

1 Śruby



2 Produkty z gniazdem sześciokątnym



3 Nakrętki, nitonakrętki & wkładki



4 Pręty gwintowane & śruby dwustronne



5 Haki & śruby oczkowe



6 Wkręty

I Index



7 Podkładki & pierścienie uszczelniające typu “O-ring”



8 Kotwy, kołki, dyble



9 Nity, kołki & wpusty



10 Elementy łączące systemowe, meblowe & zabezpieczające

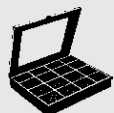

11 Zestawy

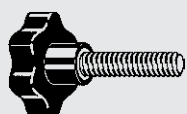























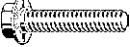

















12 Części konstrukcyjne & części maszynowe



13 Przemysł morski

T Technologia łączenia

Śruby 1

 <p>Strona 1-2 ISO 4014</p> <p>Metryczny</p>	 <p>Strona 1-18 DIN 601/555 (1987)</p> <p>Z nakrętką 6-kątną, metryczny</p>	 <p>Strona 1-19 ISO 4017</p> <p>Metryczny</p>	 <p>Strona 1-35 ISO ≈4017</p> <p>Z rowkiem, metryczny</p>	 <p>Strona 1-36 ISO 8765</p> <p>Metryczny drobny</p>
 <p>Strona 1-39 ISO 8676</p> <p>Metryczny drobny</p>	 <p>Strona 1-41 ASME ≈B18.2.1</p> <p>UNC</p>	 <p>Strona 1-52 ASME ≈B18.2.1</p> <p>UNF</p>	 <p>Strona 1-58 DIN ≈931 (1954)</p> <p>BSW</p>	 <p>Strona 1-59 BS ≈1083 (1965)</p> <p>BSF</p>
 <p>Strona 1-60 DIN ≈933 (1954)</p> <p>BSW</p>	 <p>Strona 1-61 BS ≈1083 (1965)</p> <p>BSF</p>	 <p>Strona 1-62</p> <p>RIPP samozabezpieczający, metryczny</p>	 <p>Strona 1-64</p> <p>Samozabezpieczający, metryczny</p>	 <p>Strona 1-66 DIN 6921</p> <p>Z kołnierzem, metryczny</p>
 <p>Strona 1-67 DIN ≈6921</p> <p>Z kołnierzem, metryczny, pełen gwint</p>	 <p>Strona 1-68 DIN ≈6921</p> <p>Samozabezpieczający, metryczny, pełen gwint</p>	 <p>Strona 1-70 DIN 6921</p> <p>Z kołnierzem, metryczny drobny</p>	 <p>Strona 1-71 DIN 609</p> <p>Pasowana, metryczny</p>	 <p>Strona 1-72 DIN 603</p> <p>Z podsadzeniem, metryczny</p>
 <p>Strona 1-74 DIN ≈603</p> <p>Z podsadzeniem, metryczny, pełny gwint</p>	 <p>Strona 1-75 DIN 603/555 (1987)</p> <p>Z nakrętką sześciokątną</p>	 <p>Strona 1-77 ASME B18.5.2.3M</p> <p>Z podsadzeniem UNC</p>	 <p>Strona 1-80 DIN ≈608</p> <p>Z krótkim kołnierzem, metryczna</p>	 <p>Strona 1-80 DIN - / 555 (1987)</p> <p>SEHA, metryczny</p>
 <p>Strona 1-81 DIN 604/555 (1987)</p> <p>Z nakrętką sześciokątną, metryczna</p>	 <p>Strona 1-82 DIN 605/555 (1987)</p> <p>Z kołnierzem kwadratowym i nakrętką, metryczny</p>	 <p>Strona 1-82 DIN 15237</p> <p>Talerzowa, metryczny</p>	 <p>Strona 1-83 DIN 15237</p> <p>Do osadzania śrub</p>	 <p>Strona 1-84 DIN 479</p> <p>Dociskowa (imakowa)</p>
 <p>Strona 1-85</p> <p>Z łbem kwadratowym UNC</p>	 <p>Strona 1-86 DIN 561</p> <p>Dociskowa z czopem walcowym</p>	 <p>Strona 1-87</p> <p>Śruby typ caterpillar, UNF</p>	 <p>Strona 1-89 EN 14399-4</p> <p>PEINER HV</p>	 <p>Strona 1-91 EN 14399-4</p> <p>PEINER HV</p>
 <p>Strona 1-92 EN 14399-6</p> <p>PEINER HV</p>	 <p>Strona 1-93 DIN 6917</p> <p>PEINER do dwuteowników HV</p>	 <p>Strona 1-93 DIN 6918</p> <p>PEINER do ceowników HV</p>	 <p>Strona 1-94 EN 15048</p> <p>Zestaw do połączeń konstrukcyjnych, CE</p>	 <p>Strona 1-96 EN 15048</p> <p>Zestaw do połączeń konstrukcyjnych, CE</p>
 <p>Strona 1-98</p> <p>Zaślepki ochronne sześciokątne</p>				

1 Śruby z łbem sześciokątnym

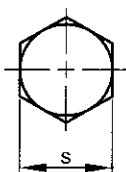
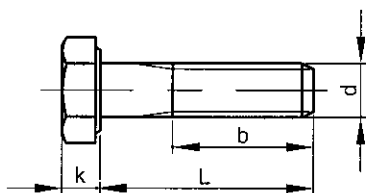

ISO 4014
 DIN 931
 NEN 1555
 ASME B18.2.3.1M
 NF E25-112

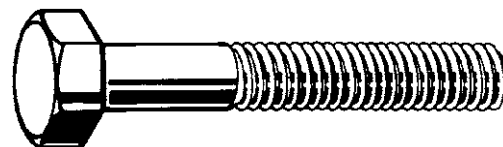

Informacje techniczne

d	b (min.): L≤125mm	b (min.): 125mm<L≤200mm	b (min.): L>200mm	k	P	s
M4	14	-	-	2.8	0.7	7
M5	16	22	-	3.5	0.8	8
M6	18	24	-	4	1	10
M7	20	26	-	4.8	1	11
M8	22	28	-	5.3	1.25	13
M10 (DIN)	26	32	45	6.4	1.5	17
M10	26	-	-	6.4	1.5	16
M12 (DIN)	30	36	49	7.5	1.75	19
M12	30	36	-	7.5	1.75	18
M14 (DIN)	34	40	53	8.8	2	22
M14	34	40	-	8.8	2	21
M16	38	44	57	10	2	24
M18	42	48	61	11.5	2.5	27
M20	46	52	65	12.5	2.5	30
M22 (DIN)	50	56	69	14	2.5	32
M22	50	56	69	14	2.5	34
M24	54	60	73	15	3	36
M27	60	66	79	17	3	41
M30	66	72	85	18.7	3.5	46
M33	72	78	91	21	3.5	50
M36	78	84	97	22.5	4	55
M39	84	90	103	25	4	60
M42	90	96	109	26	4.5	65
M45	96	102	115	28	4.5	70
M48	102	108	121	30	5	75
M52	-	116	119	33	5	80
M56	-	124	137	35	5.5	85
M60	-	132	145	38	5.5	90
M64	-	140	153	40	6	95

• Wymiar 'b' jest wartością orientacyjną, zależy od długości całkowitej

Grupy katalogowe

Gwint	Gniazdo	Materiał	Klasa	Obróbka powierzchni	Kolor	Kod	Strona
M	Sześciokąt	St	8.8			01000	1-3
M	Sześciokąt	St	8.8	Ocynk.		01200	1-5
M	Sześciokąt	St	8.8	Ocynk. żłt. pas.		01220	1-6
M	Sześciokąt	St	8.8	FLZNNC-NC6		01226	1-7
M	Sześciokąt	St	8.8	Ocynk. gor.	izometryczna	01400	1-8
M	Sześciokąt	St	8.8	Ocynk. gor.	nadwymiarowy	01420	1-9
M	Sześciokąt	St	10.9			04100	1-10
M	Sześciokąt	St	10.9	FLZNNC-NC6		04105	1-11
M	Sześciokąt	St	12.9			04108	1-11
M	Sześciokąt	St	5.6		do zbiorników ciśnieniowych	08750	1-12
M	Sześciokąt	St.St. A2	70			51000	1-12
M	Sześciokąt	St.St. A4	70			55000	1-14
M	Sześciokąt	St.St. A4	80			53510	1-16
M	Sześciokąt	St 25CrMo4+QT	KG			23010	1-17
M	Sześciokąt	Plastik PA	PA 6.6		Biały	56090	1-17

01000		Śruby z łbem sześciokątnym		A01A	
Gwint	Metryczny				
Materiał	Stal				
Klasa	8.8				

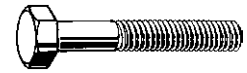

d x L	☒	Kod artykułu	d x L	☒	Kod artykułu	d x L	☒	Kod artykułu
M4X25	500	01000.040.025	M12X45/S=19	100	01000.120.045	M16X380	10	01000.160.380
M4X30	500	01000.040.030	M12X50/S=19	100	01000.120.050	M16X400	10	01000.160.400
M4X40	500	01000.040.040	M12X55/S=19	100	01000.120.055			
M5X30	200	01000.050.030	M12X60/S=19	100	01000.120.060	M18X55	25	01000.180.055
M5X35	200	01000.050.035	M12X65/S=19	50	01000.120.065	M18X60	25	01000.180.060
M5X40	200	01000.050.040	M12X70/S=19	50	01000.120.070	M18X65	25	01000.180.065
M5X45	200	01000.050.045	M12X75/S=19	50	01000.120.075	M18X70	25	01000.180.070
M5X50	200	01000.050.050	M12X80/S=19	50	01000.120.080	M18X75	25	01000.180.075
M5X55	200	01000.050.055	M12X85/S=19	50	01000.120.085	M18X80	25	01000.180.080
M5X60	200	01000.050.060	M12X90/S=19	50	01000.120.090	M18X85	25	01000.180.085
M5X70	200	01000.050.070	M12X100/S=19	50	01000.120.100	M18X90	25	01000.180.090
			M12X110/S=19	50	01000.120.110	M18X100	25	01000.180.100
			M12X120/S=19	50	01000.120.120	M18X110	25	01000.180.110
M6X30	200	01000.060.030	M12X130/S=19	50	01000.120.130	M18X120	25	01000.180.120
M6X35	200	01000.060.035	M12X140/S=19	50	01000.120.140	M18X130	25	01000.180.130
M6X40	200	01000.060.040	M12X150/S=19	50	01000.120.150	M18X140	25	01000.180.140
M6X45	200	01000.060.045	M12X160/S=19	25	01000.120.160	M18X150	25	01000.180.150
M6X50	200	01000.060.050	M12X170/S=19	25	01000.120.170	M18X160	25	01000.180.160
M6X55	200	01000.060.055	M12X180/S=19	25	01000.120.180	M18X170	25	01000.180.170
M6X60	200	01000.060.060	M12X190/S=19	25	01000.120.190	M18X180	10	01000.180.180
M6X65	200	01000.060.065	M12X200/S=19	25	01000.120.200	M18X200	10	01000.180.200
M6X70	200	01000.060.070	M12X220/S=19	25	01000.120.220	M18X220	10	01000.180.220
M6X75	200	01000.060.075	M12X240/S=19	25	01000.120.240	M18X240	10	01000.180.240
M6X80	200	01000.060.080	M12X260/S=19	25	01000.120.260	M18X260	10	01000.180.260
M6X90	200	01000.060.090	M12X280/S=19	25	01000.120.280	M18X280	10	01000.180.280
						M18X300	10	01000.180.300
M7X30	200	01000.070.030	M14X50/S=22	50	01000.140.050	M18X320	10	01000.180.320
M7X35	200	01000.070.035	M14X55/S=22	50	01000.140.055			
M7X40	200	01000.070.040	M14X60/S=22	50	01000.140.060	M20X60	50	01000.200.060
M7X50	200	01000.070.050	M14X65/S=22	50	01000.140.065	M20X65	25	01000.200.065
M7X60	200	01000.070.060	M14X70/S=22	50	01000.140.070	M20X70	25	01000.200.070
			M14X75/S=22	50	01000.140.075	M20X75	25	01000.200.075
M8X35	200	01000.080.035	M14X80/S=22	50	01000.140.080	M20X80	25	01000.200.080
M8X40	200	01000.080.040	M14X90/S=22	50	01000.140.090	M20X85	25	01000.200.085
M8X45	200	01000.080.045	M14X100/S=22	50	01000.140.100	M20X90	25	01000.200.090
M8X50	200	01000.080.050	M14X110/S=22	50	01000.140.110	M20X100	25	01000.200.100
M8X55	200	01000.080.055	M14X120/S=22	50	01000.140.120	M20X110	25	01000.200.110
M8X60	200	01000.080.060	M14X130/S=22	25	01000.140.130	M20X120	25	01000.200.120
M8X65	200	01000.080.065	M14X140/S=22	25	01000.140.140	M20X130	25	01000.200.130
M8X70	200	01000.080.070	M14X150/S=22	25	01000.140.150	M20X140	25	01000.200.140
M8X75	200	01000.080.075	M14X160/S=22	25	01000.140.160	M20X150	25	01000.200.150
M8X80	200	01000.080.080	M14X180/S=22	25	01000.140.180	M20X160	10	01000.200.160
M8X85	100	01000.080.085	M14X200/S=22	25	01000.140.200	M20X170	10	01000.200.170
M8X90	100	01000.080.090				M20X180	10	01000.200.180
M8X100	100	01000.080.100	M16X50	100	01000.160.050	M20X190	10	01000.200.190
M8X110	100	01000.080.110	M16X55	50	01000.160.055	M20X200	10	01000.200.200
M8X120	100	01000.080.120	M16X60	50	01000.160.060	M20X220	10	01000.200.220
M8X130	100	01000.080.130	M16X65	25	01000.160.065	M20X230	10	01000.200.230
M8X140	50	01000.080.140	M16X70	25	01000.160.070	M20X240	10	01000.200.240
M8X150	50	01000.080.150	M16X75	25	01000.160.075	M20X250	10	01000.200.250
			M16X80	25	01000.160.080	M20X260	10	01000.200.260
M10X35/S=17	100	01000.100.035	M16X85	25	01000.160.085	M20X280	10	01000.200.280
M10X40/S=17	100	01000.100.040	M16X90	25	01000.160.090	M20X300	10	01000.200.300
M10X45/S=17	100	01000.100.045	M16X100	25	01000.160.100	M20X320	5	01000.200.320
M10X50/S=17	100	01000.100.050	M16X110	25	01000.160.110	M20X340	5	01000.200.340
M10X55/S=17	100	01000.100.055	M16X120	25	01000.160.120	M20X360	5	01000.200.360
M10X60/S=17	100	01000.100.060	M16X130	25	01000.160.130	M20X380	5	01000.200.380
M10X65/S=17	100	01000.100.065	M16X140	25	01000.160.140	M20X400	5	01000.200.400
M10X70/S=17	100	01000.100.070	M16X150	25	01000.160.150			
M10X75/S=17	100	01000.100.075	M16X160	25	01000.160.160	M22X70/S=32	25	01000.220.070
M10X80/S=17	100	01000.100.080	M16X170	25	01000.160.170	M22X75/S=32	25	01000.220.075
M10X85/S=17	100	01000.100.085	M16X180	25	01000.160.180	M22X80/S=32	25	01000.220.080
M10X90/S=17	100	01000.100.090	M16X190	25	01000.160.190	M22X90/S=32	25	01000.220.090
M10X100/S=17	100	01000.100.100	M16X200	25	01000.160.200	M22X100/S=32	10	01000.220.100
M10X110/S=17	50	01000.100.110	M16X210	25	01000.160.210	M22X110/S=32	10	01000.220.110
M10X120/S=17	50	01000.100.120	M16X220	25	01000.160.220	M22X120/S=32	10	01000.220.120
M10X130/S=17	50	01000.100.130	M16X230	25	01000.160.230	M22X130/S=32	10	01000.220.130
M10X140/S=17	50	01000.100.140	M16X240	10	01000.160.240	M22X140/S=32	10	01000.220.140
M10X150/S=17	50	01000.100.150	M16X260	10	01000.160.260	M22X150/S=32	10	01000.220.150
M10X160/S=17	50	01000.100.160	M16X270	10	01000.160.270	M22X160/S=32	10	01000.220.160
M10X170/S=17	50	01000.100.170	M16X280	10	01000.160.280	M22X170/S=32	10	01000.220.170
M10X180/S=17	50	01000.100.180	M16X300	10	01000.160.300	M22X180/S=32	10	01000.220.180
M10X200/S=17	50	01000.100.200	M16X320	10	01000.160.320	M22X190/S=32	10	01000.220.190
			M16X340	10	01000.160.340	M22X200/S=32	5	01000.220.200
M12X40/S=19	100	01000.120.040	M16X360	10	01000.160.360	M22X220/S=32	5	01000.220.220

01000 Śruby z łbem sześciokątnym								
d x L	☒	Kod artykułu	d x L	☒	Kod artykułu	d x L	☒	Kod artykułu
M22X240/S=32	5	01000.220.240	M30X400	2	01000.300.400	M42X200	1	01000.420.200
M22X260/S=32	5	01000.220.260	M30X420	2	01000.300.420	M42X220	1	01000.420.220
M22X280/S=32	5	01000.220.280	M30X440	2	01000.300.440	M42X240	1	01000.420.240
M22X300/S=32	5	01000.220.300	M30X480	2	01000.300.480	M42X260	1	01000.420.260
						M42X280	1	01000.420.280
M24X70	25	01000.240.070	M33X100	5	01000.330.100	M42X300	1	01000.420.300
M24X75	25	01000.240.075	M33X110	5	01000.330.110	M42X320	1	01000.420.320
M24X80	25	01000.240.080	M33X120	5	01000.330.120	M42X340	1	01000.420.340
M24X85	25	01000.240.085	M33X130	5	01000.330.130	M42X360	1	01000.420.360
M24X90	10	01000.240.090	M33X140	5	01000.330.140	M42X400	1	01000.420.400
M24X100	10	01000.240.100	M33X150	5	01000.330.150	M42X420	1	01000.420.420
M24X110	10	01000.240.110	M33X160	5	01000.330.160	M42X460	1	01000.420.460
M24X120	10	01000.240.120	M33X170	2	01000.330.170	M42X480	1	01000.420.480
M24X130	10	01000.240.130	M33X180	2	01000.330.180	M42X500	1	01000.420.500
M24X140	10	01000.240.140	M33X190	2	01000.330.190			
M24X150	10	01000.240.150	M33X200	2	01000.330.200	M45X120	1	01000.450.120
M24X160	10	01000.240.160	M33X220	2	01000.330.220	M45X140	1	01000.450.140
M24X170	10	01000.240.170	M33X240	2	01000.330.240	M45X160	1	01000.450.160
M24X180	10	01000.240.180	M33X250	2	01000.330.250	M45X180	1	01000.450.180
M24X190	10	01000.240.190	M33X260	2	01000.330.260	M45X200	1	01000.450.200
M24X200	10	01000.240.200	M33X280	2	01000.330.280	M45X220	1	01000.450.220
M24X210	10	01000.240.210	M33X300	2	01000.330.300	M45X240	1	01000.450.240
M24X220	10	01000.240.220	M33X320	2	01000.330.320	M45X280	1	01000.450.280
M24X240	10	01000.240.240	M33X340	2	01000.330.340	M45X300	1	01000.450.300
M24X250	10	01000.240.250	M33X360	2	01000.330.360	M45X320	1	01000.450.320
M24X260	10	01000.240.260				M45X360	1	01000.450.360
M24X280	10	01000.240.280	M36X100	5	01000.360.100			
M24X300	10	01000.240.300	M36X110	5	01000.360.110	M48X140	1	01000.480.140
M24X320	5	01000.240.320	M36X120	5	01000.360.120	M48X150	1	01000.480.150
M24X340	5	01000.240.340	M36X130	5	01000.360.130	M48X160	1	01000.480.160
M24X360	5	01000.240.360	M36X140	5	01000.360.140	M48X170	1	01000.480.170
M24X380	5	01000.240.380	M36X150	5	01000.360.150	M48X180	1	01000.480.180
M24X400	5	01000.240.400	M36X160	5	01000.360.160	M48X200	1	01000.480.200
M24X420	5	01000.240.420	M36X170	2	01000.360.170	M48X220	1	01000.480.220
M24X440	5	01000.240.440	M36X180	2	01000.360.180	M48X240	1	01000.480.240
M24X450	5	01000.240.450	M36X190	2	01000.360.190	M48X260	1	01000.480.260
			M36X200	2	01000.360.200	M48X280	1	01000.480.280
M27X80	10	01000.270.080	M36X220	2	01000.360.220	M48X300	1	01000.480.300
M27X90	10	01000.270.090	M36X240	2	01000.360.240	M48X320	1	01000.480.320
M27X100	10	01000.270.100	M36X250	2	01000.360.250	M48X360	1	01000.480.360
M27X110	10	01000.270.110	M36X260	2	01000.360.260	M48X400	1	01000.480.400
M27X120	10	01000.270.120	M36X270	2	01000.360.270	M48X500	1	01000.480.500
M27X130	10	01000.270.130	M36X280	2	01000.360.280			
M27X140	10	01000.270.140	M36X300	2	01000.360.300	M52X160	1	01000.520.160
M27X150	10	01000.270.150	M36X320	1	01000.360.320	M52X180	1	01000.520.180
M27X160	10	01000.270.160	M36X340	1	01000.360.340	M52X200	1	01000.520.200
M27X170	5	01000.270.170	M36X360	1	01000.360.360	M52X240	1	01000.520.240
M27X180	5	01000.270.180	M36X380	1	01000.360.380	M52X280	1	01000.520.280
M27X190	5	01000.270.190	M36X400	1	01000.360.400	M52X320	1	01000.520.320
M27X200	5	01000.270.200	M36X420	1	01000.360.420	M52X360	1	01000.520.360
M27X220	5	01000.270.220	M36X440	1	01000.360.440	M52X400	1	01000.520.400
M27X240	5	01000.270.240	M36X460	1	01000.360.460	M52X500	1	01000.520.500
M27X260	5	01000.270.260	M36X480	1	01000.360.480			
M27X280	5	01000.270.280	M36X500	1	01000.360.500	M56X160	1	01000.560.160
M27X300	5	01000.270.300				M56X180	1	01000.560.180
M27X320	5	01000.270.320	M39X110	1	01000.390.110	M56X200	1	01000.560.200
M27X340	5	01000.270.340	M39X120	1	01000.390.120	M56X240	1	01000.560.240
M27X360	5	01000.270.360	M39X130	1	01000.390.130	M56X260	1	01000.560.260
M27X380	5	01000.270.380	M39X140	1	01000.390.140	M56X280	1	01000.560.280
M27X400	5	01000.270.400	M39X150	1	01000.390.150	M56X320	1	01000.560.320
			M39X160	1	01000.390.160	M56X360	1	01000.560.360
M30X90	10	01000.300.090	M39X170	1	01000.390.170	M56X400	1	01000.560.400
M30X100	10	01000.300.100	M39X180	1	01000.390.180	M56X440	1	01000.560.440
M30X110	10	01000.300.110	M39X190	1	01000.390.190			
M30X120	10	01000.300.120	M39X200	1	01000.390.200	M60X160	1	01000.600.160
M30X130	10	01000.300.130	M39X220	1	01000.390.220	M60X180	1	01000.600.180
M30X140	10	01000.300.140	M39X240	1	01000.390.240	M60X200	1	01000.600.200
M30X150	10	01000.300.150	M39X260	1	01000.390.260	M60X240	1	01000.600.240
M30X160	10	01000.300.160	M39X280	1	01000.390.280	M60X280	1	01000.600.280
M30X170	5	01000.300.170	M39X300	1	01000.390.300	M60X320	1	01000.600.320
M30X180	5	01000.300.180	M39X320	1	01000.390.320	M60X360	1	01000.600.360
M30X190	5	01000.300.190	M39X340	1	01000.390.340			
M30X200	5	01000.300.200	M39X360	1	01000.390.360	M64X180	1	01000.640.180
M30X220	5	01000.300.220	M39X400	1	01000.390.400	M64X200	1	01000.640.200
M30X240	5	01000.300.240				M64X240	1	01000.640.240
M30X260	5	01000.300.260	M42X120	1	01000.420.120	M64X280	1	01000.640.280
M30X280	5	01000.300.280	M42X130	1	01000.420.130	M64X320	1	01000.640.320
M30X300	5	01000.300.300	M42X140	1	01000.420.140	M64X360	1	01000.640.360
M30X320	2	01000.300.320	M42X150	1	01000.420.150	M64X400	1	01000.640.400
M30X340	2	01000.300.340	M42X160	1	01000.420.160			
M30X360	2	01000.300.360	M42X180	1	01000.420.180			

01200		Śruby z łbem sześciokątnym		A05A	
Gwint	Metryczny				
Materiał	Stal				
Klasa	8.8				
Obróbka powierzchni	Ocynkowane				

d x L	☒	Kod artykułu	d x L	☒	Kod artykułu	d x L	☒	Kod artykułu
M4X25	500	01200.040.025	M10X55/S=16	100	01200.100.056	M14X50/S=22	50	01200.140.050
M4X30	500	01200.040.030	M10X60/S=17	100	01200.100.060	M14X50/S=21	50	01200.140.051
M4X35	500	01200.040.035	M10X60/S=16	100	01200.100.061	M14X55/S=22	50	01200.140.055
M4X40	500	01200.040.040	M10X65/S=17	100	01200.100.065	M14X55/S=21	50	01200.140.056
M4X50	500	01200.040.050	M10X65/S=16	100	01200.100.066	M14X60/S=22	50	01200.140.060
			M10X70/S=17	100	01200.100.070	M14X60/S=21	50	01200.140.061
M5X30	200	01200.050.030	M10X70/S=16	100	01200.100.071	M14X65/S=22	50	01200.140.065
M5X35	200	01200.050.035	M10X75/S=17	100	01200.100.075	M14X70/S=22	50	01200.140.070
M5X40	200	01200.050.040	M10X75/S=16	100	01200.100.076	M14X75/S=22	50	01200.140.075
M5X45	200	01200.050.045	M10X80/S=17	100	01200.100.080	M14X80/S=22	50	01200.140.080
M5X50	200	01200.050.050	M10X80/S=16	100	01200.100.081	M14X80/S=21	50	01200.140.081
M5X55	200	01200.050.055	M10X85/S=17	100	01200.100.085	M14X85/S=22	50	01200.140.085
M5X60	200	01200.050.060	M10X85/S=16	100	01200.100.086	M14X90/S=22	50	01200.140.090
M5X65	200	01200.050.065	M10X90/S=17	100	01200.100.090	M14X100/S=22	50	01200.140.100
M5X70	200	01200.050.070	M10X90/S=16	100	01200.100.091	M14X100/S=21	50	01200.140.101
M5X80	200	01200.050.080	M10X95/S=17	100	01200.100.095	M14X110/S=22	50	01200.140.110
			M10X100/S=17	100	01200.100.100	M14X110/S=21	50	01200.140.111
M6X30	200	01200.060.030	M10X100/S=16	100	01200.100.101	M14X120/S=22	50	01200.140.120
M6X35	200	01200.060.035	M10X110/S=17	50	01200.100.110	M14X130/S=22	25	01200.140.130
M6X40	200	01200.060.040	M10X110/S=16	50	01200.100.111	M14X140/S=22	25	01200.140.140
M6X45	200	01200.060.045	M10X120/S=17	50	01200.100.120	M14X150/S=22	25	01200.140.150
M6X50	200	01200.060.050	M10X120/S=16	50	01200.100.121	M14X160/S=22	25	01200.140.160
M6X55	200	01200.060.055	M10X130/S=17	50	01200.100.130	M14X180/S=22	25	01200.140.180
M6X60	200	01200.060.060	M10X140/S=17	50	01200.100.140	M14X200/S=22	25	01200.140.200
M6X65	200	01200.060.065	M10X150/S=17	50	01200.100.150	M14X220/S=22	25	01200.140.220
M6X70	200	01200.060.070	M10X155/S=17	50	01200.100.155	M14X240/S=22	25	01200.140.240
M6X75	200	01200.060.075	M10X160/S=17	50	01200.100.160	M14X260/S=22	25	01200.140.260
M6X80	200	01200.060.080	M10X170/S=17	50	01200.100.170			
M6X90	100	01200.060.090	M10X180/S=17	50	01200.100.180	M16X50	50	01200.160.050
M6X100	100	01200.060.100	M10X190/S=17	50	01200.100.190	M16X55	50	01200.160.055
M6X110	100	01200.060.110	M10X200/S=17	50	01200.100.200	M16X60	50	01200.160.060
M6X120	100	01200.060.120	M10X210/S=17	25	01200.100.210	M16X65	25	01200.160.065
M6X130	100	01200.060.130	M10X220/S=17	25	01200.100.220	M16X70	25	01200.160.070
M6X140	100	01200.060.140	M10X240/S=17	25	01200.100.240	M16X75	25	01200.160.075
						M16X80	25	01200.160.080
M7X30	200	01200.070.030	M12X40/S=19	100	01200.120.040	M16X85	25	01200.160.085
M7X35	200	01200.070.035	M12X45/S=19	100	01200.120.045	M16X90	25	01200.160.090
M7X40	200	01200.070.040	M12X45/S=18	100	01200.120.046	M16X95	50	01200.160.095
M7X45	200	01200.070.045	M12X50/S=19	100	01200.120.050	M16X100	25	01200.160.100
M7X50	200	01200.070.050	M12X50/S=18	100	01200.120.051	M16X110	25	01200.160.110
M7X60	200	01200.070.060	M12X55/S=19	100	01200.120.055	M16X120	25	01200.160.120
M7X70	200	01200.070.070	M12X55/S=18	100	01200.120.056	M16X130	25	01200.160.130
M7X80	200	01200.070.080	M12X60/S=19	100	01200.120.060	M16X140	25	01200.160.140
			M12X60/S=18	100	01200.120.061	M16X150	25	01200.160.150
M8X35	200	01200.080.035	M12X65/S=19	50	01200.120.065	M16X160	25	01200.160.160
M8X40	200	01200.080.040	M12X65/S=18	50	01200.120.066	M16X170	25	01200.160.170
M8X45	200	01200.080.045	M12X70/S=19	50	01200.120.070	M16X180	25	01200.160.180
M8X50	200	01200.080.050	M12X70/S=18	50	01200.120.071	M16X190	25	01200.160.190
M8X55	200	01200.080.055	M12X75/S=19	50	01200.120.075	M16X200	25	01200.160.200
M8X60	200	01200.080.060	M12X75/S=18	50	01200.120.076	M16X210	25	01200.160.210
M8X65	200	01200.080.065	M12X80/S=19	50	01200.120.080	M16X220	25	01200.160.220
M8X70	200	01200.080.070	M12X80/S=18	50	01200.120.081	M16X230	25	01200.160.230
M8X75	200	01200.080.075	M12X85/S=19	50	01200.120.085	M16X240	10	01200.160.240
M8X80	200	01200.080.080	M12X90/S=19	50	01200.120.090	M16X250	10	01200.160.250
M8X85	200	01200.080.085	M12X90/S=18	50	01200.120.091	M16X260	10	01200.160.260
M8X90	100	01200.080.090	M12X100/S=19	50	01200.120.100	M16X280	10	01200.160.280
M8X95	100	01200.080.095	M12X100/S=18	50	01200.120.101	M16X300	10	01200.160.300
M8X100	100	01200.080.100	M12X110/S=19	50	01200.120.110	M16X320	10	01200.160.320
M8X105	100	01200.080.105	M12X110/S=18	50	01200.120.111	M16X340	10	01200.160.340
M8X110	100	01200.080.110	M12X120/S=19	50	01200.120.120	M16X360	10	01200.160.360
M8X120	100	01200.080.120	M12X120/S=18	50	01200.120.121	M16X380	10	01200.160.380
M8X130	100	01200.080.130	M12X130/S=19	50	01200.120.130	M16X400	10	01200.160.400
M8X140	50	01200.080.140	M12X140/S=19	50	01200.120.140			
M8X150	50	01200.080.150	M12X150/S=19	50	01200.120.150	M18X60	25	01200.180.060
M8X160	50	01200.080.160	M12X160/S=19	25	01200.120.160	M18X65	25	01200.180.065
M8X180	50	01200.080.180	M12X170/S=19	25	01200.120.170	M18X70	25	01200.180.070
M8X200	50	01200.080.200	M12X180/S=19	25	01200.120.180	M18X75	25	01200.180.075
			M12X190/S=19	25	01200.120.190	M18X80	25	01200.180.080
M10X40/S=17	100	01200.100.040	M12X200/S=19	25	01200.120.200	M18X90	25	01200.180.090
M10X40/S=16	100	01200.100.041	M12X220/S=19	25	01200.120.220	M18X100	25	01200.180.100
M10X45/S=17	100	01200.100.045	M12X240/S=19	25	01200.120.240	M18X110	25	01200.180.110
M10X45/S=16	100	01200.100.046	M12X260/S=19	25	01200.120.260	M18X120	25	01200.180.120
M10X50/S=17	100	01200.100.050	M12X280/S=19	25	01200.120.280	M18X130	25	01200.180.130
M10X50/S=16	100	01200.100.051	M12X300/S=19	25	01200.120.300	M18X140	25	01200.180.140
M10X55/S=17	100	01200.100.055				M18X150	25	01200.180.150

01200 Śruby z łbem sześciokątnym								
d x L	☒	Kod artykułu	d x L	☒	Kod artykułu	d x L	☒	Kod artykułu
M18X160	25	01200.180.160	M24X90	10	01200.240.090	M30X130	10	01200.300.130
M18X180	10	01200.180.180	M24X100	10	01200.240.100	M30X140	10	01200.300.140
M18X200	10	01200.180.200	M24X110	10	01200.240.110	M30X150	10	01200.300.150
			M24X120	10	01200.240.120	M30X160	10	01200.300.160
M20X60	25	01200.200.060	M24X130	10	01200.240.130	M30X170	5	01200.300.170
M20X65	25	01200.200.065	M24X140	10	01200.240.140	M30X180	5	01200.300.180
M20X70	25	01200.200.070	M24X150	10	01200.240.150	M30X200	5	01200.300.200
M20X75	25	01200.200.075	M24X160	10	01200.240.160	M30X220	5	01200.300.220
M20X80	25	01200.200.080	M24X170	10	01200.240.170	M30X240	5	01200.300.240
M20X85	25	01200.200.085	M24X180	10	01200.240.180	M30X260	5	01200.300.260
M20X90	25	01200.200.090	M24X190	10	01200.240.190	M30X280	5	01200.300.280
M20X100	25	01200.200.100	M24X200	10	01200.240.200	M30X300	5	01200.300.300
M20X110	25	01200.200.110	M24X210	10	01200.240.210	M30X320	2	01200.300.320
M20X120	25	01200.200.120	M24X220	10	01200.240.220	M30X340	2	01200.300.340
M20X130	25	01200.200.130	M24X230	10	01200.240.230	M30X360	2	01200.300.360
M20X140	25	01200.200.140	M24X240	10	01200.240.240	M30X400	2	01200.300.400
M20X150	25	01200.200.150	M24X260	10	01200.240.260			
M20X160	10	01200.200.160	M24X280	10	01200.240.280	M33X100	5	01200.330.100
M20X170	10	01200.200.170	M24X300	10	01200.240.300	M33X110	5	01200.330.110
M20X180	10	01200.200.180	M24X320	5	01200.240.320	M33X120	5	01200.330.120
M20X190	10	01200.200.190	M24X340	5	01200.240.340	M33X130	5	01200.330.130
M20X200	10	01200.200.200	M24X360	5	01200.240.360	M33X140	5	01200.330.140
M20X220	10	01200.200.220	M24X380	5	01200.240.380	M33X150	5	01200.330.150
M20X240	10	01200.200.240	M24X400	5	01200.240.400	M33X160	5	01200.330.160
M20X260	10	01200.200.260				M33X180	2	01200.330.180
M20X280	10	01200.200.280	M27X80	10	01200.270.080	M33X200	2	01200.330.200
M20X300	10	01200.200.300	M27X90	10	01200.270.090	M33X280	1	01200.330.280
M20X320	5	01200.200.320	M27X100	10	01200.270.100			
			M27X110	10	01200.270.110	M36X100	5	01200.360.100
M22X70/S=32	25	01200.220.070	M27X120	10	01200.270.120	M36X110	5	01200.360.110
M22X75/S=32	25	01200.220.075	M27X130	10	01200.270.130	M36X120	5	01200.360.120
M22X80/S=32	25	01200.220.080	M27X140	10	01200.270.140	M36X130	5	01200.360.130
M22X90/S=32	25	01200.220.090	M27X150	10	01200.270.150	M36X140	5	01200.360.140
M22X100/S=32	10	01200.220.100	M27X160	10	01200.270.160	M36X150	5	01200.360.150
M22X110/S=32	10	01200.220.110	M27X180	5	01200.270.180	M36X160	5	01200.360.160
M22X120/S=32	10	01200.220.120	M27X190	5	01200.270.190	M36X170	5	01200.360.170
M22X130/S=32	10	01200.220.130	M27X200	5	01200.270.200	M36X180	2	01200.360.180
M22X140/S=32	10	01200.220.140	M27X220	5	01200.270.220	M36X200	2	01200.360.200
M22X150/S=32	10	01200.220.150	M27X240	5	01200.270.240	M36X220	2	01200.360.220
M22X160/S=32	10	01200.220.160	M27X260	5	01200.270.260	M36X240	2	01200.360.240
M22X180/S=32	10	01200.220.180	M27X280	5	01200.270.280	M36X260	2	01200.360.260
M22X200/S=32	5	01200.220.200	M27X300	5	01200.270.300	M36X280	2	01200.360.280
						M36X300	2	01200.360.300
M24X70	25	01200.240.070	M30X90	10	01200.300.090			
M24X75	25	01200.240.075	M30X100	10	01200.300.100	M39X160	1	01200.390.160
M24X80	25	01200.240.080	M30X110	10	01200.300.110			
M24X85	10	01200.240.085	M30X120	10	01200.300.120			

01220 Śruby z łbem sześciokątnym				A06A
Gwint	Metryczny			
Materiał	Stal			
Klasa	8.8			
Obróbka powierzchni	Ocynkowane, po żółtej pasywacji			

d x L	☒	Kod artykułu	d x L	☒	Kod artykułu	d x L	☒	Kod artykułu
M4X25	500	01220.040.025	M6X80	200	01220.060.080	M8X150	100	01220.080.150
M4X30	500	01220.040.030	M6X90	100	01220.060.090	M8X160	50	01220.080.160
M4X40	500	01220.040.040	M6X100	100	01220.060.100	M8X180	50	01220.080.180
M4X50	500	01220.040.050	M6X110	100	01220.060.110			
			M6X120	100	01220.060.120	M10X40/S=17	100	01220.100.040
M5X30	200	01220.050.030	M6X130	100	01220.060.130	M10X45/S=17	100	01220.100.045
M5X35	200	01220.050.035				M10X50/S=17	100	01220.100.050
M5X40	200	01220.050.040	M8X35	200	01220.080.035	M10X55/S=17	100	01220.100.055
M5X45	200	01220.050.045	M8X40	200	01220.080.040	M10X60/S=17	100	01220.100.060
M5X50	200	01220.050.050	M8X45	200	01220.080.045	M10X65/S=17	100	01220.100.065
M5X55	200	01220.050.055	M8X50	200	01220.080.050	M10X70/S=17	100	01220.100.070
M5X60	200	01220.050.060	M8X55	200	01220.080.055	M10X75/S=17	100	01220.100.075
M5X70	200	01220.050.070	M8X60	200	01220.080.060	M10X80/S=17	100	01220.100.080
M5X80	200	01220.050.080	M8X65	200	01220.080.065	M10X85/S=17	100	01220.100.085
			M8X70	200	01220.080.070	M10X90/S=17	100	01220.100.090
M6X30	200	01220.060.030	M8X75	200	01220.080.075	M10X100/S=17	100	01220.100.100
M6X35	200	01220.060.035	M8X80	200	01220.080.080	M10X110/S=17	50	01220.100.110
M6X40	200	01220.060.040	M8X90	100	01220.080.090	M10X120/S=17	50	01220.100.120
M6X45	200	01220.060.045	M8X100	100	01220.080.100	M10X130/S=17	50	01220.100.130
M6X50	200	01220.060.050	M8X110	100	01220.080.110	M10X140/S=17	50	01220.100.140
M6X55	200	01220.060.055	M8X120	100	01220.080.120	M10X150/S=17	50	01220.100.150
M6X60	200	01220.060.060	M8X130	100	01220.080.130	M10X160/S=17	50	01220.100.160
M6X70	200	01220.060.070	M8X140	100	01220.080.140	M10X170/S=17	50	01220.100.170

01220 Śruby z łbem sześciokątnym								
d x L	☒	Kod artykułu	d x L	☒	Kod artykułu	d x L	☒	Kod artykułu
M10X180/S=17	50	01220.100.180	M16X60	50	01220.160.060	M24X80	25	01220.240.080
M10X200/S=17	50	01220.100.200	M16X65	25	01220.160.065	M24X90	10	01220.240.090
M10X220/S=17	50	01220.100.220	M16X70	25	01220.160.070	M24X100	10	01220.240.100
M12X45/S=19	100	01220.120.045	M16X75	25	01220.160.075	M24X110	10	01220.240.110
M12X50/S=19	100	01220.120.050	M16X80	25	01220.160.080	M24X120	10	01220.240.120
M12X55/S=19	100	01220.120.055	M16X90	25	01220.160.090	M24X130	10	01220.240.130
M12X60/S=19	100	01220.120.060	M16X100	25	01220.160.100	M24X140	10	01220.240.140
M12X65/S=19	50	01220.120.065	M16X110	25	01220.160.110	M24X150	10	01220.240.150
M12X70/S=19	50	01220.120.070	M16X120	25	01220.160.120	M24X160	10	01220.240.160
M12X75/S=19	50	01220.120.075	M16X130	25	01220.160.130	M24X180	10	01220.240.180
M12X80/S=19	50	01220.120.080	M16X140	25	01220.160.140	M24X200	10	01220.240.200
M12X90/S=19	50	01220.120.090	M16X150	25	01220.160.150	M24X220	10	01220.240.220
M12X100/S=19	50	01220.120.100	M16X160	25	01220.160.160	M24X240	10	01220.240.240
M12X110/S=19	50	01220.120.110	M16X180	25	01220.160.180	M24X260	10	01220.240.260
M12X120/S=19	50	01220.120.120	M16X200	25	01220.160.200	M24X280	10	01220.240.280
M12X120/S=19	50	01220.120.120	M16X220	25	01220.160.220	M24X300	10	01220.240.300
M12X130/S=19	50	01220.120.130	M16X240	25	01220.160.240	M27X100	10	01220.270.100
M12X140/S=19	50	01220.120.140	M20X65	25	01220.200.065	M27X110	10	01220.270.110
M12X150/S=19	50	01220.120.150	M20X70	25	01220.200.070	M27X120	10	01220.270.120
M12X160/S=19	50	01220.120.160	M20X75	25	01220.200.075	M27X140	10	01220.270.140
M12X180/S=19	50	01220.120.180	M20X80	25	01220.200.080	M27X160	10	01220.270.160
M12X200/S=19	50	01220.120.200	M20X90	25	01220.200.090	M27X180	5	01220.270.180
M12X220/S=19	50	01220.120.220	M20X100	25	01220.200.100	M27X200	5	01220.270.200
M12X240/S=19	50	01220.120.240	M20X110	25	01220.200.110	M30X100	10	01220.300.100
M14X50/S=22	50	01220.140.050	M20X120	25	01220.200.120	M30X120	10	01220.300.120
M14X55/S=22	50	01220.140.055	M20X130	25	01220.200.130	M30X130	10	01220.300.130
M14X60/S=22	50	01220.140.060	M20X140	25	01220.200.140	M30X140	10	01220.300.140
M14X70/S=22	50	01220.140.070	M20X150	25	01220.200.150	M30X160	10	01220.300.160
M14X80/S=22	50	01220.140.080	M20X160	10	01220.200.160	M30X180	5	01220.300.180
M14X90/S=22	50	01220.140.090	M20X180	10	01220.200.180	M30X200	5	01220.300.200
M14X100/S=22	50	01220.140.100	M20X190	10	01220.200.190	M33X100	10	01220.330.100
M14X110/S=22	50	01220.140.110	M20X200	10	01220.200.200	M33X120	5	01220.330.120
M14X120/S=22	50	01220.140.120	M20X220	10	01220.200.220	M33X140	5	01220.330.140
M14X130/S=22	25	01220.140.130	M20X240	10	01220.200.240	M33X160	5	01220.330.160
M14X140/S=22	25	01220.140.140	M20X260	10	01220.200.260	M33X180	5	01220.330.180
M14X150/S=22	25	01220.140.150	M20X280	10	01220.200.280	M33X200	5	01220.330.200
M14X160/S=22	25	01220.140.160	M20X300	10	01220.200.300	M36X120	5	01220.360.120
M14X180/S=22	25	01220.140.180	M22X120/S=32	25	01220.220.120	M36X180	5	01220.360.180
M14X200/S=22	25	01220.140.200	M22X130/S=32	25	01220.220.130			
M16X55	50	01220.160.055						

01226 Śruby z łbem sześciokątnym				A96A
Gwint	Metryczny			
Materiał	Stal			
Klasa	8.8			
Obróbka powierzchni	Ocynk płatkowy bez Cr6+ wg ISO 10683 (flZnnc)			

d x L	☒	Kod artykułu	d x L	☒	Kod artykułu	d x L	☒	Kod artykułu
M6X30	200	01226.060.030	M12X45/S=19	100	01226.120.045	M16X160	25	01226.160.160
M6X35	200	01226.060.035	M12X50/S=19	100	01226.120.050	M16X180	25	01226.160.180
M6X40	200	01226.060.040	M12X55/S=19	100	01226.120.055	M18X60	25	01226.180.060
M6X45	200	01226.060.045	M12X60/S=19	100	01226.120.060	M18X80	25	01226.180.080
M6X50	200	01226.060.050	M12X65/S=19	50	01226.120.065	M18X90	25	01226.180.090
M6X60	200	01226.060.060	M12X70/S=19	50	01226.120.070	M20X65	25	01226.200.065
M8X35	200	01226.080.035	M12X80/S=19	50	01226.120.080	M20X70	25	01226.200.070
M8X40	200	01226.080.040	M12X90/S=19	50	01226.120.090	M20X75	25	01226.200.075
M8X45	200	01226.080.045	M12X100/S=19	50	01226.120.100	M20X80	25	01226.200.080
M8X50	200	01226.080.050	M12X110/S=19	50	01226.120.110	M20X85	25	01226.200.085
M8X55	200	01226.080.055	M12X120/S=19	50	01226.120.120	M20X90	25	01226.200.090
M8X60	200	01226.080.060	M12X140/S=19	50	01226.120.140	M20X100	25	01226.200.100
M8X70	200	01226.080.070	M12X150/S=19	50	01226.120.150	M20X110	25	01226.200.110
M8X80	200	01226.080.080	M12X170/S=19	25	01226.120.170	M20X120	25	01226.200.120
M8X90	100	01226.080.090	M16X55	50	01226.160.055	M20X130	25	01226.200.130
M8X110	100	01226.080.110	M16X60	50	01226.160.060	M20X140	25	01226.200.140
M10X40/S=17	100	01226.100.040	M16X65	25	01226.160.065	M20X150	25	01226.200.150
M10X45/S=17	100	01226.100.045	M16X70	25	01226.160.070	M20X160	10	01226.200.160
M10X50/S=17	100	01226.100.050	M16X75	25	01226.160.075	M20X180	10	01226.200.180
M10X60/S=17	100	01226.100.060	M16X80	25	01226.160.080	M20X200	10	01226.200.200
M10X70/S=17	100	01226.100.070	M16X90	25	01226.160.090	M24X70	25	01226.240.070
M10X80/S=17	100	01226.100.080	M16X100	25	01226.160.100	M24X80	25	01226.240.080
M10X90/S=17	100	01226.100.090	M16X110	25	01226.160.110	M24X90	10	01226.240.090
M10X100/S=17	100	01226.100.100	M16X120	25	01226.160.120	M24X100	10	01226.240.100
M10X120/S=17	50	01226.100.120	M16X130	25	01226.160.130	M24X110	10	01226.240.110
			M16X140	25	01226.160.140			
			M16X150	25	01226.160.150			

01226 Śruby z łbem sześciokątnym								
d x L	☒	Kod artykułu	d x L	☒	Kod artykułu	d x L	☒	Kod artykułu
M24X130	10	01226.240.130	M24X160	10	01226.240.160	M24X200	10	01226.240.200
M24X140	10	01226.240.140	M24X180	10	01226.240.180			

- Powlekanie powierzchniowe ISO 10683 cynkowanie patkowie eliminuje możliwości uszkodzenia, jakie może wywołać kruchość wodorowa.

01400 Śruby z łbem sześciokątnym, gwint montażowy, izometryczny								A08A
Gwint	Metryczny							
Materiał	Stal							
Klasa	8.8							
Obróbka powierzchni	Ocynkowane na gorąco							
								

d x L	☒	Kod artykułu	d x L	☒	Kod artykułu	d x L	☒	Kod artykułu
M8X35	100	01400.080.035	M16X75	25	01400.160.075	M24X80	25	01400.240.080
M8X40	100	01400.080.040	M16X80	25	01400.160.080	M24X90	10	01400.240.090
M8X45	100	01400.080.045	M16X90	25	01400.160.090	M24X100	10	01400.240.100
M8X50	100	01400.080.050	M16X100	25	01400.160.100	M24X110	10	01400.240.110
M8X55	100	01400.080.055	M16X110	25	01400.160.110	M24X120	10	01400.240.120
M8X60	100	01400.080.060	M16X120	25	01400.160.120	M24X130	10	01400.240.130
M8X65	100	01400.080.065	M16X130	25	01400.160.130	M24X140	10	01400.240.140
M8X70	100	01400.080.070	M16X140	25	01400.160.140	M24X150	10	01400.240.150
M8X75	100	01400.080.075	M16X150	25	01400.160.150	M24X160	10	01400.240.160
M8X80	100	01400.080.080	M16X160	25	01400.160.160	M24X180	10	01400.240.180
M8X90	100	01400.080.090	M16X180	25	01400.160.180	M24X200	10	01400.240.200
M8X100	50	01400.080.100	M16X200	25	01400.160.200	M24X220	10	01400.240.220
			M16X220	25	01400.160.220	M24X240	10	01400.240.240
M10X40/S=17	100	01400.100.040	M16X240	25	01400.160.240	M24X260	10	01400.240.260
M10X45/S=17	100	01400.100.045	M16X260	25	01400.160.260	M24X280	10	01400.240.280
M10X50/S=17	50	01400.100.050				M24X300	10	01400.240.300
M10X55/S=17	50	01400.100.055	M18X60	25	01400.180.060	M24X320	5	01400.240.320
M10X60/S=17	50	01400.100.060	M18X70	25	01400.180.070	M24X340	5	01400.240.340
M10X65/S=17	50	01400.100.065	M18X80	25	01400.180.080	M24X360	5	01400.240.360
M10X70/S=17	50	01400.100.070	M18X90	25	01400.180.090			
M10X75/S=17	50	01400.100.075	M18X100	25	01400.180.100	M27X80	10	01400.270.080
M10X80/S=17	50	01400.100.080	M18X110	25	01400.180.110	M27X90	10	01400.270.090
M10X90/S=17	50	01400.100.090	M18X120	25	01400.180.120	M27X100	10	01400.270.100
M10X100/S=17	50	01400.100.100	M18X130	25	01400.180.130	M27X110	10	01400.270.110
M10X110/S=17	50	01400.100.110	M18X140	25	01400.180.140	M27X120	10	01400.270.120
M10X110/S=16	50	01400.100.111	M18X150	25	01400.180.150	M27X130	10	01400.270.130
M10X120/S=17	50	01400.100.120				M27X140	10	01400.270.140
M10X120/S=16	50	01400.100.121	M20X65	25	01400.200.065	M27X150	10	01400.270.150
M10X130/S=16	50	01400.100.131	M20X70	25	01400.200.070	M27X160	10	01400.270.160
M10X140/S=16	50	01400.100.141	M20X75	25	01400.200.075			
M10X150/S=16	50	01400.100.151	M20X80	25	01400.200.080	M30X90	10	01400.300.090
M10X160/S=16	50	01400.100.161	M20X90	25	01400.200.090	M30X100	10	01400.300.100
M10X180/S=16	50	01400.100.181	M20X100	25	01400.200.100	M30X110	10	01400.300.110
M10X200/S=16	50	01400.100.201	M20X110	25	01400.200.110	M30X120	10	01400.300.120
			M20X120	25	01400.200.120	M30X130	10	01400.300.130
M12X45/S=19	50	01400.120.045	M20X130	25	01400.200.130	M30X140	10	01400.300.140
M12X50/S=19	50	01400.120.050	M20X140	25	01400.200.140	M30X150	10	01400.300.150
M12X55/S=19	25	01400.120.055	M20X150	25	01400.200.150	M30X160	10	01400.300.160
M12X60/S=19	25	01400.120.060	M20X160	10	01400.200.160	M30X180	10	01400.300.180
M12X65/S=19	25	01400.120.065	M20X180	10	01400.200.180	M30X200	10	01400.300.200
M12X70/S=19	25	01400.120.070	M20X200	10	01400.200.200	M30X220	5	01400.300.220
M12X75/S=19	25	01400.120.075	M20X220	10	01400.200.220	M30X240	5	01400.300.240
M12X80/S=19	25	01400.120.080	M20X240	10	01400.200.240	M30X260	5	01400.300.260
M12X90/S=19	25	01400.120.090	M20X260	10	01400.200.260			
M12X100/S=19	25	01400.120.100	M20X280	10	01400.200.280	M33X100	5	01400.330.100
M12X110/S=19	25	01400.120.110	M20X300	10	01400.200.300	M33X120	5	01400.330.120
M12X120/S=19	25	01400.120.120				M33X140	5	01400.330.140
M12X130/S=19	25	01400.120.130	M22X70/S=34	25	01400.220.071	M33X160	5	01400.330.160
M12X140/S=19	25	01400.120.140	M22X75/S=34	25	01400.220.076			
M12X150/S=19	25	01400.120.150	M22X80/S=34	25	01400.220.081	M36X110	5	01400.360.110
M12X160/S=19	25	01400.120.160	M22X90/S=34	25	01400.220.091	M36X120	5	01400.360.120
M12X180/S=19	25	01400.120.180	M22X100/S=34	10	01400.220.101	M36X140	5	01400.360.140
M12X200/S=19	25	01400.120.200	M22X110/S=34	10	01400.220.111	M36X160	2	01400.360.160
			M22X120/S=34	10	01400.220.121	M36X180	2	01400.360.180
M16X55	25	01400.160.055	M22X140/S=34	10	01400.220.141	M36X200	2	01400.360.200
M16X60	25	01400.160.060	M22X150/S=34	10	01400.220.151	M36X220	2	01400.360.220
M16X65	25	01400.160.065				M36X240	2	01400.360.240
M16X70	25	01400.160.070	M24X75	25	01400.240.075			

- Dla śrub cynkowanych na gorąco z gwintem IZOMETRYCZNYM MONTAŻOWYM, gwint walcowany jest poniżej rozmiaru, tak aby odpowiadał sprawdzianowi przechodniemu o klasie tolerancji h po cynkowaniu.
- Zależą tej metody produkcji jest to, że śruby mogą być bez przeszkód stosowane w każdym nagwintowanym otworze.
- Odpowiadające im nakrętki IZOMETRYCZNE MONTAŻOWE, zostały nagwintowane zgodnie z klasą tolerancji 6H po cynkowaniu, tak aby doskonale pasowały do śrub.

01420 Śruby z łbem sześciokątnym z nadwymiarowym gwintem		A08A
Gwint	Metryczny	
Materiał	Stal	
Klasa	8.8	
Obróbka powierzchni	Ocynkowane na gorąco	



d x L	☒	Kod artykułu	d x L	☒	Kod artykułu	d x L	☒	Kod artykułu
M10X40/S=17	100	01420.100.040	M18X70	50	01420.180.070	M24X260	5	01420.240.260
M10X50/S=17	50	01420.100.050	M18X80	25	01420.180.080	M24X280	5	01420.240.280
M10X55/S=17	50	01420.100.055	M18X90	25	01420.180.090	M24X300	5	01420.240.300
M10X60/S=17	50	01420.100.060	M18X100	25	01420.180.100			
M10X80/S=17	50	01420.100.080	M18X120	25	01420.180.120	M27X80	10	01420.270.080
M10X100/S=17	50	01420.100.100	M18X140	25	01420.180.140	M27X85	10	01420.270.085
M10X130/S=17	50	01420.100.130				M27X90	10	01420.270.090
			M20X65	25	01420.200.065	M27X100	10	01420.270.100
M12X45/S=19	100	01420.120.045	M20X70	25	01420.200.070	M27X110	10	01420.270.110
M12X50/S=19	100	01420.120.050	M20X75	25	01420.200.075	M27X120	10	01420.270.120
M12X55/S=19	100	01420.120.055	M20X80	25	01420.200.080	M27X130	10	01420.270.130
M12X60/S=19	100	01420.120.060	M20X85	25	01420.200.085	M27X140	10	01420.270.140
M12X65/S=19	100	01420.120.065	M20X90	25	01420.200.090	M27X150	10	01420.270.150
M12X70/S=19	100	01420.120.070	M20X95	25	01420.200.095	M27X160	10	01420.270.160
M12X75/S=19	50	01420.120.075	M20X100	25	01420.200.100	M27X180	10	01420.270.180
M12X80/S=19	50	01420.120.080	M20X110	25	01420.200.110	M27X200	10	01420.270.200
M12X90/S=19	50	01420.120.090	M20X120	25	01420.200.120			
M12X100/S=19	50	01420.120.100	M20X130	25	01420.200.130	M30X90	10	01420.300.090
M12X110/S=19	50	01420.120.110	M20X140	25	01420.200.140	M30X100	10	01420.300.100
M12X120/S=19	50	01420.120.120	M20X150	25	01420.200.150	M30X110	10	01420.300.110
M12X130/S=19	50	01420.120.130	M20X160	10	01420.200.160	M30X120	10	01420.300.120
M12X140/S=19	50	01420.120.140	M20X180	10	01420.200.180	M30X130	10	01420.300.130
M12X150/S=19	50	01420.120.150	M20X200	10	01420.200.200	M30X140	10	01420.300.140
M12X160/S=19	25	01420.120.160	M20X220	10	01420.200.220	M30X150	5	01420.300.150
M12X180/S=19	25	01420.120.180	M20X240	10	01420.200.240	M30X160	10	01420.300.160
M12X200/S=19	25	01420.120.200	M20X260	10	01420.200.260	M30X180	5	01420.300.180
M12X240/S=19	25	01420.120.240	M20X280	10	01420.200.280	M30X200	5	01420.300.200
M12X260/S=19	25	01420.120.260	M20X300	10	01420.200.300	M30X220	5	01420.300.220
			M20X320	5	01420.200.320			
M14X50/S=22	50	01420.140.050	M20X360	5	01420.200.360	M33X110	5	01420.330.110
M14X60/S=22	50	01420.140.060				M33X120	5	01420.330.120
M14X70/S=22	50	01420.140.070	M22X70/S=32	25	01420.220.070	M33X140	5	01420.330.140
M14X80/S=22	25	01420.140.080	M22X75/S=32	25	01420.220.075			
M14X90/S=22	25	01420.140.090	M22X80/S=32	25	01420.220.080	M36X100	5	01420.360.100
M14X100/S=22	25	01420.140.100	M22X90/S=32	10	01420.220.090	M36X110	5	01420.360.110
M14X120/S=22	25	01420.140.120	M22X100/S=32	10	01420.220.100	M36X120	5	01420.360.120
M14X140/S=22	25	01420.140.140	M22X120/S=32	10	01420.220.120	M36X130	5	01420.360.130
			M22X140/S=32	10	01420.220.140	M36X140	5	01420.360.140
M16X55	50	01420.160.055	M22X160/S=32	10	01420.220.160	M36X150	5	01420.360.150
M16X60	50	01420.160.060	M22X180/S=32	10	01420.220.180	M36X160	5	01420.360.160
M16X65	50	01420.160.065	M22X190/S=32	10	01420.220.190	M36X180	5	01420.360.180
M16X70	50	01420.160.070	M22X200/S=32	10	01420.220.200	M36X200	5	01420.360.200
M16X75	25	01420.160.075				M36X220	1	01420.360.220
M16X80	25	01420.160.080	M24X70	25	01420.240.070	M36X320	1	01420.360.320
M16X90	25	01420.160.090	M24X75	25	01420.240.075			
M16X100	25	01420.160.100	M24X80	25	01420.240.080	M39X180	1	01420.390.180
M16X110	25	01420.160.110	M24X85	10	01420.240.085	M39X200	1	01420.390.200
M16X120	25	01420.160.120	M24X90	10	01420.240.090			
M16X130	25	01420.160.130	M24X95	10	01420.240.095	M42X140	1	01420.420.140
M16X140	25	01420.160.140	M24X100	10	01420.240.100	M42X150	1	01420.420.150
M16X150	25	01420.160.150	M24X110	10	01420.240.110	M42X160	1	01420.420.160
M16X160	25	01420.160.160	M24X120	10	01420.240.120			
M16X180	25	01420.160.180	M24X130	10	01420.240.130	M45X200	1	01420.450.200
M16X200	25	01420.160.200	M24X140	10	01420.240.140			
M16X220	25	01420.160.220	M24X150	10	01420.240.150	M48X120	1	01420.480.120
M16X240	25	01420.160.240	M24X160	10	01420.240.160			
M16X260	10	01420.160.260	M24X180	10	01420.240.180	M52X200	1	01420.520.200
M16X300	10	01420.160.300	M24X200	10	01420.240.200			
			M24X220	10	01420.240.220	M64X280	1	01420.640.280
M18X60	50	01420.180.060	M24X240	10	01420.240.240			

- Dla śrub cynkowanych na gorąco z gwintem NADWYMIAROWYM, warstwa cynku nałożona jest na normalny gwint tak, że po cynkowaniu śruby te nie są już izometryczne i pasujące, ale grubsze: tak zwane NADWYMIAROWE.
- Nie pasują do normalnych gwintów i nie mogą być zastosowane w np. normalnie nagwintowanych otworach.
- Odpowiadające im nakrętki NADWYMIAROWE zostały nagwintowane o około 0,3 mm więcej, tak aby idealnie pasowały do śrub po cynkowaniu.

04100		Śruby z łbem sześciokątnym				C01A	
Gwint		Metryczny					
Materiał		Stal					
Klasa		10.9					

d x L	☒	Kod artykułu	d x L	☒	Kod artykułu	d x L	☒	Kod artykułu
M6X30	200	04100.060.030	M14X130/S=22	50	04100.140.130	M24X110	10	04100.240.110
M6X35	200	04100.060.035	M14X140/S=22	50	04100.140.140	M24X120	10	04100.240.120
M6X40	200	04100.060.040	M14X150/S=22	25	04100.140.150	M24X130	10	04100.240.130
M6X45	200	04100.060.045	M14X160/S=22	25	04100.140.160	M24X140	10	04100.240.140
M6X50	200	04100.060.050				M24X150	10	04100.240.150
M6X55	200	04100.060.055	M16X50	50	04100.160.050	M24X160	10	04100.240.160
M6X60	200	04100.060.060	M16X55	50	04100.160.055	M24X170	10	04100.240.170
M6X70	200	04100.060.070	M16X60	50	04100.160.060	M24X180	10	04100.240.180
M6X80	200	04100.060.080	M16X65	25	04100.160.065	M24X200	10	04100.240.200
			M16X70	25	04100.160.070	M24X220	10	04100.240.220
M8X30	200	04100.080.030	M16X75	25	04100.160.075	M24X240	10	04100.240.240
M8X35	200	04100.080.035	M16X80	25	04100.160.080	M24X260	10	04100.240.260
M8X40	200	04100.080.040	M16X90	25	04100.160.090	M24X280	10	04100.240.280
M8X45	200	04100.080.045	M16X95	25	04100.160.095			
M8X50	200	04100.080.050	M16X100	25	04100.160.100	M27X80	10	04100.270.080
M8X60	200	04100.080.060	M16X110	25	04100.160.110	M27X90	10	04100.270.090
M8X70	200	04100.080.070	M16X120	25	04100.160.120	M27X100	10	04100.270.100
M8X80	200	04100.080.080	M16X130	25	04100.160.130	M27X110	10	04100.270.110
M8X90	100	04100.080.090	M16X140	25	04100.160.140	M27X120	10	04100.270.120
M8X100	100	04100.080.100	M16X150	25	04100.160.150	M27X130	10	04100.270.130
M8X110	100	04100.080.110	M16X160	25	04100.160.160	M27X140	10	04100.270.140
M8X120	100	04100.080.120	M16X170	25	04100.160.170	M27X150	10	04100.270.150
			M16X180	25	04100.160.180	M27X160	10	04100.270.160
M10X40/S=17	100	04100.100.040	M16X190	25	04100.160.190	M27X170	5	04100.270.170
M10X45/S=17	100	04100.100.045	M16X200	25	04100.160.200	M27X180	5	04100.270.180
M10X50/S=17	100	04100.100.050	M16X220	25	04100.160.220	M27X190	5	04100.270.190
M10X55/S=17	100	04100.100.055	M16X240	10	04100.160.240	M27X200	5	04100.270.200
M10X60/S=17	100	04100.100.060	M16X250	10	04100.160.250			
M10X65/S=17	100	04100.100.065				M30X90	10	04100.300.090
M10X70/S=17	100	04100.100.070	M18X60	25	04100.180.060	M30X100	10	04100.300.100
M10X75/S=17	100	04100.100.075	M18X65	25	04100.180.065	M30X110	10	04100.300.110
M10X80/S=17	100	04100.100.080	M18X70	25	04100.180.070	M30X120	10	04100.300.120
M10X90/S=17	100	04100.100.090	M18X80	25	04100.180.080	M30X130	10	04100.300.130
M10X100/S=17	100	04100.100.100	M18X85	100	04100.180.085	M30X140	10	04100.300.140
M10X110/S=17	50	04100.100.110	M18X90	25	04100.180.090	M30X150	10	04100.300.150
M10X120/S=17	50	04100.100.120	M18X100	25	04100.180.100	M30X160	10	04100.300.160
M10X130/S=17	50	04100.100.130	M18X110	25	04100.180.110	M30X170	5	04100.300.170
M10X140/S=17	50	04100.100.140	M18X120	25	04100.180.120	M30X180	5	04100.300.180
M10X150/S=17	50	04100.100.150				M30X200	5	04100.300.200
M10X160/S=17	50	04100.100.160	M20X65	25	04100.200.065	M30X220	5	04100.300.220
M10X180/S=17	50	04100.100.180	M20X70	25	04100.200.070	M30X240	5	04100.300.240
			M20X75	25	04100.200.075	M30X260	5	04100.300.260
M12X45/S=19	100	04100.120.045	M20X80	25	04100.200.080	M30X280	5	04100.300.280
M12X50/S=19	100	04100.120.050	M20X85	25	04100.200.085	M30X300	5	04100.300.300
M12X55/S=19	100	04100.120.055	M20X90	25	04100.200.090			
M12X60/S=19	100	04100.120.060	M20X95	25	04100.200.095	M33X100	5	04100.330.100
M12X65/S=19	50	04100.120.065	M20X100	25	04100.200.100	M33X110	5	04100.330.110
M12X70/S=19	50	04100.120.070	M20X110	25	04100.200.110	M33X120	5	04100.330.120
M12X75/S=19	100	04100.120.075	M20X120	25	04100.200.120	M33X130	5	04100.330.130
M12X80/S=19	50	04100.120.080	M20X130	25	04100.200.130	M33X140	5	04100.330.140
M12X85/S=19	50	04100.120.085	M20X140	25	04100.200.140	M33X150	5	04100.330.150
M12X90/S=19	50	04100.120.090	M20X150	25	04100.200.150	M33X160	5	04100.330.160
M12X100/S=19	50	04100.120.100	M20X160	10	04100.200.160	M33X180	2	04100.330.180
M12X110/S=19	50	04100.120.110	M20X170	10	04100.200.170	M33X200	2	04100.330.200
M12X120/S=19	50	04100.120.120	M20X180	10	04100.200.180	M33X240	2	04100.330.240
M12X130/S=19	25	04100.120.130	M20X190	10	04100.200.190			
M12X140/S=19	25	04100.120.140	M20X200	10	04100.200.200	M36X100	5	04100.360.100
M12X150/S=19	25	04100.120.150	M20X220	10	04100.200.220	M36X110	5	04100.360.110
M12X160/S=19	25	04100.120.160	M20X230	10	04100.200.230	M36X120	5	04100.360.120
M12X180/S=19	25	04100.120.180	M20X240	10	04100.200.240	M36X130	5	04100.360.130
M12X200/S=19	25	04100.120.200	M20X260	10	04100.200.260	M36X140	5	04100.360.140
M12X220/S=19	25	04100.120.220				M36X150	5	04100.360.150
			M22X70/S=32	10	04100.220.070	M36X160	5	04100.360.160
M14X45/S=22	50	04100.140.045	M22X75/S=32	10	04100.220.075	M36X180	2	04100.360.180
M14X50/S=22	50	04100.140.050	M22X80/S=32	10	04100.220.080	M36X200	2	04100.360.200
M14X55/S=22	50	04100.140.055	M22X90/S=32	10	04100.220.090	M36X220	2	04100.360.220
M14X60/S=22	50	04100.140.060	M22X100/S=32	10	04100.220.100	M36X240	2	04100.360.240
M14X65/S=22	50	04100.140.065	M22X110/S=32	10	04100.220.110	M36X260	2	04100.360.260
M14X70/S=22	50	04100.140.070	M22X120/S=32	10	04100.220.120	M36X300	2	04100.360.300
M14X75/S=22	50	04100.140.075	M22X130/S=32	10	04100.220.130			
M14X80/S=22	50	04100.140.080				M39X120	1	04100.390.120
M14X85/S=22	50	04100.140.085	M24X75	25	04100.240.075	M39X140	1	04100.390.140
M14X90/S=22	50	04100.140.090	M24X80	25	04100.240.080	M39X150	5	04100.390.150
M14X100/S=22	50	04100.140.100	M24X90	10	04100.240.090	M39X160	1	04100.390.160
M14X120/S=22	50	04100.140.120	M24X100	10	04100.240.100	M39X180	1	04100.390.180



04100 Śruby z łbem sześciokątnym

d x L	☒	Kod artykułu	d x L	☒	Kod artykułu	d x L	☒	Kod artykułu
M39X190	1	04100.390.190	M42X200	1	04100.420.200	M45X200	1	04100.450.200
M39X200	1	04100.390.200	M42X220	1	04100.420.220	M45X220	1	04100.450.220
M42X160	1	04100.420.160	M42X240	1	04100.420.240	M45X240	1	04100.450.240
M42X180	1	04100.420.180	M45X160	1	04100.450.160			

- Ostrzeżenie: cynkowanie elektrolityczne tych produktów może wywołać kruchość wodorową.

04105 Śruby z łbem sześciokątnym C95A

Gwint	Metryczny
Materiał	Stal
Klasa	10.9
Obrobka powierzchni	Ocynk płatkowy bez Cr6+ wg ISO 10683 (fiZnnc)

d x L	☒	Kod artykułu	d x L	☒	Kod artykułu	d x L	☒	Kod artykułu
M6X30	200	04105.060.030	M10X120	50	04105.100.120	M16X120	25	04105.160.120
M6X35	200	04105.060.035				M16X130	25	04105.160.130
M6X40	200	04105.060.040	M12X45	100	04105.120.045	M16X140	25	04105.160.140
M6X50	200	04105.060.050	M12X50	100	04105.120.050	M16X150	10	04105.160.150
M6X60	200	04105.060.060	M12X60	100	04105.120.060	M16X160	10	04105.160.160
M6X70	200	04105.060.070	M12X70	50	04105.120.070			
M6X80	200	04105.060.080	M12X80	50	04105.120.080	M20X70	25	04105.200.070
			M12X90	50	04105.120.090	M20X80	25	04105.200.080
M8X35	200	04105.080.035	M12X100	50	04105.120.100	M20X90	25	04105.200.090
M8X40	200	04105.080.040	M12X120	50	04105.120.120	M20X100	25	04105.200.100
M8X45	200	04105.080.045				M20X120	25	04105.200.120
M8X50	200	04105.080.050	M14X50	50	04105.140.050	M20X140	25	04105.200.140
M8X60	200	04105.080.060	M14X60	50	04105.140.060	M20X160	10	04105.200.160
M8X70	200	04105.080.070	M14X80	50	04105.140.080	M20X200	10	04105.200.200
			M14X90	50	04105.140.090			
M10X40	100	04105.100.040	M14X100	50	04105.140.100	M24X80	25	04105.240.080
M10X45	100	04105.100.045				M24X90	10	04105.240.090
M10X50	100	04105.100.050	M16X55	50	04105.160.055	M24X100	10	04105.240.100
M10X60	100	04105.100.060	M16X60	50	04105.160.060	M24X120	10	04105.240.120
M10X70	100	04105.100.070	M16X65	25	04105.160.065	M24X140	10	04105.240.140
M10X80	100	04105.100.080	M16X70	25	04105.160.070	M24X160	10	04105.240.160
M10X90	100	04105.100.090	M16X80	25	04105.160.080	M24X180	10	04105.240.180
M10X100	100	04105.100.100	M16X90	25	04105.160.090	M24X200	10	04105.240.200
M10X110	50	04105.100.110	M16X100	25	04105.160.100			

- Powlekanie powierzchniowe ISO 10683 cynkowanie płatkowe eliminuje możliwości uszkodzenia, jakie może wywołać kruchość wodorowa.

04108 Śruby z łbem sześciokątnym C01A

Gwint	Metryczny
Materiał	Stal
Klasa	12.9



d x L	☒	Kod artykułu	d x L	☒	Kod artykułu	d x L	☒	Kod artykułu
M6X30	200	04108.060.030	M12X60/S=19	100	04108.120.060	M16X120	25	04108.160.120
M6X40	200	04108.060.040	M12X70/S=19	50	04108.120.070	M16X130	25	04108.160.130
M6X50	200	04108.060.050	M12X80/S=19	50	04108.120.080	M16X140	25	04108.160.140
M6X60	200	04108.060.060	M12X90/S=19	50	04108.120.090	M16X160	25	04108.160.160
			M12X100/S=19	50	04108.120.100			
M8X40	200	04108.080.040	M12X110/S=19	50	04108.120.110	M20X70	25	04108.200.070
M8X50	200	04108.080.050	M12X120/S=19	50	04108.120.120	M20X80	25	04108.200.080
M8X60	200	04108.080.060				M20X90	25	04108.200.090
M8X80	200	04108.080.080	M14X50/S=22	50	04108.140.050	M20X100	25	04108.200.100
M8X100	100	04108.080.100	M14X60/S=22	50	04108.140.060	M20X110	25	04108.200.110
			M14X70/S=22	50	04108.140.070	M20X140	25	04108.200.140
M10X40/S=17	100	04108.100.040	M14X80/S=22	50	04108.140.080	M20X160	10	04108.200.160
M10X45/S=17	100	04108.100.045	M14X90/S=22	50	04108.140.090			
M10X50/S=17	100	04108.100.050	M14X100/S=22	50	04108.140.100	M24X80	25	04108.240.080
M10X60/S=17	100	04108.100.060	M14X120/S=22	50	04108.140.120	M24X90	10	04108.240.090
M10X70/S=17	100	04108.100.070				M24X100	10	04108.240.100
M10X80/S=17	100	04108.100.080	M16X60	50	04108.160.060			
M10X100/S=17	100	04108.100.100	M16X70	25	04108.160.070	M30X90	10	04108.300.090
M10X120/S=17	50	04108.100.120	M16X80	25	04108.160.080	M30X100	10	04108.300.100
			M16X90	25	04108.160.090	M30X110	10	04108.300.110
M12X45/S=19	100	04108.120.045	M16X100	25	04108.160.100	M30X120	10	04108.300.120
M12X50/S=19	100	04108.120.050	M16X110	25	04108.160.110			

- Ostrzeżenie: cynkowanie elektrolityczne tych produktów może wywołać kruchość wodorową.

08750		Śruby z łbem sześciokątnym do zbiorników ciśnieniowych		E11A	
Gwint	Metryczny				
Materiał	Stal				
Klasa	5.6				

d x L	☒	Kod artykułu	d x L	☒	Kod artykułu	d x L	☒	Kod artykułu
M12X50/S=18	100	08750.120.051	M16X160	25	08750.160.160	M24X110	10	08750.240.110
M12X55/S=18	100	08750.120.056	M16X180	25	08750.160.180	M24X120	10	08750.240.120
M12X60/S=18	100	08750.120.061				M24X150	10	08750.240.150
M12X65/S=18	50	08750.120.066	M20X75	25	08750.200.075	M24X160	10	08750.240.160
M12X70/S=18	50	08750.120.071	M20X80	25	08750.200.080	M24X180	10	08750.240.180
M12X80/S=18	50	08750.120.081	M20X90	25	08750.200.090	M24X200	10	08750.240.200
			M20X100	25	08750.200.100	M24X220	10	08750.240.220
M16X60	50	08750.160.060	M20X110	25	08750.200.110			
M16X65	25	08750.160.065	M20X120	25	08750.200.120	M27X90	10	08750.270.090
M16X70	25	08750.160.070	M20X130	25	08750.200.130	M27X100	10	08750.270.100
M16X75	25	08750.160.075	M20X140	25	08750.200.140	M27X110	10	08750.270.110
M16X80	25	08750.160.080	M20X150	25	08750.200.150	M27X120	10	08750.270.120
M16X90	25	08750.160.090	M20X160	10	08750.200.160	M27X130	10	08750.270.130
M16X100	25	08750.160.100	M20X180	10	08750.200.180	M27X240	5	08750.270.240
M16X110	25	08750.160.110						
M16X120	25	08750.160.120	M24X90	10	08750.240.090	M30X120	10	08750.300.120
M16X140	25	08750.160.140	M24X100	10	08750.240.100			

- Specjalne cechy śrub z łbem sześciokątnym do zbiorników ciśnieniowych etc.:
- Przeznaczone są do stosowania w zbiornikach ciśnieniowych, urządzeniach parowych, sprzęcie i połączeniach kołnierzowych w temperaturach od -10°C do +300°C, nadciśnieniu max. 40 bar i rozmiarach do M30 włącznie.
- Spełniają wymagania AD-Merkblatt W7, TRD 106 z TÜV (Technischer Überwachungsverein) i DIN 267-13.
- Zgodnie z TUV-Merkstoffe 1253, producent otrzymał uprawnienia na dostarczanie tych śrub bez certyfikatu 3.1, wystarczy znak handlowy i oznaczenie klasy.
- Certyfikat jest również zaakceptowany "Lloyd's Register Energy".

51000		Śruby z łbem sześciokątnym		Q01A	
Gwint	Metryczny				
Materiał	Stal nierdzewna A2				
Klasa	70				

d x L	☒	Kod artykułu	d x L	☒	Kod artykułu	d x L	☒	Kod artykułu
M5X25	200	51000.050.025	M6X190*	100	51000.060.190	M10X55/S=17	100	51000.100.055
M5X30	100	51000.050.030	M6X200*	100	51000.060.200	M10X60/S=17	100	51000.100.060
M5X35	100	51000.050.035				M10X65/S=17	50	51000.100.065
M5X40	100	51000.050.040	M8X30	200	51000.080.030	M10X70/S=17	50	51000.100.070
M5X45	100	51000.050.045	M8X35	100	51000.080.035	M10X75/S=17	50	51000.100.075
M5X50	100	51000.050.050	M8X40	100	51000.080.040	M10X80/S=17	50	51000.100.080
M5X55	100	51000.050.055	M8X45	100	51000.080.045	M10X85/S=17	50	51000.100.085
M5X60	100	51000.050.060	M8X50	100	51000.080.050	M10X90/S=17	50	51000.100.090
M5X65*	200	51000.050.065	M8X55	100	51000.080.055	M10X95/S=17	50	51000.100.095
M5X70	100	51000.050.070	M8X60	100	51000.080.060	M10X100/S=17	50	51000.100.100
M5X75*	100	51000.050.075	M8X65	100	51000.080.065	M10X110/S=17	50	51000.100.110
M5X80*	100	51000.050.080	M8X70	100	51000.080.070	M10X120/S=17	25	51000.100.120
M5X85*	100	51000.050.085	M8X75	100	51000.080.075	M10X130/S=17	25	51000.100.130
M5X90*	100	51000.050.090	M8X80	100	51000.080.080	M10X140/S=17	25	51000.100.140
M5X95*	100	51000.050.095	M8X85*	50	51000.080.085	M10X150/S=17	25	51000.100.150
M5X100*	100	51000.050.100	M8X90	100	51000.080.090	M10X160/S=17	25	51000.100.160
			M8X95*	50	51000.080.095	M10X170/S=17	25	51000.100.170
M6X25	200	51000.060.025	M8X100	100	51000.080.100	M10X180/S=17	25	51000.100.180
M6X30	200	51000.060.030	M8X110	50	51000.080.110	M10X190/S=17	25	51000.100.190
M6X35	100	51000.060.035	M8X120	50	51000.080.120	M10X200/S=17	10	51000.100.200
M6X40	100	51000.060.040	M8X130	50	51000.080.130	M10X210/S=17*	10	51000.100.210
M6X45	100	51000.060.045	M8X140	50	51000.080.140	M10X220/S=17*	10	51000.100.220
M6X50	100	51000.060.050	M8X150	50	51000.080.150	M10X230/S=17*	10	51000.100.230
M6X55	100	51000.060.055	M8X160	25	51000.080.160	M10X240/S=17*	10	51000.100.240
M6X60	100	51000.060.060	M8X170	25	51000.080.170	M10X250/S=17*	10	51000.100.250
M6X65	100	51000.060.065	M8X180	25	51000.080.180	M10X260*	10	51000.100.260
M6X70	100	51000.060.070	M8X190	25	51000.080.190	M10X270/S=17*	10	51000.100.270
M6X75	100	51000.060.075	M8X200	10	51000.080.200	M10X280/S=17*	10	51000.100.280
M6X80	100	51000.060.080	M8X210*	25	51000.080.210	M10X290/S=17*	10	51000.100.290
M6X85*	100	51000.060.085	M8X220	25	51000.080.220	M10X300*	10	51000.100.300
M6X90	100	51000.060.090	M8X230*	25	51000.080.230	M10X320/S=17*	10	51000.100.320
M6X95	100	51000.060.095	M8X240*	25	51000.080.240	M10X340*	10	51000.100.340
M6X100	100	51000.060.100	M8X250*	25	51000.080.250	M10X360/S=17*	10	51000.100.360
M6X110	50	51000.060.110	M8X260*	25	51000.080.260	M10X380*	10	51000.100.380
M6X120	50	51000.060.120	M8X270*	25	51000.080.270	M10X400*	10	51000.100.400
M6X130	50	51000.060.130	M8X280*	25	51000.080.280	M10X420*	10	51000.100.420
M6X140	50	51000.060.140				M10X440*	10	51000.100.440
M6X150	50	51000.060.150	M10X35/S=17	100	51000.100.035	M10X480*	10	51000.100.480
M6X160*	100	51000.060.160	M10X40/S=17	100	51000.100.040			
M6X170*	100	51000.060.170	M10X45/S=17	100	51000.100.045	M12X40/S=19	50	51000.120.040
M6X180	50	51000.060.180	M10X50/S=17	100	51000.100.050	M12X45/S=19	50	51000.120.045

51000 Śruby z łbem sześciokątnym								
d x L	☒	Kod artykułu	d x L	☒	Kod artykułu	d x L	☒	Kod artykułu
M12X50/S=19	50	51000.120.050	M16X170	10	51000.160.170	M20X340*	5	51000.200.340
M12X55/S=19	50	51000.120.055	M16X180	5	51000.160.180	M20X360*	5	51000.200.360
M12X60/S=19	50	51000.120.060	M16X190	5	51000.160.190	M20X380*	5	51000.200.380
M12X65/S=19	50	51000.120.065	M16X200	5	51000.160.200	M20X400*	5	51000.200.400
M12X70/S=19	50	51000.120.070	M16X210	5	51000.160.210	M20X420*	5	51000.200.420
M12X75/S=19	50	51000.120.075	M16X220	5	51000.160.220	M20X440*	5	51000.200.440
M12X80/S=19	50	51000.120.080	M16X230	5	51000.160.230	M20X460*	5	51000.200.460
M12X85/S=19	25	51000.120.085	M16X240	5	51000.160.240	M20X480*	5	51000.200.480
M12X90/S=19	50	51000.120.090	M16X250	5	51000.160.250	M20X500*	5	51000.200.500
M12X95/S=19*	25	51000.120.095	M16X260	5	51000.160.260	M20X520*	5	51000.200.520
M12X100/S=19	50	51000.120.100	M16X270*	10	51000.160.270	M20X540*	5	51000.200.540
M12X110/S=19	25	51000.120.110	M16X280	5	51000.160.280	M20X560*	5	51000.200.560
M12X120/S=19	25	51000.120.120	M16X290*	10	51000.160.290	M20X580*	5	51000.200.580
M12X130/S=19	25	51000.120.130	M16X300*	10	51000.160.300	M20X600*	5	51000.200.600
M12X140/S=19	25	51000.120.140	M16X320*	10	51000.160.320			
M12X150/S=19	25	51000.120.150	M16X340*	10	51000.160.340	M22X70/S=32	10	51000.220.070
M12X160/S=19	25	51000.120.160	M16X360*	10	51000.160.360	M22X75/S=32*	25	51000.220.075
M12X170/S=19	25	51000.120.170	M16X370	10	51000.160.370	M22X80/S=32	10	51000.220.080
M12X180/S=19	25	51000.120.180	M16X380*	10	51000.160.380	M22X85/S=32*	25	51000.220.085
M12X190/S=19	25	51000.120.190	M16X400*	10	51000.160.400	M22X90/S=32	10	51000.220.090
M12X200/S=19	10	51000.120.200	M16X420*	10	51000.160.420	M22X95/S=32*	25	51000.220.095
M12X210/S=19*	10	51000.120.210	M16X440*	10	51000.160.440	M22X100/S=32	10	51000.220.100
M12X220/S=19*	10	51000.120.220	M16X540*	10	51000.160.450	M22X110/S=32	5	51000.220.110
M12X230/S=19*	10	51000.120.230	M16X460*	10	51000.160.460	M22X120/S=32	5	51000.220.120
M12X240/S=19*	10	51000.120.240	M16X480*	10	51000.160.480	M22X130/S=32*	20	51000.220.130
M12X250/S=19*	10	51000.120.250	M16X500*	10	51000.160.500	M22X140/S=32	5	51000.220.140
M12X260/S=19*	10	51000.120.260	M16X520*	10	51000.160.520	M22X150/S=32	5	51000.220.150
M12X270/S=19*	10	51000.120.270	M16X560*	10	51000.160.560	M22X160/S=32*	10	51000.220.160
M12X280/S=19*	10	51000.120.280	M16X580*	10	51000.160.580	M22X170/S=32*	10	51000.220.170
M12X290/S=19*	10	51000.120.290				M22X180/S=32	5	51000.220.180
M12X300/S=19*	10	51000.120.300	M18X60	25	51000.180.060	M22X190/S=32*	10	51000.220.190
M12X320/S=19*	10	51000.120.320	M18X65	25	51000.180.065	M22X200/S=32*	10	51000.220.200
M12X340/S=19*	10	51000.120.340	M18X70	25	51000.180.070			
M12X360/S=19*	10	51000.120.360	M18X75*	25	51000.180.075	M24X65*	10	51000.240.065
M12X380/S=19*	10	51000.120.380	M18X80	10	51000.180.080	M24X70	10	51000.240.070
M12X400/S=19*	10	51000.120.400	M18X85*	25	51000.180.085	M24X75	10	51000.240.075
M12X420/S=19*	10	51000.120.420	M18X90	10	51000.180.090	M24X80	5	51000.240.080
M12X440/S=19*	10	51000.120.440	M18X95*	25	51000.180.095	M24X85*	10	51000.240.085
M12X460/S=19*	10	51000.120.460	M18X100	10	51000.180.100	M24X90	5	51000.240.090
M12X480/S=19*	10	51000.120.480	M18X110	10	51000.180.110	M24X95*	10	51000.240.095
M12X500/S=19*	10	51000.120.500	M18X120	10	51000.180.120	M24X100	5	51000.240.100
			M18X130	10	51000.180.130	M24X110	5	51000.240.110
M14X50/S=22	50	51000.140.050	M18X140	10	51000.180.140	M24X120	5	51000.240.120
M14X55/S=22	50	51000.140.055	M18X150	10	51000.180.150	M24X130	5	51000.240.130
M14X60/S=22	50	51000.140.060	M18X160*	25	51000.180.160	M24X140	5	51000.240.140
M14X65/S=22*	50	51000.140.065	M18X170*	25	51000.180.170	M24X150	5	51000.240.150
M14X70/S=22	50	51000.140.070	M18X180*	25	51000.180.180	M24X160	5	51000.240.160
M14X75/S=22*	25	51000.140.075	M18X190*	25	51000.180.190	M24X170*	10	51000.240.170
M14X80/S=22	10	51000.140.080	M18X200	5	51000.180.200	M24X180	5	51000.240.180
M14X85/S=22*	25	51000.140.085				M24X190*	10	51000.240.190
M14X90/S=22	10	51000.140.090	M20X55*	25	51000.200.055	M24X200	5	51000.240.200
M14X95/S=22*	25	51000.140.095	M20X60	25	51000.200.060	M24X210*	5	51000.240.210
M14X100/S=22	10	51000.140.100	M20X65	25	51000.200.065	M24X220	5	51000.240.220
M14X110/S=22*	25	51000.140.110	M20X70	25	51000.200.070	M24X230*	5	51000.240.230
M14X120/S=22	10	51000.140.120	M20X75	10	51000.200.075	M24X240	5	51000.240.240
M14X130/S=22	10	51000.140.130	M20X80	25	51000.200.080	M24X250*	5	51000.240.250
M14X140/S=22	10	51000.140.140	M20X85	25	51000.200.085	M24X260	5	51000.240.260
M14X150/S=22	10	51000.140.150	M20X90	25	51000.200.090	M24X270*	5	51000.240.270
M14X160/S=22	10	51000.140.160	M20X95*	25	51000.200.095	M24X280*	5	51000.240.280
M14X170/S=22*	10	51000.140.170	M20X100	25	51000.200.100	M24X290*	5	51000.240.290
M14X180/S=22	10	51000.140.180	M20X105*	25	51000.200.105	M24X300*	5	51000.240.300
M14X190/S=22*	10	51000.140.190	M20X110	25	51000.200.110	M24X320*	5	51000.240.320
M14X200/S=22	10	51000.140.200	M20X120	10	51000.200.120	M24X340*	5	51000.240.340
			M20X130	10	51000.200.130	M24X360*	5	51000.240.360
M16X45	25	51000.160.045	M20X140	10	51000.200.140	M24X380*	5	51000.240.380
M16X50	50	51000.160.050	M20X150	10	51000.200.150	M24X400*	5	51000.240.400
M16X55	50	51000.160.055	M20X160	10	51000.200.160	M24X420*	5	51000.240.420
M16X60	25	51000.160.060	M20X170	10	51000.200.170	M24X440*	5	51000.240.440
M16X65	25	51000.160.065	M20X180	10	51000.200.180	M24X460*	5	51000.240.460
M16X70	25	51000.160.070	M20X190	10	51000.200.190	M24X480*	5	51000.240.480
M16X75	25	51000.160.075	M20X200	5	51000.200.200	M24X500*	5	51000.240.500
M16X80	25	51000.160.080	M20X210*	10	51000.200.210	M24X520*	5	51000.240.520
M16X85	25	51000.160.085	M20X220	5	51000.200.220	M24X540*	5	51000.240.540
M16X90	25	51000.160.090	M20X230	5	51000.200.230	M24X560*	5	51000.240.560
M16X95*	25	51000.160.095	M20X240	5	51000.200.240			
M16X100	25	51000.160.100	M20X250*	10	51000.200.250	M27X70*	10	51000.270.070
M16X110	25	51000.160.110	M20X260	5	51000.200.260	M27X75*	10	51000.270.075
M16X120	10	51000.160.120	M20X270*	10	51000.200.270	M27X80*	10	51000.270.080
M16X130	10	51000.160.130	M20X280*	10	51000.200.280	M27X85*	10	51000.270.085
M16X140	10	51000.160.140	M20X290*	10	51000.200.290	M27X90	3	51000.270.090
M16X150	10	51000.160.150	M20X300*	5	51000.200.300	M27X95*	10	51000.270.095
M16X160	10	51000.160.160	M20X320*	5	51000.200.320	M27X100	3	51000.270.100

51000 Śruby z łbem sześciokątnym								
d x L	☒	Kod artykułu	d x L	☒	Kod artykułu	d x L	☒	Kod artykułu
M27X110	3	51000.270.110	M30X250*	5	51000.300.250	M36X240	1	51000.360.240
M27X120	3	51000.270.120	M30X260	1	51000.300.260	M36X250*	5	51000.360.250
M27X130	3	51000.270.130	M30X270*	5	51000.300.270	M36X260	1	51000.360.260
M27X140	3	51000.270.140	M30X280*	5	51000.300.280	M36X270*	5	51000.360.270
M27X150	3	51000.270.150	M30X290*	5	51000.300.290	M36X280*	5	51000.360.280
M27X160	3	51000.270.160	M30X300*	5	51000.300.300	M36X300*	5	51000.360.300
M27X170*	5	51000.270.170						
M27X180	3	51000.270.180	M33X90	1	51000.330.090	M39X120*	10	51000.390.120
M27X190*	5	51000.270.190	M33X100	1	51000.330.100	M39X130*	10	51000.390.130
M27X200	3	51000.270.200	M33X110	1	51000.330.110	M39X140*	10	51000.390.140
M27X210*	5	51000.270.210	M33X120	1	51000.330.120	M39X150*	5	51000.390.150
M27X220	3	51000.270.220	M33X130	1	51000.330.130	M39X160*	5	51000.390.160
M27X230*	5	51000.270.230	M33X140	1	51000.330.140	M39X170*	5	51000.390.170
M27X240	3	51000.270.240	M33X150	1	51000.330.150	M39X180*	5	51000.390.180
M27X250	3	51000.270.250	M33X160	1	51000.330.160	M39X190*	5	51000.390.190
M27X260*	5	51000.270.260	M33X170	1	51000.330.170	M39X200*	5	51000.390.200
M27X270*	5	51000.270.270	M33X180	1	51000.330.180			
M27X280*	5	51000.270.280	M33X190	1	51000.330.190	M42X120*	5	51000.420.120
M27X290*	5	51000.270.290	M33X200	1	51000.330.200	M42X130*	5	51000.420.130
M27X300*	5	51000.270.300	M33X210*	5	51000.330.210	M42X140*	5	51000.420.140
			M33X220	1	51000.330.220	M42X150*	5	51000.420.150
M30X80	1	51000.300.080	M33X230*	5	51000.330.230	M42X160*	5	51000.420.160
M30X85*	10	51000.300.085	M33X240	1	51000.330.240	M42X170*	5	51000.420.170
M30X90	1	51000.300.090	M33X260*	5	51000.330.260	M42X180*	5	51000.420.180
M30X95*	10	51000.300.095	M33X300*	5	51000.330.300	M42X200*	5	51000.420.200
M30X100	1	51000.300.100						
M30X110	1	51000.300.110	M36X100	1	51000.360.100	M45X140*	5	51000.450.140
M30X120	1	51000.300.120	M36X110	1	51000.360.110	M45X150*	5	51000.450.150
M30X130	1	51000.300.130	M36X120	1	51000.360.120	M45X160*	5	51000.450.160
M30X140	1	51000.300.140	M36X130	1	51000.360.130	M45X170*	5	51000.450.170
M30X150	1	51000.300.150	M36X140	1	51000.360.140	M45X180*	5	51000.450.180
M30X160	1	51000.300.160	M36X150	1	51000.360.150			
M30X170	1	51000.300.170	M36X160	1	51000.360.160	M48X150*	5	51000.480.150
M30X180	1	51000.300.180	M36X170	1	51000.360.170	M48X200*	5	51000.480.200
M30X190	1	51000.300.190	M36X180	1	51000.360.180			
M30X200	1	51000.300.200	M36X190	1	51000.360.190	M52X160*	5	51000.520.160
M30X210*	5	51000.300.210	M36X200	1	51000.360.200	M52X180*	5	51000.520.180
M30X220	1	51000.300.220	M36X210*	5	51000.360.210	M52X200*	5	51000.520.200
M30X230*	5	51000.300.230	M36X220	1	51000.360.220			
M30X240	1	51000.300.240	M36X230*	5	51000.360.230			



* Rozmiary o średnicy > M24 i rozmiary o długości > 8xd mają minimalną klasę właściwości 5.0.

55000 Śruby z łbem sześciokątnym								Q41A
Gwint	Metryczny							
Materiał	Stal nierdzewna A4							
Klasa	70							
d x L	☒	Kod artykułu	d x L	☒	Kod artykułu	d x L	☒	Kod artykułu
M5X25*	200	55000.050.025	M6X90	100	55000.060.090	M8X110	50	55000.080.110
M5X30	100	55000.050.030	M6X95*	100	55000.060.095	M8X120	50	55000.080.120
M5X35	100	55000.050.035	M6X100	100	55000.060.100	M8X130	50	55000.080.130
M5X40	100	55000.050.040	M6X110	50	55000.060.110	M8X140	50	55000.080.140
M5X45	100	55000.050.045	M6X120	50	55000.060.120	M8X150	50	55000.080.150
M5X50	100	55000.050.050	M6X130	50	55000.060.130	M8X160	25	55000.080.160
M5X55	100	55000.050.055	M6X140	50	55000.060.140	M8X170	25	55000.080.170
M5X60*	200	55000.050.060	M6X150	50	55000.060.150	M8X180	25	55000.080.180
M5X65*	200	55000.050.065	M6X160	50	55000.060.160	M8X190	25	55000.080.190
M5X70*	100	55000.050.070	M6X170	50	55000.060.170	M8X200	10	55000.080.200
M5X75*	100	55000.050.075	M6X180	50	55000.060.180	M8X210*	25	55000.080.210
M5X80*	100	55000.050.080	M6X200*	100	55000.060.200	M8X220	10	55000.080.220
M5X90*	100	55000.050.090				M8X230*	25	55000.080.230
M5X100*	100	55000.050.100	M8X30	100	55000.080.030	M8X240*	25	55000.080.240
			M8X35	100	55000.080.035	M8X260*	25	55000.080.260
M6X25*	200	55000.060.025	M8X40	100	55000.080.040	M8X270*	25	55000.080.270
M6X30	200	55000.060.030	M8X45	100	55000.080.045	M8X300*	25	55000.080.300
M6X35	100	55000.060.035	M8X50	100	55000.080.050			
M6X40	100	55000.060.040	M8X55	100	55000.080.055	M10X35/S=17	100	55000.100.035
M6X45	100	55000.060.045	M8X60	100	55000.080.060	M10X40/S=17	100	55000.100.040
M6X50	100	55000.060.050	M8X65	100	55000.080.065	M10X45/S=17	100	55000.100.045
M6X55	100	55000.060.055	M8X70	100	55000.080.070	M10X50/S=17	100	55000.100.050
M6X60	100	55000.060.060	M8X75	100	55000.080.075	M10X55/S=17	100	55000.100.055
M6X65	100	55000.060.065	M8X80	100	55000.080.080	M10X60/S=17	100	55000.100.060
M6X70	100	55000.060.070	M8X85	50	55000.080.085	M10X65/S=17	50	55000.100.065
M6X75	100	55000.060.075	M8X90	100	55000.080.090	M10X70/S=17	50	55000.100.070
M6X80	100	55000.060.080	M8X95*	50	55000.080.095	M10X75/S=17	50	55000.100.075
M6X85*	100	55000.060.085	M8X100	100	55000.080.100	M10X80/S=17	50	55000.100.080

55000 Śruby z łbem sześciokątnym								
d x L	☒	Kod artykułu	d x L	☒	Kod artykułu	d x L	☒	Kod artykułu
M10X85/S=17	50	55000.100.085	M14X150/S=22	10	55000.140.150	M20X130	10	55000.200.130
M10X90/S=17	50	55000.100.090	M14X160/S=22	10	55000.140.160	M20X140	10	55000.200.140
M10X95/S=17	50	55000.100.095	M14X170/S=22*	10	55000.140.170	M20X150	10	55000.200.150
M10X100/S=17	50	55000.100.100	M14X180/S=22	10	55000.140.180	M20X160	10	55000.200.160
M10X110/S=17	50	55000.100.110	M14X190/S=22*	10	55000.140.190	M20X170*	10	55000.200.170
M10X120/S=17	25	55000.100.120	M14X200/S=22	10	55000.140.200	M20X180	10	55000.200.180
M10X130/S=17	25	55000.100.130				M20X190*	10	55000.200.190
M10X140/S=17	25	55000.100.140	M16X45*	25	55000.160.045	M20X200	5	55000.200.200
M10X150/S=17	25	55000.100.150	M16X50*	25	55000.160.050	M20X210*	10	55000.200.210
M10X160/S=17	25	55000.100.160	M16X55	50	55000.160.055	M20X220	5	55000.200.220
M10X170/S=17	25	55000.100.170	M16X60	25	55000.160.060	M20X230*	10	55000.200.230
M10X180/S=17	25	55000.100.180	M16X65	25	55000.160.065	M20X240	5	55000.200.240
M10X190/S=17	25	55000.100.190	M16X70	25	55000.160.070	M20X250*	10	55000.200.250
M10X200/S=17	10	55000.100.200	M16X75	25	55000.160.075	M20X260	5	55000.200.260
M10X210/S=17*	10	55000.100.210	M16X80	25	55000.160.080	M20X270*	10	55000.200.270
M10X220/S=17	10	55000.100.220	M16X85	25	55000.160.085	M20X280	5	55000.200.280
M10X230/S=17*	10	55000.100.230	M16X90	25	55000.160.090	M20X290*	10	55000.200.290
M10X240/S=17*	10	55000.100.240	M16X95*	25	55000.160.095	M20X300	5	55000.200.300
M10X250/S=17*	10	55000.100.250	M16X100	25	55000.160.100	M20X320*	5	55000.200.320
M10X260/S=17*	10	55000.100.260	M16X110	25	55000.160.110	M20X340*	5	55000.200.340
M10X270/S=17*	10	55000.100.270	M16X120	10	55000.160.120	M20X360*	5	55000.200.360
M10X280/S=17*	10	55000.100.280	M16X130	10	55000.160.130	M20X380*	5	55000.200.380
M10X290/S=17*	10	55000.100.290	M16X140	10	55000.160.140	M20X400*	5	55000.200.400
M10X300/S=17*	10	55000.100.300	M16X150	10	55000.160.150	M20X420*	5	55000.200.420
M10X360/S=17*	10	55000.100.360	M16X160	10	55000.160.160	M20X440*	5	55000.200.440
M10X400/S=17*	10	55000.100.400	M16X170	10	55000.160.170	M20X460*	5	55000.200.460
			M16X180	5	55000.160.180	M20X500*	5	55000.200.500
			M16X190	10	55000.160.190			
M12X40/S=19	50	55000.120.040	M16X200	5	55000.160.200	M22X70/S=32*	25	55000.220.070
M12X45/S=19	50	55000.120.045	M16X210*	10	55000.160.210	M22X75/S=32*	25	55000.220.075
M12X50/S=19	50	55000.120.050	M16X220	5	55000.160.220	M22X80/S=32	10	55000.220.080
M12X55/S=19	50	55000.120.055	M16X230*	10	55000.160.230	M22X85/S=32*	25	55000.220.085
M12X60/S=19	50	55000.120.060	M16X240	5	55000.160.240	M22X90/S=32	10	55000.220.090
M12X65/S=19	50	55000.120.065	M16X250*	10	55000.160.250	M22X95/S=32*	25	55000.220.095
M12X70/S=19	50	55000.120.070	M16X260	5	55000.160.260	M22X100/S=32	10	55000.220.100
M12X75/S=19	50	55000.120.075	M16X270*	10	55000.160.270	M22X110/S=32*	20	55000.220.110
M12X80/S=19	25	55000.120.080	M16X280	5	55000.160.280	M22X120/S=32	5	55000.220.120
M12X85/S=19	25	55000.120.085	M16X290*	10	55000.160.290	M22X130/S=32	5	55000.220.130
M12X90/S=19	50	55000.120.090	M16X300	5	55000.160.300	M22X140/S=32	5	55000.220.140
M12X95/S=19	25	55000.120.095	M16X320*	10	55000.160.320	M22X150/S=32	5	55000.220.150
M12X100/S=19	50	55000.120.100	M16X340*	10	55000.160.340	M22X160/S=32*	10	55000.220.160
M12X110/S=19	25	55000.120.110	M16X360*	10	55000.160.360	M22X170/S=32*	10	55000.220.170
M12X120/S=19	25	55000.120.120	M16X380*	10	55000.160.380	M22X180/S=32*	10	55000.220.180
M12X130/S=19	25	55000.120.130	M16X400*	10	55000.160.400	M22X200/S=32*	10	55000.220.200
M12X140/S=19	25	55000.120.140	M16X420*	10	55000.160.420			
M12X150/S=19	25	55000.120.150	M16X440*	10	55000.160.440	M24X65*	10	55000.240.065
M12X160/S=19	25	55000.120.160	M16X460*	10	55000.160.460	M24X70	10	55000.240.070
M12X170/S=19	25	55000.120.170	M16X480*	10	55000.160.480	M24X75*	10	55000.240.075
M12X180/S=19	25	55000.120.180	M16X500*	10	55000.160.500	M24X80	5	55000.240.080
M12X190/S=19	25	55000.120.190				M24X85*	10	55000.240.085
M12X200/S=19	10	55000.120.200				M24X90	5	55000.240.090
M12X210/S=19	10	55000.120.210	M18X60*	25	55000.180.060	M24X95*	10	55000.240.095
M12X220/S=19	10	55000.120.220	M18X65	25	55000.180.065	M24X100	5	55000.240.100
M12X230/S=19*	10	55000.120.230	M18X70	25	55000.180.070	M24X110	5	55000.240.110
M12X240/S=19	10	55000.120.240	M18X75*	25	55000.180.075	M24X120	5	55000.240.120
M12X250/S=19*	10	55000.120.250	M18X80	10	55000.180.080	M24X130	5	55000.240.130
M12X260/S=19*	10	55000.120.260	M18X85*	25	55000.180.085	M24X140	5	55000.240.140
M12X270/S=19*	10	55000.120.270	M18X90	10	55000.180.090	M24X150	5	55000.240.150
M12X280/S=19*	10	55000.120.280	M18X95*	25	55000.180.095	M24X160	5	55000.240.160
M12X290/S=19*	10	55000.120.290	M18X100	10	55000.180.100	M24X170*	10	55000.240.170
M12X300/S=19*	10	55000.120.300	M18X110	10	55000.180.110	M24X180	5	55000.240.180
M12X320/S=19*	10	55000.120.320	M18X120	10	55000.180.120	M24X190*	10	55000.240.190
M12X340/S=19*	10	55000.120.340	M18X130*	25	55000.180.130	M24X200	5	55000.240.200
M12X360/S=19*	10	55000.120.360	M18X140*	25	55000.180.140	M24X210*	5	55000.240.210
M12X380/S=19*	10	55000.120.380	M18X150	10	55000.180.150	M24X220	5	55000.240.220
M12X400/S=19*	10	55000.120.400	M18X160*	25	55000.180.160	M24X230	5	55000.240.230
			M18X170*	25	55000.180.170	M24X240	5	55000.240.240
M14X45/S=22*	50	55000.140.045	M18X180*	25	55000.180.180	M24X250*	5	55000.240.250
M14X50/S=22*	50	55000.140.050	M18X190*	25	55000.180.190	M24X260	5	55000.240.260
M14X55/S=22*	50	55000.140.055	M18X200*	25	55000.180.200	M24X270	5	55000.240.270
M14X60/S=22	50	55000.140.060				M24X280*	5	55000.240.280
M14X65/S=22*	50	55000.140.065	M20X55*	25	55000.200.055	M24X290*	5	55000.240.290
M14X70/S=22	50	55000.140.070	M20X60	25	55000.200.060	M24X300*	5	55000.240.300
M14X75/S=22*	25	55000.140.075	M20X65	25	55000.200.065	M24X320*	5	55000.240.320
M14X80/S=22	10	55000.140.080	M20X70	25	55000.200.070	M24X340*	5	55000.240.340
M14X85/S=22*	25	55000.140.085	M20X75	25	55000.200.075	M24X360*	5	55000.240.360
M14X90/S=22	10	55000.140.090	M20X80	25	55000.200.080	M24X380*	5	55000.240.380
M14X95/S=22*	25	55000.140.095	M20X85	25	55000.200.085	M24X400*	5	55000.240.400
M14X100/S=22	10	55000.140.100	M20X90	25	55000.200.090	M24X440*	5	55000.240.440
M14X110/S=22	10	55000.140.110	M20X95*	25	55000.200.095	M24X480*	5	55000.240.480
M14X120/S=22	10	55000.140.120	M20X100	25	55000.200.100	M24X500*	5	55000.240.500
M14X130/S=22*	25	55000.140.130	M20X110	25	55000.200.110			
M14X140/S=22	10	55000.140.140	M20X120	10	55000.200.120			

55000 Śruby z łbem sześciokątnym								
d x L	☒	Kod artykułu	d x L	☒	Kod artykułu	d x L	☒	Kod artykułu
M27X70*	10	55000.270.070	M30X170*	5	55000.300.170	M36X130	1	55000.360.130
M27X75*	10	55000.270.075	M30X180	1	55000.300.180	M36X140	1	55000.360.140
M27X80	3	55000.270.080	M30X190*	5	55000.300.190	M36X150	1	55000.360.150
M27X85*	10	55000.270.085	M30X200	1	55000.300.200	M36X160	1	55000.360.160
M27X90	3	55000.270.090	M30X210	1	55000.300.210	M36X170	1	55000.360.170
M27X95*	10	55000.270.095	M30X220	1	55000.300.220	M36X180	1	55000.360.180
M27X100	3	55000.270.100	M30X230*	5	55000.300.230	M36X190	1	55000.360.190
M27X110	3	55000.270.110	M30X240	1	55000.300.240	M36X200	1	55000.360.200
M27X120	3	55000.270.120	M30X250	1	55000.300.250	M36X210*	5	55000.360.210
M27X130	3	55000.270.130	M30X260*	5	55000.300.260	M36X220	1	55000.360.220
M27X140	3	55000.270.140	M30X270*	5	55000.300.270	M36X230*	5	55000.360.230
M27X150	3	55000.270.150	M30X280*	5	55000.300.280	M36X240	1	55000.360.240
M27X160	3	55000.270.160	M30X290*	5	55000.300.290	M36X250*	5	55000.360.250
M27X170*	5	55000.270.170	M30X300*	5	55000.300.300	M36X260*	5	55000.360.260
M27X180	3	55000.270.180				M36X300*	5	55000.360.300
M27X190*	5	55000.270.190	M33X90	1	55000.330.090			
M27X200	3	55000.270.200	M33X100	1	55000.330.100	M39X120*	10	55000.390.120
M27X210*	5	55000.270.210	M33X110	1	55000.330.110	M39X130*	10	55000.390.130
M27X220	3	55000.270.220	M33X120	1	55000.330.120	M39X140*	10	55000.390.140
M27X230*	5	55000.270.230	M33X130	1	55000.330.130	M39X150*	5	55000.390.150
M27X240	3	55000.270.240	M33X140	1	55000.330.140	M39X160*	5	55000.390.160
M27X250*	5	55000.270.250	M33X150	1	55000.330.150	M39X170*	5	55000.390.170
M27X260*	5	55000.270.260	M33X160	1	55000.330.160	M39X180*	5	55000.390.180
M27X270*	5	55000.270.270	M33X170	1	55000.330.170	M39X200*	5	55000.390.200
M27X280*	5	55000.270.280	M33X180	1	55000.330.180			
M27X290*	5	55000.270.290	M33X190	1	55000.330.190	M42X120*	5	55000.420.120
M27X300*	5	55000.270.300	M33X200	1	55000.330.200	M42X130*	5	55000.420.130
			M33X210*	5	55000.330.210	M42X140*	5	55000.420.140
M30X80*	10	55000.300.080	M33X220	1	55000.330.220	M42X150*	5	55000.420.150
M30X85*	10	55000.300.085	M33X230*	5	55000.330.230	M42X160*	5	55000.420.160
M30X90	1	55000.300.090	M33X240	1	55000.330.240	M42X190*	5	55000.420.190
M30X95*	10	55000.300.095	M33X250*	5	55000.330.250	M42X200*	5	55000.420.200
M30X100	1	55000.300.100	M33X260	1	55000.330.260			
M30X110	1	55000.300.110	M33X290*	5	55000.330.290	M45X140*	5	55000.450.140
M30X120	1	55000.300.120	M33X300*	5	55000.330.300	M45X180*	5	55000.450.180
M30X130	1	55000.300.130						
M30X140	1	55000.300.140	M36X100	1	55000.360.100	M48X150*	5	55000.480.150
M30X150	1	55000.300.150	M36X110	1	55000.360.110	M48X180*	5	55000.480.180
M30X160	1	55000.300.160	M36X120	1	55000.360.120	M48X200*	5	55000.480.200

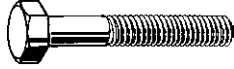
* Rozmiary o średnicy > M24 i rozmiary o długości > 8xd mają minimalną klasę właściwości 5.0.

53510 Śruby z łbem sześciokątnym								R11A
Gwint	Metryczny							
Materiał	Stal nierdzewna A4							
Klasa	80							
								
d x L	☒	Kod artykułu	d x L	☒	Kod artykułu	d x L	☒	Kod artykułu
M5X25	200	53510.050.025	M6X95*	100	53510.060.095	M8X120*	50	53510.080.120
M5X30*	200	53510.050.030	M6X100	100	53510.060.100	M8X130*	50	53510.080.130
M5X35*	200	53510.050.035	M6X110*	100	53510.060.110	M8X140*	50	53510.080.140
M5X40*	200	53510.050.040	M6X120*	100	53510.060.120	M8X150*	50	53510.080.150
M5X45*	200	53510.050.045	M6X130*	100	53510.060.130	M8X160*	25	53510.080.160
M5X50*	200	53510.050.050	M6X140*	100	53510.060.140	M8X170*	25	53510.080.170
M5X55*	200	53510.050.055	M6X150*	100	53510.060.150	M8X180*	25	53510.080.180
M5X60*	200	53510.050.060	M6X160*	100	53510.060.160	M8X190*	25	53510.080.190
M5X65*	200	53510.050.065	M6X170*	100	53510.060.170	M8X200*	25	53510.080.200
M5X70*	100	53510.050.070	M6X180*	100	53510.060.180	M8X220*	25	53510.080.220
M5X75*	100	53510.050.075	M6X190*	100	53510.060.190			
M5X80*	100	53510.050.080	M6X200*	100	53510.060.200	M10X35/S=17*	100	53510.100.035
M5X90*	100	53510.050.090				M10X40/S=17	50	53510.100.040
M5X100*	100	53510.050.100	M8X30*	100	53510.080.030	M10X45/S=17	50	53510.100.045
			M8X35*	100	53510.080.035	M10X50/S=17	50	53510.100.050
M6X25*	200	53510.060.025	M8X40	50	53510.080.040	M10X55/S=17*	50	53510.100.055
M6X30	100	53510.060.030	M8X45	50	53510.080.045	M10X60/S=17	50	53510.100.060
M6X35	100	53510.060.035	M8X50	50	53510.080.050	M10X65/S=17*	50	53510.100.065
M6X40	100	53510.060.040	M8X55*	100	53510.080.055	M10X70/S=17	50	53510.100.070
M6X45*	100	53510.060.045	M8X60	50	53510.080.060	M10X75/S=17*	50	53510.100.075
M6X50	100	53510.060.050	M8X65*	100	53510.080.065	M10X80/S=17	50	53510.100.080
M6X55*	100	53510.060.055	M8X70	50	53510.080.070	M10X85/S=17*	50	53510.100.085
M6X60	100	53510.060.060	M8X75*	50	53510.080.075	M10X90/S=17	50	53510.100.090
M6X65	100	53510.060.065	M8X80	50	53510.080.080	M10X95/S=17*	50	53510.100.095
M6X70	100	53510.060.070	M8X85*	50	53510.080.085	M10X100/S=17	50	53510.100.100
M6X75*	100	53510.060.075	M8X90*	50	53510.080.090	M10X110/S=17*	50	53510.100.110
M6X80	100	53510.060.080	M8X95*	50	53510.080.095	M10X120/S=17*	50	53510.100.120
M6X85*	100	53510.060.085	M8X100	50	53510.080.100	M10X130/S=17*	50	53510.100.130
M6X90*	100	53510.060.090	M8X110*	50	53510.080.110	M10X140/S=17*	50	53510.100.140

53510 Śruby z łbem sześciokątnym								
d x L	☒	Kod artykułu	d x L	☒	Kod artykułu	d x L	☒	Kod artykułu
M10X150/S=17*	50	53510.100.150	M14X80/S=22*	25	53510.140.080	M20X95*	25	53510.200.095
M10X160/S=17*	25	53510.100.160	M14X90/S=22*	25	53510.140.090	M20X100	10	53510.200.100
M10X170/S=17*	25	53510.100.170	M14X95/S=22*	25	53510.140.095	M20X110*	25	53510.200.110
M10X180/S=17*	25	53510.100.180	M14X100/S=22*	25	53510.140.100	M20X120	10	53510.200.120
M10X190/S=17*	25	53510.100.190	M14X110/S=22*	25	53510.140.110	M20X130*	25	53510.200.130
M10X200/S=17*	25	53510.100.200	M14X120/S=22*	25	53510.140.120	M20X140*	25	53510.200.140
M10X210/S=17*	10	53510.100.210	M14X130/S=22*	25	53510.140.130	M20X150	10	53510.200.150
M10X220/S=17*	10	53510.100.220	M14X140/S=22*	25	53510.140.140	M20X160*	10	53510.200.160
M10X230/S=17*	10	53510.100.230	M14X160/S=22*	10	53510.140.160	M20X170*	10	53510.200.170
M10X240/S=17*	10	53510.100.240	M14X180/S=22*	10	53510.140.180	M20X180*	10	53510.200.180
M10X250/S=17*	10	53510.100.250				M20X190*	10	53510.200.190
			M16X50	25	53510.160.050	M20X200*	10	53510.200.200
M12X40/S=19	50	53510.120.040	M16X55	25	53510.160.055	M20X210*	10	53510.200.210
M12X45/S=19	25	53510.120.045	M16X60	25	53510.160.060	M20X220*	10	53510.200.220
M12X50/S=19	25	53510.120.050	M16X65	25	53510.160.065	M20X230*	10	53510.200.230
M12X55/S=19	25	53510.120.055	M16X70	25	53510.160.070	M20X240*	10	53510.200.240
M12X60/S=19	25	53510.120.060	M16X75	25	53510.160.075	M20X250*	10	53510.200.250
M12X65/S=19	25	53510.120.065	M16X80	25	53510.160.080			
M12X70/S=19	25	53510.120.070	M16X85*	25	53510.160.085	M24X70*	10	53510.240.070
M12X75/S=19	25	53510.120.075	M16X90	25	53510.160.090	M24X75*	10	53510.240.075
M12X80/S=19	25	53510.120.080	M16X95*	25	53510.160.095	M24X80	10	53510.240.080
M12X85/S=19*	25	53510.120.085	M16X100	25	53510.160.100	M24X85*	10	53510.240.085
M12X90/S=19	25	53510.120.090	M16X110	25	53510.160.110	M24X90	10	53510.240.090
M12X95/S=19*	25	53510.120.095	M16X120	25	53510.160.120	M24X95*	10	53510.240.095
M12X100/S=19	25	53510.120.100	M16X130*	25	53510.160.130	M24X100	10	53510.240.100
M12X110/S=19*	25	53510.120.110	M16X140	25	53510.160.140	M24X110*	10	53510.240.110
M12X120/S=19	25	53510.120.120	M16X150	25	53510.160.150	M24X120	10	53510.240.120
M12X130/S=19*	25	53510.120.130	M16X160*	10	53510.160.160	M24X130*	10	53510.240.130
M12X140/S=19*	25	53510.120.140	M16X170*	10	53510.160.170	M24X140*	10	53510.240.140
M12X150/S=19*	25	53510.120.150	M16X180*	10	53510.160.180	M24X150	10	53510.240.150
M12X160/S=19*	10	53510.120.160	M16X190*	10	53510.160.190	M24X160*	10	53510.240.160
M12X170/S=19*	10	53510.120.170	M16X200*	10	53510.160.200	M24X170*	10	53510.240.170
M12X180/S=19*	10	53510.120.180	M16X210*	10	53510.160.210	M24X180*	10	53510.240.180
M12X190/S=19*	10	53510.120.190	M16X220*	10	53510.160.220	M24X190*	10	53510.240.190
M12X200/S=19*	10	53510.120.200	M16X230*	10	53510.160.230	M24X200*	10	53510.240.200
M12X210/S=19*	10	53510.120.210	M16X240*	10	53510.160.240	M24X220*	5	53510.240.220
M12X220/S=19*	10	53510.120.220	M16X250*	10	53510.160.250	M24X230*	5	53510.240.230
M12X230/S=19*	10	53510.120.230	M16X260*	10	53510.160.260	M24X240*	5	53510.240.240
M12X240/S=19*	10	53510.120.240				M24X250*	5	53510.240.250
M12X250/S=19*	10	53510.120.250	M20X55*	25	53510.200.055	M24X260*	5	53510.240.260
			M20X60*	25	53510.200.060	M24X280*	5	53510.240.280
M14X50/S=22*	50	53510.140.050	M20X65*	25	53510.200.065	M24X300*	5	53510.240.300
M14X55/S=22*	50	53510.140.055	M20X70	10	53510.200.070			
M14X60/S=22*	50	53510.140.060	M20X75*	25	53510.200.075	M27X130*	10	53510.270.130
M14X65/S=22*	50	53510.140.065	M20X80	10	53510.200.080			
M14X70/S=22*	50	53510.140.070	M20X85*	25	53510.200.085			
M14X75/S=22*	25	53510.140.075	M20X90	10	53510.200.090			

23010 Śruby z łbem sześciokątnym				G90A			
Gwint	Metryczny						
Material	Stal 25CrMo4+QT						
Klasa	KG						
							
							

d x L	☒	Kod artykułu	d x L	☒	Kod artykułu	d x L	☒	Kod artykułu
M20X100	10	23010.200.100	M24X120	10	23010.240.120	M30X150	5	23010.300.150
M20X120	10	23010.200.120	M24X140	10	23010.240.140			

- Specjalne cechy śrub z łbem sześciokątnym:
- Wykonane ze stali 24CrMo5 numer materiału: 1.7218.
 - Przeznaczony do stosowania w wysokich temperaturach, do 400°C.
 - Długości gwintu nie są zgodne z ISO 4014.
 - Właściwości mechaniczne zgodne z EN 10269.
 - Łeb śruby jest oznaczony znakiem KG, zgodn. z DIN 267-13.

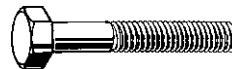
56090 Śruby z łbem sześciokątnym plastikowe				W02A			
Gwint	Metryczny						
Material	Plastik Poliamid (nylon)			DIN	≈931		
Klasa	PA 6.6			ISO	≈4014		
Kolor	Biały			NEN	≈1555		
				ASME	≈B18.2.3.1M		
				NF	≈E25-112		
							

d x L/b	☒	Kod artykułu	d x L/b	☒	Kod artykułu	d x L/b	☒	Kod artykułu
M8X70	50	56090.080.070	M12X40/30	25	56090.120.040	M12X60/50	25	56090.120.060
M10X60/50	25	56090.100.060	M12X50/50	25	56090.120.050	M12X80/30	25	56090.120.080

Śruby z łbem sześciokątnym z nakrętką sześciokątną

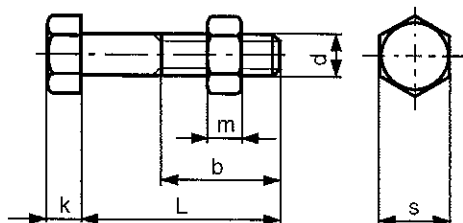

DIN 601/555 (1987)
ISO 4016/-
NEN 102/697
NF E25-115-1/E25-402

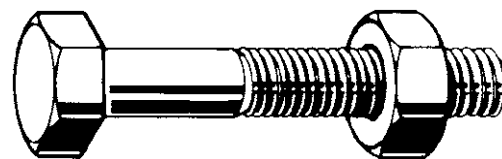

Informacje techniczne

d	b (min.): L≤125mm	b (min.): 125mm<L≤200mm	b (min.): L>200mm	k	m	P	s
M6	18	24	37	4	5	1	10
M8	22	28	41	5.3	6.5	1.25	13
M10	26	32	45	6.4	8	1.5	17
M12	30	36	49	7.5	10	1.75	19
M14	34	40	53	8.8	11	2	22
M16	38	44	57	10	13	2	24
M20	46	52	65	12.5	16	2.5	30
M24	54	60	73	15	19	3	36

- Odpowiadające nakrętki sześciokątne mają klasę właściwości ≥ I4I.

08200 Śruby z łbem sześciokątnym z nakrętką sześciokątną

E03A

Gwint Metryczny
Materiał Stal
Klasa ≥4.6
Obróbka powierzchni Ocynkowane



d x L	☒	Kod artykułu	d x L	☒	Kod artykułu	d x L	☒	Kod artykułu
M6X16	500	08200.060.016	M10X100	100	08200.100.100	M16X110	25	08200.160.110
M6X20	500	08200.060.020	M10X110	50	08200.100.110	M16X120	25	08200.160.120
M6X25	500	08200.060.025	M10X120	50	08200.100.120	M16X130	25	08200.160.130
M6X30	500	08200.060.030	M10X140	50	08200.100.140	M16X140	25	08200.160.140
M6X40	200	08200.060.040				M16X160	25	08200.160.160
M6X50	200	08200.060.050	M12X25	100	08200.120.025	M16X180	25	08200.160.180
M6X60	200	08200.060.060	M12X30	100	08200.120.030	M16X200	25	08200.160.200
M6X70	200	08200.060.070	M12X35	100	08200.120.035			
M6X80	200	08200.060.080	M12X40	100	08200.120.040	M20X40	25	08200.200.040
M6X100	100	08200.060.100	M12X45	100	08200.120.045	M20X50	25	08200.200.050
			M12X50	100	08200.120.050	M20X60	25	08200.200.060
M8X16	200	08200.080.016	M12X55	100	08200.120.055	M20X65	25	08200.200.065
M8X20	200	08200.080.020	M12X60	100	08200.120.060	M20X70	25	08200.200.070
M8X25	200	08200.080.025	M12X70	50	08200.120.070	M20X75	25	08200.200.075
M8X30	200	08200.080.030	M12X80	50	08200.120.080	M20X80	25	08200.200.080
M8X40	200	08200.080.040	M12X100	50	08200.120.100	M20X90	25	08200.200.090
M8X45	200	08200.080.045	M12X110	50	08200.120.110	M20X100	25	08200.200.100
M8X50	200	08200.080.050	M12X130	50	08200.120.130	M20X110	25	08200.200.110
M8X55	200	08200.080.055	M12X150	50	08200.120.150	M20X120	25	08200.200.120
M8X60	200	08200.080.060	M12X180	25	08200.120.180	M20X130	25	08200.200.130
M8X70	200	08200.080.070	M12X260	25	08200.120.260	M20X140	25	08200.200.140
M8X80	200	08200.080.080				M20X150	10	08200.200.150
M8X90	100	08200.080.090	M16X35	50	08200.160.035	M20X160	10	08200.200.160
M8X100	100	08200.080.100	M16X40	50	08200.160.040	M20X180	10	08200.200.180
			M16X45	50	08200.160.045	M20X200	10	08200.200.200
M10X25	200	08200.100.025	M16X50	50	08200.160.050	M20X220	10	08200.200.220
M10X30	200	08200.100.030	M16X55	50	08200.160.055	M20X240	10	08200.200.240
M10X35	100	08200.100.035	M16X60	50	08200.160.060			
M10X40	100	08200.100.040	M16X65	25	08200.160.065	M24X70	25	08200.240.070
M10X45	100	08200.100.045	M16X70	25	08200.160.070	M24X80	25	08200.240.080
M10X50	100	08200.100.050	M16X80	25	08200.160.080	M24X90	10	08200.240.090
M10X70	100	08200.100.070	M16X90	25	08200.160.090	M24X100	10	08200.240.100
M10X90	100	08200.100.090	M16X100	25	08200.160.100	M24X110	10	08200.240.110

Śruby z łbem sześciokątnym

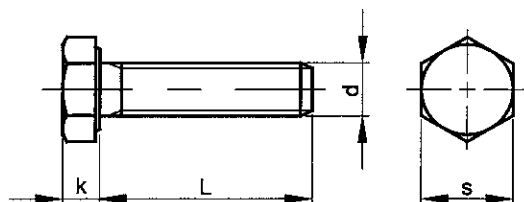

ISO 4017
 DIN 933
 NEN 1568
 ASME B18.2.3.1M
 NF E25-114

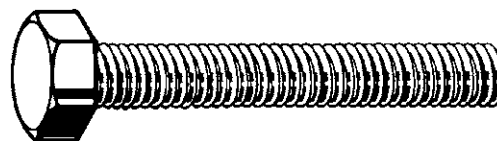

Informacje techniczne

d	k	P	s
M2	1.4	0.4	4
M2.5	1.7	0.45	5
M3	2	0.5	5.5
M4	2.8	0.7	7
M5	3.5	0.8	8
M6	4	1	10
M7	4.8	1	11
M8	5.3	1.25	13
M10 (DIN)	6.4	1.5	17
M10	6.4	1.5	16
M12 (DIN)	7.5	1.75	19
M12	7.5	1.75	18
M14 (DIN)	8.8	2	22
M14	8.8	2	21
M16	10	2	24
M18	11.5	2.5	27
M20	12.5	2.5	30
M22 (DIN)	14	2.5	32
M22	14	2.5	34
M24	15	3	36
M27	17	3	41
M30	18.7	3.5	46
M33	21	3.5	50
M36	22.5	4	55
M39	25	4	60
M42	26	4.5	65
M45	28	4.5	70
M48	30	5	75
M52	33	5	80
M64	40	6	95

Grupy katalogowe

Gwint	Gniazdo	Materiał	Klasa	Obróbka powierzchni	Kolor	Kod	Strona
M	Sześciokąt	St	8.8			01010	1-20
M	Sześciokąt	St	8.8	Ocynk.		01210	1-21
M	Sześciokąt	St	8.8	Ocynk. żłt. pas.		01230	1-22
M	Sześciokąt	St	8.8	FLZNNC-NC6		01236	1-24
M	Sześciokąt	St	8.8	Ocynk. gor.	izometryczna	01410	1-24
M	Sześciokąt	St	8.8	Ocynk. gor.	nadwymiarowy	01430	1-25
M	Sześciokąt	St	10.9			04110	1-26
M	Sześciokąt	St	10.9	FLZNNC-NC6		04116	1-26
M	Sześciokąt	St	12.9			04118	1-27
M	Sześciokąt	St	5.6		do zbiorników ciśnieniowych	08760	1-27
M	Sześciokąt	St.St. A2	70			51010	1-27
M	Sześciokąt	St.St. A4	70			55010	1-29
M	Sześciokąt	St.St. A4	80			53520	1-31
M	Sześciokąt	St.St. A5	70			53521	1-32
M	Sześciokąt	Al P40				45010	1-33
M	Sześciokąt	Al P60				45210	1-33
M	Sześciokąt	Kuprodur Cu5	60			45810	1-33
M	Sześciokąt	Mosiądz Cu2/Cu3				46010	1-33
M	Sześciokąt	Mosiądz Cu2/Cu3		Nikl.		46060	1-34
M	Sześciokąt	Ti ASTM	Gr.2			45910	1-34
M	Sześciokąt	Plastik PA	PA 6.6		Biały	56100	1-34

01010		Śruby z łbem sześciokątnym		A01A	
Gwint	Metryczny				
Materiał	Stal				
Klasa	8.8				

d x L	☒	Kod artykułu	d x L	☒	Kod artykułu	d x L	☒	Kod artykułu
M4X8	500	01010.040.008	M8X120	100	01010.080.120	M16X50	50	01010.160.050
M4X10	500	01010.040.010				M16X55	50	01010.160.055
M4X12	500	01010.040.012	M10X12/S=17	200	01010.100.012	M16X60	50	01010.160.060
M4X16	500	01010.040.016	M10X16/S=17	200	01010.100.016	M16X65	25	01010.160.065
M4X20	500	01010.040.020	M10X20/S=17	200	01010.100.020	M16X70	25	01010.160.070
M4X25	500	01010.040.025	M10X22/S=17	200	01010.100.022	M16X75	25	01010.160.075
M4X30	500	01010.040.030	M10X25/S=17	200	01010.100.025	M16X80	25	01010.160.080
M4X35	500	01010.040.035	M10X28/S=17	200	01010.100.028	M16X90	25	01010.160.090
M4X40	500	01010.040.040	M10X30/S=17	200	01010.100.030	M16X100	25	01010.160.100
M4X50	500	01010.040.050	M10X35/S=17	100	01010.100.035	M16X110	25	01010.160.110
			M10X40/S=17	100	01010.100.040	M16X120	25	01010.160.120
M5X8	200	01010.050.008	M10X45/S=17	100	01010.100.045	M16X130	25	01010.160.130
M5X10	200	01010.050.010	M10X50/S=17	100	01010.100.050	M16X140	25	01010.160.140
M5X12	200	01010.050.012	M10X55/S=17	100	01010.100.055	M16X150	25	01010.160.150
M5X16	200	01010.050.016	M10X60/S=17	100	01010.100.060	M16X160	25	01010.160.160
M5X18	200	01010.050.018	M10X65/S=17	100	01010.100.065	M16X180	25	01010.160.180
M5X20	200	01010.050.020	M10X70/S=17	100	01010.100.070	M16X200	25	01010.160.200
M5X25	200	01010.050.025	M10X75/S=17	100	01010.100.075			
M5X30	200	01010.050.030	M10X80/S=17	100	01010.100.080	M18X30	50	01010.180.030
M5X35	200	01010.050.035	M10X90/S=17	100	01010.100.090	M18X35	50	01010.180.035
M5X40	200	01010.050.040	M10X100/S=17	100	01010.100.100	M18X40	50	01010.180.040
M5X50	200	01010.050.050	M10X110/S=17	50	01010.100.110	M18X45	50	01010.180.045
M5X60	200	01010.050.060	M10X120/S=17	50	01010.100.120	M18X50	50	01010.180.050
			M10X130/S=17	50	01010.100.130	M18X55	25	01010.180.055
			M10X140/S=17	50	01010.100.140	M18X60	25	01010.180.060
			M10X150/S=17	50	01010.100.150	M18X70	25	01010.180.070
						M18X80	25	01010.180.080
M6X8	200	01010.060.008	M12X16/S=19	100	01010.120.016	M18X90	25	01010.180.090
M6X10	200	01010.060.010	M12X20/S=19	100	01010.120.020	M18X100	25	01010.180.100
M6X12	200	01010.060.012	M12X25/S=19	100	01010.120.025	M18X110	25	01010.180.110
M6X14	200	01010.060.014	M12X28/S=19	100	01010.120.028	M18X120	25	01010.180.120
M6X16	200	01010.060.016	M12X30/S=19	100	01010.120.030			
M6X18	200	01010.060.018	M12X35/S=19	100	01010.120.035	M20X30	25	01010.200.030
M6X20	200	01010.060.020	M12X40/S=19	100	01010.120.040	M20X35	25	01010.200.035
M6X22	200	01010.060.022	M12X45/S=19	100	01010.120.045	M20X40	25	01010.200.040
M6X25	200	01010.060.025	M12X50/S=19	100	01010.120.050	M20X45	25	01010.200.045
M6X30	200	01010.060.030	M12X55/S=19	100	01010.120.055	M20X50	25	01010.200.050
M6X35	200	01010.060.035	M12X65/S=19	50	01010.120.065	M20X55	25	01010.200.055
M6X40	200	01010.060.040	M12X70/S=19	50	01010.120.070	M20X60	25	01010.200.060
M6X45	200	01010.060.045	M12X75/S=19	50	01010.120.075	M20X65	25	01010.200.065
M6X50	200	01010.060.050	M12X80/S=19	50	01010.120.080	M20X70	25	01010.200.070
M6X55	200	01010.060.055	M12X90/S=19	50	01010.120.090	M20X75	25	01010.200.075
M6X60	200	01010.060.060	M12X100/S=19	50	01010.120.100	M20X80	25	01010.200.080
M6X70	200	01010.060.070	M12X110/S=19	50	01010.120.110	M20X90	25	01010.200.090
M6X80	200	01010.060.080	M12X120/S=19	50	01010.120.120	M20X100	25	01010.200.100
			M12X130/S=19	50	01010.120.130	M20X110	25	01010.200.110
M7X12	200	01010.070.012	M12X140/S=19	50	01010.120.140	M20X120	25	01010.200.120
M7X16	200	01010.070.016	M12X150/S=19	50	01010.120.150	M20X130	25	01010.200.130
M7X20	200	01010.070.020	M12X160/S=19	50	01010.120.160	M20X140	25	01010.200.140
M7X25	200	01010.070.025	M12X180/S=19	50	01010.120.180	M20X150	10	01010.200.150
M7X30	200	01010.070.030				M20X160	10	01010.200.160
M7X35	200	01010.070.035	M14X20/S=22	100	01010.140.020	M20X180	10	01010.200.180
M7X40	200	01010.070.040	M14X25/S=22	100	01010.140.025	M20X200	10	01010.200.200
M7X45	200	01010.070.045	M14X30/S=22	100	01010.140.030			
M7X50	200	01010.070.050	M14X35/S=22	100	01010.140.035	M22X40/S=32	25	01010.220.040
			M14X40/S=22	100	01010.140.040	M22X50/S=32	25	01010.220.050
M8X10	200	01010.080.010	M14X45/S=22	50	01010.140.045	M22X55/S=32	25	01010.220.055
M8X12	200	01010.080.012	M14X50/S=22	50	01010.140.050	M22X60/S=32	25	01010.220.060
M8X14	200	01010.080.014	M14X55/S=22	50	01010.140.055	M22X65/S=32	25	01010.220.065
M8X16	200	01010.080.016	M14X60/S=22	50	01010.140.060	M22X70/S=32	25	01010.220.070
M8X18	200	01010.080.018	M14X65/S=22	50	01010.140.065	M22X80/S=32	25	01010.220.080
M8X20	200	01010.080.020	M14X70/S=22	50	01010.140.070	M22X90/S=32	25	01010.220.090
M8X22	200	01010.080.022	M14X75/S=22	50	01010.140.075	M22X100/S=32	10	01010.220.100
M8X25	200	01010.080.025	M14X80/S=22	50	01010.140.080	M22X120/S=32	25	01010.220.120
M8X30	200	01010.080.030	M14X90/S=22	50	01010.140.090	M22X150/S=32	10	01010.220.150
M8X35	200	01010.080.035	M14X100/S=22	50	01010.140.100			
M8X40	200	01010.080.040	M14X120/S=22	50	01010.140.120	M24X40	25	01010.240.040
M8X45	200	01010.080.045				M24X45	25	01010.240.045
M8X50	200	01010.080.050	M16X20	50	01010.160.020	M24X50	25	01010.240.050
M8X55	200	01010.080.055	M16X25	50	01010.160.025	M24X55	25	01010.240.055
M8X60	200	01010.080.060	M16X30	50	01010.160.030	M24X60	25	01010.240.060
M8X65	200	01010.080.065	M16X35	50	01010.160.035	M24X65	25	01010.240.065
M8X70	200	01010.080.070	M16X40	50	01010.160.040	M24X70	25	01010.240.070
M8X75	200	01010.080.075	M16X45	50	01010.160.045	M24X75	25	01010.240.075
M8X80	200	01010.080.080				M24X80	25	01010.240.080
M8X90	100	01010.080.090						
M8X100	100	01010.080.100						
M8X110	100	01010.080.110						

01010 Śruby z łbem sześciokątnym								
d x L	☒	Kod artykułu	d x L	☒	Kod artykułu	d x L	☒	Kod artykułu
M24X90	10	01010.240.090	M30X80	10	01010.300.080	M36X140	5	01010.360.140
M24X100	10	01010.240.100	M30X90	10	01010.300.090	M36X160	5	01010.360.160
M24X110	10	01010.240.110	M30X100	10	01010.300.100	M36X180	5	01010.360.180
M24X120	10	01010.240.120	M30X110	10	01010.300.110			
M24X130	10	01010.240.130	M30X120	10	01010.300.120	M39X80	1	01010.390.080
M24X140	10	01010.240.140	M30X130	10	01010.300.130	M39X90	1	01010.390.090
M24X150	10	01010.240.150	M30X140	5	01010.300.140	M39X100	1	01010.390.100
M24X160	10	01010.240.160	M30X160	5	01010.300.160	M39X150	1	01010.390.150
M24X200	10	01010.240.200	M30X180	5	01010.300.180			
			M30X200	5	01010.300.200	M42X80	1	01010.420.080
M27X50	10	01010.270.050				M42X90	1	01010.420.090
M27X60	10	01010.270.060	M33X60	5	01010.330.060	M42X100	1	01010.420.100
M27X70	10	01010.270.070	M33X70	5	01010.330.070	M42X120	1	01010.420.120
M27X75	10	01010.270.075	M33X80	5	01010.330.080			
M27X80	10	01010.270.080	M33X90	5	01010.330.090	M45X90	1	01010.450.090
M27X90	10	01010.270.090	M33X100	5	01010.330.100	M45X100	1	01010.450.100
M27X100	10	01010.270.100	M33X140	5	01010.330.140			
M27X110	10	01010.270.110				M48X100	1	01010.480.100
M27X120	10	01010.270.120	M36X50	5	01010.360.050	M48X110	1	01010.480.110
			M36X60	5	01010.360.060	M48X120	1	01010.480.120
M30X40	10	01010.300.040	M36X70	5	01010.360.070	M48X180	5	01010.480.180
M30X50	10	01010.300.050	M36X80	5	01010.360.080			
M30X60	10	01010.300.060	M36X90	5	01010.360.090	M52X100	1	01010.520.100
M30X65	10	01010.300.065	M36X100	5	01010.360.100	M52X120	1	01010.520.120
M30X70	10	01010.300.070	M36X110	5	01010.360.110			
M30X75	10	01010.300.075	M36X130	5	01010.360.130	M64X160	1	01010.640.160

01210 Śruby z łbem sześciokątnym								A05A
Gwint	Metryczny							
Materiał	Stal							
Klasa	8.8							
Obróbka powierzchni	O cynkowane							

d x L	☒	Kod artykułu	d x L	☒	Kod artykułu	d x L	☒	Kod artykułu
M3X6	500	01210.030.006	M6X12	200	01210.060.012	M8X35	200	01210.080.035
M3X8	500	01210.030.008	M6X14	200	01210.060.014	M8X40	200	01210.080.040
M3X10	500	01210.030.010	M6X16	200	01210.060.016	M8X45	200	01210.080.045
M3X12	500	01210.030.012	M6X18	200	01210.060.018	M8X50	200	01210.080.050
M3X16	500	01210.030.016	M6X20	200	01210.060.020	M8X55	200	01210.080.055
M3X20	500	01210.030.020	M6X22	200	01210.060.022	M8X60	200	01210.080.060
M3X25	500	01210.030.025	M6X25	200	01210.060.025	M8X65	200	01210.080.065
M3X30	500	01210.030.030	M6X30	200	01210.060.030	M8X70	200	01210.080.070
M3X40	500	01210.030.040	M6X35	200	01210.060.035	M8X75	200	01210.080.075
			M6X40	200	01210.060.040	M8X80	200	01210.080.080
M4X6	500	01210.040.006	M6X45	200	01210.060.045	M8X90	100	01210.080.090
M4X8	500	01210.040.008	M6X50	200	01210.060.050	M8X100	100	01210.080.100
M4X10	500	01210.040.010	M6X55	200	01210.060.055	M8X110	100	01210.080.110
M4X12	500	01210.040.012	M6X60	200	01210.060.060	M8X120	100	01210.080.120
M4X16	500	01210.040.016	M6X65	200	01210.060.065	M8X130	100	01210.080.130
M4X20	500	01210.040.020	M6X70	200	01210.060.070	M8X140	100	01210.080.140
M4X25	500	01210.040.025	M6X75	200	01210.060.075	M8X150	50	01210.080.150
M4X30	500	01210.040.030	M6X80	200	01210.060.080			
M4X35	500	01210.040.035	M6X90	100	01210.060.090	M10X10/S=17	200	01210.100.010
M4X40	500	01210.040.040	M6X100	100	01210.060.100	M10X12/S=17	200	01210.100.012
M4X45	500	01210.040.045	M6X120	100	01210.060.120	M10X14/S=17	200	01210.100.014
M4X50	500	01210.040.050				M10X16/S=17	200	01210.100.016
M4X60	200	01210.040.060	M7X10	200	01210.070.010	M10X16/S=16	200	01210.100.017
			M7X12	200	01210.070.012	M10X20/S=17	200	01210.100.020
M5X6	200	01210.050.006	M7X16	200	01210.070.016	M10X20/S=16	200	01210.100.021
M5X8	200	01210.050.008	M7X20	200	01210.070.020	M10X22/S=17	200	01210.100.022
M5X10	200	01210.050.010	M7X25	200	01210.070.025	M10X25/S=17	200	01210.100.025
M5X12	200	01210.050.012	M7X30	200	01210.070.030	M10X25/S=16	200	01210.100.026
M5X16	200	01210.050.016	M7X35	200	01210.070.035	M10X30/S=17	200	01210.100.030
M5X18	200	01210.050.018	M7X40	200	01210.070.040	M10X30/S=16	200	01210.100.031
M5X20	200	01210.050.020	M7X45	200	01210.070.045	M10X35/S=17	100	01210.100.035
M5X22	200	01210.050.022	M7X50	200	01210.070.050	M10X35/S=16	100	01210.100.036
M5X25	200	01210.050.025	M7X60	200	01210.070.060	M10X40/S=17	100	01210.100.040
M5X30	200	01210.050.030	M7X70	200	01210.070.070	M10X40/S=16	100	01210.100.041
M5X35	200	01210.050.035				M10X45/S=17	100	01210.100.045
M5X40	200	01210.050.040	M8X10	200	01210.080.010	M10X45/S=16	100	01210.100.046
M5X45	200	01210.050.045	M8X12	200	01210.080.012	M10X50/S=17	100	01210.100.050
M5X50	200	01210.050.050	M8X14	200	01210.080.014	M10X50/S=16	100	01210.100.051
M5X55	200	01210.050.055	M8X16	200	01210.080.016	M10X55/S=17	100	01210.100.055
M5X60	200	01210.050.060	M8X18	200	01210.080.018	M10X60/S=17	100	01210.100.060
M5X70	200	01210.050.070	M8X20	200	01210.080.020	M10X60/S=16	100	01210.100.061
			M8X22	200	01210.080.022	M10X65/S=17	100	01210.100.065
M6X8	200	01210.060.008	M8X25	200	01210.080.025	M10X65/S=16	100	01210.100.066
M6X10	200	01210.060.010	M8X30	200	01210.080.030	M10X70/S=17	100	01210.100.070



01210 Śruby z łbem sześciokątnym								
d x L	☒	Kod artykułu	d x L	☒	Kod artykułu	d x L	☒	Kod artykułu
M10X75/S=17	100	01210.100.075	M14X90/S=22	50	01210.140.090	M22X70/S=32	25	01210.220.070
M10X80/S=17	100	01210.100.080	M14X100/S=22	50	01210.140.100	M22X80/S=32	25	01210.220.080
M10X90/S=17	100	01210.100.090	M14X110/S=22	50	01210.140.110	M22X90/S=32	25	01210.220.090
M10X100/S=17	100	01210.100.100	M14X120/S=22	50	01210.140.120	M22X100/S=32	10	01210.220.100
M10X110/S=17	50	01210.100.110						
M10X120/S=17	50	01210.100.120	M16X20	50	01210.160.020	M24X30	25	01210.240.030
M10X130/S=17	50	01210.100.130	M16X25	50	01210.160.025	M24X35	25	01210.240.035
M10X140/S=17	50	01210.100.140	M16X30	50	01210.160.030	M24X40	25	01210.240.040
M10X150/S=17	50	01210.100.150	M16X35	50	01210.160.035	M24X45	25	01210.240.045
M10X170/S=17	50	01210.100.170	M16X40	50	01210.160.040	M24X50	25	01210.240.050
			M16X45	50	01210.160.045	M24X55	25	01210.240.055
M12X12/S=19	100	01210.120.012	M16X50	50	01210.160.050	M24X60	25	01210.240.060
M12X16/S=19	100	01210.120.016	M16X55	50	01210.160.055	M24X65	25	01210.240.065
M12X20/S=19	100	01210.120.020	M16X60	50	01210.160.060	M24X70	25	01210.240.070
M12X20/S=18	100	01210.120.021	M16X65	25	01210.160.065	M24X75	25	01210.240.075
M12X22/S=19	100	01210.120.022	M16X70	25	01210.160.070	M24X80	25	01210.240.080
M12X25/S=19	100	01210.120.025	M16X75	25	01210.160.075	M24X90	10	01210.240.090
M12X25/S=18	100	01210.120.026	M16X80	25	01210.160.080	M24X100	10	01210.240.100
M12X30/S=19	100	01210.120.030	M16X90	25	01210.160.090	M24X110	10	01210.240.110
M12X30/S=18	100	01210.120.031	M16X100	25	01210.160.100	M24X120	10	01210.240.120
M12X35/S=19	100	01210.120.035	M16X110	25	01210.160.110	M24X130	10	01210.240.130
M12X35/S=18	100	01210.120.036	M16X120	25	01210.160.120	M24X140	10	01210.240.140
M12X40/S=19	100	01210.120.040	M16X130	25	01210.160.130	M24X150	10	01210.240.150
M12X40/S=18	100	01210.120.041	M16X140	25	01210.160.140	M24X160	10	01210.240.160
M12X45/S=19	100	01210.120.045	M16X150	25	01210.160.150	M24X180	10	01210.240.180
M12X45/S=18	100	01210.120.046	M16X160	25	01210.160.160	M24X200	10	01210.240.200
M12X50/S=19	100	01210.120.050	M16X180	25	01210.160.180			
M12X50/S=18	100	01210.120.051	M16X200	25	01210.160.200	M27X50	10	01210.270.050
M12X55/S=19	100	01210.120.055				M27X60	10	01210.270.060
M12X60/S=19	100	01210.120.060	M18X30	50	01210.180.030	M27X70	10	01210.270.070
M12X60/S=18	100	01210.120.061	M18X35	50	01210.180.035	M27X80	10	01210.270.080
M12X65/S=19	50	01210.120.065	M18X40	50	01210.180.040	M27X90	10	01210.270.090
M12X70/S=19	50	01210.120.070	M18X45	50	01210.180.045	M27X100	10	01210.270.100
M12X70/S=18	50	01210.120.071	M18X50	50	01210.180.050	M27X120	10	01210.270.120
M12X75/S=19	50	01210.120.075	M18X55	25	01210.180.055	M27X140	10	01210.270.140
M12X80/S=19	50	01210.120.080	M18X60	25	01210.180.060	M27X160	10	01210.270.160
M12X80/S=18	50	01210.120.081	M18X70	25	01210.180.070			
M12X85/S=19	50	01210.120.085	M18X80	25	01210.180.080	M30X40	10	01210.300.040
M12X90/S=19	50	01210.120.090	M18X90	25	01210.180.090	M30X50	10	01210.300.050
M12X100/S=19	50	01210.120.100	M18X100	25	01210.180.100	M30X60	10	01210.300.060
M12X110/S=19	50	01210.120.110				M30X65	10	01210.300.065
M12X120/S=19	50	01210.120.120	M20X30	25	01210.200.030	M30X70	10	01210.300.070
M12X130/S=19	50	01210.120.130	M20X35	25	01210.200.035	M30X75	10	01210.300.075
M12X140/S=19	50	01210.120.140	M20X40	25	01210.200.040	M30X80	10	01210.300.080
M12X150/S=19	50	01210.120.150	M20X45	25	01210.200.045	M30X90	10	01210.300.090
M12X160/S=19	25	01210.120.160	M20X50	25	01210.200.050	M30X100	10	01210.300.100
M12X180/S=19	25	01210.120.180	M20X55	25	01210.200.055	M30X110	10	01210.300.110
			M20X60	25	01210.200.060	M30X120	10	01210.300.120
M14X20/S=22	100	01210.140.020	M20X65	25	01210.200.065	M30X140	10	01210.300.140
M14X20/S=21	100	01210.140.021	M20X70	25	01210.200.070	M30X150	10	01210.300.150
M14X25/S=22	100	01210.140.025	M20X75	25	01210.200.075	M30X160	10	01210.300.160
M14X25/S=21	100	01210.140.026	M20X80	25	01210.200.080	M30X200	10	01210.300.200
M14X30/S=22	100	01210.140.030	M20X90	25	01210.200.090			
M14X35/S=22	100	01210.140.035	M20X100	25	01210.200.100	M33X60	5	01210.330.060
M14X35/S=21	100	01210.140.036	M20X110	25	01210.200.110	M33X70	5	01210.330.070
M14X40/S=22	100	01210.140.040	M20X120	25	01210.200.120	M33X80	5	01210.330.080
M14X40/S=21	100	01210.140.041	M20X130	25	01210.200.130	M33X90	5	01210.330.090
M14X45/S=22	50	01210.140.045	M20X140	25	01210.200.140	M33X100	5	01210.330.100
M14X45/S=21	50	01210.140.046	M20X150	10	01210.200.150			
M14X50/S=22	50	01210.140.050	M20X160	10	01210.200.160	M36X50	5	01210.360.050
M14X50/S=21	50	01210.140.051	M20X180	10	01210.200.180	M36X70	5	01210.360.070
M14X55/S=22	50	01210.140.055	M20X200	10	01210.200.200	M36X80	5	01210.360.080
M14X60/S=22	50	01210.140.060				M36X90	5	01210.360.090
M14X60/S=21	50	01210.140.061	M22X40/S=32	25	01210.220.040	M36X100	5	01210.360.100
M14X65/S=22	50	01210.140.065	M22X50/S=32	25	01210.220.050	M36X110	5	01210.360.110
M14X70/S=22	50	01210.140.070	M22X55/S=32	25	01210.220.055	M36X120	5	01210.360.120
M14X75/S=22	50	01210.140.075	M22X60/S=32	25	01210.220.060	M36X140	5	01210.360.140
M14X80/S=22	50	01210.140.080	M22X65/S=32	25	01210.220.065	M36X160	5	01210.360.160

01230 Śruby z łbem sześciokątnym								A06A
Gwint	Metryczny							
Materiał	Stal							
Klasa	8.8							
Obróbka powierzchni	O cynkowane, po żółtej pasywacji							

d x L	☒	Kod artykułu	d x L	☒	Kod artykułu	d x L	☒	Kod artykułu
M3X8	500	01230.030.008	M3X12	500	01230.030.012	M3X20	500	01230.030.020
M3X10	500	01230.030.010	M3X16	500	01230.030.016	M3X25	500	01230.030.025

01230 Śruby z łbem sześciokątnym								
d x L	☒	Kod artykułu	d x L	☒	Kod artykułu	d x L	☒	Kod artykułu
M3X30	500	01230.030.030	M8X100	100	01230.080.100	M16X70	25	01230.160.070
M4X6	500	01230.040.006	M8X110	100	01230.080.110	M16X80	25	01230.160.080
M4X8	500	01230.040.008	M8X120	100	01230.080.120	M16X90	25	01230.160.090
M4X10	500	01230.040.010	M10X12/S=17	200	01230.100.012	M16X100	25	01230.160.100
M4X12	500	01230.040.012	M10X16/S=17	200	01230.100.016	M16X110	25	01230.160.110
M4X16	500	01230.040.016	M10X20/S=17	200	01230.100.020	M16X120	25	01230.160.120
M4X20	500	01230.040.020	M10X25/S=17	200	01230.100.025	M16X130	25	01230.160.130
M4X25	500	01230.040.025	M10X30/S=17	200	01230.100.030	M16X140	25	01230.160.140
M4X30	500	01230.040.030	M10X35/S=17	100	01230.100.035	M16X150	25	01230.160.150
M4X35	200	01230.040.035	M10X40/S=17	100	01230.100.040	M16X160	25	01230.160.160
M4X40	200	01230.040.040	M10X45/S=17	100	01230.100.045	M16X180	25	01230.160.180
M4X50	200	01230.040.050	M10X50/S=17	100	01230.100.050	M16X200	25	01230.160.200
M4X60	200	01230.040.060	M10X55/S=17	100	01230.100.055	M18X40	50	01230.180.040
M5X8	500	01230.050.008	M10X60/S=17	100	01230.100.060	M18X45	50	01230.180.045
M5X10	500	01230.050.010	M10X65/S=17	100	01230.100.065	M18X50	50	01230.180.050
M5X12	500	01230.050.012	M10X70/S=17	100	01230.100.070	M20X30	25	01230.200.030
M5X16	500	01230.050.016	M10X75/S=17	100	01230.100.075	M20X35	25	01230.200.035
M5X20	500	01230.050.020	M10X80/S=17	100	01230.100.080	M20X40	25	01230.200.040
M5X22	500	01230.050.022	M10X90/S=17	100	01230.100.090	M20X45	25	01230.200.045
M5X25	500	01230.050.025	M10X100/S=17	100	01230.100.100	M20X50	25	01230.200.050
M5X30	500	01230.050.030	M10X110/S=17	50	01230.100.110	M20X55	25	01230.200.055
M5X35	200	01230.050.035	M10X120/S=17	50	01230.100.120	M20X60	25	01230.200.060
M5X40	200	01230.050.040	M10X130/S=17	50	01230.100.130	M20X65	25	01230.200.065
M5X45	200	01230.050.045	M10X140/S=17	50	01230.100.140	M20X70	25	01230.200.070
M5X50	200	01230.050.050	M10X150/S=17	50	01230.100.150	M20X80	25	01230.200.080
M5X60	200	01230.050.060	M12X16/S=19	100	01230.120.016	M20X90	25	01230.200.090
M6X8	500	01230.060.008	M12X20/S=19	100	01230.120.020	M20X100	25	01230.200.100
M6X10	500	01230.060.010	M12X25/S=19	100	01230.120.025	M20X110	25	01230.200.110
M6X12	500	01230.060.012	M12X30/S=19	100	01230.120.030	M20X120	25	01230.200.120
M6X14	500	01230.060.014	M12X35/S=19	100	01230.120.035	M20X140	25	01230.200.140
M6X16	500	01230.060.016	M12X40/S=19	100	01230.120.040	M20X150	25	01230.200.150
M6X20	500	01230.060.020	M12X45/S=19	100	01230.120.045	M20X160	10	01230.200.160
M6X25	500	01230.060.025	M12X50/S=19	100	01230.120.050	M20X180	10	01230.200.180
M6X30	500	01230.060.030	M12X55/S=19	100	01230.120.055	M20X200	10	01230.200.200
M6X35	200	01230.060.035	M12X60/S=19	100	01230.120.060	M24X40	25	01230.240.040
M6X40	200	01230.060.040	M12X65/S=19	100	01230.120.065	M24X45	25	01230.240.045
M6X45	200	01230.060.045	M12X70/S=19	50	01230.120.070	M24X50	25	01230.240.050
M6X50	200	01230.060.050	M12X75/S=19	50	01230.120.075	M24X55	25	01230.240.055
M6X60	200	01230.060.060	M12X80/S=19	50	01230.120.080	M24X60	25	01230.240.060
M6X70	200	01230.060.070	M12X90/S=19	50	01230.120.090	M24X65	25	01230.240.065
M6X80	200	01230.060.080	M12X100/S=19	50	01230.120.100	M24X70	25	01230.240.070
M6X100	200	01230.060.100	M12X110/S=19	50	01230.120.110	M24X75	25	01230.240.075
M7X10	200	01230.070.010	M12X120/S=19	50	01230.120.120	M24X80	25	01230.240.080
M7X12	200	01230.070.012	M12X130/S=19	50	01230.120.130	M24X90	25	01230.240.090
M7X16	200	01230.070.016	M12X140/S=19	50	01230.120.140	M24X100	10	01230.240.100
M7X20	200	01230.070.020	M12X150/S=19	50	01230.120.150	M24X120	10	01230.240.120
M7X25	200	01230.070.025	M14X20/S=22	100	01230.140.020	M24X130	10	01230.240.130
M7X30	200	01230.070.030	M14X25/S=22	100	01230.140.025	M24X140	10	01230.240.140
M7X35	200	01230.070.035	M14X30/S=22	100	01230.140.030	M24X150	10	01230.240.150
M7X40	200	01230.070.040	M14X35/S=22	100	01230.140.035	M24X160	10	01230.240.160
M7X45	200	01230.070.045	M14X40/S=22	100	01230.140.040	M24X180	10	01230.240.180
M7X50	200	01230.070.050	M14X45/S=22	50	01230.140.045	M24X200	10	01230.240.200
M8X10	200	01230.080.010	M14X50/S=22	50	01230.140.050	M27X50	10	01230.270.050
M8X12	200	01230.080.012	M14X60/S=22	50	01230.140.060	M27X60	10	01230.270.060
M8X16	200	01230.080.016	M14X70/S=22	50	01230.140.070	M27X70	10	01230.270.070
M8X20	200	01230.080.020	M14X75/S=22	50	01230.140.075	M27X80	10	01230.270.080
M8X25	200	01230.080.025	M14X80/S=22	50	01230.140.080	M27X90	10	01230.270.090
M8X30	200	01230.080.030	M14X90/S=22	50	01230.140.090	M27X100	10	01230.270.100
M8X35	200	01230.080.035	M14X100/S=22	50	01230.140.100	M27X120	10	01230.270.120
M8X40	200	01230.080.040	M16X20	50	01230.160.020	M30X60	10	01230.300.060
M8X45	200	01230.080.045	M16X25	50	01230.160.025	M33X80	5	01230.330.080
M8X50	200	01230.080.050	M16X30	50	01230.160.030	M33X90	5	01230.330.090
M8X55	200	01230.080.055	M16X35	50	01230.160.035	M33X100	5	01230.330.100
M8X60	200	01230.080.060	M16X40	50	01230.160.040	M36X80	5	01230.360.080
M8X70	200	01230.080.070	M16X45	50	01230.160.045	M36X90	5	01230.360.090
M8X75	200	01230.080.075	M16X50	50	01230.160.050	M36X100	5	01230.360.100
M8X80	200	01230.080.080	M16X55	50	01230.160.055			
M8X90	100	01230.080.090	M16X60	50	01230.160.060			
			M16X65	50	01230.160.065			



01236 Śruby z łbem sześciokątnym		A96A
Gwint	Metryczny	
Materiał	Stal	
Klasa	8.8	
Obróbka powierzchni	Ocynk plątkowy bez Cr6+ wg ISO 10683 (fiZnnc)	

d x L	☒	Kod artykułu	d x L	☒	Kod artykułu	d x L	☒	Kod artykułu
M4X10	500	01236.040.010	M8X40	200	01236.080.040	M14X65/S=22	50	01236.140.065
M4X12	500	01236.040.012	M8X45	200	01236.080.045	M14X70/S=22	50	01236.140.070
M4X16	500	01236.040.016	M8X50	200	01236.080.050			
M4X20	500	01236.040.020	M8X60	200	01236.080.060	M16X20	50	01236.160.020
M4X25	500	01236.040.025	M8X70	200	01236.080.070	M16X25	50	01236.160.025
M4X30	500	01236.040.030	M8X80	200	01236.080.080	M16X30	50	01236.160.030
						M16X35	50	01236.160.035
M5X10	500	01236.050.010	M10X16/S=17	200	01236.100.016	M16X40	50	01236.160.040
M5X12	500	01236.050.012	M10X20/S=17	200	01236.100.020	M16X45	50	01236.160.045
M5X16	500	01236.050.016	M10X25/S=17	200	01236.100.025	M16X50	50	01236.160.050
M5X20	500	01236.050.020	M10X30/S=17	200	01236.100.030	M16X60	50	01236.160.060
M5X25	500	01236.050.025	M10X35/S=17	100	01236.100.035	M16X65	25	01236.160.065
M5X30	500	01236.050.030	M10X40/S=17	100	01236.100.040	M16X70	25	01236.160.070
M5X35	200	01236.050.035	M10X45/S=17	100	01236.100.045	M16X80	25	01236.160.080
M5X40	200	01236.050.040	M10X50/S=17	100	01236.100.050	M16X100	25	01236.160.100
M5X45	200	01236.050.045	M10X55/S=17	100	01236.100.055	M16X110	25	01236.160.110
M5X50	200	01236.050.050	M10X60/S=17	100	01236.100.060			
			M10X70/S=17	100	01236.100.070	M18X45	25	01236.180.045
M6X10	500	01236.060.010	M10X80/S=17	100	01236.100.080	M18X50	50	01236.180.050
M6X12	500	01236.060.012	M10X90/S=17	100	01236.100.090	M18X55	25	01236.180.055
M6X16	500	01236.060.016				M18X60	25	01236.180.060
M6X20	500	01236.060.020	M12X20/S=19	100	01236.120.020	M18X65	25	01236.180.065
M6X25	500	01236.060.025	M12X25/S=19	100	01236.120.025			
M6X30	500	01236.060.030	M12X30/S=19	100	01236.120.030	M20X40	25	01236.200.040
M6X35	200	01236.060.035	M12X35/S=19	100	01236.120.035	M20X45	25	01236.200.045
M6X40	200	01236.060.040	M12X40/S=19	100	01236.120.040	M20X50	25	01236.200.050
M6X50	200	01236.060.050	M12X45/S=19	100	01236.120.045	M20X55	25	01236.200.055
M6X60	200	01236.060.060	M12X50/S=19	100	01236.120.050	M20X60	25	01236.200.060
M6X70	200	01236.060.070	M12X60/S=19	100	01236.120.060	M20X65	25	01236.200.065
			M12X70/S=19	50	01236.120.070	M20X70	25	01236.200.070
M8X10	200	01236.080.010	M12X80/S=19	50	01236.120.080	M20X80	25	01236.200.080
M8X12	200	01236.080.012				M20X90	25	01236.200.090
M8X16	200	01236.080.016	M14X30/S=22	100	01236.140.030			
M8X20	200	01236.080.020	M14X35/S=22	100	01236.140.035	M24X50	25	01236.240.050
M8X25	200	01236.080.025	M14X40/S=22	100	01236.140.040	M24X60	25	01236.240.060
M8X30	200	01236.080.030	M14X45/S=22	50	01236.140.045	M24X70	25	01236.240.070
M8X35	200	01236.080.035	M14X60/S=22	50	01236.140.060	M24X80	25	01236.240.080

• Powlekanie powierzchniowe ISO 10683 cynkowanie plątkowe eliminuje możliwości uszkodzenia, jakie może wywołać kruchość wodorowa.

01410 Śruby z łbem sześciokątnym z gwintem izometrycznym dopasowanym		A08A
Gwint	Metryczny	
Materiał	Stal	
Klasa	8.8	
Obróbka powierzchni	Ocynkowane na gorąco	

d x L	☒	Kod artykułu	d x L	☒	Kod artykułu	d x L	☒	Kod artykułu
M6X16	100	01410.060.016	M10X45/S=17	100	01410.100.045	M16X35	50	01410.160.035
M6X20	100	01410.060.020	M10X50/S=17	100	01410.100.050	M16X40	50	01410.160.040
M6X25	100	01410.060.025	M10X60/S=17	100	01410.100.060	M16X45	50	01410.160.045
M6X30	500	01410.060.030	M10X70/S=17	100	01410.100.070	M16X50	50	01410.160.050
M6X40	200	01410.060.040	M10X80/S=17	100	01410.100.080	M16X55	50	01410.160.055
			M10X100/S=17	100	01410.100.100	M16X60	50	01410.160.060
M8X12	100	01410.080.012				M16X65	50	01410.160.065
M8X16	100	01410.080.016	M12X20/S=19	100	01410.120.020	M16X70	50	01410.160.070
M8X20	100	01410.080.020	M12X25/S=19	100	01410.120.025	M16X80	50	01410.160.080
M8X25	100	01410.080.025	M12X30/S=19	100	01410.120.030	M16X90	25	01410.160.090
M8X30	100	01410.080.030	M12X35/S=19	100	01410.120.035	M16X100	25	01410.160.100
M8X35	100	01410.080.035	M12X40/S=19	100	01410.120.040	M16X110	25	01410.160.110
M8X40	100	01410.080.040	M12X45/S=19	100	01410.120.045	M16X120	25	01410.160.120
M8X45	100	01410.080.045	M12X50/S=19	100	01410.120.050			
M8X50	100	01410.080.050	M12X55/S=19	100	01410.120.055	M18X40	25	01410.180.040
M8X60	100	01410.080.060	M12X60/S=19	100	01410.120.060	M18X45	25	01410.180.045
M8X80	100	01410.080.080	M12X70/S=19	50	01410.120.070	M18X50	25	01410.180.050
			M12X80/S=19	50	01410.120.080	M18X55	25	01410.180.055
M10X16/S=17	100	01410.100.016	M12X90/S=19	50	01410.120.090			
M10X20/S=17	100	01410.100.020	M12X100/S=19	50	01410.120.100	M20X30	25	01410.200.030
M10X25/S=17	100	01410.100.025	M12X120/S=19	50	01410.120.120	M20X35	25	01410.200.035
M10X30/S=17	100	01410.100.030				M20X40	25	01410.200.040
M10X35/S=17	100	01410.100.035	M16X25	50	01410.160.025	M20X45	25	01410.200.045
M10X40/S=17	100	01410.100.040	M16X30	50	01410.160.030	M20X50	25	01410.200.050

01410 Śruby z łbem sześciokątnym z gwintem izometrycznym dopasowanym

d x L	☒	Kod artykułu	d x L	☒	Kod artykułu	d x L	☒	Kod artykułu
M20X55	25	01410.200.055	M24X60	25	01410.240.060	M30X60	10	01410.300.060
M20X60	25	01410.200.060	M24X65	25	01410.240.065	M30X70	10	01410.300.070
M20X65	25	01410.200.065	M24X70	25	01410.240.070	M30X80	10	01410.300.080
M20X70	25	01410.200.070	M24X80	25	01410.240.080	M30X90	10	01410.300.090
M20X80	25	01410.200.080	M24X90	10	01410.240.090	M30X100	10	01410.300.100
M20X90	25	01410.200.090	M24X100	10	01410.240.100	M30X120	10	01410.300.120
M20X100	25	01410.200.100	M24X110	10	01410.240.110			
M20X120	25	01410.200.120	M24X180	5	01410.240.180	M33X80	5	01410.330.080
						M33X90	5	01410.330.090
M22X50/S=34	25	01410.220.051	M27X50	10	01410.270.050	M33X100	5	01410.330.100
M22X60/S=34	25	01410.220.061	M27X60	10	01410.270.060			
M22X65/S=34	25	01410.220.066	M27X65	10	01410.270.065	M36X80	5	01410.360.080
			M27X70	10	01410.270.070	M36X90	5	01410.360.090
M24X40	25	01410.240.040	M27X80	10	01410.270.080	M36X100	5	01410.360.100
M24X45	25	01410.240.045	M27X90	10	01410.270.090	M36X130	5	01410.360.130
M24X50	25	01410.240.050	M27X100	10	01410.270.100			
M24X55	25	01410.240.055						

- Dla śrub cynkowanych na gorąco z gwintem IZOMETRYCZNYM DOPASOWANYM, gwint walcowany jest poniżej rozmiaru, tak aby odpowiadał sprawdzianowi przechodniemu o klasie tolerancji h po cynkowaniu.
- Zalecą tej metody produkcji jest to, że śruby mogą być bez przeszkód stosowane w każdym nagwintowanym otworze.
- Odpowiadające im nakrętki IZOMETRYCZNE DOPASOWANE, zostały nagwintowane zgodnie z klasą tolerancji 6H po cynkowaniu, tak aby doskonale pasowały do śrub.

01430 Śruby z łbem sześciokątnym z gwintem nadwymiarowym
A08A



Gwint	Metryczny
Materiał	Stal
Klasa	8.8
Obróbka powierzchni	Ocynkowane na gorąco



d x L	☒	Kod artykułu	d x L	☒	Kod artykułu	d x L	☒	Kod artykułu
M8X25	200	01430.080.025	M16X45	50	01430.160.045	M22X50/S=32	25	01430.220.050
M10X20/S=17	100	01430.100.020	M16X50	50	01430.160.050	M22X60/S=32	25	01430.220.060
M10X25/S=17	100	01430.100.025	M16X55	50	01430.160.055	M22X70/S=32	25	01430.220.070
M10X30/S=17	100	01430.100.030	M16X60	50	01430.160.060	M22X80/S=32	25	01430.220.080
M10X35/S=17	100	01430.100.035	M16X65	25	01430.160.065			
M10X40/S=17	100	01430.100.040	M16X70	25	01430.160.070	M24X40	25	01430.240.040
M10X50/S=17	100	01430.100.050	M16X80	25	01430.160.080	M24X50	25	01430.240.050
M10X60/S=17	100	01430.100.060	M16X90	25	01430.160.090	M24X55	25	01430.240.055
			M16X100	25	01430.160.100	M24X60	25	01430.240.060
M12X20/S=19	100	01430.120.020	M16X110	25	01430.160.110	M24X65	25	01430.240.065
M12X25/S=19	100	01430.120.025	M16X120	25	01430.160.120	M24X70	25	01430.240.070
M12X30/S=19	100	01430.120.030	M18X30	50	01430.180.030	M24X75	25	01430.240.075
M12X35/S=19	100	01430.120.035	M18X40	50	01430.180.040	M24X80	25	01430.240.080
M12X40/S=19	100	01430.120.040	M18X50	25	01430.180.050	M24X90	10	01430.240.090
M12X45/S=19	100	01430.120.045	M18X60	25	01430.180.060	M24X100	10	01430.240.100
M12X50/S=19	100	01430.120.050	M18X70	25	01430.180.070			
M12X55/S=19	100	01430.120.055	M18X80	25	01430.180.080	M27X60	10	01430.270.060
M12X60/S=19	100	01430.120.060	M18X100	25	01430.180.100	M27X65	10	01430.270.065
M12X70/S=19	50	01430.120.070				M27X70	10	01430.270.070
M12X80/S=19	50	01430.120.080	M20X35	25	01430.200.035	M27X75	10	01430.270.075
M12X100/S=19	50	01430.120.100	M20X40	25	01430.200.040	M27X80	10	01430.270.080
M12X120/S=19	50	01430.120.120	M20X45	25	01430.200.045			
			M20X50	25	01430.200.050	M30X60	10	01430.300.060
M14X30/S=22	100	01430.140.030	M20X55	25	01430.200.055	M30X70	10	01430.300.070
M14X35/S=22	100	01430.140.035	M20X60	25	01430.200.060	M30X80	10	01430.300.080
M14X40/S=22	100	01430.140.040	M20X65	25	01430.200.065	M30X90	10	01430.300.090
M14X50/S=22	50	01430.140.050	M20X70	25	01430.200.070	M30X100	10	01430.300.100
M14X60/S=22	50	01430.140.060	M20X75	25	01430.200.075	M30X110	10	01430.300.110
			M20X80	25	01430.200.080	M30X120	10	01430.300.120
M16X25	50	01430.160.025	M20X90	25	01430.200.090			
M16X30	50	01430.160.030	M20X100	25	01430.200.100	M36X80	5	01430.360.080
M16X35	50	01430.160.035	M20X110	25	01430.200.110	M36X90	5	01430.360.090
M16X40	50	01430.160.040	M20X130	25	01430.200.130			

- Dla śrub cynkowanych na gorąco z gwintem NADWYMIAROWYM warstwa cynku jest nakładana na normalny gwint, tak że po cynkowaniu śruby te nie są już izometryczne i pasujące, ale grubsze: tak zwane NADWYMIAROWE.
- Nie pasują do normalnych gwintów i nie mogą być zastosowane w np. normalnie nagwintowanych otworach.
- Odpowiadające im nakrętki NADWYMIAROWE zostały nagwintowane o gwint nadwymiarowy wg ISO 965-5 idealnie pasują do śrub po cynkowaniu.

04110 Śruby z łbem sześciokątnym		C01A	
Gwint	Metryczny		
Materiał	Stal		
Klasa	10.9		
Obróbka powierzchni			

d x L	☒	Kod artykułu	d x L	☒	Kod artykułu	d x L	☒	Kod artykułu
M6X10	200	04110.060.010	M12X40/S=19	100	04110.120.040	M20X30	25	04110.200.030
M6X12	200	04110.060.012	M12X45/S=19	100	04110.120.045	M20X35	25	04110.200.035
M6X16	200	04110.060.016	M12X50/S=19	100	04110.120.050	M20X40	25	04110.200.040
M6X20	200	04110.060.020	M12X55/S=19	100	04110.120.055	M20X45	25	04110.200.045
M6X25	200	04110.060.025	M12X60/S=19	100	04110.120.060	M20X50	25	04110.200.050
M6X30	200	04110.060.030	M12X70/S=19	100	04110.120.070	M20X55	25	04110.200.055
M6X35	200	04110.060.035	M12X75/S=19	100	04110.120.075	M20X60	25	04110.200.060
M6X40	200	04110.060.040	M12X80/S=19	100	04110.120.080	M20X70	25	04110.200.070
M6X45	200	04110.060.045	M12X90/S=19	50	04110.120.090	M20X80	25	04110.200.080
M6X50	200	04110.060.050	M12X100/S=19	50	04110.120.100	M20X90	25	04110.200.090
M6X60	200	04110.060.060	M12X120/S=19	50	04110.120.120	M20X100	25	04110.200.100
M6X70	200	04110.060.070				M20X120	25	04110.200.120
M8X10	200	04110.080.010	M14X30/S=22	100	04110.140.030	M22X50/S=32	25	04110.220.050
M8X12	200	04110.080.012	M14X35/S=22	100	04110.140.035	M22X60/S=32	25	04110.220.060
M8X16	200	04110.080.016	M14X40/S=22	100	04110.140.040	M22X70/S=32	25	04110.220.070
M8X20	200	04110.080.020	M14X45/S=22	50	04110.140.045	M22X80/S=32	25	04110.220.080
M8X25	200	04110.080.025	M14X50/S=22	50	04110.140.050			
M8X30	200	04110.080.030	M14X55/S=22	50	04110.140.055	M24X40	25	04110.240.040
M8X35	200	04110.080.035	M14X60/S=22	50	04110.140.060	M24X45	25	04110.240.045
M8X40	200	04110.080.040	M14X70/S=22	50	04110.140.070	M24X50	25	04110.240.050
M8X50	200	04110.080.050	M14X80/S=22	50	04110.140.080	M24X55	25	04110.240.055
M8X60	200	04110.080.060	M14X90/S=22	50	04110.140.090	M24X60	25	04110.240.060
M8X70	200	04110.080.070	M14X100/S=22	50	04110.140.100	M24X65	25	04110.240.065
M8X80	200	04110.080.080	M16X25	50	04110.160.025	M24X70	25	04110.240.070
M8X110	200	04110.080.110	M16X30	50	04110.160.030	M24X80	25	04110.240.080
M10X16/S=17	200	04110.100.016	M16X35	50	04110.160.035	M24X90	10	04110.240.090
M10X20/S=17	200	04110.100.020	M16X40	50	04110.160.040	M24X100	10	04110.240.100
M10X25/S=17	200	04110.100.025	M16X45	50	04110.160.045	M24X120	10	04110.240.120
M10X30/S=17	200	04110.100.030	M16X50	50	04110.160.050			
M10X35/S=17	100	04110.100.035	M16X55	50	04110.160.055	M27X60	10	04110.270.060
M10X40/S=17	100	04110.100.040	M16X60	25	04110.160.060	M27X70	10	04110.270.070
M10X45/S=17	100	04110.100.045	M16X65	25	04110.160.065	M27X80	10	04110.270.080
M10X50/S=17	100	04110.100.050	M16X70	25	04110.160.070			
M10X55/S=17	100	04110.100.055	M16X80	25	04110.160.080	M30X60	10	04110.300.060
M10X60/S=17	100	04110.100.060	M16X90	25	04110.160.090	M30X70	10	04110.300.070
M10X70/S=17	100	04110.100.070	M16X100	25	04110.160.100	M30X80	10	04110.300.080
M10X80/S=17	100	04110.100.080	M16X120	25	04110.160.120	M30X90	10	04110.300.090
M10X90/S=17	100	04110.100.090	M16X140	100	04110.160.140	M30X100	10	04110.300.100
M10X100/S=17	100	04110.100.100				M30X110	10	04110.300.110
M12X16/S=19	100	04110.120.016	M18X30	50	04110.180.030	M36X70	5	04110.360.070
M12X20/S=19	100	04110.120.020	M18X35	50	04110.180.035	M36X80	5	04110.360.080
M12X25/S=19	100	04110.120.025	M18X40	50	04110.180.040	M36X90	5	04110.360.090
M12X30/S=19	100	04110.120.030	M18X45	50	04110.180.045	M36X100	5	04110.360.100
M12X35/S=19	100	04110.120.035	M18X50	50	04110.180.050	M36X110	5	04110.360.110

• Ostrzeżenie: cynkowanie elektrolityczne tych produktów może wywołać kruchość wodorową.

04116 Śruby z łbem sześciokątnym		C02C	
Gwint	Metryczny		
Materiał	Stal		
Klasa	10.9		
Obróbka powierzchni	Ocynk płatkowy bez Cr6+ wg ISO 10683 (flZnnc)		



d x L	☒	Kod artykułu	d x L	☒	Kod artykułu	d x L	☒	Kod artykułu
M6X10	200	04116.060.010	M10X25/S=17	200	04116.100.025	M14X40/S=22	100	04116.140.040
M6X12	200	04116.060.012	M10X30/S=17	200	04116.100.030	M14X45/S=22	50	04116.140.045
M6X16	200	04116.060.016	M10X35/S=17	100	04116.100.035	M14X50/S=22	50	04116.140.050
M6X20	200	04116.060.020	M10X60/S=17	100	04116.100.060			
M6X25	200	04116.060.025				M16X30	50	04116.160.030
M6X30	200	04116.060.030	M12X20/S=19	100	04116.120.020	M16X35	50	04116.160.035
M8X16	200	04116.080.016	M12X25/S=19	100	04116.120.025	M16X40	50	04116.160.040
M8X20	200	04116.080.020	M12X30/S=19	100	04116.120.030	M16X45	50	04116.160.045
M8X25	200	04116.080.025	M12X35/S=19	100	04116.120.035	M16X50	50	04116.160.050
M8X30	200	04116.080.030	M12X40/S=19	100	04116.120.040	M16X60	25	04116.160.060
M10X16/S=17	200	04116.100.016	M12X45/S=19	100	04116.120.045			
M10X20/S=17	200	04116.100.020	M12X50/S=19	100	04116.120.050	M20X40	25	04116.200.040
			M12X60/S=19	100	04116.120.060	M20X45	25	04116.200.045
						M20X50	25	04116.200.050

04116 Śruby z łbem sześciokątnym

d x L	☒	Kod artykułu	d x L	☒	Kod artykułu	d x L	☒	Kod artykułu
M20X60	25	04116.200.060				M24X60	25	04116.240.060
M20X70	25	04116.200.070	M24X50	25	04116.240.050	M24X70	25	04116.240.070

- Powlekanie powierzchniowe ISO 10683 cynkowanie platkowe eliminuje możliwości uszkodzenia, jakie może wywołać kruchość wodorowa.

04118 Śruby z łbem sześciokątnym
C01A

Gwint	Metryczny
Materiał	Stal
Klasa	12.9





d x L	☒	Kod artykułu	d x L	☒	Kod artykułu	d x L	☒	Kod artykułu
M8X20	200	04118.080.020				M20X90	25	04118.200.090
M8X25	200	04118.080.025	M16X30	50	04118.160.030	M20X100	25	04118.200.100
M8X30	200	04118.080.030	M16X35	50	04118.160.035			
M10X20/S=17	200	04118.100.020	M16X40	50	04118.160.040	M24X50	25	04118.240.050
M10X25/S=17	200	04118.100.025	M16X45	50	04118.160.045	M24X60	25	04118.240.060
M10X30/S=17	200	04118.100.030	M16X50	50	04118.160.050	M24X70	25	04118.240.070
M10X35/S=17	100	04118.100.035	M16X60	50	04118.160.060	M24X80	25	04118.240.080
M10X40/S=17	100	04118.100.040	M16X70	25	04118.160.070	M24X90	10	04118.240.090
			M16X80	25	04118.160.080	M24X100	10	04118.240.100
M12X25/S=19	100	04118.120.025	M20X40	25	04118.200.040	M30X60	10	04118.300.060
M12X30/S=19	100	04118.120.030	M20X50	25	04118.200.050	M30X70	10	04118.300.070
M12X35/S=19	100	04118.120.035	M20X60	25	04118.200.060	M30X80	10	04118.300.080
M12X40/S=19	100	04118.120.040	M20X70	25	04118.200.070	M30X90	10	04118.300.090
M12X45/S=19	100	04118.120.045	M20X80	25	04118.200.080	M30X100	10	04118.300.100

- Ostrzeżenie: cynkowanie elektrolityczne tych produktów może wywołać kruchość wodorową.

08760 Śruby z łbem sześciokątnym do zbiorników ciśnieniowych
E11A

Gwint	Metryczny
Materiał	Stal
Klasa	5.6

d x L	☒	Kod artykułu	d x L	☒	Kod artykułu	d x L	☒	Kod artykułu
M10X25/S=16	200	08760.100.026	M16X35	50	08760.160.035	M20X65	25	08760.200.065
			M16X45	50	08760.160.045	M20X70	25	08760.200.070
M12X25/S=18	100	08760.120.026	M16X50	50	08760.160.050			
M12X30/S=18	100	08760.120.031	M16X55	50	08760.160.055	M24X55	25	08760.240.055
M12X35/S=18	100	08760.120.036	M16X60	50	08760.160.060	M24X70	25	08760.240.070
M12X40/S=18	100	08760.120.041				M24X80	25	08760.240.080
M12X45/S=18	100	08760.120.046	M20X50	25	08760.200.050			
			M20X60	25	08760.200.060	M27X65	10	08760.270.065

- Specjalne cechy wkrętów z łbem sześciokątnym do zbiorników ciśnieniowych etc.:
- Przeznaczone są do stosowania w zbiornikach ciśnieniowych, urządzeniach parowych, sprzęcie i połączeniach kołnierżowych w temperaturach od -10°C do +300°C, nadciśnieniu maks. 40 bar i rozmiarach do M30 włącznie.
- Spełniają wymagania AD-Merkblatt W7, TRD 106 z TÜV (Technischer Überwachungsverein) i DIN 267-13.
- Zgodnie z TUV-Merkstoffe 1253, producent otrzymał uprawnienia na dostarczanie tych śrub bez certyfikatu 3.1, wystarczy znak handlowy i oznaczenie klasy.
- Certyfikat jest również zaakceptowany "Lloyd's Register Energy".

51010 Śruby z łbem sześciokątnym
Q01A

Gwint	Metryczny
Materiał	Stal nierdzewna A2
Klasa	70



d x L	☒	Kod artykułu	d x L	☒	Kod artykułu	d x L	☒	Kod artykułu
M2X3*	1000	51010.020.003	M2,5X5*	1000	51010.025.005	M3X5*	1000	51010.030.005
M2X4*	1000	51010.020.004	M2,5X6*	1000	51010.025.006	M3X6	200	51010.030.006
M2X5*	1000	51010.020.005	M2,5X8*	1000	51010.025.008	M3X8	200	51010.030.008
M2X6*	1000	51010.020.006	M2,5X10*	1000	51010.025.010	M3X10	200	51010.030.010
M2X8*	1000	51010.020.008	M2,5X12*	1000	51010.025.012	M3X12	200	51010.030.012
M2X10*	1000	51010.020.010	M2,5X14*	1000	51010.025.014	M3X14	1000	51010.030.014
M2X12*	1000	51010.020.012	M2,5X16*	1000	51010.025.016	M3X16	200	51010.030.016
M2X14*	1000	51010.020.014	M2,5X18*	1000	51010.025.018	M3X18*	1000	51010.030.018
M2X16*	1000	51010.020.016	M2,5X20*	1000	51010.025.020	M3X20	200	51010.030.020
M2X20*	1000	51010.020.020				M3X22*	1000	51010.030.022
			M3X4*	1000	51010.030.004	M3X25	200	51010.030.025

51010 Śruby z łbem sześciokątnym								
d x L	☒	Kod artykułu	d x L	☒	Kod artykułu	d x L	☒	Kod artykułu
M3X30	200	51010.030.030	M6X120*	50	51010.060.120	M12X40/S=19	50	51010.120.040
M3X35*	500	51010.030.035	M6X130*	50	51010.060.130	M12X45/S=19	50	51010.120.045
M3X40	200	51010.030.040	M6X140*	50	51010.060.140	M12X50/S=19	50	51010.120.050
M3X45*	500	51010.030.045	M6X150	50	51010.060.150	M12X55/S=19	50	51010.120.055
M3X50	200	51010.030.050				M12X60/S=19	50	51010.120.060
			M8X8*	500	51010.080.008	M12X65/S=19	50	51010.120.065
M4X4*	1000	51010.040.004	M8X10	200	51010.080.010	M12X70/S=19	50	51010.120.070
M4X5*	1000	51010.040.005	M8X12	200	51010.080.012	M12X75/S=19	25	51010.120.075
M4X6	200	51010.040.006	M8X14	200	51010.080.014	M12X80/S=19	50	51010.120.080
M4X8	200	51010.040.008	M8X16	200	51010.080.016	M12X85/S=19	25	51010.120.085
M4X10	200	51010.040.010	M8X18	200	51010.080.018	M12X90/S=19	25	51010.120.090
M4X12	200	51010.040.012	M8X20	200	51010.080.020	M12X95/S=19*	25	51010.120.095
M4X14	1000	51010.040.014	M8X22	200	51010.080.022	M12X100/S=19	25	51010.120.100
M4X16	200	51010.040.016	M8X25	200	51010.080.025	M12X110/S=19	25	51010.120.110
M4X18*	1000	51010.040.018	M8X30	200	51010.080.030	M12X120/S=19	25	51010.120.120
M4X20	200	51010.040.020	M8X35	200	51010.080.035	M12X130/S=19	25	51010.120.130
M4X22*	500	51010.040.022	M8X40	100	51010.080.040	M12X140/S=19	25	51010.120.140
M4X25	200	51010.040.025	M8X45	100	51010.080.045	M12X150/S=19	10	51010.120.150
M4X30	200	51010.040.030	M8X50	100	51010.080.050	M12X160/S=19	10	51010.120.160
M4X35	200	51010.040.035	M8X55	100	51010.080.055	M12X170/S=19*	10	51010.120.170
M4X40	200	51010.040.040	M8X60	100	51010.080.060	M12X180/S=19	10	51010.120.180
M4X45	200	51010.040.045	M8X65	100	51010.080.065	M12X190/S=19*	10	51010.120.190
M4X50	200	51010.040.050	M8X70	50	51010.080.070	M12X200/S=19	10	51010.120.200
M4X55*	200	51010.040.055	M8X75	50	51010.080.075	M12X250/S=19	10	51010.120.250
M4X60	200	51010.040.060	M8X80	50	51010.080.080			
M4X65*	100	51010.040.065	M8X85	50	51010.080.085	M14X20/S=22*	50	51010.140.020
M4X70*	100	51010.040.070	M8X90	50	51010.080.090	M14X25/S=22	50	51010.140.025
M4X75*	100	51010.040.075	M8X95	50	51010.080.095	M14X30/S=22	50	51010.140.030
M4X80*	100	51010.040.080	M8X100	50	51010.080.100	M14X35/S=22	50	51010.140.035
			M8X110	25	51010.080.110	M14X40/S=22	50	51010.140.040
M5X5*	500	51010.050.005	M8X120	25	51010.080.120	M14X45/S=22	50	51010.140.045
M5X6	200	51010.050.006	M8X130*	50	51010.080.130	M14X50/S=22	50	51010.140.050
M5X8	200	51010.050.008	M8X140	50	51010.080.140	M14X55/S=22	50	51010.140.055
M5X10	200	51010.050.010	M8X150	50	51010.080.150	M14X60/S=22	50	51010.140.060
M5X12	200	51010.050.012	M8X160*	25	51010.080.160	M14X65/S=22	50	51010.140.065
M5X14	500	51010.050.014	M8X170*	25	51010.080.170	M14X70/S=22	50	51010.140.070
M5X16	200	51010.050.016	M8X180*	25	51010.080.180	M14X75/S=22*	50	51010.140.075
M5X18	200	51010.050.018	M8X190*	25	51010.080.190	M14X80/S=22	25	51010.140.080
M5X20	200	51010.050.020	M8X200*	25	51010.080.200	M14X85/S=22*	50	51010.140.085
M5X22*	500	51010.050.022				M14X90/S=22	50	51010.140.090
M5X25	200	51010.050.025	M10X10/S=17	100	51010.100.010	M14X100/S=22	10	51010.140.100
M5X30	200	51010.050.030	M10X12/S=17	100	51010.100.012	M14X110/S=22*	25	51010.140.110
M5X35	200	51010.050.035	M10X14/S=17	100	51010.100.014	M14X120/S=22*	25	51010.140.120
M5X40	200	51010.050.040	M10X16/S=17	100	51010.100.016	M14X130/S=22*	25	51010.140.130
M5X45	200	51010.050.045	M10X18/S=17*	100	51010.100.018	M14X140/S=22*	25	51010.140.140
M5X50	200	51010.050.050	M10X20/S=17	100	51010.100.020	M14X150/S=22*	25	51010.140.150
M5X55	200	51010.050.055	M10X22/S=17*	100	51010.100.022			
M5X60	200	51010.050.060	M10X25/S=17	100	51010.100.025	M16X16*	25	51010.160.016
M5X65*	200	51010.050.065	M10X30/S=17	100	51010.100.030	M16X20	25	51010.160.020
M5X70	200	51010.050.070	M10X35/S=17	100	51010.100.035	M16X25	50	51010.160.025
M5X75*	100	51010.050.075	M10X40/S=17	100	51010.100.040	M16X30	50	51010.160.030
M5X80	100	51010.050.080	M10X45/S=17	100	51010.100.045	M16X35	50	51010.160.035
M5X85*	100	51010.050.085	M10X50/S=17	100	51010.100.050	M16X40	50	51010.160.040
M5X90*	100	51010.050.090	M10X55/S=17	50	51010.100.055	M16X45	50	51010.160.045
M5X100*	100	51010.050.100	M10X60/S=17	50	51010.100.060	M16X50	50	51010.160.050
			M10X65/S=17	50	51010.100.065	M16X55	25	51010.160.055
M6X6	500	51010.060.006	M10X70/S=17	50	51010.100.070	M16X60	25	51010.160.060
M6X8	200	51010.060.008	M10X75/S=17	50	51010.100.075	M16X65	25	51010.160.065
M6X10	200	51010.060.010	M10X80/S=17	50	51010.100.080	M16X70	25	51010.160.070
M6X12	200	51010.060.012	M10X85/S=17	50	51010.100.085	M16X75	25	51010.160.075
M6X14	200	51010.060.014	M10X90/S=17	25	51010.100.090	M16X80	25	51010.160.080
M6X16	200	51010.060.016	M10X95/S=17*	50	51010.100.095	M16X85	25	51010.160.085
M6X18	200	51010.060.018	M10X100/S=17	25	51010.100.100	M16X90	10	51010.160.090
M6X20	200	51010.060.020	M10X110/S=17	25	51010.100.110	M16X95*	25	51010.160.095
M6X22	200	51010.060.022	M10X120/S=17	25	51010.100.120	M16X100	10	51010.160.100
M6X25	200	51010.060.025	M10X130/S=17	25	51010.100.130	M16X110	10	51010.160.110
M6X30	200	51010.060.030	M10X135/S=17*	50	51010.100.135	M16X120	10	51010.160.120
M6X35	200	51010.060.035	M10X140/S=17	25	51010.100.140	M16X130	25	51010.160.130
M6X40	200	51010.060.040	M10X150/S=17	10	51010.100.150	M16X140	25	51010.160.140
M6X45	100	51010.060.045	M10X160/S=17	10	51010.100.160	M16X150	25	51010.160.150
M6X50	100	51010.060.050	M10X170/S=17	25	51010.100.170	M16X160	25	51010.160.160
M6X55	100	51010.060.055	M10X180/S=17	25	51010.100.180	M16X170*	25	51010.160.170
M6X60	100	51010.060.060	M10X190/S=17*	25	51010.100.190	M16X180*	10	51010.160.180
M6X65	100	51010.060.065	M10X200/S=17*	25	51010.100.200	M16X190*	10	51010.160.190
M6X70	100	51010.060.070				M16X200	10	51010.160.200
M6X75	100	51010.060.075	M12X16/S=19	100	51010.120.016			
M6X80	100	51010.060.080	M12X18/S=19*	50	51010.120.018	M18X30	25	51010.180.030
M6X85*	100	51010.060.085	M12X20/S=19	100	51010.120.020	M18X35	25	51010.180.035
M6X90	100	51010.060.090	M12X22/S=19*	50	51010.120.022	M18X40	25	51010.180.040
M6X95	100	51010.060.095	M12X25/S=19	100	51010.120.025	M18X45	25	51010.180.045
M6X100	100	51010.060.100	M12X30/S=19	100	51010.120.030	M18X50	25	51010.180.050
M6X110	100	51010.060.110	M12X35/S=19	100	51010.120.035	M18X55	25	51010.180.055

51010 Śruby z łbem sześciokątnym								
d x L	☒	Kod artykułu	d x L	☒	Kod artykułu	d x L	☒	Kod artykułu
M18X60	25	51010.180.060	M22X85/S=32*	25	51010.220.085	M27X190*	5	51010.270.190
M18X65*	25	51010.180.065	M22X90/S=32	10	51010.220.090	M27X200*	5	51010.270.200
M18X70	25	51010.180.070	M22X95/S=32*	25	51010.220.095			
M18X75*	25	51010.180.075	M22X100/S=32	5	51010.220.100	M30X60	1	51010.300.060
M18X80	25	51010.180.080	M22X110/S=32*	20	51010.220.110	M30X65*	10	51010.300.065
M18X85*	25	51010.180.085	M22X120/S=32*	20	51010.220.120	M30X70	1	51010.300.070
M18X90	25	51010.180.090	M22X130/S=32*	20	51010.220.130	M30X75*	10	51010.300.075
M18X95*	25	51010.180.095	M22X140/S=32*	20	51010.220.140	M30X80	1	51010.300.080
M18X100	25	51010.180.100	M22X150/S=32*	10	51010.220.150	M30X85*	10	51010.300.085
M18X110*	25	51010.180.110				M30X90	1	51010.300.090
M18X120*	25	51010.180.120	M24X40	10	51010.240.040	M30X95*	10	51010.300.095
M18X130*	25	51010.180.130	M24X45*	10	51010.240.045	M30X100	1	51010.300.100
M18X140*	25	51010.180.140	M24X50	5	51010.240.050	M30X110	1	51010.300.110
M18X150*	25	51010.180.150	M24X55	5	51010.240.055	M30X120	1	51010.300.120
			M24X60	5	51010.240.060	M30X130*	10	51010.300.130
M20X25	25	51010.200.025	M24X65	5	51010.240.065	M30X140*	10	51010.300.140
M20X30	25	51010.200.030	M24X70	5	51010.240.070	M30X150*	10	51010.300.150
M20X35	25	51010.200.035	M24X75*	10	51010.240.075	M30X160*	5	51010.300.160
M20X40	25	51010.200.040	M24X80	5	51010.240.080	M30X170*	5	51010.300.170
M20X45	25	51010.200.045	M24X85	10	51010.240.085	M30X180*	5	51010.300.180
M20X50	25	51010.200.050	M24X90	5	51010.240.090	M30X190*	5	51010.300.190
M20X55	25	51010.200.055	M24X95*	10	51010.240.095	M30X200*	5	51010.300.200
M20X60	25	51010.200.060	M24X100	5	51010.240.100			
M20X65	25	51010.200.065	M24X110	5	51010.240.110	M33X70*	10	51010.330.070
M20X70	25	51010.200.070	M24X120	5	51010.240.120	M33X80	1	51010.330.080
M20X75	10	51010.200.075	M24X130	5	51010.240.130	M33X85*	10	51010.330.085
M20X80	10	51010.200.080	M24X140	5	51010.240.140	M33X90	1	51010.330.090
M20X85*	25	51010.200.085	M24X150	5	51010.240.150	M33X95*	10	51010.330.095
M20X90	10	51010.200.090	M24X160*	10	51010.240.160	M33X100	1	51010.330.100
M20X95*	25	51010.200.095	M24X170*	10	51010.240.170	M33X110	1	51010.330.110
M20X100	10	51010.200.100	M24X180*	5	51010.240.180	M33X120	1	51010.330.120
M20X110	5	51010.200.110	M24X190*	5	51010.240.190	M33X130*	5	51010.330.130
M20X120	5	51010.200.120	M24X200*	5	51010.240.200	M33X140*	5	51010.330.140
M20X130	5	51010.200.130				M33X150*	5	51010.330.150
M20X140	5	51010.200.140	M27X50	3	51010.270.050	M33X160*	5	51010.330.160
M20X150	5	51010.200.150	M27X55*	10	51010.270.055	M33X170*	5	51010.330.170
M20X160	5	51010.200.160	M27X60	3	51010.270.060	M33X180*	5	51010.330.180
M20X170*	25	51010.200.170	M27X65*	10	51010.270.065			
M20X180	20	51010.200.180	M27X70	3	51010.270.070	M36X80	1	51010.360.080
M20X190*	20	51010.200.190	M27X75*	10	51010.270.075	M36X85*	5	51010.360.085
M20X200*	20	51010.200.200	M27X80	3	51010.270.080	M36X90	1	51010.360.090
M20X250*	20	51010.200.250	M27X85*	10	51010.270.085	M36X95*	5	51010.360.095
			M27X90	3	51010.270.090	M36X100	1	51010.360.100
M22X30/S=32	25	51010.220.030	M27X95*	10	51010.270.095	M36X110	1	51010.360.110
M22X40/S=32*	25	51010.220.040	M27X100	3	51010.270.100	M36X120	1	51010.360.120
M22X45/S=32*	25	51010.220.045	M27X110	3	51010.270.110	M36X130	1	51010.360.130
M22X50/S=32	10	51010.220.050	M27X120	3	51010.270.120	M36X140	1	51010.360.140
M22X55/S=32*	25	51010.220.055	M27X130*	10	51010.270.130	M36X150	1	51010.360.150
M22X60/S=32	10	51010.220.060	M27X140*	10	51010.270.140	M36X160*	5	51010.360.160
M22X65/S=32*	25	51010.220.065	M27X150*	10	51010.270.150	M36X170*	5	51010.360.170
M22X70/S=32	10	51010.220.070	M27X160*	5	51010.270.160	M36X180*	5	51010.360.180
M22X75/S=32*	25	51010.220.075	M27X170*	5	51010.270.170	M36X200*	5	51010.360.200
M22X80/S=32	10	51010.220.080	M27X180*	5	51010.270.180			

* Rozmiary o średnicy > M24 i rozmiary o długości > 8xd mają minimalną klasę właściwości 5.0.

55010 Śruby z łbem sześciokątnym							
							Q41A
Gwint	Metryczny						
Materiał	Stal nierdzewna A4						
Klasa	70						

d x L	☒	Kod artykułu	d x L	☒	Kod artykułu	d x L	☒	Kod artykułu
M2X4*	1000	55010.020.004	M2,5X12*	1000	55010.025.012	M3X22*	1000	55010.030.022
M2X5*	1000	55010.020.005	M2,5X14*	1000	55010.025.014	M3X25	200	55010.030.025
M2X6*	1000	55010.020.006	M2,5X16*	1000	55010.025.016	M3X30	200	55010.030.030
M2X8*	1000	55010.020.008	M2,5X20*	1000	55010.025.020	M3X35	500	55010.030.035
M2X10*	1000	55010.020.010				M3X40*	500	55010.030.040
M2X12*	1000	55010.020.012	M3X4*	1000	55010.030.004	M3X50*	200	55010.030.050
M2X14*	1000	55010.020.014	M3X5*	1000	55010.030.005			
M2X16*	1000	55010.020.016	M3X6*	1000	55010.030.006	M4X6	1000	55010.040.006
M2X20*	1000	55010.020.020	M3X8	200	55010.030.008	M4X8	200	55010.040.008
			M3X10	200	55010.030.010	M4X10	200	55010.040.010
M2,5X4*	1000	55010.025.004	M3X12	200	55010.030.012	M4X12	200	55010.040.012
M2,5X5*	1000	55010.025.005	M3X14*	1000	55010.030.014	M4X14	1000	55010.040.014
M2,5X6*	1000	55010.025.006	M3X16	200	55010.030.016	M4X16	200	55010.040.016
M2,5X8*	1000	55010.025.008	M3X18*	1000	55010.030.018	M4X18	1000	55010.040.018
M2,5X10*	1000	55010.025.010	M3X20	200	55010.030.020	M4X20	200	55010.040.020

55010 Śruby z łbem sześciokątnym								
d x L	☒	Kod artykułu	d x L	☒	Kod artykułu	d x L	☒	Kod artykułu
M4X22*	500	55010.040.022	M8X40	100	55010.080.040	M12X150/S=19	10	55010.120.150
M4X25	200	55010.040.025	M8X45	100	55010.080.045	M12X160/S=19	10	55010.120.160
M4X30	200	55010.040.030	M8X50	100	55010.080.050	M12X170/S=19*	10	55010.120.170
M4X35	200	55010.040.035	M8X55	100	55010.080.055	M12X180/S=19	10	55010.120.180
M4X40	200	55010.040.040	M8X60	100	55010.080.060	M12X190/S=19*	10	55010.120.190
M4X45	200	55010.040.045	M8X65	100	55010.080.065	M12X200/S=19	10	55010.120.200
M4X50	200	55010.040.050	M8X70	50	55010.080.070	M12X250/S=19*	10	55010.120.250
M4X55*	200	55010.040.055	M8X75	50	55010.080.075			
M4X60	100	55010.040.060	M8X80	50	55010.080.080	M14X20/S=22*	50	55010.140.020
M4X70*	100	55010.040.070	M8X85*	50	55010.080.085	M14X25/S=22	50	55010.140.025
M4X75*	100	55010.040.075	M8X90	50	55010.080.090	M14X30/S=22	50	55010.140.030
M4X80*	100	55010.040.080	M8X95*	50	55010.080.095	M14X35/S=22	50	55010.140.035
			M8X100	50	55010.080.100	M14X40/S=22	50	55010.140.040
M5X5*	500	55010.050.005	M8X110	25	55010.080.110	M14X45/S=22	50	55010.140.045
M5X6*	500	55010.050.006	M8X120	25	55010.080.120	M14X50/S=22	50	55010.140.050
M5X8	200	55010.050.008	M8X130*	50	55010.080.130	M14X55/S=22*	50	55010.140.055
M5X10	200	55010.050.010	M8X140	25	55010.080.140	M14X60/S=22	50	55010.140.060
M5X12	200	55010.050.012	M8X150*	50	55010.080.150	M14X65/S=22	50	55010.140.065
M5X14	500	55010.050.014	M8X160	25	55010.080.160	M14X70/S=22	50	55010.140.070
M5X16	200	55010.050.016	M8X170*	25	55010.080.170	M14X75/S=22*	50	55010.140.075
M5X18	200	55010.050.018	M8X180	25	55010.080.180	M14X80/S=22	25	55010.140.080
M5X20	200	55010.050.020	M8X190*	25	55010.080.190	M14X85/S=22*	50	55010.140.085
M5X22	500	55010.050.022	M8X200*	25	55010.080.200	M14X90/S=22	25	55010.140.090
M5X25	200	55010.050.025				M14X100/S=22	10	55010.140.100
M5X30	200	55010.050.030	M10X10/S=17	100	55010.100.010	M14X110/S=22*	25	55010.140.110
M5X35	200	55010.050.035	M10X12/S=17	100	55010.100.012	M14X120/S=22	10	55010.140.120
M5X40	200	55010.050.040	M10X14/S=17*	100	55010.100.014	M14X130/S=22*	25	55010.140.130
M5X45	200	55010.050.045	M10X16/S=17	100	55010.100.016	M14X140/S=22	10	55010.140.140
M5X50	200	55010.050.050	M10X18/S=17	100	55010.100.018	M14X150/S=22*	25	55010.140.150
M5X55	200	55010.050.055	M10X20/S=17	100	55010.100.020			
M5X60	200	55010.050.060	M10X22/S=17	100	55010.100.022	M16X20	25	55010.160.020
M5X65*	200	55010.050.065	M10X25/S=17	100	55010.100.025	M16X25	50	55010.160.025
M5X70	100	55010.050.070	M10X30/S=17	100	55010.100.030	M16X30	50	55010.160.030
M5X75*	100	55010.050.075	M10X35/S=17	100	55010.100.035	M16X35	50	55010.160.035
M5X80*	100	55010.050.080	M10X40/S=17	100	55010.100.040	M16X40	50	55010.160.040
M5X85*	100	55010.050.085	M10X45/S=17	100	55010.100.045	M16X45	50	55010.160.045
M5X90*	100	55010.050.090	M10X50/S=17	100	55010.100.050	M16X50	25	55010.160.050
M5X95*	100	55010.050.095	M10X55/S=17	50	55010.100.055	M16X55	25	55010.160.055
M5X100*	100	55010.050.100	M10X60/S=17	50	55010.100.060	M16X60	25	55010.160.060
			M10X65/S=17	50	55010.100.065	M16X65	25	55010.160.065
M6X6*	500	55010.060.006	M10X70/S=17	50	55010.100.070	M16X70	25	55010.160.070
M6X8	200	55010.060.008	M10X75/S=17	50	55010.100.075	M16X75	25	55010.160.075
M6X10	200	55010.060.010	M10X80/S=17	50	55010.100.080	M16X80	25	55010.160.080
M6X12	200	55010.060.012	M10X85/S=17*	50	55010.100.085	M16X85	25	55010.160.085
M6X14	200	55010.060.014	M10X90/S=17	25	55010.100.090	M16X90	10	55010.160.090
M6X16	200	55010.060.016	M10X95/S=17*	50	55010.100.095	M16X95*	25	55010.160.095
M6X18	200	55010.060.018	M10X100/S=17	25	55010.100.100	M16X100	10	55010.160.100
M6X20	200	55010.060.020	M10X110/S=17	25	55010.100.110	M16X110	10	55010.160.110
M6X22	200	55010.060.022	M10X120/S=17	25	55010.100.120	M16X120	10	55010.160.120
M6X25	200	55010.060.025	M10X130/S=17*	50	55010.100.130	M16X130	10	55010.160.130
M6X30	200	55010.060.030	M10X135/S=17*	50	55010.100.135	M16X140	10	55010.160.140
M6X35	200	55010.060.035	M10X140/S=17	25	55010.100.140	M16X150	10	55010.160.150
M6X40	200	55010.060.040	M10X150/S=17	25	55010.100.150	M16X160	10	55010.160.160
M6X45	100	55010.060.045	M10X160/S=17	10	55010.100.160	M16X170*	25	55010.160.170
M6X50	100	55010.060.050	M10X170/S=17*	25	55010.100.170	M16X180	10	55010.160.180
M6X55	100	55010.060.055	M10X180/S=17	10	55010.100.180	M16X190*	10	55010.160.190
M6X60	100	55010.060.060	M10X190/S=17*	25	55010.100.190	M16X200	10	55010.160.200
M6X65	100	55010.060.065	M10X200/S=17	10	55010.100.200			
M6X70	100	55010.060.070				M18X30*	25	55010.180.030
M6X75	100	55010.060.075	M12X16/S=19	100	55010.120.016	M18X35	25	55010.180.035
M6X80	100	55010.060.080	M12X18/S=19*	50	55010.120.018	M18X40	25	55010.180.040
M6X85*	100	55010.060.085	M12X20/S=19	100	55010.120.020	M18X45	25	55010.180.045
M6X90	100	55010.060.090	M12X25/S=19	100	55010.120.025	M18X50	25	55010.180.050
M6X95*	100	55010.060.095	M12X30/S=19	100	55010.120.030	M18X55*	25	55010.180.055
M6X100	100	55010.060.100	M12X35/S=19	100	55010.120.035	M18X60	25	55010.180.060
M6X110*	50	55010.060.110	M12X40/S=19	50	55010.120.040	M18X65*	25	55010.180.065
M6X120	50	55010.060.120	M12X45/S=19	50	55010.120.045	M18X70	25	55010.180.070
M6X130*	50	55010.060.130	M12X50/S=19	50	55010.120.050	M18X75*	25	55010.180.075
M6X140*	50	55010.060.140	M12X55/S=19	50	55010.120.055	M18X80	25	55010.180.080
M6X150*	50	55010.060.150	M12X60/S=19	50	55010.120.060	M18X85*	25	55010.180.085
			M12X65/S=19	50	55010.120.065	M18X90	25	55010.180.090
M8X8*	500	55010.080.008	M12X70/S=19	50	55010.120.070	M18X100	25	55010.180.100
M8X10	200	55010.080.010	M12X75/S=19	25	55010.120.075	M18X110*	25	55010.180.110
M8X12	200	55010.080.012	M12X80/S=19	50	55010.120.080	M18X120*	25	55010.180.120
M8X14*	200	55010.080.014	M12X85/S=19*	25	55010.120.085	M18X130*	25	55010.180.130
M8X16	200	55010.080.016	M12X90/S=19	25	55010.120.090	M18X140*	25	55010.180.140
M8X18	200	55010.080.018	M12X95/S=19*	25	55010.120.095	M18X150*	25	55010.180.150
M8X20	200	55010.080.020	M12X100/S=19	25	55010.120.100			
M8X22	200	55010.080.022	M12X110/S=19	25	55010.120.110	M20X25*	25	55010.200.025
M8X25	200	55010.080.025	M12X120/S=19	25	55010.120.120	M20X30	25	55010.200.030
M8X30	200	55010.080.030	M12X130/S=19*	25	55010.120.130	M20X35	25	55010.200.035
M8X35	200	55010.080.035	M12X140/S=19	25	55010.120.140	M20X40	25	55010.200.040

55010 Śruby z łbem sześciokątnym								
d x L	☒	Kod artykułu	d x L	☒	Kod artykułu	d x L	☒	Kod artykułu
M20X45	25	55010.200.045	M24X45*	10	55010.240.045	M30X70	1	55010.300.070
M20X50	25	55010.200.050	M24X50	5	55010.240.050	M30X75*	10	55010.300.075
M20X55	25	55010.200.055	M24X55	5	55010.240.055	M30X80	1	55010.300.080
M20X60	25	55010.200.060	M24X60	5	55010.240.060	M30X85*	10	55010.300.085
M20X65	25	55010.200.065	M24X65	5	55010.240.065	M30X90	1	55010.300.090
M20X70	25	55010.200.070	M24X70	5	55010.240.070	M30X100	1	55010.300.100
M20X75	10	55010.200.075	M24X75*	10	55010.240.075	M30X110	1	55010.300.110
M20X80	10	55010.200.080	M24X80	5	55010.240.080	M30X120	1	55010.300.120
M20X85	10	55010.200.085	M24X85*	10	55010.240.085	M30X130*	10	55010.300.130
M20X90	10	55010.200.090	M24X90	5	55010.240.090	M30X140*	10	55010.300.140
M20X95*	25	55010.200.095	M24X95*	10	55010.240.095	M30X150	1	55010.300.150
M20X100	10	55010.200.100	M24X100	5	55010.240.100	M30X160*	5	55010.300.160
M20X110	5	55010.200.110	M24X110	5	55010.240.110	M30X170*	5	55010.300.170
M20X120	5	55010.200.120	M24X120	5	55010.240.120	M30X180*	5	55010.300.180
M20X125*	25	55010.200.125	M24X130	5	55010.240.130	M30X190*	5	55010.300.190
M20X130	5	55010.200.130	M24X140	5	55010.240.140	M30X200*	5	55010.300.200
M20X140	5	55010.200.140	M24X150	5	55010.240.150			
M20X150	5	55010.200.150	M24X160	3	55010.240.160	M33X70	1	55010.330.070
M20X160	5	55010.200.160	M24X170*	10	55010.240.170	M33X75*	10	55010.330.075
M20X170*	25	55010.200.170	M24X180	3	55010.240.180	M33X80	1	55010.330.080
M20X180	5	55010.200.180	M24X190*	5	55010.240.190	M33X85*	10	55010.330.085
M20X190*	20	55010.200.190	M24X200	3	55010.240.200	M33X90	1	55010.330.090
M20X200	5	55010.200.200				M33X100	1	55010.330.100
M20X250*	20	55010.200.250	M27X50	3	55010.270.050	M33X110	1	55010.330.110
			M27X55*	10	55010.270.055	M33X120	1	55010.330.120
M22X30/S=32*	25	55010.220.030	M27X60	3	55010.270.060	M33X130*	5	55010.330.130
M22X35/S=32*	25	55010.220.035	M27X65*	10	55010.270.065	M33X140*	5	55010.330.140
M22X40/S=32*	25	55010.220.040	M27X70	3	55010.270.070	M33X150*	5	55010.330.150
M22X45/S=32*	25	55010.220.045	M27X75*	10	55010.270.075	M33X160*	5	55010.330.160
M22X50/S=32	10	55010.220.050	M27X80	3	55010.270.080	M33X180*	5	55010.330.180
M22X55/S=32*	25	55010.220.055	M27X85*	10	55010.270.085	M33X190*	5	55010.330.190
M22X60/S=32	10	55010.220.060	M27X90	3	55010.270.090			
M22X65/S=32*	25	55010.220.065	M27X95*	10	55010.270.095	M36X80	1	55010.360.080
M22X70/S=32	10	55010.220.070	M27X100	3	55010.270.100	M36X90	1	55010.360.090
M22X75/S=32*	25	55010.220.075	M27X110*	10	55010.270.110	M36X100	1	55010.360.100
M22X80/S=32	10	55010.220.080	M27X120	3	55010.270.120	M36X110	1	55010.360.110
M22X85/S=32*	25	55010.220.085	M27X130*	10	55010.270.130	M36X120	1	55010.360.120
M22X90/S=32*	25	55010.220.090	M27X140*	10	55010.270.140	M36X130*	5	55010.360.130
M22X100/S=32*	25	55010.220.100	M27X150*	10	55010.270.150	M36X140*	5	55010.360.140
M22X110/S=32*	20	55010.220.110	M27X160*	5	55010.270.160	M36X150*	5	55010.360.150
M22X120/S=32*	20	55010.220.120	M27X170*	5	55010.270.170	M36X160*	5	55010.360.160
M22X130/S=32*	20	55010.220.130	M27X180*	5	55010.270.180	M36X180*	5	55010.360.180
M22X140/S=32*	20	55010.220.140	M27X190*	5	55010.270.190	M36X190*	5	55010.360.190
M22X150/S=32*	10	55010.220.150				M36X200*	5	55010.360.200
M24X40	10	55010.240.040	M30X60	1	55010.300.060			
			M30X65*	10	55010.300.065			

* Rozmiary o średnicy > M24 i rozmiary o długości > 8xd mają minimalną klasę właściwości 50.

55320 Śruby z łbem sześciokątnym		R11A
Gwint	Metryczny	
Materiał	Stal nierdzewna A4	
Klasa	80	



d x L	☒	Kod artykułu	d x L	☒	Kod artykułu	d x L	☒	Kod artykułu
M4X8	100	53520.040.008	M5X20	100	53520.050.020	M6X20	100	53520.060.020
M4X10	100	53520.040.010	M5X22*	500	53520.050.022	M6X22*	200	53520.060.022
M4X12	100	53520.040.012	M5X25	100	53520.050.025	M6X25	100	53520.060.025
M4X14*	1000	53520.040.014	M5X30	100	53520.050.030	M6X30	100	53520.060.030
M4X16	100	53520.040.016	M5X35*	200	53520.050.035	M6X35*	200	53520.060.035
M4X18*	1000	53520.040.018	M5X40	100	53520.050.040	M6X40	100	53520.060.040
M4X20	100	53520.040.020	M5X45*	200	53520.050.045	M6X45*	100	53520.060.045
M4X22*	500	53520.040.022	M5X50*	200	53520.050.050	M6X50	100	53520.060.050
M4X25	100	53520.040.025	M5X55*	200	53520.050.055	M6X55*	100	53520.060.055
M4X35*	200	53520.040.035	M5X60*	200	53520.050.060	M6X60*	100	53520.060.060
M4X40*	200	53520.040.040	M5X70*	100	53520.050.070	M6X65*	100	53520.060.065
M4X45*	200	53520.040.045	M5X80*	100	53520.050.080	M6X70*	100	53520.060.070
M4X50*	200	53520.040.050	M5X85*	100	53520.050.085	M6X75*	100	53520.060.075
M4X60*	100	53520.040.060	M5X90*	100	53520.050.090	M6X80*	100	53520.060.080
M4X70*	100	53520.040.070	M5X100*	100	53520.050.100	M6X85*	100	53520.060.085
						M6X90*	100	53520.060.090
M5X8*	500	53520.050.008	M6X8*	500	53520.060.008	M6X100*	100	53520.060.100
M5X10	100	53520.050.010	M6X10	100	53520.060.010	M6X110*	100	53520.060.110
M5X12	100	53520.050.012	M6X12	100	53520.060.012	M6X120*	50	53520.060.120
M5X14*	500	53520.050.014	M6X14*	200	53520.060.014	M6X150*	50	53520.060.150
M5X16	100	53520.050.016	M6X16	100	53520.060.016			
M5X18*	500	53520.050.018	M6X18*	200	53520.060.018	M8X10*	500	53520.080.010

53520		Śruby z łbem sześciokątnym						←
d x L	☒	Kod artykułu	d x L	☒	Kod artykułu	d x L	☒	Kod artykułu
M8X12	50	53520.080.012	M12X35/S=19	25	53520.120.035	M16X100*	25	53520.160.100
M8X14*	200	53520.080.014	M12X40/S=19	25	53520.120.040	M16X110	25	53520.160.110
M8X16	50	53520.080.016	M12X45/S=19	100	53520.120.045	M16X120*	25	53520.160.120
M8X18*	200	53520.080.018	M12X50/S=19	25	53520.120.050	M16X130*	25	53520.160.130
M8X20	50	53520.080.020	M12X55/S=19	25	53520.120.055	M16X140*	25	53520.160.140
M8X22*	200	53520.080.022	M12X60/S=19	25	53520.120.060	M16X150*	25	53520.160.150
M8X25	50	53520.080.025	M12X65/S=19	25	53520.120.065	M16X160*	25	53520.160.160
M8X30	50	53520.080.030	M12X70/S=19	25	53520.120.070	M16X170*	25	53520.160.170
M8X35	50	53520.080.035	M12X75/S=19*	25	53520.120.075	M16X180*	10	53520.160.180
M8X40	50	53520.080.040	M12X80/S=19*	25	53520.120.080	M16X190*	10	53520.160.190
M8X45*	100	53520.080.045	M12X85/S=19*	25	53520.120.085	M16X200*	10	53520.160.200
M8X50	50	53520.080.050	M12X90/S=19*	25	53520.120.090			
M8X55*	100	53520.080.055	M12X95/S=19*	25	53520.120.095	M20X30*	25	53520.200.030
M8X60*	100	53520.080.060	M12X100/S=19*	25	53520.120.100	M20X35*	25	53520.200.035
M8X65*	100	53520.080.065	M12X110/S=19*	25	53520.120.110	M20X40	10	53520.200.040
M8X70*	50	53520.080.070	M12X120/S=19*	25	53520.120.120	M20X45*	25	53520.200.045
M8X75*	50	53520.080.075	M12X130/S=19*	25	53520.120.130	M20X50	10	53520.200.050
M8X80*	50	53520.080.080	M12X140/S=19*	25	53520.120.140	M20X55	10	53520.200.055
M8X85*	50	53520.080.085	M12X150/S=19*	25	53520.120.150	M20X60	10	53520.200.060
M8X90*	50	53520.080.090	M12X160/S=19*	10	53520.120.160	M20X65*	25	53520.200.065
M8X95*	50	53520.080.095	M12X170/S=19*	10	53520.120.170	M20X70*	25	53520.200.070
M8X100*	50	53520.080.100	M12X180/S=19*	10	53520.120.180	M20X75*	25	53520.200.075
M8X110*	50	53520.080.110	M12X190/S=19*	10	53520.120.190	M20X80	25	53520.200.080
M8X120*	50	53520.080.120	M12X200/S=19*	10	53520.120.200	M20X85*	25	53520.200.085
M8X130*	50	53520.080.130				M20X90	25	53520.200.090
M8X140*	50	53520.080.140	M14X20/S=22*	50	53520.140.020	M20X95*	25	53520.200.095
M8X150*	50	53520.080.150	M14X25/S=22*	50	53520.140.025	M20X100*	25	53520.200.100
M8X160*	50	53520.080.160	M14X30/S=22*	50	53520.140.030	M20X110*	25	53520.200.110
M8X170*	50	53520.080.170	M14X35/S=22*	50	53520.140.035	M20X120*	25	53520.200.120
			M14X40/S=22*	50	53520.140.040	M20X130*	25	53520.200.130
M10X12/S=17*	100	53520.100.012	M14X45/S=22*	50	53520.140.045	M20X140*	25	53520.200.140
M10X16/S=17	50	53520.100.016	M14X50/S=22	50	53520.140.050	M20X150*	25	53520.200.150
M10X20/S=17	50	53520.100.020	M14X55/S=22*	50	53520.140.055	M20X160*	25	53520.200.160
M10X25/S=17	50	53520.100.025	M14X60/S=22*	50	53520.140.060	M20X170*	25	53520.200.170
M10X30/S=17	50	53520.100.030	M14X65/S=22*	50	53520.140.065	M20X180*	20	53520.200.180
M10X35/S=17	50	53520.100.035	M14X70/S=22*	50	53520.140.070	M20X200*	20	53520.200.200
M10X40/S=17	50	53520.100.040	M14X75/S=22*	50	53520.140.075			
M10X45/S=17	100	53520.100.045	M14X80/S=22*	50	53520.140.080	M24X40*	10	53520.240.040
M10X50/S=17	50	53520.100.050	M14X90/S=22*	50	53520.140.090	M24X45*	10	53520.240.045
M10X55/S=17*	50	53520.100.055	M14X100/S=22*	50	53520.140.100	M24X50	10	53520.240.050
M10X60/S=17*	50	53520.100.060	M14X110/S=22*	25	53520.140.110	M24X55*	10	53520.240.055
M10X65/S=17*	50	53520.100.065	M14X120/S=22*	25	53520.140.120	M24X60	10	53520.240.060
M10X70/S=17*	100	53520.100.070	M14X130/S=22*	25	53520.140.130	M24X65*	10	53520.240.065
M10X75/S=17*	50	53520.100.075	M14X150/S=22*	25	53520.140.150	M24X70	10	53520.240.070
M10X80/S=17*	50	53520.100.080				M24X75*	10	53520.240.075
M10X85/S=17*	50	53520.100.085	M16X20*	25	53520.160.020	M24X80	10	53520.240.080
M10X90/S=17*	50	53520.100.090	M16X25*	25	53520.160.025	M24X85*	10	53520.240.085
M10X100/S=17*	50	53520.100.100	M16X30	25	53520.160.030	M24X90*	10	53520.240.090
M10X110/S=17*	50	53520.100.110	M16X35	25	53520.160.035	M24X95*	10	53520.240.095
M10X120/S=17*	50	53520.100.120	M16X40	25	53520.160.040	M24X100*	10	53520.240.100
M10X130/S=17*	50	53520.100.130	M16X45	25	53520.160.045	M24X110*	10	53520.240.110
M10X140/S=17*	50	53520.100.140	M16X50	25	53520.160.050	M24X120*	10	53520.240.120
M10X150/S=17*	50	53520.100.150	M16X55	25	53520.160.055	M24X130*	10	53520.240.130
M10X160/S=17*	25	53520.100.160	M16X60	25	53520.160.060	M24X140*	10	53520.240.140
M10X180/S=17*	25	53520.100.180	M16X65	25	53520.160.065	M24X150*	10	53520.240.150
M10X200/S=17*	25	53520.100.200	M16X70	25	53520.160.070	M24X160*	10	53520.240.160
			M16X75*	25	53520.160.075	M24X180*	5	53520.240.180
M12X16/S=19*	50	53520.120.016	M16X80*	25	53520.160.080	M24X190*	5	53520.240.190
M12X20/S=19	25	53520.120.020	M16X85*	25	53520.160.085	M24X200*	5	53520.240.200
M12X25/S=19	25	53520.120.025	M16X90*	25	53520.160.090			
M12X30/S=19	25	53520.120.030	M16X95*	25	53520.160.095			

53521		Śruby z łbem sześciokątnym						Q41A
Gwint	Metryczny							
Materiał	Stal nierdzewna A5							
Klasa	70							
								
d x L	☒	Kod artykułu	d x L	☒	Kod artykułu	d x L	☒	Kod artykułu
M8X20*	200	53521.080.020	M8X50*	100	53521.080.050	M10X30*	100	53521.100.030
M8X25*	100	53521.080.025				M10X40*	100	53521.100.040
M8X30*	100	53521.080.030	M10X20*	100	53521.100.020	M10X50*	50	53521.100.050
M8X40*	100	53521.080.040	M10X25*	100	53521.100.025			

45010 Śruby z łbem sześciokątnym		W01A	
Gwint	Metryczny		
Material	Aluminium P40		



d x L	☒	Kod artykułu	d x L	☒	Kod artykułu	d x L	☒	Kod artykułu
M6X10	100	45010.060.010				M8X60	100	45010.080.060
M6X16	100	45010.060.016	M8X16	100	45010.080.016	M8X70	100	45010.080.070
M6X25	100	45010.060.025	M8X25	100	45010.080.025			
M6X30	100	45010.060.030	M8X30	100	45010.080.030	M10X30/S=17	100	45010.100.030
M6X40	100	45010.060.040	M8X35	100	45010.080.035	M10X40/S=17	100	45010.100.040
M6X50	100	45010.060.050	M8X50	100	45010.080.050	M10X50/S=17	100	45010.100.050

45210 Śruby z łbem sześciokątnym		W01A	
Gwint	Metryczny		
Material	Aluminium P60		



d x L	☒	Kod artykułu	d x L	☒	Kod artykułu	d x L	☒	Kod artykułu
M5X16	200	45210.050.016	M8X20	100	45210.080.020	M12X40/S=19	50	45210.120.040
M5X25	200	45210.050.025	M8X25	100	45210.080.025	M12X50/S=19	50	45210.120.050
M5X30	200	45210.050.030	M8X30	100	45210.080.030	M12X60/S=19	50	45210.120.060
M5X40	200	45210.050.040	M8X40	100	45210.080.040	M12X70/S=19	25	45210.120.070
						M12X80/S=19	25	45210.120.080
M6X25	200	45210.060.025	M10X20/S=17	100	45210.100.020			
M6X30	200	45210.060.030	M10X30/S=17	100	45210.100.030	M16X30	25	45210.160.030
M6X40	200	45210.060.040	M10X35/S=17	100	45210.100.035	M16X35	25	45210.160.035
			M10X70/S=17	50	45210.100.070			
M8X15	100	45210.080.015						

45810 Śruby z łbem sześciokątnym		M11A	
Gwint	Metryczny		
Material	Kuprodur Cu5		
Klasa	60		



d x L	☒	Kod artykułu	d x L	☒	Kod artykułu	d x L	☒	Kod artykułu
M6X16	100	45810.060.016	M8X40	100	45810.080.040	M12X30/S=19	25	45810.120.030
M6X20	100	45810.060.020				M12X35/S=19	25	45810.120.035
M6X25	100	45810.060.025	M10X20/S=17	50	45810.100.020	M12X40/S=19	25	45810.120.040
M6X30	100	45810.060.030	M10X25/S=17	50	45810.100.025	M12X50/S=19	25	45810.120.050
			M10X30/S=17	50	45810.100.030	M12X60/S=19	25	45810.120.060
M8X20	100	45810.080.020	M10X35/S=17	50	45810.100.035			
M8X25	100	45810.080.025	M10X40/S=17	50	45810.100.040	M16X35	10	45810.160.035
M8X30	100	45810.080.030	M10X45/S=17	50	45810.100.045	M16X40	10	45810.160.040
M8X35	100	45810.080.035				M16X50	10	45810.160.050

46010 Śruby z łbem sześciokątnym		M01A	
Gwint	Metryczny		
Material	Mosiądz Cu2/Cu3		



d x L	☒	Kod artykułu	d x L	☒	Kod artykułu	d x L	☒	Kod artykułu
M4X10	200	46010.040.010	M5X40	200	46010.050.040	M8X20	100	46010.080.020
M4X12	200	46010.040.012				M8X25	100	46010.080.025
M4X16	200	46010.040.016	M6X10	200	46010.060.010	M8X30	100	46010.080.030
M4X20	200	46010.040.020	M6X12	200	46010.060.012	M8X35	100	46010.080.035
M4X25	200	46010.040.025	M6X16	200	46010.060.016	M8X40	100	46010.080.040
M4X30	200	46010.040.030	M6X20	200	46010.060.020	M8X45	100	46010.080.045
M4X50	200	46010.040.050	M6X25	200	46010.060.025	M8X50	100	46010.080.050
			M6X30	200	46010.060.030	M8X60	100	46010.080.060
M5X10	200	46010.050.010	M6X40	200	46010.060.040	M8X70	100	46010.080.070
M5X12	200	46010.050.012	M6X45	200	46010.060.045			
M5X16	200	46010.050.016	M6X50	200	46010.060.050	M10X16/S=17	100	46010.100.016
M5X20	200	46010.050.020	M6X60	100	46010.060.060	M10X20/S=17	50	46010.100.020
M5X25	200	46010.050.025				M10X25/S=17	50	46010.100.025
M5X30	200	46010.050.030	M8X16	100	46010.080.016	M10X30/S=17	50	46010.100.030

46010 Śruby z łbem sześciokątnym								
d x L	☒	Kod artykułu	d x L	☒	Kod artykułu	d x L	☒	Kod artykułu
M10X35/S=17	50	46010.100.035	M12X30/S=19	50	46010.120.030	M16X30	25	46010.160.030
M10X40/S=17	50	46010.100.040	M12X35/S=19	50	46010.120.035	M16X40	25	46010.160.040
M10X45/S=17	50	46010.100.045	M12X40/S=19	25	46010.120.040	M16X50	10	46010.160.050
M10X50/S=17	50	46010.100.050	M12X50/S=19	25	46010.120.050	M16X60	10	46010.160.060
M10X60/S=17	50	46010.100.060	M12X60/S=19	25	46010.120.060	M16X70	10	46010.160.070
M10X70/S=17	50	46010.100.070	M12X70/S=19	25	46010.120.070	M16X80	10	46010.160.080
M12X20/S=19	50	46010.120.020	M12X80/S=19	25	46010.120.080	M16X90	10	46010.160.090
M12X25/S=19	50	46010.120.025	M12X90/S=19	25	46010.120.090	M16X100	10	46010.160.100
			M12X100/S=19	25	46010.120.100			

46060 Śruby z łbem sześciokątnym								M01A
Gwint	Metryczny							
Materiał	Mosiądz Cu2/Cu3							
Obróbka powierzchni	Niklowane							

d x L	☒	Kod artykułu	d x L	☒	Kod artykułu	d x L	☒	Kod artykułu
M4X8	200	46060.040.008	M5X50	200	46060.050.050	M8X40	100	46060.080.040
M4X10	200	46060.040.010	M6X10	200	46060.060.010	M8X45	100	46060.080.045
M4X12	200	46060.040.012	M6X12	200	46060.060.012	M8X50	100	46060.080.050
M4X16	200	46060.040.016	M6X16	200	46060.060.016	M8X60	100	46060.080.060
M4X20	200	46060.040.020	M6X20	200	46060.060.020	M8X70	100	46060.080.070
M4X25	200	46060.040.025	M6X25	200	46060.060.025	M10X16/S=17	50	46060.100.016
M4X30	200	46060.040.030	M6X30	200	46060.060.030	M10X20/S=17	50	46060.100.020
M4X35	200	46060.040.035	M6X35	200	46060.060.035	M10X25/S=17	50	46060.100.025
M4X40	200	46060.040.040	M6X40	200	46060.060.040	M10X30/S=17	50	46060.100.030
M5X8	200	46060.050.008	M6X50	200	46060.060.050	M10X35/S=17	50	46060.100.035
M5X10	200	46060.050.010	M6X60	100	46060.060.060	M10X40/S=17	50	46060.100.040
M5X12	200	46060.050.012	M8X12	100	46060.080.012	M10X45/S=17	50	46060.100.045
M5X16	200	46060.050.016	M8X16	100	46060.080.016	M10X50/S=17	50	46060.100.050
M5X20	200	46060.050.020	M8X20	100	46060.080.020	M10X60/S=17	50	46060.100.060
M5X25	200	46060.050.025	M8X25	100	46060.080.025	M10X70/S=17	25	46060.100.070
M5X30	200	46060.050.030	M8X30	100	46060.080.030	M12X40/S=19	25	46060.120.040
M5X40	200	46060.050.040	M8X35	100	46060.080.035			
M5X45	200	46060.050.045						

45910 Śruby z łbem sześciokątnym								W01A
Gwint	Metryczny							
Materiał	Tytan Grade 2 ASTM							
Klasa	Gr.2							
			ISO	≈4017				
			DIN	≈933				
			NEN	≈1568				
			NF	≈E25-114				

d x L	☒	Kod artykułu	d x L	☒	Kod artykułu	d x L	☒	Kod artykułu
M6X20	10	45910.060.020	M8X30	10	45910.080.030	M10X20/S=17	10	45910.100.020
M6X30	10	45910.060.030	M8X40	10	45910.080.040	M10X30/S=17	10	45910.100.030
M6X40	10	45910.060.040	M8X50	10	45910.080.050	M10X40/S=17	5	45910.100.040
M8X20	10	45910.080.020				M10X50/S=17	5	45910.100.050

- tytan klasy 2 (numer materiału 3.7035) z wysokim procentem czystego tytanu zapewniają stabilność produktu i jego przydatność w bardzo korozyjnych środowiskach, w których nie zdają egzaminu inne materiały, np. stal nierdzewna.
- Tytan klasy 2 jest również odpowiedni do innych zastosowań z lekkim obciążeniem.

56100 Śruby z łbem sześciokątnym plastikowe								W02A
Gwint	Metryczny							
Materiał	Plastik Poliamid (nylon)							
Klasa	PA 6.6							
Kolor	Biały							
			ISO	≈4017				
			DIN	≈933				
			NEN	≈1568				
			ASME	≈B18.2.3.1M				
			NF	≈E25-114				

d x L	☒	Kod artykułu	d x L	☒	Kod artykułu	d x L	☒	Kod artykułu
M3X10	200	56100.030.010	M5X10	100	56100.050.010	M6X12	50	56100.060.012
M3X16	200	56100.030.016	M5X12	100	56100.050.012	M6X16	50	56100.060.016
M3X20	200	56100.030.020	M5X16	100	56100.050.016	M6X20	50	56100.060.020
M3X25	200	56100.030.025	M5X20	100	56100.050.020	M6X25	50	56100.060.025
M4X10	200	56100.040.010	M5X25	100	56100.050.025	M6X30	50	56100.060.030
M4X12	200	56100.040.012	M5X30	100	56100.050.030	M6X40	50	56100.060.040
M4X16	200	56100.040.016	M5X50	100	56100.050.050	M6X50	50	56100.060.050
M4X20	200	56100.040.020	M6X10	50	56100.060.010	M8X16	50	56100.080.016
M4X30	200	56100.040.030				M8X20	50	56100.080.020

56100 Śruby z łbem sześciokątnym plastikowe								
d x L	☒	Kod artykułu	d x L	☒	Kod artykułu	d x L	☒	Kod artykułu
M8X25	50	56100.080.025	M10X30/S=17	25	56100.100.030	M12X60/S=19	25	56100.120.060
M8X30	50	56100.080.030	M10X40/S=17	25	56100.100.040	M12X80/S=19	25	56100.120.080
M8X35	50	56100.080.035	M10X50/S=17	25	56100.100.050			
M8X40	50	56100.080.040	M10X60/S=17	25	56100.100.060	M16X30	25	56100.160.030
M8X50	50	56100.080.050				M16X40	25	56100.160.040
M8X60	50	56100.080.060	M12X20/S=19	25	56100.120.020	M16X50	25	56100.160.050
M8X70	50	56100.080.070	M12X30/S=19	25	56100.120.030	M16X60	25	56100.160.060
			M12X35/S=19	25	56100.120.035			
M10X20/S=17	25	56100.100.020	M12X40/S=19	25	56100.120.040	M20X35	1	56100.200.035
M10X25/S=17	25	56100.100.025	M12X50/S=19	25	56100.120.050			

Śruby z łbem sześciokątnym z nacięciem prostym

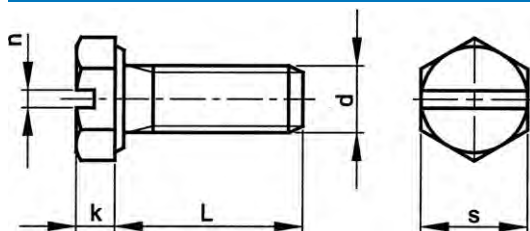

DIN ≈933
 ISO ≈4017
 NEN ≈1568
 ASME ≈B18.2.3.1M
 NF ≈E25-137

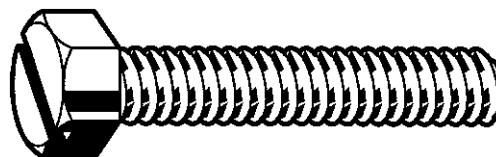

Informacje techniczne

d	k	n	P	s
M3	2	0.8	0.5	5.5
M4	2.8	1	0.7	7
M5	3.5	1.2	0.8	8
M6	4	1.6	1	10
M8	5.3	2	1.25	13
M10	6.4	2.5	1.5	17

• Nacięcie zgodne z DIN 962 SZ

Grupy katalogowe

Gwint	Gniazdo	Materiał	Klasa	Kod	Strona
M	Sześciokąt	St.St. A2	70	51012	1-35
M	Sześciokąt	St.St. A4	70	55012	1-36

51012 Śruby z łbem sześciokątnym z nacięciem prostym		Q01A
Gwint	Metryczny	
Materiał	Stal nierdzewna A2	
Klasa	70	

d x L	☒	Kod artykułu	d x L	☒	Kod artykułu	d x L	☒	Kod artykułu
M3X8*	1000	51012.030.008	M5X12*	500	51012.050.012	M6X20	200	51012.060.020
			M5X16	200	51012.050.016	M6X25	200	51012.060.025
M4X6*	500	51012.040.006	M5X18*	500	51012.050.018	M6X30	200	51012.060.030
M4X8	200	51012.040.008	M5X20	200	51012.050.020	M6X35	200	51012.060.035
M4X10	200	51012.040.010	M5X25	200	51012.050.025	M6X40	200	51012.060.040
M4X12	200	51012.040.012	M5X30	200	51012.050.030	M6X50*	200	51012.060.050
M4X16*	500	51012.040.016	M5X35*	500	51012.050.035			
M4X20	500	51012.040.020	M5X40*	500	51012.050.040	M8X16*	200	51012.080.016
M4X25*	500	51012.040.025				M8X20*	200	51012.080.020
M4X30*	500	51012.040.030	M6X10*	500	51012.060.010	M8X25*	100	51012.080.025
M4X60*	500	51012.040.060	M6X12	200	51012.060.012	M8X30*	100	51012.080.030
			M6X14*	500	51012.060.014	M8X40*	100	51012.080.040
M5X8*	500	51012.050.008	M6X16	200	51012.060.016			
M5X10*	500	51012.050.010	M6X18*	200	51012.060.018	M10X50*	200	51012.100.050

55012	Śruby z łbem sześciokątnym z nacięciem prostym		Q41A
Gwint	Metryczny		
Materiał	Stal nierdzewna A4		
Klasa	70		

d x L	☒	Kod artykułu	d x L	☒	Kod artykułu	d x L	☒	Kod artykułu
M5X10*	500	55012.050.010	M6X12*	500	55012.060.012	M6X30*	200	55012.060.030
M5X12*	500	55012.050.012	M6X14*	500	55012.060.014	M6X40*	200	55012.060.040
M5X16*	500	55012.050.016	M6X16*	200	55012.060.016			
M5X20*	500	55012.050.020	M6X18*	200	55012.060.018	M8X20*	200	55012.080.020
M5X25*	500	55012.050.025	M6X20*	200	55012.060.020	M8X25*	100	55012.080.025
M5X30*	500	55012.050.030	M6X22*	200	55012.060.022	M8X30*	100	55012.080.030
			M6X25*	200	55012.060.025			

Śruby z łbem sześciokątnym drobnozwojne

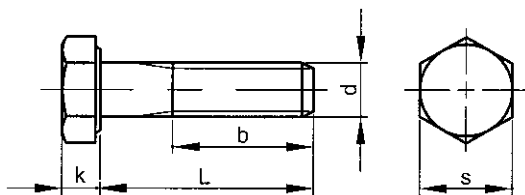

ISO 8765
DIN 960
NEN 1555
NF E25-152

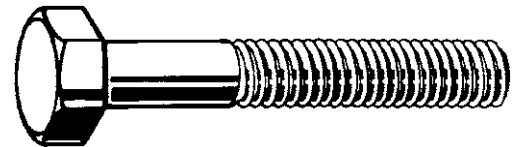

Informacje techniczne

d	b (min.): L≤125mm	b (min.): 125mm<L≤200mm	b (min.): L>200mm	k	s
M8	22	28	41	5.3	13
M10 (DIN)	26	32	45	6.4	17
M12 (DIN)	30	36	49	7.5	19
M14 (DIN)	34	40	53	8.8	22
M16	38	44	57	10	24
M18	42	48	61	11.5	27
M20	46	52	65	12.5	30
M24	54	60	73	15	36
M27	60	66	79	17	41
M30	66	72	85	18.7	46

Grupy katalogowe

Gwint	Gniazdo	Materiał	Klasa	Obróbka powierzchni	Kod	Strona
M.drob.	Sześciokąt	St	8.8		01060	1-36
M.b.drob.	Sześciokąt	St	8.8		01061	1-37
M.drob.	Sześciokąt	St	8.8	Ocynk. żłt. pas.	01240	1-37
M.b.drob.	Sześciokąt	St	8.8	Ocynk. żłt. pas.	01241	1-37
M.drob.	Sześciokąt	St	10.9		04160	1-38
M.b.drob.	Sześciokąt	St	10.9		04161	1-38

01060	Śruby z łbem sześciokątnym drobnozwojne		A09A
Gwint	Metryczny drobnozwojny		
Materiał	Stal		
Klasa	8.8		

d x P x L	☒	Kod artykułu	d x P x L	☒	Kod artykułu	d x P x L	☒	Kod artykułu
M8X1,00X35	200	01060.080.035	M10X1,25X80/S=17	100	01060.100.080	M12X1,50X100/S=19	50	01060.120.100
M8X1,00X40	200	01060.080.040	M10X1,25X90/S=17	100	01060.100.090	M12X1,50X120/S=19	100	01060.120.120
M8X1,00X50	200	01060.080.050	M10X1,25X100/S=17	100	01060.100.100			
M8X1,00X60	200	01060.080.060	M10X1,25X120/S=17	100	01060.100.120	M14X1,50X50/S=22	50	01060.140.050
M8X1,00X70	200	01060.080.070				M14X1,50X55/S=22	50	01060.140.055
M8X1,00X80	200	01060.080.080	M12X1,50X45/S=19	100	01060.120.045	M14X1,50X60/S=22	50	01060.140.060
M8X1,00X90	100	01060.080.090	M12X1,50X50/S=19	100	01060.120.050	M14X1,50X65/S=22	50	01060.140.065
			M12X1,50X55/S=19	100	01060.120.055	M14X1,50X70/S=22	50	01060.140.070
M10X1,25X35/S=17	100	01060.100.035	M12X1,50X60/S=19	100	01060.120.060	M14X1,50X75/S=22	50	01060.140.075
M10X1,25X40/S=17	100	01060.100.040	M12X1,50X65/S=19	50	01060.120.065	M14X1,50X80/S=22	50	01060.140.080
M10X1,25X50/S=17	100	01060.100.050	M12X1,50X70/S=19	50	01060.120.070	M14X1,50X90/S=22	50	01060.140.090
M10X1,25X60/S=17	100	01060.100.060	M12X1,50X75/S=19	50	01060.120.075	M14X1,50X100/S=22	50	01060.140.100
M10X1,25X70/S=17	100	01060.100.070	M12X1,50X80/S=19	50	01060.120.080			
M10X1,25X75/S=17	100	01060.100.075	M12X1,50X90/S=19	50	01060.120.090	M16X1,50X55	50	01060.160.055

01060 Śruby z łbem sześciokątnym drobnozwojne

d x P x L	☒	Kod artykułu	d x P x L	☒	Kod artykułu	d x P x L	☒	Kod artykułu
M16X1,50X60	50	01060.160.060	M16X1,50X90	25	01060.160.090	M16X1,50X140	25	01060.160.140
M16X1,50X65	25	01060.160.065	M16X1,50X100	25	01060.160.100	M16X1,50X150	25	01060.160.150
M16X1,50X70	25	01060.160.070	M16X1,50X110	25	01060.160.110			
M16X1,50X75	25	01060.160.075	M16X1,50X120	25	01060.160.120	M24X2,00X100	5	01060.240.100
M16X1,50X80	25	01060.160.080	M16X1,50X130	25	01060.160.130			

01061 Śruby z łbem sześciokątnym, extra drob
A09A

Gwint Metryczny bardzo drobnozwojny
Materiał Stal
Klasa 8.8

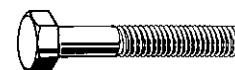

d x P x L	☒	Kod artykułu	d x P x L	☒	Kod artykułu	d x P x L	☒	Kod artykułu
M10X1,00X40/S=17	100	01061.100.040	M12X1,25X80/S=19	50	01061.120.080	M18X1,50X160	10	01061.180.160
M10X1,00X45/S=17	100	01061.100.045	M12X1,25X90/S=19	50	01061.120.090	M18X1,50X170	10	01061.180.170
M10X1,00X50/S=17	100	01061.100.050	M12X1,25X100/S=19	50	01061.120.100	M18X1,50X180	10	01061.180.180
M10X1,00X60/S=17	100	01061.100.060	M12X1,25X110/S=19	100	01061.120.110	M18X1,50X190	10	01061.180.190
M10X1,00X70/S=17	100	01061.100.070	M12X1,25X140/S=19	100	01061.120.140	M18X1,50X200	10	01061.180.200
M10X1,00X80/S=17	100	01061.100.080						
M10X1,00X90/S=17	100	01061.100.090	M18X1,50X70	25	01061.180.070	M20X1,50X70	25	01061.200.070
M10X1,00X100/S=17	100	01061.100.100	M18X1,50X80	25	01061.180.080	M20X1,50X80	25	01061.200.080
			M18X1,50X90	25	01061.180.090	M20X1,50X90	25	01061.200.090
M12X1,25X45/S=19	100	01061.120.045	M18X1,50X100	25	01061.180.100	M20X1,50X100	25	01061.200.100
M12X1,25X50/S=19	100	01061.120.050	M18X1,50X120	25	01061.180.120	M20X1,50X120	25	01061.200.120
M12X1,25X55/S=19	100	01061.120.055	M18X1,50X130	25	01061.180.130	M20X1,50X130	25	01061.200.130
M12X1,25X60/S=19	100	01061.120.060	M18X1,50X140	25	01061.180.140	M20X1,50X140	25	01061.200.140
M12X1,25X70/S=19	50	01061.120.070	M18X1,50X150	25	01061.180.150	M20X1,50X150	25	01061.200.150

01240 Śruby z łbem sześciokątnym drobnozwojne
A09A

Gwint Metryczny drobnozwojny
Materiał Stal
Klasa 8.8
Obróbka powierzchni Ocynkowane, po żółtej pasywacji

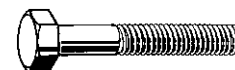

d x P x L	☒	Kod artykułu	d x P x L	☒	Kod artykułu	d x P x L	☒	Kod artykułu
M8X1,00X35	200	01240.080.035	M12X1,50X50/S=19	100	01240.120.050	M14X1,50X110/S=22	50	01240.140.110
M8X1,00X40	200	01240.080.040	M12X1,50X55/S=19	100	01240.120.055	M14X1,50X120/S=22	50	01240.140.120
M8X1,00X50	200	01240.080.050	M12X1,50X60/S=19	100	01240.120.060	M14X1,50X140/S=22	50	01240.140.140
M8X1,00X60	200	01240.080.060	M12X1,50X65/S=19	50	01240.120.065			
M8X1,00X70	200	01240.080.070	M12X1,50X70/S=19	50	01240.120.070	M16X1,50X55	50	01240.160.055
M8X1,00X80	200	01240.080.080	M12X1,50X80/S=19	50	01240.120.080	M16X1,50X60	50	01240.160.060
M8X1,00X90	100	01240.080.090	M12X1,50X90/S=19	50	01240.120.090	M16X1,50X65	25	01240.160.065
			M12X1,50X100/S=19	50	01240.120.100	M16X1,50X70	25	01240.160.070
M10X1,25X40/S=17	100	01240.100.040				M16X1,50X75	25	01240.160.075
M10X1,25X50/S=17	100	01240.100.050	M14X1,50X50/S=22	50	01240.140.050	M16X1,50X80	25	01240.160.080
M10X1,25X60/S=17	100	01240.100.060	M14X1,50X55/S=22	50	01240.140.055	M16X1,50X90	25	01240.160.090
M10X1,25X70/S=17	100	01240.100.070	M14X1,50X60/S=22	50	01240.140.060	M16X1,50X100	25	01240.160.100
M10X1,25X80/S=17	100	01240.100.080	M14X1,50X65/S=22	50	01240.140.065	M16X1,50X110	25	01240.160.110
M10X1,25X90/S=17	100	01240.100.090	M14X1,50X70/S=22	50	01240.140.070	M16X1,50X120	25	01240.160.120
M10X1,25X100/S=17	100	01240.100.100	M14X1,50X75/S=22	50	01240.140.075	M16X1,50X130	25	01240.160.130
M10X1,25X110/S=17	100	01240.100.110	M14X1,50X80/S=22	50	01240.140.080	M16X1,50X140	25	01240.160.140
			M14X1,50X90/S=22	50	01240.140.090	M16X1,50X150	25	01240.160.150
M12X1,50X45/S=19	100	01240.120.045	M14X1,50X100/S=22	50	01240.140.100			

01241 Śruby z łbem sześciokątnym, extra drob
A09A

Gwint Metryczny bardzo drobnozwojny
Materiał Stal
Klasa 8.8
Obróbka powierzchni Ocynkowane, po żółtej pasywacji

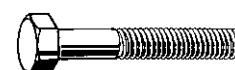

d x P x L	☒	Kod artykułu	d x P x L	☒	Kod artykułu	d x P x L	☒	Kod artykułu
M10X1,00X40/S=17	100	01241.100.040	M12X1,25X45/S=19	100	01241.120.045	M18X1,50X60	25	01241.180.060
M10X1,00X45/S=17	100	01241.100.045	M12X1,25X50/S=19	100	01241.120.050	M18X1,50X70	25	01241.180.070
M10X1,00X50/S=17	100	01241.100.050	M12X1,25X60/S=19	100	01241.120.060	M18X1,50X80	25	01241.180.080
M10X1,00X60/S=17	100	01241.100.060	M12X1,25X70/S=19	50	01241.120.070	M18X1,50X90	25	01241.180.090
M10X1,00X70/S=17	100	01241.100.070	M12X1,25X80/S=19	50	01241.120.080	M18X1,50X100	25	01241.180.100
M10X1,00X80/S=17	100	01241.100.080	M12X1,25X90/S=19	50	01241.120.090	M18X1,50X110	25	01241.180.110
M10X1,00X90/S=17	100	01241.100.090	M12X1,25X100/S=19	50	01241.120.100	M18X1,50X120	25	01241.180.120
M10X1,00X100/S=17	100	01241.100.100	M12X1,25X110/S=19	50	01241.120.110			
						M20X1,50X70	25	01241.200.070

01241 Śruby z łbem sześciokątnym, extra drob								
d x P x L	☒	Kod artykułu	d x P x L	☒	Kod artykułu	d x P x L	☒	Kod artykułu
M20X1,50X80	25	01241.200.080	M20X1,50X110	25	01241.200.110	M20X1,50X150	25	01241.200.150
M20X1,50X90	25	01241.200.090	M20X1,50X120	25	01241.200.120			
M20X1,50X100	25	01241.200.100	M20X1,50X140	25	01241.200.140			

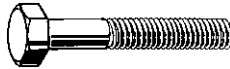
04160 Śruby z łbem sześciokątnym drobnozwojne								C02A
Gwint	Metryczny drobnozwojny							
Materiał	Stal							
Klasa	10.9							
								

d x P x L	☒	Kod artykułu	d x P x L	☒	Kod artykułu	d x P x L	☒	Kod artykułu
M8X1,00X35	200	04160.080.035	M12X1,50X120/S=19	25	04160.120.120	M16X1,50X120	25	04160.160.120
M8X1,00X40	200	04160.080.040				M16X1,50X130	20	04160.160.130
M8X1,00X50	200	04160.080.050	M14X1,50X50/S=22	50	04160.140.050	M16X1,50X140	20	04160.160.140
M8X1,00X60	200	04160.080.060	M14X1,50X60/S=22	50	04160.140.060	M16X1,50X150	20	04160.160.150
M8X1,00X70	100	04160.080.070	M14X1,50X65/S=22	50	04160.140.065	M16X1,50X160	20	04160.160.160
M8X1,00X80	100	04160.080.080	M14X1,50X70/S=22	50	04160.140.070			
M8X1,00X90	100	04160.080.090	M14X1,50X80/S=22	25	04160.140.080	M24X2,00X80	15	04160.240.080
			M14X1,50X90/S=22	25	04160.140.090	M24X2,00X90	15	04160.240.090
M10X1,25X45/S=17	100	04160.100.045	M14X1,50X100/S=22	25	04160.140.100	M24X2,00X100	10	04160.240.100
M10X1,25X50/S=17	100	04160.100.050	M14X1,50X110/S=22	25	04160.140.110	M24X2,00X110	10	04160.240.110
M10X1,25X60/S=17	100	04160.100.060	M14X1,50X120/S=22	25	04160.140.120	M24X2,00X120	10	04160.240.120
M10X1,25X70/S=17	100	04160.100.070				M24X2,00X130	10	04160.240.130
M10X1,25X80/S=17	100	04160.100.080	M16X1,50X50	25	04160.160.050	M24X2,00X140	10	04160.240.140
M10X1,25X90/S=17	100	04160.100.090	M16X1,50X55	25	04160.160.055	M24X2,00X150	10	04160.240.150
M10X1,25X100/S=17	100	04160.100.100	M16X1,50X60	25	04160.160.060	M24X2,00X160	10	04160.240.160
			M16X1,50X65	25	04160.160.065	M24X2,00X180	10	04160.240.180
M12X1,50X50/S=19	50	04160.120.050	M16X1,50X70	25	04160.160.070	M24X2,00X200	10	04160.240.200
M12X1,50X60/S=19	50	04160.120.060	M16X1,50X80	25	04160.160.080			
M12X1,50X70/S=19	50	04160.120.070	M16X1,50X90	25	04160.160.090	M27X2,00X190	10	04160.270.190
M12X1,50X80/S=19	50	04160.120.080	M16X1,50X100	25	04160.160.100			
M12X1,50X90/S=19	50	04160.120.090	M16X1,50X110	25	04160.160.110	M30X2,00X140	5	04160.300.140
M12X1,50X100/S=19	50	04160.120.100						

• Ostrzeżenie: cynkowanie elektrolityczne tych produktów może wywołać kruchość wodorową.

04161 Śruby z łbem sześciokątnym, bardzo drobnozwojne								C02A
Gwint	Metryczny bardzo drobnozwojny							
Materiał	Stal							
Klasa	10.9							
								

d x P x L	☒	Kod artykułu	d x P x L	☒	Kod artykułu	d x P x L	☒	Kod artykułu
M10X1,00X50/S=17	100	04161.100.050	M18X1,50X80	25	04161.180.080	M20X1,50X70	25	04161.200.070
M10X1,00X60/S=17	100	04161.100.060	M18X1,50X90	25	04161.180.090	M20X1,50X80	25	04161.200.080
M10X1,00X70/S=17	100	04161.100.070	M18X1,50X100	25	04161.180.100	M20X1,50X90	25	04161.200.090
M10X1,00X80/S=17	100	04161.100.080	M18X1,50X110	15	04161.180.110	M20X1,50X100	25	04161.200.100
M10X1,00X90/S=17	50	04161.100.090	M18X1,50X120	15	04161.180.120	M20X1,50X110	10	04161.200.110
M10X1,00X100/S=17	50	04161.100.100	M18X1,50X130	15	04161.180.130	M20X1,50X120	10	04161.200.120
			M18X1,50X140	10	04161.180.140	M20X1,50X130	10	04161.200.130
M18X1,50X60	25	04161.180.060	M18X1,50X150	10	04161.180.150	M20X1,50X140	10	04161.200.140
M18X1,50X70	25	04161.180.070	M18X1,50X160	10	04161.180.160	M20X1,50X150	10	04161.200.150
M18X1,50X75	25	04161.180.075				M20X1,50X160	10	04161.200.160

• Ostrzeżenie: cynkowanie elektrolityczne tych produktów może wywołać kruchość wodorową.

Śruby z łbem sześciokątnym drobnozwojne

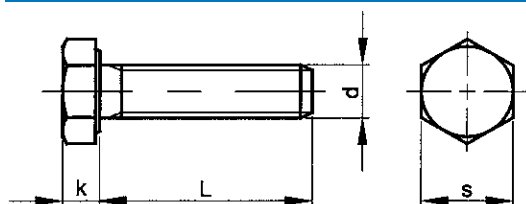

ISO 8676
DIN 961
NEN 1568
NF E25-151

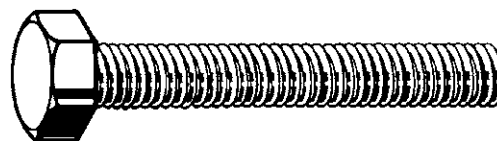

Informacje techniczne

d	k	s	d	k	s
M8	5.3	13	M18	11.5	27
M10 (DIN)	6.4	17	M20	12.5	30
M12 (DIN)	7.5	19	M22 (DIN)	14	32
M14 (DIN)	8.8	22	M24	15	36
M16	10	24			

Grupy katalogowe

Gwint	Gniazdo	Materiał	Klasa	Obróbka powierzchni	Kod	Strona
M.drob.	Sześciokąt	St	8.8		01070	1-39
M.b.drob.	Sześciokąt	St	8.8		01071	1-39
M.drob.	Sześciokąt	St	8.8	Ocynk. żłt. pas.	01250	1-40
M.b.drob.	Sześciokąt	St	8.8	Ocynk. żłt. pas.	01251	1-40
M.drob.	Sześciokąt	St	10.9		04170	1-40
M.b.drob.	Sześciokąt	St	10.9		04171	1-41

01070 Śruby z łbem sześciokątnym drobnozwojne

A09A

Gwint Metryczny drobnozwojny
Materiał Stal
Klasa 8.8



d x P x L	☒	Kod artykułu	d x P x L	☒	Kod artykułu	d x P x L	☒	Kod artykułu
M8X1,00X16	200	01070.080.016	M12X1,50X20/S=19	100	01070.120.020	M14X1,50X45/S=22	50	01070.140.045
M8X1,00X20	200	01070.080.020	M12X1,50X25/S=19	100	01070.120.025	M14X1,50X50/S=22	50	01070.140.050
M8X1,00X25	200	01070.080.025	M12X1,50X30/S=19	100	01070.120.030	M14X1,50X60/S=22	50	01070.140.060
M8X1,00X30	200	01070.080.030	M12X1,50X35/S=19	100	01070.120.035	M16X1,50X20	50	01070.160.020
M8X1,00X35	200	01070.080.035	M12X1,50X40/S=19	100	01070.120.040	M16X1,50X25	50	01070.160.025
M8X1,00X40	200	01070.080.040	M12X1,50X45/S=19	100	01070.120.045	M16X1,50X30	50	01070.160.030
M10X1,25X20/S=17	200	01070.100.020	M12X1,50X50/S=19	100	01070.120.050	M16X1,50X35	50	01070.160.035
M10X1,25X25/S=17	200	01070.100.025	M12X1,50X60/S=19	100	01070.120.060	M16X1,50X40	50	01070.160.040
M10X1,25X30/S=17	200	01070.100.030	M14X1,50X20/S=22	100	01070.140.020	M16X1,50X45	50	01070.160.045
M10X1,25X35/S=17	100	01070.100.035	M14X1,50X25/S=22	100	01070.140.025	M16X1,50X50	50	01070.160.050
M10X1,25X40/S=17	100	01070.100.040	M14X1,50X30/S=22	100	01070.140.030	M16X1,50X60	50	01070.160.060
M10X1,25X45/S=17	100	01070.100.045	M14X1,50X35/S=22	100	01070.140.035	M16X1,50X70	25	01070.160.070
M10X1,25X50/S=17	100	01070.100.050	M14X1,50X40/S=22	100	01070.140.040	M16X1,50X80	25	01070.160.080
M10X1,25X60/S=17	100	01070.100.060				M16X1,50X120	25	01070.160.120

01071 Śruby z łbem sześciokątnym, bardzo drobnozwojne

A09A

Gwint Metryczny bardzo drobnozwojny
Materiał Stal
Klasa 8.8



d x P x L	☒	Kod artykułu	d x P x L	☒	Kod artykułu	d x P x L	☒	Kod artykułu
M10X1,00X20/S=17	200	01071.100.020	M12X1,25X40/S=19	100	01071.120.040	M18X1,50X80	25	01071.180.080
M10X1,00X25/S=17	200	01071.100.025	M12X1,25X50/S=19	100	01071.120.050	M20X1,50X40	25	01071.200.040
M10X1,00X30/S=17	200	01071.100.030	M18X1,50X35	50	01071.180.035	M20X1,50X45	25	01071.200.045
M10X1,00X35/S=17	100	01071.100.035	M18X1,50X40	50	01071.180.040	M20X1,50X50	25	01071.200.050
M10X1,00X40/S=17	100	01071.100.040	M18X1,50X45	50	01071.180.045	M20X1,50X60	25	01071.200.060
M12X1,25X25/S=19	100	01071.120.025	M18X1,50X50	50	01071.180.050	M20X1,50X70	25	01071.200.070
M12X1,25X30/S=19	100	01071.120.030	M18X1,50X60	25	01071.180.060	M20X1,50X80	25	01071.200.080
M12X1,25X35/S=19	100	01071.120.035	M18X1,50X70	25	01071.180.070			

01250 Śruby z łbem sześciokątnym drobnozwojne		A09A
Gwint	Metryczny drobnozwojny	
Materiał	Stal	
Klasa	8.8	
Obróbka powierzchni	Ocynkowane, po żółtej pasywacji	

d x P x L	☒	Kod artykułu	d x P x L	☒	Kod artykułu	d x P x L	☒	Kod artykułu
M8X1,00X20	200	01250.080.020	M12X1,50X20/S=19	100	01250.120.020	M14X1,50X45/S=22	50	01250.140.045
M8X1,00X25	200	01250.080.025	M12X1,50X25/S=19	100	01250.120.025	M14X1,50X50/S=22	50	01250.140.050
M8X1,00X30	200	01250.080.030	M12X1,50X30/S=19	100	01250.120.030	M14X1,50X60/S=22	50	01250.140.060
M8X1,00X35	200	01250.080.035	M12X1,50X35/S=19	100	01250.120.035			
M8X1,00X40	200	01250.080.040	M12X1,50X40/S=19	100	01250.120.040	M16X1,50X20	50	01250.160.020
			M12X1,50X45/S=19	100	01250.120.045	M16X1,50X25	50	01250.160.025
M10X1,25X20/S=17	200	01250.100.020	M12X1,50X50/S=19	100	01250.120.050	M16X1,50X30	50	01250.160.030
M10X1,25X25/S=17	200	01250.100.025	M12X1,50X60/S=19	100	01250.120.060	M16X1,50X35	50	01250.160.035
M10X1,25X30/S=17	200	01250.100.030				M16X1,50X40	50	01250.160.040
M10X1,25X35/S=17	100	01250.100.035	M14X1,50X20/S=22	100	01250.140.020	M16X1,50X45	50	01250.160.045
M10X1,25X40/S=17	100	01250.100.040	M14X1,50X25/S=22	100	01250.140.025	M16X1,50X50	50	01250.160.050
M10X1,25X45/S=17	100	01250.100.045	M14X1,50X30/S=22	100	01250.140.030	M16X1,50X60	50	01250.160.060
M10X1,25X50/S=17	100	01250.100.050	M14X1,50X35/S=22	100	01250.140.035	M16X1,50X70	25	01250.160.070
			M14X1,50X40/S=22	100	01250.140.040			

01251 Śruby z łbem sześciokątnym, bardzo drobnozwojne		A09A
Gwint	Metryczny bardzo drobnozwojny	
Materiał	Stal	
Klasa	8.8	
Obróbka powierzchni	Ocynkowane, po żółtej pasywacji	

d x P x L	☒	Kod artykułu	d x P x L	☒	Kod artykułu	d x P x L	☒	Kod artykułu
M10X1,00X20/S=17	200	01251.100.020	M12X1,25X40/S=19	100	01251.120.040	M18X1,50X70	25	01251.180.070
M10X1,00X25/S=17	200	01251.100.025	M12X1,25X45/S=19	100	01251.120.045	M18X1,50X80	25	01251.180.080
M10X1,00X30/S=17	200	01251.100.030	M12X1,25X50/S=19	100	01251.120.050			
M10X1,00X35/S=17	100	01251.100.035				M20X1,50X40	25	01251.200.040
M10X1,00X40/S=17	100	01251.100.040	M18X1,50X35	50	01251.180.035	M20X1,50X50	25	01251.200.050
			M18X1,50X40	50	01251.180.040	M20X1,50X60	25	01251.200.060
M12X1,25X25/S=19	100	01251.120.025	M18X1,50X45	50	01251.180.045	M20X1,50X70	25	01251.200.070
M12X1,25X30/S=19	100	01251.120.030	M18X1,50X50	50	01251.180.050	M20X1,50X80	25	01251.200.080
M12X1,25X35/S=19	100	01251.120.035	M18X1,50X60	25	01251.180.060			

04170 Śruby z łbem sześciokątnym drobnozwojne		C02A
Gwint	Metryczny drobnozwojny	
Materiał	Stal	
Klasa	10.9	

d x P x L	☒	Kod artykułu	d x P x L	☒	Kod artykułu	d x P x L	☒	Kod artykułu
M8X1,00X20	200	04170.080.020	M12X1,50X25/S=19	100	04170.120.025	M16X1,50X30	50	04170.160.030
M8X1,00X25	200	04170.080.025	M12X1,50X30/S=19	100	04170.120.030	M16X1,50X35	50	04170.160.035
M8X1,00X30	200	04170.080.030	M12X1,50X35/S=19	100	04170.120.035	M16X1,50X40	50	04170.160.040
M8X1,00X35	200	04170.080.035	M12X1,50X40/S=19	100	04170.120.040	M16X1,50X45	50	04170.160.045
M8X1,00X40	200	04170.080.040				M16X1,50X50	25	04170.160.050
			M14X1,50X25/S=22	50	04170.140.025	M16X1,50X55	25	04170.160.055
M10X1,25X20/S=17	200	04170.100.020	M14X1,50X30/S=22	50	04170.140.030	M16X1,50X60	25	04170.160.060
M10X1,25X25/S=17	200	04170.100.025	M14X1,50X35/S=22	50	04170.140.035			
M10X1,25X30/S=17	100	04170.100.030	M14X1,50X40/S=22	50	04170.140.040	M24X2,00X45	25	04170.240.045
M10X1,25X35/S=17	100	04170.100.035	M14X1,50X45/S=22	50	04170.140.045	M24X2,00X50	25	04170.240.050
M10X1,25X40/S=17	100	04170.100.040	M14X1,50X50/S=22	50	04170.140.050	M24X2,00X60	25	04170.240.060
			M14X1,50X60/S=22	50	04170.140.060	M24X2,00X70	25	04170.240.070
M12X1,50X20/S=19	100	04170.120.020						

- Ostrzeżenie: cynkowanie elektrolityczne tych produktów może wywołać kruchość wodorową.

04171	Śruby z łbem sześciokątnym, bardzo drobnozwojne		C02A
Gwint	Metryczny bardzo drobnozwojny		
Materiał	Stal		
Klasa	10.9		

d x P x L	☒	Kod artykułu	d x P x L	☒	Kod artykułu	d x P x L	☒	Kod artykułu
M10X1,00X20/S=17	100	04171.100.020	M12X1,25X30/S=19	50	04171.120.030	M18X1,50X60	25	04171.180.060
M10X1,00X25/S=17	100	04171.100.025	M12X1,25X35/S=19	50	04171.120.035	M20X1,50X40	25	04171.200.040
M10X1,00X30/S=17	100	04171.100.030	M12X1,25X40/S=19	50	04171.120.040	M20X1,50X45	25	04171.200.045
M10X1,00X35/S=17	100	04171.100.035	M18X1,50X40	25	04171.180.040	M20X1,50X50	25	04171.200.050
M10X1,00X40/S=17	100	04171.100.040	M18X1,50X50	25	04171.180.050	M20X1,50X60	25	04171.200.060
M12X1,25X25/S=19	50	04171.120.025						

• Ostrzeżenie: cynkowanie elektrolityczne tych produktów może wywołać kruchość wodorową.

Śruby z łbem sześciokątnym UNC

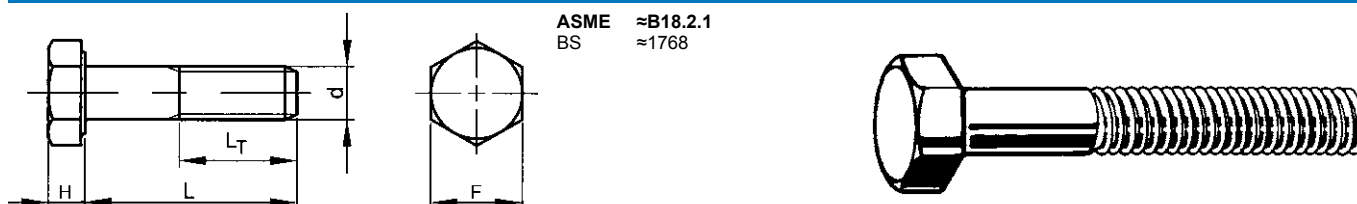

Informacje techniczne					
d	L _T (min.): L≤6 Inch	L _T (min.): L>6 Inch	F	H	Zwoje gwintu na cal
1/4	0.75	1	7/16	5/32	20
5/16	0.875	1.125	1/2	13/64	18
3/8	1	1.25	9/16	15/64	16
7/16	1.125	1.375	5/8	9/32	14
1/2	1.25	1.5	3/4	5/16	13
9/16	1.375	1.625	13/16	23/64	12
5/8	1.5	1.75	15/16	25/64	11
3/4	1.75	2	1.1/8	15/32	10
7/8	2	2.25	1.5/16	35/64	9
1 Inch	2.25	2.5	1.1/2	39/64	8
1.1/8	2.5	2.75	1.11/16	11/16	7
1.1/4	2.75	3	1.7/8	25/32	7
1.1/2	3.25	3.5	2.1/4	15/16	6

Grupy katalogowe

Gwint	Gniazdo	Materiał	Klasa	Obróbka powierzchni	Kod	Strona
UNC	Sześciokąt	St	Grade 2		U08200	1-41
UNC	Sześciokąt	St	Grade 2	Ocynk.	U08210	1-42
UNC	Sześciokąt	St	Grade 5		U01000	1-43
UNC	Sześciokąt	St	Grade 5	Ocynk.	U01200	1-44
UNC	Sześciokąt	St	Grade 8		U04104	1-46
UNC	Sześciokąt	St	Grade 8	Ocynk. żłt. pas.	U04100	1-47
UNC	Sześciokąt	St.St. A2 (AISI304/18-8)	F593		U51000	1-49
UNC	Sześciokąt	St.St. A4 (AISI316/18-10)	F593		U55000	1-50

U08200	Śruby z łbem sześciokątnym UNC		X01A
Gwint	Calowy, zunifikowany grubozwojny (UNC)		
Materiał	Stal		
Klasa	Grade 2		

d x L	☒	Kod artykułu	d x L	☒	Kod artykułu	d x L	☒	Kod artykułu
1/2-13X3/4 ft *	25	U08200.050.0075	1/2-13X2.1/4 *	10	U08200.050.0225	1/2-13X3.3/4 *	10	U08200.050.0375
1/2-13X1 Inch ft *	25	U08200.050.0100	1/2-13X2.1/2 *	10	U08200.050.0250	1/2-13X4 Inch *	5	U08200.050.0400
1/2-13X1.1/4 ft *	25	U08200.050.0125	1/2-13X2.3/4 *	10	U08200.050.0275	1/2-13X4.1/2 *	5	U08200.050.0450
1/2-13X1.1/2 *	25	U08200.050.0150	1/2-13X3 Inch *	10	U08200.050.0300	1/2-13X5 Inch *	5	U08200.050.0500
1/2-13X1.3/4 *	25	U08200.050.0175	1/2-13X3.1/4 *	10	U08200.050.0325	1/2-13X5.1/2 *	5	U08200.050.0550
1/2-13X2 Inch *	10	U08200.050.0200	1/2-13X3.1/2 *	10	U08200.050.0350	1/2-13X6 Inch *	5	U08200.050.0600

U08200		Śruby z łbem sześciokątnym UNC						←
d x L	☒	Kod artykułu	d x L	☒	Kod artykułu	d x L	☒	Kod artykułu
1/2-13X7 Inch *	5	U08200.050.0700	3/4-10X6 Inch *	5	U08200.075.0600	5/16-18X4 Inch *	25	U08200.031.0400
1/4-20X1/2 ft *	100	U08200.025.0050	3/8-16X1/2 ft *	50	U08200.037.0050	5/16-18X4.1/2 *	25	U08200.031.0450
1/4-20X5/8 ft *	100	U08200.025.0062	3/8-16X5/8 ft *	50	U08200.037.0062	5/16-18X5 Inch *	25	U08200.031.0500
1/4-20X3/4 ft *	100	U08200.025.0075	3/8-16X3/4 ft *	50	U08200.037.0075	5/16-18X5.1/2 *	25	U08200.031.0550
1/4-20X7/8 *	100	U08200.025.0087	3/8-16X7/8 ft *	50	U08200.037.0087	5/16-18X6 Inch *	25	U08200.031.0600
1/4-20X1 Inch *	100	U08200.025.0100	3/8-16X1 Inch ft *	50	U08200.037.0100	5/8-11X1 Inch ft *	10	U08200.062.0100
1/4-20X1.1/4 *	100	U08200.025.0125	3/8-16X1.1/4 *	50	U08200.037.0125	5/8-11X1.1/4 ft *	10	U08200.062.0125
1/4-20X1.1/2 *	100	U08200.025.0150	3/8-16X1.1/2 *	50	U08200.037.0150	5/8-11X1.1/2 ft *	10	U08200.062.0150
1/4-20X1.3/4 *	100	U08200.025.0175	3/8-16X1.3/4 *	50	U08200.037.0175	5/8-11X1.3/4 *	10	U08200.062.0175
1/4-20X2 Inch *	50	U08200.025.0200	3/8-16X2 Inch *	25	U08200.037.0200	5/8-11X2 Inch *	5	U08200.062.0200
1/4-20X2.1/4 *	50	U08200.025.0225	3/8-16X2.1/4 *	25	U08200.037.0225	5/8-11X2.1/4 *	5	U08200.062.0225
1/4-20X2.1/2 *	50	U08200.025.0250	3/8-16X2.1/2 *	25	U08200.037.0250	5/8-11X2.1/2 *	5	U08200.062.0250
1/4-20X2.3/4 *	50	U08200.025.0275	3/8-16X2.3/4 *	25	U08200.037.0275	5/8-11X2.3/4 *	5	U08200.062.0275
1/4-20X3 Inch *	50	U08200.025.0300	3/8-16X3 Inch *	25	U08200.037.0300	5/8-11X3 Inch *	5	U08200.062.0300
1/4-20X3.1/4 *	50	U08200.025.0325	3/8-16X3.1/4 *	25	U08200.037.0325	5/8-11X3.1/4 *	5	U08200.062.0325
1/4-20X3.1/2 *	50	U08200.025.0350	3/8-16X3.1/2 *	25	U08200.037.0350	5/8-11X3.1/2 *	5	U08200.062.0350
1/4-20X3.3/4 *	50	U08200.025.0375	3/8-16X3.3/4 *	25	U08200.037.0375	5/8-11X3.3/4 *	5	U08200.062.0375
1/4-20X4 Inch *	25	U08200.025.0400	3/8-16X4 Inch *	10	U08200.037.0400	5/8-11X4 Inch *	5	U08200.062.0400
1/4-20X4.1/2 *	25	U08200.025.0450	3/8-16X4.1/2 *	10	U08200.037.0450	5/8-11X4.1/2 *	5	U08200.062.0450
1/4-20X5 Inch *	25	U08200.025.0500	3/8-16X5 Inch *	10	U08200.037.0500	5/8-11X5 Inch *	5	U08200.062.0500
1/4-20X5.1/2 *	25	U08200.025.0550	3/8-16X5.1/2 *	10	U08200.037.0550	5/8-11X5.1/2 *	5	U08200.062.0550
1/4-20X6 Inch *	25	U08200.025.0600	3/8-16X6 Inch *	10	U08200.037.0600	5/8-11X6 Inch *	5	U08200.062.0600
3/4-10X1 Inch ft *	10	U08200.075.0100	5/16-18X1/2 ft *	100	U08200.031.0050	7/16-14X1 Inch ft *	25	U08200.043.0100
3/4-10X1.1/4 ft *	10	U08200.075.0125	5/16-18X5/8 ft *	100	U08200.031.0062	7/16-14X1.1/4 *	25	U08200.043.0125
3/4-10X1.1/2 ft *	10	U08200.075.0150	5/16-18X3/4 ft *	100	U08200.031.0075	7/16-14X1.1/2 *	25	U08200.043.0150
3/4-10X1.3/4 ft *	10	U08200.075.0175	5/16-18X7/8 ft *	100	U08200.031.0087	7/16-14X1.3/4 *	25	U08200.043.0175
3/4-10X2 Inch *	5	U08200.075.0200	5/16-18X1 Inch *	100	U08200.031.0100	7/16-14X2 Inch *	25	U08200.043.0200
3/4-10X2.1/4 *	5	U08200.075.0225	5/16-18X1.1/4 *	100	U08200.031.0125	7/16-14X2.1/4 *	10	U08200.043.0225
3/4-10X2.1/2 *	5	U08200.075.0250	5/16-18X1.1/2 *	100	U08200.031.0150	7/16-14X2.1/2 *	10	U08200.043.0250
3/4-10X2.3/4 *	5	U08200.075.0275	5/16-18X1.3/4 *	50	U08200.031.0175	7/16-14X2.3/4 *	10	U08200.043.0275
3/4-10X3 Inch *	5	U08200.075.0300	5/16-18X2 Inch *	50	U08200.031.0200	7/16-14X3 Inch *	10	U08200.043.0300
3/4-10X3.1/4 *	5	U08200.075.0325	5/16-18X2.1/4 *	50	U08200.031.0225	7/16-14X3.1/4 *	10	U08200.043.0325
3/4-10X3.1/2 *	5	U08200.075.0350	5/16-18X2.1/2 *	50	U08200.031.0250	7/16-14X3.1/2 *	10	U08200.043.0350
3/4-10X3.3/4 *	5	U08200.075.0375	5/16-18X2.3/4 *	50	U08200.031.0275	7/16-14X3.3/4 *	10	U08200.043.0375
3/4-10X4 Inch *	5	U08200.075.0400	5/16-18X3 Inch *	50	U08200.031.0300	7/16-14X4 Inch *	10	U08200.043.0400
3/4-10X4.1/2 *	5	U08200.075.0450	5/16-18X3.1/4 *	50	U08200.031.0325	7/16-14X4.1/2 *	10	U08200.043.0450
3/4-10X5 Inch *	5	U08200.075.0500	5/16-18X3.1/2 *	50	U08200.031.0350	7/16-14X4.1/2 *	10	U08200.043.0450
3/4-10X5.1/2 *	5	U08200.075.0550	5/16-18X3.3/4 *	25	U08200.031.0375	7/16-14X5 Inch *	10	U08200.043.0500

* ft = z pełnym gwintem

U08210		Śruby z łbem sześciokątnym UNC						X01A
Gwint	Całowy, zunifikowany grubozwojny (UNC)							
Materiał	Stal							
Klasa	Grade 2							
Obróbka powierzchni	Ocynkowane							

d x L	☒	Kod artykułu	d x L	☒	Kod artykułu	d x L	☒	Kod artykułu
1/4-20X1/2 ft *	100	U08210.025.0050	5/16-18X1.3/4*	50	U08210.031.0175	3/8-16X3.1/2*	25	U08210.037.0350
1/4-20X5/8 ft *	100	U08210.025.0062	5/16-18X2 Inch*	50	U08210.031.0200	3/8-16X3.3/4*	25	U08210.037.0375
1/4-20X3/4 ft *	100	U08210.025.0075	5/16-18X2.1/4 *	50	U08210.031.0225	3/8-16X4 Inch*	10	U08210.037.0400
1/4-20X7/8 *	100	U08210.025.0087	5/16-18X2.1/2 *	50	U08210.031.0250	3/8-16X4.1/2*	10	U08210.037.0450
1/4-20X1 Inch*	100	U08210.025.0100	5/16-18X2.3/4 *	50	U08210.031.0275	3/8-16X5 Inch*	10	U08210.037.0500
1/4-20X1.1/4*	100	U08210.025.0125	5/16-18X3 Inch*	50	U08210.031.0300	3/8-16X5.1/2*	10	U08210.037.0550
1/4-20X1.1/2*	100	U08210.025.0150	5/16-18X3.1/4*	50	U08210.031.0325	3/8-16X6 Inch*	10	U08210.037.0600
1/4-20X1.3/4*	100	U08210.025.0175	5/16-18X3.1/2*	50	U08210.031.0350			
1/4-20X2 Inch*	50	U08210.025.0200	5/16-18X3.3/4*	25	U08210.031.0375	7/16-14X3/4 ft*	25	U08210.043.0075
1/4-20X2.1/4*	50	U08210.025.0225	5/16-18X4 Inch*	25	U08210.031.0400	7/16-14X1 Inch ft*	25	U08210.043.0100
1/4-20X2.1/2*	50	U08210.025.0250	5/16-18X4.1/2*	25	U08210.031.0450	7/16-14X1.1/4*	25	U08210.043.0125
1/4-20X2.3/4*	50	U08210.025.0275	5/16-18X5 Inch*	25	U08210.031.0500	7/16-14X1.1/2*	25	U08210.043.0150
1/4-20X3 Inch*	50	U08210.025.0300	5/16-18X5.1/2*	25	U08210.031.0550	7/16-14X1.3/4*	25	U08210.043.0175
1/4-20X3.1/4*	50	U08210.025.0325	5/16-18X6 Inch*	25	U08210.031.0600	7/16-14X2 Inch*	25	U08210.043.0200
1/4-20X3.1/2*	50	U08210.025.0350				7/16-14X2.1/4*	10	U08210.043.0225
1/4-20X3.3/4*	50	U08210.025.0375	3/8-16X1/2 ft*	50	U08210.037.0050	7/16-14X2.1/2*	10	U08210.043.0250
1/4-20X4 Inch*	25	U08210.025.0400	3/8-16X5/8 ft*	50	U08210.037.0062	7/16-14X2.3/4*	10	U08210.043.0275
1/4-20X4.1/2*	25	U08210.025.0450	3/8-16X3/4 ft*	50	U08210.037.0075	7/16-14X3 Inch*	10	U08210.043.0300
1/4-20X5 Inch*	25	U08210.025.0500	3/8-16X7/8 ft*	50	U08210.037.0087	7/16-14X3.1/2*	10	U08210.043.0350
1/4-20X5.1/2*	25	U08210.025.0550	3/8-16X1 Inch ft*	50	U08210.037.0100	7/16-14X3.1/2*	10	U08210.043.0400
1/4-20X6 Inch*	25	U08210.025.0600	3/8-16X1.1/4*	50	U08210.037.0125	7/16-14X4.1/2*	10	U08210.043.0450
			3/8-16X1.1/2*	50	U08210.037.0150	7/16-14X5 Inch*	10	U08210.043.0500
5/16-18X1/2 ft*	100	U08210.031.0050	3/8-16X1.3/4*	50	U08210.037.0175	7/16-14X5.1/2*	10	U08210.043.0550
5/16-18X5/8 ft*	100	U08210.031.0062	3/8-16X2 Inch*	25	U08210.037.0200	7/16-14X6 Inch*	5	U08210.043.0600
5/16-18X3/4 ft*	100	U08210.031.0075	3/8-16X2.1/4*	25	U08210.037.0225			
5/16-18X7/8 ft*	100	U08210.031.0087	3/8-16X2.1/2*	25	U08210.037.0250	1/2-13X3/4 ft*	25	U08210.050.0075
5/16-18X1 Inch*	100	U08210.031.0100	3/8-16X2.3/4*	25	U08210.037.0275	1/2-13X1 Inch ft*	25	U08210.050.0100
5/16-18X1.1/4*	100	U08210.031.0125	3/8-16X3 Inch*	25	U08210.037.0300	1/2-13X1.1/4 ft*	25	U08210.050.0125
5/16-18X1.1/2*	100	U08210.031.0150	3/8-16X3.1/4*	25	U08210.037.0325	1/2-13X1.1/2*	25	U08210.050.0150

U08210 Śruby z łbem sześciokątnym UNC								
d x L	☒	Kod artykułu	d x L	☒	Kod artykułu	d x L	☒	Kod artykułu
1/2-13X1.3/4*	25	U08210.050.0175	5/8-11X1.1/2 ft*	10	U08210.062.0150	3/4-10X1.1/4 ft*	10	U08210.075.0125
1/2-13X2 Inch*	10	U08210.050.0200	5/8-11X1.3/4*	10	U08210.062.0175	3/4-10X1.1/2 ft*	10	U08210.075.0150
1/2-13X2.1/4*	10	U08210.050.0225	5/8-11X2 Inch*	5	U08210.062.0200	3/4-10X1.3/4 ft*	10	U08210.075.0175
1/2-13X2.1/2*	10	U08210.050.0250	5/8-11X2.1/4*	5	U08210.062.0225	3/4-10X2 Inch*	5	U08210.075.0200
1/2-13X2.3/4*	10	U08210.050.0275	5/8-11X2.1/2*	5	U08210.062.0250	3/4-10X2.1/4*	5	U08210.075.0225
1/2-13X3 Inch*	10	U08210.050.0300	5/8-11X2.3/4*	5	U08210.062.0275	3/4-10X2.1/2*	5	U08210.075.0250
1/2-13X3.1/4*	10	U08210.050.0325	5/8-11X3 Inch*	5	U08210.062.0300	3/4-10X2.3/4*	5	U08210.075.0275
1/2-13X3.1/2*	10	U08210.050.0350	5/8-11X3.1/4*	5	U08210.062.0325	3/4-10X3 Inch*	5	U08210.075.0300
1/2-13X3.3/4*	10	U08210.050.0375	5/8-11X3.1/2*	5	U08210.062.0350	3/4-10X3.1/4*	5	U08210.075.0325
1/2-13X4 Inch*	5	U08210.050.0400	5/8-11X3.3/4*	5	U08210.062.0375	3/4-10X3.1/2*	5	U08210.075.0350
1/2-13X4.1/2*	5	U08210.050.0450	5/8-11X4 Inch*	5	U08210.062.0400	3/4-10X3.3/4*	5	U08210.075.0375
1/2-13X5 Inch*	5	U08210.050.0500	5/8-11X4.1/2*	5	U08210.062.0450	3/4-10X4 Inch*	5	U08210.075.0400
1/2-13X5.1/2*	5	U08210.050.0550	5/8-11X5 Inch*	5	U08210.062.0500	3/4-10X4.1/2*	5	U08210.075.0450
1/2-13X6 Inch*	5	U08210.050.0600	5/8-11X5.1/2*	5	U08210.062.0550	3/4-10X5 Inch*	5	U08210.075.0500
			5/8-11X6 Inch*	5	U08210.062.0600	3/4-10X5.1/2*	5	U08210.075.0550
5/8-11X1 Inch ft*	10	U08210.062.0100				3/4-10X6 Inch*	5	U08210.075.0600
5/8-11X1.1/4 ft*	10	U08210.062.0125	3/4-10X1 Inch ft*	10	U08210.075.0100			

* ft = z pełnym gwintem

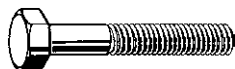
U01000 Śruby z łbem sześciokątnym UNC		X01A
Gwint	Całowy, zunifikowany grubozwojny (UNC)	
Materiał	Stal	
Klasa	Grade 5	



d x L	☒	Kod artykułu	d x L	☒	Kod artykułu	d x L	☒	Kod artykułu
1/4-20X1/2 ft*	100	U01000.025.0050	3/8-16X1/2 ft*	50	U01000.037.0050	7/16-14X7 Inch*	5	U01000.043.0700
1/4-20X5/8 ft*	100	U01000.025.0062	3/8-16X5/8 ft*	50	U01000.037.0062	7/16-14X8 Inch*	5	U01000.043.0800
1/4-20X3/4 ft*	100	U01000.025.0075	3/8-16X3/4 ft*	50	U01000.037.0075	7/16-14X9 Inch*	5	U01000.043.0900
1/4-20X7/8*	100	U01000.025.0087	3/8-16X7/8 ft*	50	U01000.037.0087	7/16-14X10 Inch*	5	U01000.043.1000
1/4-20X1 Inch*	100	U01000.025.0100	3/8-16X1 Inch ft*	50	U01000.037.0100	7/16-14X12 Inch*	5	U01000.043.1200
1/4-20X1.1/4*	100	U01000.025.0125	3/8-16X1.1/4*	50	U01000.037.0125			
1/4-20X1.3/8*	100	U01000.025.0137	3/8-16X1.1/2*	50	U01000.037.0150	1/2-13X3/4 ft*	25	U01000.050.0075
1/4-20X1.1/2*	100	U01000.025.0150	3/8-16X1.3/4*	50	U01000.037.0175	1/2-13X7/8 ft*	25	U01000.050.0087
1/4-20X1.5/8*	100	U01000.025.0162	3/8-16X2 Inch*	25	U01000.037.0200	1/2-13X1 Inch ft*	25	U01000.050.0100
1/4-20X1.3/4*	100	U01000.025.0175	3/8-16X2.1/4*	25	U01000.037.0225	1/2-13X1.1/4 ft*	25	U01000.050.0125
1/4-20X2 Inch*	50	U01000.025.0200	3/8-16X2.1/2*	25	U01000.037.0250	1/2-13X1.1/2*	25	U01000.050.0150
1/4-20X2.1/4*	50	U01000.025.0225	3/8-16X2.3/4*	25	U01000.037.0275	1/2-13X1.3/4*	25	U01000.050.0175
1/4-20X2.1/2*	50	U01000.025.0250	3/8-16X3 Inch*	25	U01000.037.0300	1/2-13X2 Inch*	10	U01000.050.0200
1/4-20X2.3/4*	50	U01000.025.0275	3/8-16X3.1/4*	25	U01000.037.0325	1/2-13X2.1/4*	10	U01000.050.0225
1/4-20X3 Inch*	50	U01000.025.0300	3/8-16X3.1/2*	25	U01000.037.0350	1/2-13X2.1/2*	10	U01000.050.0250
1/4-20X3.1/4*	50	U01000.025.0325	3/8-16X3.3/4*	25	U01000.037.0375	1/2-13X2.3/4*	10	U01000.050.0275
1/4-20X3.1/2*	50	U01000.025.0350	3/8-16X4 Inch*	10	U01000.037.0400	1/2-13X3 Inch*	10	U01000.050.0300
1/4-20X3.3/4*	50	U01000.025.0375	3/8-16X4.1/4*	10	U01000.037.0425	1/2-13X3.1/4*	10	U01000.050.0325
1/4-20X4 Inch*	25	U01000.025.0400	3/8-16X4.1/2*	10	U01000.037.0450	1/2-13X3.1/2*	10	U01000.050.0350
1/4-20X4.1/4*	25	U01000.025.0425	3/8-16X4.3/4*	10	U01000.037.0475	1/2-13X3.3/4*	10	U01000.050.0375
1/4-20X4.1/2*	25	U01000.025.0450	3/8-16X5 Inch*	10	U01000.037.0500	1/2-13X4 Inch*	5	U01000.050.0400
1/4-20X5 Inch*	25	U01000.025.0500	3/8-16X5.1/2*	10	U01000.037.0550	1/2-13X4.1/4*	5	U01000.050.0425
1/4-20X5.1/2*	25	U01000.025.0550	3/8-16X5.3/4*	10	U01000.037.0575	1/2-13X4.1/2*	5	U01000.050.0450
1/4-20X6 Inch*	25	U01000.025.0600	3/8-16X6 Inch*	10	U01000.037.0600	1/2-13X4.3/4*	5	U01000.050.0475
			3/8-16X6.1/2*	10	U01000.037.0650	1/2-13X5 Inch*	5	U01000.050.0500
5/16-18X1/2 ft*	100	U01000.031.0050	3/8-16X7 Inch*	10	U01000.037.0700	1/2-13X5.1/4*	5	U01000.050.0525
5/16-18X5/8 ft*	100	U01000.031.0062	3/8-16X8 Inch*	5	U01000.037.0800	1/2-13X5.1/2*	5	U01000.050.0550
5/16-18X3/4 ft*	100	U01000.031.0075	3/8-16X8.1/2*	5	U01000.037.0850	1/2-13X6 Inch*	5	U01000.050.0600
5/16-18X7/8 ft*	100	U01000.031.0087	3/8-16X9 Inch*	5	U01000.037.0900	1/2-13X6.1/2*	5	U01000.050.0650
5/16-18X1 Inch*	100	U01000.031.0100	3/8-16X10 Inch*	5	U01000.037.1000	1/2-13X7 Inch*	5	U01000.050.0700
5/16-18X1.1/4*	100	U01000.031.0125	3/8-16X12 Inch*	5	U01000.037.1200	1/2-13X7.1/2*	5	U01000.050.0750
5/16-18X1.3/8*	100	U01000.031.0137				1/2-13X8 Inch*	5	U01000.050.0800
5/16-18X1.1/2*	100	U01000.031.0150	7/16-14X3/4 ft*	25	U01000.043.0075	1/2-13X8.1/2*	5	U01000.050.0850
5/16-18X1.5/8*	100	U01000.031.0162	7/16-14X7/8 ft*	25	U01000.043.0087	1/2-13X9 Inch*	5	U01000.050.0900
5/16-18X1.3/4*	50	U01000.031.0175	7/16-14X1 Inch ft*	25	U01000.043.0100	1/2-13X9.1/2*	5	U01000.050.0950
5/16-18X2 Inch*	50	U01000.031.0200	7/16-14X1.1/4*	25	U01000.043.0125	1/2-13X10 Inch*	5	U01000.050.1000
5/16-18X2.1/4*	50	U01000.031.0225	7/16-14X1.1/2*	25	U01000.043.0150	1/2-13X11 Inch*	5	U01000.050.1100
5/16-18X2.1/2*	50	U01000.031.0250	7/16-14X1.3/4*	25	U01000.043.0175	1/2-13X12 Inch*	5	U01000.050.1200
5/16-18X2.3/4*	50	U01000.031.0275	7/16-14X2 Inch*	25	U01000.043.0200			
5/16-18X3 Inch*	50	U01000.031.0300	7/16-14X2.1/4*	10	U01000.043.0225	9/16-12X1 Inch ft*	25	U01000.056.0100
5/16-18X3.1/4*	50	U01000.031.0325	7/16-14X2.1/2*	10	U01000.043.0250	9/16-12X1.1/4 ft*	25	U01000.056.0125
5/16-18X3.1/2*	50	U01000.031.0350	7/16-14X2.3/4*	10	U01000.043.0275	9/16-12X1.1/2*	25	U01000.056.0150
5/16-18X3.3/4*	25	U01000.031.0375	7/16-14X3 Inch*	10	U01000.043.0300	9/16-12X1.3/4*	10	U01000.056.0175
5/16-18X4 Inch*	25	U01000.031.0400	7/16-14X3.1/4*	10	U01000.043.0325	9/16-12X2 Inch*	10	U01000.056.0200
5/16-18X4.1/4*	25	U01000.031.0425	7/16-14X3.1/2*	10	U01000.043.0350	9/16-12X2.1/4*	10	U01000.056.0225
5/16-18X4.1/2*	25	U01000.031.0450	7/16-14X3.3/4*	10	U01000.043.0375	9/16-12X2.1/2*	10	U01000.056.0250
5/16-18X5 Inch*	25	U01000.031.0500	7/16-14X4 Inch*	10	U01000.043.0400	9/16-12X2.3/4*	10	U01000.056.0275
5/16-18X5.1/2*	25	U01000.031.0550	7/16-14X4.1/2*	10	U01000.043.0450	9/16-12X3 Inch*	10	U01000.056.0300
5/16-18X6 Inch*	25	U01000.031.0600	7/16-14X5 Inch*	10	U01000.043.0500	9/16-12X3.1/4*	10	U01000.056.0325
5/16-18X7 Inch*	10	U01000.031.0700	7/16-14X5.1/2*	10	U01000.043.0550	9/16-12X3.1/2*	10	U01000.056.0350
5/16-18X8 Inch*	5	U01000.031.0800	7/16-14X6 Inch*	5	U01000.043.0600	9/16-12X3.3/4*	10	U01000.056.0375
			7/16-14X6.1/2*	5	U01000.043.0650	9/16-12X4 Inch*	5	U01000.056.0400

U01000 Śruby z łbem sześciokątnym UNC								
d x L	☒	Kod artykułu	d x L	☒	Kod artykułu	d x L	☒	Kod artykułu
9/16-12X4.1/2*	5	U01000.056.0450	3/4-10X5.1/2*	5	U01000.075.0550	1.-8X8 Inch*	1	U01000.100.0800
9/16-12X5 Inch*	5	U01000.056.0500	3/4-10X6 Inch*	5	U01000.075.0600	1.-8X8.1/2*	1	U01000.100.0850
9/16-12X5.1/2*	5	U01000.056.0550	3/4-10X6.1/2*	1	U01000.075.0650	1.-8X9 Inch*	1	U01000.100.0900
9/16-12X6 Inch*	5	U01000.056.0600	3/4-10X7 Inch*	1	U01000.075.0700	1.-8X9.1/2*	1	U01000.100.0950
			3/4-10X7.1/2*	1	U01000.075.0750	1.-8X10 Inch*	1	U01000.100.1000
5/8-11X1 Inch ft*	10	U01000.062.0100	3/4-10X8 Inch*	1	U01000.075.0800	1.-8X12 Inch*	1	U01000.100.1200
5/8-11X1.1/4 ft*	10	U01000.062.0125	3/4-10X8.1/2*	1	U01000.075.0850			
5/8-11X1.1/2 ft*	10	U01000.062.0150	3/4-10X9 Inch*	1	U01000.075.0900	1.1/8-7X2. ft*	1	U01000.112.0200
5/8-11X1.3/4*	10	U01000.062.0175	3/4-10X9.1/2*	1	U01000.075.0950	1.1/8-7X2.1/2 ft*	1	U01000.112.0250
5/8-11X2 Inch*	5	U01000.062.0200	3/4-10X10 Inch*	1	U01000.075.1000	1.1/8-7X3 Inch*	1	U01000.112.0300
5/8-11X2.1/4*	5	U01000.062.0225	3/4-10X11 Inch*	1	U01000.075.1100	1.1/8-7X3.1/2*	1	U01000.112.0350
5/8-11X2.1/2*	5	U01000.062.0250	3/4-10X12 Inch*	1	U01000.075.1200	1.1/8-7X4 Inch*	1	U01000.112.0400
5/8-11X2.3/4*	5	U01000.062.0275	3/4-10X14 Inch*	1	U01000.075.1400	1.1/8-7X4.1/2*	1	U01000.112.0450
5/8-11X3 Inch*	5	U01000.062.0300				1.1/8-7X5 Inch*	1	U01000.112.0500
5/8-11X3.1/4*	5	U01000.062.0325	7/8-9X1.1/2 ft*	5	U01000.087.0150	1.1/8-7X5.1/2*	1	U01000.112.0550
5/8-11X3.1/2*	5	U01000.062.0350	7/8-9X1.3/4 ft*	5	U01000.087.0175	1.1/8-7X6 Inch*	1	U01000.112.0600
5/8-11X3.3/4*	5	U01000.062.0375	7/8-9X2 Inch ft*	5	U01000.087.0200	1.1/8-7X6.1/2*	1	U01000.112.0650
5/8-11X4 Inch*	5	U01000.062.0400	7/8-9X2.1/4*	5	U01000.087.0225	1.1/8-7X7 Inch*	1	U01000.112.0700
5/8-11X4.1/4*	5	U01000.062.0425	7/8-9X2.1/2*	5	U01000.087.0250	1.1/8-7X7.1/2*	1	U01000.112.0750
5/8-11X4.1/2*	5	U01000.062.0450	7/8-9X2.3/4*	5	U01000.087.0275	1.1/8-7X8 Inch*	1	U01000.112.0800
5/8-11X4.3/4*	5	U01000.062.0475	7/8-9X3 Inch*	5	U01000.087.0300	1.1/8-7X8.1/2*	1	U01000.112.0850
5/8-11X5 Inch*	5	U01000.062.0500	7/8-9X3.1/4*	5	U01000.087.0325	1.1/8-7X9 Inch*	1	U01000.112.0900
5/8-11X5.1/2*	5	U01000.062.0550	7/8-9X3.1/2*	5	U01000.087.0350	1.1/8-7X10 Inch*	1	U01000.112.1000
5/8-11X6 Inch*	5	U01000.062.0600	7/8-9X3.3/4*	5	U01000.087.0375			
5/8-11X6.1/2*	5	U01000.062.0650	7/8-9X4 Inch*	5	U01000.087.0400	1.1/4-7X2 Inch ft*	1	U01000.125.0200
5/8-11X7 Inch*	5	U01000.062.0700	7/8-9X4.1/4*	5	U01000.087.0425	1.1/4-7X2.1/2 ft*	1	U01000.125.0250
5/8-11X7.1/2*	5	U01000.062.0750	7/8-9X4.1/2*	5	U01000.087.0450	1.1/4-7X3 Inch*	1	U01000.125.0300
5/8-11X8 Inch*	5	U01000.062.0800	7/8-9X5 Inch*	5	U01000.087.0500	1.1/4-7X3.1/2*	1	U01000.125.0350
5/8-11X8.1/2*	5	U01000.062.0850	7/8-9X5.1/2*	5	U01000.087.0550	1.1/4-7X4 Inch*	1	U01000.125.0400
5/8-11X9 Inch*	5	U01000.062.0900	7/8-9X6 Inch*	1	U01000.087.0600	1.1/4-7X4.1/2*	1	U01000.125.0450
5/8-11X9.1/2*	5	U01000.062.0950	7/8-9X6.1/2*	1	U01000.087.0650	1.1/4-7X5 Inch*	1	U01000.125.0500
5/8-11X10 Inch*	5	U01000.062.1000	7/8-9X7 Inch*	1	U01000.087.0700	1.1/4-7X5.1/2*	1	U01000.125.0550
5/8-11X11 Inch*	5	U01000.062.1100	7/8-9X8 Inch*	1	U01000.087.0800	1.1/4-7X6 Inch*	1	U01000.125.0600
5/8-11X12 Inch*	5	U01000.062.1200	7/8-9X8.1/2*	1	U01000.087.0850	1.1/4-7X6.1/2*	1	U01000.125.0650
5/8-11X13 Inch*	1	U01000.062.1300	7/8-9X9 Inch*	1	U01000.087.0900	1.1/4-7X7 Inch*	1	U01000.125.0700
5/8-11X14 Inch*	1	U01000.062.1400	7/8-9X9.1/2*	1	U01000.087.0950	1.1/4-7X7.1/2*	1	U01000.125.0750
5/8-11X15 Inch*	1	U01000.062.1500	7/8-9X10 Inch*	1	U01000.087.1000	1.1/4-7X8 Inch*	1	U01000.125.0800
						1.1/4-7X8.1/2*	1	U01000.125.0850
3/4-10X1 Inch ft*	10	U01000.075.0100	1.-8X1.1/2 ft*	5	U01000.100.0150	1.1/4-7X9 Inch*	1	U01000.125.0900
3/4-10X1.1/4 ft*	10	U01000.075.0125	1.-8X1.3/4 ft*	5	U01000.100.0175	1.1/4-7X10 Inch*	1	U01000.125.1000
3/4-10X1.1/2 ft*	10	U01000.075.0150	1.-8X2 Inch ft*	5	U01000.100.0200			
3/4-10X1.3/4 ft*	10	U01000.075.0175	1.-8X2.1/4 ft*	5	U01000.100.0225	1.1/2-6X3 Inch ft*	1	U01000.150.0300
3/4-10X2 Inch*	5	U01000.075.0200	1.-8X2.1/2*	5	U01000.100.0250	1.1/2-6X3.1/2*	1	U01000.150.0350
3/4-10X2.1/4*	5	U01000.075.0225	1.-8X2.3/4*	5	U01000.100.0275	1.1/2-6X4 Inch*	1	U01000.150.0400
3/4-10X2.1/2*	5	U01000.075.0250	1.-8X3 Inch*	5	U01000.100.0300	1.1/2-6X4.1/2*	1	U01000.150.0450
3/4-10X2.3/4*	5	U01000.075.0275	1.-8X3.1/4*	5	U01000.100.0325	1.1/2-6X5 Inch*	1	U01000.150.0500
3/4-10X3 Inch*	5	U01000.075.0300	1.-8X3.1/2*	5	U01000.100.0350	1.1/2-6X5.1/2*	1	U01000.150.0550
3/4-10X3.1/4*	5	U01000.075.0325	1.-8X3.3/4*	5	U01000.100.0375	1.1/2-6X6 Inch*	1	U01000.150.0600
3/4-10X3.1/2*	5	U01000.075.0350	1.-8X4 Inch*	5	U01000.100.0400	1.1/2-6X6.1/2*	1	U01000.150.0650
3/4-10X3.3/4*	5	U01000.075.0375	1.-8X4.1/2*	5	U01000.100.0450	1.1/2-6X7 Inch*	1	U01000.150.0700
3/4-10X4 Inch*	5	U01000.075.0400	1.-8X5 Inch*	5	U01000.100.0500	1.1/2-6X7.1/2*	1	U01000.150.0750
3/4-10X4.1/4*	5	U01000.075.0425	1.-8X5.1/2*	5	U01000.100.0550	1.1/2-6X8 Inch*	1	U01000.150.0800
3/4-10X4.1/2*	5	U01000.075.0450	1.-8X6 Inch*	1	U01000.100.0600	1.1/2-6X8.1/2*	1	U01000.150.0850
3/4-10X4.3/4*	5	U01000.075.0475	1.-8X6.1/2*	1	U01000.100.0650	1.1/2-6X9 Inch*	1	U01000.150.0900
3/4-10X5 Inch*	5	U01000.075.0500	1.-8X7 Inch*	1	U01000.100.0700	1.1/2-6X10 Inch*	1	U01000.150.1000
3/4-10X5.1/4*	5	U01000.075.0525	1.-8X7.1/2*	1	U01000.100.0750			

* ft = z pełnym gwintem



U01200 Śruby z łbem sześciokątnym UNC			X01A	
Gwint	Całowy, zunifikowany grubozwojny (UNC)			
Materiał	Stal			
Klasa	Grade 5			
Obróbka powierzchni	O cynkowane			

d x L	☒	Kod artykułu	d x L	☒	Kod artykułu	d x L	☒	Kod artykułu
1/4-20X1/2 ft*	100	U01200.025.0050	1/4-20X2.3/4*	50	U01200.025.0275	1/4-20X8 Inch*	5	U01200.025.0800
1/4-20X5/8 ft*	100	U01200.025.0062	1/4-20X3 Inch*	50	U01200.025.0300			
1/4-20X3/4 ft*	100	U01200.025.0075	1/4-20X3.1/4*	50	U01200.025.0325	5/16-18X1/2 ft*	100	U01200.031.0050
1/4-20X7/8*	100	U01200.025.0087	1/4-20X3.1/2*	50	U01200.025.0350	5/16-18X5/8 ft*	100	U01200.031.0062
1/4-20X1 Inch*	100	U01200.025.0100	1/4-20X3.3/4*	50	U01200.025.0375	5/16-18X3/4 ft*	100	U01200.031.0075
1/4-20X1.1/4*	100	U01200.025.0125	1/4-20X4 Inch*	25	U01200.025.0400	5/16-18X7/8 ft*	100	U01200.031.0087
1/4-20X1.3/8*	100	U01200.025.0137	1/4-20X4.1/4*	25	U01200.025.0425	5/16-18X1 Inch*	100	U01200.031.0100
1/4-20X1.1/2*	100	U01200.025.0150	1/4-20X4.1/2*	25	U01200.025.0450	5/16-18X1.1/4*	100	U01200.031.0125
1/4-20X1.5/8*	100	U01200.025.0162	1/4-20X5 Inch*	25	U01200.025.0500	5/16-18X1.3/8*	100	U01200.031.0137
1/4-20X1.3/4*	100	U01200.025.0175	1/4-20X5.1/2*	25	U01200.025.0550	5/16-18X1.1/2*	100	U01200.031.0150
1/4-20X2 Inch*	50	U01200.025.0200	1/4-20X6 Inch*	25	U01200.025.0600	5/16-18X1.5/8*	100	U01200.031.0162
1/4-20X2.1/4*	50	U01200.025.0225	1/4-20X6.1/2*	10	U01200.025.0650	5/16-18X1.3/4*	50	U01200.031.0175
1/4-20X2.1/2*	50	U01200.025.0250	1/4-20X7 Inch*	10	U01200.025.0700	5/16-18X2 Inch*	50	U01200.031.0200

U01200 Śruby z łbem sześciokątnym UNC								
d x L	☒	Kod artykułu	d x L	☒	Kod artykułu	d x L	☒	Kod artykułu
5/16-18X2.1/4*	50	U01200.031.0225	1/2-13X2.1/4*	10	U01200.050.0225	3/4-10X3 Inch*	5	U01200.075.0300
5/16-18X2.1/2*	50	U01200.031.0250	1/2-13X2.1/2*	10	U01200.050.0250	3/4-10X3.1/4*	5	U01200.075.0325
5/16-18X2.3/4*	50	U01200.031.0275	1/2-13X2.3/4*	10	U01200.050.0275	3/4-10X3.1/2*	5	U01200.075.0350
5/16-18X3 Inch*	50	U01200.031.0300	1/2-13X3 Inch*	10	U01200.050.0300	3/4-10X3.3/4*	5	U01200.075.0375
5/16-18X3.1/2*	50	U01200.031.0350	1/2-13X3.1/4*	10	U01200.050.0325	3/4-10X4 Inch*	5	U01200.075.0400
5/16-18X3.3/4*	25	U01200.031.0375	1/2-13X3.1/2*	10	U01200.050.0350	3/4-10X4.1/4*	5	U01200.075.0425
5/16-18X4 Inch*	25	U01200.031.0400	1/2-13X3.3/4*	10	U01200.050.0375	3/4-10X4.1/2*	5	U01200.075.0450
5/16-18X4.1/4*	25	U01200.031.0425	1/2-13X4 Inch*	5	U01200.050.0400	3/4-10X4.3/4*	5	U01200.075.0475
5/16-18X4.1/2*	25	U01200.031.0450	1/2-13X4.1/4*	5	U01200.050.0425	3/4-10X5 Inch*	5	U01200.075.0500
5/16-18X5 Inch*	25	U01200.031.0500	1/2-13X4.1/2*	5	U01200.050.0450	3/4-10X5.1/4*	5	U01200.075.0525
5/16-18X5.1/2*	25	U01200.031.0550	1/2-13X4.3/4*	5	U01200.050.0475	3/4-10X5.1/2*	5	U01200.075.0550
5/16-18X6 Inch*	25	U01200.031.0600	1/2-13X5 Inch*	5	U01200.050.0500	3/4-10X6 Inch*	5	U01200.075.0600
5/16-18X7 Inch*	10	U01200.031.0700	1/2-13X5.1/4*	5	U01200.050.0525	3/4-10X6.1/2*	1	U01200.075.0650
5/16-18X8 Inch*	5	U01200.031.0800	1/2-13X5.1/2*	5	U01200.050.0550	3/4-10X7 Inch*	1	U01200.075.0700
			1/2-13X6 Inch*	5	U01200.050.0600	3/4-10X7.1/2*	1	U01200.075.0750
			1/2-13X6.1/2*	5	U01200.050.0650	3/4-10X8 Inch*	1	U01200.075.0800
3/8-16X1/2 ft*	50	U01200.037.0050	1/2-13X6.1/2*	5	U01200.050.0650	3/4-10X8.1/2*	1	U01200.075.0850
3/8-16X5/8 ft*	50	U01200.037.0062	1/2-13X7 Inch*	5	U01200.050.0700	3/4-10X9 Inch*	1	U01200.075.0900
3/8-16X3/4 ft*	50	U01200.037.0075	1/2-13X7.1/2*	5	U01200.050.0750	3/4-10X9.1/2*	1	U01200.075.0950
3/8-16X7/8 ft*	50	U01200.037.0087	1/2-13X8 Inch*	5	U01200.050.0800	3/4-10X10 Inch*	1	U01200.075.1000
3/8-16X1 Inch ft*	50	U01200.037.0100	1/2-13X8.1/2*	5	U01200.050.0850	3/4-10X11 Inch*	1	U01200.075.1100
3/8-16X1.1/4*	50	U01200.037.0125	1/2-13X9 Inch*	5	U01200.050.0900	3/4-10X12 Inch*	1	U01200.075.1200
3/8-16X1.1/2*	50	U01200.037.0150	1/2-13X10 Inch*	5	U01200.050.1000	3/4-10X14 Inch*	1	U01200.075.1400
3/8-16X1.3/4*	50	U01200.037.0175	1/2-13X11 Inch*	5	U01200.050.1100			
3/8-16X2 Inch*	25	U01200.037.0200	1/2-13X12 Inch*	5	U01200.050.1200			
3/8-16X2.1/4*	25	U01200.037.0225				7/8-9X1.1/2 ft*	5	U01200.087.0150
3/8-16X2.1/2*	25	U01200.037.0250	9/16-12X1 Inch ft*	25	U01200.056.0100	7/8-9X1.3/4 ft*	5	U01200.087.0175
3/8-16X2.3/4*	25	U01200.037.0275	9/16-12X1.1/4 ft*	25	U01200.056.0125	7/8-9X2 Inch ft*	5	U01200.087.0200
3/8-16X3 Inch*	25	U01200.037.0300	9/16-12X1.1/2*	25	U01200.056.0150	7/8-9X2.1/4*	5	U01200.087.0225
3/8-16X3.1/4*	25	U01200.037.0325	9/16-12X1.3/4*	10	U01200.056.0175	7/8-9X2.1/2*	5	U01200.087.0250
3/8-16X3.1/2*	25	U01200.037.0350	9/16-12X2 Inch*	10	U01200.056.0200	7/8-9X2.3/4*	5	U01200.087.0275
3/8-16X3.3/4*	25	U01200.037.0375	9/16-12X2.1/4*	10	U01200.056.0225	7/8-9X3 Inch*	5	U01200.087.0300
3/8-16X4 Inch*	10	U01200.037.0400	9/16-12X2.1/2*	10	U01200.056.0250	7/8-9X3.1/4*	5	U01200.087.0325
3/8-16X4.1/4*	10	U01200.037.0425	9/16-12X2.3/4*	10	U01200.056.0275	7/8-9X3.1/2*	5	U01200.087.0350
3/8-16X4.1/2*	10	U01200.037.0450	9/16-12X3 Inch*	10	U01200.056.0300	7/8-9X3.3/4*	5	U01200.087.0375
3/8-16X4.3/4*	10	U01200.037.0475	9/16-12X3.1/4*	10	U01200.056.0325	7/8-9X4 Inch*	5	U01200.087.0400
3/8-16X5 Inch*	10	U01200.037.0500	9/16-12X3.1/2*	10	U01200.056.0350	7/8-9X4.1/4*	5	U01200.087.0425
3/8-16X5.1/2*	10	U01200.037.0550	9/16-12X3.3/4*	10	U01200.056.0375	7/8-9X4.1/2*	5	U01200.087.0450
3/8-16X5.3/4*	10	U01200.037.0575	9/16-12X4 Inch*	5	U01200.056.0400	7/8-9X5 Inch*	5	U01200.087.0500
3/8-16X6 Inch*	10	U01200.037.0600	9/16-12X4.1/2*	5	U01200.056.0450	7/8-9X5.1/2*	5	U01200.087.0550
3/8-16X6.1/2*	10	U01200.037.0650	9/16-12X5 Inch*	5	U01200.056.0500	7/8-9X6 Inch*	1	U01200.087.0600
3/8-16X7 Inch*	10	U01200.037.0700	9/16-12X5.1/2*	5	U01200.056.0550	7/8-9X6.1/2*	1	U01200.087.0650
3/8-16X7.1/2*	5	U01200.037.0750	9/16-12X6 Inch*	5	U01200.056.0600	7/8-9X7 Inch*	1	U01200.087.0700
3/8-16X8 Inch*	5	U01200.037.0800				7/8-9X7.1/2*	1	U01200.087.0750
3/8-16X8.1/2*	5	U01200.037.0850	5/8-11X1 Inch ft*	10	U01200.062.0100	7/8-9X8 Inch*	1	U01200.087.0800
3/8-16X9 Inch*	5	U01200.037.0900	5/8-11X1.1/4 ft*	10	U01200.062.0125	7/8-9X8.1/2*	1	U01200.087.0850
3/8-16X10 Inch*	5	U01200.037.1000	5/8-11X1.1/2 ft*	10	U01200.062.0150	7/8-9X9 Inch*	1	U01200.087.0900
3/8-16X12 Inch*	5	U01200.037.1200	5/8-11X1.3/4*	10	U01200.062.0175	7/8-9X9.1/2*	1	U01200.087.0950
			5/8-11X2 Inch*	5	U01200.062.0200	7/8-9X10 Inch*	1	U01200.087.1000
			5/8-11X2.1/4*	5	U01200.062.0225			
			5/8-11X2.1/2*	5	U01200.062.0250	1.-8X1.1/2 ft*	5	U01200.100.0150
			5/8-11X2.3/4*	5	U01200.062.0275	1.-8X1.3/4 ft*	5	U01200.100.0175
			5/8-11X3 Inch*	5	U01200.062.0300	1.-8X2 Inch ft*	5	U01200.100.0200
			5/8-11X3.1/4*	5	U01200.062.0325	1.-8X2.1/4 ft*	5	U01200.100.0225
			5/8-11X3.1/2*	5	U01200.062.0350	1.-8X2.1/2*	5	U01200.100.0250
			5/8-11X3.3/4*	5	U01200.062.0375	1.-8X2.3/4*	5	U01200.100.0275
			5/8-11X4 Inch*	5	U01200.062.0400	1.-8X3 Inch*	5	U01200.100.0300
			5/8-11X4.1/4*	5	U01200.062.0425	1.-8X3.1/4*	5	U01200.100.0325
			5/8-11X4.1/2*	5	U01200.062.0450	1.-8X3.1/2*	5	U01200.100.0350
			5/8-11X4.3/4*	5	U01200.062.0475	1.-8X3.3/4*	5	U01200.100.0375
			5/8-11X5 Inch*	5	U01200.062.0500	1.-8X4 Inch*	5	U01200.100.0400
			5/8-11X5.1/2*	5	U01200.062.0550	1.-8X4.1/4*	5	U01200.100.0425
			5/8-11X6 Inch*	5	U01200.062.0600	1.-8X4.1/2*	5	U01200.100.0450
			5/8-11X6.1/2*	5	U01200.062.0650	1.-8X5 Inch*	5	U01200.100.0500
			5/8-11X7 Inch*	5	U01200.062.0700	1.-8X5.1/2*	5	U01200.100.0550
			5/8-11X7.1/2*	5	U01200.062.0750	1.-8X6 Inch*	1	U01200.100.0600
			5/8-11X8 Inch*	5	U01200.062.0800	1.-8X6.1/2*	1	U01200.100.0650
			5/8-11X8.1/2*	5	U01200.062.0850	1.-8X7 Inch*	1	U01200.100.0700
			5/8-11X9 Inch*	5	U01200.062.0900	1.-8X7.1/2*	1	U01200.100.0750
			5/8-11X9.1/2*	5	U01200.062.0950	1.-8X8 Inch*	1	U01200.100.0800
			5/8-11X10 Inch*	5	U01200.062.1000	1.-8X8.1/2*	1	U01200.100.0850
			5/8-11X11 Inch*	5	U01200.062.1100	1.-8X9 Inch*	1	U01200.100.0900
			5/8-11X12 Inch*	5	U01200.062.1200	1.-8X9.1/2*	1	U01200.100.0950
			5/8-11X14 Inch*	1	U01200.062.1400	1.-8X10 Inch*	1	U01200.100.1000
			3/4-10X1 Inch ft*	10	U01200.075.0100	1.1/8-7X2.1/2 ft*	1	U01200.112.0250
			3/4-10X1.1/4 ft*	10	U01200.075.0125	1.1/8-7X3 Inch*	1	U01200.112.0300
			3/4-10X1.1/2 ft*	10	U01200.075.0150	1.1/8-7X3.1/2*	1	U01200.112.0350
			3/4-10X1.3/4 ft*	10	U01200.075.0175	1.1/8-7X4 Inch*	1	U01200.112.0400
			3/4-10X2 Inch*	5	U01200.075.0200	1.1/8-7X4.1/2*	1	U01200.112.0450
			3/4-10X2.1/4*	5	U01200.075.0225	1.1/8-7X5 Inch*	1	U01200.112.0500
			3/4-10X2.1/2*	5	U01200.075.0250	1.1/8-7X5.1/2*	1	U01200.112.0550
			3/4-10X2.3/4*	5	U01200.075.0275	1.1/8-7X6 Inch*	1	U01200.112.0600
1/2-13X3/4 ft*	25	U01200.050.0075						
1/2-13X7/8 ft*	25	U01200.050.0087						
1/2-13X1 Inch ft*	25	U01200.050.0100						
1/2-13X1.1/4 ft*	25	U01200.050.0125						
1/2-13X1.1/2*	25	U01200.050.0150						
1/2-13X1.3/4*	25	U01200.050.0175						
1/2-13X2 Inch*	10	U01200.050.0200						

U01200 Śruby z łbem sześciokątnym UNC								
d x L	☒	Kod artykułu	d x L	☒	Kod artykułu	d x L	☒	Kod artykułu
1.1/8-7X6.1/2*	1	U01200.112.0650	1.1/4-7X4.1/2*	1	U01200.125.0450	1.1/2-6X3 Inch ft*	1	U01200.150.0300
1.1/8-7X7 Inch*	1	U01200.112.0700	1.1/4-7X5.1/2*	1	U01200.125.0500	1.1/2-6X3.1/2*	1	U01200.150.0350
1.1/8-7X7.1/2*	1	U01200.112.0750	1.1/4-7X6 Inch*	1	U01200.125.0600	1.1/2-6X4 Inch*	1	U01200.150.0400
1.1/8-7X8 Inch*	1	U01200.112.0800	1.1/4-7X6.1/2*	1	U01200.125.0650	1.1/2-6X4.1/2*	1	U01200.150.0450
1.1/8-7X8.1/2*	1	U01200.112.0850	1.1/4-7X7 Inch*	1	U01200.125.0700	1.1/2-6X5 Inch*	1	U01200.150.0500
1.1/8-7X9 Inch*	1	U01200.112.0900	1.1/4-7X7.1/2*	1	U01200.125.0750	1.1/2-6X5.1/2*	1	U01200.150.0550
1.1/8-7X10 Inch*	1	U01200.112.1000	1.1/4-7X8 Inch*	1	U01200.125.0800	1.1/2-6X6 Inch*	1	U01200.150.0600
1.1/4-7X2 Inch ft*	1	U01200.125.0200	1.1/4-7X8.1/2*	1	U01200.125.0850	1.1/2-6X6.1/2*	1	U01200.150.0650
1.1/4-7X2.1/2 ft*	1	U01200.125.0250	1.1/4-7X9 Inch*	1	U01200.125.0900	1.1/2-6X7 Inch*	1	U01200.150.0700
1.1/4-7X3 Inch*	1	U01200.125.0300	1.1/4-7X10 Inch*	1	U01200.125.1000	1.1/2-6X7.1/2*	1	U01200.150.0750
1.1/4-7X3.1/2*	1	U01200.125.0350	1.1/4-7X12 Inch*	1	U01200.125.1200	1.1/2-6X8 Inch*	1	U01200.150.0800
1.1/4-7X4 Inch*	1	U01200.125.0400	1.1/4-7X14 Inch*	1	U01200.125.1400	1.1/2-6X10 Inch*	1	U01200.150.1000

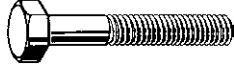
* ft = z pełnym gwintem

U04104 Śruby z łbem sześciokątnym UNC			X01A
Gwint	Całowy, zunifikowany grubozwojny (UNC)		
Materiał	Stal		
Klasa	Grade 8		
			

d x L	☒	Kod artykułu	d x L	☒	Kod artykułu	d x L	☒	Kod artykułu
1/4-20X1/2 ft*	100	U04104.025.0050	3/8-16X1 Inch ft*	50	U04104.037.0100	1/2-13X3/4 ft*	25	U04104.050.0075
1/4-20X5/8 ft*	100	U04104.025.0062	3/8-16X1.1/4*	50	U04104.037.0125	1/2-13X1 Inch ft*	25	U04104.050.0100
1/4-20X3/4 ft*	100	U04104.025.0075	3/8-16X1.1/2*	50	U04104.037.0150	1/2-13X1.1/4 ft*	25	U04104.050.0125
1/4-20X7/8*	100	U04104.025.0087	3/8-16X1.3/4*	50	U04104.037.0175	1/2-13X1.1/2*	25	U04104.050.0150
1/4-20X1 Inch*	100	U04104.025.0100	3/8-16X2 Inch*	25	U04104.037.0200	1/2-13X1.3/4*	25	U04104.050.0175
1/4-20X1.1/4*	100	U04104.025.0125	3/8-16X2.1/4*	25	U04104.037.0225	1/2-13X2 Inch*	10	U04104.050.0200
1/4-20X1.3/8*	100	U04104.025.0137	3/8-16X2.1/2*	25	U04104.037.0250	1/2-13X2.1/4*	10	U04104.050.0225
1/4-20X1.1/2*	100	U04104.025.0150	3/8-16X2.3/4*	25	U04104.037.0275	1/2-13X2.1/2*	10	U04104.050.0250
1/4-20X1.5/8*	100	U04104.025.0162	3/8-16X3 Inch*	25	U04104.037.0300	1/2-13X2.3/4*	10	U04104.050.0275
1/4-20X1.3/4*	100	U04104.025.0175	3/8-16X3.1/4*	25	U04104.037.0325	1/2-13X3 Inch*	10	U04104.050.0300
1/4-20X2 Inch*	50	U04104.025.0200	3/8-16X3.1/2*	25	U04104.037.0350	1/2-13X3.1/4*	10	U04104.050.0325
1/4-20X2.1/4*	50	U04104.025.0225	3/8-16X3.3/4*	25	U04104.037.0375	1/2-13X3.1/2*	10	U04104.050.0350
1/4-20X2.1/2*	50	U04104.025.0250	3/8-16X4 Inch*	10	U04104.037.0400	1/2-13X3.3/4*	10	U04104.050.0375
1/4-20X2.3/4*	50	U04104.025.0275	3/8-16X4.1/4*	10	U04104.037.0425	1/2-13X4 Inch*	5	U04104.050.0400
1/4-20X3 Inch*	50	U04104.025.0300	3/8-16X4.1/2*	10	U04104.037.0450	1/2-13X4.1/4*	5	U04104.050.0425
1/4-20X3.1/4*	50	U04104.025.0325	3/8-16X4.3/4*	10	U04104.037.0475	1/2-13X4.1/2*	5	U04104.050.0450
1/4-20X3.1/2*	50	U04104.025.0350	3/8-16X5 Inch*	10	U04104.037.0500	1/2-13X4.3/4*	5	U04104.050.0475
1/4-20X3.3/4*	50	U04104.025.0375	3/8-16X5.1/2*	10	U04104.037.0550	1/2-13X5 Inch*	5	U04104.050.0500
1/4-20X4 Inch*	25	U04104.025.0400	3/8-16X5.3/4*	10	U04104.037.0575	1/2-13X5.1/4*	5	U04104.050.0525
1/4-20X4.1/4*	25	U04104.025.0425	3/8-16X6 Inch*	10	U04104.037.0600	1/2-13X5.1/2*	5	U04104.050.0550
1/4-20X4.1/2*	25	U04104.025.0450	3/8-16X6.1/2*	10	U04104.037.0650	1/2-13X6 Inch*	5	U04104.050.0600
1/4-20X5 Inch*	25	U04104.025.0500	3/8-16X7 Inch*	10	U04104.037.0700	1/2-13X6.1/2*	5	U04104.050.0650
1/4-20X5.1/2*	25	U04104.025.0550	3/8-16X7.1/2*	5	U04104.037.0750	1/2-13X7 Inch*	5	U04104.050.0700
1/4-20X6 Inch*	25	U04104.025.0600	3/8-16X8 Inch*	5	U04104.037.0800	1/2-13X7.1/2*	5	U04104.050.0750
			3/8-16X8.1/2*	5	U04104.037.0850	1/2-13X8 Inch*	5	U04104.050.0800
			3/8-16X9 Inch*	5	U04104.037.0900	1/2-13X8.1/2*	5	U04104.050.0850
			3/8-16X10 Inch*	5	U04104.037.1000	1/2-13X9 Inch*	5	U04104.050.0900
			3/8-16X12 Inch*	5	U04104.037.1200	1/2-13X10 Inch*	5	U04104.050.1000
						1/2-13X11 Inch*	5	U04104.050.1100
						1/2-13X12 Inch*	5	U04104.050.1200
			7/16-14X3/4 ft*	25	U04104.043.0075			
			7/16-14X7/8 ft*	25	U04104.043.0087			
			7/16-14X1 Inch ft*	25	U04104.043.0100	9/16-12X1 Inch ft*	25	U04104.056.0100
			7/16-14X1.1/4*	25	U04104.043.0125	9/16-12X1.1/4 ft*	25	U04104.056.0125
			7/16-14X1.3/8*	25	U04104.043.0137	9/16-12X1.1/2*	25	U04104.056.0150
			7/16-14X1.1/2*	25	U04104.043.0150	9/16-12X1.3/4*	10	U04104.056.0175
			7/16-14X1.3/4*	25	U04104.043.0175	9/16-12X2 Inch*	10	U04104.056.0200
			7/16-14X2 Inch*	25	U04104.043.0200	9/16-12X2.1/4*	10	U04104.056.0225
			7/16-14X2.1/4*	10	U04104.043.0225	9/16-12X2.1/2*	10	U04104.056.0250
			7/16-14X2.1/2*	10	U04104.043.0250	9/16-12X2.3/4*	10	U04104.056.0275
			7/16-14X2.3/4*	10	U04104.043.0275	9/16-12X3 Inch*	10	U04104.056.0300
			7/16-14X3 Inch*	10	U04104.043.0300	9/16-12X3.1/4*	10	U04104.056.0325
			7/16-14X3.1/4*	10	U04104.043.0325	9/16-12X3.1/2*	10	U04104.056.0350
			7/16-14X3.1/2*	10	U04104.043.0350	9/16-12X3.3/4*	10	U04104.056.0375
			7/16-14X3.3/4*	10	U04104.043.0375	9/16-12X4 Inch*	5	U04104.056.0400
			7/16-14X4 Inch*	10	U04104.043.0400	9/16-12X4.1/2*	5	U04104.056.0450
			7/16-14X4.1/2*	10	U04104.043.0450	9/16-12X5 Inch*	5	U04104.056.0500
			7/16-14X5 Inch*	10	U04104.043.0500	9/16-12X5.1/2*	5	U04104.056.0550
			7/16-14X5.1/2*	10	U04104.043.0550	9/16-12X6 Inch*	5	U04104.056.0600
			7/16-14X6 Inch*	5	U04104.043.0600			
			7/16-14X6.1/2*	5	U04104.043.0650	5/8-11X1 Inch ft*	10	U04104.062.0100
			7/16-14X7 Inch*	5	U04104.043.0700	5/8-11X1.1/4 ft*	10	U04104.062.0125
			7/16-14X8 Inch*	5	U04104.043.0800	5/8-11X1.1/2 ft*	10	U04104.062.0150
			7/16-14X9 Inch*	5	U04104.043.0900	5/8-11X1.3/4*	10	U04104.062.0175
			7/16-14X10 Inch*	5	U04104.043.1000	5/8-11X2 Inch*	5	U04104.062.0200
			7/16-14X12 Inch*	5	U04104.043.1200	5/8-11X2.1/4*	5	U04104.062.0225
						5/8-11X2.1/2*	5	U04104.062.0250

U04104 Śruby z łbem sześciokątnym UNC								
d x L	☒	Kod artykułu	d x L	☒	Kod artykułu	d x L	☒	Kod artykułu
5/8-11X2.3/4*	5	U04104.062.0275	3/4-10X12 Inch*	1	U04104.075.1200	1.-8X12 Inch*	1	U04104.100.1200
5/8-11X3 Inch*	5	U04104.062.0300	3/4-10X13 Inch*	1	U04104.075.1300	1.1/8-7X2.1/2 ft*	1	U04104.112.0250
5/8-11X3.1/4*	5	U04104.062.0325	3/4-10X14 Inch*	1	U04104.075.1400	1.1/8-7X3 Inch*	1	U04104.112.0300
5/8-11X3.1/2*	5	U04104.062.0350				1.1/8-7X3.1/2*	1	U04104.112.0350
5/8-11X3.3/4*	5	U04104.062.0375	7/8-9X1.1/2 ft*	5	U04104.087.0150	1.1/8-7X4 Inch*	1	U04104.112.0400
5/8-11X4 Inch*	5	U04104.062.0400	7/8-9X1.3/4 ft*	5	U04104.087.0175	1.1/8-7X4.1/2*	1	U04104.112.0450
5/8-11X4.1/4*	5	U04104.062.0425	7/8-9X2 Inch ft*	5	U04104.087.0200	1.1/8-7X5 Inch*	1	U04104.112.0500
5/8-11X4.1/2*	5	U04104.062.0450	7/8-9X2.1/4*	5	U04104.087.0225	1.1/8-7X5.1/2*	1	U04104.112.0550
5/8-11X4.3/4*	5	U04104.062.0475	7/8-9X2.1/2*	5	U04104.087.0250	1.1/8-7X6 Inch*	1	U04104.112.0600
5/8-11X5 Inch*	5	U04104.062.0500	7/8-9X2.3/4*	5	U04104.087.0275	1.1/8-7X6.1/2*	1	U04104.112.0650
5/8-11X5.1/2*	5	U04104.062.0550	7/8-9X3 Inch*	5	U04104.087.0300	1.1/8-7X7 Inch*	1	U04104.112.0700
5/8-11X6 Inch*	5	U04104.062.0600	7/8-9X3.1/4*	5	U04104.087.0325	1.1/8-7X7.1/2*	1	U04104.112.0750
5/8-11X6.1/2*	5	U04104.062.0650	7/8-9X3.1/2*	5	U04104.087.0350	1.1/8-7X8 Inch*	1	U04104.112.0800
5/8-11X7 Inch*	5	U04104.062.0700	7/8-9X3.3/4*	5	U04104.087.0375	1.1/8-7X8.1/2*	1	U04104.112.0850
5/8-11X7.1/2*	5	U04104.062.0750	7/8-9X4 Inch*	5	U04104.087.0400	1.1/8-7X9 Inch*	1	U04104.112.0900
5/8-11X8 Inch*	5	U04104.062.0800	7/8-9X4.1/4*	5	U04104.087.0425	1.1/8-7X10 Inch*	1	U04104.112.1000
5/8-11X8.1/2*	5	U04104.062.0850	7/8-9X4.1/2*	5	U04104.087.0450			
5/8-11X9 Inch*	5	U04104.062.0900	7/8-9X5 Inch*	5	U04104.087.0500			
5/8-11X9.1/2*	5	U04104.062.0950	7/8-9X5.1/2*	5	U04104.087.0550	1.1/4-7X2 Inch ft*	1	U04104.125.0200
5/8-11X10 Inch*	5	U04104.062.1000	7/8-9X6 Inch*	1	U04104.087.0600	1.1/4-7X2.1/2 ft*	1	U04104.125.0250
5/8-11X11 Inch*	5	U04104.062.1100	7/8-9X6.1/2*	1	U04104.087.0650	1.1/4-7X3 Inch*	1	U04104.125.0300
5/8-11X12 Inch*	5	U04104.062.1200	7/8-9X7 Inch*	1	U04104.087.0700	1.1/4-7X3.1/2*	1	U04104.125.0350
5/8-11X14 Inch*	1	U04104.062.1400	7/8-9X7.1/2*	1	U04104.087.0750	1.1/4-7X4 Inch*	1	U04104.125.0400
			7/8-9X8 Inch*	1	U04104.087.0800	1.1/4-7X4.1/2*	1	U04104.125.0450
3/4-10X1 Inch ft*	10	U04104.075.0100	7/8-9X8.1/2*	1	U04104.087.0850	1.1/4-7X5 Inch*	1	U04104.125.0500
3/4-10X1.1/4 ft*	10	U04104.075.0125	7/8-9X9 Inch*	1	U04104.087.0900	1.1/4-7X5.1/2*	1	U04104.125.0550
3/4-10X1.1/2 ft*	10	U04104.075.0150	7/8-9X9.1/2*	1	U04104.087.0950	1.1/4-7X6 Inch*	1	U04104.125.0600
3/4-10X1.3/4 ft*	10	U04104.075.0175	7/8-9X10 Inch*	1	U04104.087.1000	1.1/4-7X6.1/2*	1	U04104.125.0650
3/4-10X2 Inch*	5	U04104.075.0200				1.1/4-7X7 Inch*	1	U04104.125.0700
3/4-10X2.1/4*	5	U04104.075.0225	1.-8X1.1/2 ft*	5	U04104.100.0150	1.1/4-7X7.1/2*	1	U04104.125.0750
3/4-10X2.1/2*	5	U04104.075.0250	1.-8X1.3/4 ft*	5	U04104.100.0175	1.1/4-7X8 Inch*	1	U04104.125.0800
3/4-10X2.3/4*	5	U04104.075.0275	1.-8X2 Inch ft*	5	U04104.100.0200	1.1/4-7X8.1/2*	1	U04104.125.0850
3/4-10X3 Inch*	5	U04104.075.0300	1.-8X2.1/4 ft*	5	U04104.100.0225	1.1/4-7X9 Inch*	1	U04104.125.0900
3/4-10X3.1/4*	5	U04104.075.0325	1.-8X2.1/2*	5	U04104.100.0250	1.1/4-7X10 Inch*	1	U04104.125.1000
3/4-10X3.1/2*	5	U04104.075.0350	1.-8X2.3/4*	5	U04104.100.0275	1.1/4-7X12 Inch*	1	U04104.125.1200
3/4-10X3.3/4*	5	U04104.075.0375	1.-8X3 Inch*	5	U04104.100.0300	1.1/4-7X14 Inch*	1	U04104.125.1400
3/4-10X4 Inch*	5	U04104.075.0400	1.-8X3.1/4*	5	U04104.100.0325			
3/4-10X4.1/4*	5	U04104.075.0425	1.-8X3.1/2*	5	U04104.100.0350	1.1/2-6X3 Inch ft*	1	U04104.150.0300
3/4-10X4.1/2*	5	U04104.075.0450	1.-8X3.3/4*	5	U04104.100.0375	1.1/2-6X3.1/2*	1	U04104.150.0350
3/4-10X4.3/4*	5	U04104.075.0475	1.-8X4 Inch*	5	U04104.100.0400	1.1/2-6X4 Inch*	1	U04104.150.0400
3/4-10X5 Inch*	5	U04104.075.0500	1.-8X4.1/4*	5	U04104.100.0425	1.1/2-6X4.1/2*	1	U04104.150.0450
3/4-10X5.1/4*	5	U04104.075.0525	1.-8X4.1/2*	5	U04104.100.0450	1.1/2-6X5 Inch*	1	U04104.150.0500
3/4-10X5.1/2*	5	U04104.075.0550	1.-8X5 Inch*	5	U04104.100.0500	1.1/2-6X5.1/2*	1	U04104.150.0550
3/4-10X6 Inch*	5	U04104.075.0600	1.-8X5.1/2*	5	U04104.100.0550	1.1/2-6X6 Inch*	1	U04104.150.0600
3/4-10X6.1/2*	1	U04104.075.0650	1.-8X6 Inch*	1	U04104.100.0600	1.1/2-6X6.1/2*	1	U04104.150.0650
3/4-10X7 Inch*	1	U04104.075.0700	1.-8X6.1/2*	1	U04104.100.0650	1.1/2-6X7 Inch*	1	U04104.150.0700
3/4-10X7.1/2*	1	U04104.075.0750	1.-8X7 Inch*	1	U04104.100.0700	1.1/2-6X7.1/2*	1	U04104.150.0750
3/4-10X8 Inch*	1	U04104.075.0800	1.-8X7.1/2*	1	U04104.100.0750	1.1/2-6X8 Inch*	1	U04104.150.0800
3/4-10X8.1/2*	1	U04104.075.0850	1.-8X8 Inch*	1	U04104.100.0800	1.1/2-6X8.1/2*	1	U04104.150.0850
3/4-10X9 Inch*	1	U04104.075.0900	1.-8X8.1/2*	1	U04104.100.0850	1.1/2-6X9 Inch*	1	U04104.150.0900
3/4-10X9.1/2*	1	U04104.075.0950	1.-8X9 Inch*	1	U04104.100.0900	1.1/2-6X10 Inch*	1	U04104.150.1000
3/4-10X10 Inch*	1	U04104.075.1000	1.-8X9.1/2*	1	U04104.100.0950			
3/4-10X11 Inch*	1	U04104.075.1100	1.-8X10 Inch*	1	U04104.100.1000			

* ft = z pełnym gwintem

U04100 Śruby z łbem sześciokątnym UNC			X01A		
Gwint	Całowy, zunifikowany grubozwojny (UNC)				
Materiał	Stal				
Klasa	Grade 8				
Obrobka powierzchni	Ocynkowane, po żółtej pasywacji				

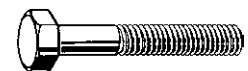

d x L	☒	Kod artykułu	d x L	☒	Kod artykułu	d x L	☒	Kod artykułu
1/4-20X1/2 ft*	100	U04100.025.0050	1/4-20X3.1/2*	50	U04100.025.0350	5/16-18X1 Inch*	100	U04100.031.0100
1/4-20X5/8 ft*	100	U04100.025.0062	1/4-20X3.3/4*	50	U04100.025.0375	5/16-18X1.1/4*	100	U04100.031.0125
1/4-20X3/4 ft*	100	U04100.025.0075	1/4-20X4 Inch*	25	U04100.025.0400	5/16-18X1.3/8*	100	U04100.031.0137
1/4-20X7/8*	100	U04100.025.0087	1/4-20X4.1/4*	25	U04100.025.0425	5/16-18X1.1/2*	100	U04100.031.0150
1/4-20X1 Inch*	100	U04100.025.0100	1/4-20X4.1/2*	25	U04100.025.0450	5/16-18X1.5/8*	100	U04100.031.0162
1/4-20X1.1/4*	100	U04100.025.0125	1/4-20X5 Inch*	25	U04100.025.0500	5/16-18X1.3/4*	50	U04100.031.0175
1/4-20X1.1/2*	100	U04100.025.0137	1/4-20X5.1/2*	25	U04100.025.0550	5/16-18X2 Inch*	50	U04100.031.0200
1/4-20X1.3/8*	100	U04100.025.0150	1/4-20X6 Inch*	25	U04100.025.0600	5/16-18X2.1/4*	50	U04100.031.0225
1/4-20X1.5/8*	100	U04100.025.0162	1/4-20X6.1/2*	10	U04100.025.0650	5/16-18X2.3/8*	50	U04100.031.0237
1/4-20X1.3/4*	100	U04100.025.0175	1/4-20X7 Inch*	10	U04100.025.0700	5/16-18X2.1/2*	50	U04100.031.0250
1/4-20X2 Inch*	50	U04100.025.0200	1/4-20X8 Inch*	5	U04100.025.0800	5/16-18X2.3/4*	50	U04100.031.0275
1/4-20X2.1/4*	50	U04100.025.0225				5/16-18X3 Inch*	50	U04100.031.0300
1/4-20X2.1/2*	50	U04100.025.0250	5/16-18X1/2 ft*	100	U04100.031.0050	5/16-18X3.1/4*	50	U04100.031.0325
1/4-20X2.3/4*	50	U04100.025.0275	5/16-18X5/8 ft*	100	U04100.031.0062	5/16-18X3.1/2*	50	U04100.031.0350
1/4-20X3 Inch*	50	U04100.025.0300	5/16-18X3/4 ft*	100	U04100.031.0075	5/16-18X3.3/4*	25	U04100.031.0375
1/4-20X3.1/4*	50	U04100.025.0325	5/16-18X7/8 ft*	100	U04100.031.0087	5/16-18X4 Inch*	25	U04100.031.0400

U04100 Śruby z łbem sześciokątnym UNC								
d x L	☒	Kod artykułu	d x L	☒	Kod artykułu	d x L	☒	Kod artykułu
5/16-18X4.1/4*	25	U04100.031.0425	1/2-13X4 Inch*	5	U04100.050.0400	3/4-10X4 Inch*	5	U04100.075.0400
5/16-18X4.1/2*	25	U04100.031.0450	1/2-13X4.1/4*	5	U04100.050.0425	3/4-10X4.1/4*	5	U04100.075.0425
5/16-18X5 Inch*	25	U04100.031.0500	1/2-13X4.1/2*	5	U04100.050.0450	3/4-10X4.1/2*	5	U04100.075.0450
5/16-18X5.1/2*	25	U04100.031.0550	1/2-13X4.3/4*	5	U04100.050.0475	3/4-10X4.3/4*	5	U04100.075.0475
5/16-18X6 Inch*	25	U04100.031.0600	1/2-13X5 Inch*	5	U04100.050.0500	3/4-10X5 Inch*	5	U04100.075.0500
5/16-18X6.1/2*	10	U04100.031.0650	1/2-13X5.1/4*	5	U04100.050.0525	3/4-10X5.1/4*	5	U04100.075.0525
5/16-18X7 Inch*	10	U04100.031.0700	1/2-13X5.1/2*	5	U04100.050.0550	3/4-10X5.1/2*	5	U04100.075.0550
5/16-18X8 Inch*	5	U04100.031.0800	1/2-13X5.3/4*	5	U04100.050.0575	3/4-10X6 Inch*	5	U04100.075.0600
			1/2-13X6 Inch*	5	U04100.050.0600	3/4-10X6.1/2*	1	U04100.075.0650
3/8-16X1/2 ft*	50	U04100.037.0050	1/2-13X6.1/2*	5	U04100.050.0650	3/4-10X7 Inch*	1	U04100.075.0700
3/8-16X5/8 ft*	50	U04100.037.0062	1/2-13X7 Inch*	5	U04100.050.0700	3/4-10X7.1/2*	1	U04100.075.0750
3/8-16X3/4 ft*	50	U04100.037.0075	1/2-13X7.1/2*	5	U04100.050.0750	3/4-10X8 Inch*	1	U04100.075.0800
3/8-16X7/8 ft*	50	U04100.037.0087	1/2-13X8 Inch*	5	U04100.050.0800	3/4-10X8.1/2*	1	U04100.075.0850
3/8-16X1 Inch ft*	50	U04100.037.0100	1/2-13X8.1/2*	5	U04100.050.0850	3/4-10X9 Inch*	1	U04100.075.0900
3/8-16X1.1/4*	50	U04100.037.0125	1/2-13X9 Inch*	5	U04100.050.0900	3/4-10X9.1/2*	1	U04100.075.0950
3/8-16X1.1/2*	50	U04100.037.0150	1/2-13X9.1/2*	5	U04100.050.0950	3/4-10X10 Inch*	1	U04100.075.1000
3/8-16X1.3/4*	50	U04100.037.0175	1/2-13X10 Inch*	5	U04100.050.1000	3/4-10X11 Inch*	1	U04100.075.1100
3/8-16X2 Inch*	25	U04100.037.0200	1/2-13X11 Inch*	5	U04100.050.1100	3/4-10X12 Inch*	1	U04100.075.1200
3/8-16X2.1/4*	25	U04100.037.0225	1/2-13X12 Inch*	5	U04100.050.1200	3/4-10X13 Inch*	1	U04100.075.1300
3/8-16X2.1/2*	25	U04100.037.0250	1/2-13X14 Inch*	1	U04100.050.1400	3/4-10X14 Inch*	1	U04100.075.1400
3/8-16X2.3/4*	25	U04100.037.0275						
3/8-16X3 Inch*	25	U04100.037.0300	9/16-12X1 Inch ft*	25	U04100.056.0100	7/8-9X1.1/2 ft*	5	U04100.087.0150
3/8-16X3.1/4*	25	U04100.037.0325	9/16-12X1.1/4 ft*	25	U04100.056.0125	7/8-9X1.3/4 ft*	5	U04100.087.0175
3/8-16X3.1/2*	25	U04100.037.0350	9/16-12X1.1/2*	25	U04100.056.0150	7/8-9X2 Inch ft*	5	U04100.087.0200
3/8-16X3.3/4*	25	U04100.037.0375	9/16-12X1.3/4*	10	U04100.056.0175	7/8-9X2.1/4*	5	U04100.087.0225
3/8-16X4 Inch*	10	U04100.037.0400	9/16-12X2 Inch*	10	U04100.056.0200	7/8-9X2.1/2*	5	U04100.087.0250
3/8-16X4.1/4*	10	U04100.037.0425	9/16-12X2.1/4*	10	U04100.056.0225	7/8-9X2.3/4*	5	U04100.087.0275
3/8-16X4.1/2*	10	U04100.037.0450	9/16-12X2.1/2*	10	U04100.056.0250	7/8-9X3 Inch*	5	U04100.087.0300
3/8-16X4.3/4*	10	U04100.037.0475	9/16-12X2.3/4*	10	U04100.056.0275	7/8-9X3.1/4*	5	U04100.087.0325
3/8-16X5 Inch*	10	U04100.037.0500	9/16-12X3 Inch*	10	U04100.056.0300	7/8-9X3.1/2*	5	U04100.087.0350
3/8-16X5.1/2*	10	U04100.037.0550	9/16-12X3.1/4*	10	U04100.056.0325	7/8-9X3.3/4*	5	U04100.087.0375
3/8-16X5.3/4*	10	U04100.037.0575	9/16-12X3.1/2*	10	U04100.056.0350	7/8-9X4 Inch*	5	U04100.087.0400
3/8-16X6 Inch*	10	U04100.037.0600	9/16-12X3.3/4*	10	U04100.056.0375	7/8-9X4.1/4*	5	U04100.087.0425
3/8-16X6.1/2*	10	U04100.037.0650	9/16-12X4 Inch*	5	U04100.056.0400	7/8-9X4.1/2*	5	U04100.087.0450
3/8-16X7 Inch*	10	U04100.037.0700	9/16-12X4.1/2*	5	U04100.056.0450	7/8-9X5 Inch*	5	U04100.087.0500
3/8-16X7.1/2*	5	U04100.037.0750	9/16-12X5 Inch*	5	U04100.056.0500	7/8-9X5.1/2*	5	U04100.087.0550
3/8-16X8 Inch*	5	U04100.037.0800	9/16-12X5.1/2*	5	U04100.056.0550	7/8-9X6 Inch*	1	U04100.087.0600
3/8-16X8.1/2*	5	U04100.037.0850	9/16-12X6 Inch*	5	U04100.056.0600	7/8-9X6.1/2*	1	U04100.087.0650
3/8-16X9 Inch*	5	U04100.037.0900				7/8-9X7 Inch*	1	U04100.087.0700
3/8-16X10 Inch*	5	U04100.037.1000	5/8-11X1 Inch ft*	10	U04100.062.0100	7/8-9X7.1/2*	1	U04100.087.0750
3/8-16X12 Inch*	5	U04100.037.1200	5/8-11X1.1/4 ft*	10	U04100.062.0125	7/8-9X8 Inch*	1	U04100.087.0800
			5/8-11X1.1/2 ft*	10	U04100.062.0150	7/8-9X8.1/2*	1	U04100.087.0850
			5/8-11X1.3/4*	10	U04100.062.0175	7/8-9X9 Inch*	1	U04100.087.0900
			5/8-11X2 Inch*	5	U04100.062.0200	7/8-9X9.1/2*	1	U04100.087.0950
			5/8-11X2.1/4*	5	U04100.062.0225	7/8-9X10 Inch*	1	U04100.087.1000
			5/8-11X2.1/2*	5	U04100.062.0250	7/8-9X11 Inch*	1	U04100.087.1100
			5/8-11X2.3/4*	5	U04100.062.0275			
7/16-14X3/4 ft*	25	U04100.043.0075	5/8-11X3 Inch*	5	U04100.062.0300	1.-8X1.1/2 ft*	5	U04100.100.0150
7/16-14X7/8 ft*	25	U04100.043.0087	5/8-11X3.1/4*	5	U04100.062.0325	1.-8X1.3/4 ft*	5	U04100.100.0175
7/16-14X1 Inch ft*	25	U04100.043.0100	5/8-11X3.1/2*	5	U04100.062.0350	1.-8X2 Inch ft*	5	U04100.100.0200
7/16-14X1.1/4*	25	U04100.043.0125	5/8-11X3.3/4*	5	U04100.062.0375	1.-8X2.1/4 ft*	5	U04100.100.0225
7/16-14X1.3/8*	25	U04100.043.0137	5/8-11X4 Inch*	5	U04100.062.0400	1.-8X2.1/2*	5	U04100.100.0250
7/16-14X1.1/2*	25	U04100.043.0150	5/8-11X4.1/4*	5	U04100.062.0425	1.-8X2.3/4*	5	U04100.100.0275
7/16-14X1.3/4*	25	U04100.043.0175	5/8-11X4.1/2*	5	U04100.062.0450	1.-8X3 Inch*	5	U04100.100.0300
7/16-14X2 Inch*	25	U04100.043.0200	5/8-11X4.3/4*	5	U04100.062.0475	1.-8X3.1/4*	5	U04100.100.0325
7/16-14X2.1/4*	10	U04100.043.0225	5/8-11X5 Inch*	5	U04100.062.0500	1.-8X3.1/2*	5	U04100.100.0350
7/16-14X2.1/2*	10	U04100.043.0250	5/8-11X5.1/2*	5	U04100.062.0550	1.-8X3.3/4*	5	U04100.100.0375
7/16-14X2.3/4*	10	U04100.043.0275	5/8-11X6 Inch*	5	U04100.062.0600	1.-8X4 Inch*	5	U04100.100.0400
7/16-14X3 Inch*	10	U04100.043.0300	5/8-11X6.1/2*	5	U04100.062.0650	1.-8X4.1/4*	5	U04100.100.0425
7/16-14X3.1/4*	10	U04100.043.0325	5/8-11X7 Inch*	5	U04100.062.0700	1.-8X4.1/2*	5	U04100.100.0450
7/16-14X3.1/2*	10	U04100.043.0350	5/8-11X7.1/2*	5	U04100.062.0750	1.-8X5 Inch*	5	U04100.100.0500
7/16-14X3.3/4*	10	U04100.043.0375	5/8-11X8 Inch*	5	U04100.062.0800	1.-8X5.1/2*	5	U04100.100.0550
7/16-14X4 Inch*	10	U04100.043.0400	5/8-11X8.1/2*	5	U04100.062.0850	1.-8X6 Inch*	1	U04100.100.0600
7/16-14X4.1/2*	10	U04100.043.0450	5/8-11X9 Inch*	5	U04100.062.0900	1.-8X6.1/2*	1	U04100.100.0650
7/16-14X5 Inch*	10	U04100.043.0500	5/8-11X9.1/2*	5	U04100.062.0950	1.-8X7 Inch*	1	U04100.100.0700
7/16-14X5.1/2*	10	U04100.043.0550	5/8-11X10 Inch*	5	U04100.062.1000	1.-8X7.1/2*	1	U04100.100.0750
7/16-14X6 Inch*	5	U04100.043.0600	5/8-11X11 Inch*	5	U04100.062.1100	1.-8X8 Inch*	1	U04100.100.0800
7/16-14X6.1/2*	5	U04100.043.0650	5/8-11X12 Inch*	5	U04100.062.1200	1.-8X8.1/2*	1	U04100.100.0850
7/16-14X7 Inch*	5	U04100.043.0700	5/8-11X14 Inch*	1	U04100.062.1400	1.-8X9 Inch*	1	U04100.100.0900
7/16-14X8 Inch*	5	U04100.043.0800				1.-8X9.1/2*	1	U04100.100.0950
7/16-14X9 Inch*	5	U04100.043.0900				1.-8X10 Inch*	1	U04100.100.1000
7/16-14X10 Inch*	5	U04100.043.1000				1.-8X12 Inch*	1	U04100.100.1200
7/16-14X12 Inch*	5	U04100.043.1200						
1/2-13X3/4 ft*	25	U04100.050.0075						
1/2-13X1 Inch ft*	25	U04100.050.0100	3/4-10X1 Inch ft*	10	U04100.075.0100			
1/2-13X1.1/4 ft*	25	U04100.050.0125	3/4-10X1.1/4 ft*	10	U04100.075.0125			
1/2-13X1.1/2*	25	U04100.050.0150	3/4-10X1.1/2 ft*	10	U04100.075.0150			
1/2-13X1.3/4*	25	U04100.050.0175	3/4-10X1.3/4 ft*	10	U04100.075.0175			
1/2-13X2 Inch*	10	U04100.050.0200	3/4-10X2 Inch*	5	U04100.075.0200	1.1/8-7X2.1/2 ft*	1	U04100.112.0250
1/2-13X2.1/4*	10	U04100.050.0225	3/4-10X2.1/4*	5	U04100.075.0225	1.1/8-7X3 Inch*	1	U04100.112.0300
1/2-13X2.1/2*	10	U04100.050.0250	3/4-10X2.1/2*	5	U04100.075.0250	1.1/8-7X3.1/2*	1	U04100.112.0350
1/2-13X2.3/4*	10	U04100.050.0275	3/4-10X2.3/4*	5	U04100.075.0275	1.1/8-7X4 Inch*	1	U04100.112.0400
1/2-13X3 Inch*	10	U04100.050.0300	3/4-10X3 Inch*	5	U04100.075.0300	1.1/8-7X4.1/2*	1	U04100.112.0450
1/2-13X3.1/4*	10	U04100.050.0325	3/4-10X3.1/4*	5	U04100.075.0325	1.1/8-7X5 Inch*	1	U04100.112.0500
1/2-13X3.1/2*	10	U04100.050.0350	3/4-10X3.1/2*	5	U04100.075.0350	1.1/8-7X5.1/2*	1	U04100.112.0550
1/2-13X3.3/4*	10	U04100.050.0375	3/4-10X3.3/4*	5	U04100.075.0375	1.1/8-7X6 Inch*	1	U04100.112.0600

U04100 Śruby z łbem sześciokątnym UNC								
d x L	☒	Kod artykułu	d x L	☒	Kod artykułu	d x L	☒	Kod artykułu
1.1/8-7X7 Inch*	1	U04100.112.0700	1.1/4-7X5.1/2*	1	U04100.125.0550	1.1/2-6X3.1/2*	1	U04100.150.0350
1.1/8-7X7.1/2*	1	U04100.112.0750	1.1/4-7X6 Inch*	1	U04100.125.0600	1.1/2-6X4 Inch*	1	U04100.150.0400
1.1/8-7X8 Inch*	1	U04100.112.0800	1.1/4-7X6.1/2*	1	U04100.125.0650	1.1/2-6X4.1/2*	1	U04100.150.0450
1.1/8-7X8.1/2*	1	U04100.112.0850	1.1/4-7X7 Inch*	1	U04100.125.0700	1.1/2-6X5 Inch*	1	U04100.150.0500
1.1/8-7X9 Inch*	1	U04100.112.0900	1.1/4-7X7.1/2*	1	U04100.125.0750	1.1/2-6X5.1/2*	1	U04100.150.0550
1.1/8-7X10 Inch*	1	U04100.112.1000	1.1/4-7X8 Inch*	1	U04100.125.0800	1.1/2-6X6 Inch*	1	U04100.150.0600
			1.1/4-7X8.1/2*	1	U04100.125.0850	1.1/2-6X6.1/2*	1	U04100.150.0650
1.1/4-7X2.1/2 ft*	1	U04100.125.0250	1.1/4-7X9 Inch*	1	U04100.125.0900	1.1/2-6X7 Inch*	1	U04100.150.0700
1.1/4-7X3 Inch*	1	U04100.125.0300	1.1/4-7X10 Inch*	1	U04100.125.1000	1.1/2-6X7.1/2*	1	U04100.150.0750
1.1/4-7X3.1/2*	1	U04100.125.0350	1.1/4-7X12 Inch*	1	U04100.125.1200	1.1/2-6X8 Inch*	1	U04100.150.0800
1.1/4-7X4 Inch*	1	U04100.125.0400	1.1/4-7X14 Inch*	1	U04100.125.1400	1.1/2-6X8.1/2*	1	U04100.150.0850
1.1/4-7X4.1/2*	1	U04100.125.0450				1.1/2-6X9 Inch*	1	U04100.150.0900
1.1/4-7X5 Inch*	1	U04100.125.0500	1.1/2-6X3 Inch ft*	1	U04100.150.0300	1.1/2-6X10 Inch*	1	U04100.150.1000

* ft = z pełnym gwintem

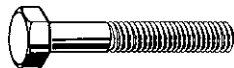

U51000 Śruby z łbem sześciokątnym UNC		X15A
Gwint	Calowy, zunifikowany grubozwojny (UNC)	
Materiał	Stal nierdzewna A2 (AISI 304/18-8)	
Klasa	F593	



d x L	☒	Kod artykułu	d x L	☒	Kod artykułu	d x L	☒	Kod artykułu
1/4-20X1/2 ft*	100	U51000.025.0050	3/8-16X3/4 ft*	50	U51000.037.0075	1/2-13X1.1/2*	10	U51000.050.0150
1/4-20X5/8 ft*	100	U51000.025.0062	3/8-16X7/8 ft*	50	U51000.037.0087	1/2-13X1.3/4*	10	U51000.050.0175
1/4-20X3/4 ft*	100	U51000.025.0075	3/8-16X1 Inch ft*	50	U51000.037.0100	1/2-13X2 Inch*	10	U51000.050.0200
1/4-20X7/8*	100	U51000.025.0087	3/8-16X1.1/8	25	U51000.037.0112	1/2-13X2.1/4*	10	U51000.050.0225
1/4-20X1 Inch*	100	U51000.025.0100	3/8-16X1.1/4*	50	U51000.037.0125	1/2-13X2.1/2*	10	U51000.050.0250
1/4-20X1.1/8	25	U51000.025.0112	3/8-16X1.3/8	25	U51000.037.0137	1/2-13X2.3/4*	10	U51000.050.0275
1/4-20X1.1/4*	100	U51000.025.0125	3/8-16X1.1/2*	25	U51000.037.0150	1/2-13X3 Inch*	5	U51000.050.0300
1/4-20X1.3/8*	100	U51000.025.0137	3/8-16X1.3/4*	25	U51000.037.0175	1/2-13X3.1/4*	5	U51000.050.0325
1/4-20X1.1/2*	100	U51000.025.0150	3/8-16X2 Inch*	25	U51000.037.0200	1/2-13X3.1/2*	5	U51000.050.0350
1/4-20X1.3/4*	100	U51000.025.0175	3/8-16X2.1/4*	25	U51000.037.0225	1/2-13X3.3/4*	5	U51000.050.0375
1/4-20X1.7/8	25	U51000.025.0187	3/8-16X2.1/2*	25	U51000.037.0250	1/2-13X4 Inch*	5	U51000.050.0400
1/4-20X2 Inch*	50	U51000.025.0200	3/8-16X2.3/4*	25	U51000.037.0275	1/2-13X4.1/4*	5	U51000.050.0425
1/4-20X2.1/4*	50	U51000.025.0225	3/8-16X3 Inch*	10	U51000.037.0300	1/2-13X4.1/2*	5	U51000.050.0450
1/4-20X2.1/2*	50	U51000.025.0250	3/8-16X3.1/4*	10	U51000.037.0325	1/2-13X4.3/4*	5	U51000.050.0475
1/4-20X2.3/4*	50	U51000.025.0275	3/8-16X3.1/2*	10	U51000.037.0350	1/2-13X5 Inch*	5	U51000.050.0500
1/4-20X3 Inch*	25	U51000.025.0300	3/8-16X3.3/4*	10	U51000.037.0375	1/2-13X5.1/2*	5	U51000.050.0550
1/4-20X3.1/4*	25	U51000.025.0325	3/8-16X4 Inch*	10	U51000.037.0400	1/2-13X6 Inch*	5	U51000.050.0600
1/4-20X3.1/2*	25	U51000.025.0350	3/8-16X4.1/4*	10	U51000.037.0425	1/2-13X6.1/2*	5	U51000.050.0650
1/4-20X3.3/4*	25	U51000.025.0375	3/8-16X4.1/2*	10	U51000.037.0450	1/2-13X7 Inch*	5	U51000.050.0700
1/4-20X4 Inch*	25	U51000.025.0400	3/8-16X4.3/4*	10	U51000.037.0475	1/2-13X7.1/2*	5	U51000.050.0750
1/4-20X4.1/4*	25	U51000.025.0425	3/8-16X5 Inch*	10	U51000.037.0500	1/2-13X8 Inch*	5	U51000.050.0800
1/4-20X4.1/2*	25	U51000.025.0450	3/8-16X5.1/2*	10	U51000.037.0550	1/2-13X8.1/2*	1	U51000.050.0850
1/4-20X5 Inch*	25	U51000.025.0500	3/8-16X5.3/4*	10	U51000.037.0575	1/2-13X9 Inch*	1	U51000.050.0900
1/4-20X5.1/2*	10	U51000.025.0550	3/8-16X6 Inch*	10	U51000.037.0600	1/2-13X10 Inch*	1	U51000.050.1000
1/4-20X6 Inch*	10	U51000.025.0600	3/8-16X6.1/2*	5	U51000.037.0650	1/2-13X11 Inch*	1	U51000.050.1100
1/4-20X6.1/2*	5	U51000.025.0650	3/8-16X7 Inch*	5	U51000.037.0700	1/2-13X12 Inch*	1	U51000.050.1200
1/4-20X7 Inch*	5	U51000.025.0700	3/8-16X7.1/2*	5	U51000.037.0750			
1/4-20X8 Inch*	5	U51000.025.0800	3/8-16X8 Inch*	5	U51000.037.0800			
			3/8-16X9 Inch	1	U51000.037.0900	9/16-12X1.1/2*	10	U51000.056.0150
			3/8-16X10 Inch	1	U51000.037.1000	9/16-12X1.3/4*	10	U51000.056.0175
5/16-18X1/2 ft*	100	U51000.031.0050				9/16-12X2 Inch*	5	U51000.056.0200
5/16-18X5/8 ft*	100	U51000.031.0062				9/16-12X2.1/4*	5	U51000.056.0225
5/16-18X3/4 ft*	100	U51000.031.0075	7/16-14X3/4 ft*	25	U51000.043.0075	9/16-12X2.1/2*	5	U51000.056.0250
5/16-18X7/8 ft*	50	U51000.031.0087	7/16-14X7/8 ft*	25	U51000.043.0087	9/16-12X2.3/4*	5	U51000.056.0275
5/16-18X1 Inch*	50	U51000.031.0100	7/16-14X1 Inch ft*	25	U51000.043.0100	9/16-12X3 Inch*	5	U51000.056.0300
5/16-18X1.1/8	25	U51000.031.0112	7/16-14X1.1/4*	25	U51000.043.0125	9/16-12X3.1/4*	5	U51000.056.0325
5/16-18X1.1/4*	50	U51000.031.0125	7/16-14X1.1/2*	25	U51000.043.0150	9/16-12X3.1/2*	5	U51000.056.0350
5/16-18X1.3/8*	50	U51000.031.0137	7/16-14X1.3/4*	10	U51000.043.0175	9/16-12X3.3/4*	5	U51000.056.0375
5/16-18X1.1/2*	50	U51000.031.0150	7/16-14X2 Inch*	10	U51000.043.0200	9/16-12X4 Inch*	5	U51000.056.0400
5/16-18X1.3/4*	50	U51000.031.0175	7/16-14X2.1/4*	10	U51000.043.0225	9/16-12X4.1/2*	5	U51000.056.0450
5/16-18X2 Inch*	50	U51000.031.0200	7/16-14X2.1/2*	10	U51000.043.0250	9/16-12X5 Inch*	5	U51000.056.0500
5/16-18X2.1/4*	25	U51000.031.0225	7/16-14X2.3/4*	10	U51000.043.0275	9/16-12X5.1/2*	5	U51000.056.0550
5/16-18X2.1/2*	25	U51000.031.0250	7/16-14X3 Inch*	10	U51000.043.0300	9/16-12X6 Inch*	5	U51000.056.0600
5/16-18X2.3/4*	25	U51000.031.0275	7/16-14X3.1/2*	5	U51000.043.0350			
5/16-18X3 Inch*	25	U51000.031.0300	7/16-14X4 Inch*	5	U51000.043.0400	5/8-11X1 Inch ft*	10	U51000.062.0100
5/16-18X3.1/4*	25	U51000.031.0325	7/16-14X4.1/2*	5	U51000.043.0450	5/8-11X1.1/4 ft*	10	U51000.062.0125
5/16-18X3.1/2*	25	U51000.031.0350	7/16-14X5 Inch*	5	U51000.043.0500	5/8-11X1.1/2 ft*	10	U51000.062.0150
5/16-18X3.3/4*	25	U51000.031.0375	7/16-14X6 Inch*	5	U51000.043.0600	5/8-11X1.3/4*	10	U51000.062.0175
5/16-18X4 Inch*	10	U51000.031.0400	7/16-14X7 Inch*	5	U51000.043.0700	5/8-11X2 Inch*	5	U51000.062.0200
5/16-18X4.1/2*	10	U51000.031.0450	7/16-14X8 Inch*	5	U51000.043.0800	5/8-11X2.1/4*	5	U51000.062.0225
5/16-18X5 Inch*	10	U51000.031.0500				5/8-11X2.1/2*	5	U51000.062.0250
5/16-18X5.1/2*	10	U51000.031.0550	1/2-13X1/2 ft	25	U51000.050.0050	5/8-11X2.3/4*	5	U51000.062.0275
5/16-18X6 Inch*	10	U51000.031.0600	1/2-13X5/8 ft	1	U51000.050.0062	5/8-11X3 Inch*	5	U51000.062.0300
5/16-18X7 Inch*	5	U51000.031.0700	1/2-13X3/4 ft*	10	U51000.050.0075	5/8-11X3.1/4*	5	U51000.062.0325
			1/2-13X7/8 ft*	10	U51000.050.0087	5/8-11X3.1/2*	5	U51000.062.0350
3/8-16X1/2 ft*	50	U51000.037.0050	1/2-13X1 Inch ft*	10	U51000.050.0100	5/8-11X3.3/4*	5	U51000.062.0375
3/8-16X5/8 ft*	50	U51000.037.0062	1/2-13X1.1/4 ft*	10	U51000.050.0125	5/8-11X4 Inch*	5	U51000.062.0400

U51000 Śruby z łbem sześciokątnym UNC								
d x L	☒	Kod artykułu	d x L	☒	Kod artykułu	d x L	☒	Kod artykułu
5/8-11X4.1/4*	5	U51000.062.0425	3/4-10X5.1/2*	5	U51000.075.0550	1.-8X2.1/2*	5	U51000.100.0250
5/8-11X4.1/2*	5	U51000.062.0450	3/4-10X6 Inch*	5	U51000.075.0600	1.-8X2.3/4*	5	U51000.100.0275
5/8-11X4.3/4*	5	U51000.062.0475	3/4-10X6.1/2*	5	U51000.075.0650	1.-8X3 Inch*	5	U51000.100.0300
5/8-11X5 Inch*	5	U51000.062.0500	3/4-10X7 Inch*	5	U51000.075.0700	1.-8X3.1/4*	5	U51000.100.0325
5/8-11X5.1/4	5	U51000.062.0525	3/4-10X7.1/2*	5	U51000.075.0750	1.-8X3.1/2*	5	U51000.100.0350
5/8-11X5.1/2*	5	U51000.062.0550	3/4-10X8 Inch*	5	U51000.075.0800	1.-8X4 Inch*	5	U51000.100.0400
5/8-11X6 Inch*	5	U51000.062.0600	3/4-10X9 Inch	1	U51000.075.0900	1.-8X4.1/4*	5	U51000.100.0425
5/8-11X6.1/2*	5	U51000.062.0650	3/4-10X10 Inch	1	U51000.075.1000	1.-8X4.1/2*	5	U51000.100.0450
5/8-11X7 Inch*	5	U51000.062.0700				1.-8X5 Inch*	5	U51000.100.0500
5/8-11X7.1/2*	5	U51000.062.0750	7/8-9X1.1/2 ft*	5	U51000.087.0150	1.-8X5.1/2*	5	U51000.100.0550
5/8-11X8 Inch*	5	U51000.062.0800	7/8-9X1.3/4 ft*	5	U51000.087.0175	1.-8X6 Inch*	5	U51000.100.0600
5/8-11X8.1/2*	1	U51000.062.0850	7/8-9X2 Inch ft*	5	U51000.087.0200	1.-8X6.1/2*	1	U51000.100.0650
5/8-11X9 Inch*	1	U51000.062.0900	7/8-9X2.1/4*	5	U51000.087.0225	1.-8X7 Inch*	1	U51000.100.0700
5/8-11X9.1/2*	1	U51000.062.0950	7/8-9X2.1/2*	5	U51000.087.0250	1.-8X8 Inch*	1	U51000.100.0800
5/8-11X10 Inch*	1	U51000.062.1000	7/8-9X2.3/4*	5	U51000.087.0275	1.-8X9 Inch*	1	U51000.100.0900
5/8-11X11 Inch*	1	U51000.062.1100	7/8-9X3 Inch*	5	U51000.087.0300	1.-8X10 Inch*	1	U51000.100.1000
5/8-11X12 Inch*	1	U51000.062.1200	7/8-9X3.1/4*	5	U51000.087.0325			
			7/8-9X3.1/2*	5	U51000.087.0350	1.1/8-7X2.1/2 ft*	1	U51000.112.0250
3/4-10X1 Inch ft*	5	U51000.075.0100	7/8-9X3.3/4*	5	U51000.087.0375	1.1/8-7X3 Inch*	1	U51000.112.0300
3/4-10X1.1/4 ft*	5	U51000.075.0125	7/8-9X4 Inch*	5	U51000.087.0400	1.1/8-7X3.1/2*	1	U51000.112.0350
3/4-10X1.1/2 ft*	5	U51000.075.0150	7/8-9X4.1/4*	5	U51000.087.0425	1.1/8-7X4 Inch*	1	U51000.112.0400
3/4-10X1.3/4 ft*	5	U51000.075.0175	7/8-9X4.1/2*	5	U51000.087.0450	1.1/8-7X5 Inch*	1	U51000.112.0500
3/4-10X2 Inch*	5	U51000.075.0200	7/8-9X4.3/4	1	U51000.087.0475	1.1/8-7X6 Inch*	1	U51000.112.0600
3/4-10X2.1/4*	5	U51000.075.0225	7/8-9X5 Inch*	5	U51000.087.0500	1.1/8-7X7 Inch*	1	U51000.112.0700
3/4-10X2.1/2*	5	U51000.075.0250	7/8-9X5.1/2*	5	U51000.087.0550	1.1/8-7X8 Inch*	1	U51000.112.0800
3/4-10X2.3/4*	5	U51000.075.0275	7/8-9X6 Inch*	5	U51000.087.0600			
3/4-10X3 Inch*	5	U51000.075.0300	7/8-9X6.1/2*	5	U51000.087.0650	1.1/4-7X2.1/2 ft*	1	U51000.125.0250
3/4-10X3.1/4*	5	U51000.075.0325	7/8-9X7 Inch*	5	U51000.087.0700	1.1/4-7X3 Inch*	1	U51000.125.0300
3/4-10X3.1/2*	5	U51000.075.0350	7/8-9X7.1/2*	1	U51000.087.0750	1.1/4-7X4 Inch*	1	U51000.125.0400
3/4-10X3.3/4*	5	U51000.075.0375	7/8-9X8 Inch*	1	U51000.087.0800	1.1/4-7X5 Inch*	1	U51000.125.0500
3/4-10X4 Inch*	5	U51000.075.0400	7/8-9X9 Inch*	1	U51000.087.0900	1.1/4-7X6 Inch*	1	U51000.125.0600
3/4-10X4.1/4*	5	U51000.075.0425	7/8-9X10 Inch*	1	U51000.087.1000	1.1/4-7X7 Inch*	1	U51000.125.0700
3/4-10X4.1/2*	5	U51000.075.0450				1.1/4-7X8 Inch*	1	U51000.125.0800
3/4-10X4.3/4*	5	U51000.075.0475	1.-8X2 Inch ft*	5	U51000.100.0200	1.1/4-7X9 Inch*	1	U51000.125.0900
3/4-10X5 Inch*	5	U51000.075.0500	1.-8X2.1/4 ft*	5	U51000.100.0225			

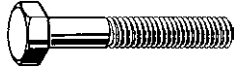
• ft = z pełnym gwintem

U55000 Śruby z łbem sześciokątnym UNC		X15A
Gwint	Całowy, zunifikowany grubozwojny (UNC)	
Materiał	Stal nierdzewna A4 (AISI 316/18-10)	
Klasa	F593	
		

d x L	☒	Kod artykułu	d x L	☒	Kod artykułu	d x L	☒	Kod artykułu
1/4-20X1/2 ft*	100	U55000.025.0050	5/16-18X2.1/4*	25	U55000.031.0225	3/8-16X6.1/2*	5	U55000.037.0650
1/4-20X5/8 ft*	100	U55000.025.0062	5/16-18X2.1/2*	25	U55000.031.0250	3/8-16X7 Inch*	5	U55000.037.0700
1/4-20X3/4 ft*	100	U55000.025.0075	5/16-18X2.3/4*	25	U55000.031.0275	3/8-16X7.1/2*	5	U55000.037.0750
1/4-20X7/8*	100	U55000.025.0087	5/16-18X3 Inch*	25	U55000.031.0300	3/8-16X8 Inch*	5	U55000.037.0800
1/4-20X1 Inch*	100	U55000.025.0100	5/16-18X3.1/2*	25	U55000.031.0350			
1/4-20X1.1/4*	100	U55000.025.0125	5/16-18X4 Inch*	10	U55000.031.0400	7/16-14X1 Inch ft*	25	U55000.043.0100
1/4-20X1.3/8*	100	U55000.025.0137	5/16-18X5 Inch*	10	U55000.031.0500	7/16-14X1.1/4*	25	U55000.043.0125
1/4-20X1.1/2*	100	U55000.025.0150	5/16-18X6 Inch*	10	U55000.031.0600	7/16-14X1.1/2*	25	U55000.043.0150
1/4-20X1.3/4*	100	U55000.025.0175				7/16-14X2 Inch*	10	U55000.043.0200
1/4-20X1.7/8	10	U55000.025.0187	3/8-16X1/2 ft*	50	U55000.037.0050	7/16-14X2.1/2*	10	U55000.043.0250
1/4-20X2 Inch*	50	U55000.025.0200	3/8-16X5/8 ft*	50	U55000.037.0062	7/16-14X3 Inch*	10	U55000.043.0300
1/4-20X2.1/4*	50	U55000.025.0225	3/8-16X3/4 ft*	50	U55000.037.0075	7/16-14X3.1/2*	5	U55000.043.0350
1/4-20X2.1/2*	50	U55000.025.0250	3/8-16X7/8 ft*	50	U55000.037.0087	7/16-14X4 Inch*	5	U55000.043.0400
1/4-20X2.3/4*	50	U55000.025.0275	3/8-16X1 Inch ft*	50	U55000.037.0100			
1/4-20X3 Inch*	25	U55000.025.0300	3/8-16X1.1/8	10	U55000.037.0112	1/2-13X3/4 ft*	10	U55000.050.0075
1/4-20X3.1/4*	25	U55000.025.0325	3/8-16X1.1/4*	50	U55000.037.0125	1/2-13X7/8 ft*	10	U55000.050.0087
1/4-20X3.1/2*	25	U55000.025.0350	3/8-16X1.1/2*	25	U55000.037.0150	1/2-13X1 Inch ft*	10	U55000.050.0100
1/4-20X3.3/4*	25	U55000.025.0375	3/8-16X1.3/4*	25	U55000.037.0175	1/2-13X1.1/4 ft*	10	U55000.050.0125
1/4-20X4 Inch*	25	U55000.025.0400	3/8-16X2 Inch*	25	U55000.037.0200	1/2-13X1.1/2*	10	U55000.050.0150
1/4-20X4.1/4*	25	U55000.025.0425	3/8-16X2.1/4*	25	U55000.037.0225	1/2-13X1.3/4*	10	U55000.050.0175
1/4-20X4.1/2*	25	U55000.025.0450	3/8-16X2.1/2*	25	U55000.037.0250	1/2-13X2 Inch*	10	U55000.050.0200
1/4-20X5 Inch*	25	U55000.025.0500	3/8-16X2.3/4*	25	U55000.037.0275	1/2-13X2.1/4*	10	U55000.050.0225
1/4-20X5.1/2*	10	U55000.025.0550	3/8-16X3 Inch*	10	U55000.037.0300	1/2-13X2.1/2*	10	U55000.050.0250
1/4-20X6 Inch*	10	U55000.025.0600	3/8-16X3.1/4*	10	U55000.037.0325	1/2-13X2.3/4*	10	U55000.050.0275
			3/8-16X3.1/2*	10	U55000.037.0350	1/2-13X3 Inch*	5	U55000.050.0300
5/16-18X1/2 ft*	100	U55000.031.0050	3/8-16X3.3/4*	10	U55000.037.0375	1/2-13X3.1/4*	5	U55000.050.0325
5/16-18X5/8 ft*	100	U55000.031.0062	3/8-16X4 Inch*	10	U55000.037.0400	1/2-13X3.1/2*	5	U55000.050.0350
5/16-18X3/4 ft*	100	U55000.031.0075	3/8-16X4.1/4*	10	U55000.037.0425	1/2-13X3.3/4*	5	U55000.050.0375
5/16-18X7/8 ft*	50	U55000.031.0087	3/8-16X4.1/2*	10	U55000.037.0450	1/2-13X4 Inch*	5	U55000.050.0400
5/16-18X1 Inch*	50	U55000.031.0100	3/8-16X4.3/4*	10	U55000.037.0475	1/2-13X4.1/4*	5	U55000.050.0425
5/16-18X1.1/4*	50	U55000.031.0125	3/8-16X5 Inch*	10	U55000.037.0500	1/2-13X4.1/2*	5	U55000.050.0450
5/16-18X1.1/2*	50	U55000.031.0150	3/8-16X5.1/2*	10	U55000.037.0550	1/2-13X4.3/4*	5	U55000.050.0475
5/16-18X1.3/4*	50	U55000.031.0175	3/8-16X5.3/4*	10	U55000.037.0575	1/2-13X5 Inch*	5	U55000.050.0500
5/16-18X2 Inch*	50	U55000.031.0200	3/8-16X6 Inch*	10	U55000.037.0600	1/2-13X5.1/2*	5	U55000.050.0550

U55000 Śruby z łbem sześciokątnym UNC								
d x L	☒	Kod artykułu	d x L	☒	Kod artykułu	d x L	☒	Kod artykułu
1/2-13X6 Inch*	5	U55000.050.0600	3/4-10X1.1/4 ft*	5	U55000.075.0125	7/8-9X9 Inch*	1	U55000.087.0900
1/2-13X6.1/2*	5	U55000.050.0650	3/4-10X1.1/2 ft*	5	U55000.075.0150	7/8-9X10 Inch*	1	U55000.087.1000
1/2-13X7 Inch*	5	U55000.050.0700	3/4-10X1.3/4 ft*	5	U55000.075.0175			
1/2-13X7.1/2*	5	U55000.050.0750	3/4-10X2 Inch*	5	U55000.075.0200	1.-8X2 Inch ft*	5	U55000.100.0200
1/2-13X8 Inch*	5	U55000.050.0800	3/4-10X2.1/4*	5	U55000.075.0225	1.-8X2.1/4 ft*	5	U55000.100.0225
1/2-13X8.1/2*	1	U55000.050.0850	3/4-10X2.1/2*	5	U55000.075.0250	1.-8X2.1/2*	5	U55000.100.0250
1/2-13X9 Inch*	1	U55000.050.0900	3/4-10X2.3/4*	5	U55000.075.0275	1.-8X2.3/4*	5	U55000.100.0275
1/2-13X10 Inch*	1	U55000.050.1000	3/4-10X3 Inch*	5	U55000.075.0300	1.-8X3 Inch*	5	U55000.100.0300
1/2-13X11 Inch*	1	U55000.050.1100	3/4-10X3.1/4*	5	U55000.075.0325	1.-8X3.1/4*	5	U55000.100.0325
1/2-13X12 Inch*	1	U55000.050.1200	3/4-10X3.1/2*	5	U55000.075.0350	1.-8X3.1/2*	5	U55000.100.0350
			3/4-10X3.3/4*	5	U55000.075.0375	1.-8X3.3/4*	5	U55000.100.0375
5/8-11X1 Inch ft*	10	U55000.062.0100	3/4-10X4 Inch*	5	U55000.075.0400	1.-8X4 Inch*	5	U55000.100.0400
5/8-11X1.1/4 ft*	10	U55000.062.0125	3/4-10X4.1/4*	5	U55000.075.0425	1.-8X4.1/4*	5	U55000.100.0425
5/8-11X1.1/2 ft*	10	U55000.062.0150	3/4-10X4.1/2*	5	U55000.075.0450	1.-8X4.1/2*	5	U55000.100.0450
5/8-11X1.3/4*	10	U55000.062.0175	3/4-10X4.3/4*	5	U55000.075.0475	1.-8X5 Inch*	5	U55000.100.0500
5/8-11X2 Inch*	5	U55000.062.0200	3/4-10X5 Inch*	5	U55000.075.0500	1.-8X5.1/2*	5	U55000.100.0550
5/8-11X2.1/4*	5	U55000.062.0225	3/4-10X5.1/2*	5	U55000.075.0550	1.-8X6 Inch*	5	U55000.100.0600
5/8-11X2.1/2*	5	U55000.062.0250	3/4-10X6 Inch*	5	U55000.075.0600	1.-8X6.1/2*	1	U55000.100.0650
5/8-11X2.3/4*	5	U55000.062.0275	3/4-10X6.1/2*	5	U55000.075.0650	1.-8X7 Inch*	1	U55000.100.0700
5/8-11X3 Inch*	5	U55000.062.0300	3/4-10X7 Inch*	5	U55000.075.0700	1.-8X7.1/2*	1	U55000.100.0750
5/8-11X3.1/4*	5	U55000.062.0325	3/4-10X7.1/2*	5	U55000.075.0750	1.-8X8 Inch*	1	U55000.100.0800
5/8-11X3.1/2*	5	U55000.062.0350	3/4-10X8 Inch*	5	U55000.075.0800	1.-8X9 Inch*	1	U55000.100.0900
5/8-11X3.3/4*	5	U55000.062.0375				1.-8X10 Inch*	1	U55000.100.1000
5/8-11X4 Inch*	5	U55000.062.0400	7/8-9X1.1/2 ft*	5	U55000.087.0150			
5/8-11X4.1/4*	5	U55000.062.0425	7/8-9X1.3/4 ft*	5	U55000.087.0175	1.1/8-7X2.1/2 ft*	1	U55000.112.0250
5/8-11X4.1/2*	5	U55000.062.0450	7/8-9X2 Inch ft*	5	U55000.087.0200	1.1/8-7X3 Inch*	1	U55000.112.0300
5/8-11X4.3/4*	5	U55000.062.0475	7/8-9X2.1/4*	5	U55000.087.0225	1.1/8-7X3.1/2*	1	U55000.112.0350
5/8-11X5 Inch*	5	U55000.062.0500	7/8-9X2.1/2*	5	U55000.087.0250	1.1/8-7X4 Inch*	1	U55000.112.0400
5/8-11X51/4	5	U55000.062.0525	7/8-9X2.3/4*	5	U55000.087.0275	1.1/8-7X5 Inch*	1	U55000.112.0500
5/8-11X5.1/2*	5	U55000.062.0550	7/8-9X3 Inch*	5	U55000.087.0300	1.1/8-7X6 Inch*	1	U55000.112.0600
5/8-11X6 Inch*	5	U55000.062.0600	7/8-9X3.1/4*	5	U55000.087.0325	1.1/8-7X7 Inch*	1	U55000.112.0700
5/8-11X6.1/2*	5	U55000.062.0650	7/8-9X3.1/2*	5	U55000.087.0350	1.1/8-7X8 Inch*	1	U55000.112.0800
5/8-11X7 Inch*	5	U55000.062.0700	7/8-9X3.3/4*	5	U55000.087.0375			
5/8-11X7.1/2*	5	U55000.062.0750	7/8-9X4 Inch*	5	U55000.087.0400	1.1/4-7X2.1/2 ft*	1	U55000.125.0250
5/8-11X8 Inch*	5	U55000.062.0800	7/8-9X4.1/4*	5	U55000.087.0425	1.1/4-7X3 Inch*	1	U55000.125.0300
5/8-11X8.1/2*	1	U55000.062.0850	7/8-9X4.1/2*	5	U55000.087.0450	1.1/4-7X4 Inch*	1	U55000.125.0400
5/8-11X9 Inch*	1	U55000.062.0900	7/8-9X5 Inch*	5	U55000.087.0500	1.1/4-7X5 Inch*	1	U55000.125.0500
5/8-11X9.1/2*	1	U55000.062.0950	7/8-9X5.1/2*	5	U55000.087.0550	1.1/4-7X6 Inch*	1	U55000.125.0600
5/8-11X10 Inch*	1	U55000.062.1000	7/8-9X6 Inch*	5	U55000.087.0600	1.1/4-7X7 Inch*	1	U55000.125.0700
5/8-11X11 Inch*	1	U55000.062.1100	7/8-9X6.1/2*	5	U55000.087.0650	1.1/4-7X8 Inch*	1	U55000.125.0800
5/8-11X12 Inch*	1	U55000.062.1200	7/8-9X7 Inch*	5	U55000.087.0700	1.1/4-7X9 Inch*	1	U55000.125.0900
			7/8-9X7.1/2*	1	U55000.087.0750			
3/4-10X1 Inch ft	5	U55000.075.0100	7/8-9X8 Inch*	1	U55000.087.0800			

• ft = z pełnym gwintem

Śruby z łbem sześciokątnym UNF

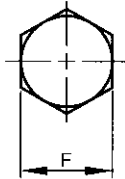
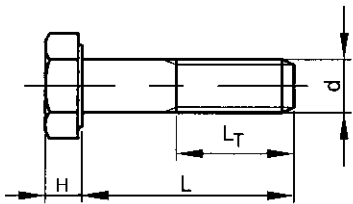

ASME ≈B18.2.1
BS ≈1768

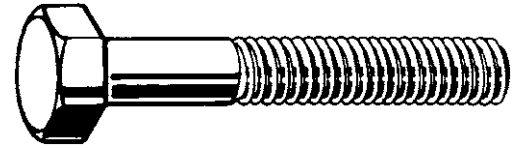

Informacje techniczne

d	L _T (min.): L≤6 Inch	L _T (min.): L>6 Inch	F	H	Zwoje gwintu na cal
1/4	0.75	1	7/16	5/32	28
5/16	0.875	1.125	1/2	13/64	24
3/8	1	1.25	9/16	15/64	24
7/16	1.125	1.375	5/8	9/32	20
1/2	1.25	1.50	3/4	5/16	20
9/16	1.375	1.625	13/16	23/64	18
5/8	1.5	1.75	15/16	25/64	18
3/4	1.75	2	1.1/8	15/32	16
7/8	2	2.25	1.5/16	35/64	14
1 Inch	2.25	2.5	1.1/2	39/64	12
1.1/8	2.5	2.75	1.11/16	11/16	12
1.1/4	2.75	3	1.7/8	25/32	12
1.1/2	3.25	3.5	2.1/4	15/46	12

Grupy katalogowe

Gwint	Gniazdo	Materiał	Klasa	Obróbka powierzchni	Kod	Strona
UNF	Sześciokąt	St	Grade 5		U01060	1-52
UNF	Sześciokąt	St	Grade 5	Ocyнк.	U01062	1-53
UNF	Sześciokąt	St	Grade 8		U04160	1-54
UNF	Sześciokąt	St	Grade 8	Ocyнк. żłt. pas.	U04360	1-56
UNF	Sześciokąt	St.St. A2 (AISI304/18-8)	F593		U51007	1-57

U01060 Śruby z łbem sześciokątnym UNF

X01A

Gwint Calowy, zunifikowany drobnozwojny (UNF)
Materiał Stal
Klasa Grade 5

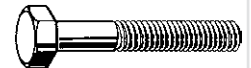

d x L	☒	Kod artykułu	d x L	☒	Kod artykułu	d x L	☒	Kod artykułu
1/4-28X1/2 ft*	100	U01060.025.0050	5/16-24X1.1/4*	100	U01060.031.0125	3/8-24X3 Inch*	25	U01060.037.0300
1/4-28X5/8 ft*	100	U01060.025.0062	5/16-24X1.1/2*	100	U01060.031.0150	3/8-24X3.1/4*	25	U01060.037.0325
1/4-28X3/4 ft*	100	U01060.025.0075	5/16-24X1.3/4*	50	U01060.031.0175	3/8-24X3.1/2*	25	U01060.037.0350
1/4-28X7/8*	100	U01060.025.0087	5/16-24X2 Inch*	50	U01060.031.0200	3/8-24X3.3/4*	25	U01060.037.0375
1/4-28X1 Inch*	100	U01060.025.0100	5/16-24X2.1/4*	50	U01060.031.0225	3/8-24X4 Inch*	10	U01060.037.0400
1/4-28X1.1/4*	100	U01060.025.0125	5/16-24X2.1/2*	50	U01060.031.0250	3/8-24X4.1/4*	10	U01060.037.0425
1/4-28X1.3/8*	100	U01060.025.0137	5/16-24X2.3/4*	50	U01060.031.0275	3/8-24X4.1/2*	10	U01060.037.0450
1/4-28X1.1/2*	100	U01060.025.0150	5/16-24X3 Inch*	50	U01060.031.0300	3/8-24X4.3/4*	10	U01060.037.0475
1/4-28X1.3/4*	100	U01060.025.0175	5/16-24X3.1/4*	50	U01060.031.0325	3/8-24X5 Inch*	10	U01060.037.0500
1/4-28X2 Inch*	50	U01060.025.0200	5/16-24X3.1/2*	50	U01060.031.0350	3/8-24X5.1/4*	10	U01060.037.0525
1/4-28X2.1/4*	50	U01060.025.0225	5/16-24X3.3/4*	25	U01060.031.0375	3/8-24X5.1/2*	10	U01060.037.0550
1/4-28X2.1/2*	50	U01060.025.0250	5/16-24X4 Inch*	25	U01060.031.0400	3/8-24X5.3/4*	10	U01060.037.0575
1/4-28X2.3/4*	50	U01060.025.0275	5/16-24X4.1/2*	25	U01060.031.0450	3/8-24X6 Inch*	10	U01060.037.0600
1/4-28X3 Inch*	50	U01060.025.0300	5/16-24X5 Inch*	25	U01060.031.0500	3/8-24X6.1/2*	10	U01060.037.0650
1/4-28X3.1/4*	50	U01060.025.0325	5/16-24X5.1/2*	25	U01060.031.0550	3/8-24X8 Inch*	5	U01060.037.0800
1/4-28X3.1/2*	50	U01060.025.0350	5/16-24X6 Inch*	25	U01060.031.0600	3/8-24X10 Inch*	5	U01060.037.1000
1/4-28X3.3/4*	50	U01060.025.0375	5/16-24X7 Inch*	10	U01060.031.0700			
1/4-28X4 Inch*	25	U01060.025.0400				7/16-20X3/4 ft*	25	U01060.043.0075
1/4-28X4.1/2*	25	U01060.025.0450	3/8-24X1/2 ft*	50	U01060.037.0050	7/16-20X7/8 ft*	25	U01060.043.0087
1/4-28X5 Inch*	25	U01060.025.0500	3/8-24X5/8 ft*	50	U01060.037.0062	7/16-20X1 Inch ft*	25	U01060.043.0100
1/4-28X5.1/2*	25	U01060.025.0550	3/8-24X3/4 ft*	50	U01060.037.0075	7/16-20X1.1/4*	25	U01060.043.0125
1/4-28X6 Inch*	25	U01060.025.0600	3/8-24X7/8 ft*	50	U01060.037.0087	7/16-20X1.1/2*	25	U01060.043.0150
1/4-28X7 Inch*	10	U01060.025.0700	3/8-24X1 Inch ft*	50	U01060.037.0100	7/16-20X1.3/4*	25	U01060.043.0175
1/4-28X8 Inch*	5	U01060.025.0800	3/8-24X1.1/4*	50	U01060.037.0125	7/16-20X2 Inch*	25	U01060.043.0200
			3/8-24X1.1/2*	50	U01060.037.0150	7/16-20X2.1/4*	10	U01060.043.0225
5/16-24X1/2 ft*	100	U01060.031.0050	3/8-24X1.3/4*	50	U01060.037.0175	7/16-20X2.1/2*	10	U01060.043.0250
5/16-24X5/8 ft*	100	U01060.031.0062	3/8-24X2 Inch*	25	U01060.037.0200	7/16-20X2.3/4*	10	U01060.043.0275
5/16-24X3/4 ft*	100	U01060.031.0075	3/8-24X2.1/4*	25	U01060.037.0225	7/16-20X3 Inch*	10	U01060.043.0300
5/16-24X7/8 ft*	100	U01060.031.0087	3/8-24X2.1/2*	25	U01060.037.0250	7/16-20X3.1/4*	10	U01060.043.0325
5/16-24X1 Inch*	100	U01060.031.0100	3/8-24X2.3/4*	25	U01060.037.0275	7/16-20X3.1/2*	10	U01060.043.0350

U01060 Śruby z łbem sześciokątnym UNF								
d x L	☒	Kod artykułu	d x L	☒	Kod artykułu	d x L	☒	Kod artykułu
7/16-20X3.3/4*	10	U01060.043.0375	5/8-18X1.1/4 ft*	10	U01060.062.0125	7/8-14X2.3/4*	5	U01060.087.0275
7/16-20X4 Inch*	10	U01060.043.0400	5/8-18X1.1/2 ft*	10	U01060.062.0150	7/8-14X3 Inch*	5	U01060.087.0300
7/16-20X4.1/2*	10	U01060.043.0450	5/8-18X1.3/4*	10	U01060.062.0175	7/8-14X3.1/4*	5	U01060.087.0325
7/16-20X5 Inch*	10	U01060.043.0500	5/8-18X2 Inch*	5	U01060.062.0200	7/8-14X3.1/2*	5	U01060.087.0350
7/16-20X5.1/2*	10	U01060.043.0550	5/8-18X2.1/4*	5	U01060.062.0225	7/8-14X3.3/4*	5	U01060.087.0375
7/16-20X6 Inch*	5	U01060.043.0600	5/8-18X2.1/2*	5	U01060.062.0250	7/8-14X4 Inch*	5	U01060.087.0400
7/16-20X6.1/2*	5	U01060.043.0650	5/8-18X2.3/4*	5	U01060.062.0275	7/8-14X4.1/2*	5	U01060.087.0450
7/16-20X8 Inch*	5	U01060.043.0800	5/8-18X3 Inch*	5	U01060.062.0300	7/8-14X5 Inch*	5	U01060.087.0500
			5/8-18X3.1/4*	5	U01060.062.0325	7/8-14X5.1/2*	5	U01060.087.0550
1/2-20X3/4 ft*	25	U01060.050.0075	5/8-18X3.1/2*	5	U01060.062.0350	7/8-14X6 Inch*	1	U01060.087.0600
1/2-20X7/8 ft*	25	U01060.050.0087	5/8-18X3.3/4*	5	U01060.062.0375	7/8-14X6.1/2*	1	U01060.087.0650
1/2-20X1 Inch ft*	25	U01060.050.0100	5/8-18X4 Inch*	5	U01060.062.0400	7/8-14X7 Inch*	1	U01060.087.0700
1/2-20X1.1/4 ft*	25	U01060.050.0125	5/8-18X4.1/4*	5	U01060.062.0425	7/8-14X7.1/2*	1	U01060.087.0750
1/2-20X1.1/2*	25	U01060.050.0150	5/8-18X4.1/2*	5	U01060.062.0450			
1/2-20X1.3/4*	25	U01060.050.0175	5/8-18X4.3/4*	5	U01060.062.0475	1.-14X1.1/2*	5	U01060.101.0150
1/2-20X2 Inch*	10	U01060.050.0200	5/8-18X5 Inch*	5	U01060.062.0500	1.-14X1.3/4*	5	U01060.101.0175
1/2-20X2.1/4*	10	U01060.050.0225	5/8-18X5.1/2*	5	U01060.062.0550	1.-14X2 Inch*	5	U01060.101.0200
1/2-20X2.1/2*	10	U01060.050.0250	5/8-18X6 Inch*	5	U01060.062.0600	1.-14X2.1/4*	5	U01060.101.0225
1/2-20X2.3/4*	10	U01060.050.0275	5/8-18X6.1/2*	5	U01060.062.0650	1.-14X2.1/2*	5	U01060.101.0250
1/2-20X3 Inch*	10	U01060.050.0300	5/8-18X7 Inch*	5	U01060.062.0700	1.-14X2.3/4*	5	U01060.101.0275
1/2-20X3.1/4*	10	U01060.050.0325	5/8-18X7.1/2*	5	U01060.062.0750	1.-14X3 Inch*	5	U01060.101.0300
1/2-20X3.1/2*	10	U01060.050.0350	5/8-18X8 Inch*	5	U01060.062.0800	1.-14X3.1/4*	5	U01060.101.0325
1/2-20X3.3/4*	10	U01060.050.0375	5/8-18X9 Inch*	5	U01060.062.0900	1.-14X3.1/2*	5	U01060.101.0350
1/2-20X4 Inch*	5	U01060.050.0400	5/8-18X10 Inch*	5	U01060.062.1000	1.-14X3.3/4*	5	U01060.101.0375
1/2-20X4.1/4*	5	U01060.050.0425	5/8-18X12 Inch*	5	U01060.062.1200	1.-14X4 Inch*	5	U01060.101.0400
1/2-20X4.1/2*	5	U01060.050.0450				1.-14X4.1/2*	5	U01060.101.0450
1/2-20X4.3/4*	5	U01060.050.0475	3/4-16X1 Inch ft*	10	U01060.075.0100	1.-14X5 Inch*	5	U01060.101.0500
1/2-20X5 Inch*	5	U01060.050.0500	3/4-16X1.1/4 ft*	10	U01060.075.0125	1.-14X5.1/2*	5	U01060.101.0550
1/2-20X5.1/2*	5	U01060.050.0550	3/4-16X1.1/2 ft*	10	U01060.075.0150	1.-14X6 Inch*	1	U01060.101.0600
1/2-20X6 Inch*	5	U01060.050.0600	3/4-16X1.3/4 ft*	10	U01060.075.0175	1.-14X7 Inch*	1	U01060.101.0700
1/2-20X6.1/2*	5	U01060.050.0650	3/4-16X2 Inch*	5	U01060.075.0200	1.-14X8 Inch*	1	U01060.101.0800
1/2-20X7 Inch*	5	U01060.050.0700	3/4-16X2.1/4*	5	U01060.075.0225			
1/2-20X7.1/2*	5	U01060.050.0750	3/4-16X2.1/2*	5	U01060.075.0250	1.1/8-12X3.1/2*	1	U01060.112.0350
1/2-20X8 Inch*	5	U01060.050.0800	3/4-16X2.3/4*	5	U01060.075.0275	1.1/8-12X4.1/2*	1	U01060.112.0450
1/2-20X10 Inch*	5	U01060.050.1000	3/4-16X3 Inch*	5	U01060.075.0300	1.1/8-12X7 Inch*	1	U01060.112.0700
1/2-20X12 Inch*	5	U01060.050.1200	3/4-16X3.1/4*	5	U01060.075.0325	1.1/8-12X8 Inch*	1	U01060.112.0800
			3/4-16X3.1/2*	5	U01060.075.0350			
9/16-18X1 Inch ft*	25	U01060.056.0100	3/4-16X3.3/4*	5	U01060.075.0375	1.1/4-12X2 Inch ft*	1	U01060.125.0200
9/16-18X1.1/4 ft*	25	U01060.056.0125	3/4-16X4 Inch*	5	U01060.075.0400	1.1/4-12X3 Inch*	1	U01060.125.0300
9/16-18X1.1/2*	25	U01060.056.0150	3/4-16X4.1/4*	5	U01060.075.0425	1.1/4-12X3.1/2*	1	U01060.125.0350
9/16-18X1.3/4*	10	U01060.056.0175	3/4-16X4.1/2*	5	U01060.075.0450	1.1/4-12X4 Inch*	1	U01060.125.0400
9/16-18X2 Inch*	10	U01060.056.0200	3/4-16X4.3/4*	5	U01060.075.0475	1.1/4-12X4.1/2*	1	U01060.125.0450
9/16-18X2.1/4*	10	U01060.056.0225	3/4-16X5 Inch*	5	U01060.075.0500	1.1/4-12X5 Inch*	1	U01060.125.0500
9/16-18X2.1/2*	10	U01060.056.0250	3/4-16X5.1/2*	5	U01060.075.0550	1.1/4-12X5.1/2*	1	U01060.125.0550
9/16-18X2.3/4*	10	U01060.056.0275	3/4-16X6 Inch*	5	U01060.075.0600	1.1/4-12X6 Inch*	1	U01060.125.0600
9/16-18X3 Inch*	10	U01060.056.0300	3/4-16X6.1/2*	1	U01060.075.0650	1.1/4-12X7 Inch*	1	U01060.125.0700
9/16-18X3.1/4*	10	U01060.056.0325	3/4-16X7 Inch*	5	U01060.075.0700	1.1/4-12X8 Inch*	1	U01060.125.0800
9/16-18X3.1/2*	10	U01060.056.0350	3/4-16X8 Inch*	1	U01060.075.0800	1.1/4-12X9 Inch*	1	U01060.125.0900
9/16-18X3.3/4*	10	U01060.056.0375	3/4-16X9 Inch*	5	U01060.075.0900			
9/16-18X4 Inch*	5	U01060.056.0400	3/4-16X10 Inch*	1	U01060.075.1000	1.1/2-12X3 Inch ft*	1	U01060.150.0300
9/16-18X4.1/2*	5	U01060.056.0450				1.1/2-12X4 Inch*	1	U01060.150.0400
9/16-18X5 Inch*	5	U01060.056.0500	7/8-14X1.1/2 ft*	5	U01060.087.0150	1.1/2-12X5 Inch*	1	U01060.150.0500
9/16-18X5.1/2*	5	U01060.056.0550	7/8-14X1.3/4 ft*	5	U01060.087.0175	1.1/2-12X6 Inch*	1	U01060.150.0600
9/16-18X6 Inch*	5	U01060.056.0600	7/8-14X2 Inch ft*	5	U01060.087.0200	1.1/2-12X7 Inch*	1	U01060.150.0700
			7/8-14X2.1/4*	5	U01060.087.0225	1.1/2-12X10 Inch*	1	U01060.150.1000
5/8-18X1 Inch ft*	10	U01060.062.0100	7/8-14X2.1/2*	5	U01060.087.0250			

* ft = z pełnym gwintem

U01062 Śruby z łbem sześciokątnym UNF			X01A	
Gwint	Całowy, zunifikowany drobnozwojny (UNF)			
Materiał	Stal			
Klasa	Grade 5			
Obróbka powierzchni	O cynkowane			

d x L	☒	Kod artykułu	d x L	☒	Kod artykułu	d x L	☒	Kod artykułu
1/4-28X1/2 ft*	100	U01062.025.0050	1/4-28X3 Inch*	50	U01062.025.0300	5/16-24X3/4 ft*	100	U01062.031.0075
1/4-28X5/8 ft*	100	U01062.025.0062	1/4-28X3.1/4*	50	U01062.025.0325	5/16-24X1 Inch*	100	U01062.031.0100
1/4-28X3/4 ft*	100	U01062.025.0075	1/4-28X3.1/2*	50	U01062.025.0350	5/16-24X1.1/4*	100	U01062.031.0125
1/4-28X7/8*	100	U01062.025.0087	1/4-28X3.3/4*	50	U01062.025.0375	5/16-24X1.1/2*	100	U01062.031.0150
1/4-28X1 Inch*	100	U01062.025.0100	1/4-28X4 Inch*	25	U01062.025.0400	5/16-24X1.3/4*	50	U01062.031.0175
1/4-28X1.1/4*	100	U01062.025.0125	1/4-28X4.1/2*	25	U01062.025.0450	5/16-24X2 Inch*	50	U01062.031.0200
1/4-28X1.3/8*	100	U01062.025.0137	1/4-28X5 Inch*	25	U01062.025.0500	5/16-24X2.1/4*	50	U01062.031.0225
1/4-28X1.1/2*	100	U01062.025.0150	1/4-28X5.1/2*	25	U01062.025.0550	5/16-24X2.1/2*	50	U01062.031.0250
1/4-28X1.3/4*	100	U01062.025.0175	1/4-28X6 Inch*	25	U01062.025.0600	5/16-24X2.3/4*	50	U01062.031.0275
1/4-28X2 Inch*	50	U01062.025.0200	1/4-28X7 Inch*	10	U01062.025.0700	5/16-24X3 Inch*	50	U01062.031.0300
1/4-28X2.1/4*	50	U01062.025.0225				5/16-24X3.1/2*	50	U01062.031.0350
1/4-28X2.1/2*	50	U01062.025.0250	5/16-24X1/2 ft*	100	U01062.031.0050	5/16-24X4 Inch*	25	U01062.031.0400
1/4-28X2.3/4*	50	U01062.025.0275	5/16-24X5/8 ft*	100	U01062.031.0062	5/16-24X4.1/2*	25	U01062.031.0450

U01062		Śruby z łbem sześciokątnym UNF						←
d x L	☒	Kod artykułu	d x L	☒	Kod artykułu	d x L	☒	Kod artykułu
5/16-24X5 Inch*	25	U01062.031.0500	1/2-20X3/4 ft*	25	U01062.050.0075	5/8-18X4.3/4*	5	U01062.062.0475
5/16-24X5.1/2*	25	U01062.031.0550	1/2-20X1 Inch ft*	25	U01062.050.0100	5/8-18X5 Inch*	5	U01062.062.0500
5/16-24X6 Inch*	25	U01062.031.0600	1/2-20X1.1/4 ft*	25	U01062.050.0125	5/8-18X5.1/2*	5	U01062.062.0550
3/8-24X1/2 ft*	50	U01062.037.0050	1/2-20X1.1/2*	25	U01062.050.0150	5/8-18X6 Inch*	5	U01062.062.0600
3/8-24X5/8 ft*	50	U01062.037.0062	1/2-20X2 Inch*	10	U01062.050.0200	5/8-18X7 Inch*	5	U01062.062.0700
3/8-24X3/4 ft*	50	U01062.037.0075	1/2-20X2.1/4*	10	U01062.050.0225	5/8-18X8 Inch*	5	U01062.062.0800
3/8-24X7/8 ft*	50	U01062.037.0087	1/2-20X2.1/2*	10	U01062.050.0250	5/8-18X8.1/2*	5	U01062.062.0850
3/8-24X1 Inch ft*	50	U01062.037.0100	1/2-20X2.3/4*	10	U01062.050.0275	5/8-18X9 Inch*	5	U01062.062.0900
3/8-24X1.1/4*	50	U01062.037.0125	1/2-20X3 Inch*	10	U01062.050.0300	5/8-18X10 Inch*	5	U01062.062.1000
3/8-24X1.1/2*	50	U01062.037.0150	1/2-20X3.1/2*	10	U01062.050.0350			
3/8-24X1.3/4*	50	U01062.037.0175	1/2-20X4 Inch*	5	U01062.050.0400	3/4-16X1 Inch ft*	10	U01062.075.0100
3/8-24X2 Inch*	25	U01062.037.0200	1/2-20X4.1/4*	5	U01062.050.0425	3/4-16X1.1/2 ft*	10	U01062.075.0150
3/8-24X2.1/4*	25	U01062.037.0225	1/2-20X4.1/2*	5	U01062.050.0450	3/4-16X2 Inch*	5	U01062.075.0200
3/8-24X2.1/2*	25	U01062.037.0250	1/2-20X4.3/4*	5	U01062.050.0475	3/4-16X2.1/4*	5	U01062.075.0225
3/8-24X2.3/4*	25	U01062.037.0275	1/2-20X5 Inch*	5	U01062.050.0500	3/4-16X2.1/2*	5	U01062.075.0250
3/8-24X3 Inch*	25	U01062.037.0300	1/2-20X5.1/2*	5	U01062.050.0550	3/4-16X2.3/4*	5	U01062.075.0275
3/8-24X3.1/2*	25	U01062.037.0350	1/2-20X6 Inch*	5	U01062.050.0600	3/4-16X3 Inch*	5	U01062.075.0300
3/8-24X4 Inch*	10	U01062.037.0400	1/2-20X7 Inch*	5	U01062.050.0700	3/4-16X3.1/2*	5	U01062.075.0350
3/8-24X4.1/4*	10	U01062.037.0425	1/2-20X8 Inch*	5	U01062.050.0800	3/4-16X4 Inch*	5	U01062.075.0400
3/8-24X4.1/2*	10	U01062.037.0450	1/2-20X10 Inch*	5	U01062.050.1000	3/4-16X4.1/4*	5	U01062.075.0425
3/8-24X4.3/4*	10	U01062.037.0475	1/2-20X12 Inch*	5	U01062.050.1200	3/4-16X4.1/2*	5	U01062.075.0450
3/8-24X5 Inch*	10	U01062.037.0500				3/4-16X4.3/4*	5	U01062.075.0475
3/8-24X5.1/4*	10	U01062.037.0525	9/16-18X1 Inch ft*	25	U01062.056.0100	3/4-16X5 Inch*	5	U01062.075.0500
3/8-24X5.1/2*	10	U01062.037.0550	9/16-18X1.1/2*	25	U01062.056.0150	3/4-16X5.1/2*	5	U01062.075.0550
3/8-24X5.3/4*	10	U01062.037.0575	9/16-18X1.3/4*	10	U01062.056.0175	3/4-16X6 Inch*	5	U01062.075.0600
3/8-24X6 Inch*	10	U01062.037.0600	9/16-18X2 Inch*	10	U01062.056.0200	3/4-16X6.1/2*	1	U01062.075.0650
3/8-24X6.1/2*	10	U01062.037.0650	9/16-18X2.1/2*	10	U01062.056.0250	3/4-16X8 Inch*	1	U01062.075.0800
3/8-24X8 Inch*	5	U01062.037.0800	9/16-18X3 Inch*	10	U01062.056.0300			
3/8-24X10 Inch*	5	U01062.037.1000	9/16-18X3.1/2*	10	U01062.056.0350	7/8-14X2 Inch ft*	5	U01062.087.0200
			9/16-18X4 Inch*	5	U01062.056.0400	7/8-14X2.1/2*	5	U01062.087.0250
			9/16-18X4.1/2*	5	U01062.056.0450	7/8-14X3 Inch*	5	U01062.087.0300
			9/16-18X5 Inch*	5	U01062.056.0500	7/8-14X3.1/2*	5	U01062.087.0350
			9/16-18X6 Inch*	5	U01062.056.0600	7/8-14X4 Inch*	5	U01062.087.0400
						7/8-14X5 Inch*	5	U01062.087.0500
			5/8-18X1 Inch ft*	10	U01062.062.0100	7/8-14X5.1/2*	5	U01062.087.0550
			5/8-18X1.1/2 ft*	10	U01062.062.0150	7/8-14X6 Inch*	1	U01062.087.0600
			5/8-18X1.3/4*	10	U01062.062.0175	7/8-14X7 Inch*	1	U01062.087.0700
			5/8-18X2 Inch*	5	U01062.062.0200	7/8-14X8 Inch*	1	U01062.087.0800
			5/8-18X2.1/4*	5	U01062.062.0225			
			5/8-18X2.1/2*	5	U01062.062.0250	1.-14X2 Inch ft*	5	U01062.101.0200
			5/8-18X2.3/4*	5	U01062.062.0275	1.-14X3.1/2*	5	U01062.101.0350
			5/8-18X3 Inch*	5	U01062.062.0300	1.-14X4 Inch*	5	U01062.101.0400
			5/8-18X3.1/4*	5	U01062.062.0325	1.-14X5 Inch*	5	U01062.101.0500
			5/8-18X3.1/2*	5	U01062.062.0350	1.-14X6 Inch*	1	U01062.101.0600
			5/8-18X4 Inch*	5	U01062.062.0400	1.-14X8 Inch*	1	U01062.101.0800
			5/8-18X4.1/4*	5	U01062.062.0425			
			5/8-18X4.1/2*	5	U01062.062.0450			

* ft = z pełnym gwintem

U04160		Śruby z łbem sześciokątnym UNF						X01A
Gwint	Całowy, zunifikowany drobnozwojny (UNF)							
Materiał	Stal							
Klasa	Grade 8							

d x L	☒	Kod artykułu	d x L	☒	Kod artykułu	d x L	☒	Kod artykułu
1/4-28X1/2 ft*	100	U04160.025.0050	1/4-28X7 Inch*	10	U04160.025.0700	5/16-24X6 Inch*	25	U04160.031.0600
1/4-28X5/8 ft*	100	U04160.025.0062				5/16-24X7 Inch*	10	U04160.031.0700
1/4-28X3/4 ft*	100	U04160.025.0075	5/16-24X1/2 ft*	100	U04160.031.0050			
1/4-28X7/8*	100	U04160.025.0087	5/16-24X5/8 ft*	100	U04160.031.0062	3/8-24X1/2 ft*	50	U04160.037.0050
1/4-28X1 Inch*	100	U04160.025.0100	5/16-24X5/8 ft*	100	U04160.031.0075	3/8-24X5/8 ft*	50	U04160.037.0062
1/4-28X1.1/4*	100	U04160.025.0125	5/16-24X3/4 ft*	100	U04160.031.0087	3/8-24X3/4 ft*	50	U04160.037.0075
1/4-28X1.3/8*	100	U04160.025.0137	5/16-24X7/8 ft*	100	U04160.031.0087	3/8-24X7/8 ft*	50	U04160.037.0087
1/4-28X1.1/2*	100	U04160.025.0150	5/16-24X1 Inch*	100	U04160.031.0100	3/8-24X7/8 ft*	50	U04160.037.0087
1/4-28X1.3/4*	100	U04160.025.0175	5/16-24X1 Inch*	100	U04160.031.0100	3/8-24X1 Inch ft*	50	U04160.037.0100
1/4-28X2 Inch*	50	U04160.025.0200	5/16-24X1.1/4*	100	U04160.031.0125	3/8-24X1.1/4*	50	U04160.037.0125
1/4-28X2.1/4*	50	U04160.025.0225	5/16-24X1.1/2*	100	U04160.031.0150	3/8-24X1.1/2*	50	U04160.037.0150
1/4-28X2.1/2*	50	U04160.025.0250	5/16-24X1.3/4*	50	U04160.031.0175	3/8-24X1.3/4*	50	U04160.037.0175
1/4-28X2.3/4*	50	U04160.025.0275	5/16-24X2 Inch*	50	U04160.031.0200	3/8-24X2 Inch*	25	U04160.037.0200
1/4-28X3 Inch*	50	U04160.025.0300	5/16-24X2.1/4*	50	U04160.031.0225	3/8-24X2.1/4*	25	U04160.037.0225
1/4-28X3.1/4*	50	U04160.025.0325	5/16-24X2.1/2*	50	U04160.031.0250	3/8-24X2.1/2*	25	U04160.037.0250
1/4-28X3.1/2*	50	U04160.025.0350	5/16-24X2.3/4*	50	U04160.031.0275	3/8-24X2.3/4*	25	U04160.037.0275
1/4-28X3.3/4*	50	U04160.025.0375	5/16-24X3 Inch*	50	U04160.031.0300	3/8-24X2.3/4*	25	U04160.037.0275
1/4-28X4 Inch*	25	U04160.025.0400	5/16-24X3.1/4*	50	U04160.031.0325	3/8-24X3 Inch*	25	U04160.037.0300
1/4-28X4.1/2*	25	U04160.025.0450	5/16-24X3.1/2*	50	U04160.031.0350	3/8-24X3.1/4*	25	U04160.037.0325
1/4-28X5 Inch*	25	U04160.025.0500	5/16-24X3.3/4*	25	U04160.031.0375	3/8-24X3.1/2*	25	U04160.037.0350
1/4-28X5.1/2*	25	U04160.025.0550	5/16-24X4 Inch*	25	U04160.031.0400	3/8-24X3.3/4*	25	U04160.037.0375
1/4-28X6 Inch*	25	U04160.025.0600	5/16-24X4.1/2*	25	U04160.031.0450	3/8-24X4 Inch*	10	U04160.037.0400
			5/16-24X5 Inch*	25	U04160.031.0500	3/8-24X4.1/4*	10	U04160.037.0425
			5/16-24X5.1/2*	25	U04160.031.0550	3/8-24X4.1/2*	10	U04160.037.0450

U04160 Śruby z łbem sześciokątnym UNF								
d x L	☒	Kod artykułu	d x L	☒	Kod artykułu	d x L	☒	Kod artykułu
3/8-24X4.3/4*	10	U04160.037.0475	9/16-18X5.1/2*	5	U04160.056.0550	7/8-14X4 Inch*	5	U04160.087.0400
3/8-24X5 Inch*	10	U04160.037.0500	9/16-18X6 Inch*	5	U04160.056.0600	7/8-14X4.1/2*	5	U04160.087.0450
3/8-24X5.1/4*	10	U04160.037.0525				7/8-14X5 Inch*	5	U04160.087.0500
3/8-24X5.1/2*	10	U04160.037.0550	5/8-18X1 Inch ft*	10	U04160.062.0100	7/8-14X5.1/2*	5	U04160.087.0550
3/8-24X5.3/4*	10	U04160.037.0575	5/8-18X1.1/4 ft*	10	U04160.062.0125	7/8-14X6 Inch*	1	U04160.087.0600
3/8-24X6 Inch*	10	U04160.037.0600	5/8-18X1.1/2 ft*	10	U04160.062.0150	7/8-14X6.1/2*	1	U04160.087.0650
3/8-24X6.1/2*	10	U04160.037.0650	5/8-18X1.3/4*	10	U04160.062.0175	7/8-14X7 Inch*	1	U04160.087.0700
3/8-24X8 Inch*	5	U04160.037.0800	5/8-18X2 Inch*	5	U04160.062.0200	7/8-14X7.1/2*	1	U04160.087.0750
3/8-24X10 Inch*	5	U04160.037.1000	5/8-18X2.1/4*	5	U04160.062.0225	7/8-14X8 Inch*	1	U04160.087.0800
			5/8-18X2.1/2*	5	U04160.062.0250	7/8-14X8.1/2*	1	U04160.087.0850
			5/8-18X2.3/4*	5	U04160.062.0275	7/8-14X9 Inch*	1	U04160.087.0900
7/16-20X3/4 ft*	25	U04160.043.0075	5/8-18X3 Inch*	5	U04160.062.0300	7/8-14X10 Inch*	1	U04160.087.1000
7/16-20X1 Inch ft*	25	U04160.043.0100	5/8-18X3.1/4*	5	U04160.062.0325			
7/16-20X1.1/4*	25	U04160.043.0125	5/8-18X3.1/2*	5	U04160.062.0350	1.-14X1.1/2 ft*	5	U04160.101.0150
7/16-20X1.1/2*	25	U04160.043.0150	5/8-18X3.3/4*	5	U04160.062.0375	1.-14X1.3/4 ft*	5	U04160.101.0175
7/16-20X1.3/4*	25	U04160.043.0175	5/8-18X4 Inch*	5	U04160.062.0400	1.-14X2 Inch ft*	5	U04160.101.0200
7/16-20X2 Inch*	25	U04160.043.0200	5/8-18X4.1/4*	5	U04160.062.0425	1.-14X2.1/4 ft*	5	U04160.101.0225
7/16-20X2.1/4*	10	U04160.043.0225	5/8-18X4.1/2*	5	U04160.062.0450	1.-14X2.1/2*	5	U04160.101.0250
7/16-20X2.1/2*	10	U04160.043.0250	5/8-18X4.3/4*	5	U04160.062.0475	1.-14X2.3/4*	5	U04160.101.0275
7/16-20X2.3/4*	10	U04160.043.0275	5/8-18X5 Inch*	5	U04160.062.0500	1.-14X3 Inch*	5	U04160.101.0300
7/16-20X3 Inch*	10	U04160.043.0300	5/8-18X5.1/2*	5	U04160.062.0550	1.-14X3.1/4*	5	U04160.101.0325
7/16-20X3.1/4*	10	U04160.043.0325	5/8-18X6 Inch*	5	U04160.062.0600	1.-14X3.1/2*	5	U04160.101.0350
7/16-20X3.1/2*	10	U04160.043.0350	5/8-18X6.1/2*	5	U04160.062.0650	1.-14X3.3/4*	5	U04160.101.0375
7/16-20X3.3/4*	10	U04160.043.0375	5/8-18X7 Inch*	5	U04160.062.0700	1.-14X4 Inch*	5	U04160.101.0400
7/16-20X4 Inch*	10	U04160.043.0400	5/8-18X7.1/2*	5	U04160.062.0750	1.-14X4.1/2*	5	U04160.101.0450
7/16-20X4.1/2*	10	U04160.043.0450	5/8-18X8 Inch*	5	U04160.062.0800	1.-14X5 Inch*	5	U04160.101.0500
7/16-20X5 Inch*	10	U04160.043.0500	5/8-18X8.1/2*	5	U04160.062.0850	1.-14X5.1/2*	5	U04160.101.0550
7/16-20X5.1/2*	10	U04160.043.0550	5/8-18X9 Inch*	5	U04160.062.0900	1.-14X6 Inch*	1	U04160.101.0600
7/16-20X6 Inch*	5	U04160.043.0600	5/8-18X9.1/2*	5	U04160.062.0950	1.-14X6.1/2*	1	U04160.101.0650
			5/8-18X10 Inch*	5	U04160.062.1000	1.-14X7 Inch*	1	U04160.101.0700
1/2-20X3/4 ft*	25	U04160.050.0075	5/8-18X11 Inch*	5	U04160.062.1100	1.-14X7.1/2*	1	U04160.101.0750
1/2-20X1 Inch ft*	25	U04160.050.0100	5/8-18X12 Inch*	5	U04160.062.1200	1.-14X8 Inch*	1	U04160.101.0800
1/2-20X1.1/4 ft*	25	U04160.050.0125				1.-14X8.1/2*	1	U04160.101.0850
1/2-20X1.1/2*	25	U04160.050.0150	3/4-16X1 Inch ft*	10	U04160.075.0100	1.-14X9 Inch*	1	U04160.101.0900
1/2-20X1.3/4*	25	U04160.050.0175	3/4-16X1.1/4 ft*	10	U04160.075.0125	1.-14X9.1/2*	1	U04160.101.0950
1/2-20X2 Inch*	10	U04160.050.0200	3/4-16X1.1/2 ft*	10	U04160.075.0150	1.-14X10 Inch*	1	U04160.101.1000
1/2-20X2.1/4*	10	U04160.050.0225	3/4-16X1.3/4 ft*	10	U04160.075.0175			
1/2-20X2.1/2*	10	U04160.050.0250	3/4-16X2 Inch*	5	U04160.075.0200	1.1/8-12X2.1/2 ft*	1	U04160.112.0250
1/2-20X2.3/4*	10	U04160.050.0275	3/4-16X2.1/4*	5	U04160.075.0225	1.1/8-12X3 Inch*	1	U04160.112.0300
1/2-20X3 Inch*	10	U04160.050.0300	3/4-16X2.1/2*	5	U04160.075.0250	1.1/8-12X3.1/2*	1	U04160.112.0350
1/2-20X3.1/4*	10	U04160.050.0325	3/4-16X2.3/4*	5	U04160.075.0275	1.1/8-12X4 Inch*	1	U04160.112.0400
1/2-20X3.1/2*	10	U04160.050.0350	3/4-16X3 Inch*	5	U04160.075.0300	1.1/8-12X4.1/2*	1	U04160.112.0450
1/2-20X3.3/4*	10	U04160.050.0375	3/4-16X3.1/4*	5	U04160.075.0325	1.1/8-12X5 Inch*	1	U04160.112.0500
1/2-20X4 Inch*	5	U04160.050.0400	3/4-16X3.1/2*	5	U04160.075.0350	1.1/8-12X5.1/2*	1	U04160.112.0550
1/2-20X4.1/4*	5	U04160.050.0425	3/4-16X3.3/4*	5	U04160.075.0375	1.1/8-12X6 Inch*	1	U04160.112.0600
1/2-20X4.1/2*	5	U04160.050.0450	3/4-16X4 Inch*	5	U04160.075.0400	1.1/8-12X7 Inch*	1	U04160.112.0700
1/2-20X4.3/4*	5	U04160.050.0475	3/4-16X4.1/4*	5	U04160.075.0425	1.1/8-12X8 Inch*	1	U04160.112.0800
1/2-20X5 Inch*	5	U04160.050.0500	3/4-16X4.1/2*	5	U04160.075.0450	1.1/8-12X10 Inch*	1	U04160.112.1000
1/2-20X5.1/2*	5	U04160.050.0550	3/4-16X4.3/4*	5	U04160.075.0475			
1/2-20X6 Inch*	5	U04160.050.0600	3/4-16X5 Inch*	5	U04160.075.0500	1.1/4-12X2 Inch ft*	1	U04160.125.0200
1/2-20X6.1/2*	5	U04160.050.0650	3/4-16X5.1/2*	5	U04160.075.0550	1.1/4-12X3 Inch*	1	U04160.125.0300
1/2-20X7 Inch*	5	U04160.050.0700	3/4-16X6 Inch*	5	U04160.075.0600	1.1/4-12X3.1/2*	1	U04160.125.0350
1/2-20X7.1/2*	5	U04160.050.0750	3/4-16X6.1/2*	1	U04160.075.0650	1.1/4-12X4 Inch*	1	U04160.125.0400
1/2-20X8 Inch*	5	U04160.050.0800	3/4-16X7 Inch*	1	U04160.075.0700	1.1/4-12X4.1/2*	1	U04160.125.0450
1/2-20X8.1/2*	5	U04160.050.0850	3/4-16X7.1/2*	1	U04160.075.0750	1.1/4-12X5 Inch*	1	U04160.125.0500
1/2-20X10 Inch*	5	U04160.050.1000	3/4-16X8 Inch*	1	U04160.075.0800	1.1/4-12X5.1/2*	1	U04160.125.0550
1/2-20X12 Inch*	5	U04160.050.1200	3/4-16X8.1/2*	1	U04160.075.0850	1.1/4-12X6 Inch*	1	U04160.125.0600
			3/4-16X9 Inch*	1	U04160.075.0900	1.1/4-12X7 Inch*	1	U04160.125.0700
9/16-18X1 Inch ft*	25	U04160.056.0100	3/4-16X9.1/2*	1	U04160.075.0950	1.1/4-12X7.1/2*	1	U04160.125.0750
9/16-18X1.1/4 ft*	25	U04160.056.0125	3/4-16X10 Inch*	1	U04160.075.1000	1.1/4-12X8 Inch*	1	U04160.125.0800
9/16-18X1.1/2*	25	U04160.056.0150	3/4-16X11 Inch*	1	U04160.075.1100	1.1/4-12X9 Inch*	1	U04160.125.0900
9/16-18X1.3/4*	10	U04160.056.0175	3/4-16X12 Inch*	1	U04160.075.1200	1.1/4-12X10 Inch*	1	U04160.125.1000
9/16-18X2 Inch*	10	U04160.056.0200						
9/16-18X2.1/4*	10	U04160.056.0225	7/8-14X1.1/2 ft*	5	U04160.087.0150	1.1/2-12X3 Inch ft*	1	U04160.150.0300
9/16-18X2.1/2*	10	U04160.056.0250	7/8-14X2 Inch ft*	5	U04160.087.0200	1.1/2-12X3.1/2*	1	U04160.150.0350
9/16-18X2.3/4*	10	U04160.056.0275	7/8-14X2.1/4*	5	U04160.087.0225	1.1/2-12X4 Inch*	1	U04160.150.0400
9/16-18X3 Inch*	10	U04160.056.0300	7/8-14X2.1/2*	5	U04160.087.0250	1.1/2-12X4.1/2*	1	U04160.150.0450
9/16-18X3.1/4*	10	U04160.056.0325	7/8-14X2.3/4*	5	U04160.087.0275	1.1/2-12X5 Inch*	1	U04160.150.0500
9/16-18X3.1/2*	10	U04160.056.0350	7/8-14X3 Inch*	5	U04160.087.0300	1.1/2-12X6 Inch*	1	U04160.150.0600
9/16-18X4 Inch*	5	U04160.056.0400	7/8-14X3.1/4*	5	U04160.087.0325	1.1/2-12X7 Inch*	1	U04160.150.0700
9/16-18X4.1/2*	5	U04160.056.0450	7/8-14X3.1/2*	5	U04160.087.0350			
9/16-18X5 Inch*	5	U04160.056.0500						

* ft = z pełnym gwintem

U04360 Śruby z łbem sześciokątnym UNF
X01A

Gwint Calowy, zunifikowany drobnozwojny (UNF)
Materiał Stal
Klasa Grade 8
Obróbka powierzchni Ocynkowane, po żółtej pasywacji

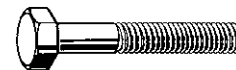

d x L	☒	Kod artykułu	d x L	☒	Kod artykułu	d x L	☒	Kod artykułu
1/4-28X1/2 ft*	100	U04360.025.0050	3/8-24X8 Inch*	5	U04360.037.0800	5/8-18X2 Inch*	5	U04360.062.0200
1/4-28X5/8 ft*	100	U04360.025.0062	3/8-24X10 Inch*	5	U04360.037.1000	5/8-18X2.1/4*	5	U04360.062.0225
1/4-28X3/4 ft*	100	U04360.025.0075				5/8-18X2.1/2*	5	U04360.062.0250
1/4-28X7/8*	100	U04360.025.0087	7/16-20X3/4 ft*	25	U04360.043.0075	5/8-18X2.3/4*	5	U04360.062.0275
1/4-28X1 Inch*	100	U04360.025.0100	7/16-20X7/8 ft*	25	U04360.043.0087	5/8-18X3 Inch*	5	U04360.062.0300
1/4-28X1.1/4*	100	U04360.025.0125	7/16-20X1 Inch ft*	25	U04360.043.0100	5/8-18X3.1/4*	5	U04360.062.0325
1/4-28X1.3/8*	100	U04360.025.0137	7/16-20X1.1/4*	25	U04360.043.0125	5/8-18X3.1/2*	5	U04360.062.0350
1/4-28X1.1/2*	100	U04360.025.0150	7/16-20X1.1/2*	25	U04360.043.0150	5/8-18X3.3/4*	5	U04360.062.0375
1/4-28X1.3/4*	100	U04360.025.0175	7/16-20X1.3/4*	25	U04360.043.0175	5/8-18X4 Inch*	5	U04360.062.0400
1/4-28X2 Inch*	50	U04360.025.0200	7/16-20X2 Inch*	25	U04360.043.0200	5/8-18X4.1/4*	5	U04360.062.0425
1/4-28X2.1/4*	50	U04360.025.0225	7/16-20X2.1/4*	10	U04360.043.0225	5/8-18X4.1/2*	5	U04360.062.0450
1/4-28X2.1/2*	50	U04360.025.0250	7/16-20X2.1/2*	10	U04360.043.0250	5/8-18X4.3/4*	5	U04360.062.0475
1/4-28X2.3/4*	50	U04360.025.0275	7/16-20X2.3/4*	10	U04360.043.0275	5/8-18X5 Inch*	5	U04360.062.0500
1/4-28X3 Inch*	50	U04360.025.0300	7/16-20X3 Inch*	10	U04360.043.0300	5/8-18X5.1/2*	5	U04360.062.0550
1/4-28X3.1/4*	50	U04360.025.0325	7/16-20X3.1/4*	10	U04360.043.0325	5/8-18X6 Inch*	5	U04360.062.0600
1/4-28X3.1/2*	50	U04360.025.0350	7/16-20X3.1/2*	10	U04360.043.0350	5/8-18X6.1/2*	5	U04360.062.0650
1/4-28X3.3/4*	50	U04360.025.0375	7/16-20X3.3/4*	10	U04360.043.0375	5/8-18X7 Inch*	5	U04360.062.0700
1/4-28X4 Inch*	25	U04360.025.0400	7/16-20X4 Inch*	10	U04360.043.0400	5/8-18X7.1/2*	5	U04360.062.0750
1/4-28X4.1/2*	25	U04360.025.0450	7/16-20X4.1/2*	10	U04360.043.0450	5/8-18X8 Inch*	5	U04360.062.0800
1/4-28X5 Inch*	25	U04360.025.0500	7/16-20X5 Inch*	10	U04360.043.0500	5/8-18X8.1/2*	5	U04360.062.0850
1/4-28X5.1/2*	25	U04360.025.0550	7/16-20X5.1/2*	10	U04360.043.0550	5/8-18X9 Inch*	5	U04360.062.0900
1/4-28X6 Inch*	25	U04360.025.0600	7/16-20X6 Inch*	5	U04360.043.0600	5/8-18X9.1/2*	5	U04360.062.0950
1/4-28X7 Inch*	10	U04360.025.0700				5/8-18X10 Inch*	5	U04360.062.1000
1/4-28X8 Inch*	5	U04360.025.0800	1/2-20X3/4 ft*	25	U04360.050.0075	5/8-18X11 Inch*	5	U04360.062.1100
			1/2-20X1 Inch ft*	25	U04360.050.0100	5/8-18X12 Inch*	5	U04360.062.1200
5/16-24X1/2 ft*	100	U04360.031.0050	1/2-20X1.1/4 ft*	25	U04360.050.0125			
5/16-24X5/8 ft*	100	U04360.031.0062	1/2-20X1.1/2*	25	U04360.050.0150	3/4-16X1 Inch ft*	10	U04360.075.0100
5/16-24X3/4 ft*	100	U04360.031.0075	1/2-20X1.3/4*	25	U04360.050.0175	3/4-16X1.1/4 ft*	10	U04360.075.0125
5/16-24X7/8 ft*	100	U04360.031.0087	1/2-20X2 Inch*	10	U04360.050.0200	3/4-16X1.1/2 ft*	10	U04360.075.0150
5/16-24X1 Inch*	100	U04360.031.0100	1/2-20X2.1/4*	10	U04360.050.0225	3/4-16X1.3/4 ft*	10	U04360.075.0175
5/16-24X1.1/4*	100	U04360.031.0125	1/2-20X2.1/2*	10	U04360.050.0250	3/4-16X2 Inch*	5	U04360.075.0200
5/16-24X1.1/2*	100	U04360.031.0150	1/2-20X2.3/4*	10	U04360.050.0275	3/4-16X2.1/4*	5	U04360.075.0225
5/16-24X1.3/4*	50	U04360.031.0175	1/2-20X3 Inch*	10	U04360.050.0300	3/4-16X2.1/2*	5	U04360.075.0250
5/16-24X2 Inch*	50	U04360.031.0200	1/2-20X3.1/4*	10	U04360.050.0325	3/4-16X2.3/4*	5	U04360.075.0275
5/16-24X2.1/4*	50	U04360.031.0225	1/2-20X3.1/2*	10	U04360.050.0350	3/4-16X3 Inch*	5	U04360.075.0300
5/16-24X2.1/2*	50	U04360.031.0250	1/2-20X3.3/4*	10	U04360.050.0375	3/4-16X3.1/4*	5	U04360.075.0325
5/16-24X2.3/4*	50	U04360.031.0275	1/2-20X4 Inch*	5	U04360.050.0400	3/4-16X3.1/2*	5	U04360.075.0350
5/16-24X3 Inch*	50	U04360.031.0300	1/2-20X4.1/4*	5	U04360.050.0425	3/4-16X3.3/4*	5	U04360.075.0375
5/16-24X3.1/4*	50	U04360.031.0325	1/2-20X4.1/2*	5	U04360.050.0450	3/4-16X4 Inch*	5	U04360.075.0400
5/16-24X3.1/2*	50	U04360.031.0350	1/2-20X4.3/4*	5	U04360.050.0475	3/4-16X4.1/4*	5	U04360.075.0425
5/16-24X3.3/4*	25	U04360.031.0375	1/2-20X5 Inch*	5	U04360.050.0500	3/4-16X4.1/2*	5	U04360.075.0450
5/16-24X4 Inch*	25	U04360.031.0400	1/2-20X5.1/2*	5	U04360.050.0550	3/4-16X4.3/4*	5	U04360.075.0475
5/16-24X4.1/2*	25	U04360.031.0450	1/2-20X6 Inch*	5	U04360.050.0600	3/4-16X5 Inch*	5	U04360.075.0500
5/16-24X5 Inch*	25	U04360.031.0500	1/2-20X6.1/2*	5	U04360.050.0650	3/4-16X5.1/2*	5	U04360.075.0550
5/16-24X5.1/2*	25	U04360.031.0550	1/2-20X7 Inch*	5	U04360.050.0700	3/4-16X6 Inch*	5	U04360.075.0600
5/16-24X6 Inch*	25	U04360.031.0600	1/2-20X7.1/2*	5	U04360.050.0750	3/4-16X6.1/2*	1	U04360.075.0650
5/16-24X7 Inch*	10	U04360.031.0700	1/2-20X8 Inch*	5	U04360.050.0800	3/4-16X7 Inch*	1	U04360.075.0700
			1/2-20X8.1/2*	5	U04360.050.0850	3/4-16X7.1/2*	1	U04360.075.0750
			1/2-20X9 Inch*	5	U04360.050.0900	3/4-16X8 Inch*	1	U04360.075.0800
3/8-24X1/2 ft*	50	U04360.037.0050	1/2-20X10 Inch*	5	U04360.050.1000	3/4-16X8.1/2*	5	U04360.075.0850
3/8-24X5/8 ft*	50	U04360.037.0062	1/2-20X11 Inch*	5	U04360.050.1100	3/4-16X9 Inch*	1	U04360.075.0900
3/8-24X3/4 ft*	50	U04360.037.0075	1/2-20X12 Inch*	5	U04360.050.1200	3/4-16X9.1/2*	5	U04360.075.0950
3/8-24X7/8 ft*	50	U04360.037.0087				3/4-16X10 Inch*	1	U04360.075.1000
3/8-24X1 Inch ft*	50	U04360.037.0100				3/4-16X11 Inch*	5	U04360.075.1100
3/8-24X1.1/4*	50	U04360.037.0125	9/16-18X1 Inch ft*	25	U04360.056.0100	3/4-16X12 Inch*	5	U04360.075.1200
3/8-24X1.1/2*	50	U04360.037.0150	9/16-18X1.1/4 ft*	25	U04360.056.0125			
3/8-24X1.3/4*	50	U04360.037.0175	9/16-18X1.1/2*	25	U04360.056.0150			
3/8-24X2 Inch*	25	U04360.037.0200	9/16-18X1.3/4*	10	U04360.056.0175	7/8-14X1.1/2 ft*	5	U04360.087.0150
3/8-24X2.1/4*	25	U04360.037.0225	9/16-18X2 Inch*	10	U04360.056.0200	7/8-14X2 Inch ft*	5	U04360.087.0200
3/8-24X2.1/2*	25	U04360.037.0250	9/16-18X2.1/4*	10	U04360.056.0225	7/8-14X2.1/4*	5	U04360.087.0225
3/8-24X2.3/4*	25	U04360.037.0275	9/16-18X2.1/2*	10	U04360.056.0250	7/8-14X2.1/2*	5	U04360.087.0250
3/8-24X3 Inch*	25	U04360.037.0300	9/16-18X2.3/4*	10	U04360.056.0275	7/8-14X2.3/4*	5	U04360.087.0275
3/8-24X3.1/4*	25	U04360.037.0325	9/16-18X3 Inch*	10	U04360.056.0300	7/8-14X3 Inch*	5	U04360.087.0300
3/8-24X3.1/2*	25	U04360.037.0350	9/16-18X3.1/4*	10	U04360.056.0325	7/8-14X3.1/4*	5	U04360.087.0325
3/8-24X3.3/4*	25	U04360.037.0375	9/16-18X3.1/2*	10	U04360.056.0350	7/8-14X3.1/2*	5	U04360.087.0350
3/8-24X4 Inch*	10	U04360.037.0400	9/16-18X3.3/4*	10	U04360.056.0375	7/8-14X3.3/4*	5	U04360.087.0375
3/8-24X4.1/4*	10	U04360.037.0425	9/16-18X4 Inch*	5	U04360.056.0400	7/8-14X4 Inch*	5	U04360.087.0400
3/8-24X4.1/2*	10	U04360.037.0450	9/16-18X4.1/2*	5	U04360.056.0450	7/8-14X4.1/2*	5	U04360.087.0450
3/8-24X4.3/4*	10	U04360.037.0475	9/16-18X5 Inch*	5	U04360.056.0500	7/8-14X5 Inch*	5	U04360.087.0500
3/8-24X5 Inch*	10	U04360.037.0500	9/16-18X5.1/2*	5	U04360.056.0550	7/8-14X5.1/2*	5	U04360.087.0550
3/8-24X5.1/4*	10	U04360.037.0525	9/16-18X6 Inch*	5	U04360.056.0600	7/8-14X6 Inch*	1	U04360.087.0600
3/8-24X5.1/2*	10	U04360.037.0550				7/8-14X6.1/2*	1	U04360.087.0650
3/8-24X5.3/4*	10	U04360.037.0575	5/8-18X1 Inch ft*	10	U04360.062.0100	7/8-14X7 Inch*	1	U04360.087.0700
3/8-24X6 Inch*	10	U04360.037.0600	5/8-18X1.1/4 ft*	10	U04360.062.0125	7/8-14X7.1/2*	1	U04360.087.0750
3/8-24X6.1/2*	10	U04360.037.0650	5/8-18X1.1/2 ft*	10	U04360.062.0150	7/8-14X8 Inch*	1	U04360.087.0800
3/8-24X7 Inch*	10	U04360.037.0700	5/8-18X1.3/4*	10	U04360.062.0175	7/8-14X8.1/2*	1	U04360.087.0850

U04360 Śruby z łbem sześciokątnym UNF								
d x L	☒	Kod artykułu	d x L	☒	Kod artykułu	d x L	☒	Kod artykułu
7/8-14X9 Inch*	1	U04360.087.0900	1.-14X8.1/2*	1	U04360.101.0850	1.1/4-12X3 Inch*	1	U04360.125.0300
7/8-14X10 Inch*	1	U04360.087.1000	1.-14X9 Inch*	1	U04360.101.0900	1.1/4-12X3.1/2*	1	U04360.125.0350
1.-14X1.1/2 ft*	5	U04360.101.0150	1.-14X9.1/2*	1	U04360.101.0950	1.1/4-12X4 Inch*	1	U04360.125.0400
1.-14X1.3/4 ft*	5	U04360.101.0175	1.-14X10 Inch*	1	U04360.101.1000	1.1/4-12X4.1/2*	1	U04360.125.0450
1.-14X2 Inch ft*	5	U04360.101.0200	1.1/8-12X2.1/2 ft*	5	U04360.112.0250	1.1/4-12X5 Inch*	1	U04360.125.0500
1.-14X2.1/4 ft*	5	U04360.101.0225	1.1/8-12X3 Inch*	1	U04360.112.0300	1.1/4-12X5.1/2*	1	U04360.125.0550
1.-14X2.1/2*	5	U04360.101.0250	1.1/8-12X3.1/2*	1	U04360.112.0350	1.1/4-12X6 Inch*	1	U04360.125.0600
1.-14X2.3/4*	5	U04360.101.0275	1.1/8-12X4 Inch*	1	U04360.112.0400	1.1/4-12X6.1/2*	1	U04360.125.0650
1.-14X3 Inch*	5	U04360.101.0300	1.1/8-12X4.1/2*	1	U04360.112.0450	1.1/4-12X7 Inch*	1	U04360.125.0700
1.-14X3.1/4*	5	U04360.101.0325	1.1/8-12X5.1/2*	1	U04360.112.0500	1.1/4-12X7.1/2*	1	U04360.125.0750
1.-14X3.1/2*	5	U04360.101.0350	1.1/8-12X5 Inch*	1	U04360.112.0550	1.1/4-12X8 Inch*	1	U04360.125.0800
1.-14X3.3/4*	5	U04360.101.0375	1.1/8-12X5.1/2*	1	U04360.112.0600	1.1/4-12X9 Inch*	1	U04360.125.0900
1.-14X4 Inch*	5	U04360.101.0400	1.1/8-12X6 Inch*	1	U04360.112.0650	1.1/4-12X10 Inch*	1	U04360.125.1000
1.-14X4.1/2*	5	U04360.101.0450	1.1/8-12X6.1/2*	1	U04360.112.0700	1.1/2-12X3 Inch ft*	1	U04360.150.0300
1.-14X5 Inch*	5	U04360.101.0500	1.1/8-12X7 Inch*	1	U04360.112.0750	1.1/2-12X4.1/2*	1	U04360.150.0450
1.-14X5.1/2*	5	U04360.101.0550	1.1/8-12X7.1/2*	1	U04360.112.0800	1.1/2-12X5 Inch*	1	U04360.150.0500
1.-14X6 Inch*	1	U04360.101.0600	1.1/8-12X8 Inch*	1	U04360.112.0900	1.1/2-12X6 Inch*	1	U04360.150.0600
1.-14X6.1/2*	1	U04360.101.0650	1.1/8-12X9 Inch*	1	U04360.112.1000	1.1/2-12X6.1/2*	1	U04360.150.0650
1.-14X7 Inch*	1	U04360.101.0700	1.1/8-12X10 Inch*	1	U04360.112.1000	1.1/2-12X7 Inch*	1	U04360.150.0700
1.-14X7.1/2*	1	U04360.101.0750	1.1/4-12X2 Inch ft*	1	U04360.125.0200	1.1/2-12X7.1/2*	1	U04360.150.0750
1.-14X8 Inch*	1	U04360.101.0800	1.1/4-12X2.1/2 ft*	1	U04360.125.0250	1.1/2-12X10 Inch*	1	U04360.150.1000

* ft = z pełnym gwintem

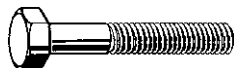
U51007 Śruby z łbem sześciokątnym UNF		X15A
Gwint	Calowy, zunifikowany drobnozwojny (UNF)	
Materiał	Stal nierdzewna A2 (AISI 304/18-8)	
Klasa	F593	



d x L	☒	Kod artykułu	d x L	☒	Kod artykułu	d x L	☒	Kod artykułu
1/4-28X1/2 ft*	100	U51007.025.0050	3/8-24X2.3/4*	25	U51007.037.0275	9/16-18X2.1/2*	5	U51007.056.0250
1/4-28X5/8 ft*	100	U51007.025.0062	3/8-24X3 Inch*	10	U51007.037.0300	9/16-18X3 Inch*	5	U51007.056.0300
1/4-28X3/4 ft*	100	U51007.025.0075	3/8-24X3.1/2*	10	U51007.037.0350	9/16-18X3.1/2*	5	U51007.056.0350
1/4-28X7/8*	100	U51007.025.0087	3/8-24X4 Inch*	10	U51007.037.0400	9/16-18X4 Inch*	5	U51007.056.0400
1/4-28X1 Inch*	100	U51007.025.0100	3/8-24X4.1/2*	10	U51007.037.0450	9/16-18X4.1/2*	5	U51007.056.0450
1/4-28X1.1/4*	100	U51007.025.0125	3/8-24X5 Inch*	10	U51007.037.0500	9/16-18X5 Inch*	5	U51007.056.0500
1/4-28X1.3/8*	100	U51007.025.0137				9/16-18X5.1/2*	5	U51007.056.0550
1/4-28X1.1/2*	100	U51007.025.0150	7/16-20X1 Inch ft*	25	U51007.043.0100	9/16-18X6 Inch*	5	U51007.056.0600
1/4-28X1.3/4*	100	U51007.025.0175	7/16-20X1.1/4*	25	U51007.043.0125	5/8-18X1 Inch ft*	10	U51007.062.0100
1/4-28X2 Inch*	50	U51007.025.0200	7/16-20X1.1/2*	25	U51007.043.0150	5/8-18X1.1/4 ft*	10	U51007.062.0125
1/4-28X2.1/4*	50	U51007.025.0225	7/16-20X1.3/4*	10	U51007.043.0175	5/8-18X1.1/2 ft*	10	U51007.062.0150
1/4-28X2.1/2*	50	U51007.025.0250	7/16-20X2 Inch*	10	U51007.043.0200	5/8-18X1.3/4*	10	U51007.062.0175
1/4-28X2.3/4*	50	U51007.025.0275	7/16-20X2.1/4*	10	U51007.043.0225	5/8-18X2 Inch*	5	U51007.062.0200
1/4-28X3 Inch*	50	U51007.025.0300	7/16-20X2.1/2*	10	U51007.043.0250	5/8-18X2.1/4*	5	U51007.062.0225
1/4-28X3.1/2*	25	U51007.025.0350	7/16-20X2.3/4*	10	U51007.043.0275	5/8-18X2.1/2*	5	U51007.062.0250
1/4-28X4 Inch*	25	U51007.025.0400	7/16-20X3 Inch*	10	U51007.043.0300	5/8-18X3 Inch*	5	U51007.062.0300
5/16-24X1/2 ft*	50	U51007.031.0050	7/16-20X3.1/2*	5	U51007.043.0350	5/8-18X3.1/2*	5	U51007.062.0350
5/16-24X5/8 ft*	50	U51007.031.0062	7/16-20X4 Inch*	5	U51007.043.0400	5/8-18X4 Inch*	5	U51007.062.0400
5/16-24X3/4 ft*	50	U51007.031.0075	7/16-20X4.1/2*	5	U51007.043.0450	5/8-18X4.1/2*	5	U51007.062.0450
5/16-24X7/8 ft*	50	U51007.031.0087	7/16-20X5 Inch*	5	U51007.043.0500	5/8-18X5 Inch*	5	U51007.062.0500
5/16-24X1 Inch*	50	U51007.031.0100	1/2-20X3/4 ft*	10	U51007.050.0075	5/8-18X5.1/2*	5	U51007.062.0550
5/16-24X1.1/4*	50	U51007.031.0125	1/2-20X1 Inch ft*	10	U51007.050.0100	5/8-18X6 Inch*	5	U51007.062.0600
5/16-24X1.1/2*	50	U51007.031.0150	1/2-20X1.1/4 ft*	10	U51007.050.0125	5/8-18X6.1/2*	5	U51007.062.0650
5/16-24X1.3/4*	50	U51007.031.0175	1/2-20X1.1/2*	10	U51007.050.0150	5/8-18X7 Inch*	5	U51007.062.0700
5/16-24X2 Inch*	50	U51007.031.0200	1/2-20X2 Inch*	10	U51007.050.0200	5/8-18X8 Inch*	5	U51007.062.0800
5/16-24X2.1/4*	25	U51007.031.0225	1/2-20X2.1/4*	10	U51007.050.0225	5/8-18X9 Inch*	1	U51007.062.0900
5/16-24X2.1/2*	25	U51007.031.0250	1/2-20X2.1/2*	10	U51007.050.0250			
5/16-24X3 Inch*	25	U51007.031.0300	1/2-20X3 Inch*	5	U51007.050.0300	3/4-16X1 Inch ft*	5	U51007.075.0100
5/16-24X3.1/2*	25	U51007.031.0350	1/2-20X3.1/4*	5	U51007.050.0325	3/4-16X1.1/4 ft*	5	U51007.075.0125
5/16-24X4 Inch*	10	U51007.031.0400	1/2-20X3.1/2*	5	U51007.050.0350	3/4-16X1.1/2 ft*	5	U51007.075.0150
3/8-24X1/2 ft*	50	U51007.037.0050	1/2-20X4 Inch*	5	U51007.050.0400	3/4-16X1.3/4 ft*	5	U51007.075.0175
3/8-24X5/8 ft*	50	U51007.037.0062	1/2-20X4.1/2*	5	U51007.050.0450	3/4-16X2 Inch*	5	U51007.075.0200
3/8-24X3/4 ft*	50	U51007.037.0075	1/2-20X5 Inch*	5	U51007.050.0500	3/4-16X2.1/4*	5	U51007.075.0225
3/8-24X7/8 ft*	50	U51007.037.0087	1/2-20X5.1/2*	5	U51007.050.0550	3/4-16X2.1/2*	5	U51007.075.0250
3/8-24X1 Inch ft*	50	U51007.037.0100	1/2-20X6 Inch*	5	U51007.050.0600	3/4-16X3 Inch*	5	U51007.075.0300
3/8-24X1.1/4*	50	U51007.037.0125				3/4-16X3.1/2*	5	U51007.075.0350
3/8-24X1.1/2*	25	U51007.037.0150	9/16-18X1 Inch ft*	10	U51007.056.0100	3/4-16X4 Inch*	5	U51007.075.0400
3/8-24X1.3/4*	25	U51007.037.0175	9/16-18X1.1/4 ft*	10	U51007.056.0125	3/4-16X4.1/2*	5	U51007.075.0450
3/8-24X2 Inch*	25	U51007.037.0200	9/16-18X1.1/2*	10	U51007.056.0150	3/4-16X5 Inch*	5	U51007.075.0500
3/8-24X2.1/4*	25	U51007.037.0225	9/16-18X1.3/4*	10	U51007.056.0175	3/4-16X5.1/2*	5	U51007.075.0550
3/8-24X2.1/2*	25	U51007.037.0250	9/16-18X2 Inch*	5	U51007.056.0200	3/4-16X6 Inch*	5	U51007.075.0600

* ft = z pełnym gwintem

Śruby z łbem sześciokątnym BSW

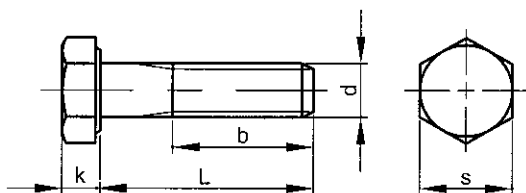

DIN ≈931 (1954)
NEN ≈2336 (1961)

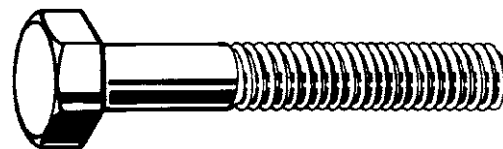

Informacje techniczne

d	k	s	Zwoje gwintu na cal	d	k	s	Zwoje gwintu na cal
1/2	9	22	12	7/8	16	36	9
5/8	11	27	11	1 Inch	18	41	8
3/4	13	32	10				

- Gwint Whitworth'a (BSW/BSF) nie jest zalecany do międzynarodowego stosowania. Zaleca się stosowanie gwintu metrycznego (M/MF) lub zunifikowanego (UNC/UNF).
- W zależności od dostępności wymiary mogą się różnić.

03400 Śruby z łbem sześciokątnym BSW X03A

Gwint: Całowy, Whitworth'a (BSW)
Materiał: Stal
Klasa: 8.8

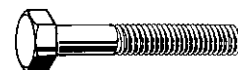

d x L/b	☒	Kod artykułu	d x L/b	☒	Kod artykułu	d x L/b	☒	Kod artykułu
1/2X35/25	50	03400.127.035	5/8X50/28	25	03400.158.050	7/8X60/38	10	03400.222.060
1/2X50/25	50	03400.127.050	5/8X60/28	25	03400.158.060	7/8X70/38	10	03400.222.070
1/2X60/25	50	03400.127.060						
1/2X70/25	50	03400.127.070	3/4X50/32	10	03400.191.050			
1/2X75/30	50	03400.127.075	3/4X60/32	10	03400.191.060	1 InchX70/40	10	03400.254.070
1/2X80/30	50	03400.127.080	3/4X70/32	10	03400.191.070	1 InchX80/40	10	03400.254.080
1/2X100/30	50	03400.127.100	3/4X80/32	10	03400.191.080	1 InchX100/55	10	03400.254.100
			3/4X100/40	10	03400.191.100			

Śruby z łbem sześciokątnym BSF

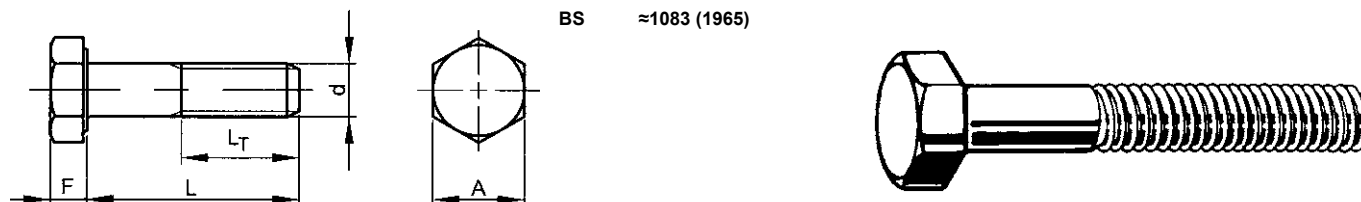

BS ≈1083 (1965)

Informacje techniczne

d	A	F	L _T (min.)	Zwoje gwintu na cal
1/4	0.445	4.6	13	26
5/16	0.525	5.5	16	22
3/8	0.6	6.6	19	20
7/16	0.71	7.7	22	18
1/2	0.82	8.7	25.5	16
5/8	1.01	10.6	32	14
3/4	1.2	12.7	38	12

- Gwint Whitworth'a (BSW/BSF) nie jest zalecany do międzynarodowego stosowania. Zaleca się stosowanie gwintu metrycznego (M/MF) lub zunifikowanego (UNC/UNF).
- Minimalna klasa R zgodn. z ≈ BS 1083 (1965) odpowiada w zasadzie klasie właściwości 6.8 zgodn. z DIN ISO 898-1. Łeb śruby jest oznaczony symbolem klasy właściwości R.

03000 Śruby z łbem sześciokątnym BSF

X90A

Gwint Calowy, Whitwortha, drobnozwojny (BSF)
Materiał Stal
Klasa ≥Grade R

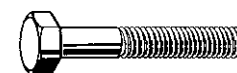

d x L	☒	Kod artykułu	d x L	☒	Kod artykułu	d x L	☒	Kod artykułu
1/4X1 Inch	200	03000.063.025	3/8X1.1/4	100	03000.096.031	1/2X1.3/4	50	03000.127.044
1/4X2 Inch	100	03000.063.050	3/8X1.1/2	100	03000.096.038	1/2X2 Inch	50	03000.127.050
1/4X2.1/2	100	03000.063.063	3/8X1.3/4	100	03000.096.044	1/2X2.1/2	50	03000.127.063
1/4X3 Inch	100	03000.063.076	3/8X2 Inch	100	03000.096.050	1/2X3 Inch	50	03000.127.076
5/16X1.1/2	200	03000.079.038	3/8X3 Inch	100	03000.096.076	5/8X2 Inch	25	03000.158.050
5/16X1.3/4	100	03000.079.044	7/16X1.1/2	100	03000.111.038	3/4X2 Inch	25	03000.191.050
5/16X2 Inch	100	03000.079.050	1/2X1.1/2	50	03000.127.038	3/4X2.1/2	25	03000.191.063
5/16X2.1/4	100	03000.079.057				3/4X3 Inch	25	03000.191.076
5/16X3 Inch	100	03000.079.076						

Wkręty z łbem sześciokątnym BSW

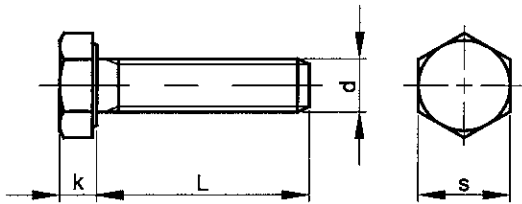

DIN ≈933 (1954)
NEN ≈2337 (1961)

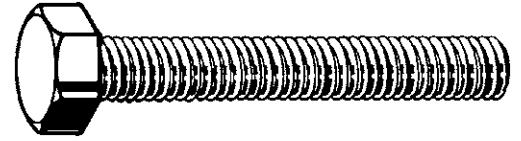

Informacje techniczne

d	k	s	Zwoje gwintu na cal	d	k	s	Zwoje gwintu na cal
1/4	5	11	20	1/2	9	22	12
5/16	6	14	18	5/8	11	27	11
3/8	7	17	16	3/4	13	32	10

- Gwint Whitworth'a (BSW/BSF) nie jest zalecany do międzynarodowego stosowania. Zaleca się stosowanie gwintu metrycznego (M/MF) lub zunifikowanego (UNC/UNF).
- W zależności od dostępności wymiary mogą się różnić.

Grupy katalogowe

Gwint	Gniazdo	Materiał	Klasa	Kod	Strona
BSW	Sześciokąt	St	8.8	03410	1-60
BSW	Sześciokąt	Mosiądz Cu2		46210	1-60

03410 Wkręty z łbem sześciokątnym BSW

X03A

Gwint Calowy, Whitworth'a (BSW)
Materiał Stal
Klasa 8.8



d x L	☒	Kod artykułu	d x L	☒	Kod artykułu	d x L	☒	Kod artykułu
1/4X10MM	100	03410.063.010	3/8X15MM	100	03410.096.015	1/2X40MM	50	03410.127.040
1/4X15MM	100	03410.063.015	3/8X20MM	100	03410.096.020	1/2X50MM	50	03410.127.050
1/4X20MM	100	03410.063.020	3/8X25MM	100	03410.096.025	1/2X55MM	50	03410.127.055
1/4X25MM	100	03410.063.025	3/8X30MM	100	03410.096.030	1/2X60MM	50	03410.127.060
1/4X30MM	100	03410.063.030	3/8X35MM	100	03410.096.035	1/2X70MM	50	03410.127.070
1/4X40MM	100	03410.063.040	3/8X40MM	100	03410.096.040			
1/4X50MM	100	03410.063.050	3/8X50MM	100	03410.096.050	5/8X30MM	50	03410.158.030
			3/8X60MM	100	03410.096.060	5/8X40MM	25	03410.158.040
5/16X20MM	100	03410.079.020	3/8X70MM	100	03410.096.070	5/8X50MM	25	03410.158.050
5/16X25MM	100	03410.079.025				5/8X60MM	25	03410.158.060
5/16X30MM	100	03410.079.030	1/2X20MM	100	03410.127.020			
5/16X40MM	100	03410.079.040	1/2X25MM	100	03410.127.025	3/4X50MM	10	03410.191.050
5/16X50MM	100	03410.079.050	1/2X30MM	100	03410.127.030	3/4X60MM	10	03410.191.060
5/16X60MM	100	03410.079.060	1/2X35MM	100	03410.127.035	3/4X70MM	10	03410.191.070

46210 Wkręty z łbem sześciokątnym BSW

X08A

Gwint Calowy, Whitworth'a (BSW)
Materiał Mosiądz Cu2



d x L	☒	Kod artykułu	d x L	☒	Kod artykułu	d x L	☒	Kod artykułu
1/4X10MM	100	46210.063.010	5/16X20MM	100	46210.079.020	3/8X50MM	25	46210.096.050
1/4X12MM	100	46210.063.012	5/16X25MM	100	46210.079.025			
1/4X15MM	100	46210.063.015	5/16X30MM	50	46210.079.030	1/2X25MM	25	46210.127.025
1/4X20MM	100	46210.063.020	5/16X40MM	50	46210.079.040	1/2X30MM	25	46210.127.030
1/4X25MM	100	46210.063.025	5/16X50MM	50	46210.079.050	1/2X40MM	25	46210.127.040
1/4X30MM	100	46210.063.030				1/2X50MM	25	46210.127.050
1/4X40MM	50	46210.063.040	3/8X20MM	50	46210.096.020			
1/4X50MM	50	46210.063.050	3/8X25MM	50	46210.096.025	5/8X16MM	25	46210.158.016
			3/8X30MM	25	46210.096.030	5/8X40MM	10	46210.158.040
5/16X16MM	100	46210.079.016	3/8X40MM	25	46210.096.040	5/8X50MM	10	46210.158.050

Śruby z łebem sześciokątnym, BSF

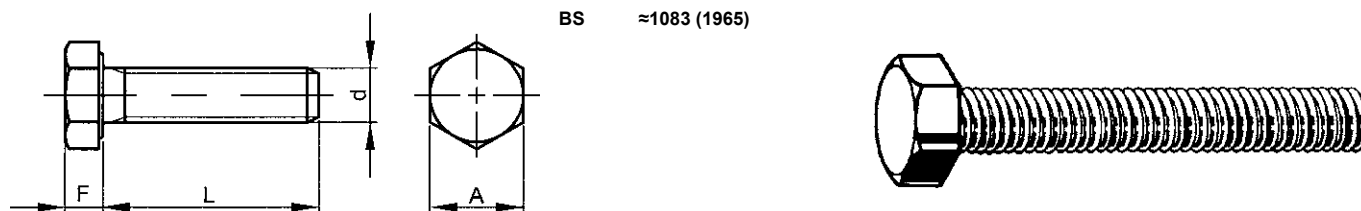

BS ≈1083 (1965)

Informacje techniczne

d	A	F	Zwoje gwintu na cal	d	A	F	Zwoje gwintu na cal
1/4	0.445	4.6	26	3/8	0.6	6.6	20
5/16	0.525	5.5	22	1/2	0.82	8.7	16

- Gwint Whitworth'a (BSW/BSF) nie jest zalecany do międzynarodowego stosowania. Zaleca się stosowanie gwintu metrycznego (M/MF) lub zunifikowanego (UNC/UNF).
- Minimalna klasa R zgodn. z ≈ BS 1083 (1965) odpowiada w zasadzie klasie właściwości 6.8 zgodn. z DIN ISO 898-1. Łeb śruby jest oznaczony symbolem klasy właściwości R.

03010 Śruby z łebem sześciokątnym, BSF

X90A

Gwint Calowy, Whitwortha, drobnozwojny (BSF)
Materiał Stal
Klasa ≥Grade R



d x L	☒	Kod artykułu	d x L	☒	Kod artykułu	d x L	☒	Kod artykułu
1/4X5/8	200	03010.063.015	5/16X3/4	200	03010.079.019	3/8X5/8	100	03010.096.015
1/4X3/4	200	03010.063.019	5/16X1 Inch	200	03010.079.025	3/8X3/4	100	03010.096.019
1/4X1 Inch	200	03010.063.025	5/16X1.1/4	200	03010.079.031	3/8X1 Inch	100	03010.096.025
1/4X1.1/4	200	03010.063.031	5/16X1.1/2	200	03010.079.038	1/2X1 Inch	100	03010.127.025
1/4X1.1/2	200	03010.063.038	3/8X1/2	100	03010.096.012	1/2X1.1/4	50	03010.127.031
5/16X5/8	200	03010.079.015						

Śruby samozabezpieczające z łbem sześciokątnym z kołnierzem stożkowym



Informacje techniczne

d	d _c	k	P	s
M5	11.2	4.3	0.8	8
M6	14.2	5.5	1	10
M8	18.2	7	1.25	13
M10	21	8.5	1.5	15
M12	24	10	1.75	17
M16	31	14	2	22

Specjalne właściwości śrub samozabezpieczających z łbem sześciokątnym z kołnierzem stożkowym RIPP::

- ząbkowany (wielorowkowy) kołnierz usuwa uszkodzenia podczas montażu, zapobiega samopoluzowaniu i zmniejsza poluznienie
- kołnierz pozwala na rozproszczenie nagromadzonych sił na większym obszarze, tym samym zmniejszając nacisk na powierzchnię
- kołnierz może zakryć duże (nadwymiarowe) otwory i/lub otwory narzędziowe
- podkładka i/lub element blokujący nie jest konieczny.

MONTAŻ Z OBCIĄŻENIEM WSTĘPNYM F_M w kN, a MOMENT SKRĘCAJĄCY M_A w Nm

Klasa	Dopasowanie materiału	M5		M6		M8		M10		M12		M16	
		F_M	M_A	F_M	M_A	F_M	M_A	F_M	M_A	F_M	M_A	F_M	M_A
100	Stal ($R_m < 800 \text{ N/mm}^2$)	9	11	12,6	19	23,2	42	37	85	54	130	102	330
	Stal ($R_m \geq 800 \text{ N/mm}^2$)	9	10	12,6	18	23,2	37	37	80	54	120	102	310
	Stal zgrzewna/ żeliwo ciągliwe	9	9	12,6	16	23,2	35	37	75	54	115	102	300

Grupy katalogowe

Gwint	Gniazdo	Materiał	Klasa	Obróbka powierzchni	Kod	Strona
M	Sześciokąt	St	100		04400	1-62
M	Sześciokąt	St	100	Ocynk.	04410	1-63
M	Sześciokąt	St	100	FLZNNC-NC6	04405	1-63

04400 RIPP Śruby samozabezpieczające z łbem sześciokątnym z kołnierzem stożkowym



A92A

Gwint Metryczny
Materiał Stal
Klasa 100



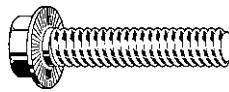

d x L	☒	Kod artykułu	d x L	☒	Kod artykułu	d x L	☒	Kod artykułu
M5X10	500	04400.050.010	M8X25	200	04400.080.025	M12X35	100	04400.120.035
M5X12	500	04400.050.012	M8X30	200	04400.080.030	M12X40	100	04400.120.040
M5X16	500	04400.050.016	M8X35	200	04400.080.035	M12X45	100	04400.120.045
M5X20	500	04400.050.020	M8X40	200	04400.080.040	M12X50	100	04400.120.050
M6X10	500	04400.060.010	M10X16	200	04400.100.016	M16X25	50	04400.160.025
M6X12	500	04400.060.012	M10X20	200	04400.100.020	M16X30	50	04400.160.030
M6X16	500	04400.060.016	M10X25	200	04400.100.025	M16X35	50	04400.160.035
M6X20	500	04400.060.020	M10X30	200	04400.100.030	M16X40	50	04400.160.040
M6X25	500	04400.060.025	M10X35	100	04400.100.035	M16X45	50	04400.160.045
M6X30	500	04400.060.030	M10X40	100	04400.100.040	M16X50	50	04400.160.050
						M16X55	50	04400.160.055
M8X12	200	04400.080.012	M12X20	100	04400.120.020	M16X60	50	04400.160.060
M8X16	200	04400.080.016	M12X25	100	04400.120.025	M16X70	25	04400.160.070
M8X20	200	04400.080.020	M12X30	100	04400.120.030			

- Śruby samozabezpieczające z łbem sześciokątnym z kołnierzem stożkowym RIPP, zostały umieszczone w klasie właściwości 100 z min. wytrzymałością na rozciąganie 1040 N/mm², są one utwardzane powierzchniowo i w związku z tym nie mogą zostać umieszczone w klasie 10.9.
- Ostrzeżenie: cynkowanie elektrolityczne tych produktów może wywołać kruchość wodorową.

04410 RIPP Śruby samozabezpieczające z łbem sześciokątnym z kołnierzem stożkowym		A92A
Gwint	Metryczny	 
Materiał	Stal	
Klasa	100	
Obróbka powierzchni	Ocynkowane	

d x L	☒	Kod artykułu	d x L	☒	Kod artykułu	d x L	☒	Kod artykułu
M5X10	500	04410.050.010	M8X25	200	04410.080.025	M12X25	100	04410.120.025
M5X12	500	04410.050.012	M8X30	200	04410.080.030	M12X30	100	04410.120.030
M5X16	500	04410.050.016	M8X35	200	04410.080.035	M12X35	100	04410.120.035
			M8X40	200	04410.080.040	M12X40	100	04410.120.040
M6X10	500	04410.060.010				M12X45	100	04410.120.045
M6X12	500	04410.060.012	M10X16	200	04410.100.016	M12X50	100	04410.120.050
M6X14	500	04410.060.014	M10X20	200	04410.100.020			
M6X16	500	04410.060.016	M10X22	200	04410.100.022	M16X30	50	04410.160.030
M6X20	500	04410.060.020	M10X25	200	04410.100.025	M16X35	50	04410.160.035
M6X25	500	04410.060.025	M10X30	200	04410.100.030	M16X40	50	04410.160.040
			M10X35	100	04410.100.035	M16X45	50	04410.160.045
M8X12	200	04410.080.012	M10X40	100	04410.100.040	M16X50	50	04410.160.050
M8X14	200	04410.080.014				M16X60	50	04410.160.060
M8X16	200	04410.080.016	M12X20	100	04410.120.020	M16X70	25	04410.160.070
M8X20	200	04410.080.020						

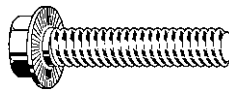
- Śruby samozabezpieczające z łbem sześciokątnym z kołnierzem stożkowym RIPP, zostały umieszczone w klasie właściwości 100 z min. wytrzymałością na rozciąganie 1040 N/mm², są one utwardzane powierzchniowo i w związku z tym nie mogą zostać umieszczone w klasie 10.9.
- Ostrzeżenie: cynkowanie elektrolityczne tych produktów może wywołać kruchość wodorową.

04405 RIPP Śruby samozabezpieczające z łbem sześciokątnym z kołnierzem stożkowym		A95A
Gwint	Metryczny	 
Materiał	Stal	
Klasa	100	
Obróbka powierzchni	Ocynk płatkowy bez Cr6+ wg ISO 10683 (flZnnc)	

d x L	☒	Kod artykułu	d x L	☒	Kod artykułu	d x L	☒	Kod artykułu
M5X10	200	04405.050.010	M8X20	200	04405.080.020	M12X35	100	04405.120.035
M5X12	200	04405.050.012	M8X25	200	04405.080.025	M12X40	100	04405.120.040
M5X16	200	04405.050.016	M8X30	200	04405.080.030	M12X50	100	04405.120.050
M5X20	200	04405.050.020	M8X35	200	04405.080.035			
M6X10	200	04405.060.010	M10X20	200	04405.100.020	M16X30	50	04405.160.030
M6X12	200	04405.060.012	M10X25	200	04405.100.025	M16X35	50	04405.160.035
M6X16	200	04405.060.016	M10X30	200	04405.100.030	M16X40	50	04405.160.040
M6X20	200	04405.060.020	M10X35	100	04405.100.035	M16X45	50	04405.160.045
M6X25	200	04405.060.025	M10X40	100	04405.100.040	M16X50	50	04405.160.050
						M16X60	50	04405.160.060
M8X16	200	04405.080.016	M12X30	100	04405.120.030	M16X70	50	04405.160.070

- Powlekanie powierzchniowe ISO 10683 cynkowanie płatkowe eliminuje możliwości uszkodzenia, jakie może wywołać kruchość wodorowa.

Śruby samozabezpieczające z łbem sześciokątnym z kołnierzem stożkowym

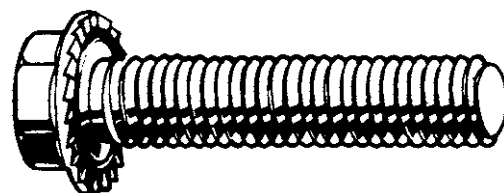
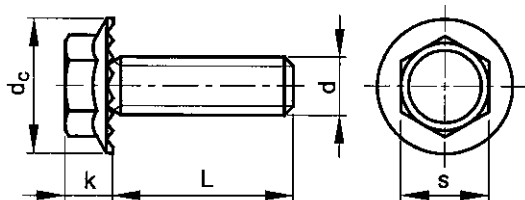

Informacje techniczne

d	d _c	k	P	s
M5	11.2	4.3	0.8	8
M6	14.2	5.5	1	10
M8	18.2	7	1.25	13
M10	21	7.9	1.5	15
M12	24	8.7	1.75	17
M16	31	11.2	2	22

Śruby samozabezpieczające z łbem sześciokątnym oznaczone klasą właściwości 90 i 100, z minimalną wytrzymałością na rozciąganie odpowiednio 900 i 1040 N/mm², są nawęglane i w związku z tym nie mogą zostać umieszczone w klasie 8.8 i 10.9.

MONTAŻ Z OBCIĄŻENIEM WSTĘPNYM F_m w kN, a MOMENT SKRĘCAJĄCY M_a w Nm

Klasa	Dopasowanie materiału	M5		M6		M8		M10		M12		M16	
		FM	MA	FM	MA	FM	MA	FM	MA	FM	MA	FM	MA
90	Stal	6,35	9	9	16	16,5	34	26,2	58	--	--	--	--
	Stal zgrzewna/ żeliwo ciągliwe	6,35	7	9	13	16,5	28	26,2	49	--	--	--	--
100	Stal	--	--	--	--	--	--	--	--	54	120	102	280
	Stal zgrzewna/ żeliwo ciągliwe	--	--	--	--	--	--	--	--	54	105	102	260

Grupy katalogowe

Gwint	Gniazdo	Materiał	Klasa	Obróbka powierzchni	Kod	Strona
M	Sześciokąt	St	90/100		01050	1-64
M	Sześciokąt	St	90/100	Ocynk.	01049	1-65
M	Sześciokąt	St	90/100	FLZNNC-NC6	01055	1-65

01050 Śruby samozabezpieczające z łbem sześciokątnym z kołnierzem stożkowym

A92A

Gwint: Metryczny
Materiał: Stal
Klasa: 90/100



d x L	☒	Kod artykułu	d x L	☒	Kod artykułu	d x L	☒	Kod artykułu
M5X10	500	01050.050.010	M8X25	200	01050.080.025	M12X35	100	01050.120.035
M5X12	500	01050.050.012	M8X30	200	01050.080.030	M12X40	100	01050.120.040
M5X16	500	01050.050.016	M8X35	200	01050.080.035	M12X45	100	01050.120.045
M5X20	500	01050.050.020	M8X40	200	01050.080.040	M12X50	100	01050.120.050
M6X10	500	01050.060.010	M10X16	200	01050.100.016	M16X25	50	01050.160.025
M6X12	500	01050.060.012	M10X20	200	01050.100.020	M16X30	50	01050.160.030
M6X16	500	01050.060.016	M10X25	200	01050.100.025	M16X35	50	01050.160.035
M6X20	500	01050.060.020	M10X30	200	01050.100.030	M16X40	50	01050.160.040
M6X25	500	01050.060.025	M10X35	100	01050.100.035	M16X45	50	01050.160.045
M6X30	500	01050.060.030	M10X40	100	01050.100.040	M16X50	50	01050.160.050
M8X12	200	01050.080.012	M12X20	100	01050.120.020	M16X55	50	01050.160.055
M8X16	200	01050.080.016	M12X25	100	01050.120.025	M16X60	50	01050.160.060
M8X20	200	01050.080.020	M12X30	100	01050.120.030	M16X70	25	01050.160.070

01049		Śruby samozabezpieczające z łbem sześciokątnym z kołnierzem stożkowym		A92A	
Gwint	Metryczny				
Materiał	Stal				
Klasa	90/100				
Obróbka powierzchni	Ocynkowane				

d x L	☒	Kod artykułu	d x L	☒	Kod artykułu	d x L	☒	Kod artykułu
M5X8	500	01049.050.008	M6X30	500	01049.060.030	M10X25	200	01049.100.025
M5X10	500	01049.050.010				M10X30	200	01049.100.030
M5X12	500	01049.050.012	M8X12	200	01049.080.012			
M5X14	500	01049.050.014	M8X14	200	01049.080.014	M12X20	100	01049.120.020
M5X16	500	01049.050.016	M8X16	200	01049.080.016	M12X25	100	01049.120.025
M5X20	500	01049.050.020	M8X18	200	01049.080.018	M12X30	100	01049.120.030
			M8X22	200	01049.080.022	M12X35	100	01049.120.035
M6X10	500	01049.060.010	M8X25	200	01049.080.025	M12X40	100	01049.120.040
M6X12	500	01049.060.012	M8X30	200	01049.080.030			
M6X14	500	01049.060.014	M8X35	200	01049.080.035	M16X25	50	01049.160.025
M6X16	500	01049.060.016				M16X35	50	01049.160.035
M6X20	500	01049.060.020	M10X18	200	01049.100.018	M16X40	50	01049.160.040
M6X25	500	01049.060.025	M10X20	200	01049.100.020	M16X50	50	01049.160.050

01055		Śruby samozabezpieczające z łbem sześciokątnym z kołnierzem stożkowym		A94A	
Gwint	Metryczny				
Materiał	Stal				
Klasa	90/100				
Obróbka powierzchni	Ocynk płatkowy bez Cr6+ wg ISO 10683 (flZnnc)				

d x L	☒	Kod artykułu	d x L	☒	Kod artykułu	d x L	☒	Kod artykułu
M6X10	500	01055.060.010	M8X20	200	01055.080.020	M12X30	100	01055.120.030
M6X12	500	01055.060.012	M8X25	200	01055.080.025	M12X40	100	01055.120.040
M6X16	500	01055.060.016	M8X30	200	01055.080.030	M12X50	100	01055.120.050
M6X20	500	01055.060.020						
M6X25	500	01055.060.025	M10X25	200	01055.100.025	M16X40	50	01055.160.040
			M10X30	200	01055.100.030	M16X50	50	01055.160.050
M8X12	200	01055.080.012	M10X40	200	01055.100.040			
M8X16	200	01055.080.016						

- Powlekanie powierzchniowe ISO 10683 cynkowanie płatkowe eliminuje możliwości uszkodzenia, jakie może wywołać kruchość wodorowa.

Śruby z łbem sześciokątnym z kołnierzem stożkowym metryczne

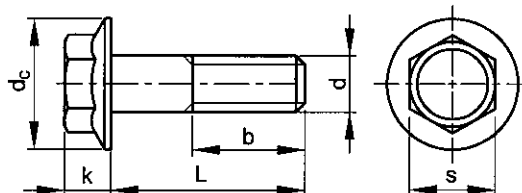

DIN 6921
 ISO ≈4162
 EN ≈1665
 ASME ≈B18.2.3.4M

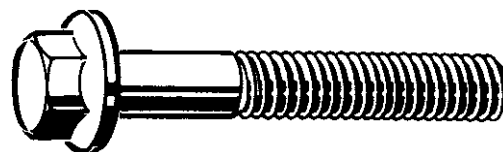

Informacje techniczne

d	b (min.)	d _c (maks.)	k (maks.)	P	s
M6	18	14.2	6.6	1	10
M8	22	18	8.1	1.25	13
M10	26	22.3	9.2	1.5	15
M12	30	26.6	11.5	1.75	16
M14	34	30.5	12.8	2	18
M16	38	35	14.4	2	21
M20	46	43	17.1	2.5	27

Grupy katalogowe

Gwint	Gniazdo	Materiał	Klasa	Obróbka powierzchni	Kod	Strona
M	Sześciokąt	St	8.8	Ocynk. żłt. pas.	01256	1-66
M	Sześciokąt	St	10.9		04132	1-67

01256 Śruby z łbem sześciokątnym z kołnierzem stożkowym metryczne

A94A

Gwint Metryczny
Materiał Stal
Klasa 8.8
Obróbka powierzchni Ocynkowane, po żółtej pasywacji



d x L	☒	Kod artykułu	d x L	☒	Kod artykułu	d x L	☒	Kod artykułu
M6X12	200	01256.060.012	M10X25	200	01256.100.025	M14X35	100	01256.140.035
M6X16	200	01256.060.016	M10X30	200	01256.100.030	M14X40	100	01256.140.040
M6X20	200	01256.060.020	M10X35	200	01256.100.035	M14X45	50	01256.140.045
M6X25	200	01256.060.025	M10X40	100	01256.100.040	M14X50	50	01256.140.050
M6X30	200	01256.060.030	M10X45	100	01256.100.045	M14X60	50	01256.140.060
M6X40	200	01256.060.040	M10X50	100	01256.100.050	M14X80	50	01256.140.080
M6X45	200	01256.060.045	M10X60	100	01256.100.060			
M6X50	200	01256.060.050	M10X70	100	01256.100.070	M16X35	50	01256.160.035
			M10X80	100	01256.100.080	M16X40	50	01256.160.040
M8X12	200	01256.080.012	M10X100	100	01256.100.100	M16X45	50	01256.160.045
M8X16	200	01256.080.016				M16X50	50	01256.160.050
M8X20	200	01256.080.020	M12X25	100	01256.120.025	M16X60	50	01256.160.060
M8X25	200	01256.080.025	M12X30	100	01256.120.030	M16X70	25	01256.160.070
M8X30	200	01256.080.030	M12X35	100	01256.120.035	M16X80	25	01256.160.080
M8X35	200	01256.080.035	M12X40	100	01256.120.040	M16X100	25	01256.160.100
M8X40	200	01256.080.040	M12X45	100	01256.120.045			
M8X45	200	01256.080.045	M12X50	100	01256.120.050	M20X50	25	01256.200.050
M8X50	200	01256.080.050	M12X60	100	01256.120.060	M20X60	25	01256.200.060
M8X60	200	01256.080.060	M12X70	50	01256.120.070	M20X70	25	01256.200.070
M8X70	200	01256.080.070	M12X80	50	01256.120.080	M20X80	10	01256.200.080
M8X80	100	01256.080.080	M12X90	50	01256.120.090	M20X90	10	01256.200.090
M8X100	100	01256.080.100	M12X100	50	01256.120.100	M20X100	10	01256.200.100
			M12X120	50	01256.120.120	M20X120	10	01256.200.120
M10X20	200	01256.100.020						

- Specjalne cechy śrub sześciokątnych z kołnierzem stożkowym:
- Kołnierz pozwala na rozłożenie przenoszonych obciążeń na większym obszarze, zmniejszając tym samym nacisk na powierzchnię.
- Kołnierz może zakryć duże (nadwymiarowe) otwory i/lub otwory narzędziowe.
- Podkładka jest zbędna.

04132		Śruby z łbem sześciokątnym z kołnierzem stożkowym metryczne		A92A	
Gwint	Metryczny				
Materiał	Stal				
Klasa	10.9				

d x L	☒	Kod artykułu	d x L	☒	Kod artykułu	d x L	☒	Kod artykułu
M6X20	200	04132.060.020	M10X40	100	04132.100.040	M12X90	50	04132.120.090
M6X25	200	04132.060.025	M10X50	100	04132.100.050			
M6X30	200	04132.060.030	M10X60	100	04132.100.060	M14X35	50	04132.140.035
M6X40	200	04132.060.040	M10X70	100	04132.100.070	M14X40	50	04132.140.040
M6X50	200	04132.060.050				M14X45	50	04132.140.045
			M12X25	100	04132.120.025	M14X50	50	04132.140.050
M8X20	200	04132.080.020	M12X30	100	04132.120.030			
M8X25	200	04132.080.025	M12X35	100	04132.120.035	M16X35	50	04132.160.035
M8X30	200	04132.080.030	M12X40	100	04132.120.040	M16X40	50	04132.160.040
M8X40	200	04132.080.040	M12X45	100	04132.120.045	M16X45	50	04132.160.045
M8X50	200	04132.080.050	M12X50	100	04132.120.050	M16X50	50	04132.160.050
			M12X60	100	04132.120.060	M16X60	50	04132.160.060
M10X20	200	04132.100.020	M12X70	50	04132.120.070	M16X70	25	04132.160.070
M10X25	200	04132.100.025	M12X80	50	04132.120.080	M16X80	25	04132.160.080
M10X30	200	04132.100.030						

- Specjalne cechy śrub sześciokątnych z kołnierzem stożkowym:
- Kołnierz pozwala na rozłożenie przenoszonych obciążeń na większym obszarze, zmniejszając tym samym nacisk na powierzchnię.
- Kołnierz może zakryć duże (nadwymiarowe) otwory i/lub otwory narzędziowe.
- Podkładka jest zbędna.
- Ostrzeżenie: cynkowanie elektrolityczne tych produktów może wywołać kruchość wodorową.

Śruby z łbem sześciokątnym z kołnierzem stożkowym metryczne, z pełnym gwintem

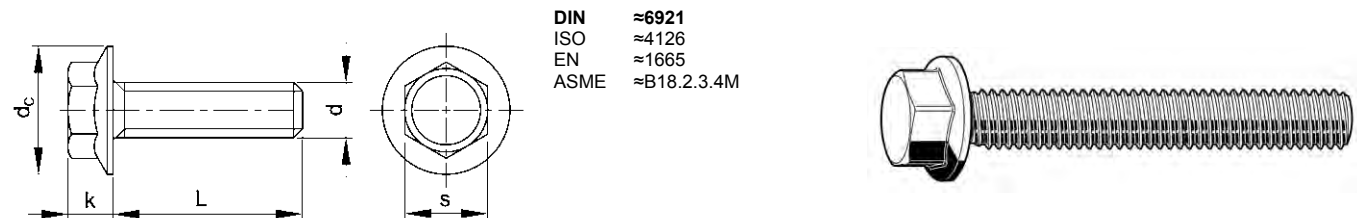

DIN ≈6921
 ISO ≈4126
 EN ≈1665
 ASME ≈B18.2.3.4M

Informacje techniczne

d	b (min.)	d _c (maks.)	k (maks.)	P	s
M5	16	11.8	5.4	0.8	8
M6	18	14.2	6.6	1	10
M8	22	18	8.1	1.25	13
M10	26	22.3	9.2	1.5	15
M12	30	26.6	11.5	1.75	16

Grupy katalogowe

Gwint	Gniazdo	Materiał	Klasa	Kod	Strona
M	Sześciokąt	St.St. A2	70	51018	1-67
M	Sześciokąt	St.St. A4	70	55018	1-68

51018		Śruby z łbem sześciokątnym z kołnierzem stożkowym metryczne, z pełnym gwintem		Q01A	
Gwint	Metryczny				
Materiał	Stal nierdzewna A2				
Klasa	70				

d x L	☒	Kod artykułu	d x L	☒	Kod artykułu	d x L	☒	Kod artykułu
M5X8*	200	51018.050.008				M6X55*	200	51018.060.055
M5X10	200	51018.050.010	M6X10*	200	51018.060.010	M6X60*	200	51018.060.060
M5X12*	200	51018.050.012	M6X12*	200	51018.060.012			
M5X16*	200	51018.050.016	M6X16	200	51018.060.016	M8X12*	200	51018.080.012
M5X20*	200	51018.050.020	M6X20	200	51018.060.020	M8X16	200	51018.080.016
M5X25*	200	51018.050.025	M6X25*	200	51018.060.025	M8X20*	200	51018.080.020
M5X30*	200	51018.050.030	M6X30*	200	51018.060.030	M8X25	200	51018.080.025
M5X35*	200	51018.050.035	M6X35*	200	51018.060.035	M8X30*	200	51018.080.030
M5X40*	200	51018.050.040	M6X40*	200	51018.060.040	M8X35*	200	51018.080.035
M5X45*	200	51018.050.045	M6X45*	200	51018.060.045	M8X40*	200	51018.080.040
M5X50*	200	51018.050.050	M6X50*	200	51018.060.050	M8X45*	200	51018.080.045

51018 Śruby z łbem sześciokątnym z kołnierzem stożkowym metryczne, z pełnym gwintem								
d x L	☒	Kod artykułu	d x L	☒	Kod artykułu	d x L	☒	Kod artykułu
M8X50*	200	51018.080.050	M10X20*	100	51018.100.020	M10X60*	100	51018.100.060
M8X55*	200	51018.080.055	M10X25*	100	51018.100.025	M10X65*	100	51018.100.065
M8X60*	200	51018.080.060	M10X30*	100	51018.100.030	M10X70*	100	51018.100.070
M8X65*	200	51018.080.065	M10X35*	100	51018.100.035	M10X80*	100	51018.100.080
M8X70*	200	51018.080.070	M10X40*	100	51018.100.040			
M8X80*	200	51018.080.080	M10X45*	100	51018.100.045	M12X60*	50	51018.120.060
M10X16*	100	51018.100.016	M10X50*	100	51018.100.050			
			M10X55*	100	51018.100.055			

55018 Śruby z łbem sześciokątnym z kołnierzem stożkowym metryczne, z pełnym gwintem		Q41A
Gwint	Metryczny	
Materiał	Stal nierdzewna A4	
Klasa	70	

d x L	☒	Kod artykułu	d x L	☒	Kod artykułu	d x L	☒	Kod artykułu
M5X8*	200	55018.050.008	M6X30*	200	55018.060.030	M8X55*	200	55018.080.055
M5X10*	200	55018.050.010	M6X35*	200	55018.060.035	M8X60*	200	55018.080.060
M5X12*	200	55018.050.012	M6X40*	200	55018.060.040			
M5X16*	200	55018.050.016	M6X45*	200	55018.060.045	M10X16*	100	55018.100.016
M5X20*	200	55018.050.020	M6X50*	200	55018.060.050	M10X20*	100	55018.100.020
M5X25*	200	55018.050.025	M6X55*	200	55018.060.055	M10X25*	100	55018.100.025
M5X30*	200	55018.050.030	M6X60*	200	55018.060.060	M10X30*	100	55018.100.030
M5X35*	200	55018.050.035				M10X35*	100	55018.100.035
M5X40*	200	55018.050.040	M8X12*	200	55018.080.012	M10X40*	100	55018.100.040
M5X45*	200	55018.050.045	M8X16*	200	55018.080.016	M10X45*	100	55018.100.045
M5X50*	200	55018.050.050	M8X20*	200	55018.080.020	M10X50*	100	55018.100.050
			M8X25*	200	55018.080.025	M10X55*	100	55018.100.055
M6X10*	200	55018.060.010	M8X30*	200	55018.080.030	M10X60*	100	55018.100.060
M6X12*	200	55018.060.012	M8X35*	200	55018.080.035	M10X65*	100	55018.100.065
M6X16*	200	55018.060.016	M8X40*	200	55018.080.040	M10X70*	100	55018.100.070
M6X20*	200	55018.060.020	M8X45*	200	55018.080.045	M10X80*	100	55018.100.080
M6X25*	200	55018.060.025	M8X50*	200	55018.080.050			

Śruby z łbem kołnierzowym ząbkowanym, z pełnym gwintem

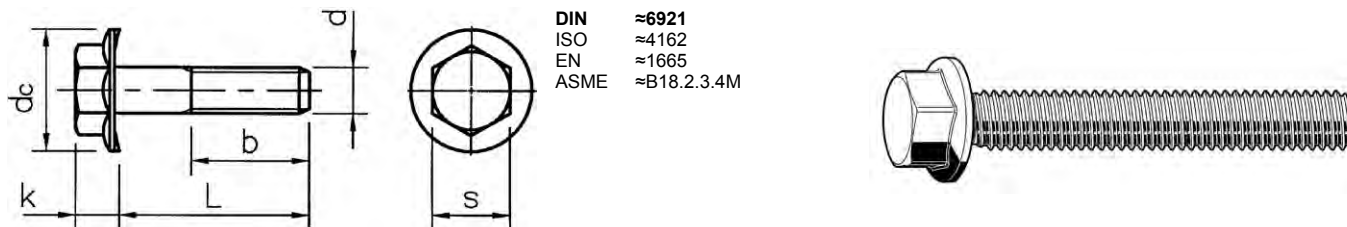

Informacje techniczne

d	b (min.)	d _c (maks.)	k (maks.)	P	s
M5	16	11.8	5.4	0.8	8
M6	18	14.2	6.6	1	10
M8	22	18	8.1	1.25	13
M10	26	22.3	9.2	1.5	15
M12	30	26.6	11.5	1.75	16

Grupy katalogowe

Gwint	Gniazdo	Materiał	Klasa	Obróbka powierzchni	Kod	Strona
M	Sześciokąt	St	8.8	Ocynek.	01258	1-69
M	Sześciokąt	St.St. A2	70		51014	1-69

01258		Śruba sześciokątna z łbem kołnierzym ząbkowanym, pełny gwint		A94A	
Gwint	Metryczny				
Materiał	Stal				
Klasa	8.8				
Obróbka powierzchni	Ocynkowane				

d x L	☒	Kod artykułu	d x L	☒	Kod artykułu	d x L	☒	Kod artykułu
M6X12	200	01258.060.012	M8X25	200	01258.080.025	M10X40	100	01258.100.040
M6X16	200	01258.060.016	M8X30	200	01258.080.030			
M6X20	200	01258.060.020				M12X20	100	01258.120.020
M6X25	200	01258.060.025	M10X20	200	01258.100.020	M12X25	100	01258.120.025
M6X30	200	01258.060.030	M10X25	200	01258.100.025	M12X30	100	01258.120.030
			M10X30	200	01258.100.030	M12X35	100	01258.120.035
M8X16	200	01258.080.016	M10X35	100	01258.100.035	M12X40	100	01258.120.040
M8X20	200	01258.080.020						

- Specjalne cechy śrub sześciokątnych z ząbkowanym kołnierzem stożkowym:
- Kołnier pozwala na rozłożenie przenoszonych obciążeń na większym obszarze, zmniejszając tym samym nacisk na powierzchnię.
- Kołnier może zakryć duże (nadwymiarowe) otwory i/lub otwory narzędziowe.
- Podkładka jest zbędna.
- Ząbkowana krawędź kołnierza zapewnia doskonałe właściwości samohamowne.

51014		Śruba sześciokątna z łbem kołnierzym ząbkowanym, pełny gwint		Q01A	
Gwint	Metryczny				
Materiał	Stal nierdzewna A2				
Klasa	70				

d x L	☒	Kod artykułu	d x L	☒	Kod artykułu	d x L	☒	Kod artykułu
M5X8*	200	51014.050.008	M6X35*	200	51014.060.035	M8X55*	200	51014.080.055
M5X10*	200	51014.050.010	M6X40*	200	51014.060.040	M8X60*	200	51014.080.060
M5X12*	200	51014.050.012	M6X45*	200	51014.060.045			
M5X16*	200	51014.050.016	M6X50*	200	51014.060.050	M10X16*	100	51014.100.016
M5X20*	200	51014.050.020	M6X55*	200	51014.060.055	M10X20*	100	51014.100.020
M5X25*	200	51014.050.025	M6X60*	200	51014.060.060	M10X25*	100	51014.100.025
M5X30*	200	51014.050.030				M10X30*	100	51014.100.030
M5X40*	200	51014.050.040	M8X12*	200	51014.080.012	M10X35*	100	51014.100.035
M5X50*	200	51014.050.050	M8X16*	200	51014.080.016	M10X40*	100	51014.100.040
			M8X20*	200	51014.080.020	M10X45*	100	51014.100.045
M6X10*	200	51014.060.010	M8X25*	200	51014.080.025	M10X50*	100	51014.100.050
M6X12*	200	51014.060.012	M8X30*	200	51014.080.030	M10X60*	100	51014.100.060
M6X16*	200	51014.060.016	M8X35*	200	51014.080.035	M10X65*	100	51014.100.065
M6X20*	200	51014.060.020	M8X40*	200	51014.080.040			
M6X25*	200	51014.060.025	M8X45*	200	51014.080.045	M12X90*	50	51014.120.090
M6X30*	200	51014.060.030	M8X50*	200	51014.080.050			

- Specjalne cechy śrub sześciokątnych z ząbkowanym kołnierzem stożkowym:
- Kołnier pozwala na rozłożenie przenoszonych obciążeń na większym obszarze, zmniejszając tym samym nacisk na powierzchnię.
- Kołnier może zakryć duże (nadwymiarowe) otwory i/lub otwory narzędziowe.
- Podkładka jest zbędna.
- Ząbkowana krawędź kołnierza zapewnia doskonałe właściwości samohamowne.

Śruby z łbem sześciokątnym z kołnierzem stożkowym metryczne drobnozwojne

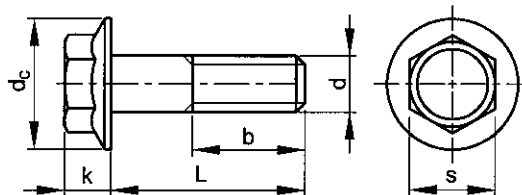

DIN 6921
 ISO ≈4162
 EN ≈1665
 ASME ≈B18.2.3.4M

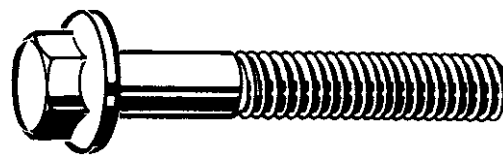

Informacje techniczne

d	b (min.)	d _c (maks.)	k (maks.)	s
M8	22	18	8.1	13
M10	26	22.3	9.2	15
M12	30	26.6	11.5	16
M14	34	30.5	12.8	18
M16	38	35	14.4	21

- Specjalne cechy śrub sześciokątnych z kołnierzem stożkowym:
- Kołnierz pozwala na rozłożenie przenoszonych obciążeń na większym obszarze, zmniejszając tym samym nacisk na powierzchnię.
- Kołnierz może przykryć duże (nadwymiarowe) otwory i/lub otwory narzędziowe.
- Nie jest potrzebna podkładka.

04135 Śruby z łbem sześciokątnym z kołnierzem stożkowym metryczne drobnozwojne

A92A

Gwint Metryczny drobnozwojny
Materiał Stal
Klasa 10.9

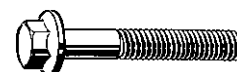

d x P x L	☒	Kod artykułu	d x P x L	☒	Kod artykułu	d x P x L	☒	Kod artykułu
M8X1,00X25	200	04135.080.025	M12X1,50X25	100	04135.120.025	M14X1,50X50	50	04135.140.050
M8X1,00X30	200	04135.080.030	M12X1,50X30	100	04135.120.030	M14X1,50X60	50	04135.140.060
M10X1,25X20	200	04135.100.020	M12X1,50X40	100	04135.120.040	M16X1,50X35	50	04135.160.035
M10X1,25X30	200	04135.100.030	M12X1,50X45	100	04135.120.045	M16X1,50X40	50	04135.160.040
M10X1,25X40	100	04135.100.040	M12X1,50X50	100	04135.120.050	M16X1,50X45	50	04135.160.045
M10X1,25X50	100	04135.100.050	M14X1,50X35	50	04135.140.035	M16X1,50X50	50	04135.160.050
M10X1,25X60	100	04135.100.060	M14X1,50X40	50	04135.140.040	M16X1,50X60	50	04135.160.060
M10X1,25X70	100	04135.100.070						

- Ostrzeżenie: cynkowanie elektrolityczne tych produktów może wywołać kruchość wodorową.

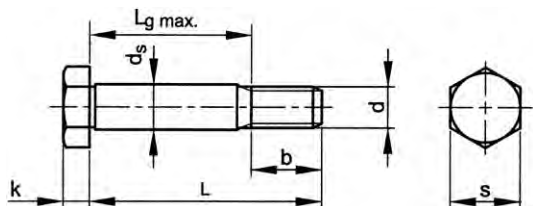
Śruby pasowane z łbem sześciokątnym z gwintem długim

DIN 609

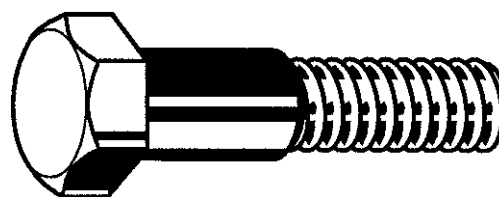
Informacje techniczne

d	b:L≤50mm	b:50mm<L≤150mm	d _s (k6)	k	P	s	Tolerancja ø wiertła
M10	17.5	19.5	11	6.4	1.5	16	H7
M12	20.5	22.5	13	7.5	1.75	18	H7
M16	25	27	17	10	2	24	H7
M18	27.5	29.5	19	11.5	2.5	27	H7
M20	28.5	30.5	21	12.5	2.5	30	H7
M24	-	36.5	25	15	3	36	H7
M30	-	43	32	19	3.5	46	H7
M36	-	49	38	22	4	55	H7

01040 Śruby pasowane z łbem sześciokątnym z gwintem długim
A90A

 Gwint Metryczny
 Material Stal
 Klasa 8.8

d x L	☒	Kod artykułu	d x L	☒	Kod artykułu	d x L	☒	Kod artykułu
M10X30	25	01040.100.030	M16X45	10	01040.160.045	M20X90	5	01040.200.090
M10X35	25	01040.100.035	M16X50	10	01040.160.050	M20X100	5	01040.200.100
M10X40	25	01040.100.040	M16X55	10	01040.160.055	M20X120	5	01040.200.120
M10X45	25	01040.100.045	M16X60	10	01040.160.060	M24X55	3	01040.240.055
M10X50	25	01040.100.050	M16X70	10	01040.160.070	M24X60	3	01040.240.060
M10X55	25	01040.100.055	M16X80	10	01040.160.080	M24X70	3	01040.240.070
M10X60	25	01040.100.060	M16X90	10	01040.160.090	M24X80	3	01040.240.080
M12X30	25	01040.120.030	M16X100	10	01040.160.100	M24X90	3	01040.240.090
M12X35	25	01040.120.035	M16X105	10	01040.160.105	M24X100	3	01040.240.100
M12X40	25	01040.120.040	M18X70	10	01040.180.070	M24X120	3	01040.240.120
M12X45	25	01040.120.045	M20X45	5	01040.200.045	M30X100	1	01040.300.100
M12X50	25	01040.120.050	M20X50	5	01040.200.050	M30X120	1	01040.300.120
M12X55	25	01040.120.055	M20X55	5	01040.200.055	M36X140	1	01040.360.140
M12X60	25	01040.120.060	M20X60	5	01040.200.060	M36X150	1	01040.360.150
M12X70	25	01040.120.070	M20X70	5	01040.200.070			
M16X40	10	01040.160.040	M20X80	5	01040.200.080			

Śruby z łbem grzybkowym z podsadzeniem

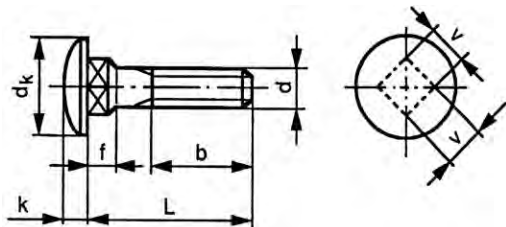

DIN	603
ISO	8677
NEN	303
ASME	B18.5.2.3M
BS	4933

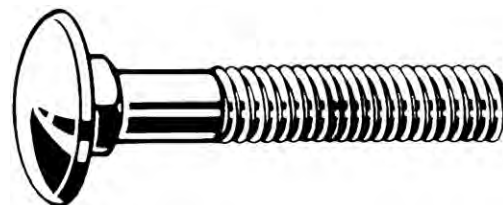

Informacje techniczne

d	b (min.): L≤125mm	b (min.): 125mm<L≤200mm	b (min.): L>200mm	dk (maks.)	f (maks.)	k (maks.)	P	v (maks.)
M5	16	22	-	13.55	4.1	3.3	0.8	5.48
M6	18	24	-	16.55	4.6	3.88	1	6.48
M8	22	28	41	20.65	5.6	4.88	1.25	8.58
M10	26	32	45	24.65	6.6	5.38	1.5	10.58
M12	30	36	49	30.65	8.75	6.95	1.75	12.7
M16	38	44	57	38.80	12.9	8.95	2	16.7

• Wymiar 'b' jest wartością orientacyjną, zależy od długości całkowitej

Grupy katalogowe

Gwint	Materiał	Klasa	Obróbka powierzchni	Kod	Strona
M	St	8.8		08310	1-72
M	St	8.8	Ocynk.	08320	1-72
M	St.St. A2			51500	1-73
M	St.St. A4			55500	1-73

08310 Śruby z łbem grzybkowym z podsadzeniem A90A

Gwint	Metryczny
Materiał	Stal
Klasa	8.8



d x L	☒	Kod artykułu	d x L	☒	Kod artykułu	d x L	☒	Kod artykułu
M6X16	200	08310.060.016	M8X60	100	08310.080.060	M12X25	100	08310.120.025
M6X20	200	08310.060.020	M8X70	100	08310.080.070	M12X30	100	08310.120.030
M6X25	200	08310.060.025	M8X80	100	08310.080.080	M12X35	100	08310.120.035
M6X30	200	08310.060.030				M12X40	50	08310.120.040
M6X35	200	08310.060.035	M10X20	100	08310.100.020	M12X45	50	08310.120.045
M6X40	200	08310.060.040	M10X25	100	08310.100.025	M12X50	50	08310.120.050
M6X45	200	08310.060.045	M10X30	100	08310.100.030	M12X55	50	08310.120.055
M6X50	200	08310.060.050	M10X35	100	08310.100.035	M12X60	50	08310.120.060
			M10X40	100	08310.100.040	M12X65	50	08310.120.065
M8X16	200	08310.080.016	M10X45	100	08310.100.045	M12X70	50	08310.120.070
M8X20	200	08310.080.020	M10X50	100	08310.100.050	M12X80	50	08310.120.080
M8X25	200	08310.080.025	M10X55	100	08310.100.055	M12X90	50	08310.120.090
M8X30	200	08310.080.030	M10X60	100	08310.100.060	M12X100	50	08310.120.100
M8X35	200	08310.080.035	M10X70	100	08310.100.070			
M8X40	200	08310.080.040	M10X80	50	08310.100.080	M16X90	25	08310.160.090
M8X45	200	08310.080.045	M10X90	50	08310.100.090	M16X120	25	08310.160.120
M8X50	200	08310.080.050	M10X100	50	08310.100.100			
M8X55	100	08310.080.055						

08320 Śruby z łbem grzybkowym z podsadzeniem A90A

Gwint	Metryczny
Materiał	Stal
Klasa	8.8
Obróbka powierzchni	Ocynkowane



d x L	☒	Kod artykułu	d x L	☒	Kod artykułu	d x L	☒	Kod artykułu
M6X16	200	08320.060.016	M8X30	200	08320.080.030	M10X25	100	08320.100.025
M6X20	200	08320.060.020	M8X35	200	08320.080.035	M10X30	100	08320.100.030
M6X30	200	08320.060.030	M8X40	200	08320.080.040	M10X35	100	08320.100.035
M6X40	200	08320.060.040	M8X45	200	08320.080.045	M10X40	100	08320.100.040
M6X50	200	08320.060.050	M8X50	200	08320.080.050	M10X50	100	08320.100.050
			M8X55	100	08320.080.055	M10X60	100	08320.100.060
M8X16	200	08320.080.016	M8X60	100	08320.080.060	M10X70	100	08320.100.070
M8X20	200	08320.080.020				M10X80	50	08320.100.080
M8X25	200	08320.080.025	M10X20	100	08320.100.020	M10X90	50	08320.100.090

08320 Śruby z łbem grzybkowym z podsadzeniem								
d x L	☒	Kod artykułu	d x L	☒	Kod artykułu	d x L	☒	Kod artykułu
M10X100	50	08320.100.100	M12X40	50	08320.120.040	M12X70	50	08320.120.070
M12X30	100	08320.120.030	M12X45	50	08320.120.045	M12X80	50	08320.120.080
M12X35	100	08320.120.035	M12X50	50	08320.120.050	M12X90	50	08320.120.090
			M12X60	50	08320.120.060	M12X100	50	08320.120.100

51500 Śruby z łbem grzybkowym z podsadzeniem								R03A
Gwint	Metryczny							
Material	Stal nierdzewna A2							

d x L	☒	Kod artykułu	d x L	☒	Kod artykułu	d x L	☒	Kod artykułu
M5X12*	500	51500.050.012	M8X100	25	51500.080.100	M12X55*	50	51500.120.055
M5X16	50	51500.050.016	M8X110	25	51500.080.110	M12X60	10	51500.120.060
M5X18*	200	51500.050.018	M8X120	50	51500.080.120	M12X70	10	51500.120.070
M5X20	50	51500.050.020	M8X130	25	51500.080.130	M12X80	10	51500.120.080
M5X25	50	51500.050.025	M8X140	25	51500.080.140	M12X90	10	51500.120.090
M5X30	50	51500.050.030	M8X150	25	51500.080.150	M12X100	10	51500.120.100
M5X35	50	51500.050.035	M8X160*	50	51500.080.160	M12X110	10	51500.120.110
M5X40	50	51500.050.040	M8X170*	50	51500.080.170	M12X120	10	51500.120.120
M5X45	50	51500.050.045	M8X180*	50	51500.080.180	M12X130	10	51500.120.130
M5X50	50	51500.050.050	M8X190*	50	51500.080.190	M12X140	10	51500.120.140
M5X60	50	51500.050.060	M8X200*	50	51500.080.200	M12X160*	50	51500.120.160
M6X16	50	51500.060.016	M10X16*	100	51500.100.016	M12X180*	50	51500.120.180
M6X20	50	51500.060.020	M10X20	25	51500.100.020	M12X200*	50	51500.120.200
M6X25	50	51500.060.025	M10X25	25	51500.100.025	M12X220*	50	51500.120.220
M6X30	50	51500.060.030	M10X30	25	51500.100.030	M12X240*	50	51500.120.240
M6X35	50	51500.060.035	M10X35	25	51500.100.035	M12X260*	50	51500.120.260
M6X40	50	51500.060.040	M10X40	25	51500.100.040	M12X280*	50	51500.120.280
M6X45	50	51500.060.045	M10X45	25	51500.100.045	M12X300*	50	51500.120.300
M6X50	50	51500.060.050	M10X50	25	51500.100.050	M16X30*	25	51500.160.030
M6X55	50	51500.060.055	M10X55	25	51500.100.055	M16X35*	25	51500.160.035
M6X60	50	51500.060.060	M10X60	10	51500.100.060	M16X40*	25	51500.160.040
M6X70	50	51500.060.070	M10X70	10	51500.100.070	M16X45	10	51500.160.045
M6X80	50	51500.060.080	M10X80	10	51500.100.080	M16X50*	25	51500.160.050
M6X90	50	51500.060.090	M10X90	10	51500.100.090	M16X55*	25	51500.160.055
M6X100	50	51500.060.100	M10X100	10	51500.100.100	M16X60	10	51500.160.060
M6X110	50	51500.060.110	M10X110	10	51500.100.110	M16X65	10	51500.160.065
M6X120	50	51500.060.120	M10X120	10	51500.100.120	M16X70*	25	51500.160.070
M8X12*	100	51500.080.012	M10X130	10	51500.100.130	M16X75*	25	51500.160.075
M8X16	50	51500.080.016	M10X140	10	51500.100.140	M16X80*	25	51500.160.080
M8X18*	100	51500.080.018	M10X150	10	51500.100.150	M16X90*	25	51500.160.090
M8X20	50	51500.080.020	M10X160	50	51500.100.160	M16X100*	25	51500.160.100
M8X25	50	51500.080.025	M10X180	50	51500.100.180	M16X110*	25	51500.160.110
M8X30	50	51500.080.030	M10X200*	50	51500.100.200	M16X120*	25	51500.160.120
M8X35	50	51500.080.035	M10X220*	50	51500.100.220	M16X130*	25	51500.160.130
M8X40	25	51500.080.040	M10X240*	50	51500.100.240	M16X140*	25	51500.160.140
M8X45	25	51500.080.045	M10X260*	50	51500.100.260	M16X150*	25	51500.160.150
M8X50	25	51500.080.050	M10X280*	50	51500.100.280	M16X160*	25	51500.160.160
M8X55	25	51500.080.055	M10X300*	50	51500.100.300	M16X180*	25	51500.160.180
M8X60	25	51500.080.060	M12X25	10	51500.120.025	M16X200*	25	51500.160.200
M8X65	100	51500.080.065	M12X30	10	51500.120.030	M16X220*	25	51500.160.220
M8X70	25	51500.080.070	M12X35	10	51500.120.035	M16X240*	25	51500.160.240
M8X75*	50	51500.080.075	M12X40	10	51500.120.040	M16X260*	25	51500.160.260
M8X80	25	51500.080.080	M12X50	10	51500.120.050	M16X280*	25	51500.160.280
M8X90	25	51500.080.090				M16X300*	25	51500.160.300

55500 Śruby z łbem grzybkowym z podsadzeniem								R43A
Gwint	Metryczny							
Material	Stal nierdzewna A4							

d x L	☒	Kod artykułu	d x L	☒	Kod artykułu	d x L	☒	Kod artykułu
M5X16	50	55500.050.016	M5X70	50	55500.050.070	M6X40	50	55500.060.040
M5X20	50	55500.050.020				M6X45	50	55500.060.045
M5X25*	200	55500.050.025	M6X12*	200	55500.060.012	M6X50	50	55500.060.050
M5X30	50	55500.050.030	M6X16	50	55500.060.016	M6X60	50	55500.060.060
M5X35	50	55500.050.035	M6X20	50	55500.060.020	M6X65	50	55500.060.065
M5X40	50	55500.050.040	M6X25	50	55500.060.025	M6X70	50	55500.060.070
M5X50	50	55500.050.050	M6X30	50	55500.060.030	M6X80	50	55500.060.080
M5X60	50	55500.050.060	M6X35	50	55500.060.035	M6X90	50	55500.060.090

55500 Śruby z łbem grzybkowym z podsadzeniem								
d x L	☒	Kod artykułu	d x L	☒	Kod artykułu	d x L	☒	Kod artykułu
M6X100	50	55500.060.100	M10X40	25	55500.100.040	M12X110	10	55500.120.110
M6X110	25	55500.060.110	M10X50	25	55500.100.050	M12X120	10	55500.120.120
M6X120	25	55500.060.120	M10X60	10	55500.100.060	M12X130	10	55500.120.130
			M10X70	10	55500.100.070	M12X140	10	55500.120.140
M8X10*	50	55500.080.010	M10X80	10	55500.100.080	M12X150	10	55500.120.150
M8X16	50	55500.080.016	M10X100	10	55500.100.100	M12X160*	50	55500.120.160
M8X20	50	55500.080.020	M10X110	10	55500.100.110	M12X180*	50	55500.120.180
M8X25	50	55500.080.025	M10X120	10	55500.100.120			
M8X30	50	55500.080.030	M10X130	10	55500.100.130	M16X40	10	55500.160.040
M8X35	50	55500.080.035	M10X140	10	55500.100.140	M16X50	10	55500.160.050
M8X40	25	55500.080.040	M10X150	10	55500.100.150	M16X55*	25	55500.160.055
M8X50	25	55500.080.050	M10X160*	50	55500.100.160	M16X60	10	55500.160.060
M8X60	25	55500.080.060	M10X200*	50	55500.100.200	M16X65*	25	55500.160.065
M8X70	25	55500.080.070				M16X70	10	55500.160.070
M8X80	25	55500.080.080	M12X25*	50	55500.120.025	M16X75*	25	55500.160.075
M8X90	25	55500.080.090	M12X30	10	55500.120.030	M16X80	5	55500.160.080
M8X100	25	55500.080.100	M12X35	10	55500.120.035	M16X90	5	55500.160.090
M8X110	10	55500.080.110	M12X40	10	55500.120.040	M16X100	5	55500.160.100
M8X120	10	55500.080.120	M12X45	10	55500.120.045	M16X110*	25	55500.160.110
M8X130	10	55500.080.130	M12X50	10	55500.120.050	M16X120	5	55500.160.120
M8X140	10	55500.080.140	M12X60	10	55500.120.060	M16X130	5	55500.160.130
M8X150	10	55500.080.150	M12X70	10	55500.120.070	M16X140	5	55500.160.140
			M12X80	10	55500.120.080	M16X150	5	55500.160.150
M10X20	25	55500.100.020	M12X90	10	55500.120.090			
M10X30	25	55500.100.030	M12X100	10	55500.120.100			

Śruby z łbem grzybkowym z podsadzeniem, pełny gwint

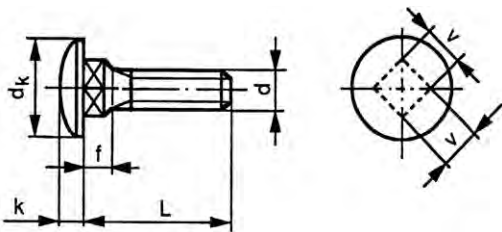

DIN ≈603
ISO ≈8677

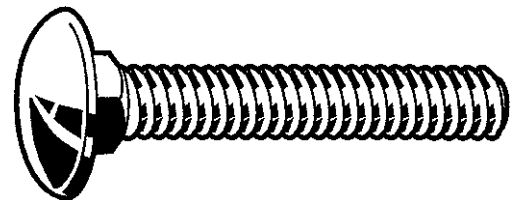

Informacje techniczne

d	b (min.): L≤125mm	b (min.): 125mm<L≤200mm	b (min.): L>200mm	dk (maks.)	f (maks.)	k (maks.)	P	v (maks.)
M5	16	22	-	13.55	4.1	3.3	0.8	5.48
M6	18	24	-	16.55	4.6	3.88	1	6.48
M8	22	28	41	20.65	5.6	4.88	1.25	8.58
M10	26	32	45	24.65	6.6	5.38	1.5	10.58
M12	30	36	49	30.65	8.75	6.95	1.75	12.7

Grupy katalogowe

Gwint	Material	Kod	Strona
M	St.St. A2	51501	1-74
M	St.St. A4	55501	1-75

51501 Śruby z łbem grzybkowym z podsadzeniem, pełny gwint

R09A

Gwint Metryczny
Material Stal nierdzewna A2



d x L	☒	Kod artykułu	d x L	☒	Kod artykułu	d x L	☒	Kod artykułu
M5X35*	200	51501.050.035	M6X25*	200	51501.060.025	M8X90*	50	51501.080.090
M5X45*	200	51501.050.045	M6X55*	100	51501.060.055	M8X120*	50	51501.080.120
M5X55*	200	51501.050.055	M6X65*	100	51501.060.065	M8X130*	50	51501.080.130
M5X65*	200	51501.050.065	M6X75*	100	51501.060.075	M8X140*	50	51501.080.140
M5X70*	200	51501.050.070	M6X110*	100	51501.060.110	M8X150*	50	51501.080.150
M5X75*	200	51501.050.075	M6X120*	100	51501.060.120			
M5X80*	200	51501.050.080	M6X130*	100	51501.060.130	M10X35*	100	51501.100.035
M5X90*	200	51501.050.090	M6X140*	100	51501.060.140	M10X40*	100	51501.100.040
M5X100*	200	51501.050.100	M6X150*	100	51501.060.150	M10X45*	100	51501.100.045
M5X110*	200	51501.050.110				M10X50*	50	51501.100.050
M5X120*	200	51501.050.120	M8X55*	100	51501.080.055	M10X55*	50	51501.100.055
			M8X65*	100	51501.080.065	M10X60*	50	51501.100.060
M6X12*	200	51501.060.012	M8X75*	50	51501.080.075	M10X65*	50	51501.100.065

51501 Śruby z łbem grzybkowym z podsadzeniem, pełny gwint								
d x L	☒	Kod artykułu	d x L	☒	Kod artykułu	d x L	☒	Kod artykułu
M10X70*	50	51501.100.070	M12X35*	50	51501.120.035	M12X90*	50	51501.120.090
M10X75*	50	51501.100.075	M12X45*	50	51501.120.045	M12X100*	50	51501.120.100
M10X80*	50	51501.100.080	M12X55*	50	51501.120.055	M12X110*	50	51501.120.110
M10X100*	50	51501.100.100	M12X60*	50	51501.120.060	M12X120*	50	51501.120.120
M10X110*	50	51501.100.110	M12X65*	50	51501.120.065	M12X130*	50	51501.120.130
M10X120*	50	51501.100.120	M12X70*	50	51501.120.070	M12X140*	50	51501.120.140
M10X130*	50	51501.100.130	M12X75*	50	51501.120.075	M12X150*	50	51501.120.150
M10X140*	50	51501.100.140	M12X80*	50	51501.120.080			
M10X150*	50	51501.100.150						

55501 Śruby z łbem grzybkowym z podsadzeniem, pełny gwint		R49A
Gwint	Metryczny	
Materiał	Stal nierdzewna A4	

d x L	☒	Kod artykułu	d x L	☒	Kod artykułu	d x L	☒	Kod artykułu
M5X45*	200	55501.050.045	M8X55*	100	55501.080.055	M10X65*	50	55501.100.065
M5X80*	200	55501.050.080	M8X65*	100	55501.080.065	M10X75*	50	55501.100.075
			M8X75*	50	55501.080.075	M10X90*	50	55501.100.090
M6X55*	100	55501.060.055	M10X16*	100	55501.100.016	M12X35*	50	55501.120.035
M6X65*	100	55501.060.065	M10X25*	100	55501.100.025	M12X45*	50	55501.120.045
M6X75*	100	55501.060.075	M10X35*	100	55501.100.035	M12X65*	50	55501.120.065
M6X140*	100	55501.060.140	M10X45*	100	55501.100.045	M12X75*	50	55501.120.075
M8X45*	100	55501.080.045	M10X55*	50	55501.100.055			

Śruby z łbem grzybkowym z podsadzeniem z nakrętką sześciokątną

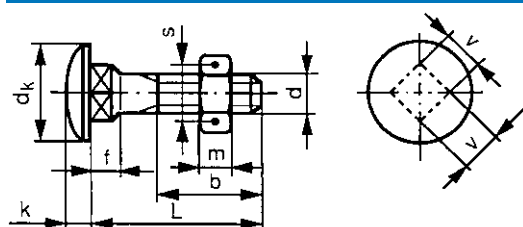

DIN 603/555 (1987)
ISO 8677/-
NEN 303/697
ASME B18.5.2.3M/-
NF - / E25-402
BS 4933/-

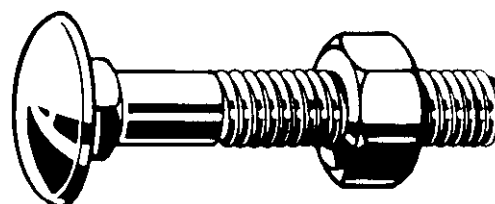

Informacje techniczne

d	b (min.): L≤125mm	b (min.): 125mm<L≤200mm	b (min.): L>200mm	dk (maks.)	f (maks.)	k (maks.)	m	P	s	v (maks.)
M5	16	22	-	13.55	4.1	3.3	4	0.8	8	5.48
M6	18	24	-	16.55	4.6	3.88	5	1	10	6.48
M8	22	28	41	20.65	5.6	4.88	6.5	1.25	13	8.58
M10	26	32	45	24.65	6.6	5.38	8	1.5	17	10.58
M12	30	36	49	30.65	8.75	6.95	10	1.75	19	12.7
M16	38	44	57	38.8	12.9	8.95	13	2	24	16.7

* Wymiar 'b' jest wartością orientacyjną, zależy od długości całkowitej

Grupy katalogowe

Gwint	Materiał	Klasa	Obróbka powierzchni	Kod	Strona
M	St	≥4.6	O cynk.	08250	1-75
M	St	≥4.6	O cynk gor.	08420	1-76

08250 Śruby z łbem grzybkowym z podsadzeniem z nakrętką sześciokątną		E05A
Gwint	Metryczny	
Materiał	Stal	
Klasa	≥4.6	
Obróbka powierzchni	O cynkowane	

d x L	☒	Kod artykułu	d x L	☒	Kod artykułu	d x L	☒	Kod artykułu
M5X16	500	08250.050.016	M5X45	200	08250.050.045	M6X16	200	08250.060.016
M5X20	500	08250.050.020	M5X50	200	08250.050.050	M6X20	200	08250.060.020
M5X25	500	08250.050.025	M5X60	200	08250.050.060	M6X25	200	08250.060.025
M5X30	500	08250.050.030	M5X65	200	08250.050.065	M6X30	200	08250.060.030
M5X35	200	08250.050.035	M5X70	200	08250.050.070	M6X35	200	08250.060.035
M5X40	200	08250.050.040	M5X80	200	08250.050.080			

08250 Śruby z łbem grzybkowym z podsadzeniem z nakrętką sześciokątną ←								
d x L	☒	Kod artykułu	d x L	☒	Kod artykułu	d x L	☒	Kod artykułu
M6X40	200	08250.060.040	M10X30	200	08250.100.030	M12X140	50	08250.120.140
M6X45	200	08250.060.045	M10X35	100	08250.100.035	M12X150	50	08250.120.150
M6X50	200	08250.060.050	M10X40	100	08250.100.040	M12X160	25	08250.120.160
M6X55	200	08250.060.055	M10X45	100	08250.100.045	M12X170	25	08250.120.170
M6X60	200	08250.060.060	M10X50	100	08250.100.050	M12X180	25	08250.120.180
M6X65	200	08250.060.065	M10X55	100	08250.100.055	M12X190	25	08250.120.190
M6X70	200	08250.060.070	M10X60	100	08250.100.060	M12X200	25	08250.120.200
M6X75	200	08250.060.075	M10X65	100	08250.100.065	M12X220	25	08250.120.220
M6X80	200	08250.060.080	M10X70	100	08250.100.070	M12X240	25	08250.120.240
M6X90	100	08250.060.090	M10X75	100	08250.100.075	M12X250	25	08250.120.250
M6X100	100	08250.060.100	M10X80	100	08250.100.080	M12X260	25	08250.120.260
M6X110	100	08250.060.110	M10X90	100	08250.100.090	M12X280	25	08250.120.280
M6X120	100	08250.060.120	M10X100	100	08250.100.100	M12X300	25	08250.120.300
M6X130	100	08250.060.130	M10X110	50	08250.100.110	M12X320	10	08250.120.320
M6X140	100	08250.060.140	M10X120	50	08250.100.120	M12X340	10	08250.120.340
M6X150	100	08250.060.150	M10X130	50	08250.100.130	M12X360	10	08250.120.360
			M10X140	50	08250.100.140	M12X380	10	08250.120.380
M8X16	200	08250.080.016	M10X150	50	08250.100.150	M12X400	10	08250.120.400
M8X20	200	08250.080.020	M10X160	50	08250.100.160			
M8X25	200	08250.080.025	M10X170	50	08250.100.170	M16X50	50	08250.160.050
M8X30	200	08250.080.030	M10X180	50	08250.100.180	M16X60	50	08250.160.060
M8X35	200	08250.080.035	M10X190	50	08250.100.190	M16X70	25	08250.160.070
M8X40	200	08250.080.040	M10X200	50	08250.100.200	M16X80	25	08250.160.080
M8X45	200	08250.080.045	M10X220	25	08250.100.220	M16X90	25	08250.160.090
M8X50	200	08250.080.050	M10X240	25	08250.100.240	M16X100	25	08250.160.100
M8X55	200	08250.080.055	M10X260	25	08250.100.260	M16X110	25	08250.160.110
M8X60	200	08250.080.060	M10X280	25	08250.100.280	M16X120	25	08250.160.120
M8X65	200	08250.080.065	M10X300	25	08250.100.300	M16X130	25	08250.160.130
M8X70	200	08250.080.070				M16X140	25	08250.160.140
M8X75	200	08250.080.075	M12X30	100	08250.120.030	M16X160	25	08250.160.160
M8X80	200	08250.080.080	M12X35	100	08250.120.035	M16X170	25	08250.160.170
M8X90	100	08250.080.090	M12X40	100	08250.120.040	M16X180	25	08250.160.180
M8X100	100	08250.080.100	M12X45	100	08250.120.045	M16X200	10	08250.160.200
M8X110	100	08250.080.110	M12X50	100	08250.120.050	M16X220	10	08250.160.220
M8X120	100	08250.080.120	M12X55	100	08250.120.055	M16X240	10	08250.160.240
M8X130	100	08250.080.130	M12X60	100	08250.120.060	M16X260	10	08250.160.260
M8X140	50	08250.080.140	M12X65	50	08250.120.065	M16X280	10	08250.160.280
M8X150	50	08250.080.150	M12X70	50	08250.120.070	M16X300	10	08250.160.300
M8X160	50	08250.080.160	M12X75	50	08250.120.075	M16X320	10	08250.160.320
M8X170	50	08250.080.170	M12X80	50	08250.120.080	M16X340	10	08250.160.340
M8X180	50	08250.080.180	M12X90	50	08250.120.090	M16X360	10	08250.160.360
M8X200	50	08250.080.200	M12X100	50	08250.120.100	M16X380	10	08250.160.380
			M12X110	50	08250.120.110	M16X400	10	08250.160.400
M10X20	200	08250.100.020	M12X120	50	08250.120.120			
M10X25	200	08250.100.025	M12X130	50	08250.120.130			

08420 Śruby z łbem grzybkowym z podsadzeniem, nakrętką sześciokątną i gwintem nadwymiarowym				A08A
Gwint	Metryczny			
Materiał	Stal			
Klasa	≥4.6			
Obróbka powierzchni	Ocynkowane na gorąco			

d x L	☒	Kod artykułu	d x L	☒	Kod artykułu	d x L	☒	Kod artykułu
M8X50	200	08420.080.050	M10X160	50	08420.100.160	M12X220	25	08420.120.220
M8X60	200	08420.080.060	M10X170	50	08420.100.170	M12X240	25	08420.120.240
M8X70	200	08420.080.070	M10X180	50	08420.100.180	M12X260	25	08420.120.260
M8X80	100	08420.080.080	M10X200	50	08420.100.200	M12X280	25	08420.120.280
M8X90	100	08420.080.090	M10X220	25	08420.100.220	M12X300	25	08420.120.300
M8X100	100	08420.080.100	M10X240	25	08420.100.240	M12X320	10	08420.120.320
M8X110	100	08420.080.110	M10X280	25	08420.100.280	M12X340	10	08420.120.340
M8X120	100	08420.080.120	M10X300	25	08420.100.300	M12X360	10	08420.120.360
M8X130	100	08420.080.130				M12X400	10	08420.120.400
M8X140	50	08420.080.140	M12X60	50	08420.120.060			
M8X160	50	08420.080.160	M12X70	50	08420.120.070	M16X90	25	08420.160.090
M8X180	50	08420.080.180	M12X80	50	08420.120.080	M16X100	25	08420.160.100
			M12X90	50	08420.120.090	M16X120	25	08420.160.120
M10X50	100	08420.100.050	M12X100	50	08420.120.100	M16X130	25	08420.160.130
M10X60	100	08420.100.060	M12X110	50	08420.120.110	M16X140	25	08420.160.140
M10X70	100	08420.100.070	M12X120	50	08420.120.120	M16X150	25	08420.160.150
M10X80	100	08420.100.080	M12X130	50	08420.120.130	M16X160	25	08420.160.160
M10X90	100	08420.100.090	M12X140	50	08420.120.140	M16X180	25	08420.160.180
M10X100	100	08420.100.100	M12X150	50	08420.120.150	M16X200	10	08420.160.200
M10X110	50	08420.100.110	M12X160	25	08420.120.160	M16X220	10	08420.160.220
M10X120	50	08420.100.120	M12X170	25	08420.120.170	M16X240	10	08420.160.240
M10X130	50	08420.100.130	M12X180	25	08420.120.180	M16X260	10	08420.160.260
M10X140	50	08420.100.140	M12X200	25	08420.120.200	M16X280	10	08420.160.280
M10X150	50	08420.100.150						

08420 Śruby z łbem grzybkowym z podsadzeniem, nakrętką sześciokątną i gwintem nadwymiarowym

- Dla śrub cynkowanych na gorąco z gwintem NADWYMIAROWYM, warstwa cynku nałożona jest na normalny gwint tak, że po cynkowaniu śruby te nie są już izometryczne i pasujące, ale grubsze: tak zwane NADWYMIAROWE.
- Nie pasują do normalnych gwintów i nie mogą być zastosowane w np. normalnie nagwintowanych otworach.
- Odpowiadające im nakrętki NADWYMIAROWE zostały nagwintowane o gwint nadwymiarowy wg ISO 965-5 tak aby idealnie pasowały do śrub po cynkowaniu.

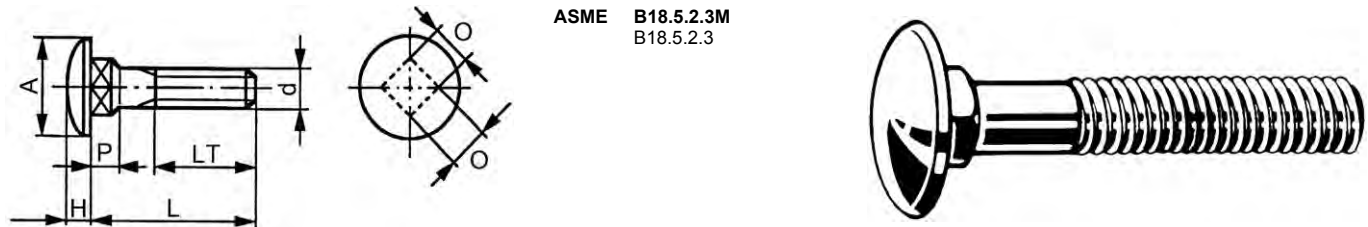
Śruby z łbem grzybkowym i podsadzeniem UNC

 ASME B18.5.2.3M
 B18.5.2.3

Informacje techniczne

d	A (maks.)	H (maks.)	L _T (min.): L≤6 Inch	L _T (min.): L>6 Inch	O (maks.)	P (maks.)	Zwoje gwintu na cal
1/4	0.594	0.145	0.750	1.000	0.260	0.156	20
5/16	0.719	0.176	0.875	1.125	0.324	0.187	18
3/8	0.844	0.208	1.000	1.250	0.388	0.219	16
7/16	0.969	0.239	1.125	1.375	0.452	0.250	14
1/2	1.094	0.270	1.250	1.500	0.515	0.281	13
5/8	1.344	0.344	1.500	1.750	0.642	0.344	11
3/4	1.594	0.406	1.750	2.000	0.768	0.406	10

Grupy katalogowe

Gwint	Material	Klasa	Obróbka powierzchni	Kod	Strona
UNC	St	Grade 2		U08300	1-77
UNC	St	Grade 2	Ocynk.	U08305	1-78
UNC	St	Grade 2	Ocynk. gor.	U08307	1-78
UNC	St	Grade 5	Ocynk.	U08320	1-78
UNC	St.St. A2 (AISI304/18-8)			U51500	1-79

U08300 Śruby z łbem grzybkowym i podsadzeniem UNC

X09A

Gwint Calowy, zunifikowany grubozwojny (UNC)
Material Stal
Klasa Grade 2



d x L	☒	Kod artykułu	d x L	☒	Kod artykułu	d x L	☒	Kod artykułu
1/4-20X1/2*	100	U08300.025.0050	5/16-18X6 Inch*	50	U08300.031.0600	1/2-13X2.1/2*	25	U08300.050.0250
1/4-20X3/4*	100	U08300.025.0075				1/2-13X3 Inch*	25	U08300.050.0300
1/4-20X1 Inch*	100	U08300.025.0100	3/8-16X1 Inch*	100	U08300.037.0100	1/2-13X3.1/2*	25	U08300.050.0350
1/4-20X1.1/4*	100	U08300.025.0125	3/8-16X1.1/2*	100	U08300.037.0150	1/2-13X4 Inch*	10	U08300.050.0400
1/4-20X1.1/2*	100	U08300.025.0150	3/8-16X2 Inch*	50	U08300.037.0200	1/2-13X5 Inch*	10	U08300.050.0500
1/4-20X2 Inch*	100	U08300.025.0200	3/8-16X2.1/2*	50	U08300.037.0250	1/2-13X6 Inch*	10	U08300.050.0600
1/4-20X2.1/2*	100	U08300.025.0250	3/8-16X3 Inch*	25	U08300.037.0300			
1/4-20X3 Inch*	50	U08300.025.0300	3/8-16X3.1/2*	25	U08300.037.0350	5/8-11X2 Inch*	10	U08300.062.0200
1/4-20X3.1/2*	50	U08300.025.0350	3/8-16X4 Inch*	25	U08300.037.0400	5/8-11X2.1/4*	10	U08300.062.0225
1/4-20X4 Inch*	50	U08300.025.0400	3/8-16X4.1/2*	10	U08300.037.0450	5/8-11X2.1/2*	10	U08300.062.0250
1/4-20X4.1/2*	50	U08300.025.0450	3/8-16X5 Inch*	10	U08300.037.0500	5/8-11X3 Inch*	10	U08300.062.0300
1/4-20X5 Inch*	50	U08300.025.0500	3/8-16X6 Inch*	10	U08300.037.0600	5/8-11X3.1/2*	10	U08300.062.0350
			3/8-16X6.1/2*	10	U08300.037.0650	5/8-11X4 Inch*	10	U08300.062.0400
5/16-18X1 Inch*	100	U08300.031.0100	3/8-16X7 Inch*	10	U08300.037.0700	5/8-11X5 Inch*	10	U08300.062.0500
5/16-18X1.1/4*	100	U08300.031.0125				5/8-11X6 Inch*	10	U08300.062.0600
5/16-18X1.1/2*	100	U08300.031.0150	7/16-14X1.1/4*	50	U08300.043.0125			
5/16-18X2 Inch*	100	U08300.031.0200	7/16-14X1.1/2*	50	U08300.043.0150	3/4-10X2 Inch*	10	U08300.075.0200
5/16-18X2.1/2*	100	U08300.031.0250	7/16-14X2 Inch*	50	U08300.043.0200	3/4-10X3 Inch*	10	U08300.075.0300
5/16-18X3 Inch*	50	U08300.031.0300	7/16-14X2.1/2*	25	U08300.043.0250	3/4-10X4 Inch*	10	U08300.075.0400
5/16-18X3.1/2*	50	U08300.031.0350				3/4-10X5 Inch*	10	U08300.075.0500
5/16-18X4 Inch*	50	U08300.031.0400	1/2-13X1.1/4*	50	U08300.050.0125	3/4-10X6 Inch*	10	U08300.075.0600
5/16-18X4.1/2*	50	U08300.031.0450	1/2-13X1.1/2*	50	U08300.050.0150	3/4-10X7 Inch*	5	U08300.075.0700
5/16-18X5 Inch*	50	U08300.031.0500	1/2-13X1.3/4*	25	U08300.050.0175	3/4-10X8 Inch*	5	U08300.075.0800
5/16-18X5.1/2*	50	U08300.031.0550	1/2-13X2 Inch*	25	U08300.050.0200			

U08305 Śruby z łbem grzybkowym i podsadzeniem UNC		X09A
Gwint	Całowy, zunifikowany grubozwojny (UNC)	 
Materiał	Stal	
Klasa	Grade 2	
Obróbka powierzchni	Ocynkowane	

d x L	☒	Kod artykułu	d x L	☒	Kod artykułu	d x L	☒	Kod artykułu
1/4-20X1/2*	100	U08305.025.0050	5/16-18X5.1/2*	50	U08305.031.0550	1/2-13X1.3/4*	25	U08305.050.0175
1/4-20X5/8*	100	U08305.025.0062	5/16-18X6 Inch*	50	U08305.031.0600	1/2-13X2 Inch*	25	U08305.050.0200
1/4-20X3/4*	100	U08305.025.0075				1/2-13X2.1/4*	25	U08305.050.0225
1/4-20X1 Inch*	100	U08305.025.0100	3/8-16X3/4*	100	U08305.037.0075	1/2-13X2.1/2*	25	U08305.050.0250
1/4-20X1.1/4*	100	U08305.025.0125	3/8-16X1 Inch*	100	U08305.037.0100	1/2-13X2.3/4*	25	U08305.050.0275
1/4-20X1.1/2*	100	U08305.025.0150	3/8-16X1.1/4*	100	U08305.037.0125	1/2-13X3 Inch*	25	U08305.050.0300
1/4-20X1.3/4*	100	U08305.025.0175	3/8-16X1.1/2*	100	U08305.037.0150	1/2-13X3.1/2*	25	U08305.050.0350
1/4-20X2 Inch*	100	U08305.025.0200	3/8-16X1.3/4*	100	U08305.037.0175	1/2-13X4 Inch*	10	U08305.050.0400
1/4-20X2.1/4*	100	U08305.025.0225	3/8-16X2 Inch*	50	U08305.037.0200	1/2-13X5 Inch*	10	U08305.050.0500
1/4-20X2.1/2*	100	U08305.025.0250	3/8-16X2.1/4*	50	U08305.037.0225	1/2-13X6 Inch*	10	U08305.050.0600
1/4-20X2.3/4*	100	U08305.025.0275	3/8-16X2.1/2*	50	U08305.037.0250	1/2-13X8 Inch*	10	U08305.050.0800
1/4-20X3 Inch*	50	U08305.025.0300	3/8-16X2.3/4*	50	U08305.037.0275	1/2-13X9 Inch*	10	U08305.050.0900
1/4-20X3.1/2*	50	U08305.025.0350	3/8-16X3 Inch*	25	U08305.037.0300	1/2-13X10 Inch*	10	U08305.050.1000
1/4-20X4 Inch*	50	U08305.025.0400	3/8-16X3.1/2*	25	U08305.037.0350			
1/4-20X4.1/2*	50	U08305.025.0450	3/8-16X4 Inch*	25	U08305.037.0400	5/8-11X1.1/2*	10	U08305.062.0150
1/4-20X5 Inch*	50	U08305.025.0500	3/8-16X4.1/2*	10	U08305.037.0450	5/8-11X2 Inch*	10	U08305.062.0200
			3/8-16X5 Inch*	10	U08305.037.0500	5/8-11X2.1/2*	10	U08305.062.0250
5/16-18X3/4*	100	U08305.031.0075	3/8-16X5.1/2*	10	U08305.037.0550	5/8-11X3 Inch*	10	U08305.062.0300
5/16-18X1 Inch*	100	U08305.031.0100	3/8-16X6 Inch*	10	U08305.037.0600	5/8-11X3.1/2*	10	U08305.062.0350
5/16-18X1.1/4*	100	U08305.031.0125	3/8-16X7 Inch*	10	U08305.037.0700	5/8-11X4 Inch*	10	U08305.062.0400
5/16-18X1.1/2*	100	U08305.031.0150	3/8-16X8 Inch*	10	U08305.037.0800	5/8-11X4.1/2*	10	U08305.062.0450
5/16-18X1.3/4*	100	U08305.031.0175				5/8-11X5 Inch*	10	U08305.062.0500
5/16-18X2 Inch*	100	U08305.031.0200	7/16-14X1 Inch*	50	U08305.043.0100	5/8-11X6 Inch*	10	U08305.062.0600
5/16-18X2.1/4*	100	U08305.031.0225	7/16-14X2 Inch*	50	U08305.043.0200			
5/16-18X2.1/2*	100	U08305.031.0250	7/16-14X3 Inch*	25	U08305.043.0300	3/4-10X2 Inch*	10	U08305.075.0200
5/16-18X2.3/4*	50	U08305.031.0275	7/16-14X4 Inch*	10	U08305.043.0400	3/4-10X3 Inch*	10	U08305.075.0300
5/16-18X3 Inch*	50	U08305.031.0300	7/16-14X4.1/2*	10	U08305.043.0450	3/4-10X4 Inch*	10	U08305.075.0400
5/16-18X3.1/2*	50	U08305.031.0350				3/4-10X5 Inch*	10	U08305.075.0500
5/16-18X4 Inch*	50	U08305.031.0400	1/2-13X1 Inch*	50	U08305.050.0100	3/4-10X6 Inch*	10	U08305.075.0600
5/16-18X4.1/2*	50	U08305.031.0450	1/2-13X1.1/4*	50	U08305.050.0125	3/4-10X7 Inch*	5	U08305.075.0700
5/16-18X5 Inch*	50	U08305.031.0500	1/2-13X1.1/2*	50	U08305.050.0150	3/4-10X8 Inch*	5	U08305.075.0800

U08307 Śruby z łbem grzybkowym i podsadzeniem UNC		X09A
Gwint	Całowy, zunifikowany grubozwojny (UNC)	 
Materiał	Stal	
Klasa	Grade 2	
Obróbka powierzchni	Ocynkowane na gorąco	

d x L	☒	Kod artykułu	d x L	☒	Kod artykułu	d x L	☒	Kod artykułu
1/4-20X1 Inch*	100	U08307.025.0100	5/16-18X3 Inch*	50	U08307.031.0300	1/2-13X1.1/2*	50	U08307.050.0150
1/4-20X1.1/4*	100	U08307.025.0125	5/16-18X3.1/2*	50	U08307.031.0350	1/2-13X2 Inch*	25	U08307.050.0200
1/4-20X1.1/2*	100	U08307.025.0150	5/16-18X4 Inch*	50	U08307.031.0400	1/2-13X2.1/2*	25	U08307.050.0250
1/4-20X2 Inch*	100	U08307.025.0200	5/16-18X5 Inch*	50	U08307.031.0500	1/2-13X3 Inch*	25	U08307.050.0300
1/4-20X2.1/2*	100	U08307.025.0250				1/2-13X3.1/2*	25	U08307.050.0350
1/4-20X3 Inch*	50	U08307.025.0300	3/8-16X1 Inch*	100	U08307.037.0100	1/2-13X4 Inch*	10	U08307.050.0400
1/4-20X3.1/2*	50	U08307.025.0350	3/8-16X1.1/4*	100	U08307.037.0125	1/2-13X5 Inch*	10	U08307.050.0500
1/4-20X4 Inch*	50	U08307.025.0400	3/8-16X1.1/2*	100	U08307.037.0150	1/2-13X6 Inch*	10	U08307.050.0600
1/4-20X5 Inch*	50	U08307.025.0500	3/8-16X2 Inch*	50	U08307.037.0200			
			3/8-16X2.1/2*	50	U08307.037.0250	5/8-11X2 Inch*	10	U08307.062.0200
5/16-18X1 Inch*	100	U08307.031.0100	3/8-16X3 Inch*	25	U08307.037.0300	5/8-11X2.1/2*	10	U08307.062.0250
5/16-18X1.1/4*	100	U08307.031.0125	3/8-16X3.1/2*	25	U08307.037.0350	5/8-11X3 Inch*	10	U08307.062.0300
5/16-18X1.1/2*	100	U08307.031.0150	3/8-16X4 Inch*	25	U08307.037.0400	5/8-11X4 Inch*	10	U08307.062.0400
5/16-18X2 Inch*	100	U08307.031.0200	3/8-16X5 Inch*	10	U08307.037.0500	5/8-11X5 Inch*	10	U08307.062.0500
5/16-18X2.1/2*	100	U08307.031.0250	3/8-16X6 Inch*	10	U08307.037.0600			

U08320 Śruby z łbem grzybkowym i podsadzeniem UNC		X09A
Gwint	Całowy, zunifikowany grubozwojny (UNC)	 
Materiał	Stal	
Klasa	Grade 5	
Obróbka powierzchni	Ocynkowane	

d x L	☒	Kod artykułu	d x L	☒	Kod artykułu	d x L	☒	Kod artykułu
1/4-20X3/4*	100	U08320.025.0075	1/4-20X2.1/2*	100	U08320.025.0250	5/16-18X3/4*	100	U08320.031.0075
1/4-20X1 Inch*	100	U08320.025.0100	1/4-20X3 Inch*	50	U08320.025.0300	5/16-18X1 Inch*	100	U08320.031.0100
1/4-20X1.1/4*	100	U08320.025.0125	1/4-20X3.1/2*	50	U08320.025.0350	5/16-18X1.1/4*	100	U08320.031.0125
1/4-20X1.1/2*	100	U08320.025.0150	1/4-20X4 Inch*	50	U08320.025.0400	5/16-18X1.1/2*	100	U08320.031.0150
1/4-20X2 Inch*	100	U08320.025.0200	1/4-20X5 Inch*	50	U08320.025.0500			

U08320 Śruby z łbem grzybkowym i podsadzeniem UNC								
d x L	☒	Kod artykułu	d x L	☒	Kod artykułu	d x L	☒	Kod artykułu
5/16-18X2 Inch*	100	U08320.031.0200	3/8-16X3.1/2*	25	U08320.037.0350	1/2-13X6 Inch*	10	U08320.050.0600
5/16-18X2.1/2*	50	U08320.031.0250	3/8-16X4 Inch*	25	U08320.037.0400	5/8-11X2 Inch*	10	U08320.062.0200
5/16-18X3 Inch*	50	U08320.031.0300	3/8-16X5 Inch*	10	U08320.037.0500	5/8-11X2.1/2*	10	U08320.062.0250
5/16-18X4 Inch*	50	U08320.031.0400	3/8-16X6 Inch*	10	U08320.037.0600	5/8-11X3 Inch*	10	U08320.062.0300
5/16-18X5 Inch*	50	U08320.031.0500				5/8-11X3.1/2*	10	U08320.062.0350
3/8-16X3/4*	100	U08320.037.0075	1/2-13X1 Inch*	50	U08320.050.0100	5/8-11X4 Inch*	10	U08320.062.0400
3/8-16X1 Inch*	100	U08320.037.0100	1/2-13X1.1/4*	50	U08320.050.0125	5/8-11X5 Inch*	10	U08320.062.0500
3/8-16X1.1/4*	100	U08320.037.0125	1/2-13X1.1/2*	50	U08320.050.0150	5/8-11X6 Inch*	10	U08320.062.0600
3/8-16X1.3/4*	100	U08320.037.0150	1/2-13X1.3/4*	25	U08320.050.0175			
3/8-16X2 Inch*	50	U08320.037.0200	1/2-13X2 Inch*	25	U08320.050.0200	3/4-10X2 Inch*	10	U08320.075.0200
3/8-16X2.1/4*	50	U08320.037.0225	1/2-13X2.1/2*	25	U08320.050.0250	3/4-10X3 Inch*	10	U08320.075.0300
3/8-16X2.1/2*	50	U08320.037.0250	1/2-13X3 Inch*	25	U08320.050.0300	3/4-10X4 Inch*	10	U08320.075.0400
3/8-16X3 Inch*	25	U08320.037.0300	1/2-13X3.1/2*	10	U08320.050.0350	3/4-10X5 Inch*	10	U08320.075.0500
			1/2-13X4 Inch*	10	U08320.050.0400			
			1/2-13X5 Inch*	10	U08320.050.0500			

U51500 Śruby z łbem grzybkowym i podsadzeniem UNC		X15A
Gwint	Caliowy, zunifikowany grubozwojny (UNC)	
Material	Stal nierdzewna A2 (AISI 304/18-8)	

d x L	☒	Kod artykułu	d x L	☒	Kod artykułu	d x L	☒	Kod artykułu
1/4-20X1/2*	100	U51500.025.0050	5/16-18X1 Inch*	100	U51500.031.0100	3/8-16X3.1/2*	25	U51500.037.0350
1/4-20X5/8*	100	U51500.025.0062	5/16-18X1.1/4*	100	U51500.031.0125	3/8-16X4 Inch*	25	U51500.037.0400
1/4-20X3/4*	100	U51500.025.0075	5/16-18X1.1/2*	100	U51500.031.0150	3/8-16X4.1/2*	10	U51500.037.0450
1/4-20X1 Inch*	100	U51500.025.0100	5/16-18X1.3/4*	100	U51500.031.0175	3/8-16X5 Inch*	10	U51500.037.0500
1/4-20X1.1/4*	100	U51500.025.0125	5/16-18X2 Inch*	100	U51500.031.0200	3/8-16X6 Inch*	10	U51500.037.0600
1/4-20X1.1/2*	100	U51500.025.0150	5/16-18X2.1/4*	100	U51500.031.0225			
1/4-20X1.3/4*	100	U51500.025.0175	5/16-18X2.1/2*	50	U51500.031.0250	1/2-13X1.1/4*	50	U51500.050.0125
1/4-20X2 Inch*	100	U51500.025.0200	5/16-18X2 Inch*	50	U51500.031.0300	1/2-13X1.1/2*	50	U51500.050.0150
1/4-20X2.1/4*	100	U51500.025.0225	5/16-18X3.1/2*	50	U51500.031.0350	1/2-13X1.3/4*	25	U51500.050.0175
1/4-20X2.1/2*	100	U51500.025.0250	5/16-18X4 Inch*	50	U51500.031.0400	1/2-13X2 Inch*	25	U51500.050.0200
1/4-20X2.3/4*	100	U51500.025.0275				1/2-13X2.1/2*	25	U51500.050.0250
1/4-20X3 Inch*	50	U51500.025.0300	3/8-16X1 Inch*	100	U51500.037.0100	1/2-13X3 Inch*	25	U51500.050.0300
1/4-20X3.1/2*	50	U51500.025.0350	3/8-16X1.1/4*	100	U51500.037.0125	1/2-13X3.1/2*	10	U51500.050.0350
1/4-20X4 Inch*	50	U51500.025.0400	3/8-16X1.1/2*	100	U51500.037.0150	1/2-13X4 Inch*	10	U51500.050.0400
1/4-20X5 Inch*	50	U51500.025.0500	3/8-16X2 Inch*	50	U51500.037.0200	1/2-13X5 Inch*	10	U51500.050.0500
			3/8-16X2.1/2*	50	U51500.037.0250	1/2-13X6 Inch*	10	U51500.050.0600
5/16-18X3/4*	100	U51500.031.0075	3/8-16X3 Inch*	25	U51500.037.0300			

Śruby z łbem stożkowym płaskim i niskim podsadzeniem

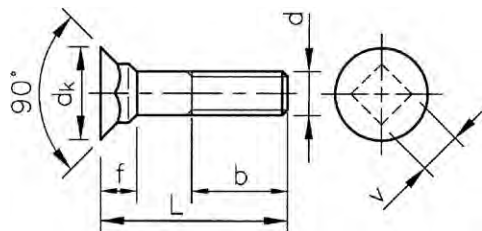

DIN ≈608
BS ≈4933



Informacje techniczne

d	b (min.)	dk (maks.)	f (maks.)	P	v (maks.)
M10	26	19.65	8.45	1.5	10.58
M12	30	24.65	11.05	1.75	12.7

01036 Śruby z łbem stożkowym płaskim i niskim podsadzeniem

A90A

Gwint Metryczny
Materiał Stal
Klasa 8.8



d x L	☒	Kod artykułu	d x L	☒	Kod artykułu	d x L	☒	Kod artykułu
M10X25	100	01036.100.025	M10X50	50	01036.100.050	M12X35	50	01036.120.035
M10X30	100	01036.100.030	M10X60	50	01036.100.060	M12X40	50	01036.120.040
M10X35	100	01036.100.035				M12X50	50	01036.120.050
M10X40	100	01036.100.040	M12X30	50	01036.120.030			

Śruby skrzydełkowe z łbem stożkowym płaskim z podsadzeniem i nakrętka 6-kątną

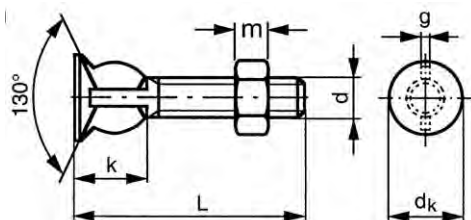

DIN - / 555 (1987)
NEN - / 697
NF - / E25-402

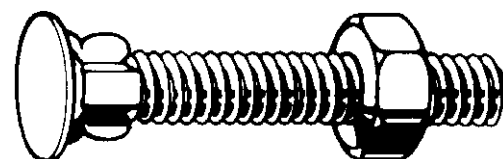

Informacje techniczne

d	dk	g	k	m	P	s
M6	11.5	1	8	5	1	10
M8	15	1.2	11.5	6.5	1.25	13

- Odpowiadające nakrętki sześciokątne mają klasę właściwości \geq I4I.

08260 SEHA Śruby skrzydełkowe z łbem stożkowym płaskim z podsadzeniem z nakrętką sześciokątną

E90A

Gwint Metryczny
Materiał Stal
Klasa \geq 4.6
Obróbka powierzchni O cynkowane

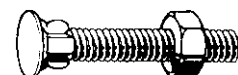

d x L	☒	Kod artykułu	d x L	☒	Kod artykułu	d x L	☒	Kod artykułu
M6X20	200	08260.060.020	M6X35	200	08260.060.035	M8X40	100	08260.080.040
M6X25	200	08260.060.025	M6X40	200	08260.060.040	M8X50	100	08260.080.050
M6X30	200	08260.060.030	M6X50	200	08260.060.050			

Śruby z łbem stożkowym płaskim z noskiem z nakrętką sześciokątną

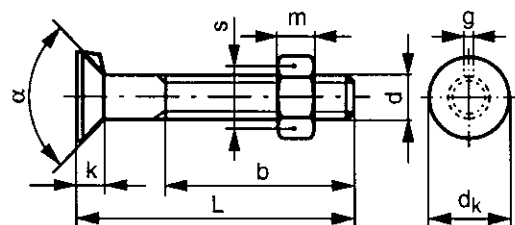

DIN 604/555 (1987)
 NEN 2355/697
 NF - / E25-402
 BS 4933/-

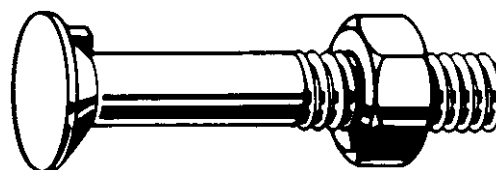

Informacje techniczne

d	b (min.): L≤125mm	b (min.): 125mm<L≤200mm	b (min.): L>200mm	dk (maks.)	g (maks.)	k	m	P	s	α (min.)
M10	26	32	45	19.65	3.2	5.5	8	1.5	17	90°
M12	30	36	49	24.65	3.6	7	10	1.75	19	90°
M16	38	44	57	32.8	4.2	9	13	2	24	90°
M20	46	52	65	32.8	5.4	11.5	16	2.5	30	60°
M24	54	60	73	38.8	6.6	13	19	3	36	60°

- Odpowiadające nakrętki sześciokątne mają klasę właściwości ≥ I4I.

08070 Śruby z łbem stożkowym płaskim z noskiem z nakrętką sześciokątną

E01B

Gwint Metryczny
 Materiał Stal
 Klasa ≥4.6

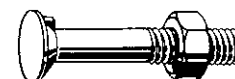

d x L	☒	Kod artykułu	d x L	☒	Kod artykułu	d x L	☒	Kod artykułu
M10X25	100	08070.100.025	M12X50	100	08070.120.050	M16X140	25	08070.160.140
M10X30	100	08070.100.030	M12X60	50	08070.120.060	M20X50	25	08070.200.050
M10X35	100	08070.100.035	M12X70	50	08070.120.070	M20X60	25	08070.200.060
M10X40	100	08070.100.040	M12X80	50	08070.120.080	M20X70	25	08070.200.070
M10X45	100	08070.100.045	M12X90	50	08070.120.090	M20X80	25	08070.200.080
M10X50	100	08070.100.050	M16X35	25	08070.160.035	M20X90	25	08070.200.090
M10X55	100	08070.100.055	M16X40	25	08070.160.040	M20X100	25	08070.200.100
M10X60	100	08070.100.060	M16X45	25	08070.160.045	M20X120	25	08070.200.120
M10X70	100	08070.100.070	M16X50	25	08070.160.050	M20X130	25	08070.200.130
M10X80	50	08070.100.080	M16X55	25	08070.160.055	M24X60	25	08070.240.060
M10X90	50	08070.100.090	M16X60	25	08070.160.060	M24X80	25	08070.240.080
M12X30	100	08070.120.030	M16X70	25	08070.160.070	M24X90	25	08070.240.090
M12X35	100	08070.120.035	M16X80	25	08070.160.080	M24X100	25	08070.240.100
M12X40	100	08070.120.040	M16X90	25	08070.160.090	M24X110	25	08070.240.110
M12X45	100	08070.120.045	M16X100	25	08070.160.100			

Śruby z łbem stożkowym płaskim z podsadzeniem z nakrętką sześciokątną

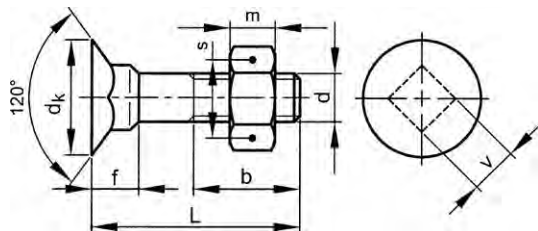

DIN 605/555 (1987)
NF - / E25-402
BS 4933/-

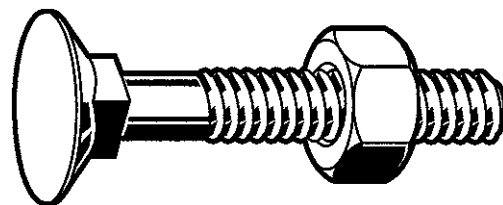

Informacje techniczne

d	b (min.)	d _k (maks.)	f (maks.)	m	P	s	v (maks.)
M6	18	16.55	7.45	5	1	10	6.48
M8	22	20.65	9.45	6.5	1.25	13	8.58
M10	26	24.65	11.55	8	1.5	17	10.58

- Odpowiadające nakrętki sześciokątne mają klasę właściwości ≥ I4I.

08206 Śruby z łbem stożkowym płaskim z podsadzeniem z nakrętką sześciokątną

E03B

Gwint Metryczny
Materiał Stal
Klasa 4.6
Obróbka powierzchni O cynkowane

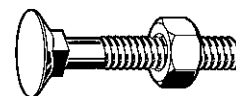

d x L	☒	Kod artykułu	d x L	☒	Kod artykułu	d x L	☒	Kod artykułu
M6X30	200	08206.060.030	M8X30	200	08206.080.030	M10X40	100	08206.100.040
M6X35	200	08206.060.035	M8X35	200	08206.080.035	M10X50	100	08206.100.050
M6X40	200	08206.060.040	M8X40	200	08206.080.040	M10X60	100	08206.100.060
M6X50	200	08206.060.050	M8X50	200	08206.080.050			
			M8X60	200	08206.080.060			

Śruby talerzowe (do pasów)

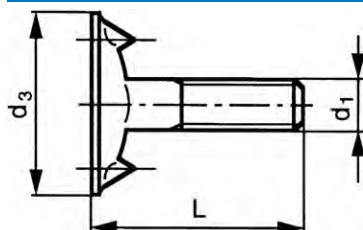

DIN 15237

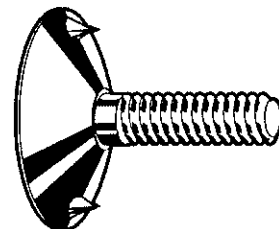

Informacje techniczne

d ₁	d ₃	P
M8	28	1.25
M10	35	1.5

- Zastosowanie do mocowania pasów transmisyjnych
- Krzywki pod łbem stożkowym osadzają mocno śrubę talerzową, podczas gdy podkładka wydrążona pod pasem wzmacnia połączenie.

Grupy katalogowe

Gwint	Materiał	Kod	Strona
M	St.St. A2	51505	1-82
M	St.St. A4	55505	1-83

51505 Śruby talerzowe (do pasów)

R03A

Gwint Metryczny
Materiał Stal nierdzewna A2

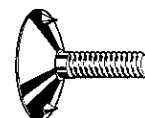

d ₁ x L	☒	Kod artykułu	d ₁ x L	☒	Kod artykułu	d ₁ x L	☒	Kod artykułu
M8X25	10	51505.080.025	M10X30	5	51505.100.030	M10X40	5	51505.100.040
M8X30	10	51505.080.030	M10X35	5	51505.100.035	M10X50	5	51505.100.050
M8X35	10	51505.080.035						

55505 Śruby talerzowe (do pasów)				R43A	
Gwint	Metryczny				
Materiał	Stal nierdzewna A4				
d₁ x L	✉	Kod artykułu	d₁ x L	✉	Kod artykułu
M8X25	10	55505.080.025			M10X50 5 55505.100.050

Podkładki wklęsłe do śrub talerzowych

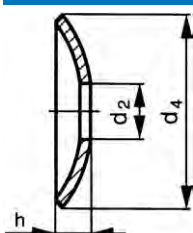

DIN 15237



Informacje techniczne

Dla wymiaru nominalnego	d ₂	d ₄	h ≈
M8	9.5	32	5.7
M10	11.5	40	7

- Nadaje się do zamocowania wałków pasów przenośników taśmowych.

Grupy katalogowe

Materiał	Kod	Strona
St.St. A2	51506	1-83
St.St. A4	55506	1-83

51506 Podkładki wklęsłe do śrub talerzowych				R09A	
Materiał	Stal nierdzewna A2				
Dla wymiaru nominalnego	✉	Kod artykułu	Dla wymiaru nominalnego	✉	Kod artykułu
M8	10	51506.080.001	M10	5	51506.100.001

55506 Podkładki wklęsłe do śrub talerzowych				R49A	
Materiał	Stal nierdzewna A4				
Dla wymiaru nominalnego	✉	Kod artykułu			
M8	10	55506.080.001			

Śruby z łbem kwadratowym z krótkim czopem walcowym

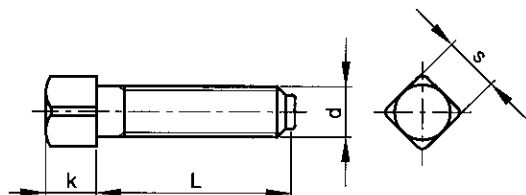

DIN 479
NF E25-134

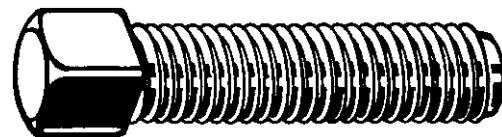

Informacje techniczne

d	k	P	s	d	k	P	s
M6	6	1	6	M16	16	2	17
M8	8	1.25	8	M20	20	2.5	22
M10	10	1.5	10	M24	22	3	24
M12	12	1.75	13				

01030 Śruby z łbem kwadratowym z krótkim czopem walcowym

A90A

Gwint Metryczny
Materiał Stal
Klasa 8.8



d x L	☒	Kod artykułu	d x L	☒	Kod artykułu	d x L	☒	Kod artykułu
M6X16	200	01030.060.016	M10X40	100	01030.100.040	M16X50	50	01030.160.050
M6X20	200	01030.060.020	M10X45	100	01030.100.045	M16X60	50	01030.160.060
M6X25	200	01030.060.025	M10X50	100	01030.100.050	M16X70	50	01030.160.070
M6X30	200	01030.060.030	M10X60	100	01030.100.060	M16X80	25	01030.160.080
M6X35	200	01030.060.035	M10X70	100	01030.100.070	M16X90	25	01030.160.090
M6X40	200	01030.060.040	M10X80	50	01030.100.080	M16X100	25	01030.160.100
M6X50	200	01030.060.050	M10X100	50	01030.100.100	M16X120	25	01030.160.120
M8X16	200	01030.080.016	M12X20	200	01030.120.020	M20X50	25	01030.200.050
M8X20	200	01030.080.020	M12X25	100	01030.120.025	M20X60	25	01030.200.060
M8X25	200	01030.080.025	M12X30	100	01030.120.030	M20X70	25	01030.200.070
M8X30	200	01030.080.030	M12X35	100	01030.120.035	M20X80	25	01030.200.080
M8X35	200	01030.080.035	M12X40	100	01030.120.040	M20X90	25	01030.200.090
M8X40	200	01030.080.040	M12X50	50	01030.120.050	M20X100	25	01030.200.100
M8X50	200	01030.080.050	M12X60	50	01030.120.060	M20X120	25	01030.200.120
M8X60	100	01030.080.060	M12X70	50	01030.120.070			
			M12X80	50	01030.120.080	M24X70	25	01030.240.070
M10X16	200	01030.100.016	M12X90	50	01030.120.090	M24X80	25	01030.240.080
M10X20	200	01030.100.020	M12X100	50	01030.120.100	M24X90	10	01030.240.090
M10X25	200	01030.100.025				M24X100	10	01030.240.100
M10X30	200	01030.100.030	M16X40	50	01030.160.040	M24X120	10	01030.240.120
M10X35	200	01030.100.035	M16X45	50	01030.160.045	M24X140	50	01030.240.140

Śruby z łbem kwadratowym UNC

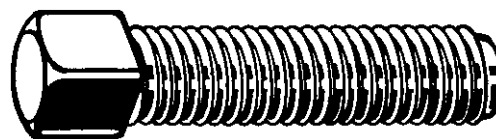
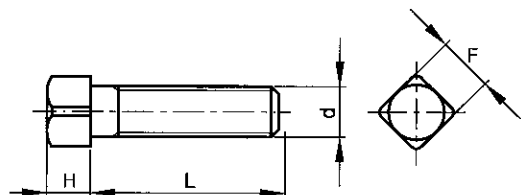

Informacje techniczne

d	F (max.)	H (max.)	Zwoje gwintu na cal
1/4	0.250	0.196	20
5/16	0.312	0.245	18
3/8	0.375	0.293	16
7/16	0.438	0.341	14
1/2	0.500	0.389	13
5/8	0.625	0.485	11
3/4	0.750	0.582	10
7/8	0.875	0.678	9
1 Inch	1.000	0.774	8

U01080 Śruby z łbem kwadratowym UNC

X09A

Gwint: Całowy, zunifikowany grubozwojny (UNC)
 Material: Stal



d x L	☒	Kod artykułu	d x L	☒	Kod artykułu	d x L	☒	Kod artykułu
1/4-20X3/8*	100	U01080.025.0037	3/8-16X2.1/2*	25	U01080.037.0250	5/8-11X2.1/2*	10	U01080.062.0250
1/4-20X1/2*	100	U01080.025.0050	3/8-16X3 Inch*	15	U01080.037.0300	5/8-11X3 Inch*	5	U01080.062.0300
1/4-20X5/8*	100	U01080.025.0062	3/8-16X3.1/2*	10	U01080.037.0350	5/8-11X3.1/2*	5	U01080.062.0350
1/4-20X3/4*	100	U01080.025.0075	3/8-16X4 Inch*	10	U01080.037.0400	5/8-11X4 Inch*	5	U01080.062.0400
1/4-20X7/8*	100	U01080.025.0087				5/8-11X5 Inch*	5	U01080.062.0500
1/4-20X1 Inch*	100	U01080.025.0100	7/16-14X3/4*	50	U01080.043.0075	5/8-11X6 Inch*	5	U01080.062.0600
1/4-20X1.1/4*	100	U01080.025.0125	7/16-14X1 Inch*	50	U01080.043.0100			
1/4-20X1.1/2*	100	U01080.025.0150	7/16-14X1.1/4*	25	U01080.043.0125	3/4-10X1 Inch*	5	U01080.075.0100
1/4-20X1.3/4*	100	U01080.025.0175	7/16-14X1.1/2*	25	U01080.043.0150	3/4-10X1.1/4*	5	U01080.075.0125
1/4-20X2 Inch*	100	U01080.025.0200	7/16-14X2 Inch*	25	U01080.043.0200	3/4-10X1.1/2*	5	U01080.075.0150
1/4-20X2.1/2*	50	U01080.025.0250				3/4-10X2 Inch*	5	U01080.075.0200
			1/2-13X3/4*	25	U01080.050.0075	3/4-10X2.1/2*	5	U01080.075.0250
5/16-18X1/2*	100	U01080.031.0050	1/2-13X7/8*	25	U01080.050.0087	3/4-10X3 Inch*	5	U01080.075.0300
5/16-18X5/8*	100	U01080.031.0062	1/2-13X1 Inch*	25	U01080.050.0100	3/4-10X3.1/2*	5	U01080.075.0350
5/16-18X3/4*	100	U01080.031.0075	1/2-13X1.1/4*	25	U01080.050.0125	3/4-10X4 Inch*	5	U01080.075.0400
5/16-18X1 Inch*	100	U01080.031.0100	1/2-13X1.1/2*	25	U01080.050.0150	3/4-10X5 Inch*	5	U01080.075.0500
5/16-18X1.1/4*	100	U01080.031.0125	1/2-13X1.3/4*	25	U01080.050.0175	3/4-10X6 Inch*	5	U01080.075.0600
5/16-18X1.1/2*	100	U01080.031.0150	1/2-13X2 Inch*	10	U01080.050.0200			
5/16-18X1.3/4*	100	U01080.031.0175	1/2-13X2.1/2*	10	U01080.050.0250	7/8-9X2 Inch*	5	U01080.087.0200
5/16-18X2 Inch*	100	U01080.031.0200	1/2-13X3 Inch*	10	U01080.050.0300	7/8-9X3 Inch*	5	U01080.087.0300
5/16-18X2.1/2*	50	U01080.031.0250	1/2-13X3.1/2*	10	U01080.050.0350	7/8-9X4 Inch*	5	U01080.087.0400
			1/2-13X4 Inch*	10	U01080.050.0400	7/8-9X5 Inch*	5	U01080.087.0500
3/8-16X1/2*	100	U01080.037.0050	1/2-13X5 Inch*	5	U01080.050.0500	7/8-9X6 Inch*	5	U01080.087.0600
3/8-16X5/8*	100	U01080.037.0062	1/2-13X6 Inch*	5	U01080.050.0600			
3/8-16X3/4*	100	U01080.037.0075				1.-8X2.1/2*	1	U01080.100.0250
3/8-16X1 Inch*	100	U01080.037.0100	5/8-11X1 Inch*	10	U01080.062.0100	1.-8X3 Inch*	1	U01080.100.0300
3/8-16X1.1/4*	100	U01080.037.0125	5/8-11X1.1/4*	10	U01080.062.0125	1.-8X4 Inch*	1	U01080.100.0400
3/8-16X1.1/2*	50	U01080.037.0150	5/8-11X1.1/2*	10	U01080.062.0150	1.-8X5 Inch*	1	U01080.100.0500
3/8-16X1.3/4*	50	U01080.037.0175	5/8-11X1.3/4*	10	U01080.062.0175	1.-8X6 Inch*	1	U01080.100.0600
3/8-16X2 Inch*	25	U01080.037.0200	5/8-11X2 Inch*	10	U01080.062.0200			

Śruby dociskowe z łbem sześciokątnym z czopem walcowym

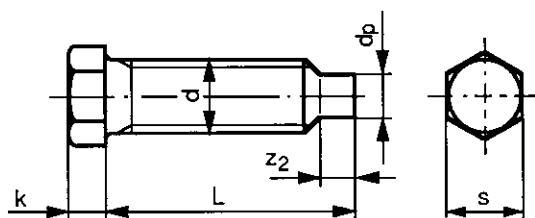

DIN 561
NF E25-133

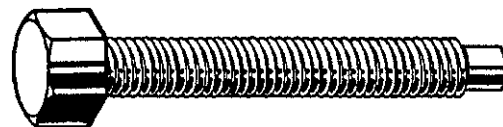

Informacje techniczne

d	d _p (maks.)	k	P	s	z ₂ (min.)
M6	4	5	1	8	3
M8	5.5	6	1.25	10	4
M10	7	7	1.5	13	5
M12	8.5	9	1.75	16	6
M16	12	11	2	18	8

01098 Śruby dociskowe z łbem sześciokątnym z czopem walcowym

A90A

Gwint Metryczny
Materiał Stal
Klasa 8.8

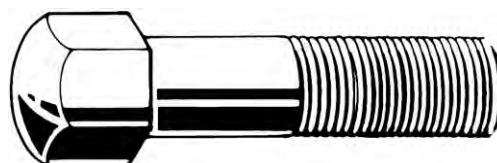
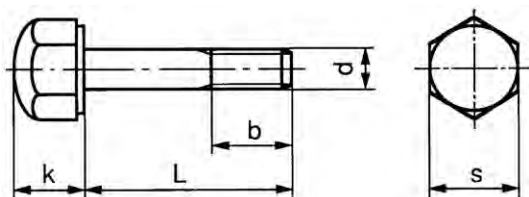

d x L	☒	Kod artykułu	d x L	☒	Kod artykułu	d x L	☒	Kod artykułu
M6X12	200	01098.060.012	M10X20	200	01098.100.020	M12X30	100	01098.120.030
M6X16	200	01098.060.016	M10X25	200	01098.100.025	M12X35	100	01098.120.035
M6X20	200	01098.060.020	M10X30	200	01098.100.030	M12X40	100	01098.120.040
M8X16	200	01098.080.016	M10X35	100	01098.100.035	M12X50	100	01098.120.050
M8X20	200	01098.080.020	M10X40	100	01098.100.040	M12X60	100	01098.120.060
M8X25	200	01098.080.025	M10X50	100	01098.100.050	M16X50	50	01098.160.050
M8X30	200	01098.080.030	M10X60	100	01098.100.060	M16X60	50	01098.160.060
M8X35	200	01098.080.035	M12X25	100	01098.120.025	M16X70	25	01098.160.070
M8X40	200	01098.080.040				M16X80	25	01098.160.080
M8X50	100	01098.080.050						

Caterpillar, UNF

Informacje techniczne

d	k	s	Zwoje gwintu na cal	d	k	s	Zwoje gwintu na cal
7/16	11	16	20	5/8	16	24	18
1/2	13	19	20	3/4	19	28	16
9/16	14	22	18	1 Inch-14G	24	38.1	14

- W celu znalezienia odpowiedniej nakrętki gąsienicowej przejdź do Sekcji 3.

06000 Caterpillar, UNF		Y90A
Gwint	Całowy, zunifikowany drobnozwojny (UNF)	 
Materiał	Stal	
Klasa	170	

d x L x b	☒	Kod artykułu	d x L x b	☒	Kod artykułu	d x L x b	☒	Kod artykułu
7/16X1.1/2X22MM	50	06000.111.038	9/16X1.15/16X28MM	50	06000.142.049	3/4X2.3/8X30MM	10	06000.191.060
1/2X1.1/2X19MM	50	06000.127.038	5/8X2 InchX28MM	25	06000.158.050	3/4X2.1/2X30MM	10	06000.191.063
1/2X2 InchX24MM	50	06000.127.050	5/8X2.1/4X27MM	25	06000.158.057	3/4X2.3/4X38MM	10	06000.191.069
9/16X1.5/8X26MM	50	06000.142.041	3/4X2.1/4X29MM	10	06000.191.057	1-14GX3 InchX35MM	10	06000.256.076

- 170 = minimalna wytrzymałość na rozciąganie 170.000 psi = 1200 N/mm².

1 PEINER – śruby konstrukcyjne o dużej wytrzymałości

Informacje ogólne

Od września 2007 r. producenci śrub, nakrętek i podkładek konstrukcyjnych o dużej wytrzymałości mają obowiązek wytwarzać wyroby zgodnie z europejską normą **EN 14399**. Dopuszczalne jest używanie i sprzedawanie wyrobów opartych na starszych normach DIN 6914, 6915 i 6916 (stare „zapasy DIN”), jednak nie mogą być łączone w zestawach (patrz „Zestawy”) z wyrobami spełniającymi wymogi nowej normy. Nowa norma nie wprowadza żadnych istotnych zmian odnośnie wymiarów (z wyjątkiem długości gwintu „b”, której maksymalna wartość jest taka jak w starej normie, a począwszy od M24, nawet nieco wyższa). Oprócz tego wymagane jest umieszczenie na opakowaniu znaku CE oraz przestrzeganie bardziej rygorystycznych instrukcji tworzenia zestawów śrubowych i monitorowania. Ponadto wartość próby wytrzymałościowej zmieniła się z $K_{v,min} = 20$ J na $K_{v,min} = 27$ J przy -20°C. Opisane w tym katalogu śruby, nakrętki i podkładki konstrukcyjne o dużej wytrzymałości PEINER 10.9 spełniają nowe normy.

Produkt	Stara norma	Nowa norma	Oznaczenie
Śruby HV	DIN 6914	→EN 14399-4	10.9 HV
Nakrętki HV	DIN 6915	→EN 14399-4	10 HV
Podkładki HV	DIN 6916	→EN 14399-6	H

Jakość

PEINER jest posiadającym certyfikat CE producentem śrub klasy 10.9 HV, nakrętek klasy 10 HV oraz podkładek (o twardości 300-370 HV) w rozmiarach M12-M36, zgodnych odpowiednio z normami EN 14399-4 – EN 14399-6. Artykuły te dostępne są w wersji czarnej, a także cynkowanej na gorąco. Śruby spełniają wszelkie wymagania dotyczące zapobiegania korozji wodorowej.

Zestawy

Norma wymaga, aby śruba, nakrętka i podkładka pochodziły od tego samego producenta. Norma EN 14399-2 określa metodę badania, jakie musi przejść zestaw śruba/nakrętka/podkładka. Ze względu na bardziej restrykcyjne instrukcje dotyczące tworzenia zestawów i podziału na klasy k, producent powinien zagwarantować wymaganą siłę napięcia wstępnego i brak przeciążenia, zgodnie z metodami przyjętymi w normie EN 1090-2.

W przypadku zestawów cynkowanych na gorąco, w klasie tarcia K1, wymagany jest ten sam moment dokręcania i siły napięcia wstępnego co odpowiednio w normach DIN 18800-7 (2002-09), tabela 6, kolumny 3 i 7 oraz EN 1993-1-8. W przypadku zestawów cynkowanych na gorąco tego samego producenta

można łączyć różne oddzielne elementy (zgodnie z normami DIN i EN). Jest to możliwe, ponieważ wartości momentu dokręcania pozostają niezmienione.

W przypadku zestawów innych niż cynkowane na gorąco obowiązują takie same momenty dokręcania jak dla elementów cynkowanych na gorąco, tam gdzie normy DIN 18800-7 (2002-09), tabela 6, kolumny 4 i 8 poprzednio przewidywały większe momenty dokręcania. Z uwagi na tę różnicę między momentami dokręcania, łączenie produktów zgodnych z normą DIN z produktami zgodnymi z PL-EN jest **niedozwolone**.

Śruby konstrukcyjne o dużej wytrzymałości Peiner, które spełniają nową normę EN, oferowane są w klasie tarcia K1.

Współczynnik k określa liniową zależność między momentem dokręcania (M) a siłą napięcia wstępnego uzyskaną dla danej średnicy.

Zależność ta wyrażana jest wzorem: $M = k \times F_v \times d$ (M [Nm], F_v [kN], d [mm])

Wyroby napięcia wstępnego PEINER (EN 14399-4 i 6) powinny spełniać wymogi klasy **K1**, gdzie $0,1 \leq k \leq 0,16$, bez względu na obróbkę powierzchni.

Na opakowaniu produktów wymienione są wytyczne dotyczące tworzenia zestawów śrubowych i klasy tarcia. Obróbka powierzchni stosowana przez producenta gwarantuje spełnienie tych wymagań. Dodatkowe smarowanie lub odtłuszczenie ma wpływ na wartość współczynnika k i jest niedozwolone. Jeśli chodzi o długość zacisku zestawu śruba/nakrętka/podkładka, obowiązuje nowa norma dotycząca grubości podkładek.

Certyfikaty

Śruby konstrukcyjne o dużej wytrzymałości PEINER dostępne są, na żądanie, z certyfikatem 3.1 zgodnym z normą EN 10204.



Śruby konstrukcyjne o dużej wytrzymałości

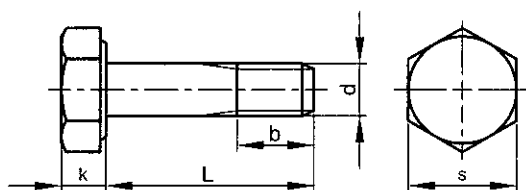

EN 14399-4

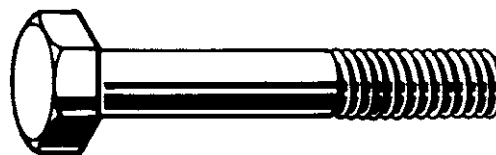

Informacje techniczne

d	b	k	P	s
M12	23	8	1.75	22
M16	28	10	2	27
M20	33	13	2.5	32
M22	34	14	2.5	36
M24	39	15	3	41
M27	41	17	3	46
M30	44	19	3.5	50
M36	52	23	4	60
M39	68	25	4	65
M42	74	26	4.5	70
M45	76	28	4.5	75
M48	82	30	5	80
M56	90	35	5.5	90
M64	100	40	6	100

- Śruby HV Peiner wraz z odpowiadającymi im nakrętkami i podkładkami HV, rozmiary M12 do M36 są określone w normie EN14399-4 oraz EN 14399-6. Średnice M39 do M72 są zdefiniowane w dyrektywie DASt 021.
- Śruby PEINER HV z dołączonymi nakrętkami HV oraz podkładkami HV mogą być używane tylko jako zestaw od jednego i tego samego dostawcy.

04210 PEINER Śruby konstrukcyjne o dużej wytrzymałości

C05A

Gwint: Metryczny
 Materiał: Stal
 Klasa: 10.9
 Obróbka powierzchni: Ocynkowane na gorąco



CE

d x L	☒	Kod artykułu	d x L	☒	Kod artykułu	d x L	☒	Kod artykułu
M12X30	100	04210.120.030	M16X150	25	04210.160.150	M20X230	15	04210.200.230
M12X35	100	04210.120.035	M16X160	25	04210.160.160	M20X240	15	04210.200.240
M12X40	100	04210.120.040	M16X170	25	04210.160.170	M20X250	15	04210.200.250
M12X45	100	04210.120.045	M16X180	25	04210.160.180	M20X260	15	04210.200.260
M12X50	100	04210.120.050	M16X190	25	04210.160.190			
M12X55	100	04210.120.055	M16X200	25	04210.160.200	M22X50	25	04210.220.050
M12X60	50	04210.120.060	M16X210	25	04210.160.210	M22X55	25	04210.220.055
M12X65	50	04210.120.065	M16X220	25	04210.160.220	M22X60	25	04210.220.060
M12X70	50	04210.120.070				M22X65	25	04210.220.065
M12X75	50	04210.120.075	M20X40	25	04210.200.040	M22X70	25	04210.220.070
M12X80	50	04210.120.080	M20X45	25	04210.200.045	M22X75	25	04210.220.075
M12X85	50	04210.120.085	M20X50	25	04210.200.050	M22X80	25	04210.220.080
M12X90	50	04210.120.090	M20X55	25	04210.200.055	M22X85	25	04210.220.085
M12X95	50	04210.120.095	M20X60	25	04210.200.060	M22X90	25	04210.220.090
M12X100	50	04210.120.100	M20X65	25	04210.200.065	M22X95	25	04210.220.095
M12X110	50	04210.120.110	M20X70	25	04210.200.070	M22X100	25	04210.220.100
M12X120	50	04210.120.120	M20X75	25	04210.200.075	M22X110	25	04210.220.110
			M20X80	25	04210.200.080	M22X120	25	04210.220.120
M16X35	50	04210.160.035	M20X85	25	04210.200.085	M22X130	25	04210.220.130
M16X40	50	04210.160.040	M20X90	25	04210.200.090	M22X140	20	04210.220.140
M16X45	50	04210.160.045	M20X95	25	04210.200.095	M22X150	15	04210.220.150
M16X50	50	04210.160.050	M20X100	25	04210.200.100	M22X160	15	04210.220.160
M16X55	50	04210.160.055	M20X105	25	04210.200.105	M22X170	15	04210.220.170
M16X60	50	04210.160.060	M20X110	25	04210.200.110	M22X180	15	04210.220.180
M16X65	50	04210.160.065	M20X115	25	04210.200.115	M22X190	15	04210.220.190
M16X70	50	04210.160.070	M20X120	25	04210.200.120	M22X200	15	04210.220.200
M16X75	50	04210.160.075	M20X125	25	04210.200.125			
M16X80	25	04210.160.080	M20X130	25	04210.200.130	M24X50	25	04210.240.050
M16X85	25	04210.160.085	M20X140	25	04210.200.140	M24X55	25	04210.240.055
M16X90	25	04210.160.090	M20X150	25	04210.200.150	M24X60	25	04210.240.060
M16X95	25	04210.160.095	M20X160	20	04210.200.160	M24X65	25	04210.240.065
M16X100	25	04210.160.100	M20X170	20	04210.200.170	M24X70	25	04210.240.070
M16X110	25	04210.160.110	M20X180	15	04210.200.180	M24X75	25	04210.240.075
M16X115	25	04210.160.115	M20X190	15	04210.200.190	M24X80	25	04210.240.080
M16X120	25	04210.160.120	M20X200	15	04210.200.200	M24X85	25	04210.240.085
M16X130	25	04210.160.130	M20X210	15	04210.200.210	M24X90	25	04210.240.090
M16X140	25	04210.160.140	M20X220	15	04210.200.220	M24X95	25	04210.240.095

04210 PEINER Śruby konstrukcyjne o dużej wytrzymałości ←								
d x L	✉	Kod artykułu	d x L	✉	Kod artykułu	d x L	✉	Kod artykułu
M24X100	25	04210.240.100	M27X260	10	04210.270.260	M30X500	1	04210.300.500
M24X105	25	04210.240.105						
M24X110	25	04210.240.110	M30X70	10	04210.300.070	M36X80	5	04210.360.080
M24X115	25	04210.240.115	M30X75	10	04210.300.075	M36X85	5	04210.360.085
M24X120	20	04210.240.120	M30X80	10	04210.300.080	M36X90	5	04210.360.090
M24X125	20	04210.240.125	M30X85	10	04210.300.085	M36X95	5	04210.360.095
M24X130	20	04210.240.130	M30X90	10	04210.300.090	M36X100	5	04210.360.100
M24X135	20	04210.240.135	M30X95	10	04210.300.095	M36X110	5	04210.360.110
M24X140	20	04210.240.140	M30X100	10	04210.300.100	M36X115	5	04210.360.115
M24X150	15	04210.240.150	M30X110	10	04210.300.110	M36X120	5	04210.360.120
M24X160	15	04210.240.160	M30X115	10	04210.300.115	M36X130	5	04210.360.130
M24X170	10	04210.240.170	M30X120	10	04210.300.120	M36X140	5	04210.360.140
M24X180	10	04210.240.180	M30X130	10	04210.300.130	M36X150	5	04210.360.150
M24X190	10	04210.240.190	M30X140	10	04210.300.140	M36X160	5	04210.360.160
M24X200	10	04210.240.200	M30X150	10	04210.300.150	M36X170	5	04210.360.170
M24X210	10	04210.240.210	M30X160	10	04210.300.160	M36X180	5	04210.360.180
M24X220	10	04210.240.220	M30X165	10	04210.300.165	M36X190	5	04210.360.190
M24X230	10	04210.240.230	M30X170	10	04210.300.170	M36X200	5	04210.360.200
M24X240	10	04210.240.240	M30X180	5	04210.300.180	M36X210	5	04210.360.210
M24X250	10	04210.240.250	M30X190	5	04210.300.190	M36X220	5	04210.360.220
M24X260	10	04210.240.260	M30X200	5	04210.300.200	M36X230	5	04210.360.230
			M30X210	5	04210.300.210	M36X240	5	04210.360.240
M27X60	10	04210.270.060	M30X220	5	04210.300.220	M36X250	5	04210.360.250
M27X65	10	04210.270.065	M30X230	5	04210.300.230	M36X260	5	04210.360.260
M27X70	10	04210.270.070	M30X240	5	04210.300.240	M36X270	1	04210.360.270
M27X75	10	04210.270.075	M30X250	5	04210.300.250	M36X280	1	04210.360.280
M27X80	10	04210.270.080	M30X260	5	04210.300.260	M36X290	1	04210.360.290
M27X85	10	04210.270.085	M30X270	1	04210.300.270	M36X300	1	04210.360.300
M27X90	10	04210.270.090	M30X280	1	04210.300.280	M36X310	1	04210.360.310
M27X95	10	04210.270.095	M30X290	1	04210.300.290	M36X320	1	04210.360.320
M27X100	10	04210.270.100	M30X300	1	04210.300.300	M36X330	1	04210.360.330
M27X105	10	04210.270.105	M30X310	1	04210.300.310	M36X340	1	04210.360.340
M27X110	10	04210.270.110	M30X320	1	04210.300.320	M36X350	1	04210.360.350
M27X115	10	04210.270.115	M30X330	1	04210.300.330	M36X360	1	04210.360.360
M27X120	10	04210.270.120	M30X340	1	04210.300.340	M36X370	1	04210.360.370
M27X125	10	04210.270.125	M30X350	1	04210.300.350	M36X380	1	04210.360.380
M27X130	10	04210.270.130	M30X360	1	04210.300.360	M36X390	1	04210.360.390
M27X140	10	04210.270.140	M30X370	1	04210.300.370	M36X400	1	04210.360.400
M27X150	10	04210.270.150	M30X380	1	04210.300.380	M36X410	1	04210.360.410
M27X160	10	04210.270.160	M30X390	1	04210.300.390	M36X420	1	04210.360.420
M27X165	10	04210.270.165	M30X400	1	04210.300.400	M36X430	1	04210.360.430
M27X170	10	04210.270.170	M30X410	1	04210.300.410	M36X440	1	04210.360.440
M27X180	10	04210.270.180	M30X420	1	04210.300.420	M36X450	1	04210.360.450
M27X190	10	04210.270.190	M30X430	1	04210.300.430	M36X460	1	04210.360.460
M27X200	10	04210.270.200	M30X440	1	04210.300.440	M36X470	1	04210.360.470
M27X210	10	04210.270.210	M30X450	1	04210.300.450	M36X480	1	04210.360.480
M27X220	10	04210.270.220	M30X460	1	04210.300.460	M36X490	1	04210.360.490
M27X230	10	04210.270.230	M30X470	1	04210.300.470	M36X500	1	04210.360.500
M27X240	10	04210.270.240	M30X480	1	04210.300.480			
M27X250	10	04210.270.250	M30X490	1	04210.300.490			

Nakrętki konstrukcyjne o dużej wytrzymałości

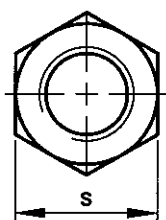
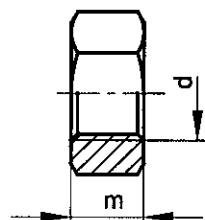

EN 14399-4

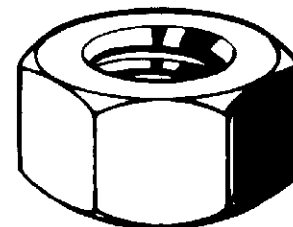

Informacje techniczne

d	m	P	s	d	m	P	s
M12	10	1.75	22	M36	29	4	60
M16	13	2	27	M39	31	4	65
M20	16	2.5	32	M42	34	4.5	70
M22	18	2.5	36	M45	36	4.5	75
M24	20	3	41	M48	38	5	80
M27	22	3	46	M56	45	5.5	90
M30	24	3.5	50	M64	51	6	100

Grupy katalogowe

Gwint	Gniazdo	Materiał	Klasa	Obróbka powierzchni	Kod	Strona
M	Sześciokąt	St	10		04025	1-91
M	Sześciokąt	St	10	Ocynk. gor.	04225	1-91

04025 PEINER Nakrętki konstrukcyjne o dużej wytrzymałości

C05A

Gwint Metryczny
Materiał Stal
Klasa 10

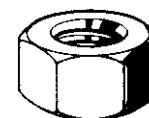

CE

d	☒	Kod artykułu	d	☒	Kod artykułu	d	☒	Kod artykułu
M12	200	04025.120.001	M22	50	04025.220.001	M30	50	04025.300.001
M16	100	04025.160.001	M24	50	04025.240.001	M36	25	04025.360.001
M20	100	04025.200.001	M27	50	04025.270.001			

04225 PEINER Nakrętki konstrukcyjne o dużej wytrzymałości

C05A

Gwint Metryczny
Materiał Stal
Klasa 10
Obróbka powierzchni Ocynkowane na gorąco

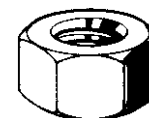

CE

d	☒	Kod artykułu	d	☒	Kod artykułu	d	☒	Kod artykułu
M12	200	04225.120.001	M27	50	04225.270.001	M45	1	04225.450.001
M16	100	04225.160.001	M30	50	04225.300.001	M48	1	04225.480.001
M20	100	04225.200.001	M36	25	04225.360.001	M56	1	04225.560.001
M22	50	04225.220.001	M39	1	04225.390.001	M64	1	04225.640.001
M24	50	04225.240.001	M42	1	04225.420.001			

- Ocynkowane na gorąco nakrętki o wysokiej wytrzymałości zgodnie z EN 14399-4 dostarczane są smarowane.

Podkładki konstrukcyjne o dużej wytrzymałości

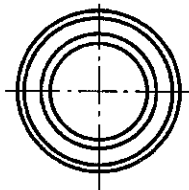
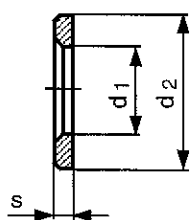

EN 14399-6

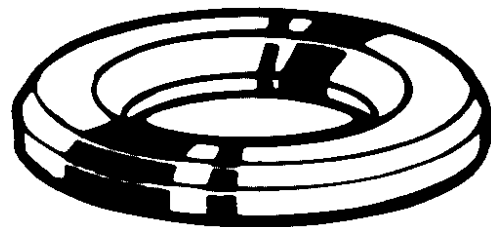

Informacje techniczne

Dla wymiaru nominalnego	d ₁	d ₂	s	Dla wymiaru nominalnego	d ₁	d ₂	s
M12	13	24	3	M36	37	66	6
M16	17	30	4	M39	41	72	6
M20	21	37	4	M42	44	78	8
M22	23	39	4	M45	47	85	8
M24	25	44	4	M48	50	92	8
M27	28	50	5	M56	58	105	10
M30	31	56	5	M64	66	115	10

Grupy katalogowe

Materiał	Obróbka powierzchni	Kod	Strona
St 300-370 HV10		04035	1-92
St 300-370 HV10	Ocynk. gor.	04237	1-92

04035 PEINER Podkładki konstrukcyjne o dużej wytrzymałości

C05A

Materiał Stal 300-370 HV10

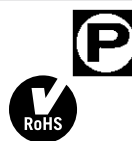

Dla wymiaru nominalnego	☒	Kod artykułu	Dla wymiaru nominalnego	☒	Kod artykułu	Dla wymiaru nominalnego	☒	Kod artykułu
M12	400	04035.120.001	M22	200	04035.220.001	M30	100	04035.300.001
M16	200	04035.160.001	M24	200	04035.240.001	M36	50	04035.360.001
M20	200	04035.200.001	M27	100	04035.270.001			

04237 PEINER Podkładki konstrukcyjne o dużej wytrzymałości

C05A

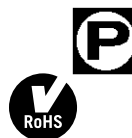
 Materiał Stal 300-370 HV10
 Obróbka powierzchni Ocynkowane na gorąco

Dla wymiaru nominalnego	☒	Kod artykułu	Dla wymiaru nominalnego	☒	Kod artykułu	Dla wymiaru nominalnego	☒	Kod artykułu
M12	400	04237.120.001	M27	100	04237.270.001	M45	1	04237.450.001
M16	200	04237.160.001	M30	100	04237.300.001	M48	1	04237.480.001
M20	200	04237.200.001	M36	50	04237.360.001	M56	1	04237.560.001
M22	200	04237.220.001	M39	1	04237.390.001	M64	1	04237.640.001
M24	200	04237.240.001	M42	1	04237.420.001			

Podkładki kwadratowe klinowe 14% do dwuteowników

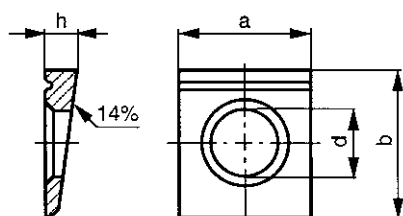
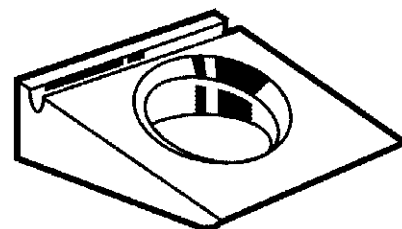

 DIN 6917
 NEN 5515

Informacje techniczne

Dla wymiaru nominalnego	a	b	d	h
M12	26	30	13	6.2
M16	32	36	17	7.5
M20	40	44	21	9.2
M22	44	50	23	10
M24	56	56	25	10.8
M27	56	56	28	10.8
M30	62	62	31	11.7
M36	68	68	37	12.5

04240 PEINER Podkładki kwadratowe klinowe 14% do dwuteowników

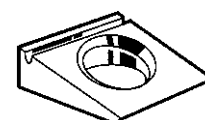
C05A

 Materiał Stal 295-350 HV10
 Obróbka powierzchni Ocynkowane na gorąco

Dla wymiaru nominalnego	☒	Kod artykułu	Dla wymiaru nominalnego	☒	Kod artykułu	Dla wymiaru nominalnego	☒	Kod artykułu
M12	200	04240.120.001	M22	50	04240.220.001	M30	50	04240.300.001
M16	100	04240.160.001	M24	50	04240.240.001	M36	50	04240.360.001
M20	100	04240.200.001	M27	50	04240.270.001			

Podkładki kwadratowe klinowe 8% do ceowników

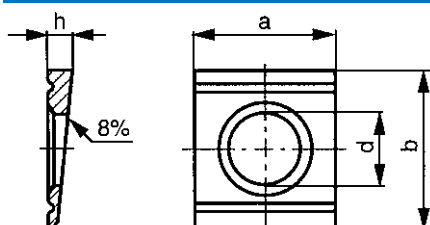
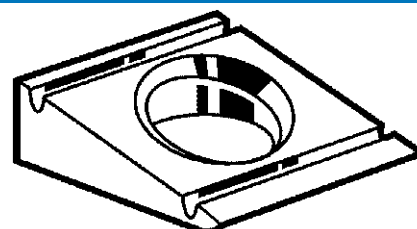

 DIN 6918
 NEN 5514

Informacje techniczne

Dla wymiaru nominalnego	a	b	d	h
M12	26	30	13	4.9
M16	32	36	17	5.9
M20	40	44	21	7
M22	44	50	23	8
M24	56	56	25	8.5
M27	56	56	28	8.5
M30	62	62	31	9
M36	68	68	37	9.4

04250 PEINER Podkładki kwadratowe klinowe 8% do ceowników

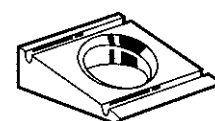
C05A

 Materiał Stal 295-350 HV10
 Obróbka powierzchni Ocynkowane na gorąco

Dla wymiaru nominalnego	☒	Kod artykułu	Dla wymiaru nominalnego	☒	Kod artykułu	Dla wymiaru nominalnego	☒	Kod artykułu
M12	200	04250.120.001	M22	50	04250.220.001	M30	50	04250.300.001
M16	100	04250.160.001	M24	50	04250.240.001	M36	50	04250.360.001
M20	100	04250.200.001	M27	50	04250.270.001			

Śruby konstrukcyjne z łbem sześciokątnym z nakrętką

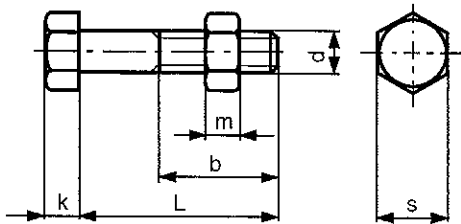
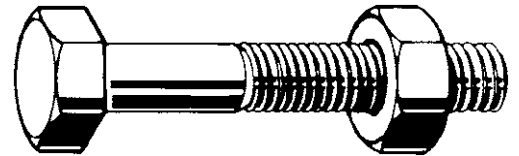
 EN 15048
 ISO 4014/4032

Informacje techniczne

d	b (min.): L≤125mm	b (min.): 125mm<L≤200mm	b (min.): L>200mm	k	m (maks.)	P	s
M10	26	32	45	6.4	8.4	1.5	16
M12	30	36	49	7.5	10.8	1.75	18
M16	38	44	57	10	14.8	2	24
M20	46	52	65	12.5	18	2.5	30
M24	54	60	73	15	21.5	3	36
M27	60	66	79	17	23.8	3	41
M30	66	72	85	18.7	25.6	3.5	46
M33	72	78	91	21	28.7	3.5	50
M36	78	84	97	22.5	31	4	55

• Tylko pełne opakowania.

Grupy katalogowe

Gwint	Gniazdo	Materiał	Klasa	Obróbka powierzchni	Kod	Strona
M	Sześciokąt	St	8.8	Ocynk.	01222	1-94
M	Sześciokąt	St	8.8	Ocynk. gor. izometryczna	01405	1-95

01222 Śruby konstrukcyjne z łbem sześciokątnym z nakrętką

A96A

Gwint Metryczny
Materiał Stal
Klasa 8.8
Obróbka powierzchni Ocynkowane



CE

d x L	☒	Kod artykułu	d x L	☒	Kod artykułu	d x L	☒	Kod artykułu
M12X50/S=18	100	01222.120.050	M16X120	25	01222.160.120	M20X280	10	01222.200.280
M12X55/S=18	100	01222.120.055	M16X130	25	01222.160.130	M20X300	10	01222.200.300
M12X60/S=18	100	01222.120.060	M16X140	25	01222.160.140	M20X320	10	01222.200.320
M12X70/S=18	75	01222.120.070	M16X150	25	01222.160.150	M20X340	10	01222.200.340
M12X75/S=18	50	01222.120.075	M16X160	25	01222.160.160	M20X360	10	01222.200.360
M12X80/S=18	50	01222.120.080	M16X170	25	01222.160.170			
M12X85/S=18	50	01222.120.085	M16X180	25	01222.160.180	M24X80	25	01222.240.080
M12X90/S=18	50	01222.120.090	M16X190	25	01222.160.190	M24X85	10	01222.240.085
M12X100/S=18	50	01222.120.100	M16X200	25	01222.160.200	M24X90	10	01222.240.090
M12X110/S=18	50	01222.120.110	M16X220	25	01222.160.220	M24X100	10	01222.240.100
M12X120/S=18	50	01222.120.120	M16X240	10	01222.160.240	M24X110	10	01222.240.110
M12X130/S=18	50	01222.120.130	M16X250	10	01222.160.250	M24X120	10	01222.240.120
M12X140/S=18	50	01222.120.140	M16X260	10	01222.160.260	M24X130	10	01222.240.130
M12X150/S=18	50	01222.120.150	M16X280	10	01222.160.280	M24X140	10	01222.240.140
M12X160/S=18	25	01222.120.160	M16X300	10	01222.160.300	M24X150	25	01222.240.150
M12X170/S=18	25	01222.120.170				M24X160	10	01222.240.160
M12X180/S=18	25	01222.120.180	M20X65	25	01222.200.065	M24X170	10	01222.240.170
M12X190/S=18	25	01222.120.190	M20X70	25	01222.200.070	M24X180	10	01222.240.180
M12X200/S=18	25	01222.120.200	M20X75	25	01222.200.075	M24X200	10	01222.240.200
M12X220/S=18	25	01222.120.220	M20X80	25	01222.200.080	M24X220	10	01222.240.220
M12X240/S=18	25	01222.120.240	M20X85	25	01222.200.085	M24X240	10	01222.240.240
M12X250/S=18	25	01222.120.250	M20X90	20	01222.200.090	M24X260	10	01222.240.260
M12X260/S=18	25	01222.120.260	M20X100	20	01222.200.100	M24X280	10	01222.240.280
M12X280/S=18	25	01222.120.280	M20X110	20	01222.200.110	M24X300	10	01222.240.300
M12X300/S=18	25	01222.120.300	M20X120	20	01222.200.120	M24X320	5	01222.240.320
			M20X130	20	01222.200.130	M24X340	5	01222.240.340
M16X55	50	01222.160.055	M20X140	10	01222.200.140	M24X360	5	01222.240.360
M16X60	50	01222.160.060	M20X150	10	01222.200.150			
M16X65	25	01222.160.065	M20X160	10	01222.200.160	M27X80	5	01222.270.080
M16X70	25	01222.160.070	M20X170	10	01222.200.170	M27X90	10	01222.270.090
M16X75	25	01222.160.075	M20X180	10	01222.200.180	M27X100	10	01222.270.100
M16X80	25	01222.160.080	M20X190	10	01222.200.190	M27X110	10	01222.270.110
M16X85	25	01222.160.085	M20X200	10	01222.200.200	M27X120	10	01222.270.120
M16X90	25	01222.160.090	M20X220	10	01222.200.220	M27X130	10	01222.270.130
M16X95	25	01222.160.095	M20X240	10	01222.200.240	M27X140	10	01222.270.140
M16X100	25	01222.160.100	M20X250	10	01222.200.250	M27X150	10	01222.270.150
M16X110	25	01222.160.110	M20X260	10	01222.200.260	M27X160	10	01222.270.160

01222 Śruby konstrukcyjne z łbem sześciokątnym z nakrętką

d x L	☒	Kod artykułu	d x L	☒	Kod artykułu	d x L	☒	Kod artykułu
M27X180	5	01222.270.180	M30X240	5	01222.300.240	M36X120	5	01222.360.120
M27X200	5	01222.270.200	M30X260	5	01222.300.260	M36X130	5	01222.360.130
			M30X280	5	01222.300.280	M36X140	5	01222.360.140
M30X90	10	01222.300.090	M30X300	5	01222.300.300	M36X150	5	01222.360.150
M30X100	10	01222.300.100				M36X160	5	01222.360.160
M30X110	10	01222.300.110	M33X100	5	01222.330.100	M36X180	2	01222.360.180
M30X120	10	01222.300.120	M33X110	5	01222.330.110	M36X200	2	01222.360.200
M30X130	10	01222.300.130	M33X120	5	01222.330.120	M36X220	2	01222.360.220
M30X140	10	01222.300.140	M33X130	5	01222.330.130	M36X240	2	01222.360.240
M30X150	10	01222.300.150	M33X140	5	01222.330.140	M36X260	2	01222.360.260
M30X160	10	01222.300.160	M33X150	5	01222.330.150	M36X280	2	01222.360.280
M30X170	5	01222.300.170	M33X160	5	01222.330.160	M36X300	2	01222.360.300
M30X180	5	01222.300.180	M33X180	2	01222.330.180	M36X320	2	01222.360.320
M30X200	5	01222.300.200						
M30X220	5	01222.300.220	M36X110	5	01222.360.110			

- Konstrukcje w Europie muszą być zgodne z Dyrektywą CPR (Construction Products Regulation) 305/2011 celem zapewnienia bezpieczeństwa ludzi i obiektów.
- W większości przypadków oznacza to stosowanie produktów zgodnie ze zharmonizowanymi normami europejskimi (hEN-standards)
- Dla połączeń strukturalnych niesprężanych oznacza to, że powinny być stosowane elementy złączne wg EN 15048-1. W porównaniu do standardowych śrub wg ISO 4014/4017 (dawniej DIN 931/933) i nakrętek ISO 4032 (DIN 934) śruby i nakrętki wg EN 15048 mają dodatkowo oznaczenie SB (Structural Bolting) i opakowanie z logo CE.
- Wytwórcy muszą mieć certyfikację CE na produkcję elementów złącznych wg EN 15048.
- Śruby i nakrętki są pakowane razem w pojedynczym zabezpieczonym pudełku

01405 Śruby konstrukcyjne z łbem sześciokątnym z nakrętką A96A

Gwint Metryczny
 Materiał Stal
 Klasa 8.8
 Obróbka powierzchni Ocynkowane na gorąco



CE

d x L	☒	Kod artykułu	d x L	☒	Kod artykułu	d x L	☒	Kod artykułu
M10X45/S=16	100	01405.100.045	M16X160	25	01405.160.160	M24X170	10	01405.240.170
M10X50/S=16	100	01405.100.050	M16X170	25	01405.160.170	M24X180	10	01405.240.180
M10X55/S=16	100	01405.100.055	M16X180	25	01405.160.180	M24X200	10	01405.240.200
M10X60/S=16	100	01405.100.060	M16X200	25	01405.160.200	M24X220	10	01405.240.220
M10X65/S=16	100	01405.100.065	M16X220	25	01405.160.220	M24X240	10	01405.240.240
M10X70/S=16	100	01405.100.070	M16X240	10	01405.160.240	M24X260	10	01405.240.260
M10X75/S=16	100	01405.100.075	M16X260	10	01405.160.260	M24X280	10	01405.240.280
M10X80/S=16	100	01405.100.080	M16X280	25	01405.160.280	M24X300	10	01405.240.300
M10X90/S=16	100	01405.100.090	M16X300	25	01405.160.300			
M10X100/S=16	100	01405.100.100				M27X80	10	01405.270.080
M10X110/S=16	50	01405.100.110	M20X65	25	01405.200.065	M27X90	10	01405.270.090
M10X120/S=16	50	01405.100.120	M20X70	25	01405.200.070	M27X100	10	01405.270.100
M10X130/S=16	50	01405.100.130	M20X75	25	01405.200.075	M27X110	10	01405.270.110
M10X140/S=16	50	01405.100.140	M20X80	25	01405.200.080	M27X120	10	01405.270.120
M10X160/S=16	50	01405.100.160	M20X85	25	01405.200.085	M27X130	10	01405.270.130
M10X180/S=16	50	01405.100.180	M20X90	25	01405.200.090	M27X140	10	01405.270.140
			M20X100	25	01405.200.100	M27X150	10	01405.270.150
M12X50/S=18	100	01405.120.050	M20X110	25	01405.200.110	M27X160	10	01405.270.160
M12X55/S=18	100	01405.120.055	M20X120	25	01405.200.120	M27X180	5	01405.270.180
M12X60/S=18	100	01405.120.060	M20X130	25	01405.200.130	M27X200	5	01405.270.200
M12X65/S=18	50	01405.120.065	M20X140	25	01405.200.140	M27X220	5	01405.270.220
M12X70/S=18	50	01405.120.070	M20X150	25	01405.200.150	M27X230	5	01405.270.230
M12X75/S=18	50	01405.120.075	M20X160	10	01405.200.160	M27X240	5	01405.270.240
M12X80/S=18	50	01405.120.080	M20X170	10	01405.200.170	M27X260	5	01405.270.260
M12X90/S=18	50	01405.120.090	M20X180	10	01405.200.180	M27X280	5	01405.270.280
M12X100/S=18	50	01405.120.100	M20X190	10	01405.200.190	M27X300	5	01405.270.300
M12X110/S=18	50	01405.120.110	M20X200	10	01405.200.200			
M12X120/S=18	50	01405.120.120	M20X220	10	01405.200.220	M30X90	10	01405.300.090
M12X130/S=18	50	01405.120.130	M20X240	10	01405.200.240	M30X100	10	01405.300.100
M12X140/S=18	50	01405.120.140	M20X260	10	01405.200.260	M30X110	10	01405.300.110
M12X150/S=18	50	01405.120.150	M20X280	10	01405.200.280	M30X120	10	01405.300.120
M12X160/S=18	50	01405.120.160	M20X300	10	01405.200.300	M30X130	10	01405.300.130
M12X180/S=18	50	01405.120.180				M30X140	10	01405.300.140
			M24X70	25	01405.240.070	M30X150	10	01405.300.150
M16X55	50	01405.160.055	M24X75	25	01405.240.075	M30X160	10	01405.300.160
M16X60	50	01405.160.060	M24X80	25	01405.240.080	M30X180	5	01405.300.180
M16X65	25	01405.160.065	M24X85	10	01405.240.085			
M16X70	25	01405.160.070	M24X90	10	01405.240.090	M36X110	5	01405.360.110
M16X75	25	01405.160.075	M24X95	10	01405.240.095	M36X120	5	01405.360.120
M16X80	25	01405.160.080	M24X100	10	01405.240.100	M36X130	5	01405.360.130
M16X90	25	01405.160.090	M24X110	10	01405.240.110	M36X140	5	01405.360.140
M16X100	25	01405.160.100	M24X120	10	01405.240.120	M36X150	5	01405.360.150
M16X110	25	01405.160.110	M24X130	10	01405.240.130	M36X160	5	01405.360.160
M16X120	25	01405.160.120	M24X140	10	01405.240.140	M36X180	5	01405.360.180
M16X130	25	01405.160.130	M24X150	10	01405.240.150	M36X200	5	01405.360.200
M16X140	25	01405.160.140	M24X160	10	01405.240.160	M36X220	5	01405.360.220
M16X150	25	01405.160.150						

01405 Śruby konstrukcyjne z łbem sześciokątnym z nakrętką

- Konstrukcje w Europie muszą być zgodne z Dyrektywą CPR (Construction Products Regulation) 305/2011 celem zapewnienia bezpieczeństwa ludzi i obiektów.
- W większości przypadków oznacza to stosowanie produktów zgodnie ze zharmonizowanymi normami europejskimi (hEN-standards)
- Dla połączeń strukturalnych niesprężanych oznacza to, że powinny być stosowane elementy złączne wg EN 15048-1. W porównaniu do standardowych śrub wg ISO 4014/4017 (dawniej DIN 931/933) i nakrętek ISO 4032 (DIN 934) śruby i nakrętki wg EN 15048 mają dodatkowo oznaczenie SB (Structural Bolting) i opakowanie z logo CE.
- Wytwórcy muszą mieć certyfikację CE na produkcję elementów złącznych wg EN 15048.
- Śruby i nakrętki są pakowane razem w pojedynczym zabezpieczonym pudełku

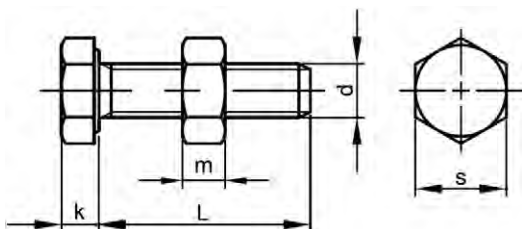
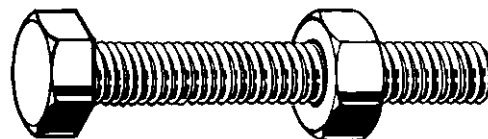
Śruby konstrukcyjne z łbem sześciokątnym z pełnym gwintem z nakrętką

 EN 15048
 ISO 4017/4032

Informacje techniczne

d	k	m (maks.)	P	s
M10	6.4	8.4	1.5	16
M12	7.5	10.8	1.75	18
M16	10	14.8	2	24
M20	12.5	18	2.5	30
M24	15	21.5	3	36
M27	17	23.8	3	41
M30	18.7	25.6	3.5	46
M36	22.5	31	4	55

- Tylko pełne opakowania.

Grupy katalogowe

Gwint	Gniazdo	Materiał	Klasa	Obróbka powierzchni	Kod	Strona
M	Sześciokąt	St	8.8	Ocynk.	01232	1-96
M	Sześciokąt	St	8.8	Ocynk. gor. izometryczna	01415	1-97

01232 Śruby konstrukcyjne z łbem sześciokątnym z pełnym gwintem z nakrętką
A96A

Gwint: Metryczny
 Materiał: Stal
 Klasa: 8.8
 Obróbka powierzchni: Ocynkowane

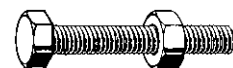

CE

d x L	☒	Kod artykułu	d x L	☒	Kod artykułu	d x L	☒	Kod artykułu
M12X20/S=18	100	01232.120.020	M16X70	25	01232.160.070	M24X70	25	01232.240.070
M12X25/S=18	100	01232.120.025	M16X80	25	01232.160.080	M24X75	25	01232.240.075
M12X30/S=18	100	01232.120.030	M16X90	25	01232.160.090	M24X80	25	01232.240.080
M12X35/S=18	100	01232.120.035	M16X100	25	01232.160.100	M24X90	10	01232.240.090
M12X40/S=18	100	01232.120.040				M24X100	10	01232.240.100
M12X45/S=18	100	01232.120.045	M20X30	25	01232.200.030			
M12X50/S=18	100	01232.120.050	M20X35	25	01232.200.035	M27X50	10	01232.270.050
M12X55/S=18	100	01232.120.055	M20X40	25	01232.200.040	M27X60	10	01232.270.060
M12X60/S=18	100	01232.120.060	M20X45	25	01232.200.045	M27X70	10	01232.270.070
M12X65/S=18	50	01232.120.065	M20X50	25	01232.200.050	M27X80	10	01232.270.080
M12X70/S=18	50	01232.120.070	M20X55	25	01232.200.055			
M12X80/S=18	50	01232.120.080	M20X60	25	01232.200.060	M30X50	10	01232.300.050
M12X100/S=18	50	01232.120.100	M20X65	25	01232.200.065	M30X60	10	01232.300.060
			M20X70	25	01232.200.070	M30X70	10	01232.300.070
M16X20	50	01232.160.020	M20X80	25	01232.200.080	M30X80	10	01232.300.080
M16X25	50	01232.160.025	M20X90	25	01232.200.090	M30X90	10	01232.300.090
M16X30	50	01232.160.030	M20X100	25	01232.200.100	M30X100	10	01232.300.100
M16X35	50	01232.160.035						
M16X40	50	01232.160.040	M24X40	25	01232.240.040	M36X70	5	01232.360.070
M16X45	50	01232.160.045	M24X45	25	01232.240.045	M36X80	5	01232.360.080
M16X50	50	01232.160.050	M24X50	25	01232.240.050	M36X90	5	01232.360.090
M16X55	50	01232.160.055	M24X55	25	01232.240.055	M36X100	5	01232.360.100
M16X60	50	01232.160.060	M24X60	25	01232.240.060			
M16X65	25	01232.160.065	M24X65	25	01232.240.065			

01232 Śruby konstrukcyjne z łbem sześciokątnym z pełnym gwintem z nakrętką

- Konstrukcje w Europie muszą być zgodne z Dyrektywą CPR (Construction Products Regulation) 305/2011 celem zapewnienia bezpieczeństwa ludzi i obiektów.
- W większości przypadków oznacza to stosowanie produktów zgodnie ze zharmonizowanymi normami europejskimi (hEN-standards)
- Dla połączeń strukturalnych niesprężanych oznacza to, że powinny być stosowane elementy złączne wg EN 15048-1. W porównaniu do standardowych śrub wg ISO 4014/4017 (dawniej DIN 931/933) i nakrętek ISO 4032 (DIN 934) śruby i nakrętki wg EN 15048 mają dodatkowo oznaczenie SB (Structural Bolting) i opakowanie z logo CE.
- Wytwórcy muszą mieć certyfikację CE na produkcję elementów złącznych wg EN 15048.
- Śruby i nakrętki są pakowane razem w pojedynczym zapieczętowanym pudełku

01415 Śruby konstrukcyjne z łbem sześciokątnym z pełnym gwintem z nakrętką
A96A

Gwint Metryczny
Materiał Stal
Klasa 8.8
Obróbka powierzchni O cynkowane na gorąco

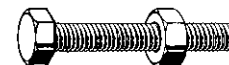

CE

d x L	☒	Kod artykułu	d x L	☒	Kod artykułu	d x L	☒	Kod artykułu
M10X16/S=16	200	01415.100.016	M16X25	50	01415.160.025	M24X50	25	01415.240.050
M10X20/S=16	200	01415.100.020	M16X30	50	01415.160.030	M24X55	25	01415.240.055
M10X25/S=16	200	01415.100.025	M16X35	50	01415.160.035	M24X60	25	01415.240.060
M10X30/S=16	200	01415.100.030	M16X40	50	01415.160.040	M24X65	25	01415.240.065
M10X35/S=16	100	01415.100.035	M16X45	50	01415.160.045	M24X70	25	01415.240.070
M10X40/S=16	100	01415.100.040	M16X50	50	01415.160.050	M24X75	25	01415.240.075
M10X45/S=16	100	01415.100.045	M16X55	50	01415.160.055	M24X80	25	01415.240.080
M10X50/S=16	100	01415.100.050	M16X60	50	01415.160.060	M24X90	10	01415.240.090
M10X55/S=16	100	01415.100.055	M16X65	25	01415.160.065	M24X100	10	01415.240.100
M10X60/S=16	100	01415.100.060	M16X70	25	01415.160.070	M24X110	10	01415.240.110
M10X65/S=16	100	01415.100.065	M16X75	25	01415.160.075	M24X120	10	01415.240.120
M10X70/S=16	100	01415.100.070	M16X80	25	01415.160.080			
M10X75/S=16	100	01415.100.075	M16X90	25	01415.160.090	M27X50	10	01415.270.050
M10X80/S=16	100	01415.100.080	M16X100	25	01415.160.100	M27X60	10	01415.270.060
M10X90/S=16	100	01415.100.090	M16X110	25	01415.160.110	M27X65	10	01415.270.065
M10X100/S=16	100	01415.100.100	M16X120	25	01415.160.120	M27X70	10	01415.270.070
						M27X75	10	01415.270.075
M12X20/S=18	100	01415.120.020	M20X30	25	01415.200.030	M27X80	10	01415.270.080
M12X25/S=18	100	01415.120.025	M20X35	25	01415.200.035	M27X90	10	01415.270.090
M12X30/S=18	100	01415.120.030	M20X40	25	01415.200.040	M27X100	10	01415.270.100
M12X35/S=18	100	01415.120.035	M20X45	25	01415.200.045	M27X110	10	01415.270.110
M12X40/S=18	100	01415.120.040	M20X50	25	01415.200.050	M27X120	10	01415.270.120
M12X45/S=18	100	01415.120.045	M20X55	25	01415.200.055			
M12X50/S=18	100	01415.120.050	M20X60	25	01415.200.060	M30X60	10	01415.300.060
M12X55/S=18	100	01415.120.055	M20X65	25	01415.200.065	M30X65	10	01415.300.065
M12X60/S=18	100	01415.120.060	M20X70	25	01415.200.070	M30X70	10	01415.300.070
M12X65/S=18	50	01415.120.065	M20X75	25	01415.200.075	M30X80	10	01415.300.080
M12X70/S=18	50	01415.120.070	M20X80	25	01415.200.080	M30X90	10	01415.300.090
M12X75/S=18	50	01415.120.075	M20X90	25	01415.200.090	M30X100	10	01415.300.100
M12X80/S=18	50	01415.120.080	M20X100	25	01415.200.100			
M12X90 /S=18	50	01415.120.090	M20X110	25	01415.200.110	M36X80	5	01415.360.080
M12X100/S=18	50	01415.120.100	M20X120	25	01415.200.120	M36X90	5	01415.360.090
M12X110/S=18	50	01415.120.110				M36X100	5	01415.360.100
M12X120/S=18	50	01415.120.120	M24X40	25	01415.240.040			
			M24X45	25	01415.240.045			

- Konstrukcje w Europie muszą być zgodne z Dyrektywą CPR (Construction Products Regulation) 305/2011 celem zapewnienia bezpieczeństwa ludzi i obiektów.
- W większości przypadków oznacza to stosowanie produktów zgodnie ze zharmonizowanymi normami europejskimi (hEN-standards)
- Dla połączeń strukturalnych niesprężanych oznacza to, że powinny być stosowane elementy złączne wg EN 15048-1. W porównaniu do standardowych śrub wg ISO 4014/4017 (dawniej DIN 931/933) i nakrętek ISO 4032 (DIN 934) śruby i nakrętki wg EN 15048 mają dodatkowo oznaczenie SB (Structural Bolting) i opakowanie z logo CE.
- Wytwórcy muszą mieć certyfikację CE na produkcję elementów złącznych wg EN 15048.
- Śruby i nakrętki są pakowane razem w pojedynczym zapieczętowanym pudełku

Zaślepki ochronne sześciokątne

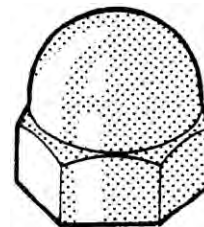
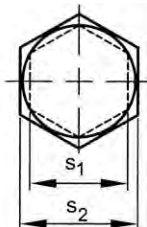
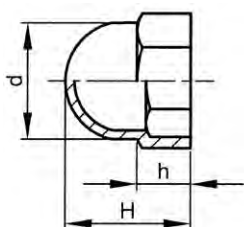

Informacje techniczne

W użyciu z	d	h	H	s	s ₁	s ₂
M4	7.6	4.8	8.1	7	6.8	8.6
M5	9.5	6.9	10.8	8	7.8	9.8
M6	11	6.9	13.3	10	9.8	11.6
M7	12	7.4	14.2	11	10.8	12.5
M8	14.3	8	15.3	13	12.8	15
M10	18	10.3	20.5	17	16.7	18.8
M12	20.2	11.5	22	19	18.7	20.8
M14	23.5	13	24.5	22	21.7	24.3
M16	26	15.1	28	24	23.7	26.5
M20	32	18	34	30	29.8	33
M22	34	19	37	32	31.8	35
M24	38	20	41	36	35.8	39.5
M27	43	22	47	41	40.8	44.5
M30	48	24	52	46	45.8	49.5
M33	53	36	57.5	50	49	54
M36	57	38	62.2	55	54.5	58.7

Przykład zastosowania

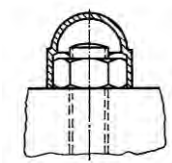

Grupy katalogowe

Material	Kolor	Kod	Strona
Plastik PE	Biały	56660	1-98
Plastik PE	Czarny	56661	1-99
Plastik PE	Szary	56662	1-99

56660 Zaślepki ochronne sześciokątne

W02G

Material Plastik Polietylen
Kolor Biały



W użyciu z / s	☒	Kod artykułu	W użyciu z / s	☒	Kod artykułu	W użyciu z / s	☒	Kod artykułu
M4/s=7	100	56660.040.001	M12/s=19	50	56660.120.001	M27/s=41	10	56660.270.001
M5/s=8	100	56660.050.001	M14/s=22	50	56660.140.001	M30/s=46	10	56660.300.001
M6/s=10	100	56660.060.001	M16/s=24	50	56660.160.001	M33/s=50	10	56660.330.001
M7/s=11	100	56660.070.001	M20/s=30	25	56660.200.001	M36/s=55	10	56660.360.001
M8/s=13	100	56660.080.001	M22/s=32	25	56660.220.001			
M10/s=17	50	56660.100.001	M24/s=36	25	56660.240.001			

56661		Zaślepki ochronne sześciokątne		W02G		
Materiał	Plastik Polietylen					
Kolor	Czarny					

W użyciu z / s	✉	Kod artykułu	W użyciu z / s	✉	Kod artykułu	W użyciu z / s	✉	Kod artykułu
M4/s=7	100	56661.040.001	M10/s=17	50	56661.100.001	M20/s=30	25	56661.200.001
M5/s=8	100	56661.050.001	M12/s=19	50	56661.120.001	M22/s=32	25	56661.220.001
M6/s=10	100	56661.060.001	M14/s=22	50	56661.140.001	M24/s=36	25	56661.240.001
M7/s=11	100	56661.070.001	M16/s=24	50	56661.160.001	M27/s=41	10	56661.270.001
M8/s=13	100	56661.080.001						

56662		Zaślepki ochronne sześciokątne		W03G		
Materiał	Plastik Polietylen					
Kolor	Szary					

W użyciu z / s	✉	Kod artykułu	W użyciu z / s	✉	Kod artykułu	W użyciu z / s	✉	Kod artykułu
M4/s=7	100	56662.040.001	M8/s=13	100	56662.080.001	M16/s=24	50	56662.160.001
M5/s=8	100	56662.050.001	M10/s=17	50	56662.100.001	M20/s=30	25	56662.200.001
M6/s=10	100	56662.060.001	M12/s=19	50	56662.120.001	M24/s=36	25	56662.240.001
M7/s=11	100	56662.070.001	M14/s=22	50	56662.140.001			

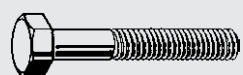

1 Śruby

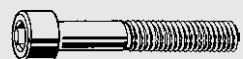

2 Produkty z gniazdem sześciokątnym



3 Nakrętki, nitonakrętki & wkładki



4 Pręty gwintowane & śruby dwustronne



5 Haki & śruby oczkowe



6 Wkręty

I Index



7 Podkładki & pierścienie uszczelniające typu “O-ring”



8 Kotwy, kołki, dyble

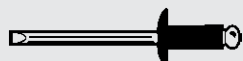

9 Nity, kołki & wpusty



10 Elementy łączące systemowe, meblowe & zabezpieczające



11 Zestawy

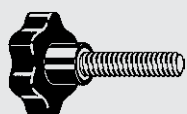

12 Części konstrukcyjne & części maszynowe

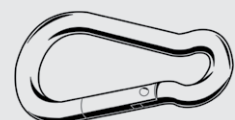

















































13 Przemysł morski

T Technologia łączenia

Produkty z gniazdem sześciokątnym 2

2

 Strona 2-2 DIN 912 Metryczny	 Strona 2-16 ISO 14579 Gniazdo sześciokątne, metryczny	 Strona 2-17 DIN ≈912 Z gwintem na całej długości, metryczny	 Strona 2-20 DIN 912 Metryczny drobny	 Strona 2-21 ASME ≈B18.3 (1960) Seria 1960 UNC
 Strona 2-22 ASME ≈B18.3 (1936) Seria 1936 UNC	 Strona 2-28 ASME ≈B18.3 (1936) Seria 1936 UNF	 Strona 2-32 BS ≈2470 BSW	 Strona 2-32 DIN 7984 Niska walcowa, metryczny	 Strona 2-36 DIN 6912 Niska z prowadzeniem na klucz, metryczny
 Strona 2-39 ISO 10642 Z łbem stożkowym, metryczny	 Strona 2-44 ISO ≈10642 Z gniazdem sześciokątnym, metr.	 Strona 2-45 ASME ≈B18.3 UNC	 Strona 2-48 ASME ≈B18.3 UNF	 Strona 2-50 BS ≈2470 BSW
 Strona 2-51 ISO 7380-1 Z łbem grzybkowym, metryczny	 Strona 2-54 ISO ≈7380-1 Z gniazdem sześciokątnym, metr.	 Strona 2-56 UNC	 Strona 2-58 UNF	 Strona 2-59 ISO 7380-2 Z kołnierzem, metryczny
 Strona 2-62 ISO ≈7380-2 Z kołnierzem i gn. sześciokątnym, metryczny	 Strona 2-63 Samozabezpieczająca, metryczny	 Strona 2-64 ISO ≈7379 Tolerancja f9, metryczny	 Strona 2-66 ASME B18.3 UNC	 Strona 2-68 ISO ≈7379 Tolerancja h8, metryczny
 Strona 2-69 DIN 916 Z końcem wgłębionym, metryczny	 Strona 2-72 DIN ≈916 Z końcem wgłębionym, metryczny drobny	 Strona 2-73 ASME ≈B18.3 Z końcem wgłębionym, UNC	 Strona 2-75 ASME ≈B18.3 Z końcem wgłębionym UNF	 Strona 2-76 DIN ≈916 Z radełkow. końcem wgłęb., metryczny
 Strona 2-77 ASME ≈B18.3 Z radełk. końc., wgłębiony UNC	 Strona 2-78 ASME ≈B18.3 Z radełk. końc., wgłębiony UNF	 Strona 2-78 DIN 913 Z końcem płaskim, metryczny	 Strona 2-81 DIN ≈913 Z końcem płaskim, metryczny drobny	 Strona 2-82 ASME ≈B18.3 Z końcem płaskim UNC
 Strona 2-83 DIN 914 Z końcem stożkowym, metryczny	 Strona 2-85 ASME ≈B18.3 Z końcem stożkowym UNC	 Strona 2-86 DIN 915 Z czopem walcowym, Metryczny	 Strona 2-88 ASME ≈B18.3 Z krótkim czopem walcowym UNC	 Strona 2-89 Z nylonowym czopem walcowym, metryczny
 Strona 2-90 BS ≈2470 Z końcem wgłębionym, BSW	 Strona 2-90 ASME ≈B18.3 Z końcem owalnym UNC	 Strona 2-91 Zaśleka, plastik	 Strona 2-92 DIN 906 Korek drobnozwojny stożkowy	 Strona 2-93 DIN 906 Korek z gwintem rurowym, stożkowym
 Strona 2-94 DIN 908 Korek drobnozwojny, walcowy	 Strona 2-95 DIN 908 Korek z gwintem rurowym	 Strona 2-96 DIN 910 Korek drobnozwojny, walcowy	 Strona 2-97 DIN 910 Korek z gwintem rurowym	

Śruby z łbem walcowym z gniazdem sześciokątnym

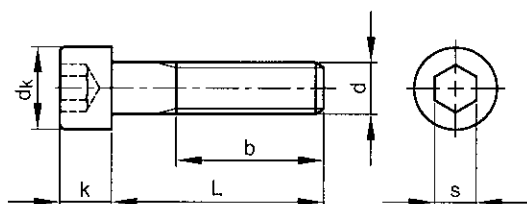

DIN	912
ISO	4762
NEN	1241
ASME	B18.3.1M
NF	E25-125
BS	4168-1

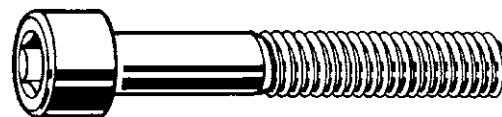

Informacje techniczne

d	b	d _k (maks.)	k (maks.)	P	Pelen gwint L ≤	s
M1.6	15	3	1.6	0.35	16	1.5
M2	16	3.8	2	0.4	20	1.5
M2.5	17	4.5	2.5	0.45	25	2
M3	18	5.5	3	0.5	20	2.5
M4	20	7	4	0.7	25	3
M5	22	8.5	5	0.8	25	4
M6	24	10	6	1	30	5
M8	28	13	8	1.25	35	6
M10	32	16	10	1.5	40	8
M12	36	18	12	1.75	50	10
M14	40	21	14	2	55	12
M16	44	24	16	2	60	14
M18	48	27	18	2.5	65	14
M20	52	30	20	2.5	75	17
M22	56	33	22	2.5	70	17
M24	60	36	24	3	85	19
M27	66	40	27	3	90	19
M30	72	45	30	3.5	100	22
M33	78	50	33	3.5	100	24
M36	84	54	36	4	110	27
M39 (#DIN)	90	58	39	4	120	27
M42	96	63	42	4.5	130	32
M48	108	72	48	5	150	36

Grupy katalogowe

Gwint	Gniazdo	Materiał	Klasa	Obróbka powierzchni	Kod	Strona
M	Gniazdo sześciokątne	St	8.8		07060	2-2
M	Gniazdo sześciokątne	St	8.8	Ocynek.	07160	2-4
M	Gniazdo sześciokątne	St	8.8	Ocynek. żłt. pas.	07170	2-5
M	Gniazdo sześciokątne	St	8.8	FLZNNC-NC6	07065	2-6
M	Gniazdo sześciokątne	St	10.9		07015	2-6
M	Gniazdo sześciokątne	St	12.9		07000	2-7
M	Gniazdo sześciokątne	St	12.9	FLZNNC-NC6	07025	2-9
M	Gniazdo sześciokątne	St.St. A2	70		51050	2-10
M	Gniazdo sześciokątne	St.St. A4	70		55050	2-12
M	Gniazdo sześciokątne	St.St. A4	80		53570	2-14
M	Gniazdo sześciokątne	Al P60			45205	2-15

07060 Śruby z łbem walcowym z gniazdem sześciokątnym

D02A

Gwint	Metryczny
Materiał	Stal
Klasa	8.8

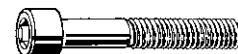

d x L	☒	Kod artykułu	d x L	☒	Kod artykułu	d x L	☒	Kod artykułu
M3X4	200	07060.030.004				M4X40	200	07060.040.040
M3X5	200	07060.030.005	M4X6	200	07060.040.006	M4X45	200	07060.040.045
M3X6	200	07060.030.006	M4X8	200	07060.040.008	M4X50	200	07060.040.050
M3X8	200	07060.030.008	M4X10	200	07060.040.010	M4X60	200	07060.040.060
M3X10	200	07060.030.010	M4X12	200	07060.040.012	M4X65	200	07060.040.065
M3X12	200	07060.030.012	M4X16	200	07060.040.016	M4X70	200	07060.040.070
M3X16	200	07060.030.016	M4X18	200	07060.040.018			
M3X20	200	07060.030.020	M4X20	200	07060.040.020	M5X6	200	07060.050.006
M3X25	200	07060.030.025	M4X25	200	07060.040.025	M5X8	200	07060.050.008
M3X30	500	07060.030.030	M4X30	200	07060.040.030	M5X10	200	07060.050.010
M3X40	200	07060.030.040	M4X35	200	07060.040.035	M5X12	200	07060.050.012

07060 Śruby z łbem walcowym z gniazdem sześciokątnym								
d x L	☒	Kod artykułu	d x L	☒	Kod artykułu	d x L	☒	Kod artykułu
M5X14	200	07060.050.014	M10X22	200	07060.100.022	M16X30	50	07060.160.030
M5X16	200	07060.050.016	M10X25	200	07060.100.025	M16X35	50	07060.160.035
M5X18	200	07060.050.018	M10X30	200	07060.100.030	M16X40	50	07060.160.040
M5X20	200	07060.050.020	M10X35	100	07060.100.035	M16X45	50	07060.160.045
M5X25	200	07060.050.025	M10X40	100	07060.100.040	M16X50	50	07060.160.050
M5X30	200	07060.050.030	M10X45	100	07060.100.045	M16X55	50	07060.160.055
M5X35	200	07060.050.035	M10X50	100	07060.100.050	M16X60	50	07060.160.060
M5X40	200	07060.050.040	M10X55	100	07060.100.055	M16X65	50	07060.160.065
M5X45	200	07060.050.045	M10X60	100	07060.100.060	M16X70	25	07060.160.070
M5X50	200	07060.050.050	M10X65	100	07060.100.065	M16X75	25	07060.160.075
M5X55	200	07060.050.055	M10X70	100	07060.100.070	M16X80	25	07060.160.080
M5X60	200	07060.050.060	M10X75	100	07060.100.075	M16X85	25	07060.160.085
M5X70	200	07060.050.070	M10X80	100	07060.100.080	M16X90	25	07060.160.090
M5X75	200	07060.050.075	M10X90	100	07060.100.090	M16X100	25	07060.160.100
M5X80	200	07060.050.080	M10X100	50	07060.100.100	M16X110	25	07060.160.110
M5X90	200	07060.050.090	M10X110	50	07060.100.110	M16X120	25	07060.160.120
M5X100	200	07060.050.100	M10X120	50	07060.100.120	M16X130	25	07060.160.130
M5X110	100	07060.050.110	M10X130	50	07060.100.130	M16X140	25	07060.160.140
M5X120	100	07060.050.120	M10X140	50	07060.100.140	M16X150	25	07060.160.150
M5X140	100	07060.050.140	M10X150	25	07060.100.150	M16X160	25	07060.160.160
			M10X160	25	07060.100.160	M16X180	10	07060.160.180
M6X8	200	07060.060.008	M10X170	25	07060.100.170	M16X200	10	07060.160.200
M6X10	200	07060.060.010	M10X180	25	07060.100.180	M16X220	10	07060.160.220
M6X12	200	07060.060.012	M10X200	25	07060.100.200	M16X240	10	07060.160.240
M6X14	200	07060.060.014	M10X220	25	07060.100.220	M16X260	10	07060.160.260
M6X16	200	07060.060.016				M16X300	10	07060.160.300
M6X18	200	07060.060.018	M12X16	100	07060.120.016			
M6X20	200	07060.060.020	M12X20	100	07060.120.020	M18X35	25	07060.180.035
M6X22	200	07060.060.022	M12X25	100	07060.120.025	M18X40	25	07060.180.040
M6X25	200	07060.060.025	M12X30	100	07060.120.030	M18X45	25	07060.180.045
M6X30	200	07060.060.030	M12X35	100	07060.120.035	M18X50	25	07060.180.050
M6X35	200	07060.060.035	M12X40	100	07060.120.040	M18X55	25	07060.180.055
M6X40	200	07060.060.040	M12X45	100	07060.120.045	M18X60	25	07060.180.060
M6X45	200	07060.060.045	M12X50	100	07060.120.050	M18X70	25	07060.180.070
M6X50	200	07060.060.050	M12X55	100	07060.120.055	M18X80	25	07060.180.080
M6X55	200	07060.060.055	M12X60	100	07060.120.060	M18X90	25	07060.180.090
M6X60	200	07060.060.060	M12X65	50	07060.120.065	M18X100	25	07060.180.100
M6X65	200	07060.060.065	M12X70	50	07060.120.070	M18X110	10	07060.180.110
M6X70	200	07060.060.070	M12X75	50	07060.120.075	M18X120	10	07060.180.120
M6X75	200	07060.060.075	M12X80	50	07060.120.080	M18X140	10	07060.180.140
M6X80	200	07060.060.080	M12X90	50	07060.120.090	M18X160	10	07060.180.160
M6X90	100	07060.060.090	M12X100	50	07060.120.100	M18X180	10	07060.180.180
M6X100	100	07060.060.100	M12X110	50	07060.120.110	M18X200	10	07060.180.200
M6X110	100	07060.060.110	M12X120	25	07060.120.120			
M6X120	100	07060.060.120	M12X130	25	07060.120.130	M20X30	50	07060.200.030
M6X130	100	07060.060.130	M12X140	25	07060.120.140	M20X35	25	07060.200.035
M6X140	100	07060.060.140	M12X150	25	07060.120.150	M20X40	25	07060.200.040
M6X150	100	07060.060.150	M12X160	25	07060.120.160	M20X45	25	07060.200.045
M6X160	100	07060.060.160	M12X180	25	07060.120.180	M20X50	25	07060.200.050
M6X180	100	07060.060.180	M12X200	25	07060.120.200	M20X55	25	07060.200.055
			M12X220	25	07060.120.220	M20X60	25	07060.200.060
M8X10	200	07060.080.010	M12X240	25	07060.120.240	M20X65	25	07060.200.065
M8X12	200	07060.080.012	M12X260	25	07060.120.260	M20X70	25	07060.200.070
M8X16	200	07060.080.016	M12X280	25	07060.120.280	M20X75	25	07060.200.075
M8X18	200	07060.080.018	M12X300	25	07060.120.300	M20X80	25	07060.200.080
M8X20	200	07060.080.020				M20X90	25	07060.200.090
M8X22	200	07060.080.022	M14X20	100	07060.140.020	M20X100	25	07060.200.100
M8X25	200	07060.080.025	M14X25	100	07060.140.025	M20X110	25	07060.200.110
M8X30	200	07060.080.030	M14X30	100	07060.140.030	M20X120	25	07060.200.120
M8X35	200	07060.080.035	M14X35	100	07060.140.035	M20X130	25	07060.200.130
M8X40	200	07060.080.040	M14X40	100	07060.140.040	M20X140	25	07060.200.140
M8X45	200	07060.080.045	M14X45	50	07060.140.045	M20X150	25	07060.200.150
M8X50	200	07060.080.050	M14X50	50	07060.140.050	M20X160	10	07060.200.160
M8X55	200	07060.080.055	M14X55	50	07060.140.055	M20X180	10	07060.200.180
M8X60	200	07060.080.060	M14X60	50	07060.140.060	M20X190	10	07060.200.190
M8X70	200	07060.080.070	M14X70	50	07060.140.070	M20X200	10	07060.200.200
M8X75	200	07060.080.075	M14X75	50	07060.140.075	M20X220	10	07060.200.220
M8X80	200	07060.080.080	M14X80	50	07060.140.080	M20X240	10	07060.200.240
M8X90	100	07060.080.090	M14X90	50	07060.140.090	M20X250	10	07060.200.250
M8X100	100	07060.080.100	M14X100	50	07060.140.100	M20X260	10	07060.200.260
M8X110	100	07060.080.110	M14X110	50	07060.140.110	M20X270	10	07060.200.270
M8X120	100	07060.080.120	M14X120	25	07060.140.120	M20X280	10	07060.200.280
M8X130	50	07060.080.130	M14X130	25	07060.140.130	M20X300	10	07060.200.300
M8X140	50	07060.080.140	M14X140	25	07060.140.140	M20X310	10	07060.200.310
M8X150	50	07060.080.150	M14X150	25	07060.140.150			
M8X160	50	07060.080.160	M14X160	25	07060.140.160	M22X50	10	07060.220.050
M8X180	50	07060.080.180	M14X180	25	07060.140.180	M22X60	10	07060.220.060
M8X200	50	07060.080.200	M14X190	25	07060.140.190	M22X70	10	07060.220.070
			M14X200	25	07060.140.200	M22X80	10	07060.220.080
M10X12	200	07060.100.012				M22X90	10	07060.220.090
M10X16	200	07060.100.016	M16X20	100	07060.160.020	M22X100	10	07060.220.100
M10X20	200	07060.100.020	M16X25	100	07060.160.025	M22X110	10	07060.220.110

07060 Śruby z łbem walcowym z gniazdem sześciokątnym ←

d x L	☒	Kod artykułu	d x L	☒	Kod artykułu	d x L	☒	Kod artykułu
M22X120	10	07060.220.120	M27X60	10	07060.270.060	M33X70	2	07060.330.070
M22X130	10	07060.220.130	M27X70	10	07060.270.070	M33X80	2	07060.330.080
M22X140	10	07060.220.140	M27X80	10	07060.270.080	M33X90	2	07060.330.090
M22X150	10	07060.220.150	M27X90	10	07060.270.090	M33X100	2	07060.330.100
M22X160	10	07060.220.160	M27X100	10	07060.270.100	M33X120	2	07060.330.120
M22X180	5	07060.220.180	M27X120	10	07060.270.120	M33X130	2	07060.330.130
M22X200	5	07060.220.200	M27X130	10	07060.270.130	M33X140	2	07060.330.140
M24X40	10	07060.240.040	M27X140	10	07060.270.140	M33X160	2	07060.330.160
M24X45	10	07060.240.045	M27X160	10	07060.270.160	M33X180	2	07060.330.180
M24X50	10	07060.240.050	M27X180	10	07060.270.180	M33X200	2	07060.330.200
M24X55	10	07060.240.055	M27X200	10	07060.270.200	M36X60	1	07060.360.060
M24X60	10	07060.240.060	M30X60	5	07060.300.060	M36X80	1	07060.360.080
M24X65	10	07060.240.065	M30X70	5	07060.300.070	M36X100	1	07060.360.100
M24X70	10	07060.240.070	M30X80	5	07060.300.080	M36X110	1	07060.360.110
M24X75	5	07060.240.075	M30X90	2	07060.300.090	M36X120	1	07060.360.120
M24X80	10	07060.240.080	M30X100	2	07060.300.100	M36X140	1	07060.360.140
M24X90	10	07060.240.090	M30X110	2	07060.300.110	M36X160	1	07060.360.160
M24X100	10	07060.240.100	M30X120	2	07060.300.120	M36X180	1	07060.360.180
M24X110	10	07060.240.110	M30X130	2	07060.300.130	M36X200	1	07060.360.200
M24X120	5	07060.240.120	M30X140	2	07060.300.140	M36X220	1	07060.360.220
M24X130	5	07060.240.130	M30X150	2	07060.300.150	M36X240	1	07060.360.240
M24X140	5	07060.240.140	M30X160	2	07060.300.160	M36X260	1	07060.360.260
M24X150	5	07060.240.150	M30X170	2	07060.300.170	M36X280	1	07060.360.280
M24X160	5	07060.240.160	M30X180	2	07060.300.180	M36X300	1	07060.360.300
M24X180	5	07060.240.180	M30X190	2	07060.300.190	M42X100	1	07060.420.100
M24X190	5	07060.240.190	M30X200	2	07060.300.200	M42X120	1	07060.420.120
M24X200	5	07060.240.200	M30X220	2	07060.300.220	M42X140	1	07060.420.140
M24X220	5	07060.240.220	M30X240	2	07060.300.240	M42X160	1	07060.420.160
M24X240	5	07060.240.240	M30X260	2	07060.300.260	M42X180	1	07060.420.180
M24X260	5	07060.240.260	M30X280	2	07060.300.280	M42X200	1	07060.420.200
M24X280	5	07060.240.280	M30X300	2	07060.300.300	M42X240	1	07060.420.240
M24X300	5	07060.240.300				M42X280	1	07060.420.280
M24X320	5	07060.240.320						

07160 Śruby z łbem walcowym z gniazdem sześciokątnym D02A

Gwint Metryczny
 Materiał Stal
 Klasa 8.8
 Obróbka powierzchni O cynkowane



d x L	☒	Kod artykułu	d x L	☒	Kod artykułu	d x L	☒	Kod artykułu
M3X5	200	07160.030.005	M5X25	200	07160.050.025	M6X110	100	07160.060.110
M3X6	200	07160.030.006	M5X30	200	07160.050.030	M6X120	100	07160.060.120
M3X8	200	07160.030.008	M5X35	200	07160.050.035			
M3X10	200	07160.030.010	M5X40	200	07160.050.040	M8X10	200	07160.080.010
M3X12	200	07160.030.012	M5X45	200	07160.050.045	M8X12	200	07160.080.012
M3X16	200	07160.030.016	M5X50	200	07160.050.050	M8X14	200	07160.080.014
M3X18	200	07160.030.018	M5X55	200	07160.050.055	M8X16	200	07160.080.016
M3X20	200	07160.030.020	M5X60	200	07160.050.060	M8X18	200	07160.080.018
M3X25	200	07160.030.025	M5X70	200	07160.050.070	M8X20	200	07160.080.020
M3X30	200	07160.030.030	M5X80	200	07160.050.080	M8X22	200	07160.080.022
M3X35	200	07160.030.035	M5X90	200	07160.050.090	M8X25	200	07160.080.025
M3X40	200	07160.030.040	M5X100	200	07160.050.100	M8X30	200	07160.080.030
			M5X120	100	07160.050.120	M8X35	200	07160.080.035
M4X6	200	07160.040.006				M8X40	200	07160.080.040
M4X8	200	07160.040.008	M6X6	100	07160.060.006	M8X45	200	07160.080.045
M4X10	200	07160.040.010	M6X8	200	07160.060.008	M8X50	200	07160.080.050
M4X12	200	07160.040.012	M6X10	200	07160.060.010	M8X55	200	07160.080.055
M4X16	200	07160.040.016	M6X12	200	07160.060.012	M8X60	200	07160.080.060
M4X18	200	07160.040.018	M6X16	200	07160.060.016	M8X65	200	07160.080.065
M4X20	200	07160.040.020	M6X18	200	07160.060.018	M8X70	200	07160.080.070
M4X25	200	07160.040.025	M6X20	200	07160.060.020	M8X75	200	07160.080.075
M4X30	200	07160.040.030	M6X22	200	07160.060.022	M8X80	200	07160.080.080
M4X35	200	07160.040.035	M6X25	200	07160.060.025	M8X85	100	07160.080.085
M4X40	200	07160.040.040	M6X30	200	07160.060.030	M8X90	100	07160.080.090
M4X45	200	07160.040.045	M6X35	200	07160.060.035	M8X100	100	07160.080.100
M4X50	200	07160.040.050	M6X40	200	07160.060.040	M8X110	100	07160.080.110
M4X60	200	07160.040.060	M6X45	200	07160.060.045	M8X120	100	07160.080.120
M4X70	200	07160.040.070	M6X50	200	07160.060.050	M8X130	50	07160.080.130
			M6X55	200	07160.060.055	M8X140	50	07160.080.140
M5X6	200	07160.050.006	M6X60	200	07160.060.060	M8X160	50	07160.080.160
M5X8	200	07160.050.008	M6X65	200	07160.060.065			
M5X10	200	07160.050.010	M6X70	200	07160.060.070	M10X12	200	07160.100.012
M5X12	200	07160.050.012	M6X75	200	07160.060.075	M10X16	200	07160.100.016
M5X16	200	07160.050.016	M6X80	200	07160.060.080	M10X20	200	07160.100.020
M5X18	200	07160.050.018	M6X90	100	07160.060.090	M10X25	200	07160.100.025
M5X20	200	07160.050.020	M6X100	100	07160.060.100	M10X30	200	07160.100.030

07160 Śruby z łbem walcowym z gniazdem sześciokątnym

d x L	☒	Kod artykułu	d x L	☒	Kod artykułu	d x L	☒	Kod artykułu
M10X35	100	07160.100.035	M14X55	50	07160.140.055	M20X90	25	07160.200.090
M10X40	100	07160.100.040	M14X60	50	07160.140.060	M20X100	25	07160.200.100
M10X45	100	07160.100.045	M14X65	50	07160.140.065	M20X110	25	07160.200.110
M10X50	100	07160.100.050	M14X70	50	07160.140.070	M20X120	25	07160.200.120
M10X55	100	07160.100.055	M14X80	50	07160.140.080	M20X130	25	07160.200.130
M10X60	100	07160.100.060	M14X90	50	07160.140.090	M20X140	25	07160.200.140
M10X65	100	07160.100.065	M14X100	50	07160.140.100	M20X160	10	07160.200.160
M10X70	100	07160.100.070	M14X110	50	07160.140.110	M20X180	10	07160.200.180
M10X75	100	07160.100.075	M14X120	25	07160.140.120	M20X200	10	07160.200.200
M10X80	100	07160.100.080	M14X180	25	07160.140.180			
M10X85	100	07160.100.085				M22X50	10	07160.220.050
M10X90	100	07160.100.090	M16X20	50	07160.160.020	M22X60	10	07160.220.060
M10X100	50	07160.100.100	M16X25	50	07160.160.025	M22X70	10	07160.220.070
M10X110	50	07160.100.110	M16X30	50	07160.160.030	M22X80	10	07160.220.080
M10X120	50	07160.100.120	M16X35	50	07160.160.035	M22X100	10	07160.220.100
M10X130	50	07160.100.130	M16X40	50	07160.160.040			
M10X140	50	07160.100.140	M16X45	50	07160.160.045	M24X40	10	07160.240.040
M10X160	25	07160.100.160	M16X50	50	07160.160.050	M24X50	10	07160.240.050
M10X180	25	07160.100.180	M16X55	50	07160.160.055	M24X60	10	07160.240.060
			M16X60	50	07160.160.060	M24X65	10	07160.240.065
M12X16	100	07160.120.016	M16X65	50	07160.160.065	M24X70	10	07160.240.070
M12X20	100	07160.120.020	M16X70	25	07160.160.070	M24X75	10	07160.240.075
M12X25	100	07160.120.025	M16X80	25	07160.160.080	M24X80	10	07160.240.080
M12X30	100	07160.120.030	M16X90	25	07160.160.090	M24X90	10	07160.240.090
M12X35	100	07160.120.035	M16X100	25	07160.160.100	M24X100	10	07160.240.100
M12X40	100	07160.120.040	M16X110	25	07160.160.110	M24X110	10	07160.240.110
M12X45	100	07160.120.045	M16X120	25	07160.160.120	M24X120	5	07160.240.120
M12X50	100	07160.120.050	M16X130	25	07160.160.130	M24X140	5	07160.240.140
M12X55	100	07160.120.055	M16X140	25	07160.160.140	M24X160	5	07160.240.160
M12X60	100	07160.120.060	M16X150	50	07160.160.150	M24X180	5	07160.240.180
M12X65	50	07160.120.065	M16X160	25	07160.160.160	M24X200	5	07160.240.200
M12X70	50	07160.120.070	M16X180	10	07160.160.180			
M12X75	50	07160.120.075	M16X200	10	07160.160.200	M27X60	10	07160.270.060
M12X80	50	07160.120.080				M27X80	10	07160.270.080
M12X85	50	07160.120.085	M18X40	25	07160.180.040	M27X100	10	07160.270.100
M12X90	50	07160.120.090	M18X50	25	07160.180.050			
M12X100	50	07160.120.100	M18X60	25	07160.180.060	M30X80	5	07160.300.080
M12X110	50	07160.120.110	M18X80	25	07160.180.080	M30X100	2	07160.300.100
M12X120	25	07160.120.120	M18X100	25	07160.180.100	M30X120	2	07160.300.120
M12X130	25	07160.120.130	M18X120	10	07160.180.120	M30X140	2	07160.300.140
M12X140	25	07160.120.140				M30X160	2	07160.300.160
M12X150	25	07160.120.150	M20X30	25	07160.200.030	M30X180	2	07160.300.180
M12X160	25	07160.120.160	M20X40	25	07160.200.040	M30X200	1	07160.300.200
M12X180	25	07160.120.180	M20X45	25	07160.200.045			
			M20X50	25	07160.200.050	M36X100	1	07160.360.100
M14X30	100	07160.140.030	M20X55	25	07160.200.055	M36X120	1	07160.360.120
M14X35	100	07160.140.035	M20X60	25	07160.200.060	M36X160	1	07160.360.160
M14X40	100	07160.140.040	M20X65	25	07160.200.065	M36X200	1	07160.360.200
M14X45	50	07160.140.045	M20X70	25	07160.200.070	M36X240	1	07160.360.240
M14X50	50	07160.140.050	M20X80	25	07160.200.080			

07170 Śruby z łbem walcowym z gniazdem sześciokątnym
D02A

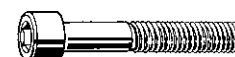

Gwint Metryczny
Materiał Stal
Klasa 8.8
Obróbka powierzchni Ocynkowane, po żółtej pasywacji



d x L	☒	Kod artykułu	d x L	☒	Kod artykułu	d x L	☒	Kod artykułu
M4X6	200	07170.040.006	M5X50	200	07170.050.050	M8X35	200	07170.080.035
M4X8	200	07170.040.008				M8X40	200	07170.080.040
M4X10	200	07170.040.010	M6X10	200	07170.060.010	M8X45	200	07170.080.045
M4X12	200	07170.040.012	M6X12	200	07170.060.012	M8X50	200	07170.080.050
M4X16	200	07170.040.016	M6X16	200	07170.060.016	M8X55	200	07170.080.055
M4X20	200	07170.040.020	M6X20	200	07170.060.020	M8X60	200	07170.080.060
M4X25	200	07170.040.025	M6X25	200	07170.060.025	M8X70	200	07170.080.070
M4X30	200	07170.040.030	M6X30	200	07170.060.030	M8X80	200	07170.080.080
M4X35	200	07170.040.035	M6X35	200	07170.060.035	M8X90	50	07170.080.090
M4X40	200	07170.040.040	M6X40	200	07170.060.040	M8X100	200	07170.080.100
			M6X45	200	07170.060.045			
M5X10	200	07170.050.010	M6X50	200	07170.060.050	M10X16	200	07170.100.016
M5X12	200	07170.050.012	M6X60	200	07170.060.060	M10X20	200	07170.100.020
M5X16	200	07170.050.016	M6X70	200	07170.060.070	M10X25	200	07170.100.025
M5X20	200	07170.050.020	M6X80	200	07170.060.080	M10X30	200	07170.100.030
M5X25	200	07170.050.025				M10X35	100	07170.100.035
M5X30	200	07170.050.030	M8X16	200	07170.080.016	M10X40	100	07170.100.040
M5X35	200	07170.050.035	M8X20	200	07170.080.020	M10X45	100	07170.100.045
M5X40	200	07170.050.040	M8X25	200	07170.080.025	M10X50	100	07170.100.050
M5X45	200	07170.050.045	M8X30	200	07170.080.030	M10X60	100	07170.100.060

07170 Śruby z łbem walcowym z gniazdem sześciokątnym								
d x L	☒	Kod artykułu	d x L	☒	Kod artykułu	d x L	☒	Kod artykułu
M10X70	100	07170.100.070	M12X25	100	07170.120.025	M12X60	100	07170.120.060
M10X80	100	07170.100.080	M12X30	100	07170.120.030	M12X70	50	07170.120.070
M10X100	50	07170.100.100	M12X35	100	07170.120.035	M12X80	50	07170.120.080
			M12X40	100	07170.120.040	M12X100	50	07170.120.100
M12X20	100	07170.120.020	M12X50	100	07170.120.050	M12X120	25	07170.120.120

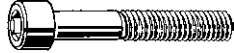
07065 Śruby z łbem walcowym z gniazdem sześciokątnym		A96A
Gwint	Metryczny	
Materiał	Stal	
Klasa	8.8	
Obróbka powierzchni	O cynk plątkowy bez Cr6+ wg ISO 10683 (flZnnc)	

d x L	☒	Kod artykułu	d x L	☒	Kod artykułu	d x L	☒	Kod artykułu
M3X10	200	07065.030.010	M6X20	200	07065.060.020	M10X35	100	07065.100.035
M3X12	200	07065.030.012	M6X25	200	07065.060.025	M10X40	100	07065.100.040
M3X16	200	07065.030.016	M6X30	200	07065.060.030	M10X45	100	07065.100.045
M3X20	200	07065.030.020	M6X35	200	07065.060.035	M10X50	100	07065.100.050
			M6X40	200	07065.060.040	M10X55	100	07065.100.055
M4X8	200	07065.040.008	M6X45	200	07065.060.045	M10X60	100	07065.100.060
M4X10	200	07065.040.010	M6X50	200	07065.060.050	M10X70	100	07065.100.070
M4X12	200	07065.040.012	M6X55	200	07065.060.055	M10X80	100	07065.100.080
M4X16	200	07065.040.016	M6X60	200	07065.060.060	M10X90	100	07065.100.090
M4X20	200	07065.040.020	M6X65	200	07065.060.065			
M4X25	200	07065.040.025	M6X70	200	07065.060.070	M12X20	100	07065.120.020
M4X30	200	07065.040.030	M6X80	200	07065.060.080	M12X25	100	07065.120.025
M4X40	200	07065.040.040	M6X90	100	07065.060.090	M12X30	100	07065.120.030
M4X50	200	07065.040.050				M12X35	100	07065.120.035
			M8X10	200	07065.080.010	M12X40	100	07065.120.040
M5X10	200	07065.050.010	M8X12	200	07065.080.012	M12X45	100	07065.120.045
M5X12	200	07065.050.012	M8X16	200	07065.080.016	M12X50	100	07065.120.050
M5X16	200	07065.050.016	M8X20	200	07065.080.020	M12X55	100	07065.120.055
M5X20	200	07065.050.020	M8X25	200	07065.080.025	M12X60	100	07065.120.060
M5X25	200	07065.050.025	M8X30	200	07065.080.030	M12X65	50	07065.120.065
M5X30	200	07065.050.030	M8X35	200	07065.080.035	M12X70	50	07065.120.070
M5X40	200	07065.050.040	M8X40	200	07065.080.040	M12X80	50	07065.120.080
M5X45	200	07065.050.045	M8X45	200	07065.080.045	M12X90	50	07065.120.090
M5X50	200	07065.050.050	M8X50	200	07065.080.050	M12X100	50	07065.120.100
M5X55	200	07065.050.055	M8X60	200	07065.080.060			
M5X60	200	07065.050.060	M8X70	200	07065.080.070	M16X40	50	07065.160.040
M5X70	200	07065.050.070	M8X80	200	07065.080.080	M16X50	50	07065.160.050
M5X80	200	07065.050.080	M8X90	100	07065.080.090	M16X60	50	07065.160.060
M5X90	200	07065.050.090				M16X70	25	07065.160.070
			M10X20	200	07065.100.020	M16X80	25	07065.160.080
M6X10	200	07065.060.010	M10X25	200	07065.100.025	M16X90	25	07065.160.090
M6X12	200	07065.060.012	M10X30	200	07065.100.030	M16X100	25	07065.160.100
M6X16	200	07065.060.016						

• Powlekanie powierzchniowe ISO 10683 cynkowanie plątkowe eliminuje możliwości uszkodzenia, jakie może wywołać kruchość wodorowa.

07015 Śruby z łbem walcowym z gniazdem sześciokątnym		D03A
Gwint	Metryczny	
Materiał	Stal	
Klasa	10.9	



d x L	☒	Kod artykułu	d x L	☒	Kod artykułu	d x L	☒	Kod artykułu
M5X10	500	07015.050.010	M6X35	200	07015.060.035	M8X60	200	07015.080.060
M5X12	500	07015.050.012	M6X40	200	07015.060.040	M8X70	200	07015.080.070
M5X16	500	07015.050.016	M6X45	200	07015.060.045	M8X80	100	07015.080.080
M5X20	500	07015.050.020	M6X50	200	07015.060.050	M8X90	100	07015.080.090
M5X25	500	07015.050.025	M6X60	200	07015.060.060	M8X100	100	07015.080.100
M5X30	500	07015.050.030	M6X70	200	07015.060.070			
M5X35	200	07015.050.035	M6X80	100	07015.060.080	M10X20	200	07015.100.020
M5X40	200	07015.050.040	M6X90	100	07015.060.090	M10X25	200	07015.100.025
M5X45	200	07015.050.045	M6X140	50	07015.060.140	M10X30	200	07015.100.030
M5X50	200	07015.050.050				M10X35	100	07015.100.035
M5X60	200	07015.050.060	M8X16	200	07015.080.016	M10X40	100	07015.100.040
			M8X20	200	07015.080.020	M10X45	100	07015.100.045
M6X10	500	07015.060.010	M8X25	200	07015.080.025	M10X50	100	07015.100.050
M6X12	500	07015.060.012	M8X30	200	07015.080.030	M10X60	100	07015.100.060
M6X16	500	07015.060.016	M8X35	200	07015.080.035	M10X65	100	07015.100.065
M6X20	500	07015.060.020	M8X40	200	07015.080.040	M10X70	100	07015.100.070
M6X25	500	07015.060.025	M8X45	200	07015.080.045	M10X80	100	07015.100.080
M6X30	500	07015.060.030	M8X50	200	07015.080.050	M10X85	100	07015.100.085

07015 Śruby z łbem walcowym z gniazdem sześciokątnym								
d x L	☒	Kod artykułu	d x L	☒	Kod artykułu	d x L	☒	Kod artykułu
M10X90	50	07015.100.090				M20X100	25	07015.200.100
M10X100	50	07015.100.100	M16X30	50	07015.160.030	M20X120	25	07015.200.120
M10X120	50	07015.100.120	M16X40	50	07015.160.040	M20X130	25	07015.200.130
M10X130	50	07015.100.130	M16X50	50	07015.160.050	M20X140	25	07015.200.140
			M16X60	50	07015.160.060	M20X190	10	07015.200.190
M12X25	100	07015.120.025	M16X70	25	07015.160.070	M20X230	5	07015.200.230
M12X30	100	07015.120.030	M16X80	25	07015.160.080			
M12X35	100	07015.120.035	M16X90	25	07015.160.090	M24X50	10	07015.240.050
M12X40	100	07015.120.040	M16X100	25	07015.160.100	M24X60	10	07015.240.060
M12X50	100	07015.120.050	M16X120	25	07015.160.120	M24X70	10	07015.240.070
M12X55	100	07015.120.055	M16X130	25	07015.160.130	M24X80	10	07015.240.080
M12X60	100	07015.120.060	M16X160	25	07015.160.160	M24X90	10	07015.240.090
M12X65	50	07015.120.065				M24X100	10	07015.240.100
M12X70	50	07015.120.070	M20X40	25	07015.200.040	M24X120	5	07015.240.120
M12X80	50	07015.120.080	M20X50	25	07015.200.050			
M12X90	50	07015.120.090	M20X60	25	07015.200.060	M27X90	10	07015.270.090
M12X100	50	07015.120.100	M20X70	25	07015.200.070	M27X130	5	07015.270.130
M12X110	50	07015.120.110	M20X80	25	07015.200.080			
M12X120	50	07015.120.120	M20X90	25	07015.200.090			

• Ostrzeżenie: cynkowanie elektrolityczne tych produktów może wywołać kruchość wodorową.

07000 Śruby z łbem walcowym z gniazdem sześciokątnym		D01A
Gwint	Metryczny	
Material	Stal	
Klasa	12.9	



d x L	☒	Kod artykułu	d x L	☒	Kod artykułu	d x L	☒	Kod artykułu
M1,6X3	100	07000.016.003	M4X10	200	07000.040.010	M5X110	200	07000.050.110
M1,6X4	100	07000.016.004	M4X12	200	07000.040.012	M5X115	100	07000.050.115
M1,6X5	100	07000.016.005	M4X14	200	07000.040.014	M5X120	100	07000.050.120
M1,6X6	100	07000.016.006	M4X16	200	07000.040.016	M5X125	100	07000.050.125
			M4X18	200	07000.040.018	M5X130	50	07000.050.130
M2X3	100	07000.020.003	M4X20	200	07000.040.020	M5X135	200	07000.050.135
M2X4	100	07000.020.004	M4X22	200	07000.040.022	M5X140	25	07000.050.140
M2X5	100	07000.020.005	M4X25	200	07000.040.025	M5X150	25	07000.050.150
M2X6	100	07000.020.006	M4X30	200	07000.040.030	M5X160	25	07000.050.160
M2X8	100	07000.020.008	M4X35	200	07000.040.035	M5X170	25	07000.050.170
M2X10	100	07000.020.010	M4X40	200	07000.040.040	M5X180	25	07000.050.180
M2X12	100	07000.020.012	M4X45	200	07000.040.045	M5X190	25	07000.050.190
M2X14	100	07000.020.014	M4X50	200	07000.040.050	M5X200	25	07000.050.200
M2X16	100	07000.020.016	M4X55	200	07000.040.055			
M2X20	100	07000.020.020	M4X60	200	07000.040.060	M6X6	500	07000.060.006
			M4X65	200	07000.040.065	M6X8	200	07000.060.008
M2,5X3	100	07000.025.003	M4X70	200	07000.040.070	M6X10	200	07000.060.010
M2,5X4	100	07000.025.004	M4X75	200	07000.040.075	M6X12	200	07000.060.012
M2,5X5	100	07000.025.005	M4X80	200	07000.040.080	M6X14	200	07000.060.014
M2,5X6	100	07000.025.006	M4X90	200	07000.040.090	M6X16	200	07000.060.016
M2,5X8	100	07000.025.008	M4X100	100	07000.040.100	M6X18	200	07000.060.018
M2,5X10	100	07000.025.010	M4X110	100	07000.040.110	M6X20	200	07000.060.020
M2,5X12	100	07000.025.012	M4X120	100	07000.040.120	M6X22	200	07000.060.022
M2,5X14	100	07000.025.014				M6X25	200	07000.060.025
M2,5X16	100	07000.025.016	M5X6	200	07000.050.006	M6X30	200	07000.060.030
M2,5X20	100	07000.025.020	M5X8	200	07000.050.008	M6X35	200	07000.060.035
M2,5X25	100	07000.025.025	M5X10	200	07000.050.010	M6X40	200	07000.060.040
			M5X12	200	07000.050.012	M6X45	200	07000.060.045
M3X4	200	07000.030.004	M5X14	200	07000.050.014	M6X50	200	07000.060.050
M3X6	200	07000.030.006	M5X16	200	07000.050.016	M6X55	200	07000.060.055
M3X8	200	07000.030.008	M5X18	200	07000.050.018	M6X60	200	07000.060.060
M3X10	200	07000.030.010	M5X20	200	07000.050.020	M6X65	200	07000.060.065
M3X12	200	07000.030.012	M5X22	200	07000.050.022	M6X70	200	07000.060.070
M3X14	200	07000.030.014	M5X25	200	07000.050.025	M6X75	200	07000.060.075
M3X16	200	07000.030.016	M5X30	200	07000.050.030	M6X80	200	07000.060.080
M3X18	200	07000.030.018	M5X35	200	07000.050.035	M6X85	100	07000.060.085
M3X20	200	07000.030.020	M5X40	200	07000.050.040	M6X90	100	07000.060.090
M3X22	200	07000.030.022	M5X45	200	07000.050.045	M6X95	100	07000.060.095
M3X25	200	07000.030.025	M5X50	200	07000.050.050	M6X100	100	07000.060.100
M3X30	200	07000.030.030	M5X55	200	07000.050.055	M6X110	50	07000.060.110
M3X35	200	07000.030.035	M5X60	200	07000.050.060	M6X115	50	07000.060.115
M3X40	200	07000.030.040	M5X65	200	07000.050.065	M6X120	50	07000.060.120
M3X45	200	07000.030.045	M5X70	200	07000.050.070	M6X125	50	07000.060.125
M3X50	200	07000.030.050	M5X75	200	07000.050.075	M6X130	50	07000.060.130
M3X60	200	07000.030.060	M5X80	200	07000.050.080	M6X135	50	07000.060.135
			M5X85	200	07000.050.085	M6X140	25	07000.060.140
M4X5	200	07000.040.005	M5X90	200	07000.050.090	M6X150	25	07000.060.150
M4X6	200	07000.040.006	M5X95	200	07000.050.095	M6X160	25	07000.060.160
M4X8	200	07000.040.008	M5X100	200	07000.050.100	M6X165	25	07000.060.165

07000 Śruby z łbem walcowym z gniazdem sześciokątnym

d x L	☒	Kod artykułu	d x L	☒	Kod artykułu	d x L	☒	Kod artykułu
M6X170	25	07000.060.170	M12X50	100	07000.120.050	M16X260	5	07000.160.260
M6X180	25	07000.060.180	M12X55	100	07000.120.055	M16X270	5	07000.160.270
M6X190	25	07000.060.190	M12X60	100	07000.120.060	M16X280	5	07000.160.280
M6X200	25	07000.060.200	M12X65	50	07000.120.065	M16X300	5	07000.160.300
			M12X70	50	07000.120.070	M16X320	5	07000.160.320
			M12X75	50	07000.120.075			
M8X10	200	07000.080.010	M12X80	50	07000.120.080	M18X35	50	07000.180.035
M8X12	200	07000.080.012	M12X85	50	07000.120.085	M18X40	50	07000.180.040
M8X14	200	07000.080.014	M12X90	50	07000.120.090	M18X45	50	07000.180.045
M8X16	200	07000.080.016	M12X100	50	07000.120.100	M18X50	50	07000.180.050
M8X18	200	07000.080.018	M12X110	50	07000.120.110	M18X60	25	07000.180.060
M8X20	200	07000.080.020	M12X120	50	07000.120.120	M18X70	25	07000.180.070
M8X22	200	07000.080.022	M12X130	25	07000.120.130	M18X80	25	07000.180.080
M8X25	200	07000.080.025	M12X140	25	07000.120.140	M18X90	25	07000.180.090
M8X30	200	07000.080.030	M12X150	25	07000.120.150	M18X100	25	07000.180.100
M8X35	200	07000.080.035	M12X160	25	07000.120.160	M18X110	25	07000.180.110
M8X40	200	07000.080.040	M12X170	25	07000.120.170	M18X120	25	07000.180.120
M8X45	200	07000.080.045	M12X180	10	07000.120.180	M18X140	25	07000.180.140
M8X50	200	07000.080.050	M12X200	10	07000.120.200	M18X160	10	07000.180.160
M8X55	200	07000.080.055	M12X210	10	07000.120.210	M18X180	10	07000.180.180
M8X60	200	07000.080.060	M12X220	10	07000.120.220	M18X190	10	07000.180.190
M8X65	200	07000.080.065	M12X230	10	07000.120.230	M18X200	10	07000.180.200
M8X70	200	07000.080.070	M12X240	10	07000.120.240	M18X220	10	07000.180.220
M8X75	200	07000.080.075	M12X260	10	07000.120.260			
M8X80	200	07000.080.080	M12X280	10	07000.120.280	M20X30	25	07000.200.030
M8X85	100	07000.080.085	M12X300	10	07000.120.300	M20X35	25	07000.200.035
M8X90	100	07000.080.090				M20X40	25	07000.200.040
M8X100	100	07000.080.100	M14X20	100	07000.140.020	M20X45	25	07000.200.045
M8X110	50	07000.080.110	M14X25	100	07000.140.025	M20X50	25	07000.200.050
M8X120	50	07000.080.120	M14X30	100	07000.140.030	M20X55	25	07000.200.055
M8X130	50	07000.080.130	M14X35	100	07000.140.035	M20X60	25	07000.200.060
M8X140	50	07000.080.140	M14X40	100	07000.140.040	M20X65	25	07000.200.065
M8X150	50	07000.080.150	M14X45	50	07000.140.045	M20X70	25	07000.200.070
M8X160	50	07000.080.160	M14X50	50	07000.140.050	M20X75	25	07000.200.075
M8X170	50	07000.080.170	M14X55	50	07000.140.055	M20X80	25	07000.200.080
M8X180	50	07000.080.180	M14X60	50	07000.140.060	M20X90	25	07000.200.090
M8X200	50	07000.080.200	M14X65	50	07000.140.065	M20X100	25	07000.200.100
			M14X70	50	07000.140.070	M20X110	25	07000.200.110
M10X12	200	07000.100.012	M14X75	50	07000.140.075	M20X120	25	07000.200.120
M10X16	200	07000.100.016	M14X80	50	07000.140.080	M20X130	25	07000.200.130
M10X20	200	07000.100.020	M14X90	50	07000.140.090	M20X140	25	07000.200.140
M10X25	200	07000.100.025	M14X100	50	07000.140.100	M20X150	10	07000.200.150
M10X30	200	07000.100.030	M14X110	25	07000.140.110	M20X160	10	07000.200.160
M10X35	100	07000.100.035	M14X120	25	07000.140.120	M20X170	10	07000.200.170
M10X40	100	07000.100.040	M14X130	25	07000.140.130	M20X180	10	07000.200.180
M10X45	100	07000.100.045	M14X140	25	07000.140.140	M20X190	10	07000.200.190
M10X50	100	07000.100.050	M14X150	25	07000.140.150	M20X200	10	07000.200.200
M10X55	100	07000.100.055	M14X160	25	07000.140.160	M20X210	10	07000.200.210
M10X60	100	07000.100.060	M14X180	10	07000.140.180	M20X220	5	07000.200.220
M10X65	100	07000.100.065	M14X200	10	07000.140.200	M20X240	5	07000.200.240
M10X70	100	07000.100.070				M20X250	5	07000.200.250
M10X75	100	07000.100.075	M16X20	50	07000.160.020	M20X260	5	07000.200.260
M10X80	100	07000.100.080	M16X25	50	07000.160.025	M20X280	5	07000.200.280
M10X85	100	07000.100.085	M16X30	50	07000.160.030	M20X300	5	07000.200.300
M10X90	100	07000.100.090	M16X35	50	07000.160.035	M20X320	5	07000.200.320
M10X100	50	07000.100.100	M16X40	50	07000.160.040	M20X340	5	07000.200.340
M10X110	50	07000.100.110	M16X45	50	07000.160.045	M20X360	5	07000.200.360
M10X120	50	07000.100.120	M16X50	50	07000.160.050	M20X380	5	07000.200.380
M10X130	50	07000.100.130	M16X55	50	07000.160.055	M20X400	5	07000.200.400
M10X140	25	07000.100.140	M16X60	50	07000.160.060			
M10X150	25	07000.100.150	M16X65	25	07000.160.065	M22X40	10	07000.220.040
M10X160	25	07000.100.160	M16X70	25	07000.160.070	M22X50	10	07000.220.050
M10X170	25	07000.100.170	M16X75	25	07000.160.075	M22X60	10	07000.220.060
M10X180	25	07000.100.180	M16X80	25	07000.160.080	M22X70	10	07000.220.070
M10X190	25	07000.100.190	M16X85	25	07000.160.085	M22X80	10	07000.220.080
M10X200	25	07000.100.200	M16X90	25	07000.160.090	M22X90	10	07000.220.090
M10X210	25	07000.100.210	M16X100	25	07000.160.100	M22X100	10	07000.220.100
M10X220	25	07000.100.220	M16X110	25	07000.160.110	M22X110	10	07000.220.110
M10X230	25	07000.100.230	M16X120	25	07000.160.120	M22X120	10	07000.220.120
M10X240	10	07000.100.240	M16X130	25	07000.160.130	M22X140	10	07000.220.140
M10X250	10	07000.100.250	M16X140	25	07000.160.140	M22X150	10	07000.220.150
M10X260	10	07000.100.260	M16X150	10	07000.160.150	M22X160	10	07000.220.160
M10X270	10	07000.100.270	M16X160	10	07000.160.160	M22X180	10	07000.220.180
M10X280	10	07000.100.280	M16X170	10	07000.160.170	M22X200	10	07000.220.200
M10X300	10	07000.100.300	M16X180	10	07000.160.180	M22X210	5	07000.220.210
			M16X190	25	07000.160.190	M22X240	5	07000.220.240
M12X16	100	07000.120.016	M16X200	10	07000.160.200	M22X260	5	07000.220.260
M12X20	100	07000.120.020	M16X210	10	07000.160.210	M22X300	5	07000.220.300
M12X25	100	07000.120.025	M16X220	10	07000.160.220			
M12X30	100	07000.120.030	M16X230	5	07000.160.230	M24X40	10	07000.240.040
M12X35	100	07000.120.035	M16X240	5	07000.160.240	M24X45	10	07000.240.045
M12X40	100	07000.120.040	M16X250	5	07000.160.250	M24X50	10	07000.240.050
M12X45	100	07000.120.045						

07000 Śruby z łbem walcowym z gniazdem sześciokątnym

d x L	☒	Kod artykułu	d x L	☒	Kod artykułu	d x L	☒	Kod artykułu
M24X55	10	07000.240.055	M27X190	2	07000.270.190	M36X90	1	07000.360.090
M24X60	10	07000.240.060	M27X200	2	07000.270.200	M36X100	1	07000.360.100
M24X65	10	07000.240.065	M27X220	2	07000.270.220	M36X120	1	07000.360.120
M24X70	10	07000.240.070	M27X240	2	07000.270.240	M36X140	1	07000.360.140
M24X75	10	07000.240.075	M27X260	2	07000.270.260	M36X160	1	07000.360.160
M24X80	10	07000.240.080	M27X300	2	07000.270.300	M36X180	1	07000.360.180
M24X85	10	07000.240.085				M36X200	1	07000.360.200
M24X90	10	07000.240.090	M30X60	2	07000.300.060	M36X220	1	07000.360.220
M24X100	10	07000.240.100	M30X70	2	07000.300.070	M36X240	1	07000.360.240
M24X110	10	07000.240.110	M30X80	2	07000.300.080	M36X260	1	07000.360.260
M24X120	5	07000.240.120	M30X90	2	07000.300.090	M36X280	1	07000.360.280
M24X130	5	07000.240.130	M30X100	2	07000.300.100	M36X300	1	07000.360.300
M24X140	5	07000.240.140	M30X110	2	07000.300.110	M36X400	1	07000.360.400
M24X150	5	07000.240.150	M30X120	2	07000.300.120	M36X420	1	07000.360.420
M24X160	5	07000.240.160	M30X130	2	07000.300.130			
M24X170	5	07000.240.170	M30X140	2	07000.300.140	M39X80	1	07000.390.080
M24X180	5	07000.240.180	M30X150	2	07000.300.150	M39X90	1	07000.390.090
M24X200	5	07000.240.200	M30X160	2	07000.300.160	M39X100	1	07000.390.100
M24X210	2	07000.240.210	M30X170	2	07000.300.170	M39X120	1	07000.390.120
M24X220	2	07000.240.220	M30X180	2	07000.300.180	M39X140	1	07000.390.140
M24X240	2	07000.240.240	M30X200	2	07000.300.200	M39X160	1	07000.390.160
M24X250	2	07000.240.250	M30X210	2	07000.300.210	M39X180	1	07000.390.180
M24X260	2	07000.240.260	M30X220	2	07000.300.220	M39X200	1	07000.390.200
M24X280	2	07000.240.280	M30X240	2	07000.300.240			
M24X300	2	07000.240.300	M30X250	2	07000.300.250	M42X90	1	07000.420.090
M24X320	2	07000.240.320	M30X260	2	07000.300.260	M42X100	1	07000.420.100
M24X340	2	07000.240.340	M30X280	2	07000.300.280	M42X120	1	07000.420.120
M24X360	2	07000.240.360	M30X300	2	07000.300.300	M42X140	1	07000.420.140
M24X380	2	07000.240.380	M30X400	1	07000.300.400	M42X160	1	07000.420.160
M24X400	2	07000.240.400				M42X180	1	07000.420.180
			M33X70	2	07000.330.070	M42X200	1	07000.420.200
M27X50	2	07000.270.050	M33X80	2	07000.330.080	M42X240	1	07000.420.240
M27X60	2	07000.270.060	M33X90	2	07000.330.090	M42X260	1	07000.420.260
M27X70	2	07000.270.070	M33X100	2	07000.330.100	M42X300	1	07000.420.300
M27X75	2	07000.270.075	M33X120	2	07000.330.120			
M27X80	2	07000.270.080	M33X130	2	07000.330.130	M48X120	1	07000.480.120
M27X90	2	07000.270.090	M33X140	2	07000.330.140	M48X140	1	07000.480.140
M27X100	2	07000.270.100	M33X160	2	07000.330.160	M48X150	1	07000.480.150
M27X120	2	07000.270.120	M33X180	2	07000.330.180	M48X160	1	07000.480.160
M27X130	2	07000.270.130	M33X200	2	07000.330.200	M48X180	1	07000.480.180
M27X140	2	07000.270.140	M33X260	1	07000.330.260	M48X200	1	07000.480.200
M27X150	2	07000.270.150	M33X280	1	07000.330.280	M48X260	1	07000.480.260
M27X160	2	07000.270.160				M48X300	1	07000.480.300
M27X170	2	07000.270.170	M36X60	1	07000.360.060			
M27X180	2	07000.270.180	M36X80	1	07000.360.080			

• Ostrzeżenie: cynkowanie elektrolityczne tych produktów może wywołać kruchość wodorową.

07025 Śruby z łbem walcowym z gniazdem sześciokątnym
D95A

Gwint Metryczny
Material Stal
Klasa 12.9
Obróbka powierzchni Ocynk płatkowy bez Cr6+ wg ISO 10683 (flZnnc)

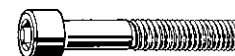

d x L	☒	Kod artykułu	d x L	☒	Kod artykułu	d x L	☒	Kod artykułu
M3X6	200	07025.030.006	M5X10	200	07025.050.010	M6X45	200	07025.060.045
M3X8	200	07025.030.008	M5X12	200	07025.050.012	M6X50	200	07025.060.050
M3X10	200	07025.030.010	M5X16	200	07025.050.016	M6X55	200	07025.060.055
M3X12	200	07025.030.012	M5X20	200	07025.050.020	M6X60	200	07025.060.060
M3X16	200	07025.030.016	M5X25	200	07025.050.025	M6X65	200	07025.060.065
M3X20	200	07025.030.020	M5X30	200	07025.050.030	M6X70	200	07025.060.070
M3X25	200	07025.030.025	M5X35	200	07025.050.035	M6X75	200	07025.060.075
M3X30	200	07025.030.030	M5X40	200	07025.050.040	M6X80	200	07025.060.080
M3X35	200	07025.030.035	M5X45	200	07025.050.045	M6X100	100	07025.060.100
			M5X50	200	07025.050.050	M6X130	50	07025.060.130
M4X6	200	07025.040.006	M5X60	200	07025.050.060	M6X140	25	07025.060.140
M4X8	200	07025.040.008	M5X70	200	07025.050.070			
M4X10	200	07025.040.010	M5X100	200	07025.050.100	M8X10	200	07025.080.010
M4X12	200	07025.040.012				M8X12	200	07025.080.012
M4X16	200	07025.040.016	M6X10	200	07025.060.010	M8X16	200	07025.080.016
M4X20	200	07025.040.020	M6X12	200	07025.060.012	M8X20	200	07025.080.020
M4X25	200	07025.040.025	M6X16	200	07025.060.016	M8X25	200	07025.080.025
M4X30	200	07025.040.030	M6X18	200	07025.060.018	M8X30	200	07025.080.030
M4X45	200	07025.040.045	M6X20	200	07025.060.020	M8X35	200	07025.080.035
M4X50	200	07025.040.050	M6X25	200	07025.060.025	M8X40	200	07025.080.040
			M6X30	200	07025.060.030	M8X45	200	07025.080.045
M5X6	200	07025.050.006	M6X35	200	07025.060.035	M8X50	200	07025.080.050
M5X8	200	07025.050.008	M6X40	200	07025.060.040	M8X55	200	07025.080.055

07025 Śruby z łbem walcowym z gniazdem sześciokątnym

d x L	☒	Kod artykułu	d x L	☒	Kod artykułu	d x L	☒	Kod artykułu
M8X60	200	07025.080.060	M12X25	100	07025.120.025	M16X50	50	07025.160.050
M8X70	200	07025.080.070	M12X30	100	07025.120.030	M16X55	50	07025.160.055
M8X80	200	07025.080.080	M12X35	100	07025.120.035	M16X60	50	07025.160.060
M8X90	100	07025.080.090	M12X40	100	07025.120.040	M16X70	25	07025.160.070
M8X100	100	07025.080.100	M12X45	100	07025.120.045	M16X75	25	07025.160.075
M8X110	50	07025.080.110	M12X50	100	07025.120.050	M16X80	25	07025.160.080
M8X140	50	07025.080.140	M12X55	100	07025.120.055	M16X90	25	07025.160.090
			M12X60	100	07025.120.060	M16X100	25	07025.160.100
M10X12	200	07025.100.012	M12X70	50	07025.120.070	M16X110	25	07025.160.110
M10X16	200	07025.100.016	M12X80	50	07025.120.080	M16X120	25	07025.160.120
M10X20	200	07025.100.020	M12X90	50	07025.120.090			
M10X25	200	07025.100.025	M12X100	50	07025.120.100	M20X40	25	07025.200.040
M10X30	200	07025.100.030	M12X120	50	07025.120.120	M20X50	25	07025.200.050
M10X35	100	07025.100.035	M12X140	25	07025.120.140	M20X60	25	07025.200.060
M10X40	200	07025.100.040				M20X70	25	07025.200.070
M10X45	100	07025.100.045	M14X30	100	07025.140.030	M20X80	25	07025.200.080
M10X50	100	07025.100.050	M14X40	100	07025.140.040	M20X90	25	07025.200.090
M10X55	100	07025.100.055	M14X50	50	07025.140.050	M20X100	25	07025.200.100
M10X60	100	07025.100.060	M14X60	50	07025.140.060	M20X120	25	07025.200.120
M10X65	100	07025.100.065	M14X70	50	07025.140.070			
M10X70	100	07025.100.070	M14X80	50	07025.140.080	M24X40	10	07025.240.040
M10X80	100	07025.100.080	M14X90	50	07025.140.090	M24X50	10	07025.240.050
M10X90	100	07025.100.090	M14X100	50	07025.140.100	M24X60	10	07025.240.060
M10X100	100	07025.100.100				M24X70	10	07025.240.070
M10X120	50	07025.100.120	M16X25	50	07025.160.025	M24X80	10	07025.240.080
M10X150	25	07025.100.150	M16X30	50	07025.160.030	M24X90	10	07025.240.090
M10X160	25	07025.100.160	M16X35	50	07025.160.035	M24X100	10	07025.240.100
			M16X40	50	07025.160.040	M24X120	5	07025.240.120
M12X20	100	07025.120.020	M16X45	50	07025.160.045	M24X140	5	07025.240.140

• Powłokanie powierzchniowe ISO 10683 cynkowanie płatkowe eliminuje możliwości uszkodzenia, jakie może wywołać kruchość wodorowa.

51050 Śruby z łbem walcowym z gniazdem sześciokątnym

Q05A

Gwint Metryczny
Materiał Stal nierdzewna A2
Klasa 70

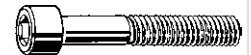

d x L	☒	Kod artykułu	d x L	☒	Kod artykułu	d x L	☒	Kod artykułu
M1,6X3*	500	51050.016.003	M2,5X30*	500	51050.025.030	M4X30	200	51050.040.030
M1,6X4*	500	51050.016.004	M2,5X35*	500	51050.025.035	M4X35	200	51050.040.035
M1,6X5*	500	51050.016.005	M2,5X40*	500	51050.025.040	M4X40	200	51050.040.040
M1,6X6*	500	51050.016.006				M4X45	200	51050.040.045
M1,6X8*	500	51050.016.008	M3X3*	1000	51050.030.003	M4X50	200	51050.040.050
M1,6X10*	500	51050.016.010	M3X4	1000	51050.030.004	M4X55	100	51050.040.055
M1,6X12*	500	51050.016.012	M3X5	200	51050.030.005	M4X60	200	51050.040.060
M1,6X14*	500	51050.016.014	M3X6	200	51050.030.006	M4X65*	100	51050.040.065
M1,6X16*	500	51050.016.016	M3X8	200	51050.030.008	M4X70*	100	51050.040.070
M1,6X18*	500	51050.016.018	M3X10	200	51050.030.010	M4X75*	100	51050.040.075
M1,6X20*	500	51050.016.020	M3X12	200	51050.030.012	M4X80	100	51050.040.080
			M3X14*	1000	51050.030.014	M4X90	100	51050.040.090
M2X3*	500	51050.020.003	M3X16	200	51050.030.016	M4X100*	100	51050.040.100
M2X4	100	51050.020.004	M3X18	200	51050.030.018			
M2X5	100	51050.020.005	M3X20	200	51050.030.020	M5X5*	500	51050.050.005
M2X6	100	51050.020.006	M3X22*	1000	51050.030.022	M5X6	200	51050.050.006
M2X8	100	51050.020.008	M3X25	200	51050.030.025	M5X8	200	51050.050.008
M2X10	100	51050.020.010	M3X30	200	51050.030.030	M5X10	200	51050.050.010
M2X12	100	51050.020.012	M3X35	200	51050.030.035	M5X12	200	51050.050.012
M2X14*	500	51050.020.014	M3X40	200	51050.030.040	M5X14*	500	51050.050.014
M2X16	100	51050.020.016	M3X45	200	51050.030.045	M5X16	200	51050.050.016
M2X18*	500	51050.020.018	M3X50*	200	51050.030.050	M5X18*	500	51050.050.018
M2X22*	500	51050.020.022	M3X55*	200	51050.030.055	M5X20	200	51050.050.020
M2X25*	500	51050.020.025	M3X60	200	51050.030.060	M5X22*	500	51050.050.022
M2X30*	500	51050.020.030	M3X65*	200	51050.030.065	M5X25	200	51050.050.025
			M3X70*	200	51050.030.070	M5X30	200	51050.050.030
M2,5X3	500	51050.025.003				M5X35	200	51050.050.035
M2,5X4	500	51050.025.004	M4X4*	1000	51050.040.004	M5X40	200	51050.050.040
M2,5X5	100	51050.025.005	M4X5*	1000	51050.040.005	M5X45	200	51050.050.045
M2,5X6	100	51050.025.006	M4X6	200	51050.040.006	M5X50	200	51050.050.050
M2,5X8	100	51050.025.008	M4X8	200	51050.040.008	M5X55	100	51050.050.055
M2,5X10	100	51050.025.010	M4X10	200	51050.040.010	M5X60	200	51050.050.060
M2,5X12	100	51050.025.012	M4X12	200	51050.040.012	M5X65	100	51050.050.065
M2,5X14*	500	51050.025.014	M4X14*	1000	51050.040.014	M5X70	200	51050.050.070
M2,5X16	100	51050.025.016	M4X16	200	51050.040.016	M5X75*	100	51050.050.075
M2,5X18*	500	51050.025.018	M4X18*	1000	51050.040.018	M5X80	200	51050.050.080
M2,5X20	100	51050.025.020	M4X20	200	51050.040.020	M5X85*	100	51050.050.085
M2,5X22*	500	51050.025.022	M4X22*	500	51050.040.022	M5X90	200	51050.050.090
M2,5X25*	500	51050.025.025	M4X25	200	51050.040.025	M5X95*	100	51050.050.095

51050 Śruby z łbem walcowym z gniazdem sześciokątnym								
d x L	☒	Kod artykułu	d x L	☒	Kod artykułu	d x L	☒	Kod artykułu
M5X100	200	51050.050.100	M8X260*	25	51050.080.260	M12X300*	25	51050.120.300
M5X110*	100	51050.050.110	M8X270*	25	51050.080.270	M14X20	25	51050.140.020
M5X120	100	51050.050.120	M8X280*	25	51050.080.280	M14X25*	100	51050.140.025
M5X130*	100	51050.050.130	M8X290*	25	51050.080.290	M14X30	25	51050.140.030
M5X140*	100	51050.050.140	M8X300*	25	51050.080.300	M14X35*	50	51050.140.035
M6X6*	500	51050.060.006	M10X12	200	51050.100.012	M14X40	25	51050.140.040
M6X8	200	51050.060.008	M10X14*	100	51050.100.014	M14X45*	50	51050.140.045
M6X10	200	51050.060.010	M10X16	100	51050.100.016	M14X50	25	51050.140.050
M6X12	200	51050.060.012	M10X18*	100	51050.100.018	M14X55*	50	51050.140.055
M6X14	200	51050.060.014	M10X20	100	51050.100.020	M14X60	25	51050.140.060
M6X16	200	51050.060.016	M10X22*	100	51050.100.022	M14X65*	50	51050.140.065
M6X18	200	51050.060.018	M10X25	100	51050.100.025	M14X70*	50	51050.140.070
M6X20	200	51050.060.020	M10X30	100	51050.100.030	M14X75*	50	51050.140.075
M6X22	200	51050.060.022	M10X35	100	51050.100.035	M14X80	25	51050.140.080
M6X25	200	51050.060.025	M10X40	100	51050.100.040	M14X85*	50	51050.140.085
M6X30	200	51050.060.030	M10X45	100	51050.100.045	M14X90*	50	51050.140.090
M6X35	200	51050.060.035	M10X50	100	51050.100.050	M14X95*	50	51050.140.095
M6X40	200	51050.060.040	M10X55	100	51050.100.055	M14X100*	50	51050.140.100
M6X45	200	51050.060.045	M10X60	100	51050.100.060	M14X110*	25	51050.140.110
M6X50	200	51050.060.050	M10X65*	50	51050.100.065	M14X120*	25	51050.140.120
M6X55	200	51050.060.055	M10X70	100	51050.100.070	M14X130*	25	51050.140.130
M6X60	200	51050.060.060	M10X75	50	51050.100.075	M14X140*	25	51050.140.140
M6X65	200	51050.060.065	M10X80	100	51050.100.080	M14X150*	25	51050.140.150
M6X70	200	51050.060.070	M10X85*	50	51050.100.085	M14X160*	25	51050.140.160
M6X75*	100	51050.060.075	M10X90	100	51050.100.090	M14X170*	25	51050.140.170
M6X80	200	51050.060.080	M10X95*	50	51050.100.095	M14X180*	25	51050.140.180
M6X85*	100	51050.060.085	M10X100	100	51050.100.100	M14X200*	25	51050.140.200
M6X90	200	51050.060.090	M10X110	50	51050.100.110	M16X20*	25	51050.160.020
M6X95*	100	51050.060.095	M10X120	50	51050.100.120	M16X25	25	51050.160.025
M6X100	200	51050.060.100	M10X130	50	51050.100.130	M16X30	25	51050.160.030
M6X110	100	51050.060.110	M10X140	50	51050.100.140	M16X35	25	51050.160.035
M6X120*	100	51050.060.120	M10X150	50	51050.100.150	M16X40	25	51050.160.040
M6X130*	100	51050.060.130	M10X160	25	51050.100.160	M16X45	25	51050.160.045
M6X140	100	51050.060.140	M10X170*	25	51050.100.170	M16X50	25	51050.160.050
M6X150	100	51050.060.150	M10X180*	25	51050.100.180	M16X55	25	51050.160.055
M6X160*	100	51050.060.160	M10X190*	25	51050.100.190	M16X60	25	51050.160.060
M6X170*	100	51050.060.170	M10X200*	25	51050.100.200	M16X65*	25	51050.160.065
M6X180*	100	51050.060.180	M10X210*	25	51050.100.210	M16X70	25	51050.160.070
M6X190*	100	51050.060.190	M10X220*	25	51050.100.220	M16X75*	25	51050.160.075
M6X200*	100	51050.060.200	M10X230*	25	51050.100.230	M16X80	25	51050.160.080
M6X220*	100	51050.060.220	M10X240*	25	51050.100.240	M16X85*	25	51050.160.085
M8X8*	500	51050.080.008	M10X250*	25	51050.100.250	M16X90	10	51050.160.090
M8X10	200	51050.080.010	M10X260*	25	51050.100.260	M16X95*	25	51050.160.095
M8X12	200	51050.080.012	M10X280*	25	51050.100.280	M16X100	10	51050.160.100
M8X14*	200	51050.080.014	M10X300*	25	51050.100.300	M16X110	10	51050.160.110
M8X16	200	51050.080.016	M12X16	50	51050.120.016	M16X120	10	51050.160.120
M8X18*	200	51050.080.018	M12X20	100	51050.120.020	M16X130	10	51050.160.130
M8X20	200	51050.080.020	M12X22*	50	51050.120.022	M16X140	10	51050.160.140
M8X22	200	51050.080.022	M12X25	100	51050.120.025	M16X150	10	51050.160.150
M8X25	200	51050.080.025	M12X30	100	51050.120.030	M16X160*	25	51050.160.160
M8X30	200	51050.080.030	M12X35	100	51050.120.035	M16X170*	25	51050.160.170
M8X35	200	51050.080.035	M12X40	100	51050.120.040	M16X180*	25	51050.160.180
M8X40	200	51050.080.040	M12X45	100	51050.120.045	M16X190*	25	51050.160.190
M8X45	200	51050.080.045	M12X50	100	51050.120.050	M16X200*	25	51050.160.200
M8X50	200	51050.080.050	M12X55	100	51050.120.055	M18X30*	25	51050.180.030
M8X55	200	51050.080.055	M12X60	100	51050.120.060	M18X35*	25	51050.180.035
M8X60	200	51050.080.060	M12X65*	50	51050.120.065	M18X40*	25	51050.180.040
M8X65	100	51050.080.065	M12X70	100	51050.120.070	M18X45*	25	51050.180.045
M8X70	200	51050.080.070	M12X75	25	51050.120.075	M18X50*	25	51050.180.050
M8X75*	100	51050.080.075	M12X80	100	51050.120.080	M18X55*	25	51050.180.055
M8X80	200	51050.080.080	M12X85	25	51050.120.085	M18X60*	25	51050.180.060
M8X85*	100	51050.080.085	M12X90	100	51050.120.090	M18X65*	25	51050.180.065
M8X90	200	51050.080.090	M12X95*	25	51050.120.095	M18X70*	25	51050.180.070
M8X95*	100	51050.080.095	M12X100	100	51050.120.100	M18X75*	25	51050.180.075
M8X100	200	51050.080.100	M12X110	50	51050.120.110	M18X80*	25	51050.180.080
M8X110	100	51050.080.110	M12X120	50	51050.120.120	M18X85*	25	51050.180.085
M8X120	100	51050.080.120	M12X130	25	51050.120.130	M18X90*	25	51050.180.090
M8X130	50	51050.080.130	M12X140*	25	51050.120.140	M18X100*	25	51050.180.100
M8X140	50	51050.080.140	M12X150	25	51050.120.150	M18X110*	25	51050.180.110
M8X150	50	51050.080.150	M12X160	50	51050.120.160	M18X120*	25	51050.180.120
M8X160	50	51050.080.160	M12X170*	25	51050.120.170	M18X130*	25	51050.180.130
M8X170*	25	51050.080.170	M12X180*	25	51050.120.180	M18X140*	25	51050.180.140
M8X180*	25	51050.080.180	M12X190*	25	51050.120.190	M18X150*	25	51050.180.150
M8X190*	25	51050.080.190	M12X200*	25	51050.120.200	M20X30*	25	51050.200.030
M8X200*	25	51050.080.200	M12X210*	25	51050.120.210	M20X35*	25	51050.200.035
M8X210*	25	51050.080.210	M12X220*	25	51050.120.220	M20X40	25	51050.200.040
M8X220*	25	51050.080.220	M12X230*	25	51050.120.230	M20X45	25	51050.200.045
M8X230*	25	51050.080.230	M12X240*	25	51050.120.240	M20X50	25	51050.200.050
M8X240*	25	51050.080.240	M12X260*	25	51050.120.260			
M8X250*	25	51050.080.250	M12X270*	25	51050.120.270			

51050 Śruby z łbem walcowym z gniazdem sześciokątnym ←

d x L	☒	Kod artykułu	d x L	☒	Kod artykułu	d x L	☒	Kod artykułu
M20X55	25	51050.200.055	M22X80*	25	51050.220.080	M24X260*	10	51050.240.260
M20X60	25	51050.200.060	M22X100*	25	51050.220.100	M27X60*	10	51050.270.060
M20X65*	25	51050.200.065	M22X110*	25	51050.220.110	M27X70*	10	51050.270.070
M20X70	25	51050.200.070	M22X130*	25	51050.220.130	M27X80*	10	51050.270.080
M20X75*	25	51050.200.075	M22X140*	25	51050.220.140	M27X90*	10	51050.270.090
M20X80	10	51050.200.080				M27X100*	10	51050.270.100
M20X85*	25	51050.200.085	M24X40*	10	51050.240.040	M27X110*	10	51050.270.110
M20X90	10	51050.200.090	M24X45	10	51050.240.045	M27X120*	10	51050.270.120
M20X100	10	51050.200.100	M24X50	10	51050.240.050	M27X130*	10	51050.270.130
M20X110	10	51050.200.110	M24X55*	10	51050.240.055	M27X150*	10	51050.270.150
M20X120	10	51050.200.120	M24X60	10	51050.240.060			
M20X130*	25	51050.200.130	M24X65*	10	51050.240.065	M30X50*	10	51050.300.050
M20X140	10	51050.200.140	M24X70	10	51050.240.070	M30X60*	10	51050.300.060
M20X150	10	51050.200.150	M24X75*	10	51050.240.075	M30X65*	10	51050.300.065
M20X160*	25	51050.200.160	M24X80	10	51050.240.080	M30X70*	10	51050.300.070
M20X170*	25	51050.200.170	M24X85*	10	51050.240.085	M30X75*	10	51050.300.075
M20X180*	25	51050.200.180	M24X90	10	51050.240.090	M30X80*	10	51050.300.080
M20X190*	25	51050.200.190	M24X95*	10	51050.240.095	M30X90*	10	51050.300.090
M20X200*	25	51050.200.200	M24X100	10	51050.240.100	M30X100*	10	51050.300.100
M20X210*	25	51050.200.210	M24X110	10	51050.240.110	M30X110*	10	51050.300.110
M20X220*	25	51050.200.220	M24X120	10	51050.240.120	M30X120*	10	51050.300.120
M20X240*	25	51050.200.240	M24X130*	10	51050.240.130	M30X130*	10	51050.300.130
M20X260*	25	51050.200.260	M24X140	10	51050.240.140	M30X140*	10	51050.300.140
			M24X150	10	51050.240.150	M30X160*	10	51050.300.160
M22X40*	25	51050.220.040	M24X160*	10	51050.240.160	M30X170*	10	51050.300.170
M22X50*	25	51050.220.050	M24X170*	10	51050.240.170	M30X180*	10	51050.300.180
M22X55*	25	51050.220.055	M24X180*	10	51050.240.180	M30X200*	10	51050.300.200
M22X60*	25	51050.220.060	M24X200*	10	51050.240.200	M30X300*	10	51050.300.300
M22X65*	25	51050.220.065	M24X210*	10	51050.240.210			
M22X70*	25	51050.220.070	M24X220*	10	51050.240.220			
M22X75*	25	51050.220.075	M24X250*	10	51050.240.250			

* Rozmiary o średnicy > M24 i rozmiary o długości > 8xd mają minimalną klasę właściwości 50.

55050 Śruby z łbem walcowym z gniazdem sześciokątnym Q45A

Gwint Metryczny
Materiał Stal nierdzewna A4
Klasa 70

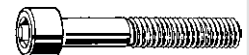

d x L	☒	Kod artykułu	d x L	☒	Kod artykułu	d x L	☒	Kod artykułu
M1,6X3*	500	55050.016.003	M2,5X22*	500	55050.025.022	M4X18*	1000	55050.040.018
M1,6X4	100	55050.016.004	M2,5X25*	500	55050.025.025	M4X20	200	55050.040.020
M1,6X5	100	55050.016.005	M2,5X30*	500	55050.025.030	M4X22*	500	55050.040.022
M1,6X6	100	55050.016.006	M2,5X35*	500	55050.025.035	M4X25	200	55050.040.025
M1,6X8*	500	55050.016.008	M2,5X40*	500	55050.025.040	M4X30	200	55050.040.030
M1,6X10*	500	55050.016.010				M4X35	200	55050.040.035
M1,6X12*	500	55050.016.012	M3X3*	1000	55050.030.003	M4X40	200	55050.040.040
M1,6X14*	500	55050.016.014	M3X4*	1000	55050.030.004	M4X45	200	55050.040.045
M1,6X16*	500	55050.016.016	M3X5*	1000	55050.030.005	M4X50	200	55050.040.050
M1,6X18*	500	55050.016.018	M3X6	200	55050.030.006	M4X55*	200	55050.040.055
M1,6X20*	500	55050.016.020	M3X8	200	55050.030.008	M4X60*	100	55050.040.060
			M3X10	200	55050.030.010	M4X65*	100	55050.040.065
M2X3*	500	55050.020.003	M3X12	200	55050.030.012	M4X70	100	55050.040.070
M2X4*	500	55050.020.004	M3X14*	1000	55050.030.014	M4X75*	100	55050.040.075
M2X5	100	55050.020.005	M3X16	200	55050.030.016	M4X80*	100	55050.040.080
M2X6	100	55050.020.006	M3X18*	1000	55050.030.018	M4X90*	100	55050.040.090
M2X8	100	55050.020.008	M3X20	200	55050.030.020	M4X100*	100	55050.040.100
M2X10	100	55050.020.010	M3X22*	1000	55050.030.022			
M2X12	100	55050.020.012	M3X25	200	55050.030.025	M5X5*	500	55050.050.005
M2X14*	500	55050.020.014	M3X30	200	55050.030.030	M5X6	500	55050.050.006
M2X16	100	55050.020.016	M3X35	200	55050.030.035	M5X8	200	55050.050.008
M2X18*	500	55050.020.018	M3X40	200	55050.030.040	M5X10	200	55050.050.010
M2X20	100	55050.020.020	M3X45*	500	55050.030.045	M5X12	200	55050.050.012
M2X25*	500	55050.020.025	M3X50	200	55050.030.050	M5X14	500	55050.050.014
M2X30*	500	55050.020.030	M3X55*	200	55050.030.055	M5X16	200	55050.050.016
			M3X60*	200	55050.030.060	M5X18*	500	55050.050.018
M2,5X3*	500	55050.025.003	M3X65*	200	55050.030.065	M5X20	200	55050.050.020
M2,5X4*	500	55050.025.004	M3X70*	200	55050.030.070	M5X22*	500	55050.050.022
M2,5X5	100	55050.025.005				M5X25	200	55050.050.025
M2,5X6	100	55050.025.006	M4X4*	1000	55050.040.004	M5X30	200	55050.050.030
M2,5X8	100	55050.025.008	M4X5*	1000	55050.040.005	M5X35	200	55050.050.035
M2,5X10	100	55050.025.010	M4X6	200	55050.040.006	M5X40	200	55050.050.040
M2,5X12	100	55050.025.012	M4X8	200	55050.040.008	M5X45	200	55050.050.045
M2,5X14*	500	55050.025.014	M4X10	200	55050.040.010	M5X50	200	55050.050.050
M2,5X16	100	55050.025.016	M4X12	200	55050.040.012	M5X55	200	55050.050.055
M2,5X18*	500	55050.025.018	M4X14*	1000	55050.040.014	M5X60	200	55050.050.060
M2,5X20	100	55050.025.020	M4X16	200	55050.040.016	M5X65*	100	55050.050.065

55050 Śruby z łbem walcowym z gniazdem sześciokątnym								
d x L	☒	Kod artykułu	d x L	☒	Kod artykułu	d x L	☒	Kod artykułu
M5X70	200	55050.050.070	M8X210*	25	55050.080.210	M12X240*	25	55050.120.240
M5X75*	100	55050.050.075	M8X220*	25	55050.080.220	M12X250*	25	55050.120.250
M5X80	200	55050.050.080	M8X230*	25	55050.080.230	M12X260*	25	55050.120.260
M5X85*	100	55050.050.085	M8X240*	25	55050.080.240	M12X270*	25	55050.120.270
M5X90*	100	55050.050.090	M8X250*	25	55050.080.250	M12X280*	25	55050.120.280
M5X95*	100	55050.050.095	M8X260*	25	55050.080.260	M12X300*	25	55050.120.300
M5X100*	100	55050.050.100	M8X270*	25	55050.080.270			
M5X110*	100	55050.050.110	M8X280*	25	55050.080.280	M14X25	25	55050.140.025
M5X120*	100	55050.050.120	M8X290*	25	55050.080.290	M14X30	25	55050.140.030
M5X130*	100	55050.050.130	M8X300*	25	55050.080.300	M14X35*	50	55050.140.035
M5X140*	100	55050.050.140				M14X40	25	55050.140.040
			M10X12	100	55050.100.012	M14X45	50	55050.140.045
M6X6	500	55050.060.006	M10X14*	100	55050.100.014	M14X50	25	55050.140.050
M6X8	200	55050.060.008	M10X16	100	55050.100.016	M14X55*	50	55050.140.055
M6X10	200	55050.060.010	M10X18*	100	55050.100.018	M14X60	25	55050.140.060
M6X12	200	55050.060.012	M10X20	100	55050.100.020	M14X65*	50	55050.140.065
M6X14	200	55050.060.014	M10X22*	100	55050.100.022	M14X70*	50	55050.140.070
M6X16	200	55050.060.016	M10X25	100	55050.100.025	M14X75*	50	55050.140.075
M6X18*	200	55050.060.018	M10X30	100	55050.100.030	M14X80	25	55050.140.080
M6X20	200	55050.060.020	M10X35	100	55050.100.035	M14X85*	50	55050.140.085
M6X22*	200	55050.060.022	M10X40	100	55050.100.040	M14X90	10	55050.140.090
M6X25	200	55050.060.025	M10X45	100	55050.100.045	M14X95*	50	55050.140.095
M6X30	200	55050.060.030	M10X50	100	55050.100.050	M14X100	10	55050.140.100
M6X35	200	55050.060.035	M10X55	100	55050.100.055	M14X110	10	55050.140.110
M6X40	200	55050.060.040	M10X60	100	55050.100.060	M14X120	10	55050.140.120
M6X45	200	55050.060.045	M10X65	50	55050.100.065	M14X130*	25	55050.140.130
M6X50	200	55050.060.050	M10X70	100	55050.100.070	M14X140*	25	55050.140.140
M6X55	200	55050.060.055	M10X75*	50	55050.100.075	M14X150*	25	55050.140.150
M6X60	200	55050.060.060	M10X80	100	55050.100.080			
M6X65	100	55050.060.065	M10X85*	50	55050.100.085	M16X20	25	55050.160.020
M6X70	200	55050.060.070	M10X90	100	55050.100.090	M16X25	25	55050.160.025
M6X75*	100	55050.060.075	M10X95*	50	55050.100.095	M16X30	25	55050.160.030
M6X80	200	55050.060.080	M10X100	100	55050.100.100	M16X35	25	55050.160.035
M6X85*	100	55050.060.085	M10X110	50	55050.100.110	M16X40	25	55050.160.040
M6X90	200	55050.060.090	M10X120	50	55050.100.120	M16X45	25	55050.160.045
M6X95*	100	55050.060.095	M10X130	50	55050.100.130	M16X50	25	55050.160.050
M6X100	200	55050.060.100	M10X140	50	55050.100.140	M16X55	25	55050.160.055
M6X110	100	55050.060.110	M10X150	50	55050.100.150	M16X60	25	55050.160.060
M6X120	100	55050.060.120	M10X160*	50	55050.100.160	M16X65*	25	55050.160.065
M6X130	100	55050.060.130	M10X170*	25	55050.100.170	M16X70	25	55050.160.070
M6X140	100	55050.060.140	M10X180*	25	55050.100.180	M16X75*	25	55050.160.075
M6X150	100	55050.060.150	M10X190*	25	55050.100.190	M16X80	25	55050.160.080
M6X160*	100	55050.060.160	M10X200*	25	55050.100.200	M16X85*	25	55050.160.085
M6X170*	100	55050.060.170	M10X210*	25	55050.100.210	M16X90	10	55050.160.090
M6X180*	100	55050.060.180	M10X220*	25	55050.100.220	M16X95*	25	55050.160.095
M6X190*	100	55050.060.190	M10X230*	25	55050.100.230	M16X100	10	55050.160.100
M6X200*	100	55050.060.200	M10X240*	25	55050.100.240	M16X110	10	55050.160.110
			M10X250*	25	55050.100.250	M16X120	10	55050.160.120
			M10X280*	25	55050.100.280	M16X130	10	55050.160.130
M8X8*	500	55050.080.008				M16X140	10	55050.160.140
M8X10	500	55050.080.010	M12X16*	50	55050.120.016	M16X150	10	55050.160.150
M8X12	200	55050.080.012	M12X20	100	55050.120.020	M16X160*	25	55050.160.160
M8X14*	200	55050.080.014	M12X22*	50	55050.120.022	M16X170*	25	55050.160.170
M8X16	200	55050.080.016	M12X25	100	55050.120.025	M16X180*	25	55050.160.180
M8X18*	200	55050.080.018	M12X30	100	55050.120.030	M16X190*	25	55050.160.190
M8X20	200	55050.080.020	M12X35	100	55050.120.035	M16X200*	25	55050.160.200
M8X22*	200	55050.080.022	M12X40	100	55050.120.040			
M8X25	200	55050.080.025	M12X45	100	55050.120.045	M18X30*	25	55050.180.030
M8X30	200	55050.080.030	M12X50	100	55050.120.050	M18X35*	25	55050.180.035
M8X35	200	55050.080.035	M12X55	100	55050.120.055	M18X40*	25	55050.180.040
M8X40	200	55050.080.040	M12X60	100	55050.120.060	M18X45*	25	55050.180.045
M8X45	200	55050.080.045	M12X65	100	55050.120.065	M18X50*	25	55050.180.050
M8X50	200	55050.080.050	M12X70	100	55050.120.070	M18X55*	25	55050.180.055
M8X55	200	55050.080.055	M12X75	25	55050.120.075	M18X60*	25	55050.180.060
M8X60	200	55050.080.060	M12X80	100	55050.120.080	M18X65*	25	55050.180.065
M8X65	100	55050.080.065	M12X85*	25	55050.120.085	M18X70*	25	55050.180.070
M8X70	200	55050.080.070	M12X90	100	55050.120.090	M18X75*	25	55050.180.075
M8X75*	100	55050.080.075	M12X95*	25	55050.120.095	M18X80*	25	55050.180.080
M8X80	200	55050.080.080	M12X100	100	55050.120.100	M18X90*	25	55050.180.090
M8X85*	100	55050.080.085	M12X110	50	55050.120.110	M18X100*	25	55050.180.100
M8X90	200	55050.080.090	M12X120	50	55050.120.120	M18X110*	25	55050.180.110
M8X95*	100	55050.080.095	M12X130	25	55050.120.130	M18X120*	25	55050.180.120
M8X100	200	55050.080.100	M12X140	25	55050.120.140	M18X140*	25	55050.180.140
M8X110	100	55050.080.110	M12X150	25	55050.120.150	M18X150*	25	55050.180.150
M8X120	100	55050.080.120	M12X160*	25	55050.120.160			
M8X130	50	55050.080.130	M12X170*	25	55050.120.170	M20X30*	25	55050.200.030
M8X140	50	55050.080.140	M12X180*	25	55050.120.180	M20X35*	25	55050.200.035
M8X150	50	55050.080.150	M12X190*	25	55050.120.190	M20X40	25	55050.200.040
M8X160*	50	55050.080.160	M12X200*	25	55050.120.200	M20X45	25	55050.200.045
M8X170*	25	55050.080.170	M12X210*	25	55050.120.210	M20X50	25	55050.200.050
M8X180*	25	55050.080.180	M12X220*	25	55050.120.220	M20X55	25	55050.200.055
M8X190*	25	55050.080.190	M12X230*	25	55050.120.230	M20X60	25	55050.200.060
M8X200*	25	55050.080.200						

55050 Śruby z łbem walcowym z gniazdem sześciokątnym ←

d x L	☒	Kod artykułu	d x L	☒	Kod artykułu	d x L	☒	Kod artykułu
M20X65*	25	55050.200.065	M22X130*	25	55050.220.130	M27X70	5	55050.270.070
M20X70	25	55050.200.070	M22X140*	25	55050.220.140	M27X75*	10	55050.270.075
M20X75*	25	55050.200.075	M22X150*	10	55050.220.150	M27X80	5	55050.270.080
M20X80	10	55050.200.080				M27X90	5	55050.270.090
M20X85*	25	55050.200.085	M24X40*	10	55050.240.040	M27X100	5	55050.270.100
M20X90	10	55050.200.090	M24X45*	10	55050.240.045	M27X120*	10	55050.270.120
M20X95*	25	55050.200.095	M24X50	10	55050.240.050	M27X130	5	55050.270.130
M20X100	10	55050.200.100	M24X55*	10	55050.240.055	M27X140	5	55050.270.140
M20X110	10	55050.200.110	M24X60	10	55050.240.060	M27X150	5	55050.270.150
M20X120	10	55050.200.120	M24X65*	10	55050.240.065	M27X160*	10	55050.270.160
M20X130	10	55050.200.130	M24X70	10	55050.240.070			
M20X140	10	55050.200.140	M24X75*	10	55050.240.075	M30X50	2	55050.300.050
M20X150	10	55050.200.150	M24X80	10	55050.240.080	M30X55*	2	55050.300.055
M20X160*	25	55050.200.160	M24X90	10	55050.240.090	M30X60	2	55050.300.060
M20X170*	25	55050.200.170	M24X100	10	55050.240.100	M30X65*	10	55050.300.065
M20X180*	25	55050.200.180	M24X110	10	55050.240.110	M30X70	2	55050.300.070
M20X190*	25	55050.200.190	M24X120	10	55050.240.120	M30X80	2	55050.300.080
M20X200*	25	55050.200.200	M24X130*	10	55050.240.130	M30X85*	10	55050.300.085
M20X210*	25	55050.200.210	M24X140	10	55050.240.140	M30X90	2	55050.300.090
			M24X150	10	55050.240.150	M30X95*	10	55050.300.095
M22X40*	25	55050.220.040	M24X160*	10	55050.240.160	M30X100	2	55050.300.100
M22X50*	25	55050.220.050	M24X170*	10	55050.240.170	M30X110	2	55050.300.110
M22X55*	25	55050.220.055	M24X180*	10	55050.240.180	M30X120*	10	55050.300.120
M22X60*	25	55050.220.060	M24X190*	10	55050.240.190	M30X130	2	55050.300.130
M22X65*	25	55050.220.065	M24X200*	10	55050.240.200	M30X140	2	55050.300.140
M22X70*	25	55050.220.070	M24X210*	10	55050.240.210	M30X150	2	55050.300.150
M22X75*	25	55050.220.075	M24X220*	10	55050.240.220	M30X160*	10	55050.300.160
M22X80*	25	55050.220.080	M24X240*	10	55050.240.240	M30X180*	10	55050.300.180
M22X90*	25	55050.220.090				M30X200*	10	55050.300.200
M22X110*	25	55050.220.110	M27X50	5	55050.270.050			
M22X120*	25	55050.220.120	M27X60	5	55050.270.060			

* Rozmiary o średnicy > M24 i rozmiary o długości > 8xd mają minimalną klasę właściwości 5.0.

53570 Śruby z łbem walcowym z gniazdem sześciokątnym R11A

Gwint Metryczny
Materiał Stal nierdzewna A4
Klasa 80

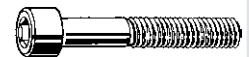

d x L	☒	Kod artykułu	d x L	☒	Kod artykułu	d x L	☒	Kod artykułu
M4X5*	1000	53570.040.005	M5X70*	100	53570.050.070	M8X20	50	53570.080.020
M4X6*	1000	53570.040.006	M5X75*	100	53570.050.075	M8X22*	200	53570.080.022
M4X8	100	53570.040.008	M5X80*	100	53570.050.080	M8X25	50	53570.080.025
M4X10	100	53570.040.010				M8X30	50	53570.080.030
M4X12	100	53570.040.012	M6X8*	500	53570.060.008	M8X35	100	53570.080.035
M4X14*	1000	53570.040.014	M6X10*	500	53570.060.010	M8X40	50	53570.080.040
M4X16	100	53570.040.016	M6X12	100	53570.060.012	M8X45*	100	53570.080.045
M4X18*	1000	53570.040.018	M6X14	100	53570.060.014	M8X50	50	53570.080.050
M4X20	100	53570.040.020	M6X16	100	53570.060.016	M8X55*	100	53570.080.055
M4X22*	500	53570.040.022	M6X18*	200	53570.060.018	M8X60	50	53570.080.060
M4X25	100	53570.040.025	M6X20	100	53570.060.020	M8X65*	100	53570.080.065
M4X30	100	53570.040.030	M6X22*	200	53570.060.022	M8X70	100	53570.080.070
M4X35*	200	53570.040.035	M6X25	100	53570.060.025	M8X75*	100	53570.080.075
M4X40	100	53570.040.040	M6X30	100	53570.060.030	M8X80*	100	53570.080.080
M4X45*	200	53570.040.045	M6X35	100	53570.060.035	M8X90*	100	53570.080.090
M4X50*	200	53570.040.050	M6X40	100	53570.060.040	M8X100*	50	53570.080.100
M4X55*	200	53570.040.055	M6X45*	100	53570.060.045	M8X110*	50	53570.080.110
M4X60*	100	53570.040.060	M6X50	100	53570.060.050	M8X120*	50	53570.080.120
			M6X55*	100	53570.060.055	M8X130*	50	53570.080.130
M5X6*	500	53570.050.006	M6X60	100	53570.060.060	M8X140*	50	53570.080.140
M5X8*	500	53570.050.008	M6X65*	100	53570.060.065	M8X150*	50	53570.080.150
M5X10	100	53570.050.010	M6X70*	100	53570.060.070	M8X160*	50	53570.080.160
M5X12	100	53570.050.012	M6X75*	100	53570.060.075			
M5X14*	500	53570.050.014	M6X80*	100	53570.060.080	M10X16	50	53570.100.016
M5X16	100	53570.050.016	M6X90*	100	53570.060.090	M10X18*	100	53570.100.018
M5X18*	500	53570.050.018	M6X100*	100	53570.060.100	M10X20	50	53570.100.020
M5X20	100	53570.050.020	M6X110*	100	53570.060.110	M10X22*	100	53570.100.022
M5X22*	500	53570.050.022	M6X120*	100	53570.060.120	M10X25	50	53570.100.025
M5X25	100	53570.050.025	M6X130*	100	53570.060.130	M10X30	50	53570.100.030
M5X30	100	53570.050.030	M6X140*	100	53570.060.140	M10X35	50	53570.100.035
M5X35	100	53570.050.035	M6X150*	100	53570.060.150	M10X40	50	53570.100.040
M5X40	100	53570.050.040				M10X45	100	53570.100.045
M5X45*	200	53570.050.045	M8X10*	500	53570.080.010	M10X50	50	53570.100.050
M5X50*	200	53570.050.050	M8X12*	500	53570.080.012	M10X55*	50	53570.100.055
M5X55*	200	53570.050.055	M8X14*	200	53570.080.014	M10X60	50	53570.100.060
M5X60*	100	53570.050.060	M8X16	50	53570.080.016	M10X65*	50	53570.100.065
M5X65*	100	53570.050.065	M8X18*	200	53570.080.018	M10X70	50	53570.100.070

53570 Śruby z łbem walcowym z gniazdem sześciokątnym

d x L	☒	Kod artykułu	d x L	☒	Kod artykułu	d x L	☒	Kod artykułu
M10X75*	50	53570.100.075	M14X50*	50	53570.140.050	M20X30*	25	53570.200.030
M10X80*	50	53570.100.080	M14X55*	50	53570.140.055	M20X35*	25	53570.200.035
M10X90*	50	53570.100.090	M14X60*	50	53570.140.060	M20X40*	25	53570.200.040
M10X100*	50	53570.100.100	M14X65*	50	53570.140.065	M20X45*	25	53570.200.045
M10X110*	50	53570.100.110	M14X70*	50	53570.140.070	M20X50	10	53570.200.050
M10X120*	50	53570.100.120	M14X75*	50	53570.140.075	M20X55*	25	53570.200.055
M10X130*	50	53570.100.130	M14X80*	50	53570.140.080	M20X60	10	53570.200.060
M10X140*	50	53570.100.140	M14X90*	50	53570.140.090	M20X65*	25	53570.200.065
M10X150*	50	53570.100.150	M14X100*	50	53570.140.100	M20X70	10	53570.200.070
			M14X110*	25	53570.140.110	M20X75*	25	53570.200.075
M12X20*	50	53570.120.020	M14X120*	25	53570.140.120	M20X80*	25	53570.200.080
M12X25	25	53570.120.025	M14X130*	25	53570.140.130	M20X90*	25	53570.200.090
M12X30	25	53570.120.030	M14X140*	25	53570.140.140	M20X100	10	53570.200.100
M12X35	25	53570.120.035	M14X150*	25	53570.140.150	M20X110*	25	53570.200.110
M12X40	25	53570.120.040				M20X120*	25	53570.200.120
M12X45	100	53570.120.045	M16X25*	25	53570.160.025	M20X130*	25	53570.200.130
M12X50	25	53570.120.050	M16X30	25	53570.160.030	M20X140*	25	53570.200.140
M12X55*	50	53570.120.055	M16X35*	25	53570.160.035	M20X150*	25	53570.200.150
M12X60	25	53570.120.060	M16X40	25	53570.160.040			
M12X65*	50	53570.120.065	M16X45	25	53570.160.045	M24X40*	10	53570.240.040
M12X70	100	53570.120.070	M16X50	25	53570.160.050	M24X45*	10	53570.240.045
M12X75*	25	53570.120.075	M16X55*	25	53570.160.055	M24X50*	10	53570.240.050
M12X80*	25	53570.120.080	M16X60	25	53570.160.060	M24X55*	10	53570.240.055
M12X90	25	53570.120.090	M16X65*	25	53570.160.065	M24X60*	10	53570.240.060
M12X100*	25	53570.120.100	M16X70	100	53570.160.070	M24X65*	10	53570.240.065
M12X110*	25	53570.120.110	M16X75*	25	53570.160.075	M24X70*	10	53570.240.070
M12X120*	25	53570.120.120	M16X80	25	53570.160.080	M24X75*	10	53570.240.075
M12X130*	25	53570.120.130	M16X90	25	53570.160.090	M24X80*	10	53570.240.080
M12X140*	25	53570.120.140	M16X100*	25	53570.160.100	M24X90*	10	53570.240.090
M12X150*	25	53570.120.150	M16X110*	25	53570.160.110	M24X100*	10	53570.240.100
			M16X120*	25	53570.160.120	M24X110*	10	53570.240.110
M14X30*	50	53570.140.030	M16X130*	25	53570.160.130	M24X120*	10	53570.240.120
M14X35*	50	53570.140.035	M16X140*	25	53570.160.140	M24X130*	10	53570.240.130
M14X40*	50	53570.140.040	M16X150*	25	53570.160.150	M24X140*	10	53570.240.140
M14X45*	50	53570.140.045				M24X150*	10	53570.240.150

45205 Śruby z łbem walcowym z gniazdem sześciokątnym
W010

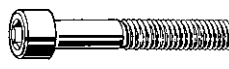
Gwint	Metryczny	DIN	≈912	
Material	Aluminium P60	ISO	≈4762	
		NEN	≈1241	
		ASME	≈B18.3.1M	
		NF	≈E25-125	
		BS	≈4168-1	

d x L	☒	Kod artykułu	d x L	☒	Kod artykułu	d x L	☒	Kod artykułu
M4X10	200	45205.040.010	M5X40	200	45205.050.040	M8X15	200	45205.080.015
M4X12	200	45205.040.012				M8X20	200	45205.080.020
M4X16	200	45205.040.016	M6X10	200	45205.060.010	M8X25	200	45205.080.025
M4X20	200	45205.040.020	M6X12	200	45205.060.012	M8X30	200	45205.080.030
M4X25	200	45205.040.025	M6X16	200	45205.060.016	M8X40	200	45205.080.040
M4X30	200	45205.040.030	M6X20	200	45205.060.020	M8X50	200	45205.080.050
			M6X25	200	45205.060.025			
M5X10	200	45205.050.010	M6X30	200	45205.060.030	M10X25	200	45205.100.025
M5X12	200	45205.050.012	M6X40	200	45205.060.040	M10X30	200	45205.100.030
M5X16	200	45205.050.016	M6X50	200	45205.060.050	M10X40	100	45205.100.040
M5X20	200	45205.050.020	M6X60	200	45205.060.060	M10X50	100	45205.100.050
M5X25	200	45205.050.025	M6X70	200	45205.060.070	M10X60	100	45205.100.060
M5X30	200	45205.050.030						

Śruby z gniazdem sześciokątnym

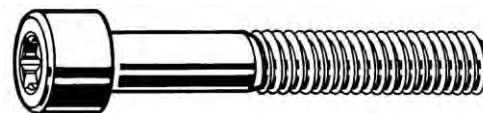
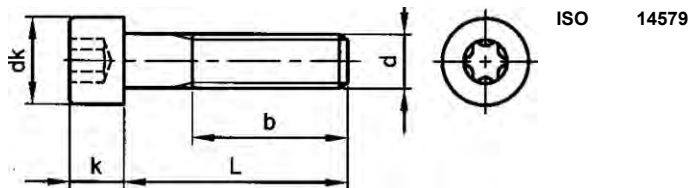

2

Informacje techniczne

d	b	d _k (maks.)	k (maks.)	Nasadka	P
M2	16	3.8	2	T6	0.4
M2.5	17	4.5	2.5	T8	0.45
M3	18	5.5	3	T10	0.5
M4	20	7	4	T20	0.7
M5	22	8.5	5	T25	0.8
M6	24	10	6	T30	1
M8	28	13	8	T45	1.25

Grupy katalogowe

Gwint	Gniazdo	Materiał	Klasa	Obróbka powierzchni	Kod	Strona
M	Sześciokątny	St	8.8	Ocynk.	07165	2-16
M	Sześciokątny	St.St. A2	50		51052	2-16

07165 Śruby z gniazdem sześciokątnym

D02A

Gwint Metryczny
 Materiał Stal
 Klasa 8.8
 Obróbka powierzchni Ocynkowane



d x L	☒	Kod artykułu	d x L	☒	Kod artykułu	d x L	☒	Kod artykułu
M5X25	500	07165.050.025	M6X35	200	07165.060.035	M8X16	200	07165.080.016
M6X12	200	07165.060.012	M6X40	200	07165.060.040	M8X40	100	07165.080.040
M6X30	200	07165.060.030	M6X50	200	07165.060.050	M8X50	100	07165.080.050

51052 Śruby z gniazdem sześciokątnym

Q05A

Gwint Metryczny
 Materiał Stal nierdzewna A2
 Klasa 50



d x L	☒	Kod artykułu	d x L	☒	Kod artykułu	d x L	☒	Kod artykułu
M2X3*	500	51052.020.003	M3X5*	1000	51052.030.005	M4X35*	200	51052.040.035
M2X4*	500	51052.020.004	M3X6*	1000	51052.030.006	M4X40*	200	51052.040.040
M2X5*	500	51052.020.005	M3X8*	1000	51052.030.008	M4X45*	200	51052.040.045
M2X6*	500	51052.020.006	M3X10*	1000	51052.030.010	M4X50*	200	51052.040.050
M2X8*	500	51052.020.008	M3X12*	1000	51052.030.012	M4X60*	100	51052.040.060
M2X10*	500	51052.020.010	M3X14*	1000	51052.030.014	M5X6*	500	51052.050.006
M2X12*	500	51052.020.012	M3X16*	1000	51052.030.016	M5X8*	500	51052.050.008
M2X14*	500	51052.020.014	M3X18*	1000	51052.030.018	M5X10*	500	51052.050.010
M2X16*	500	51052.020.016	M3X20*	1000	51052.030.020	M5X12*	500	51052.050.012
M2X18*	500	51052.020.018	M3X22*	1000	51052.030.022	M5X14*	500	51052.050.014
M2X20*	500	51052.020.020	M3X25*	1000	51052.030.025	M5X16*	500	51052.050.016
			M3X30*	1000	51052.030.030	M5X18*	500	51052.050.018
M2.5X3*	500	51052.025.003				M5X20*	500	51052.050.020
M2.5X4*	500	51052.025.004	M4X5*	1000	51052.040.005	M5X22*	500	51052.050.022
M2.5X5*	500	51052.025.005	M4X6*	1000	51052.040.006	M5X25*	200	51052.050.025
M2.5X6*	500	51052.025.006	M4X8*	1000	51052.040.008	M5X30*	200	51052.050.030
M2.5X8*	500	51052.025.008	M4X10*	1000	51052.040.010	M5X35*	200	51052.050.035
M2.5X10*	500	51052.025.010	M4X12*	1000	51052.040.012	M5X40*	200	51052.050.040
M2.5X12*	500	51052.025.012	M4X14*	1000	51052.040.014	M5X45*	200	51052.050.045
M2.5X14*	500	51052.025.014	M4X16*	1000	51052.040.016	M5X50*	200	51052.050.050
M2.5X16*	500	51052.025.016	M4X18*	1000	51052.040.018	M5X60*	100	51052.050.060
M2.5X18*	500	51052.025.018	M4X20*	500	51052.040.020			
M2.5X20*	500	51052.025.020	M4X22*	500	51052.040.022			
			M4X25*	500	51052.040.025	M6X6*	500	51052.060.006
M3X4*	1000	51052.030.004	M4X30*	500	51052.040.030	M6X8*	500	51052.060.008

51052 Śruby z gniazdem sześciokątnym								
d x L	☒	Kod artykułu	d x L	☒	Kod artykułu	d x L	☒	Kod artykułu
M6X10*	500	51052.060.010	M6X35*	200	51052.060.035	M8X22*	200	51052.080.022
M6X12*	500	51052.060.012	M6X40*	200	51052.060.040	M8X25*	100	51052.080.025
M6X14*	200	51052.060.014	M6X45*	100	51052.060.045	M8X30*	100	51052.080.030
M6X16*	200	51052.060.016	M6X50*	100	51052.060.050	M8X35*	100	51052.080.035
M6X18*	200	51052.060.018	M6X60*	100	51052.060.060	M8X40*	100	51052.080.040
M6X20*	200	51052.060.020				M8X45*	100	51052.080.045
M6X22*	200	51052.060.022	M8X16*	200	51052.080.016	M8X50*	100	51052.080.050
M6X25*	200	51052.060.025	M8X18*	200	51052.080.018	M8X60*	100	51052.080.060
M6X30*	200	51052.060.030	M8X20*	200	51052.080.020			

Śruby z łbem walcowym z gniazdem sześciokątnym z gwintem na całej długości

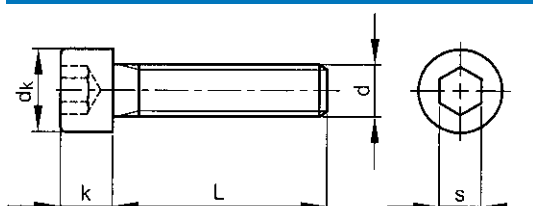

DIN ≈912
 ISO ≈4762
 NEN ≈1241
 ASME ≈B18.3.1M
 NF ≈E25-125
 BS ≈4168-1





Informacje techniczne

d	d _k (maks.)	k (maks.)	P	s
M3	5.5	3	0.5	2.5
M4	7	4	0.7	3
M5	8.5	5	0.8	4
M6	10	6	1	5
M8	13	8	1.25	6
M10	16	10	1.5	8
M12	18	12	1.75	10
M14	21	14	2	12
M16	24	16	2	14
M20	30	20	2.5	17

Grupy katalogowe

Gwint	Gniazdo	Materiał	Klasa	Obróbka powierzchni	Kolor	Kod	Strona
M	Gniazdo sześciokątne	St	8.8			07070	2-17
M	Gniazdo sześciokątne	St	8.8	Ocynk.		07071	2-18
M	Gniazdo sześciokątne	St	12.9			07010	2-18
M	Gniazdo sześciokątne	St.St. A2	70			51020	2-18
M	Gniazdo sześciokątne	St.St. A4	70			55020	2-19
M	Gniazdo sześciokątne	St.St. A2	70		Ząbkowane	51051	2-19
M	Gniazdo sześciokątne	Plastik PA	PA 6.6		Biały	56120	2-19

07070 Śruby z łbem walcowym z gniazdem sześciokątnym z gwintem na całej długości		D03A
Gwint	Metryczny	
Materiał	Stal	
Klasa	8.8	

d x L	☒	Kod artykułu	d x L	☒	Kod artykułu	d x L	☒	Kod artykułu
M3X25	200	07070.030.025	M6X45	200	07070.060.045	M10X80	50	07070.100.080
			M6X50	200	07070.060.050	M10X100	50	07070.100.100
M4X30	200	07070.040.030	M6X60	200	07070.060.060			
M4X40	200	07070.040.040	M6X80	200	07070.060.080	M12X60	50	07070.120.060
M4X50	200	07070.040.050	M6X90	100	07070.060.090	M12X70	50	07070.120.070
M4X60	200	07070.040.060	M6X100	100	07070.060.100	M12X80	50	07070.120.080
						M12X100	50	07070.120.100
M5X30	200	07070.050.030	M8X40	100	07070.080.040	M12X120	50	07070.120.120
M5X35	200	07070.050.035	M8X50	100	07070.080.050			
M5X40	200	07070.050.040	M8X60	100	07070.080.060	M14X60	50	07070.140.060
M5X45	200	07070.050.045	M8X70	100	07070.080.070	M14X80	50	07070.140.080
M5X50	200	07070.050.050	M8X80	100	07070.080.080			
M5X60	200	07070.050.060	M8X100	100	07070.080.100	M16X80	25	07070.160.080
M5X80	200	07070.050.080				M16X100	25	07070.160.100
			M10X50	50	07070.100.050	M20X80	25	07070.200.080
M6X35	200	07070.060.035	M10X60	50	07070.100.060			
M6X40	200	07070.060.040	M10X70	50	07070.100.070			

07071	Śruby z łbem walcowym z gniazdem sześciokątnym z gwintem na całej długości		D03A
Gwint	Metryczny		
Materiał	Stal		
Klasa	8.8		
Obróbka powierzchni	Ocynkowane		

d x L	☒	Kod artykułu	d x L	☒	Kod artykułu	d x L	☒	Kod artykułu
M3X25	200	07071.030.025	M6X35	200	07071.060.035	M10X80	50	07071.100.080
M3X30	200	07071.030.030	M6X40	200	07071.060.040	M10X100	50	07071.100.100
M3X40	200	07071.030.040	M6X45	200	07071.060.045			
M4X30	200	07071.040.030	M6X50	200	07071.060.050	M12X60	50	07071.120.060
M4X40	200	07071.040.040	M6X60	200	07071.060.060	M12X70	50	07071.120.070
M4X50	200	07071.040.050	M6X70	200	07071.060.070	M12X80	50	07071.120.080
M4X60	200	07071.040.060	M6X80	200	07071.060.080	M12X100	50	07071.120.100
			M8X40	100	07071.080.040	M16X70	50	07071.160.070
M5X30	200	07071.050.030	M8X50	100	07071.080.050	M16X80	25	07071.160.080
M5X35	200	07071.050.035	M8X60	100	07071.080.060	M16X90	25	07071.160.090
M5X40	200	07071.050.040	M8X70	100	07071.080.070	M16X100	25	07071.160.100
M5X45	200	07071.050.045	M8X80	100	07071.080.080			
M5X50	200	07071.050.050	M8X100	100	07071.080.100	M20X80	25	07071.200.080
M5X60	200	07071.050.060				M20X90	25	07071.200.090
M5X70	200	07071.050.070	M10X50	50	07071.100.050	M20X100	25	07071.200.100
M5X80	200	07071.050.080	M10X60	50	07071.100.060			
			M10X70	50	07071.100.070			



07010	Śruby z łbem walcowym z gniazdem sześciokątnym z gwintem na całej długości		D03A
Gwint	Metryczny		
Materiał	Stal		
Klasa	12.9		

d x L	☒	Kod artykułu	d x L	☒	Kod artykułu	d x L	☒	Kod artykułu
M3X25	200	07010.030.025	M6X35	200	07010.060.035	M8X80	100	07010.080.080
M4X30	200	07010.040.030	M6X40	200	07010.060.040	M10X50	50	07010.100.050
M4X40	200	07010.040.040	M6X50	200	07010.060.050	M10X60	50	07010.100.060
M4X50	200	07010.040.050	M6X60	100	07010.060.060	M10X70	50	07010.100.070
						M10X80	50	07010.100.080
M5X30	200	07010.050.030	M8X40	100	07010.080.040	M12X60	50	07010.120.060
M5X35	200	07010.050.035	M8X50	100	07010.080.050	M12X80	50	07010.120.080
M5X40	200	07010.050.040	M8X60	100	07010.080.060			
M5X50	200	07010.050.050						



• Ostrzeżenie: cynkowanie elektrolityczne tych produktów może wywołać kruchość wodorową.

51020	Śruby z łbem walcowym z gniazdem sześciokątnym z gwintem na całej długości		Q05A
Gwint	Metryczny		
Materiał	Stal nierdzewna A2		
Klasa	70		

d x L	☒	Kod artykułu	d x L	☒	Kod artykułu	d x L	☒	Kod artykułu
M5X30*	200	51020.050.030	M6X90*	100	51020.060.090	M10X50*	50	51020.100.050
M5X35*	200	51020.050.035	M6X100*	100	51020.060.100	M10X55*	50	51020.100.055
M5X40*	200	51020.050.040				M10X60*	50	51020.100.060
M5X45*	200	51020.050.045	M8X40*	100	51020.080.040	M10X70*	50	51020.100.070
M5X50*	200	51020.050.050	M8X45*	100	51020.080.045	M10X80*	50	51020.100.080
			M8X50*	100	51020.080.050	M10X90*	50	51020.100.090
M6X35*	200	51020.060.035	M8X55*	100	51020.080.055	M10X100*	50	51020.100.100
M6X40*	200	51020.060.040	M8X60*	100	51020.080.060			
M6X45*	100	51020.060.045	M8X70*	100	51020.080.070	M12X55*	100	51020.120.055
M6X50*	100	51020.060.050	M8X80*	100	51020.080.080	M12X60*	50	51020.120.060
M6X55*	100	51020.060.055	M8X90*	100	51020.080.090	M12X70*	50	51020.120.070
M6X60*	100	51020.060.060	M8X100*	50	51020.080.100	M12X80*	25	51020.120.080
M6X70*	100	51020.060.070				M12X90*	25	51020.120.090
M6X80*	100	51020.060.080	M10X45*	100	51020.100.045			

55020	Śruby z łbem walcowym z gniazdem sześciokątnym z gwintem na całą długość		Q45A
Gwint	Metryczny		
Materiał	Stal nierdzewna A4		
Klasa	70		
			

d x L	☒	Kod artykułu	d x L	☒	Kod artykułu	d x L	☒	Kod artykułu
M5X30*	200	55020.050.030	M6X80*	100	55020.060.080	M10X50*	50	55020.100.050
M5X35*	200	55020.050.035	M6X90*	100	55020.060.090	M10X55*	50	55020.100.055
M5X40*	200	55020.050.040				M10X60*	50	55020.100.060
M5X45*	200	55020.050.045	M8X40*	100	55020.080.040	M10X70*	50	55020.100.070
M5X50*	200	55020.050.050	M8X45*	100	55020.080.045	M10X80*	50	55020.100.080
M5X100*	100	55020.050.100	M8X50*	100	55020.080.050	M10X90*	50	55020.100.090
			M8X55*	100	55020.080.055	M10X100*	50	55020.100.100
M6X35*	200	55020.060.035	M8X60*	100	55020.080.060			
M6X40*	200	55020.060.040	M8X70*	100	55020.080.070	M12X55*	50	55020.120.055
M6X45*	100	55020.060.045	M8X80*	100	55020.080.080	M12X60*	50	55020.120.060
M6X50*	100	55020.060.050	M8X90*	100	55020.080.090	M12X70*	50	55020.120.070
M6X55*	100	55020.060.055	M8X100*	50	55020.080.100	M12X80*	25	55020.120.080
M6X60*	100	55020.060.060				M12X90*	25	55020.120.090
M6X70*	100	55020.060.070	M10X45*	100	55020.100.045	M12X100*	25	55020.120.100

51051	Śruby z łbem walcowym z gniazdem sześciokątnym, ząbkowana, pełny gwint		Q05A
Gwint	Metryczny		
Materiał	Stal nierdzewna A2		
Klasa	70		
			

d x L	☒	Kod artykułu	d x L	☒	Kod artykułu	d x L	☒	Kod artykułu
M8X12*	500	51051.080.012	M8X28*	200	51051.080.028	M8X50*	200	51051.080.050
M8X14*	200	51051.080.014	M8X30*	200	51051.080.030	M8X55*	100	51051.080.055
M8X16*	200	51051.080.016	M8X32*	200	51051.080.032	M8X60*	100	51051.080.060
M8X20*	200	51051.080.020	M8X35*	200	51051.080.035			
M8X22*	200	51051.080.022	M8X40*	200	51051.080.040	M10X20*	100	51051.100.020
M8X25*	200	51051.080.025	M8X45*	200	51051.080.045			

56120	Śruby z łbem walcowym z gniazdem sześciokątnym z gwintem na całą długość plastikowe		W02A
Gwint	Metryczny		
Materiał	Plastik Poliamid (nylon)		
Klasa	PA 6.6		
Kolor	Biały		

d x L	☒	Kod artykułu	d x L	☒	Kod artykułu	d x L	☒	Kod artykułu
M6X10	50	56120.060.010	M8X20	50	56120.080.020	M10X30	25	56120.100.030
M6X16	50	56120.060.016	M8X25	50	56120.080.025	M10X40	25	56120.100.040
M6X20	50	56120.060.020	M8X30	50	56120.080.030	M10X50	25	56120.100.050
M6X25	50	56120.060.025	M8X40	50	56120.080.040	M10X60	25	56120.100.060
M6X30	50	56120.060.030	M8X50	50	56120.080.050			
M6X40	50	56120.060.040	M8X60	50	56120.080.060	M12X30	25	56120.120.030
M6X50	50	56120.060.050				M12X40	25	56120.120.040
			M10X20	25	56120.100.020	M12X50	25	56120.120.050
M8X16	50	56120.080.016	M10X25	25	56120.100.025	M12X60	25	56120.120.060

Śruby z łbem walcowym z gniazdem sześciokątnym, metryczne drobnozwojne

2

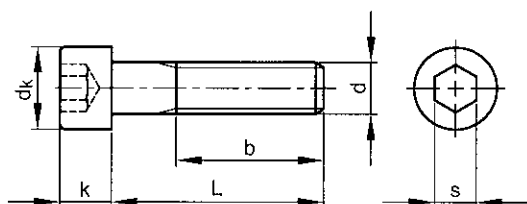

DIN 912
ISO 4762
NEN 1241
ASME B18.3.1M
NF E25-125
BS 4168-1

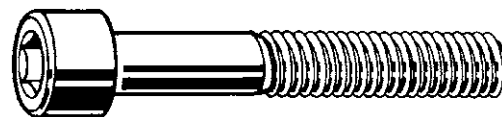

Informacje techniczne

d	b	d _k (maks.)	k (maks.)	Pelen gwint L ≤	s
M8	28	13	8	35	6
M10	32	16	10	40	8
M12	36	18	12	50	10
M14	40	21	14	55	12
M16	44	24	16	60	14
M18	48	27	18	65	14

Grupy katalogowe

Gwint	Gniazdo	Materiał	Klasa	Kod	Strona
M.drob.	Gniazdo sześciokątne	St	12.9	07040	2-20
M.b.drob.	Gniazdo sześciokątne	St	12.9	07041	2-20

07040 Śruby z łbem walcowym z gniazdem sześciokątnym, metryczne drobnozwojne

D93A

Gwint Metryczny drobnozwojny
Materiał Stal
Klasa 12.9

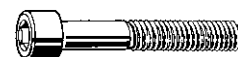

d x P x L	☒	Kod artykułu	d x P x L	☒	Kod artykułu	d x P x L	☒	Kod artykułu
M8X1,00X16	100	07040.080.016	M10X1,25X60	25	07040.100.060	M12X1,50X100	10	07040.120.100
M8X1,00X20	100	07040.080.020	M10X1,25X70	25	07040.100.070	M14X1,50X30	10	07040.140.030
M8X1,00X25	100	07040.080.025	M10X1,25X80	25	07040.100.080	M14X1,50X40	10	07040.140.040
M8X1,00X30	100	07040.080.030	M10X1,25X90	25	07040.100.090	M14X1,50X50	10	07040.140.050
M8X1,00X35	100	07040.080.035	M10X1,25X100	25	07040.100.100	M14X1,50X60	50	07040.140.060
M8X1,00X40	100	07040.080.040				M14X1,50X80	10	07040.140.080
M8X1,00X45	50	07040.080.045	M12X1,50X25	50	07040.120.025	M16X1,50X40	10	07040.160.040
M8X1,00X50	50	07040.080.050	M12X1,50X30	50	07040.120.030	M16X1,50X50	10	07040.160.050
			M12X1,50X35	50	07040.120.035	M16X1,50X55	10	07040.160.055
M10X1,25X20	100	07040.100.020	M12X1,50X40	25	07040.120.040	M16X1,50X60	10	07040.160.060
M10X1,25X25	50	07040.100.025	M12X1,50X45	25	07040.120.045	M16X1,50X70	10	07040.160.070
M10X1,25X30	50	07040.100.030	M12X1,50X50	25	07040.120.050	M16X1,50X80	5	07040.160.080
M10X1,25X35	50	07040.100.035	M12X1,50X55	25	07040.120.055	M16X1,50X90	5	07040.160.090
M10X1,25X40	50	07040.100.040	M12X1,50X60	10	07040.120.060	M16X1,50X100	5	07040.160.100
M10X1,25X45	50	07040.100.045						
M10X1,25X50	50	07040.100.050						
M10X1,25X55	50	07040.100.055						

• Ostrzeżenie: cynkowanie elektrolityczne tych produktów może wywołać kruchość wodorową.

07041 Śruby z łbem walcowym z gniazdem sześciokątnym, metryczne bardzo drobnozwojne

D93A

Gwint Metryczny bardzo drobnozwojny
Materiał Stal
Klasa 12.9

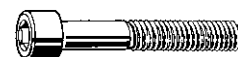

d x P x L	☒	Kod artykułu	d x P x L	☒	Kod artykułu	d x P x L	☒	Kod artykułu
M10X1,00X30	50	07041.100.030	M10X1,00X100	25	07041.100.100	M12X1,25X60	25	07041.120.060
M10X1,00X35	50	07041.100.035				M12X1,25X70	10	07041.120.070
M10X1,00X40	50	07041.100.040	M12X1,25X25	50	07041.120.025	M12X1,25X80	10	07041.120.080
M10X1,00X45	50	07041.100.045	M12X1,25X30	50	07041.120.030	M12X1,25X100	10	07041.120.100
M10X1,00X50	50	07041.100.050	M12X1,25X40	25	07041.120.040			
M10X1,00X60	25	07041.100.060	M12X1,25X45	25	07041.120.045	M18X1,50X70	5	07041.180.070
M10X1,00X70	25	07041.100.070	M12X1,25X50	25	07041.120.050	M18X1,50X80	5	07041.180.080
M10X1,00X90	25	07041.100.090						

• Ostrzeżenie: cynkowanie elektrolityczne tych produktów może wywołać kruchość wodorową.

Śruby z łbem walcowym z gniazdem sześciokątnym seria 1960 UNC

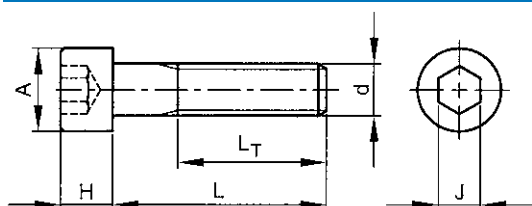

ASME ≈B18.3 (1960)
BS ≈2470

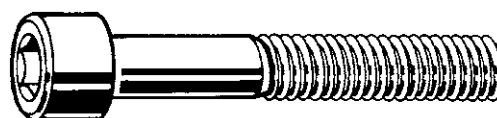

2

Informacje techniczne

d	A	H	J	L _T (min.)	Zwoje gwintu na cal
No.2	0.14	0.086	5/64	0.625	56
No.4	0.183	0.112	3/32	0.750	40
No.6	0.226	0.138	7/64	0.750	32
No.8	0.27	0.164	9/64	0.875	32
1/4	3/8	1/4	3/16	1.000	20
5/16	15/32	5/16	1/4	1.125	18
3/8	9/16	3/8	5/16	1.250	16
1/2	3/4	1/2	3/8	1.500	13
5/8	15/16	5/8	1/2	1.750	11
3/4	1.1/8	3/4	5/8	2.000	10

- Właściwości mechaniczne odpowiadają w zasadzie klasie właściwości 12.9 zgodn. z DIN ISO 898-1. Inne właściwości zgodn. z ASTM A574.
- Oznaczenie tych śrub nie jest obowiązkowe.
- UWAGA: ponieważ norma produktu wyznacza tolerancję gwintu 3A dla rozmiarów gwintu do 1 cala, cynkowanie może spowodować problemy z pasowaniem gwintu.

Grupy katalogowe

Gwint	Gniazdo	Materiał	Klasa	Kod	Strona
UNC	Gniazdo sześciokątne	St	12.9	07212	2-21
UNC	Gniazdo sześciokątne	St.St. A2		51056	2-21

07212 Śruby z łbem walcowym z gniazdem sześciokątnym seria 1960 UNC

X05A

Gwint Calowy, zunifikowany grubozwojny (UNC)
Materiał Stal
Klasa 12.9



d x L	☒	Kod artykułu	d x L	☒	Kod artykułu	d x L	☒	Kod artykułu
NO.2X3/16	100	07212.021.004	NO.4X5/8	100	07212.028.015	NO.6X1 Inch	100	07212.035.025
NO.2X1/4	100	07212.021.006	NO.4X3/4	100	07212.028.019			
NO.2X3/8	100	07212.021.009				NO.8X1/4	100	07212.041.006
NO.2X1/2	100	07212.021.012	NO.6X1/4	100	07212.035.006	NO.8X3/8	100	07212.041.009
NO.2X5/8	100	07212.021.015	NO.6X5/16	100	07212.035.007	NO.8X1/2	100	07212.041.012
			NO.6X3/8	100	07212.035.009	NO.8X5/8	100	07212.041.015
NO.4X1/4	100	07212.028.006	NO.6X1/2	100	07212.035.012	NO.8X3/4	100	07212.041.019
NO.4X5/16	100	07212.028.007	NO.6X5/8	100	07212.035.015	NO.8X1 Inch	100	07212.041.025
NO.4X3/8	100	07212.028.009	NO.6X3/4	100	07212.035.019	NO.8X1.1/4	100	07212.041.031
NO.4X1/2	100	07212.028.012	NO.6X7/8	100	07212.035.022	NO.8X1.1/2	100	07212.041.038

- Ostrzeżenie: cynkowanie elektrolityczne tych produktów może wywołać kruchość wodorową.

51056 Śruby z łbem walcowym z gniazdem sześciokątnym seria 1960 UNC

X61A

Gwint Calowy, zunifikowany grubozwojny (UNC)
Materiał Stal nierdzewna A2



d x L	☒	Kod artykułu	d x L	☒	Kod artykułu	d x L	☒	Kod artykułu
1/4X1/4	100	51056.063.006	1/4X2 Inch	100	51056.063.050	3/8X2 Inch	50	51056.096.050
1/4X3/8	100	51056.063.009	1/4X2.1/4	100	51056.063.057	3/8X2.1/2	50	51056.096.063
1/4X1/2	100	51056.063.012	1/4X2.1/2	100	51056.063.063	3/8X2.3/4	100	51056.096.069
1/4X5/8	100	51056.063.015				3/8X3.1/2	50	51056.096.088
1/4X7/8	100	51056.063.022	3/8X5/8	25	51056.096.015	3/8X4.1/2	50	51056.096.114
1/4X1 Inch	100	51056.063.025	3/8X1 Inch	50	51056.096.025			
1/4X1.1/4	100	51056.063.031	3/8X1.1/4	50	51056.096.031	1/2X3/4	25	51056.127.019
1/4X1.1/2	100	51056.063.038	3/8X1.1/2	50	51056.096.038	1/2X1 Inch	25	51056.127.025
1/4X1.3/4	100	51056.063.044	3/8X1.3/4	50	51056.096.044	1/2X1.1/4	25	51056.127.031

51056 Śruby z łbem walcowym z gniazdem sześciokątnym seria 1960 UNC

d x L	☒	Kod artykułu	d x L	☒	Kod artykułu	d x L	☒	Kod artykułu
1/2X1.1/2	25	51056.127.038	1/2X2 Inch	25	51056.127.050	1/2X4 Inch	25	51056.127.101
1/2X1.3/4	25	51056.127.044	1/2X3 Inch	25	51056.127.076			

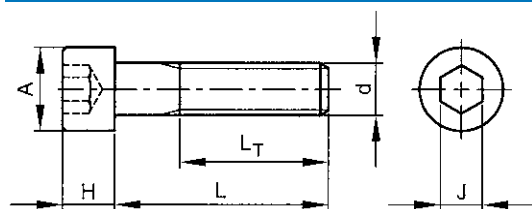
2
Śruby z łbem walcowym z gniazdem sześciokątnym seria 1936 UNC

ASME ≈B18.3 (1936)

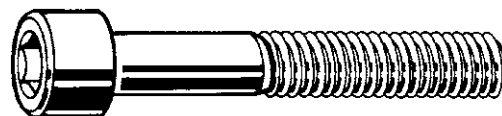
Informacje techniczne

d	A	H	J	L _T (min.)	Zwoje gwintu na cal
No.1	0.118	0.073	1/16	0.62	64
No.2	0.140	0.086	5/64	0.62	56
No.3	0.161	0.099	5/64	0.62	48
No.4	0.183	0.112	3/32	0.75	40
No.5	0.205	0.125	3/32	0.75	40
No.6	0.226	0.138	7/64	0.75	32
No.8	0.270	0.164	9/64	0.88	32
No.10	0.312	0.19	5/32	0.88	24
1/4	0.375	0.25	3/16	1	20
5/16	0.469	0.312	1/4	1.12	18
3/8	0.562	0.375	5/16	1.25	16
7/16	0.656	0.438	3/8	1.38	14
1/2	0.750	0.5	3/8	1.5	13
9/16	0.844	0.562	3/8	1.5	12
5/8	0.938	0.625	1/2	1.75	11
3/4	1.125	0.75	5/8	2	10
7/8	1.312	0.875	3/4	2.25	9
1 Inch	1.5	1	3/4	2.5	8
1.1/8	1.688	1.125	7/8	2.81	7
1.1/4	1.875	1.25	7/8	3.12	7
1.3/8	2.062	1.375	1	3.44	6
1.1/2	2.25	1.5	1	3.75	6
1.3/4	2.625	1.75	1 1/4	4.38	5
2 Inch	3	2	1 1/2	5	4.5

- Właściwości mechaniczne odpowiadają w zasadzie klasie właściwości 12.9 zgodn. z DIN ISO 898-1. Inne właściwości zgodn. z ASTM A574.
- Oznaczenie tych śrub nie jest obowiązkowe.
- UWAGA: ponieważ norma produktu wyznacza tolerancję gwintu 3A dla rozmiarów gwintu do 1 cala, cynkowanie może spowodować problemy z pasowaniem gwintu.

Grupy katalogowe

Gwint	Gniazdo	Materiał	Klasa	Obróbka powierzchni	Kod	Strona
UNC	Gniazdo sześciokątne	St	Grade 8		U07000	2-22
UNC	Gniazdo sześciokątne	St	Grade 8	Ocynk.	U07001	2-25
UNC	Gniazdo sześciokątne	St	12.9	Ocynk. mech.	07260	2-25
UNC	Gniazdo sześciokątne	St.St. A2 (AISI304/18-8)	F837B		U51050	2-26
UNC	Gniazdo sześciokątne	St.St. A4 (AISI316/18-10)	F837E		U55050	2-27

U07000 Śruby z łbem walcowym z gniazdem sześciokątnym seria 1936 UNC
X05A

Gwint Calowy, zunifikowany grubozwojny (UNC)
Materiał Stal
Klasa Grade 8



d x L	☒	Kod artykułu	d x L	☒	Kod artykułu	d x L	☒	Kod artykułu
NO.1-64X3/16 ft*	100	U07000.007.0018	NO.1-64X3/4*	100	U07000.007.0075	NO.2-56X5/16 ft*	100	U07000.008.0031
NO.1-64X1/4 ft*	100	U07000.007.0025	NO.1-64X1 Inch*	100	U07000.007.0100	NO.2-56X3/8 ft*	100	U07000.008.0037
NO.1-64X5/16 ft*	100	U07000.007.0031				NO.2-56X7/16 ft*	100	U07000.008.0043
NO.1-64X3/8 ft*	100	U07000.007.0037	NO.2-56X1/8 ft*	100	U07000.008.0012	NO.2-56X1/2 ft*	100	U07000.008.0050
NO.1-64X1/2 ft*	100	U07000.007.0050	NO.2-56X3/16 ft*	100	U07000.008.0018	NO.2-56X5/8 ft*	100	U07000.008.0062
NO.1-64X5/8 ft*	100	U07000.007.0062	NO.2-56X1/4 ft*	100	U07000.008.0025	NO.2-56X3/4*	100	U07000.008.0075

U07000 Śruby z łbem walcowym z gniazdem sześciokątnym seria 1936 UNC								
d x L	☒	Kod artykułu	d x L	☒	Kod artykułu	d x L	☒	Kod artykułu
NO.2-56X7/8*	100	U07000.008.0087	NO.8-32X2 Inch*	100	U07000.016.0200	3/8-16X1/2 ft*	50	U07000.037.0050
NO.2-56X1 Inch*	100	U07000.008.0100	NO.8-32X2.1/4*	100	U07000.016.0225	3/8-16X5/8 ft*	50	U07000.037.0062
NO.3-48X1/8 ft*	100	U07000.009.0012	NO.8-32X2.1/2*	100	U07000.016.0250	3/8-16X3/4 ft*	50	U07000.037.0075
NO.3-48X3/16 ft*	100	U07000.009.0018	NO.8-32X2.3/4*	100	U07000.016.0275	3/8-16X7/8 ft*	50	U07000.037.0087
NO.3-48X1/4 ft*	100	U07000.009.0025	NO.8-32X3 Inch*	100	U07000.016.0300	3/8-16X1 Inch ft*	50	U07000.037.0100
NO.3-48X5/16 ft*	100	U07000.009.0031	NO.10-24X3/16 ft*	100	U07000.019.0018	3/8-16X1.1/8 ft*	50	U07000.037.0112
NO.3-48X3/8 ft*	100	U07000.009.0037	NO.10-24X1/4 ft*	100	U07000.019.0025	3/8-16X1.1/4 ft*	50	U07000.037.0125
NO.3-48X1/2 ft*	100	U07000.009.0050	NO.10-24X5/16 ft*	100	U07000.019.0031	3/8-16X1.3/8*	50	U07000.037.0137
NO.3-48X5/8 ft*	100	U07000.009.0062	NO.10-24X3/8 ft*	100	U07000.019.0037	3/8-16X1.1/2*	25	U07000.037.0150
NO.3-48X3/4*	100	U07000.009.0075	NO.10-24X7/16 ft*	100	U07000.019.0043	3/8-16X1.3/4*	25	U07000.037.0175
NO.3-48X7/8*	100	U07000.009.0087	NO.10-24X1/2 ft*	100	U07000.019.0050	3/8-16X2 Inch*	25	U07000.037.0200
NO.3-48X1 Inch*	100	U07000.009.0100	NO.10-24X5/8 ft*	100	U07000.019.0062	3/8-16X2.1/4*	25	U07000.037.0225
NO.4-40X1/8 ft*	100	U07000.011.0012	NO.10-24X3/4 ft*	100	U07000.019.0075	3/8-16X2.1/2*	25	U07000.037.0250
NO.4-40X3/16 ft*	100	U07000.011.0018	NO.10-24X7/8 ft*	100	U07000.019.0087	3/8-16X2.3/4*	25	U07000.037.0275
NO.4-40X1/4 ft*	100	U07000.011.0025	NO.10-24X1 Inch*	100	U07000.019.0100	3/8-16X3 Inch*	10	U07000.037.0300
NO.4-40X5/16 ft*	100	U07000.011.0031	NO.10-24X1.1/8*	100	U07000.019.0112	3/8-16X3.1/4*	10	U07000.037.0325
NO.4-40X3/8 ft*	100	U07000.011.0037	NO.10-24X1.1/4*	100	U07000.019.0125	3/8-16X3.1/2*	10	U07000.037.0350
NO.4-40X7/16 ft*	100	U07000.011.0043	NO.10-24X1.3/8*	100	U07000.019.0137	3/8-16X3.3/4*	10	U07000.037.0375
NO.4-40X1/2 ft*	100	U07000.011.0050	NO.10-24X1.1/2*	100	U07000.019.0150	3/8-16X4 Inch*	10	U07000.037.0400
NO.4-40X5/8 ft*	100	U07000.011.0062	NO.10-24X1.3/4*	100	U07000.019.0175	3/8-16X4.1/4*	10	U07000.037.0425
NO.4-40X3/4 ft*	100	U07000.011.0075	NO.10-24X2 Inch*	100	U07000.019.0200	3/8-16X4.1/2*	10	U07000.037.0450
NO.4-40X7/8*	100	U07000.011.0087	NO.10-24X2.1/4*	100	U07000.019.0225	3/8-16X4.3/4*	10	U07000.037.0475
NO.4-40X1 Inch*	100	U07000.011.0100	NO.10-24X2.1/2*	100	U07000.019.0250	3/8-16X5 Inch*	10	U07000.037.0500
NO.4-40X1.1/8*	100	U07000.011.0112	NO.10-24X2.3/4*	100	U07000.019.0275	3/8-16X5.1/2*	10	U07000.037.0550
NO.4-40X1.1/4*	100	U07000.011.0125	NO.10-24X3 Inch*	100	U07000.019.0300	3/8-16X6 Inch*	10	U07000.037.0600
NO.4-40X1.3/8*	100	U07000.011.0137	NO.10-24X3.1/4*	100	U07000.019.0325	3/8-16X6.1/2*	5	U07000.037.0650
NO.4-40X1.1/2*	100	U07000.011.0150	NO.10-24X3.1/2*	100	U07000.019.0350	3/8-16X7 Inch*	5	U07000.037.0700
NO.4-40X1.3/4*	100	U07000.011.0175	NO.10-24X3.3/4*	100	U07000.019.0375	3/8-16X7.1/2*	5	U07000.037.0750
NO.4-40X2 Inch*	100	U07000.011.0200	NO.10-24X4 Inch*	100	U07000.019.0400	7/16-14X1/2 ft*	25	U07000.043.0050
NO.5-40X1/8 ft*	100	U07000.012.0012	1/4-20X5/16 ft*	100	U07000.025.0031	7/16-14X5/8 ft*	25	U07000.043.0062
NO.5-40X3/16 ft*	100	U07000.012.0018	1/4-20X3/8 ft*	100	U07000.025.0037	7/16-14X3/4 ft*	25	U07000.043.0075
NO.5-40X1/4 ft*	100	U07000.012.0025	1/4-20X7/16 ft*	100	U07000.025.0043	7/16-14X7/8 ft*	25	U07000.043.0087
NO.5-40X5/16 ft*	100	U07000.012.0031	1/4-20X1/2 ft*	100	U07000.025.0050	7/16-14X1 Inch ft*	25	U07000.043.0100
NO.5-40X3/8 ft*	100	U07000.012.0037	1/4-20X5/8 ft*	100	U07000.025.0062	7/16-14X1.1/4 ft*	25	U07000.043.0125
NO.5-40X7/16 ft*	100	U07000.012.0043	1/4-20X3/4 ft*	100	U07000.025.0075	7/16-14X1.1/2*	25	U07000.043.0150
NO.5-40X1/2 ft*	100	U07000.012.0050	1/4-20X7/8 ft*	100	U07000.025.0087	7/16-14X1.3/4*	10	U07000.043.0175
NO.5-40X5/8 ft*	100	U07000.012.0062	1/4-20X1 Inch ft*	100	U07000.025.0100	7/16-14X2 Inch*	10	U07000.043.0200
NO.5-40X3/4 ft*	100	U07000.012.0075	1/4-20X1.1/8*	100	U07000.025.0112	7/16-14X2.1/4*	10	U07000.043.0225
NO.5-40X7/8*	100	U07000.012.0087	1/4-20X1.1/4*	100	U07000.025.0125	7/16-14X2.1/2*	10	U07000.043.0250
NO.5-40X1 Inch*	100	U07000.012.0100	1/4-20X1.3/8*	100	U07000.025.0137	7/16-14X2.3/4*	10	U07000.043.0275
NO.5-40X1.1/4*	100	U07000.012.0125	1/4-20X1.1/2*	100	U07000.025.0150	7/16-14X3 Inch*	10	U07000.043.0300
NO.5-40X1.1/2*	100	U07000.012.0150	1/4-20X1.3/4*	100	U07000.025.0175	7/16-14X3.1/4*	5	U07000.043.0325
NO.5-40X2 Inch*	100	U07000.012.0200	1/4-20X2 Inch*	50	U07000.025.0200	7/16-14X3.1/2*	5	U07000.043.0350
NO.6-32X3/16 ft*	100	U07000.013.0018	1/4-20X2.1/4*	50	U07000.025.0225	7/16-14X4 Inch*	5	U07000.043.0400
NO.6-32X1/4 ft*	100	U07000.013.0025	1/4-20X2.1/2*	50	U07000.025.0250	7/16-14X4.1/2*	5	U07000.043.0450
NO.6-32X5/16 ft*	100	U07000.013.0031	1/4-20X2.3/4*	50	U07000.025.0275	7/16-14X5 Inch*	5	U07000.043.0500
NO.6-32X3/8 ft*	100	U07000.013.0037	1/4-20X3 Inch*	25	U07000.025.0300	7/16-14X5.1/2*	5	U07000.043.0550
NO.6-32X7/16 ft*	100	U07000.013.0043	1/4-20X3.1/4*	25	U07000.025.0325	7/16-14X6 Inch*	5	U07000.043.0600
NO.6-32X1/2 ft*	100	U07000.013.0050	1/4-20X3.1/2*	25	U07000.025.0350	1/2-13X1/2 ft*	10	U07000.050.0050
NO.6-32X5/8 ft*	100	U07000.013.0062	1/4-20X3.3/4*	25	U07000.025.0375	1/2-13X5/8 ft*	10	U07000.050.0062
NO.6-32X3/4 ft*	100	U07000.013.0075	1/4-20X4 Inch*	25	U07000.025.0400	1/2-13X3/4 ft*	10	U07000.050.0075
NO.6-32X7/8*	100	U07000.013.0087	1/4-20X4.1/4*	25	U07000.025.0425	1/2-13X7/8 ft*	10	U07000.050.0087
NO.6-32X1 Inch*	100	U07000.013.0100	1/4-20X4.1/2*	25	U07000.025.0450	1/2-13X1 Inch ft*	10	U07000.050.0100
NO.6-32X1.1/8*	100	U07000.013.0112	1/4-20X4.3/4*	25	U07000.025.0475	1/2-13X1.1/8 ft*	10	U07000.050.0112
NO.6-32X1.1/4*	100	U07000.013.0125	1/4-20X5 Inch*	25	U07000.025.0500	1/2-13X1.1/4 ft*	10	U07000.050.0125
NO.6-32X1.3/8*	100	U07000.013.0137	5/16-18X3/8 ft*	100	U07000.031.0037	1/2-13X1.3/8 ft*	10	U07000.050.0137
NO.6-32X1.1/2*	100	U07000.013.0150	5/16-18X1/2 ft*	100	U07000.031.0050	1/2-13X1.1/2 ft*	10	U07000.050.0150
NO.6-32X1.3/4*	100	U07000.013.0175	5/16-18X5/8 ft*	100	U07000.031.0062	1/2-13X1.3/4*	10	U07000.050.0175
NO.6-32X2 Inch*	100	U07000.013.0200	5/16-18X3/4 ft*	100	U07000.031.0075	1/2-13X2 Inch*	10	U07000.050.0200
NO.6-32X2.1/4*	100	U07000.013.0225	5/16-18X7/8 ft*	100	U07000.031.0087	1/2-13X2.1/4*	10	U07000.050.0225
NO.6-32X2.1/2*	100	U07000.013.0250	5/16-18X1 Inch ft*	50	U07000.031.0100	1/2-13X2.1/2*	10	U07000.050.0250
NO.6-32X2.3/4*	100	U07000.013.0275	5/16-18X1.1/8 ft*	50	U07000.031.0112	1/2-13X2.3/4*	10	U07000.050.0275
NO.8-32X3/16 ft*	100	U07000.016.0018	5/16-18X1.1/4*	50	U07000.031.0125	1/2-13X3 Inch*	5	U07000.050.0300
NO.8-32X1/4 ft*	100	U07000.016.0025	5/16-18X1.3/8*	50	U07000.031.0137	1/2-13X3.1/4*	5	U07000.050.0325
NO.8-32X5/16 ft*	100	U07000.016.0031	5/16-18X1.1/2*	50	U07000.031.0150	1/2-13X3.1/2*	5	U07000.050.0350
NO.8-32X3/8 ft*	100	U07000.016.0037	5/16-18X1.3/4*	50	U07000.031.0175	1/2-13X3.3/4*	5	U07000.050.0375
NO.8-32X7/16 ft*	100	U07000.016.0043	5/16-18X2 Inch*	50	U07000.031.0200	1/2-13X4 Inch*	5	U07000.050.0400
NO.8-32X1/2 ft*	100	U07000.016.0050	5/16-18X2.1/4*	25	U07000.031.0225	1/2-13X4.1/4*	5	U07000.050.0425
NO.8-32X5/8 ft*	100	U07000.016.0062	5/16-18X2.1/2*	25	U07000.031.0250	1/2-13X4.1/2*	5	U07000.050.0450
NO.8-32X3/4 ft*	100	U07000.016.0075	5/16-18X2.3/4*	25	U07000.031.0275	1/2-13X4.3/4*	5	U07000.050.0475
NO.8-32X7/8 ft*	100	U07000.016.0087	5/16-18X3 Inch*	25	U07000.031.0300	1/2-13X5 Inch*	5	U07000.050.0500
NO.8-32X1 Inch*	100	U07000.016.0100	5/16-18X3.1/4*	25	U07000.031.0325	1/2-13X5.1/4*	5	U07000.050.0525
NO.8-32X1.1/8*	100	U07000.016.0112	5/16-18X3.1/2*	25	U07000.031.0350	1/2-13X5.1/2*	5	U07000.050.0550
NO.8-32X1.1/4*	100	U07000.016.0125	5/16-18X3.3/4*	25	U07000.031.0375	1/2-13X5.3/4*	5	U07000.050.0575
NO.8-32X1.3/8*	100	U07000.016.0137	5/16-18X4 Inch*	10	U07000.031.0400	1/2-13X6 Inch*		

U07000 Śruby z łbem walcowym z gniazdem sześciokątnym seria 1936 UNC

d x L	☒	Kod artykułu	d x L	☒	Kod artykułu	d x L	☒	Kod artykułu
1/2-13X8.1/2*	1	U07000.050.0850	3/4-10X10 Inch*	1	U07000.075.1000	1.1/8-7X13 Inch*	1	U07000.112.1300
1/2-13X9 Inch*	1	U07000.050.0900	3/4-10X11 Inch*	1	U07000.075.1100	1.1/8-7X14 Inch*	1	U07000.112.1400
1/2-13X9.1/2*	1	U07000.050.0950	3/4-10X12 Inch*	1	U07000.075.1200	1.1/8-7X15 Inch*	1	U07000.112.1500
			3/4-10X13 Inch*	1	U07000.075.1300	1.1/8-7X16 Inch*	1	U07000.112.1600
			3/4-10X14 Inch*	1	U07000.075.1400			
9/16-12X1 Inch ft*	10	U07000.056.0100	7/8-9X1.1/4 ft*	5	U07000.087.0125	1.1/4-7X2 Inch ft*	1	U07000.125.0200
9/16-12X1.1/4 ft*	10	U07000.056.0125	7/8-9X1.1/2 ft*	5	U07000.087.0150	1.1/4-7X2.1/4 ft*	1	U07000.125.0225
9/16-12X1.1/2 ft*	10	U07000.056.0150	7/8-9X1.3/4 ft*	5	U07000.087.0175	1.1/4-7X2.1/2 ft*	1	U07000.125.0250
9/16-12X1.3/4*	10	U07000.056.0175	7/8-9X2 Inch ft*	5	U07000.087.0200	1.1/4-7X2.3/4 ft*	1	U07000.125.0275
9/16-12X2 Inch*	5	U07000.056.0200	7/8-9X2.1/4 ft*	5	U07000.087.0225	1.1/4-7X3 Inch ft*	1	U07000.125.0300
9/16-12X2.1/4*	5	U07000.056.0225	7/8-9X2.1/2*	5	U07000.087.0250	1.1/4-7X3.1/2*	1	U07000.125.0350
9/16-12X2.1/2*	5	U07000.056.0250	7/8-9X2.3/4*	5	U07000.087.0275	1.1/4-7X3.3/4*	1	U07000.125.0375
9/16-12X2.3/4*	5	U07000.056.0275	7/8-9X3 Inch*	5	U07000.087.0300	1.1/4-7X4 Inch*	1	U07000.125.0400
9/16-12X3 Inch*	5	U07000.056.0300	7/8-9X3.1/4*	5	U07000.087.0325	1.1/4-7X4.1/2*	1	U07000.125.0450
9/16-12X3.1/2*	5	U07000.056.0350	7/8-9X3.1/2*	5	U07000.087.0350	1.1/4-7X5 Inch*	1	U07000.125.0500
9/16-12X4 Inch*	5	U07000.056.0400	7/8-9X3.3/4*	5	U07000.087.0375	1.1/4-7X5.1/2*	1	U07000.125.0550
9/16-12X4.1/2*	5	U07000.056.0450	7/8-9X4 Inch*	5	U07000.087.0400	1.1/4-7X6 Inch*	1	U07000.125.0600
9/16-12X5 Inch*	5	U07000.056.0500	7/8-9X4.1/2*	5	U07000.087.0450	1.1/4-7X6.1/2*	1	U07000.125.0650
9/16-12X5.1/2*	5	U07000.056.0550	7/8-9X4.3/4*	5	U07000.087.0475	1.1/4-7X7 Inch*	1	U07000.125.0700
9/16-12X6 Inch*	5	U07000.056.0600	7/8-9X5 Inch*	5	U07000.087.0500	1.1/4-7X8 Inch*	1	U07000.125.0800
9/16-12X6.1/2*	5	U07000.056.0650	7/8-9X5.1/2*	5	U07000.087.0550	1.1/4-7X9 Inch*	1	U07000.125.0900
9/16-12X7 Inch*	5	U07000.056.0700	7/8-9X6 Inch*	1	U07000.087.0600	1.1/4-7X10 Inch*	1	U07000.125.1000
9/16-12X7.1/2*	5	U07000.056.0750	7/8-9X6.1/2*	1	U07000.087.0650	1.1/4-7X11 Inch*	1	U07000.125.1100
9/16-12X8 Inch*	5	U07000.056.0800	7/8-9X7 Inch*	1	U07000.087.0700	1.1/4-7X12 Inch*	1	U07000.125.1200
			7/8-9X7.1/2*	1	U07000.087.0750	1.1/4-7X13 Inch*	1	U07000.125.1300
5/8-11X5/8 ft*	10	U07000.062.0062	7/8-9X8 Inch*	1	U07000.087.0800	1.1/4-7X14 Inch*	1	U07000.125.1400
5/8-11X3/4 ft*	10	U07000.062.0075	7/8-9X9 Inch*	1	U07000.087.0900	1.1/4-7X15 Inch*	1	U07000.125.1500
5/8-11X7/8 ft*	10	U07000.062.0087	7/8-9X10 Inch*	1	U07000.087.1000	1.1/4-7X16 Inch*	1	U07000.125.1600
5/8-11X1 Inch ft*	10	U07000.062.0100	7/8-9X11 Inch*	1	U07000.087.1100	1.1/4-7X18 Inch*	1	U07000.125.1800
5/8-11X1.1/4 ft*	10	U07000.062.0125	7/8-9X12 Inch*	1	U07000.087.1200	1.1/4-7X20 Inch*	1	U07000.125.2000
5/8-11X1.3/8 ft*	10	U07000.062.0137	7/8-9X14 Inch*	1	U07000.087.1400			
5/8-11X1.1/2 ft*	10	U07000.062.0150	7/8-9X16 Inch*	1	U07000.087.1600			
5/8-11X1.3/4 ft*	10	U07000.062.0175	7/8-9X18 Inch*	1	U07000.087.1800			
5/8-11X2 Inch*	5	U07000.062.0200				1.3/8-6X3 Inch ft*	1	U07000.137.0300
5/8-11X2.1/4*	5	U07000.062.0225	1.-8X1.1/2 ft*	5	U07000.100.0150	1.3/8-6X3.1/2*	1	U07000.137.0350
5/8-11X2.1/2*	5	U07000.062.0250	1.-8X1.3/4 ft*	5	U07000.100.0175	1.3/8-6X4 Inch*	1	U07000.137.0400
5/8-11X2.3/4*	5	U07000.062.0275	1.-8X2 Inch ft*	5	U07000.100.0200	1.3/8-6X4.1/2*	1	U07000.137.0450
5/8-11X3 Inch*	5	U07000.062.0300	1.-8X2.1/4 ft*	5	U07000.100.0225	1.3/8-6X5 Inch*	1	U07000.137.0500
5/8-11X3.1/4*	5	U07000.062.0325	1.-8X2.1/2 ft*	5	U07000.100.0250	1.3/8-6X5.1/2*	1	U07000.137.0550
5/8-11X3.1/2*	5	U07000.062.0350	1.-8X2.3/4*	5	U07000.100.0275	1.3/8-6X6 Inch*	1	U07000.137.0600
5/8-11X3.3/4*	5	U07000.062.0375	1.-8X3 Inch*	5	U07000.100.0300	1.3/8-6X7 Inch*	1	U07000.137.0700
5/8-11X4 Inch*	5	U07000.062.0400	1.-8X3.1/4*	5	U07000.100.0325	1.3/8-6X8 Inch*	1	U07000.137.0800
5/8-11X4.1/4*	5	U07000.062.0425	1.-8X3.1/2*	5	U07000.100.0350	1.3/8-6X10 Inch*	1	U07000.137.1000
5/8-11X4.1/2*	5	U07000.062.0450	1.-8X3.3/4*	5	U07000.100.0375	1.3/8-6X11 Inch*	1	U07000.137.1100
5/8-11X5 Inch*	5	U07000.062.0500	1.-8X4 Inch*	5	U07000.100.0400	1.3/8-6X12 Inch*	1	U07000.137.1200
5/8-11X5.1/2*	5	U07000.062.0550	1.-8X4.1/4*	5	U07000.100.0425	1.3/8-6X14 Inch*	1	U07000.137.1400
5/8-11X6 Inch*	5	U07000.062.0600	1.-8X4.1/2*	5	U07000.100.0450	1.3/8-6X16 Inch*	1	U07000.137.1600
5/8-11X6.1/2*	5	U07000.062.0650	1.-8X4.3/4*	5	U07000.100.0475	1.3/8-6X18 Inch*	1	U07000.137.1800
5/8-11X7 Inch*	5	U07000.062.0700	1.-8X5 Inch*	5	U07000.100.0500	1.3/8-6X20 Inch*	1	U07000.137.2000
5/8-11X7.1/2*	5	U07000.062.0750	1.-8X5.1/2*	5	U07000.100.0550			
5/8-11X8 Inch*	5	U07000.062.0800	1.-8X6 Inch*	1	U07000.100.0600	1.1/2-6X2.1/2 ft*	1	U07000.150.0250
5/8-11X8.1/2*	1	U07000.062.0850	1.-8X6.1/2*	1	U07000.100.0650	1.1/2-6X2.3/4 ft*	1	U07000.150.0275
5/8-11X9 Inch*	1	U07000.062.0900	1.-8X7 Inch*	1	U07000.100.0700	1.1/2-6X3 Inch ft*	1	U07000.150.0300
5/8-11X9.1/2*	1	U07000.062.0950	1.-8X7.1/2*	1	U07000.100.0750	1.1/2-6X3.1/2 ft*	1	U07000.150.0350
5/8-11X10 Inch*	1	U07000.062.1000	1.-8X8 Inch*	1	U07000.100.0800	1.1/2-6X4 Inch*	1	U07000.150.0400
5/8-11X11 Inch*	1	U07000.062.1100	1.-8X8.1/2*	1	U07000.100.0850	1.1/2-6X4.1/2*	1	U07000.150.0450
			1.-8X9 Inch*	1	U07000.100.0900	1.1/2-6X5 Inch*	1	U07000.150.0500
			1.-8X9.1/2*	1	U07000.100.0950	1.1/2-6X5.1/2*	1	U07000.150.0550
3/4-10X1 Inch ft*	5	U07000.075.0100	1.-8X10 Inch*	1	U07000.100.1000	1.1/2-6X6 Inch*	1	U07000.150.0600
3/4-10X1.1/4 ft*	5	U07000.075.0125	1.-8X11 Inch*	1	U07000.100.1100	1.1/2-6X6.1/2*	1	U07000.150.0650
3/4-10X1.1/2 ft*	5	U07000.075.0150	1.-8X12 Inch*	1	U07000.100.1200	1.1/2-6X7 Inch*	1	U07000.150.0700
3/4-10X1.3/4 ft*	5	U07000.075.0175	1.-8X13 Inch*	1	U07000.100.1300	1.1/2-6X8 Inch*	1	U07000.150.0800
3/4-10X2 Inch ft*	5	U07000.075.0200	1.-8X14 Inch*	1	U07000.100.1400	1.1/2-6X9 Inch*	1	U07000.150.0900
3/4-10X2.1/4*	5	U07000.075.0225	1.-8X16 Inch*	1	U07000.100.1600	1.1/2-6X10 Inch*	1	U07000.150.1000
3/4-10X2.1/2*	5	U07000.075.0250	1.-8X18 Inch*	1	U07000.100.1800	1.1/2-6X11 Inch*	1	U07000.150.1100
3/4-10X2.3/4*	5	U07000.075.0275	1.-8X20 Inch*	1	U07000.100.2000	1.1/2-6X12 Inch*	1	U07000.150.1200
3/4-10X3 Inch*	5	U07000.075.0300				1.1/2-6X13 Inch*	1	U07000.150.1300
3/4-10X3.1/4*	5	U07000.075.0325	1.1/8-7X2 Inch ft*	1	U07000.112.0200	1.1/2-6X14 Inch*	1	U07000.150.1400
3/4-10X3.1/2*	5	U07000.075.0350	1.1/8-7X2.1/2 ft*	1	U07000.112.0250	1.1/2-6X15 Inch*	1	U07000.150.1500
3/4-10X3.3/4*	5	U07000.075.0375	1.1/8-7X3 Inch*	1	U07000.112.0300	1.1/2-6X16 Inch*	1	U07000.150.1600
3/4-10X4 Inch*	5	U07000.075.0400	1.1/8-7X3.1/2*	1	U07000.112.0350	1.1/2-6X18 Inch*	1	U07000.150.1800
3/4-10X4.1/4*	5	U07000.075.0425	1.1/8-7X4 Inch*	1	U07000.112.0400	1.1/2-6X20 Inch*	1	U07000.150.2000
3/4-10X4.1/2*	5	U07000.075.0450	1.1/8-7X4.1/2*	1	U07000.112.0450			
3/4-10X4.3/4*	5	U07000.075.0475	1.1/8-7X5 Inch*	1	U07000.112.0500	1.3/4-5X3 Inch ft*	1	U07000.175.0300
3/4-10X5 Inch*	5	U07000.075.0500	1.1/8-7X5.1/2*	1	U07000.112.0550	1.3/4-5X3.1/2 ft*	1	U07000.175.0350
3/4-10X5.1/2*	5	U07000.075.0550	1.1/8-7X6 Inch*	1	U07000.112.0600	1.3/4-5X4 Inch ft*	1	U07000.175.0400
3/4-10X6 Inch*	5	U07000.075.0600	1.1/8-7X7 Inch*	1	U07000.112.0700	1.3/4-5X4.1/2*	1	U07000.175.0450
3/4-10X6.1/2*	1	U07000.075.0650	1.1/8-7X8 Inch*	1	U07000.112.0800	1.3/4-5X5 Inch*	1	U07000.175.0500
3/4-10X7 Inch*	1	U07000.075.0700	1.1/8-7X9 Inch*	1	U07000.112.0900	1.3/4-5X5.1/2*	1	U07000.175.0550
3/4-10X7.1/2*	1	U07000.075.0750	1.1/8-7X10 Inch*	1	U07000.112.1000	1.3/4-5X6 Inch*	1	U07000.175.0600
3/4-10X8 Inch*	1	U07000.075.0800	1.1/8-7X11 Inch*	1	U07000.112.1100	1.3/4-5X7 Inch*	1	U07000.175.0700
3/4-10X8.1/2*	1	U07000.075.0850	1.1/8-7X12 Inch*	1	U07000.112.1200	1.3/4-5X8 Inch*	1	U07000.175.0800
3/4-10X9 Inch*	1	U07000.075.0900				1.3/4-5X9 Inch*	1	U07000.175.0900
3/4-10X9.1/2*	1	U07000.075.0950				1.3/4-5X10 Inch*	1	U07000.175.1000

2

U07000 Śruby z łbem walcowym z gniazdem sześciokątnym seria 1936 UNC

d x L	☒	Kod artykułu	d x L	☒	Kod artykułu	d x L	☒	Kod artykułu
1.3/4-5X12 Inch*	1	U07000.175.1200	2.-4,5X4. 1/2 ft*	1	U07000.200.0450	2.-4,5X12 Inch*	1	U07000.200.1200
1.3/4-5X14 Inch*	1	U07000.175.1400	2.-4,5X5 Inch ft*	1	U07000.200.0500	2.-4,5X14 Inch*	1	U07000.200.1400
1.3/4-5X15 Inch*	1	U07000.175.1500	2.-4,5X5. 1/2*	1	U07000.200.0550	2.-4,5X15 Inch*	1	U07000.200.1500
1.3/4-5X16 Inch*	1	U07000.175.1600	2.-4,5X6 Inch*	1	U07000.200.0600	2.-4,5X16 Inch*	1	U07000.200.1600
1.3/4-5X18 Inch*	1	U07000.175.1800	2.-4,5X7 Inch*	1	U07000.200.0700	2.-4,5X18 Inch*	1	U07000.200.1800
1.3/4-5X20 Inch*	1	U07000.175.2000	2.-4,5X8 Inch*	1	U07000.200.0800	2.-4,5X20 Inch*	1	U07000.200.2000
2.-4,5X4 Inch ft*	1	U07000.200.0400	2.-4,5X9 Inch*	1	U07000.200.0900			
			2.-4,5X10 Inch*	1	U07000.200.1000			

* ft = z pełnym gwintem

U07001 Śruby z łbem walcowym z gniazdem sześciokątnym seria 1936 UNC
X05A

Gwint	Całowy, zunifikowany grubozwojny (UNC)
Materiał	Stal
Klasa	Grade 8
Obróbka powierzchni	Ocynkowane

d x L	☒	Kod artykułu	d x L	☒	Kod artykułu	d x L	☒	Kod artykułu
NO.2-56X1/4 ft*	100	U07001.008.0025	NO.10-24X1.1/4*	100	U07001.019.0125	3/8-16X2.3/4*	25	U07001.037.0275
NO.2-56X3/8 ft*	100	U07001.008.0037	NO.10-24X1.1/2*	100	U07001.019.0150	3/8-16X3 Inch*	10	U07001.037.0300
			NO.10-24X1.3/4*	100	U07001.019.0175	3/8-16X3.1/2*	10	U07001.037.0350
			NO.10-24X2 Inch*	100	U07001.019.0200	3/8-16X4 Inch*	10	U07001.037.0400
NO.3-48X1/4 ft*	100	U07001.009.0025						
NO.3-48X3/8 ft*	100	U07001.009.0037	1/4-20X3/8 ft*	100	U07001.025.0037	1/2-13X3/4 ft*	10	U07001.050.0075
NO.3-48X5/8 ft*	100	U07001.009.0062	1/4-20X1/2 ft*	100	U07001.025.0050	1/2-13X1 Inch ft*	10	U07001.050.0100
			1/4-20X5/8 ft*	100	U07001.025.0062	1/2-13X1.1/4 ft*	10	U07001.050.0125
NO.4-40X3/16 ft*	100	U07001.011.0018	1/4-20X3/4 ft*	100	U07001.025.0075	1/2-13X1.1/2 ft*	10	U07001.050.0150
NO.4-40X1/4 ft*	100	U07001.011.0025	1/4-20X7/8 ft*	100	U07001.025.0087	1/2-13X1.3/4*	10	U07001.050.0175
NO.4-40X3/8 ft*	100	U07001.011.0037	1/4-20X1 Inch ft*	100	U07001.025.0100	1/2-13X2 Inch*	10	U07001.050.0200
NO.4-40X1/2 ft*	100	U07001.011.0050	1/4-20X1.1/4*	100	U07001.025.0125	1/2-13X2.1/4*	10	U07001.050.0225
NO.4-40X5/8 ft*	100	U07001.011.0062	1/4-20X1.1/2*	100	U07001.025.0150	1/2-13X2.1/2*	10	U07001.050.0250
NO.4-40X3/4 ft*	100	U07001.011.0075	1/4-20X1.3/4*	100	U07001.025.0175	1/2-13X2.3/4*	10	U07001.050.0275
NO.4-40X1 Inch*	100	U07001.011.0100	1/4-20X2 Inch*	50	U07001.025.0200	1/2-13X3 Inch*	5	U07001.050.0300
			1/4-20X2.1/4*	50	U07001.025.0225	1/2-13X3.1/2*	5	U07001.050.0350
NO.5-40X1/4 ft*	100	U07001.012.0025	1/4-20X2.1/2*	50	U07001.025.0250	1/2-13X4 Inch*	5	U07001.050.0400
NO.5-40X3/8 ft*	100	U07001.012.0037	1/4-20X3 Inch*	25	U07001.025.0300			
NO.5-40X1/2 ft*	100	U07001.012.0050						
NO.5-40X5/8 ft*	100	U07001.012.0062	5/16-18X1/2 ft*	100	U07001.031.0050	5/8-11X1.1/4 ft*	10	U07001.062.0125
NO.5-40X3/4 ft*	100	U07001.012.0075	5/16-18X5/8 ft*	100	U07001.031.0062	5/8-11X1.1/2 ft*	10	U07001.062.0150
			5/16-18X3/4 ft*	100	U07001.031.0075	5/8-11X1.3/4 ft*	10	U07001.062.0175
NO.6-32X1/4 ft*	100	U07001.013.0025	5/16-18X7/8 ft*	100	U07001.031.0087	5/8-11X2 Inch*	5	U07001.062.0200
NO.6-32X3/8 ft*	100	U07001.013.0037	5/16-18X7/8 ft*	100	U07001.031.0087	5/8-11X2.1/4*	5	U07001.062.0225
NO.6-32X1/2 ft*	100	U07001.013.0050	5/16-18X1 Inch ft*	50	U07001.031.0100	5/8-11X2.1/2*	5	U07001.062.0250
NO.6-32X5/8 ft*	100	U07001.013.0062	5/16-18X1.1/4*	50	U07001.031.0125	5/8-11X2.3/4*	5	U07001.062.0275
NO.6-32X3/4 ft*	100	U07001.013.0075	5/16-18X1.1/2*	50	U07001.031.0150	5/8-11X3 Inch*	5	U07001.062.0300
NO.6-32X1 Inch*	100	U07001.013.0100	5/16-18X1.3/4*	50	U07001.031.0175	5/8-11X3.1/2*	5	U07001.062.0350
			5/16-18X2 Inch*	50	U07001.031.0200	5/8-11X4 Inch*	5	U07001.062.0400
NO.8-32X1/4 ft*	100	U07001.016.0025	5/16-18X2.1/4*	25	U07001.031.0225			
NO.8-32X3/8 ft*	100	U07001.016.0037	5/16-18X2.1/2*	25	U07001.031.0250	3/4-10X1.1/4 ft*	5	U07001.075.0125
NO.8-32X1/2 ft*	100	U07001.016.0050	5/16-18X3 Inch*	25	U07001.031.0300	3/4-10X1.1/2 ft*	5	U07001.075.0150
NO.8-32X5/8 ft*	100	U07001.016.0062	5/16-18X3.1/2*	25	U07001.031.0350	3/4-10X1.3/4 ft*	5	U07001.075.0175
NO.8-32X3/4 ft*	100	U07001.016.0075	5/16-18X4 Inch*	10	U07001.031.0400	3/4-10X2 Inch ft*	5	U07001.075.0200
NO.8-32X7/8 ft*	100	U07001.016.0087				3/4-10X2.1/4*	5	U07001.075.0225
NO.8-32X1 Inch*	100	U07001.016.0100	3/8-16X1/2 ft*	50	U07001.037.0050	3/4-10X2.1/2*	5	U07001.075.0250
NO.8-32X1.1/4*	100	U07001.016.0125	3/8-16X3/4 ft*	50	U07001.037.0075	3/4-10X2.3/4*	5	U07001.075.0275
NO.8-32X1.1/2*	100	U07001.016.0150	3/8-16X7/8 ft*	50	U07001.037.0087	3/4-10X3 Inch*	5	U07001.075.0300
			3/8-16X1 Inch ft*	50	U07001.037.0100	3/4-10X3.1/2*	5	U07001.075.0350
NO.10-24X3/8 ft*	100	U07001.019.0037	3/8-16X1.1/4 ft*	50	U07001.037.0125	3/4-10X4 Inch*	5	U07001.075.0400
NO.10-24X1/2 ft*	100	U07001.019.0050	3/8-16X1.1/2*	25	U07001.037.0150	3/4-10X5 Inch*	5	U07001.075.0500
NO.10-24X5/8 ft*	100	U07001.019.0062	3/8-16X1.3/4*	25	U07001.037.0175	3/4-10X6.1/2*	5	U07001.075.0650
NO.10-24X3/4 ft*	100	U07001.019.0075	3/8-16X2 Inch*	25	U07001.037.0200	3/4-10X7 Inch*	5	U07001.075.0700
NO.10-24X7/8 ft*	100	U07001.019.0087	3/8-16X2.1/4*	25	U07001.037.0225	3/4-10X8 Inch*	5	U07001.075.0800
NO.10-24X1 Inch*	100	U07001.019.0100	3/8-16X2.1/2*	25	U07001.037.0250			

* ft = z pełnym gwintem

07260 Śruby z łbem walcowym z gniazdem sześciokątnym seria 1936 UNC
X05A

Gwint	Całowy, zunifikowany grubozwojny (UNC)
Materiał	Stal
Klasa	12.9
Obróbka powierzchni	Ocynkowane mechanicznie

d x L	☒	Kod artykułu	d x L	☒	Kod artykułu	d x L	☒	Kod artykułu
1/4X3/8 ft	100	07260.063.009	5/16X1/2 ft	100	07260.079.012	3/8X7/8 ft	100	07260.096.022
1/4X5/8 ft	100	07260.063.015	5/16X1 Inch ft	100	07260.079.025	3/8X1.1/4 ft	100	07260.096.031
1/4X1.1/4	100	07260.063.031						

07260 Śruby z łbem walcowym z gniazdem sześciokątnym seria 1936 UNC

d x L	☒	Kod artykułu	d x L	☒	Kod artykułu	d x L	☒	Kod artykułu
3/8X1.1/2	100	07260.096.038	1/2X5/8 ft	50	07260.127.015	5/8X2.1/4	25	07260.158.057
3/8X1.3/4	50	07260.096.044	1/2X3/4 ft	50	07260.127.019			
1/2X1/2 ft	50	07260.127.012	1/2X1 Inch ft	50	07260.127.025			
			1/2X1.1/4 ft	50	07260.127.031			

• ft = z pełnym gwintem

U51050 Śruby z łbem walcowym z gniazdem sześciokątnym seria 1936 UNC
X15A

Gwint Calowy, zunifikowany grubozwojny (UNC)
Materiał Stal nierdzewna A2 (AISI 304/18-8)
Klasa F837B



d x L	☒	Kod artykułu	d x L	☒	Kod artykułu	d x L	☒	Kod artykułu
NO.1-64X1/8 ft*	100	U51050.007.0012	NO.6-32X3/16 ft*	100	U51050.013.0018	1/4-20X1/2 ft*	100	U51050.025.0050
NO.1-64X3/16 ft*	100	U51050.007.0018	NO.6-32X1/4 ft*	100	U51050.013.0025	1/4-20X5/8 ft*	100	U51050.025.0062
NO.1-64X1/4 ft*	100	U51050.007.0025	NO.6-32X5/16 ft*	100	U51050.013.0031	1/4-20X3/4 ft*	100	U51050.025.0075
NO.1-64X5/16 ft*	100	U51050.007.0031	NO.6-32X3/8 ft*	100	U51050.013.0037	1/4-20X7/8 ft*	100	U51050.025.0087
NO.1-64X3/8 ft*	100	U51050.007.0037	NO.6-32X7/16 ft*	100	U51050.013.0043	1/4-20X1 Inch ft*	100	U51050.025.0100
NO.1-64X1/2 ft*	100	U51050.007.0050	NO.6-32X1/2 ft*	100	U51050.013.0050	1/4-20X1.1/8*	100	U51050.025.0112
NO.1-64X5/8 ft*	100	U51050.007.0062	NO.6-32X5/8 ft*	100	U51050.013.0062	1/4-20X1.1/4*	100	U51050.025.0125
NO.1-64X3/4*	100	U51050.007.0075	NO.6-32X3/4 ft*	100	U51050.013.0075	1/4-20X1.3/8*	100	U51050.025.0137
NO.1-64X1 Inch*	100	U51050.007.0100	NO.6-32X7/8*	100	U51050.013.0087	1/4-20X1.1/2*	100	U51050.025.0150
			NO.6-32X1 Inch*	100	U51050.013.0100	1/4-20X1.3/4*	100	U51050.025.0175
			NO.6-32X1.1/8*	100	U51050.013.0112	1/4-20X2 Inch*	50	U51050.025.0200
			NO.6-32X1.1/4*	100	U51050.013.0125	1/4-20X2.1/4*	50	U51050.025.0225
			NO.6-32X1.1/2*	100	U51050.013.0150	1/4-20X2.1/2*	50	U51050.025.0250
			NO.6-32X1.3/4*	100	U51050.013.0175	1/4-20X2.3/4*	50	U51050.025.0275
			NO.6-32X2 Inch*	100	U51050.013.0200	1/4-20X3 Inch*	25	U51050.025.0300
			NO.6-32X2.1/4*	100	U51050.013.0225	1/4-20X3.1/4*	25	U51050.025.0325
			NO.6-32X2.1/2*	100	U51050.013.0250	1/4-20X3.1/2*	25	U51050.025.0350
						1/4-20X3.3/4*	25	U51050.025.0375
			NO.8-32X3/16 ft*	100	U51050.016.0018	1/4-20X4 Inch*	25	U51050.025.0400
			NO.8-32X1/4 ft*	100	U51050.016.0025	1/4-20X4.1/2*	25	U51050.025.0450
			NO.8-32X5/16 ft*	100	U51050.016.0031	1/4-20X5 Inch*	25	U51050.025.0500
			NO.8-32X3/8 ft*	100	U51050.016.0037			
			NO.8-32X7/16 ft*	100	U51050.016.0043	5/16-18X3/8 ft*	100	U51050.031.0037
			NO.8-32X1/2 ft*	100	U51050.016.0050	5/16-18X7/16 ft*	100	U51050.031.0043
			NO.8-32X5/8 ft*	100	U51050.016.0062	5/16-18X1/2 ft*	100	U51050.031.0050
			NO.8-32X3/4 ft*	100	U51050.016.0075	5/16-18X5/8 ft*	100	U51050.031.0062
			NO.8-32X7/8 ft*	100	U51050.016.0087	5/16-18X3/4 ft*	100	U51050.031.0075
			NO.8-32X1 Inch*	100	U51050.016.0100	5/16-18X7/8 ft*	100	U51050.031.0087
			NO.8-32X1.1/8*	100	U51050.016.0112	5/16-18X1 Inch ft*	50	U51050.031.0100
			NO.8-32X1.1/4*	100	U51050.016.0125	5/16-18X1.1/8 ft*	50	U51050.031.0112
			NO.8-32X1.3/8*	100	U51050.016.0137	5/16-18X1.1/4*	50	U51050.031.0125
			NO.8-32X1.1/2*	100	U51050.016.0150	5/16-18X1.1/2*	50	U51050.031.0150
			NO.8-32X1.3/4*	100	U51050.016.0175	5/16-18X1.3/4*	50	U51050.031.0175
			NO.8-32X2 Inch*	100	U51050.016.0200	5/16-18X2 Inch*	50	U51050.031.0200
			NO.8-32X2.1/4*	100	U51050.016.0225	5/16-18X2.1/4*	25	U51050.031.0225
			NO.8-32X2.1/2*	100	U51050.016.0250	5/16-18X2.1/2*	25	U51050.031.0250
			NO.8-32X2.3/4*	100	U51050.016.0275	5/16-18X2.3/4*	25	U51050.031.0275
			NO.8-32X3 Inch*	100	U51050.016.0300	5/16-18X3 Inch*	25	U51050.031.0300
						5/16-18X3.1/4*	25	U51050.031.0325
			NO.10-24X3/16 ft*	100	U51050.019.0018	5/16-18X3.1/2*	25	U51050.031.0350
			NO.10-24X1/4 ft*	100	U51050.019.0025	5/16-18X3.3/4*	25	U51050.031.0375
			NO.10-24X5/16 ft*	100	U51050.019.0031	5/16-18X4 Inch*	10	U51050.031.0400
			NO.10-24X3/8 ft*	100	U51050.019.0037	5/16-18X4.1/2*	10	U51050.031.0450
			NO.10-24X7/16 ft*	100	U51050.019.0043	5/16-18X5 Inch*	10	U51050.031.0500
			NO.10-24X1/2 ft*	100	U51050.019.0050	5/16-18X5.1/2*	10	U51050.031.0550
			NO.10-24X5/8 ft*	100	U51050.019.0062	5/16-18X6 Inch*	10	U51050.031.0600
			NO.10-24X3/4 ft*	100	U51050.019.0075			
			NO.10-24X7/8 ft*	100	U51050.019.0087	3/8-16X1/2 ft*	50	U51050.037.0050
			NO.10-24X1 Inch*	100	U51050.019.0100	3/8-16X5/8 ft*	50	U51050.037.0062
			NO.10-24X1.1/8*	100	U51050.019.0112	3/8-16X3/4 ft*	50	U51050.037.0075
			NO.10-24X1.1/4*	100	U51050.019.0125	3/8-16X7/8 ft*	50	U51050.037.0087
			NO.10-24X1.3/8*	100	U51050.019.0137	3/8-16X1 Inch ft*	50	U51050.037.0100
			NO.10-24X1.1/2*	100	U51050.019.0150	3/8-16X1.1/8 ft*	50	U51050.037.0112
			NO.10-24X1.3/4*	100	U51050.019.0175	3/8-16X1.1/4 ft*	50	U51050.037.0125
			NO.10-24X2 Inch*	100	U51050.019.0200	3/8-16X1.3/8*	50	U51050.037.0137
			NO.10-24X2.1/4*	100	U51050.019.0225	3/8-16X1.1/2*	25	U51050.037.0150
			NO.10-24X2.1/2*	100	U51050.019.0250	3/8-16X1.3/4*	25	U51050.037.0175
			NO.10-24X2.3/4*	100	U51050.019.0275	3/8-16X2 Inch*	25	U51050.037.0200
			NO.10-24X3 Inch*	100	U51050.019.0300	3/8-16X2.1/4*	25	U51050.037.0225
			NO.10-24X3.1/2*	100	U51050.019.0350	3/8-16X2.1/2*	25	U51050.037.0250
			NO.10-24X4 Inch*	100	U51050.019.0400	3/8-16X2.3/4*	25	U51050.037.0275
						3/8-16X3 Inch*	10	U51050.037.0300
			1/4-20X5/16 ft*	100	U51050.025.0031	3/8-16X3.1/4*	10	U51050.037.0325
			1/4-20X3/8 ft*	100	U51050.025.0037	3/8-16X3.1/2*	10	U51050.037.0350
			1/4-20X7/16 ft*	100	U51050.025.0043	3/8-16X3.3/4*	10	U51050.037.0375

U51050 Śruby z łbem walcowym z gniazdem sześciokątnym seria 1936 UNC

d x L	☒	Kod artykułu	d x L	☒	Kod artykułu	d x L	☒	Kod artykułu
3/8-16X4 Inch*	10	U51050.037.0400	1/2-13X5.1/2*	5	U51050.050.0550	3/4-10X3 Inch*	5	U51050.075.0300
3/8-16X4.1/2*	10	U51050.037.0450	1/2-13X6 Inch*	5	U51050.050.0600	3/4-10X3.1/2*	5	U51050.075.0350
3/8-16X5 Inch*	10	U51050.037.0500	1/2-13X6.1/2*	5	U51050.050.0650	3/4-10X4 Inch*	5	U51050.075.0400
3/8-16X5.1/2*	10	U51050.037.0550	1/2-13X7 Inch*	5	U51050.050.0700	3/4-10X4.1/2*	5	U51050.075.0450
3/8-16X6 Inch*	10	U51050.037.0600	1/2-13X7.1/2*	5	U51050.050.0750	3/4-10X5 Inch*	5	U51050.075.0500
3/8-16X6.1/2*	5	U51050.037.0650	1/2-13X8 Inch*	5	U51050.050.0800	3/4-10X6 Inch*	5	U51050.075.0600
3/8-16X7 Inch*	5	U51050.037.0700				3/4-10X6.1/2*	5	U51050.075.0650
			9/16-12X1 Inch ft*	10	U51050.056.0100	3/4-10X7 Inch*	5	U51050.075.0700
7/16-14X3/4 ft*	25	U51050.043.0075	9/16-12X1.1/2 ft*	10	U51050.056.0150	3/4-10X8 Inch*	5	U51050.075.0800
7/16-14X1 Inch ft*	25	U51050.043.0100	9/16-12X2.1/2*	5	U51050.056.0250			
7/16-14X1.1/4 ft*	25	U51050.043.0125	9/16-12X3 Inch*	5	U51050.056.0300	7/8-9X2 Inch ft*	5	U51050.087.0200
7/16-14X1.1/2*	25	U51050.043.0150				7/8-9X2.1/4 ft*	5	U51050.087.0225
7/16-14X1.3/4*	10	U51050.043.0175	5/8-11X1 Inch ft*	10	U51050.062.0100	7/8-9X2.1/2*	5	U51050.087.0250
7/16-14X2 Inch*	10	U51050.043.0200	5/8-11X1.1/4 ft*	10	U51050.062.0125	7/8-9X2.3/4*	5	U51050.087.0275
7/16-14X2.1/4*	10	U51050.043.0225	5/8-11X1.1/2 ft*	10	U51050.062.0150	7/8-9X3 Inch*	5	U51050.087.0300
7/16-14X2.1/2*	10	U51050.043.0250	5/8-11X1.3/4 ft*	10	U51050.062.0175	7/8-9X3.1/2*	5	U51050.087.0350
7/16-14X3 Inch*	10	U51050.043.0300	5/8-11X2 Inch*	5	U51050.062.0200	7/8-9X4 Inch*	5	U51050.087.0400
7/16-14X3.1/2*	5	U51050.043.0350	5/8-11X2.1/4*	5	U51050.062.0225	7/8-9X4.1/2*	5	U51050.087.0450
7/16-14X4 Inch*	5	U51050.043.0400	5/8-11X2.1/2*	5	U51050.062.0250	7/8-9X5 Inch*	5	U51050.087.0500
			5/8-11X2.3/4*	5	U51050.062.0275	7/8-9X6 Inch*	5	U51050.087.0600
1/2-13X1/2 ft*	10	U51050.050.0050	5/8-11X3 Inch*	5	U51050.062.0300	7/8-9X6.1/2*	5	U51050.087.0650
1/2-13X5/8 ft*	10	U51050.050.0062	5/8-11X3.1/2*	5	U51050.062.0350	7/8-9X7 Inch*	5	U51050.087.0700
1/2-13X3/4 ft*	10	U51050.050.0075	5/8-11X4 Inch*	5	U51050.062.0400	7/8-9X8 Inch*	1	U51050.087.0800
1/2-13X7/8 ft*	10	U51050.050.0087	5/8-11X4.1/2*	5	U51050.062.0450			
1/2-13X1 Inch ft*	10	U51050.050.0100	5/8-11X5 Inch*	5	U51050.062.0500	1.-8X2 Inch ft*	5	U51050.100.0200
1/2-13X1.1/4 ft*	10	U51050.050.0125	5/8-11X5.1/2*	5	U51050.062.0550	1.-8X2.1/4 ft*	5	U51050.100.0225
1/2-13X1.1/2 ft*	10	U51050.050.0150	5/8-11X6 Inch*	5	U51050.062.0600	1.-8X2.1/2 ft*	5	U51050.100.0250
1/2-13X1.3/4*	10	U51050.050.0175	5/8-11X7 Inch*	5	U51050.062.0700	1.-8X2.3/4*	5	U51050.100.0275
1/2-13X2 Inch*	10	U51050.050.0200	5/8-11X8 Inch*	5	U51050.062.0800	1.-8X3 Inch*	5	U51050.100.0300
1/2-13X2.1/4*	10	U51050.050.0225				1.-8X3.1/2*	5	U51050.100.0350
1/2-13X2.1/2*	10	U51050.050.0250	3/4-10X1 Inch ft*	5	U51050.075.0100	1.-8X4 Inch*	5	U51050.100.0400
1/2-13X2.3/4*	10	U51050.050.0275	3/4-10X1.1/4 ft*	5	U51050.075.0125	1.-8X4.1/2*	5	U51050.100.0450
1/2-13X3 Inch*	5	U51050.050.0300	3/4-10X1.1/2 ft*	5	U51050.075.0150	1.-8X5 Inch*	5	U51050.100.0500
1/2-13X3.1/4*	5	U51050.050.0325	3/4-10X1.3/4 ft*	5	U51050.075.0175	1.-8X6 Inch*	5	U51050.100.0600
1/2-13X3.1/2*	5	U51050.050.0350	3/4-10X2 Inch ft*	5	U51050.075.0200	1.-8X6.1/2*	1	U51050.100.0650
1/2-13X4 Inch*	5	U51050.050.0400	3/4-10X2.1/4*	5	U51050.075.0225	1.-8X7 Inch*	1	U51050.100.0700
1/2-13X4.1/2*	5	U51050.050.0450	3/4-10X2.1/2*	5	U51050.075.0250	1.-8X8 Inch*	1	U51050.100.0800
1/2-13X5 Inch*	5	U51050.050.0500	3/4-10X2.3/4*	5	U51050.075.0275			

* ft = z pełnym gwintem

U55050 Śruby z łbem walcowym z gniazdem sześciokątnym seria 1936 UNC

Gwint	Całowy, zunifikowany grubozwojny (UNC)	X15A
Materiał	Stal nierdzewna A4 (AISI 316/18-10)	
Klasa	F837E	



d x L	☒	Kod artykułu	d x L	☒	Kod artykułu	d x L	☒	Kod artykułu
NO.2-56X1/4 ft*	100	U55050.008.0025	NO.8-32X1/4 ft*	100	U55050.016.0025	1/4-20X2.1/4*	50	U55050.025.0225
NO.2-56X3/8 ft*	100	U55050.008.0037	NO.8-32X3/8 ft*	100	U55050.016.0037	1/4-20X2.1/2*	50	U55050.025.0250
			NO.8-32X1/2 ft*	100	U55050.016.0050	1/4-20X3 Inch*	25	U55050.025.0300
NO.3-48X1/4 ft*	100	U55050.009.0025	NO.8-32X5/8 ft*	100	U55050.016.0062			
NO.3-48X5/8 ft*	100	U55050.009.0062	NO.8-32X3/4 ft*	100	U55050.016.0075	5/16-18X1/2 ft*	100	U55050.031.0050
			NO.8-32X7/8 ft*	100	U55050.016.0087	5/16-18X5/8 ft*	100	U55050.031.0062
NO.4-40X3/16 ft*	100	U55050.011.0018	NO.8-32X1 Inch*	100	U55050.016.0100	5/16-18X3/4 ft*	100	U55050.031.0075
NO.4-40X1/4 ft*	100	U55050.011.0025	NO.8-32X1.1/4*	100	U55050.016.0125	5/16-18X7/8 ft*	100	U55050.031.0087
NO.4-40X5/16 ft*	100	U55050.011.0031	NO.8-32X1.1/2*	100	U55050.016.0150	5/16-18X1 Inch ft*	50	U55050.031.0100
NO.4-40X3/8 ft*	100	U55050.011.0037				5/16-18X1.1/4*	50	U55050.031.0125
NO.4-40X1/2 ft*	100	U55050.011.0050	NO.10-24X3/8 ft*	100	U55050.019.0037	5/16-18X1.1/2*	50	U55050.031.0150
NO.4-40X5/8 ft*	100	U55050.011.0062	NO.10-24X1/2 ft*	100	U55050.019.0050	5/16-18X1.3/4*	50	U55050.031.0175
NO.4-40X3/4 ft*	100	U55050.011.0075	NO.10-24X5/8 ft*	100	U55050.019.0062	5/16-18X2 Inch*	50	U55050.031.0200
NO.4-40X1 Inch*	100	U55050.011.0100	NO.10-24X3/4 ft*	100	U55050.019.0075	5/16-18X2.1/4*	25	U55050.031.0225
			NO.10-24X7/8 ft*	100	U55050.019.0087	5/16-18X2.1/2*	25	U55050.031.0250
NO.5-40X1/4 ft*	100	U55050.012.0025	NO.10-24X1 Inch*	100	U55050.019.0100	5/16-18X3 Inch*	25	U55050.031.0300
NO.5-40X3/8 ft*	100	U55050.012.0037	NO.10-24X1.1/4*	100	U55050.019.0125	5/16-18X3.1/2*	25	U55050.031.0350
NO.5-40X1/2 ft*	100	U55050.012.0050	NO.10-24X1.1/2*	100	U55050.019.0150	5/16-18X4 Inch*	10	U55050.031.0400
NO.5-40X5/8 ft*	100	U55050.012.0062	NO.10-24X1.3/4*	100	U55050.019.0175			
NO.5-40X3/4 ft*	100	U55050.012.0075	NO.10-24X2 Inch*	100	U55050.019.0200	3/8-16X1/2 ft*	50	U55050.037.0050
						3/8-16X5/8 ft*	50	U55050.037.0062
NO.6-32X1/4 ft*	100	U55050.013.0025	1/4-20X3/8 ft*	100	U55050.025.0037	3/8-16X3/4 ft*	50	U55050.037.0075
NO.6-32X5/16 ft*	100	U55050.013.0031	1/4-20X1/2 ft*	100	U55050.025.0050	3/8-16X1 Inch ft*	50	U55050.037.0100
NO.6-32X3/8 ft*	100	U55050.013.0037	1/4-20X5/8 ft*	100	U55050.025.0062	3/8-16X1.1/4 ft*	50	U55050.037.0125
NO.6-32X1/2 ft*	100	U55050.013.0050	1/4-20X3/4 ft*	100	U55050.025.0075	3/8-16X1.1/2*	25	U55050.037.0150
NO.6-32X5/8 ft*	100	U55050.013.0062	1/4-20X7/8 ft*	100	U55050.025.0087	3/8-16X1.3/4*	25	U55050.037.0175
NO.6-32X3/4 ft*	100	U55050.013.0075	1/4-20X1 Inch ft*	100	U55050.025.0100	3/8-16X2 Inch*	25	U55050.037.0200
NO.6-32X1 Inch*	100	U55050.013.0100	1/4-20X1.1/4*	100	U55050.025.0125	3/8-16X2.1/2*	25	U55050.037.0250
NO.6-32X1.1/4*	100	U55050.013.0125	1/4-20X1.1/2*	100	U55050.025.0150	3/8-16X3 Inch*	10	U55050.037.0300
NO.6-32X1.1/2*	100	U55050.013.0150	1/4-20X1.3/4*	100	U55050.025.0175			
			1/4-20X2 Inch*	50	U55050.025.0200	7/16-14X1.1/2*	25	U55050.043.0150

U55050 Śruby z łbem walcowym z gniazdem sześciokątnym seria 1936 UNC

d x L	☒	Kod artykułu	d x L	☒	Kod artykułu	d x L	☒	Kod artykułu
7/16-14X2 Inch*	10	U55050.043.0200	1/2-13X3.1/2*	5	U55050.050.0350	5/8-11X3.1/2*	5	U55050.062.0350
1/2-13X3/4 ft*	10	U55050.050.0075	1/2-13X4 Inch*	5	U55050.050.0400	5/8-11X4 Inch*	5	U55050.062.0400
1/2-13X1 Inch ft*	10	U55050.050.0100	5/8-11X1 Inch ft*	10	U55050.062.0100	3/4-10X1.1/4 ft*	5	U55050.075.0125
1/2-13X1.1/4 ft*	10	U55050.050.0125	5/8-11X1.1/4 ft*	10	U55050.062.0125	3/4-10X1.1/2 ft*	5	U55050.075.0150
1/2-13X1.1/2 ft*	10	U55050.050.0150	5/8-11X1.1/2 ft*	10	U55050.062.0150	3/4-10X1.3/4 ft*	5	U55050.075.0175
1/2-13X1.3/4*	10	U55050.050.0175	5/8-11X1.3/4 ft*	10	U55050.062.0175	3/4-10X2 Inch ft*	5	U55050.075.0200
1/2-13X2 Inch*	10	U55050.050.0200	5/8-11X2 Inch*	5	U55050.062.0200	3/4-10X2.1/2*	5	U55050.075.0250
1/2-13X2.1/4*	10	U55050.050.0225	5/8-11X2.1/4*	5	U55050.062.0225	3/4-10X3 Inch*	5	U55050.075.0300
1/2-13X2.1/2*	10	U55050.050.0250	5/8-11X2.1/2*	5	U55050.062.0250	3/4-10X4 Inch*	5	U55050.075.0400
1/2-13X3 Inch*	5	U55050.050.0300	5/8-11X3 Inch*	5	U55050.062.0300			

* ft = z pełnym gwintem

Śruby z łbem walcowym z gniazdem sześciokątnym seria 1936 UNF

ASME ≈B18.3 (1936)

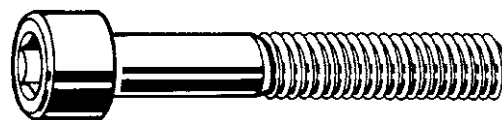
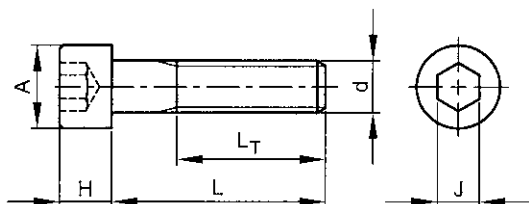
Informacje techniczne

d	A	H	J	L _T (min.)	Zwoje gwintu na cal
No.0	0.096	0.06	0.05	0.5	80
No.1	0.118	0.073	1/16	0.62	72
No.2	0.140	0.086	5/64	0.62	64
No.3	0.161	0.099	5/64	0.62	56
No.4	0.183	0.112	3/32	0.75	48
No.5	0.205	0.125	3/32	0.75	44
No.6	0.026	0.138	7/64	0.75	40
No.8	0.270	0.164	9/64	0.88	36
No.10	0.312	0.19	5/32	0.88	32
1/4	0.375	0.25	3/16	1	28
5/16	0.469	0.312	1/4	1.12	24
3/8	0.562	0.375	5/16	1.25	24
7/16	0.656	0.438	3/8	1.38	20
1/2	0.750	0.5	3/8	1.5	20
9/16	0.844	0.562	3/8	1.5	18
5/8	0.938	0.625	1/2	1.75	18
3/4	1.125	0.75	5/8	2	16
7/8	1.312	0.875	3/4	2.25	14
1.1/8	1.688	1.125	7/8	2.81	12
1.1/4	1.875	1.25	7/8	3.12	12
1.3/8	2.062	1.375	1	3.44	12
1.1/2	2.25	1.5	1	3.75	12

- Właściwości mechaniczne odpowiadają w zasadzie klasie właściwości 12.9 zgodn. z DIN ISO 898-1.
- Inne właściwości zgodn. z ASTM A574.
- Oznaczenie tych śrub nie jest obowiązkowe.
- UWAGA: ponieważ norma produktu wyznacza tolerancję gwintu 3A dla rozmiarów gwintu do 1 cala, cynkowanie może spowodować problemy z pasowaniem gwintu.

Grupy katalogowe

Gwint	Gniazdo	Materiał	Klasa	Obróbka powierzchni	Kod	Strona
UNF	Gniazdo sześciokątne	St	Grade 8		U07040	2-29
UNF	Gniazdo sześciokątne	St	12.9	Ocynk. mech.	07250	2-30
UNF	Gniazdo sześciokątne	St.St. A2 (AISI304/18-8)	F837B		U51041	2-30
UNF	Gniazdo sześciokątne	St.St. A4 (AISI316/18-10)	F837E		U55041	2-31

U07040	Śruby z łbem walcowym z gniazdem sześciokątnym seria 1936 UNF	X05A
Gwint	Całowy, zunifikowany drobnozwojny (UNF)	
Materiał	Stal	
Klasa	Grade 8	

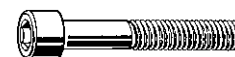

d x L	☒	Kod artykułu	d x L	☒	Kod artykułu	d x L	☒	Kod artykułu
NO.0-80X1/16 ft*	100	U07040.006.0006	NO.8-36X1.1/4*	100	U07040.016.0125	3/8-24X7/8 ft*	50	U07040.037.0087
NO.0-80X1/8 ft*	100	U07040.006.0012	NO.8-36X1.1/2*	100	U07040.016.0150	3/8-24X1 Inch ft*	50	U07040.037.0100
NO.0-80X3/16 ft*	100	U07040.006.0018				3/8-24X1.1/8 ft*	50	U07040.037.0112
NO.0-80X1/4 ft*	100	U07040.006.0025	NO.10-32X3/16 ft*	100	U07040.019.0018	3/8-24X1.1/4 ft*	50	U07040.037.0125
NO.0-80X5/16 ft*	100	U07040.006.0031	NO.10-32X1/4 ft*	100	U07040.019.0025	3/8-24X1.3/8*	50	U07040.037.0137
NO.0-80X3/8 ft*	100	U07040.006.0037	NO.10-32X5/16 ft*	100	U07040.019.0031	3/8-24X1.1/2*	25	U07040.037.0150
NO.0-80X1/2 ft*	100	U07040.006.0050	NO.10-32X3/8 ft*	100	U07040.019.0037	3/8-24X1.3/4*	25	U07040.037.0175
NO.0-80X5/8*	100	U07040.006.0062	NO.10-32X7/16 ft*	100	U07040.019.0043	3/8-24X2 Inch*	25	U07040.037.0200
NO.0-80X3/4*	100	U07040.006.0075	NO.10-32X1/2 ft*	100	U07040.019.0050	3/8-24X2.1/4*	25	U07040.037.0225
NO.0-80X1 Inch*	100	U07040.006.0100	NO.10-32X5/8 ft*	100	U07040.019.0062	3/8-24X2.1/2*	25	U07040.037.0250
			NO.10-32X3/4 ft*	100	U07040.019.0075	3/8-24X2.3/4*	25	U07040.037.0275
NO.1-72X1/8 ft*	100	U07040.007.0012	NO.10-32X7/8 ft*	100	U07040.019.0087	3/8-24X3 Inch*	10	U07040.037.0300
NO.1-72X3/16 ft*	100	U07040.007.0018	NO.10-32X1 Inch*	100	U07040.019.0100	3/8-24X3.1/4*	10	U07040.037.0325
NO.1-72X1/4 ft*	100	U07040.007.0025	NO.10-32X1.1/8*	100	U07040.019.0112	3/8-24X3.1/2*	10	U07040.037.0350
NO.1-72X3/8 ft*	100	U07040.007.0037	NO.10-32X1.1/4*	100	U07040.019.0125	3/8-24X3.3/4*	10	U07040.037.0375
NO.1-72X1/2 ft*	100	U07040.007.0050	NO.10-32X1.3/8*	100	U07040.019.0137	3/8-24X4 Inch*	10	U07040.037.0400
NO.1-72X5/8 ft*	100	U07040.007.0062	NO.10-32X1.1/2*	100	U07040.019.0150	3/8-24X4.1/2*	10	U07040.037.0450
NO.1-72X3/4*	100	U07040.007.0075	NO.10-32X1.3/4*	100	U07040.019.0175	3/8-24X5 Inch*	10	U07040.037.0500
NO.1-72X1 Inch*	100	U07040.007.0100	NO.10-32X2 Inch*	100	U07040.019.0200	3/8-24X5.1/2*	10	U07040.037.0550
			NO.10-32X2.1/4*	100	U07040.019.0225	3/8-24X6 Inch*	10	U07040.037.0600
NO.2-64X1/8 ft*	100	U07040.008.0012	NO.10-32X2.1/2*	100	U07040.019.0250			
NO.2-64X3/16 ft*	100	U07040.008.0018	NO.10-32X2.3/4*	100	U07040.019.0275	7/16-20X1/2 ft*	25	U07040.043.0050
NO.2-64X1/4 ft*	100	U07040.008.0025	NO.10-32X3 Inch*	100	U07040.019.0300	7/16-20X5/8 ft*	25	U07040.043.0062
NO.2-64X3/8 ft*	100	U07040.008.0037	NO.10-32X3.1/4*	100	U07040.019.0325	7/16-20X3/4 ft*	25	U07040.043.0075
NO.2-64X1/2 ft*	100	U07040.008.0050	NO.10-32X3.1/2*	100	U07040.019.0350	7/16-20X7/8 ft*	25	U07040.043.0087
NO.2-64X5/8 ft*	100	U07040.008.0062	NO.10-32X4 Inch*	100	U07040.019.0400	7/16-20X1 Inch ft*	25	U07040.043.0100
NO.2-64X3/4*	100	U07040.008.0075				7/16-20X1.1/4 ft*	25	U07040.043.0125
NO.2-64X1 Inch*	100	U07040.008.0100	1/4-28X3/8 ft*	100	U07040.025.0037	7/16-20X1.1/2 ft*	25	U07040.043.0150
			1/4-28X7/16 ft*	100	U07040.025.0043	7/16-20X1.3/4*	10	U07040.043.0175
NO.3-56X1/8 ft*	100	U07040.009.0012	1/4-28X1/2 ft*	100	U07040.025.0050	7/16-20X2 Inch*	10	U07040.043.0200
NO.3-56X3/16 ft*	100	U07040.009.0018	1/4-28X5/8 ft*	100	U07040.025.0062	7/16-20X2.1/4*	10	U07040.043.0225
NO.3-56X1/4 ft*	100	U07040.009.0025	1/4-28X3/4 ft*	100	U07040.025.0075	7/16-20X2.1/2*	10	U07040.043.0250
NO.3-56X5/16 ft*	100	U07040.009.0031	1/4-28X7/8 ft*	100	U07040.025.0087	7/16-20X3 Inch*	10	U07040.043.0300
NO.3-56X3/8 ft*	100	U07040.009.0037	1/4-28X1 Inch ft*	100	U07040.025.0100	7/16-20X3.1/2*	5	U07040.043.0350
NO.3-56X1/2 ft*	100	U07040.009.0050	1/4-28X1.1/8*	100	U07040.025.0112	7/16-20X4 Inch*	5	U07040.043.0400
NO.3-56X5/8 ft*	100	U07040.009.0062	1/4-28X1.1/4*	100	U07040.025.0125	7/16-20X5 Inch*	5	U07040.043.0500
NO.3-56X3/4*	100	U07040.009.0075	1/4-28X1.3/8*	100	U07040.025.0137	7/16-20X6 Inch*	5	U07040.043.0600
NO.3-56X1 Inch*	100	U07040.009.0100	1/4-28X1.1/2*	100	U07040.025.0150			
			1/4-28X1.3/4*	100	U07040.025.0175	1/2-20X1/2 ft*	10	U07040.050.0050
NO.4-48X1/8 ft*	100	U07040.011.0012	1/4-28X2 Inch*	50	U07040.025.0200	1/2-20X5/8 ft*	10	U07040.050.0062
NO.4-48X3/16 ft*	100	U07040.011.0018	1/4-28X2.1/4*	50	U07040.025.0225	1/2-20X3/4 ft*	10	U07040.050.0075
NO.4-48X1/4 ft*	100	U07040.011.0025	1/4-28X2.1/2*	50	U07040.025.0250	1/2-20X7/8 ft*	10	U07040.050.0087
NO.4-48X5/16 ft*	100	U07040.011.0031	1/4-28X2.3/4*	50	U07040.025.0275	1/2-20X1 Inch ft*	10	U07040.050.0100
NO.4-48X3/8 ft*	100	U07040.011.0037	1/4-28X3 Inch*	25	U07040.025.0300	1/2-20X1.1/8 ft*	10	U07040.050.0112
NO.4-48X7/16 ft*	100	U07040.011.0043	1/4-28X3.1/4*	25	U07040.025.0325	1/2-20X1.1/4 ft*	10	U07040.050.0125
NO.4-48X1/2 ft*	100	U07040.011.0050	1/4-28X3.1/2*	25	U07040.025.0350	1/2-20X1.3/8 ft*	10	U07040.050.0137
NO.4-48X5/8 ft*	100	U07040.011.0062	1/4-28X4 Inch*	25	U07040.025.0400	1/2-20X1.1/2 ft*	10	U07040.050.0150
NO.4-48X3/4 ft*	100	U07040.011.0075	1/4-28X4.1/2*	25	U07040.025.0450	1/2-20X1.3/4*	10	U07040.050.0175
NO.4-48X7/8*	100	U07040.011.0087	1/4-28X5 Inch*	25	U07040.025.0500	1/2-20X2 Inch*	10	U07040.050.0200
NO.4-48X1 Inch*	100	U07040.011.0100				1/2-20X2.1/4*	10	U07040.050.0225
			5/16-24X3/8 ft*	100	U07040.031.0037	1/2-20X2.1/2*	10	U07040.050.0250
NO.5-44X1/4 ft*	100	U07040.012.0025	5/16-24X1/2 ft*	100	U07040.031.0050	1/2-20X2.3/4*	10	U07040.050.0275
NO.5-44X3/8 ft*	100	U07040.012.0037	5/16-24X5/8 ft*	100	U07040.031.0062	1/2-20X3 Inch*	5	U07040.050.0300
NO.5-44X1/2 ft*	100	U07040.012.0050	5/16-24X3/4 ft*	100	U07040.031.0075	1/2-20X3.1/4*	5	U07040.050.0325
NO.5-44X5/8 ft*	100	U07040.012.0062	5/16-24X7/8 ft*	100	U07040.031.0087	1/2-20X3.1/2*	5	U07040.050.0350
NO.5-44X3/4 ft*	100	U07040.012.0075	5/16-24X1 Inch ft*	50	U07040.031.0100	1/2-20X3.3/4*	5	U07040.050.0375
			5/16-24X1.1/4*	50	U07040.031.0125	1/2-20X4 Inch*	5	U07040.050.0400
NO.6-40X3/16 ft*	100	U07040.013.0018	5/16-24X1.1/2*	50	U07040.031.0150	1/2-20X4.1/2*	5	U07040.050.0450
NO.6-40X1/4 ft*	100	U07040.013.0025	5/16-24X1.3/4*	50	U07040.031.0175	1/2-20X5 Inch*	5	U07040.050.0500
NO.6-40X5/16 ft*	100	U07040.013.0031	5/16-24X2 Inch*	50	U07040.031.0200	1/2-20X5.1/2*	5	U07040.050.0550
NO.6-40X3/8 ft*	100	U07040.013.0037	5/16-24X2.1/4*	25	U07040.031.0225	1/2-20X6 Inch*	5	U07040.050.0600
NO.6-40X7/16 ft*	100	U07040.013.0043	5/16-24X2.1/2*	25	U07040.031.0250	1/2-20X7 Inch*	5	U07040.050.0700
NO.6-40X1/2 ft*	100	U07040.013.0050	5/16-24X2.3/4*	25	U07040.031.0275	1/2-20X8 Inch*	5	U07040.050.0800
NO.6-40X5/8 ft*	100	U07040.013.0062	5/16-24X3 Inch*	25	U07040.031.0300			
NO.6-40X3/4 ft*	100	U07040.013.0075	5/16-24X3.1/4*	25	U07040.031.0325	9/16-18X1 Inch ft*	10	U07040.056.0100
NO.6-40X7/8*	100	U07040.013.0087	5/16-24X3.1/2*	25	U07040.031.0350	9/16-18X1.1/4 ft*	10	U07040.056.0125
NO.6-40X1 Inch*	100	U07040.013.0100	5/16-24X4 Inch*	10	U07040.031.0400	9/16-18X1.1/2 ft*	10	U07040.056.0150
			5/16-24X4.1/2*	10	U07040.031.0450	9/16-18X1.3/4*	10	U07040.056.0175
NO.8-36X1/4 ft*	100	U07040.016.0025	5/16-24X5 Inch*	10	U07040.031.0500	9/16-18X2 Inch*	5	U07040.056.0200
NO.8-36X3/8 ft*	100	U07040.016.0037	5/16-24X5.1/2*	10	U07040.031.0550	9/16-18X2.1/4*	5	U07040.056.0225
NO.8-36X1/2 ft*	100	U07040.016.0050	5/16-24X6 Inch*	10	U07040.031.0600	9/16-18X2.1/2*	5	U07040.056.0250
NO.8-36X5/8 ft*	100	U07040.016.0062				9/16-18X3 Inch*	5	U07040.056.0300
NO.8-36X3/4 ft*	100	U07040.016.0075	3/8-24X1/2 ft*	50	U07040.037.0050	9/16-18X4 Inch*	5	U07040.056.0400
NO.8-36X7/8 ft*	100	U07040.016.0087	3/8-24X5/8 ft*	50	U07040.037.0062	9/16-18X4.1/2*	5	U07040.056.0450
NO.8-36X1 Inch*	100	U07040.016.0100	3/8-24X3/4 ft*	50	U07040.037.0075	9/16-18X5 Inch*	5	U07040.056.0500

U07040 Śruby z łbem walcowym z gniazdem sześciokątnym seria 1936 UNF ←

d x L	☒	Kod artykułu	d x L	☒	Kod artykułu	d x L	☒	Kod artykułu
9/16-18X5.1/2*	5	U07040.056.0550	3/4-16X6.1/2*	1	U07040.075.0650	1.1/4-12X2 Inch ft*	1	U07040.125.0200
9/16-18X6 Inch*	5	U07040.056.0600	3/4-16X7 Inch*	1	U07040.075.0700	1.1/4-12X2.1/2 ft*	1	U07040.125.0250
5/8-18X1 Inch ft*	10	U07040.062.0100	3/4-16X8 Inch*	1	U07040.075.0800	1.1/4-12X3 Inch ft*	1	U07040.125.0300
5/8-18X1.1/4 ft*	10	U07040.062.0125	7/8-14X2 Inch ft*	5	U07040.087.0200	1.1/4-12X3.1/2*	1	U07040.125.0350
5/8-18X1.1/2 ft*	10	U07040.062.0150	7/8-14X2.1/4 ft*	5	U07040.087.0225	1.1/4-12X4 Inch*	1	U07040.125.0400
5/8-18X1.3/4 ft*	10	U07040.062.0175	7/8-14X2.1/2*	5	U07040.087.0250	1.1/4-12X4.1/2*	1	U07040.125.0450
5/8-18X2 Inch*	5	U07040.062.0200	7/8-14X3.1/4*	5	U07040.087.0325	1.1/4-12X5 Inch*	1	U07040.125.0500
5/8-18X2.1/4*	5	U07040.062.0225	7/8-14X3.1/2*	5	U07040.087.0350	1.1/4-12X5.1/2*	1	U07040.125.0550
5/8-18X2.1/2*	5	U07040.062.0250	7/8-14X3 Inch*	5	U07040.087.0300	1.1/4-12X6 Inch*	1	U07040.125.0600
5/8-18X2.3/4*	5	U07040.062.0275	7/8-14X3.1/2*	5	U07040.087.0325	1.1/4-12X7 Inch*	1	U07040.125.0700
5/8-18X3 Inch*	5	U07040.062.0300	7/8-14X4 Inch*	5	U07040.087.0400	1.1/4-12X8 Inch*	1	U07040.125.0800
5/8-18X3.1/4*	5	U07040.062.0325	7/8-14X4.1/2*	5	U07040.087.0450	1.1/4-12X9 Inch*	1	U07040.125.0900
5/8-18X3.1/2*	5	U07040.062.0350	7/8-14X5 Inch*	5	U07040.087.0500	1.1/4-12X10 Inch*	1	U07040.125.1000
5/8-18X4 Inch*	5	U07040.062.0400	7/8-14X6 Inch*	1	U07040.087.0600	1.1/4-12X12 Inch*	1	U07040.125.1200
5/8-18X4.1/2*	5	U07040.062.0450	7/8-14X7 Inch*	1	U07040.087.0700	1.3/8-12X3 Inch ft*	1	U07040.137.0300
5/8-18X5 Inch*	5	U07040.062.0500	7/8-14X8 Inch*	1	U07040.087.0800	1.3/8-12X3.1/2*	1	U07040.137.0350
5/8-18X5.1/2*	5	U07040.062.0550	1.-14X2 Inch*	5	U07040.101.0200	1.3/8-12X4 Inch*	1	U07040.137.0400
5/8-18X6 Inch*	5	U07040.062.0600	1.-14X2.1/4*	5	U07040.101.0225	1.3/8-12X4.1/2*	1	U07040.137.0450
5/8-18X6.1/2*	5	U07040.062.0650	1.-14X2.1/2*	5	U07040.101.0250	1.3/8-12X5 Inch*	1	U07040.137.0500
5/8-18X7 Inch*	5	U07040.062.0700	1.-14X3 Inch*	5	U07040.101.0300	1.3/8-12X5.1/2*	1	U07040.137.0550
5/8-18X8 Inch*	5	U07040.062.0800	1.-14X3.1/2*	5	U07040.101.0350	1.3/8-12X6 Inch*	1	U07040.137.0600
3/4-16X1.1/4 ft*	5	U07040.075.0125	1.-14X3.1/2*	5	U07040.101.0350	1.3/8-12X7 Inch*	1	U07040.137.0700
3/4-16X1.1/2 ft*	5	U07040.075.0150	1.-14X4 Inch*	5	U07040.101.0400	1.3/8-12X8 Inch*	1	U07040.137.0800
3/4-16X1.3/4 ft*	5	U07040.075.0175	1.-14X4.1/2*	5	U07040.101.0450	1.3/8-12X10 Inch*	1	U07040.137.1000
3/4-16X2 Inch ft*	5	U07040.075.0200	1.-14X5 Inch*	5	U07040.101.0500	1.1/2-12X3 Inch ft*	1	U07040.150.0300
3/4-16X2.1/4*	5	U07040.075.0225	1.-14X6 Inch*	1	U07040.101.0600	1.1/2-12X3.1/2 ft*	1	U07040.150.0350
3/4-16X2.1/2*	5	U07040.075.0250	1.-14X7 Inch*	1	U07040.101.0700	1.1/2-12X4 Inch*	1	U07040.150.0400
3/4-16X2.3/4*	5	U07040.075.0275	1.1/8-12X3 Inch*	1	U07040.112.0300	1.1/2-12X4.1/2*	1	U07040.150.0450
3/4-16X3 Inch*	5	U07040.075.0300	1.1/8-12X3.1/2*	1	U07040.112.0350	1.1/2-12X5 Inch*	1	U07040.150.0500
3/4-16X3.1/4*	5	U07040.075.0325	1.1/8-12X4 Inch*	1	U07040.112.0400	1.1/2-12X5.1/2*	1	U07040.150.0550
3/4-16X3.1/2*	5	U07040.075.0350	1.1/8-12X4.1/2*	1	U07040.112.0450	1.1/2-12X6 Inch*	1	U07040.150.0600
3/4-16X4 Inch*	5	U07040.075.0400	1.1/8-12X5 Inch*	1	U07040.112.0500	1.1/2-12X7 Inch*	1	U07040.150.0700
3/4-16X4.1/2*	5	U07040.075.0450	1.1/8-12X6 Inch*	1	U07040.112.0600	1.1/2-12X8 Inch*	1	U07040.150.0800
3/4-16X5 Inch*	5	U07040.075.0500	1.1/8-12X7 Inch*	1	U07040.112.0700	1.1/2-12X10 Inch*	1	U07040.150.1000
3/4-16X5.1/2*	5	U07040.075.0550	1.1/8-12X8 Inch*	1	U07040.112.0800	1.1/2-12X12 Inch*	1	U07040.150.1200
3/4-16X6 Inch*	5	U07040.075.0600						

* ft = z pełnym gwintem

07250 Śruby z łbem walcowym z gniazdem sześciokątnym seria 1936 UNF X05A

Gwint Całowy, zunifikowany drobnozwojny (UNF)
Materiał Stal
Klasa 12.9
Obróbka powierzchni Ocynkowane mechanicznie



d x L	☒	Kod artykułu	d x L	☒	Kod artykułu	d x L	☒	Kod artykułu
5/16-24X7/8 ft	100	07250.079.022	3/8-24X1.1/2	100	07250.096.038	1/2-20X1.3/4	50	07250.127.044
5/16-24X1 Inch ft	100	07250.079.025	1/2-20X5/8 ft	50	07250.127.015	5/8-18X1.1/2 ft	25	07250.158.038
3/8-24X1 Inch ft	100	07250.096.025	1/2-20X1.1/2 ft	50	07250.127.038			

* ft = z pełnym gwintem

U51041 Śruby z łbem walcowym z gniazdem sześciokątnym seria 1936 UNF X15A

Gwint Całowy, zunifikowany drobnozwojny (UNF)
Materiał Stal nierdzewna A2 (AISI 304/18-8)
Klasa F837B

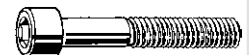

d x L	☒	Kod artykułu	d x L	☒	Kod artykułu	d x L	☒	Kod artykułu
NO.0-80X1/8 ft*	100	U51041.006.0012	NO.1-72X5/16 ft*	100	U51041.007.0031	NO.2-64X3/4*	100	U51041.008.0075
NO.0-80X3/16 ft*	100	U51041.006.0018	NO.1-72X3/8 ft*	100	U51041.007.0037	NO.2-64X1 Inch*	100	U51041.008.0100
NO.0-80X1/4 ft*	100	U51041.006.0025	NO.1-72X1/2 ft*	100	U51041.007.0050			
NO.0-80X5/16 ft*	100	U51041.006.0031	NO.1-72X5/8 ft*	100	U51041.007.0062	NO.3-56X3/16 ft*	100	U51041.009.0018
NO.0-80X3/8 ft*	100	U51041.006.0037	NO.1-72X3/4 ft*	100	U51041.007.0075	NO.3-56X1/4 ft*	100	U51041.009.0025
NO.0-80X1/2 ft*	100	U51041.006.0050	NO.1-72X1 Inch*	100	U51041.007.0100	NO.3-56X5/16 ft*	100	U51041.009.0031
NO.0-80X5/8*	100	U51041.006.0062				NO.3-56X3/8 ft*	100	U51041.009.0037
NO.0-80X3/4*	100	U51041.006.0075	NO.2-64X3/16 ft*	100	U51041.008.0018	NO.3-56X1/2 ft*	100	U51041.009.0050
NO.0-80X1 Inch*	100	U51041.006.0100	NO.2-64X1/4 ft*	100	U51041.008.0025	NO.3-56X5/8 ft*	100	U51041.009.0062
			NO.2-64X5/16 ft*	100	U51041.008.0031	NO.3-56X3/4*	100	U51041.009.0075
NO.1-72X1/8 ft*	100	U51041.007.0012	NO.2-64X3/8 ft*	100	U51041.008.0037	NO.3-56X1 Inch*	100	U51041.009.0100
NO.1-72X3/16 ft*	100	U51041.007.0018	NO.2-64X1/2 ft*	100	U51041.008.0050			
NO.1-72X1/4 ft*	100	U51041.007.0025	NO.2-64X5/8 ft*	100	U51041.008.0062	NO.4-48X3/16 ft*	100	U51041.011.0018

U51041 Śruby z łbem walcowym z gniazdem sześciokątnym seria 1936 UNF

d x L	☒	Kod artykułu	d x L	☒	Kod artykułu	d x L	☒	Kod artykułu
NO.4-48X1/4 ft*	100	U51041.011.0025	NO.10-32X1.1/8*	100	U51041.019.0112	5/16-24X3.1/2*	25	U51041.031.0350
NO.4-48X5/16 ft*	100	U51041.011.0031	NO.10-32X1.1/4*	100	U51041.019.0125	5/16-24X4 Inch*	10	U51041.031.0400
NO.4-48X3/8 ft*	100	U51041.011.0037	NO.10-32X1.3/8*	100	U51041.019.0137			
NO.4-48X1/2 ft*	100	U51041.011.0050	NO.10-32X1.1/2*	100	U51041.019.0150	3/8-24X1/2 ft*	50	U51041.037.0050
NO.4-48X5/8 ft*	100	U51041.011.0062	NO.10-32X1.3/4*	100	U51041.019.0175	3/8-24X5/8 ft*	50	U51041.037.0062
NO.4-48X3/4 ft*	100	U51041.011.0075	NO.10-32X2 Inch*	100	U51041.019.0200	3/8-24X3/4 ft*	50	U51041.037.0075
NO.4-48X1 Inch*	100	U51041.011.0100	NO.10-32X2.1/4*	100	U51041.019.0225	3/8-24X7/8 ft*	50	U51041.037.0087
			NO.10-32X2.1/2*	100	U51041.019.0250	3/8-24X1 Inch ft*	50	U51041.037.0100
NO.5-44X3/16 ft*	100	U51041.012.0018	NO.10-32X2.3/4*	100	U51041.019.0275	3/8-24X1.1/4 ft*	50	U51041.037.0125
NO.5-44X1/4 ft*	100	U51041.012.0025	NO.10-32X3 Inch*	100	U51041.019.0300	3/8-24X1.1/2*	25	U51041.037.0150
NO.5-44X5/16 ft*	100	U51041.012.0031	NO.10-32X3.1/4*	100	U51041.019.0325	3/8-24X1.3/4*	25	U51041.037.0175
NO.5-44X3/8 ft*	100	U51041.012.0037	NO.10-32X3.1/2*	100	U51041.019.0350	3/8-24X2 Inch*	25	U51041.037.0200
NO.5-44X1/2 ft*	100	U51041.012.0050	NO.10-32X4 Inch*	100	U51041.019.0400	3/8-24X2.1/4*	25	U51041.037.0225
NO.5-44X5/8 ft*	100	U51041.012.0062				3/8-24X2.1/2*	25	U51041.037.0250
NO.5-44X3/4 ft*	100	U51041.012.0075	1/4-28X3/8 ft*	100	U51041.025.0037	3/8-24X2.3/4*	25	U51041.037.0275
NO.5-44X1 Inch*	100	U51041.012.0100	1/4-28X7/16 ft*	100	U51041.025.0043	3/8-24X3 Inch*	10	U51041.037.0300
			1/4-28X1/2 ft*	100	U51041.025.0050	3/8-24X3.1/2*	10	U51041.037.0350
NO.6-40X3/16 ft*	100	U51041.013.0018	1/4-28X5/8 ft*	100	U51041.025.0062	3/8-24X4 Inch*	10	U51041.037.0400
NO.6-40X1/4 ft*	100	U51041.013.0025	1/4-28X3/4 ft*	100	U51041.025.0075	3/8-24X4.1/2*	10	U51041.037.0450
NO.6-40X5/16 ft*	100	U51041.013.0031	1/4-28X7/8 ft*	100	U51041.025.0087	3/8-24X5 Inch*	10	U51041.037.0500
NO.6-40X3/8 ft*	100	U51041.013.0037	1/4-28X1 Inch ft*	100	U51041.025.0100	3/8-24X6 Inch*	10	U51041.037.0600
NO.6-40X1/2 ft*	100	U51041.013.0050	1/4-28X1.1/8*	100	U51041.025.0112			
NO.6-40X5/8 ft*	100	U51041.013.0062	1/4-28X1.1/4*	100	U51041.025.0125	7/16-20X1 Inch ft*	25	U51041.043.0100
NO.6-40X3/4 ft*	100	U51041.013.0075	1/4-28X1.1/2*	100	U51041.025.0150	7/16-20X1.1/4 ft*	25	U51041.043.0125
NO.6-40X1 Inch*	100	U51041.013.0100	1/4-28X1.3/4*	100	U51041.025.0175	7/16-20X1.1/2*	25	U51041.043.0150
NO.6-40X1.1/4*	100	U51041.013.0125	1/4-28X2 Inch*	50	U51041.025.0200	7/16-20X2 Inch*	10	U51041.043.0200
			1/4-28X2.1/4*	50	U51041.025.0225			
NO.8-36X1/4 ft*	100	U51041.016.0025	1/4-28X2.1/2*	50	U51041.025.0250	1/2-20X3/4 ft*	10	U51041.050.0075
NO.8-36X3/8 ft*	100	U51041.016.0037	1/4-28X3 Inch*	25	U51041.025.0300	1/2-20X1 Inch ft*	10	U51041.050.0100
NO.8-36X1/2 ft*	100	U51041.016.0050	1/4-28X3.1/2*	25	U51041.025.0350	1/2-20X1.1/4 ft*	10	U51041.050.0125
NO.8-36X5/8 ft*	100	U51041.016.0062	1/4-28X4 Inch*	25	U51041.025.0400	1/2-20X1.1/2 ft*	10	U51041.050.0150
NO.8-36X3/4 ft*	100	U51041.016.0075				1/2-20X1.3/4*	10	U51041.050.0175
NO.8-36X7/8 ft*	100	U51041.016.0087	5/16-24X3/8 ft*	100	U51041.031.0037	1/2-20X2 Inch*	10	U51041.050.0200
NO.8-36X1 Inch*	100	U51041.016.0100	5/16-24X1/2 ft*	100	U51041.031.0050	1/2-20X2.1/4*	10	U51041.050.0225
NO.8-36X1.1/4*	100	U51041.016.0125	5/16-24X5/8 ft*	100	U51041.031.0062	1/2-20X2.1/2*	10	U51041.050.0250
			5/16-24X3/4 ft*	100	U51041.031.0075	1/2-20X3 Inch*	5	U51041.050.0300
NO.10-32X3/16 ft*	100	U51041.019.0018	5/16-24X7/8 ft*	100	U51041.031.0087	1/2-20X3.1/2*	5	U51041.050.0350
NO.10-32X1/4 ft*	100	U51041.019.0025	5/16-24X1 Inch ft*	50	U51041.031.0100	1/2-20X4 Inch*	5	U51041.050.0400
NO.10-32X5/16 ft*	100	U51041.019.0031	5/16-24X1.1/4*	50	U51041.031.0125	1/2-20X4.1/2*	5	U51041.050.0450
NO.10-32X3/8 ft*	100	U51041.019.0037	5/16-24X1.1/2*	50	U51041.031.0150	1/2-20X5 Inch*	5	U51041.050.0500
NO.10-32X7/16 ft*	100	U51041.019.0043	5/16-24X1.3/4*	50	U51041.031.0175	1/2-20X6 Inch*	5	U51041.050.0600
NO.10-32X1/2 ft*	100	U51041.019.0050	5/16-24X2 Inch*	50	U51041.031.0200			
NO.10-32X5/8 ft*	100	U51041.019.0062	5/16-24X2.1/4*	25	U51041.031.0225	5/8-18X1.1/2 ft*	10	U51041.062.0150
NO.10-32X3/4 ft*	100	U51041.019.0075	5/16-24X2.1/2*	25	U51041.031.0250	5/8-18X1.3/4 ft*	10	U51041.062.0175
NO.10-32X7/8 ft*	100	U51041.019.0087	5/16-24X2.3/4*	25	U51041.031.0275	5/8-18X2 Inch*	5	U51041.062.0200
NO.10-32X1 Inch*	100	U51041.019.0100	5/16-24X3 Inch*	25	U51041.031.0300			

* ft = z pełnym gwintem

U55041 Śruby z łbem walcowym z gniazdem sześciokątnym seria 1936 UNF
X15A

Gwint Calowy, zunifikowany drobnozwojny (UNF)
Materiał Stal nierdzewna A4 (AISI 316/18-10)
Klasa F837E



d x L	☒	Kod artykułu	d x L	☒	Kod artykułu	d x L	☒	Kod artykułu
NO.10-32X1/4 ft*	100	U55041.019.0025	NO.10-32X1.1/4*	100	U55041.019.0125	5/16-24X3/4 ft*	100	U55041.031.0075
NO.10-32X3/8 ft*	100	U55041.019.0037	NO.10-32X1.1/2*	100	U55041.019.0150	5/16-24X1 Inch ft*	50	U55041.031.0100
NO.10-32X1/2 ft*	100	U55041.019.0050	NO.10-32X2 Inch*	100	U55041.019.0200			
NO.10-32X5/8 ft*	100	U55041.019.0062				3/8-24X3/4 ft*	50	U55041.037.0075
NO.10-32X3/4 ft*	100	U55041.019.0075	1/4-28X1/2 ft*	100	U55041.025.0050	3/8-24X1 Inch ft*	50	U55041.037.0100
NO.10-32X7/8 ft*	100	U55041.019.0087	1/4-28X3/4 ft*	100	U55041.025.0075			
NO.10-32X1 Inch*	100	U55041.019.0100	1/4-28X1 Inch ft*	100	U55041.025.0100			

* ft = z pełnym gwintem

Śruby z łbem walcowym z gniazdem sześciokątnym BSW

2

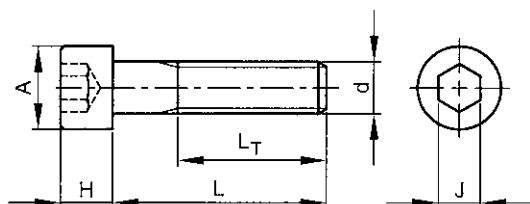

BS ≈2470

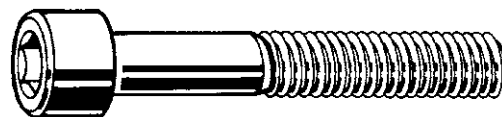

Informacje techniczne

d	A	H	J	L _T (min.)	Zwoje gwintu na cal
1/2	19	12.7	3/8	38	12

- Gwint Whitworth'a (BSW/BSF) nie jest zalecany do międzynarodowego stosowania. Zaleca się stosowanie gwintu metrycznego (M/MF) lub zunifikowanego (UNC/UNF).
- W zależności od dostępności dostarczona może zostać również klasa 10.9.
- Znakowanie tych śrub nie jest obowiązkowe.
- W zależności od dostępności wymiary mogą się różnić.

07200 Śruby z łbem walcowym z gniazdem sześciokątnym BSW

X08A

Gwint Calowy, Whitworth'a (BSW)
Materiał Stal
Klasa 12.9



d x L	☒	Kod artykułu	d x L	☒	Kod artykułu	d x L	☒	Kod artykułu
1/2X3/4	50	07200.127.020	1/2X2 Inch	50	07200.127.050	1/2X3. 1/4	25	07200.127.080
1/2X1 Inch	50	07200.127.025	1/2X2. 1/4	25	07200.127.060	1/2X3. 1/2	25	07200.127.090
1/2X1. 1/4	50	07200.127.030	1/2X2. 1/2	25	07200.127.065	1/2X4 Inch	25	07200.127.100
1/2X1. 1/2	50	07200.127.040	1/2X2. 3/4	25	07200.127.070	1/2X4. 1/2	25	07200.127.110
1/2X1. 3/4	50	07200.127.045	1/2X3 Inch	25	07200.127.075			

- Ostrzeżenie: cynkowanie elektrolityczne tych produktów może wywołać kruchość wodorową.

Śruby z łbem walcowym niskim z gniazdem sześciokątnym

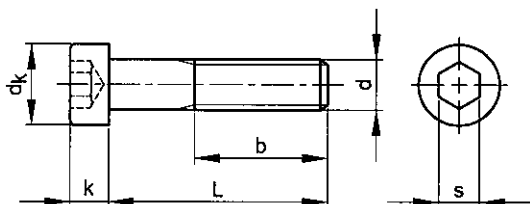

DIN 7984
 NEN 1601



Informacje techniczne

d	b (min.)	d _k	k	P	Pełen gwint L ≤	s
M3	12	5.5	2	0.5	18	2
M4	14	7	2.8	0.7	20	2.5
M5	16	8.5	3.5	0.8	25	3
M6	18	10	4	1	25	4
M8	22	13	5	1.25	30	5
M10	26	16	6	1.5	35	7
M12	30	18	7	1.75	45	8
M16	38	24	9	2	55	12
M20	46	30	11	2.5	60	14
M24	54	36	13	3	80	17

- W związku z niestandardową geometrią łba elementy złączne mają ograniczoną obciążalność.
- W przypadku znakowania śrub o ograniczonej obciążalności, symbol standardowego oznaczenia poprzedza cyfra "0", tak więc 8.8→08.8 ; 10.9→010.9 oraz 12.9→012.9
- Dla elementów złącznych ze stali nierdzewnej oznaczenie następuje poprzez oznaczenie cechy danej klasy na przykład: 70 (A2-70 → A2).
- Tymczasowo mogą pojawić się stare i nowe formy znakowania na śrubach.

Grupy katalogowe

Gwint	Gniazdo	Materiał	Klasa	Obróbka powierzchni	Kod	Strona
M	Gniazdo sześciokątne	St	08.8		07080	2-33
M	Gniazdo sześciokątne	St	08.8	Ocynek.	07090	2-33
M	Gniazdo sześciokątne	St	010.9		07105	2-34

Grupy katalogowe

Gwint	Gniazdo	Materiał	Klasa	Obróbka powierzchni	Kod	Strona
M	Gniazdo sześciokątne	St.St. A2			51040	2-34
M	Gniazdo sześciokątne	St.St. A4			55040	2-35

07080 Śruby z łbem walcowym niskim z gniazdem sześciokątnym

D03A

Gwint
Materiał
Klasa

Metryczny
Stal
08.8

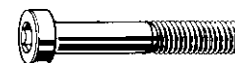

d x L	☒	Kod artykułu	d x L	☒	Kod artykułu	d x L	☒	Kod artykułu
M4X6	200	07080.040.006				M12X60	100	07080.120.060
M4X8	200	07080.040.008	M8X12	200	07080.080.012	M12X70	50	07080.120.070
M4X10	200	07080.040.010	M8X16	200	07080.080.016	M12X80	50	07080.120.080
M4X12	200	07080.040.012	M8X18	200	07080.080.018	M12X100	50	07080.120.100
M4X16	200	07080.040.016	M8X20	200	07080.080.020			
M4X20	200	07080.040.020	M8X22	200	07080.080.022	M16X25	50	07080.160.025
M4X25	200	07080.040.025	M8X25	200	07080.080.025	M16X30	50	07080.160.030
M4X30	200	07080.040.030	M8X30	200	07080.080.030	M16X35	50	07080.160.035
			M8X35	200	07080.080.035	M16X40	50	07080.160.040
M5X8	200	07080.050.008	M8X40	200	07080.080.040	M16X45	50	07080.160.045
M5X10	200	07080.050.010	M8X45	200	07080.080.045	M16X50	50	07080.160.050
M5X12	200	07080.050.012	M8X50	200	07080.080.050	M16X55	50	07080.160.055
M5X16	200	07080.050.016	M8X60	200	07080.080.060	M16X60	50	07080.160.060
M5X18	200	07080.050.018	M8X70	200	07080.080.070	M16X70	25	07080.160.070
M5X20	200	07080.050.020				M16X80	25	07080.160.080
M5X22	200	07080.050.022	M10X16	200	07080.100.016	M16X90	25	07080.160.090
M5X25	200	07080.050.025	M10X20	200	07080.100.020	M16X100	25	07080.160.100
M5X30	200	07080.050.030	M10X22	200	07080.100.022	M16X120	50	07080.160.120
M5X35	200	07080.050.035	M10X25	200	07080.100.025			
M5X40	200	07080.050.040	M10X30	200	07080.100.030	M20X30	25	07080.200.030
M5X50	200	07080.050.050	M10X35	100	07080.100.035	M20X35	25	07080.200.035
			M10X40	100	07080.100.040	M20X40	25	07080.200.040
M6X8	200	07080.060.008	M10X45	100	07080.100.045	M20X50	25	07080.200.050
M6X10	200	07080.060.010	M10X50	100	07080.100.050	M20X60	25	07080.200.060
M6X12	200	07080.060.012	M10X60	100	07080.100.060	M20X70	25	07080.200.070
M6X16	200	07080.060.016	M10X70	100	07080.100.070	M20X80	25	07080.200.080
M6X18	200	07080.060.018	M10X80	100	07080.100.080	M20X90	25	07080.200.090
M6X20	200	07080.060.020						
M6X22	200	07080.060.022	M12X20	100	07080.120.020	M24X40	25	07080.240.040
M6X25	200	07080.060.025	M12X25	100	07080.120.025	M24X45	25	07080.240.045
M6X30	200	07080.060.030	M12X30	100	07080.120.030	M24X50	25	07080.240.050
M6X35	200	07080.060.035	M12X35	100	07080.120.035	M24X60	25	07080.240.060
M6X40	200	07080.060.040	M12X40	100	07080.120.040	M24X80	25	07080.240.080
M6X45	200	07080.060.045	M12X45	100	07080.120.045	M24X90	25	07080.240.090
M6X50	200	07080.060.050	M12X50	100	07080.120.050	M24X100	25	07080.240.100
M6X60	200	07080.060.060						

07090 Śruby z łbem walcowym niskim z gniazdem sześciokątnym

D03A

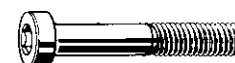

Gwint
Materiał
Klasa
Obróbka powierzchni

Metryczny
Stal
08.8
O cynkowane





d x L	☒	Kod artykułu	d x L	☒	Kod artykułu	d x L	☒	Kod artykułu
M4X6	200	07090.040.006	M6X30	200	07090.060.030	M10X25	200	07090.100.025
M4X8	200	07090.040.008	M6X35	200	07090.060.035	M10X30	200	07090.100.030
M4X10	200	07090.040.010	M6X40	200	07090.060.040	M10X35	100	07090.100.035
M4X12	200	07090.040.012	M6X45	200	07090.060.045	M10X40	100	07090.100.040
M4X16	200	07090.040.016	M6X50	200	07090.060.050	M10X50	100	07090.100.050
M4X20	200	07090.040.020				M10X60	100	07090.100.060
			M8X10	200	07090.080.010			
M5X8	200	07090.050.008	M8X12	200	07090.080.012	M12X20	100	07090.120.020
M5X10	200	07090.050.010	M8X16	200	07090.080.016	M12X25	100	07090.120.025
M5X12	200	07090.050.012	M8X20	200	07090.080.020	M12X30	100	07090.120.030
M5X16	200	07090.050.016	M8X25	200	07090.080.025	M12X35	100	07090.120.035
M5X20	200	07090.050.020	M8X30	200	07090.080.030	M12X40	100	07090.120.040
M5X25	200	07090.050.025	M8X35	200	07090.080.035	M12X45	100	07090.120.045
M5X30	200	07090.050.030	M8X40	200	07090.080.040	M12X50	100	07090.120.050
			M8X45	200	07090.080.045	M12X60	100	07090.120.060
M6X10	200	07090.060.010	M8X50	200	07090.080.050	M12X80	50	07090.120.080
M6X12	200	07090.060.012	M8X60	200	07090.080.060			
M6X16	200	07090.060.016				M16X25	50	07090.160.025
M6X20	200	07090.060.020	M10X16	200	07090.100.016	M16X30	50	07090.160.030
M6X25	200	07090.060.025	M10X20	200	07090.100.020	M16X35	50	07090.160.035

07090 Śruby z łbem walcowym niskim z gniazdem sześciokątnym								
d x L	☒	Kod artykułu	d x L	☒	Kod artykułu	d x L	☒	Kod artykułu
M16X40	50	07090.160.040	M16X80	25	07090.160.080	M20X60	25	07090.200.060
M16X50	50	07090.160.050				M20X70	25	07090.200.070
M16X60	50	07090.160.060	M20X40	25	07090.200.040	M20X80	25	07090.200.080
M16X70	25	07090.160.070	M20X50	25	07090.200.050			

07105 Śruby z łbem walcowym niskim z gniazdem sześciokątnym								D03A
Gwint	Metryczny							
Materiał	Stal							
Klasa	010.9							
								



d x L	☒	Kod artykułu	d x L	☒	Kod artykułu	d x L	☒	Kod artykułu
M4X8	200	07105.040.008	M8X12	200	07105.080.012	M12X45	100	07105.120.045
M4X10	200	07105.040.010	M8X16	200	07105.080.016	M12X50	50	07105.120.050
M4X12	200	07105.040.012	M8X20	200	07105.080.020	M12X60	50	07105.120.060
M4X16	200	07105.040.016	M8X25	200	07105.080.025			
M4X20	200	07105.040.020	M8X30	200	07105.080.030	M16X30	25	07105.160.030
			M8X35	200	07105.080.035	M16X40	25	07105.160.040
M5X10	200	07105.050.010	M8X40	200	07105.080.040	M16X45	25	07105.160.045
M5X12	200	07105.050.012	M8X50	200	07105.080.050	M16X50	25	07105.160.050
M5X16	200	07105.050.016				M16X60	25	07105.160.060
M5X20	200	07105.050.020	M10X16	200	07105.100.016	M16X70	25	07105.160.070
M5X25	200	07105.050.025	M10X20	200	07105.100.020	M16X80	25	07105.160.080
			M10X25	200	07105.100.025			
M6X10	200	07105.060.010	M10X30	200	07105.100.030	M20X30	25	07105.200.030
M6X12	200	07105.060.012	M10X35	100	07105.100.035	M20X40	25	07105.200.040
M6X16	200	07105.060.016	M10X40	100	07105.100.040	M20X50	25	07105.200.050
M6X20	200	07105.060.020	M10X50	100	07105.100.050	M20X60	25	07105.200.060
M6X25	200	07105.060.025				M20X70	25	07105.200.070
M6X30	200	07105.060.030	M12X20	100	07105.120.020	M20X80	25	07105.200.080
M6X35	200	07105.060.035	M12X25	100	07105.120.025	M20X90	25	07105.200.090
M6X40	200	07105.060.040	M12X30	100	07105.120.030	M20X100	25	07105.200.100
			M12X35	100	07105.120.035	M20X110	25	07105.200.110
M8X10	200	07105.080.010	M12X40	100	07105.120.040			

• Ostrzeżenie: cynkowanie elektrolityczne tych produktów może wywołać kruchość wodorową.

51040 Śruby z łbem walcowym niskim z gniazdem sześciokątnym								Q05A
Gwint	Metryczny							
Materiał	Stal nierdzewna A2							
								

d x L	☒	Kod artykułu	d x L	☒	Kod artykułu	d x L	☒	Kod artykułu
M3X3*	1000	51040.030.003	M4X25*	500	51040.040.025	M6X6*	500	51040.060.006
M3X4*	1000	51040.030.004	M4X30	200	51040.040.030	M6X8	500	51040.060.008
M3X5*	1000	51040.030.005	M4X35*	200	51040.040.035	M6X10	200	51040.060.010
M3X6*	1000	51040.030.006	M4X40*	200	51040.040.040	M6X12	200	51040.060.012
M3X8	1000	51040.030.008	M4X45*	200	51040.040.045	M6X14*	200	51040.060.014
M3X10	1000	51040.030.010	M4X50*	200	51040.040.050	M6X16	200	51040.060.016
M3X12	1000	51040.030.012	M4X55*	200	51040.040.055	M6X18*	200	51040.060.018
M3X14*	1000	51040.030.014	M4X60*	100	51040.040.060	M6X20	200	51040.060.020
M3X16*	1000	51040.030.016				M6X22*	200	51040.060.022
M3X18*	1000	51040.030.018	M5X5*	500	51040.050.005	M6X25	100	51040.060.025
M3X20*	1000	51040.030.020	M5X6*	500	51040.050.006	M6X30	100	51040.060.030
M3X22*	1000	51040.030.022	M5X8	200	51040.050.008	M6X35	100	51040.060.035
M3X25*	1000	51040.030.025	M5X10	200	51040.050.010	M6X40	100	51040.060.040
M3X30*	1000	51040.030.030	M5X12	200	51040.050.012	M6X45	100	51040.060.045
M3X35*	500	51040.030.035	M5X14	500	51040.050.014	M6X50	100	51040.060.050
M3X40*	500	51040.030.040	M5X16	200	51040.050.016	M6X55*	100	51040.060.055
M3X45*	500	51040.030.045	M5X18*	500	51040.050.018	M6X60*	100	51040.060.060
M3X50*	200	51040.030.050	M5X20	200	51040.050.020	M6X65*	100	51040.060.065
			M5X22*	500	51040.050.022	M6X70*	100	51040.060.070
M4X4*	1000	51040.040.004	M5X25	200	51040.050.025	M6X75*	100	51040.060.075
M4X5*	1000	51040.040.005	M5X30	200	51040.050.030	M6X80*	100	51040.060.080
M4X6	200	51040.040.006	M5X35*	200	51040.050.035	M6X90*	100	51040.060.090
M4X8	200	51040.040.008	M5X40*	200	51040.050.040	M6X100*	100	51040.060.100
M4X10	200	51040.040.010	M5X45	200	51040.050.045	M6X120*	100	51040.060.120
M4X12	200	51040.040.012	M5X50	100	51040.050.050			
M4X14*	1000	51040.040.014	M5X60*	100	51040.050.060	M8X8*	500	51040.080.008
M4X16	200	51040.040.016	M5X65*	100	51040.050.065	M8X10*	500	51040.080.010
M4X18*	1000	51040.040.018	M5X70*	100	51040.050.070	M8X12	100	51040.080.012
M4X20	200	51040.040.020	M5X75*	100	51040.050.075	M8X14*	200	51040.080.014
M4X22*	500	51040.040.022	M5X80*	100	51040.050.080			

51040 Śruby z łbem walcowym niskim z gniazdem sześciokątnym								
d x L	☒	Kod artykułu	d x L	☒	Kod artykułu	d x L	☒	Kod artykułu
M8X16	100	51040.080.016	M10X40	50	51040.100.040	M12X120*	25	51040.120.120
M8X18*	200	51040.080.018	M10X45	50	51040.100.045	M16X25*	25	51040.160.025
M8X20	100	51040.080.020	M10X50	50	51040.100.050	M16X30	10	51040.160.030
M8X22*	200	51040.080.022	M10X55*	50	51040.100.055	M16X35	10	51040.160.035
M8X25	100	51040.080.025	M10X60	25	51040.100.060	M16X40*	25	51040.160.040
M8X30	100	51040.080.030	M10X65*	50	51040.100.065	M16X45	10	51040.160.045
M8X35	100	51040.080.035	M10X70	25	51040.100.070	M16X50	10	51040.160.050
M8X40	100	51040.080.040	M10X80*	50	51040.100.080	M16X55*	25	51040.160.055
M8X45	50	51040.080.045	M10X90*	50	51040.100.090	M16X60	10	51040.160.060
M8X50	50	51040.080.050	M10X100*	50	51040.100.100	M16X65*	25	51040.160.065
M8X55*	100	51040.080.055	M12X16*	50	51040.120.016	M16X70*	25	51040.160.070
M8X60	50	51040.080.060	M12X20	50	51040.120.020	M16X80	5	51040.160.080
M8X65*	100	51040.080.065	M12X22*	50	51040.120.022	M16X90*	25	51040.160.090
M8X70*	100	51040.080.070	M12X25	50	51040.120.025	M16X100	5	51040.160.100
M8X75*	100	51040.080.075	M12X25	50	51040.120.025	M16X150*	25	51040.160.150
M8X80*	100	51040.080.080	M12X30	50	51040.120.030	M20X30*	25	51040.200.030
M8X90*	100	51040.080.090	M12X35	50	51040.120.035	M20X35*	25	51040.200.035
M8X100*	50	51040.080.100	M12X40	25	51040.120.040	M20X40*	25	51040.200.040
M8X110*	50	51040.080.110	M12X45	25	51040.120.045	M20X45*	25	51040.200.045
M8X120*	50	51040.080.120	M12X50	25	51040.120.050	M20X50*	25	51040.200.050
M10X16	100	51040.100.016	M12X55*	50	51040.120.055	M20X60	5	51040.200.060
M10X18*	100	51040.100.018	M12X60	25	51040.120.060	M20X70*	25	51040.200.070
M10X20	100	51040.100.020	M12X65*	50	51040.120.065	M20X80*	25	51040.200.080
M10X22*	100	51040.100.022	M12X70	25	51040.120.070	M20X90*	25	51040.200.090
M10X25	50	51040.100.025	M12X75*	25	51040.120.075	M20X100*	25	51040.200.100
M10X30	50	51040.100.030	M12X80	25	51040.120.080	M20X110*	25	51040.200.110
M10X35	50	51040.100.035	M12X90*	25	51040.120.090			
			M12X100	25	51040.120.100			

55040 Śruby z łbem walcowym niskim z gniazdem sześciokątnym		Q45A
Gwint	Metryczny	
Material	Stal nierdzewna A4	
		
		

d x L	☒	Kod artykułu	d x L	☒	Kod artykułu	d x L	☒	Kod artykułu
M3X4*	1000	55040.030.004	M5X30*	200	55040.050.030	M8X40*	100	55040.080.040
M3X5*	1000	55040.030.005	M5X35*	200	55040.050.035	M8X45*	100	55040.080.045
M3X6*	1000	55040.030.006	M5X40*	200	55040.050.040	M8X50*	100	55040.080.050
M3X8*	1000	55040.030.008	M5X45*	200	55040.050.045	M8X55*	100	55040.080.055
M3X10*	1000	55040.030.010	M5X50*	200	55040.050.050	M8X60*	100	55040.080.060
M3X12*	1000	55040.030.012	M5X60*	100	55040.050.060	M8X65*	100	55040.080.065
M3X14*	1000	55040.030.014	M5X65*	100	55040.050.065	M8X70*	100	55040.080.070
M3X16*	1000	55040.030.016	M5X75*	100	55040.050.075	M8X80*	100	55040.080.080
M3X18*	1000	55040.030.018	M5X80*	100	55040.050.080	M8X90*	100	55040.080.090
M3X20*	1000	55040.030.020	M6X8*	500	55040.060.008	M8X100*	50	55040.080.100
M3X22*	1000	55040.030.022	M6X10	500	55040.060.010	M10X16*	100	55040.100.016
M3X25*	1000	55040.030.025	M6X12*	500	55040.060.012	M10X18*	100	55040.100.018
M3X30*	1000	55040.030.030	M6X14*	200	55040.060.014	M10X20*	100	55040.100.020
M3X35*	500	55040.030.035	M6X16*	200	55040.060.016	M10X22*	100	55040.100.022
M4X4*	1000	55040.040.004	M6X18*	200	55040.060.018	M10X25*	100	55040.100.025
M4X5*	1000	55040.040.005	M6X20*	200	55040.060.020	M10X30*	100	55040.100.030
M4X6*	1000	55040.040.006	M6X22*	200	55040.060.022	M10X35*	100	55040.100.035
M4X8*	1000	55040.040.008	M6X25*	200	55040.060.025	M10X40*	100	55040.100.040
M4X10*	1000	55040.040.010	M6X30*	200	55040.060.030	M10X45*	100	55040.100.045
M4X12*	1000	55040.040.012	M6X35*	200	55040.060.035	M10X50*	50	55040.100.050
M4X14*	1000	55040.040.014	M6X40*	200	55040.060.040	M10X55*	50	55040.100.055
M4X16*	1000	55040.040.016	M6X45*	100	55040.060.045	M10X60*	50	55040.100.060
M4X18*	1000	55040.040.018	M6X50*	100	55040.060.050	M10X65*	50	55040.100.065
M4X20*	500	55040.040.020	M6X55*	100	55040.060.055	M10X70*	50	55040.100.070
M4X22*	500	55040.040.022	M6X60*	100	55040.060.060	M10X75*	50	55040.100.075
M4X25*	500	55040.040.025	M6X65*	100	55040.060.065	M10X80*	50	55040.100.080
M4X30*	500	55040.040.030	M6X70*	100	55040.060.070	M10X100*	50	55040.100.100
M4X35*	200	55040.040.035	M6X80*	100	55040.060.080	M10X110*	50	55040.100.110
M4X40*	200	55040.040.040	M6X90*	100	55040.060.090	M12X16*	50	55040.120.016
M4X50*	200	55040.040.050	M6X100*	100	55040.060.100	M12X18*	50	55040.120.018
M4X60*	100	55040.040.060	M8X8*	500	55040.080.008	M12X20*	50	55040.120.020
M5X6*	500	55040.050.006	M8X10*	500	55040.080.010	M12X25*	50	55040.120.025
M5X8*	500	55040.050.008	M8X12*	500	55040.080.012	M12X30*	50	55040.120.030
M5X10*	500	55040.050.010	M8X14*	200	55040.080.014	M12X35*	50	55040.120.035
M5X12	500	55040.050.012	M8X16*	200	55040.080.016	M12X40*	50	55040.120.040
M5X14*	500	55040.050.014	M8X18*	200	55040.080.018	M12X45*	50	55040.120.045
M5X16*	500	55040.050.016	M8X22*	200	55040.080.022	M12X50*	50	55040.120.050
M5X18*	500	55040.050.018	M8X25*	100	55040.080.025	M12X55*	50	55040.120.055
M5X20*	500	55040.050.020	M8X30*	100	55040.080.030	M12X60*	50	55040.120.060
M5X25*	200	55040.050.025	M8X35*	100	55040.080.035	M12X65*	50	55040.120.065

55040 Śruby z łbem walcowym niskim z gniazdem sześciokątnym								
d x L	☒	Kod artykułu	d x L	☒	Kod artykułu	d x L	☒	Kod artykułu
M12X70*	50	55040.120.070	M16X45*	25	55040.160.045	M20X40*	25	55040.200.040
M12X80*	25	55040.120.080	M16X50*	25	55040.160.050	M20X45*	25	55040.200.045
M12X90*	25	55040.120.090	M16X55*	25	55040.160.055	M20X50*	25	55040.200.050
M12X100*	25	55040.120.100	M16X60*	25	55040.160.060	M20X55*	25	55040.200.055
M12X110*	25	55040.120.110	M16X65*	25	55040.160.065	M20X60*	25	55040.200.060
M16X25*	25	55040.160.025	M16X70*	25	55040.160.070	M20X65*	25	55040.200.065
M16X30*	25	55040.160.030	M16X80*	25	55040.160.080	M20X70*	25	55040.200.070
M16X35*	25	55040.160.035	M20X30*	25	55040.200.030	M20X80*	25	55040.200.080
M16X40*	25	55040.160.040	M20X35*	25	55040.200.035	M20X90*	25	55040.200.090
						M20X120*	25	55040.200.120

Śruby z łbem walcowym niskim z gniazdem sześciokątnym z prowadzeniem na klucz sześciokątny

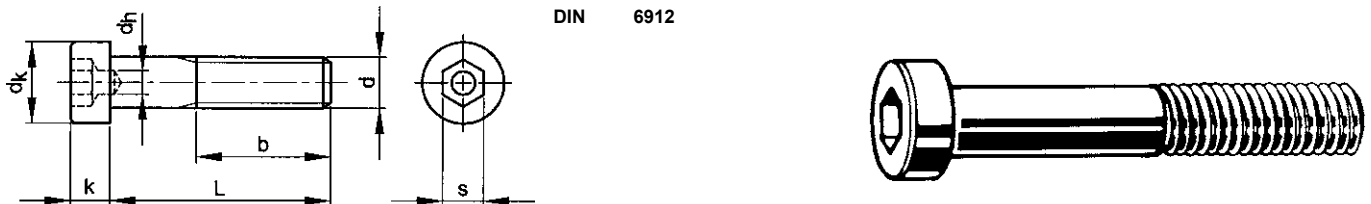

DIN 6912

Informacje techniczne

d	b (min.): L≤125mm	b (min.): 125mm<L≤200mm	b (min.): L>200mm	dh	dk	k	P	Pełen gwint L ≤	s
M3 (#DIN)	12	-	-	-	5.5	2	0.5	18	2
M4	14	-	-	2	7	2.8	0.7	16	3
M5	16	-	-	2.5	8.5	3.5	0.8	20	4
M6	18	-	-	3	10	4	1	25	5
M8	22	-	-	4	13	5	1.25	30	6
M10	26	32	-	5	16	6.5	1.5	35	8
M12	30	36	-	6	18	7.5	1.75	45	10
M16	38	44	57	8	24	10	2	50	14
M20	46	52	65	10	30	12	2.5	60	17
M24	54	60	73	12	36	14	3	80	19

- W związku z niestandardową geometrią łba elementy złączne mają ograniczoną obciążalność.
- W przypadku znakowania śrub o ograniczonej obciążalności, symbol standardowego oznaczenia poprzedza cyfra "0", tak więc 8.8→08.8 ; 10.9→010.9 oraz 12.9→012.9
- Dla elementów złącznych ze stali nierdzewnej oznaczenie następuje poprzez oznaczenie cechy danej klasy na przykład: 70 (A2-70 → A2).
- Tymczasowo mogą pojawić się stare i nowe formy znakowania na śrubach.

Grupy katalogowe

Gwint	Gniazdo	Materiał	Klasa	Kod	Strona
M	Gniazdo sześciokątne	St	08.8	07030	2-36
M	Gniazdo sześciokątne	St.St. A2		51042	2-37
M	Gniazdo sześciokątne	St.St. A4		55042	2-38

07030 Śruby z łbem walcowym niskim z gniazdem sześciokątnym z prowadzeniem na klucz sześciokątny		D03A
Gwint	Metryczny	
Materiał	Stal	
Klasa	08.8	

d x L	☒	Kod artykułu	d x L	☒	Kod artykułu	d x L	☒	Kod artykułu
M4X8	200	07030.040.008	M6X12	200	07030.060.012	M8X40	200	07030.080.040
M4X10	200	07030.040.010	M6X16	200	07030.060.016	M8X45	200	07030.080.045
M4X12	200	07030.040.012	M6X20	200	07030.060.020	M8X50	200	07030.080.050
M4X16	200	07030.040.016	M6X25	200	07030.060.025	M8X60	200	07030.080.060
M4X20	200	07030.040.020	M6X30	200	07030.060.030			
M4X25	200	07030.040.025	M6X35	200	07030.060.035	M10X20	200	07030.100.020
			M6X40	200	07030.060.040	M10X22	200	07030.100.022
M5X10	200	07030.050.010	M6X45	200	07030.060.045	M10X25	200	07030.100.025
M5X12	200	07030.050.012	M6X50	200	07030.060.050	M10X30	200	07030.100.030
M5X16	200	07030.050.016	M6X60	200	07030.060.060	M10X35	100	07030.100.035
M5X20	200	07030.050.020				M10X40	100	07030.100.040
M5X25	200	07030.050.025	M8X12	200	07030.080.012	M10X50	100	07030.100.050
M5X30	200	07030.050.030	M8X16	200	07030.080.016	M10X60	100	07030.100.060
M5X35	200	07030.050.035	M8X20	200	07030.080.020	M10X70	100	07030.100.070
M5X40	200	07030.050.040	M8X25	200	07030.080.025	M10X80	100	07030.100.080
			M8X30	200	07030.080.030	M10X100	100	07030.100.100
M6X10	200	07030.060.010	M8X35	200	07030.080.035			

07030 Śruby z łbem walcowym niskim z gniazdem sześciokątnym z prowadzeniem na klucz sześciokątny ←								
d x L	☒	Kod artykułu	d x L	☒	Kod artykułu	d x L	☒	Kod artykułu
M12X20	100	07030.120.020	M16X40	50	07030.160.040	M20X70	25	07030.200.070
M12X25	100	07030.120.025	M16X45	50	07030.160.045	M20X80	25	07030.200.080
M12X30	100	07030.120.030	M16X50	50	07030.160.050	M20X90	25	07030.200.090
M12X35	100	07030.120.035	M16X60	50	07030.160.060	M20X100	25	07030.200.100
M12X40	100	07030.120.040	M16X70	50	07030.160.070	M20X120	25	07030.200.120
M12X45	100	07030.120.045	M16X80	50	07030.160.080	M20X140	25	07030.200.140
M12X50	100	07030.120.050	M16X90	25	07030.160.090			
M12X60	100	07030.120.060	M16X100	25	07030.160.100	M24X50	10	07030.240.050
M12X80	50	07030.120.080	M16X120	25	07030.160.120	M24X60	10	07030.240.060
M12X90	50	07030.120.090				M24X70	10	07030.240.070
M12X100	50	07030.120.100	M20X40	25	07030.200.040	M24X80	10	07030.240.080
			M20X45	25	07030.200.045	M24X90	10	07030.240.090
M16X30	50	07030.160.030	M20X50	25	07030.200.050	M24X100	10	07030.240.100
M16X35	50	07030.160.035	M20X60	25	07030.200.060	M24X120	10	07030.240.120

51042 Śruby z łbem walcowym niskim z gniazdem sześciokątnym z prowadzeniem na klucz sześciokątny		Q05A
Gwint	Metryczny	
Material	Stal nierdzewna A2	

d x L	☒	Kod artykułu	d x L	☒	Kod artykułu	d x L	☒	Kod artykułu
M3X5*	1000	51042.030.005	M6X20	100	51042.060.020	M10X80	10	51042.100.080
M3X6*	1000	51042.030.006	M6X22*	200	51042.060.022	M10X90	10	51042.100.090
M3X8*	1000	51042.030.008	M6X25	50	51042.060.025	M10X100	10	51042.100.100
M3X10*	1000	51042.030.010	M6X30	50	51042.060.030	M10X110*	50	51042.100.110
M3X12*	1000	51042.030.012	M6X35	50	51042.060.035	M10X120*	50	51042.100.120
M3X16*	1000	51042.030.016	M6X40	50	51042.060.040			
M3X20*	1000	51042.030.020	M6X45	50	51042.060.045	M12X16	25	51042.120.016
M3X25*	1000	51042.030.025	M6X50	50	51042.060.050	M12X20	25	51042.120.020
M3X30*	1000	51042.030.030	M6X55	50	51042.060.055	M12X25	25	51042.120.025
			M6X60	25	51042.060.060	M12X30	25	51042.120.030
M4X5*	1000	51042.040.005	M6X65*	100	51042.060.065	M12X35	25	51042.120.035
M4X6*	1000	51042.040.006	M6X70	25	51042.060.070	M12X40	10	51042.120.040
M4X8	100	51042.040.008	M6X75*	100	51042.060.075	M12X45	10	51042.120.045
M4X10	100	51042.040.010	M6X80	25	51042.060.080	M12X50	10	51042.120.050
M4X12	100	51042.040.012	M6X90*	100	51042.060.090	M12X55	10	51042.120.055
M4X14*	1000	51042.040.014	M6X100*	100	51042.060.100	M12X60	10	51042.120.060
M4X16	100	51042.040.016	M6X120*	100	51042.060.120	M12X65*	50	51042.120.065
M4X18*	1000	51042.040.018				M12X70	5	51042.120.070
M4X20	100	51042.040.020	M8X10	50	51042.080.010	M12X75*	25	51042.120.075
M4X22*	500	51042.040.022	M8X12	50	51042.080.012	M12X80	5	51042.120.080
M4X25	100	51042.040.025	M8X14*	200	51042.080.014	M12X90	5	51042.120.090
M4X30	100	51042.040.030	M8X16	50	51042.080.016	M12X100	5	51042.120.100
M4X35	100	51042.040.035	M8X18*	200	51042.080.018	M12X120*	25	51042.120.120
M4X40	100	51042.040.040	M8X20	50	51042.080.020			
M4X45*	200	51042.040.045	M8X22*	200	51042.080.022	M16X25	10	51042.160.025
M4X50*	200	51042.040.050	M8X25	50	51042.080.025	M16X30	10	51042.160.030
M4X55*	200	51042.040.055	M8X30	50	51042.080.030	M16X35	5	51042.160.035
M4X60*	100	51042.040.060	M8X35	50	51042.080.035	M16X40	5	51042.160.040
			M8X40	50	51042.080.040	M16X45	5	51042.160.045
M5X6*	500	51042.050.006	M8X45*	100	51042.080.045	M16X50	5	51042.160.050
M5X8	100	51042.050.008	M8X50	25	51042.080.050	M16X55	5	51042.160.055
M5X10	100	51042.050.010	M8X55	25	51042.080.055	M16X60	5	51042.160.060
M5X12	100	51042.050.012	M8X60	25	51042.080.060	M16X65*	25	51042.160.065
M5X14*	500	51042.050.014	M8X65*	100	51042.080.065	M16X70	5	51042.160.070
M5X16	100	51042.050.016	M8X70	10	51042.080.070	M16X75*	25	51042.160.075
M5X18*	500	51042.050.018	M8X75*	100	51042.080.075	M16X80	3	51042.160.080
M5X20	100	51042.050.020	M8X80	10	51042.080.080	M16X90	3	51042.160.090
M5X22*	500	51042.050.022	M8X85*	100	51042.080.085	M16X100	3	51042.160.100
M5X25	100	51042.050.025	M8X90*	100	51042.080.090	M16X110*	25	51042.160.110
M5X30	100	51042.050.030	M8X100	10	51042.080.100	M16X120*	25	51042.160.120
M5X35	50	51042.050.035	M8X120*	50	51042.080.120			
M5X40	50	51042.050.040				M20X30*	25	51042.200.030
M5X45	50	51042.050.045	M10X16	50	51042.100.016	M20X35	3	51042.200.035
M5X50	50	51042.050.050	M10X18*	100	51042.100.018	M20X40	3	51042.200.040
M5X55*	200	51042.050.055	M10X20	50	51042.100.020	M20X45	3	51042.200.045
M5X60*	100	51042.050.060	M10X25	25	51042.100.025	M20X50*	25	51042.200.050
M5X65*	100	51042.050.065	M10X30	25	51042.100.030	M20X55*	25	51042.200.055
M5X70*	100	51042.050.070	M10X35	25	51042.100.035	M20X60	3	51042.200.060
M5X80*	100	51042.050.080	M10X40	25	51042.100.040	M20X70	3	51042.200.070
			M10X45*	100	51042.100.045	M20X80	3	51042.200.080
M6X8	100	51042.060.008	M10X50	25	51042.100.050	M20X90	3	51042.200.090
M6X10	100	51042.060.010	M10X55	25	51042.100.055	M20X100	3	51042.200.100
M6X12	100	51042.060.012	M10X60	10	51042.100.060	M20X120*	25	51042.200.120
M6X14*	200	51042.060.014	M10X65*	50	51042.100.065			
M6X16	100	51042.060.016	M10X70	10	51042.100.070	M24X55	3	51042.240.055
M6X18*	200	51042.060.018	M10X75*	50	51042.100.075	M24X60	3	51042.240.060

51042 Śruby z łbem walcowym niskim z gniazdem sześciokątnym z prowadzeniem na klucz sześciokątny

d x L	☒	Kod artykułu
M24X70	3	51042.240.070

55042 Śruby z łbem walcowym niskim z gniazdem sześciokątnym z prowadzeniem na klucz sześciokątny
Q45A
Gwint Metryczny
Materiał Stal nierdzewna A4

d x L	☒	Kod artykułu	d x L	☒	Kod artykułu	d x L	☒	Kod artykułu
M3X5*	1000	55042.030.005	M6X25	50	55042.060.025	M10X80*	50	55042.100.080
M3X6*	1000	55042.030.006	M6X30	50	55042.060.030	M10X90*	50	55042.100.090
M3X8*	1000	55042.030.008	M6X35	50	55042.060.035	M10X100*	50	55042.100.100
M3X10*	1000	55042.030.010	M6X40	50	55042.060.040	M10X120*	50	55042.100.120
M3X12*	1000	55042.030.012	M6X45*	100	55042.060.045			
			M6X50	50	55042.060.050	M12X16*	50	55042.120.016
M4X5*	1000	55042.040.005	M6X55*	100	55042.060.055	M12X20	25	55042.120.020
M4X6*	1000	55042.040.006	M6X60*	100	55042.060.060	M12X25	25	55042.120.025
M4X8*	1000	55042.040.008	M6X70*	100	55042.060.070	M12X30	25	55042.120.030
M4X10	100	55042.040.010	M6X75*	100	55042.060.075	M12X35	25	55042.120.035
M4X12	100	55042.040.012	M6X80*	100	55042.060.080	M12X40	10	55042.120.040
M4X14*	1000	55042.040.014	M6X90*	100	55042.060.090	M12X45*	50	55042.120.045
M4X16	100	55042.040.016	M6X120*	100	55042.060.120	M12X50	10	55042.120.050
M4X20	100	55042.040.020				M12X55*	50	55042.120.055
M4X22*	500	55042.040.022	M8X10*	500	55042.080.010	M12X60	10	55042.120.060
M4X25	100	55042.040.025	M8X12*	500	55042.080.012	M12X70*	50	55042.120.070
M4X30	100	55042.040.030	M8X14*	200	55042.080.014	M12X75*	25	55042.120.075
M4X35*	200	55042.040.035	M8X16	50	55042.080.016	M12X80*	25	55042.120.080
M4X40*	200	55042.040.040	M8X18*	200	55042.080.018	M12X90*	25	55042.120.090
M4X45*	200	55042.040.045	M8X20	50	55042.080.020	M12X100*	25	55042.120.100
M4X50*	200	55042.040.050	M8X22*	200	55042.080.022			
			M8X25	50	55042.080.025	M16X25*	25	55042.160.025
M5X6*	500	55042.050.006	M8X30	50	55042.080.030	M16X30	10	55042.160.030
M5X8*	500	55042.050.008	M8X35	50	55042.080.035	M16X35	5	55042.160.035
M5X10	100	55042.050.010	M8X40	50	55042.080.040	M16X40*	25	55042.160.040
M5X12	100	55042.050.012	M8X45*	100	55042.080.045	M16X45	5	55042.160.045
M5X14*	500	55042.050.014	M8X50	25	55042.080.050	M16X50	5	55042.160.050
M5X16	100	55042.050.016	M8X55*	100	55042.080.055	M16X55*	25	55042.160.055
M5X18*	500	55042.050.018	M8X60	25	55042.080.060	M16X60*	25	55042.160.060
M5X20	100	55042.050.020	M8X65*	100	55042.080.065	M16X70	5	55042.160.070
M5X22*	500	55042.050.022	M8X70*	100	55042.080.070	M16X80	3	55042.160.080
M5X25	100	55042.050.025	M8X75*	100	55042.080.075	M16X90	5	55042.160.090
M5X30	100	55042.050.030	M8X80*	100	55042.080.080	M16X100*	25	55042.160.100
M5X35	50	55042.050.035	M8X90*	100	55042.080.090	M16X110*	25	55042.160.110
M5X40	50	55042.050.040	M8X100*	50	55042.080.100	M16X130*	25	55042.160.130
M5X45*	200	55042.050.045	M8X110*	50	55042.080.110			
M5X50*	200	55042.050.050	M8X120*	50	55042.080.120	M20X35*	25	55042.200.035
M5X55*	200	55042.050.055				M20X40	3	55042.200.040
M5X60*	100	55042.050.060	M10X16*	100	55042.100.016	M20X45*	25	55042.200.045
M5X65*	100	55042.050.065	M10X20	50	55042.100.020	M20X50	3	55042.200.050
M5X70*	100	55042.050.070	M10X25	25	55042.100.025	M20X55*	25	55042.200.055
			M10X30	25	55042.100.030	M20X60	3	55042.200.060
M6X8*	500	55042.060.008	M10X35	50	55042.100.035	M20X65*	25	55042.200.065
M6X10*	500	55042.060.010	M10X40	25	55042.100.040	M20X70	3	55042.200.070
M6X12	100	55042.060.012	M10X45*	100	55042.100.045	M20X80	3	55042.200.080
M6X14*	200	55042.060.014	M10X50	25	55042.100.050	M20X90	3	55042.200.090
M6X16	100	55042.060.016	M10X55*	50	55042.100.055	M20X100	3	55042.200.100
M6X18*	200	55042.060.018	M10X60	10	55042.100.060	M20X120*	25	55042.200.120
M6X20	100	55042.060.020	M10X70*	50	55042.100.070	M20X150*	25	55042.200.150
M6X22*	200	55042.060.022	M10X75*	50	55042.100.075			

Śruby z łbem stożkowym płaskim z gniazdem sześciokątnym

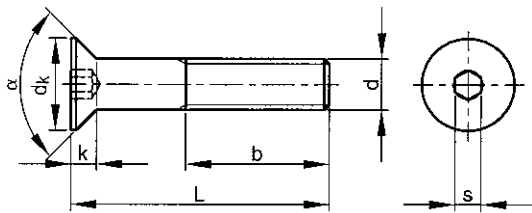

ISO 10642
DIN 7991
NEN 2359
BS 4168-8

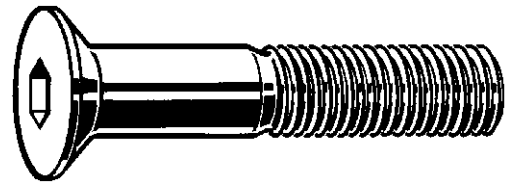

2

Informacje techniczne

d	b	d _k	k (maks.)	P	Pelen gwint L ≤	s	α
M3	18	6.72	1.86	0.5	25	2	90°
M4	20	8.96	2.48	0.7	25	2.5	90°
M5	22	11.2	3.2	0.8	30	3	90°
M6	24	13.44	3.72	1	35	4	90°
M8	28	17.92	4.96	1.25	45	5	90°
M10	32	22.4	6.2	1.5	50	6	90°
M12	36	26.88	7.4	1.75	60	8	90°
M14	40	30.8	8.4	2	65	10	90°
M16	44	33.6	8.8	2	70	10	90°
M18 (DIN)	42	33	8	2.5	60	12	90°
M20	52	40.32	10.16	2.5	90	12	90°
M24 (DIN)	54	39	14	3	90	14	60°

- Wszystkie wymiary są poglądowe i mogą różnić się w zależności od producenta.
- W związku z niestandardową geometrią łba elementy złączne mają ograniczoną nośność.
- W momencie potrzeby oznaczania elementów złącznych (np. 8.8 / 10.9 / 12.9) z ograniczoną nośnością, symbol oznaczenia poprzedza cyfra "0", tak więc 8.8 → 08.8 10.9 → 010.9 oraz 12.9 → 012.9.
- Dla elementów złącznych ze stali nierdzewnej oznaczenie następuje poprzez oznaczenie cechy danej klasy na przykład: 70 (A2-70 → A2).
- Stare i nowe wskazania mogą się pojawić wzajemnie przez jakiś czas.

Grupy katalogowe

Gwint	Gniazdo	Materiał	Klasa	Obróbka powierzchni	Kod	Strona
M	Gniazdo sześciokątne	St	08.8	Ocynk.	07470	2-39
M	Gniazdo sześciokątne	St	010.9		07400	2-40
M	Gniazdo sześciokątne	St	010.9	FLZNNC-NC6	07407	2-41
M	Gniazdo sześciokątne	St.St. A2			51060	2-41
M	Gniazdo sześciokątne	St.St. A4			55060	2-42
M	Gniazdo sześciokątne	Al P40			45008	2-43
M	Gniazdo sześciokątne	Al P60			45208	2-44

07470 Śruby z łbem stożkowym płaskim z gniazdem sześciokątnym

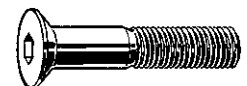

D02A

Gwint Metryczny
Materiał Stal
Klasa 08.8
Obróbka powierzchni Ocynkowane

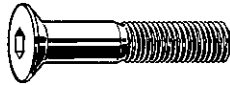

d x L	☒	Kod artykułu	d x L	☒	Kod artykułu	d x L	☒	Kod artykułu
M3X6	200	07470.030.006				M6X35	200	07470.060.035
M3X8	200	07470.030.008	M5X8	200	07470.050.008	M6X40	200	07470.060.040
M3X10	200	07470.030.010	M5X10	200	07470.050.010	M6X45	200	07470.060.045
M3X12	200	07470.030.012	M5X12	200	07470.050.012	M6X50	200	07470.060.050
M3X16	200	07470.030.016	M5X16	200	07470.050.016	M6X60	200	07470.060.060
M3X20	200	07470.030.020	M5X20	200	07470.050.020	M6X70	200	07470.060.070
M3X25	200	07470.030.025	M5X25	200	07470.050.025	M6X80	200	07470.060.080
M3X30	200	07470.030.030	M5X30	200	07470.050.030			
M3X40	200	07470.030.040	M5X35	200	07470.050.035	M8X10	200	07470.080.010
M3X50	200	07470.030.050	M5X40	200	07470.050.040	M8X12	200	07470.080.012
			M5X45	200	07470.050.045	M8X16	200	07470.080.016
M4X6	200	07470.040.006	M5X50	200	07470.050.050	M8X20	200	07470.080.020
M4X8	200	07470.040.008	M5X60	200	07470.050.060	M8X25	200	07470.080.025
M4X10	200	07470.040.010	M5X70	200	07470.050.070	M8X30	200	07470.080.030
M4X12	200	07470.040.012				M8X35	200	07470.080.035
M4X16	200	07470.040.016	M6X8	200	07470.060.008	M8X40	200	07470.080.040
M4X20	200	07470.040.020	M6X10	200	07470.060.010	M8X45	200	07470.080.045
M4X25	200	07470.040.025	M6X12	200	07470.060.012	M8X50	200	07470.080.050
M4X30	200	07470.040.030	M6X16	200	07470.060.016	M8X55	200	07470.080.055
M4X35	200	07470.040.035	M6X18	200	07470.060.018	M8X60	200	07470.080.060
M4X40	200	07470.040.040	M6X20	200	07470.060.020	M8X65	200	07470.080.065
M4X50	200	07470.040.050	M6X25	200	07470.060.025	M8X70	200	07470.080.070
M4X60	200	07470.040.060	M6X30	200	07470.060.030	M8X80	200	07470.080.080

07470 Śruby z łbem stożkowym płaskim z gniazdem sześciokątnym								
d x L	☒	Kod artykułu	d x L	☒	Kod artykułu	d x L	☒	Kod artykułu
M8X90	200	07470.080.090	M12X25	100	07470.120.025	M16X60	50	07470.160.060
M8X100	200	07470.080.100	M12X30	100	07470.120.030	M16X70	25	07470.160.070
M10X16	200	07470.100.016	M12X35	100	07470.120.035	M16X80	25	07470.160.080
M10X20	200	07470.100.020	M12X40	100	07470.120.040	M16X100	25	07470.160.100
M10X25	200	07470.100.025	M12X45	100	07470.120.045	M16X120	25	07470.160.120
M10X30	200	07470.100.030	M12X50	100	07470.120.050	M16X140	25	07470.160.140
M10X35	100	07470.100.035	M12X55	100	07470.120.055	M20X40	25	07470.200.040
M10X40	100	07470.100.040	M12X60	100	07470.120.060	M20X45	25	07470.200.045
M10X45	100	07470.100.045	M12X70	50	07470.120.070	M20X50	25	07470.200.050
M10X50	100	07470.100.050	M12X80	50	07470.120.080	M20X60	25	07470.200.060
M10X55	100	07470.100.055	M12X90	50	07470.120.090	M20X70	25	07470.200.070
M10X60	100	07470.100.060	M12X100	50	07470.120.100	M20X80	25	07470.200.080
M10X70	100	07470.100.070	M12X120	50	07470.120.120	M20X90	25	07470.200.090
M10X80	100	07470.100.080	M16X30	50	07470.160.030	M20X100	25	07470.200.100
M10X90	100	07470.100.090	M16X35	50	07470.160.035	M24X50	25	07470.240.050
M10X100	50	07470.100.100	M16X40	50	07470.160.040	M24X60	10	07470.240.060
M10X120	50	07470.100.120	M16X45	50	07470.160.045	M24X70	10	07470.240.070
M12X20	100	07470.120.020	M16X50	50	07470.160.050	M24X80	10	07470.240.080
			M16X55	50	07470.160.055			

07400 Śruby z łbem stożkowym płaskim z gniazdem sześciokątnym		D01A
Gwint	Metryczny	
Materiał	Stal	
Klasa	010.9	
		

d x L	☒	Kod artykułu	d x L	☒	Kod artykułu	d x L	☒	Kod artykułu
M3X5	200	07400.030.005	M6X25	200	07400.060.025	M12X25	100	07400.120.025
M3X6	200	07400.030.006	M6X30	200	07400.060.030	M12X30	100	07400.120.030
M3X8	200	07400.030.008	M6X35	200	07400.060.035	M12X35	100	07400.120.035
M3X10	200	07400.030.010	M6X40	200	07400.060.040	M12X40	100	07400.120.040
M3X12	200	07400.030.012	M6X45	200	07400.060.045	M12X45	100	07400.120.045
M3X16	200	07400.030.016	M6X50	200	07400.060.050	M12X50	100	07400.120.050
M3X20	200	07400.030.020	M6X55	200	07400.060.055	M12X55	100	07400.120.055
M3X25	200	07400.030.025	M6X60	200	07400.060.060	M12X60	100	07400.120.060
M3X30	200	07400.030.030	M6X70	200	07400.060.070	M12X70	100	07400.120.070
M3X40	200	07400.030.040	M6X80	200	07400.060.080	M12X80	100	07400.120.080
M3X50	200	07400.030.050	M6X90	200	07400.060.090	M12X90	50	07400.120.090
M4X6	200	07400.040.006	M6X100	200	07400.060.100	M12X100	50	07400.120.100
M4X8	200	07400.040.008	M8X10	200	07400.080.010	M12X110	50	07400.120.110
M4X10	200	07400.040.010	M8X12	200	07400.080.012	M12X120	50	07400.120.120
M4X12	200	07400.040.012	M8X16	200	07400.080.016	M12X130	50	07400.120.130
M4X14	200	07400.040.014	M8X20	200	07400.080.020	M12X140	50	07400.120.140
M4X16	200	07400.040.016	M8X22	200	07400.080.022	M12X160	50	07400.120.160
M4X20	200	07400.040.020	M8X25	200	07400.080.025	M12X180	50	07400.120.180
M4X25	200	07400.040.025	M8X30	200	07400.080.030	M14X25	25	07400.140.025
M4X30	200	07400.040.030	M8X35	200	07400.080.035	M14X30	25	07400.140.030
M4X35	200	07400.040.035	M8X40	200	07400.080.040	M14X35	25	07400.140.035
M4X40	200	07400.040.040	M8X45	200	07400.080.045	M14X40	25	07400.140.040
M4X50	200	07400.040.050	M8X50	200	07400.080.050	M14X45	50	07400.140.045
M4X60	200	07400.040.060	M8X55	200	07400.080.055	M14X50	25	07400.140.050
M4X70	200	07400.040.070	M8X60	100	07400.080.060	M14X55	25	07400.140.055
M5X8	200	07400.050.008	M8X70	100	07400.080.070	M14X60	25	07400.140.060
M5X10	200	07400.050.010	M8X80	100	07400.080.080	M14X70	25	07400.140.070
M5X12	200	07400.050.012	M8X90	100	07400.080.090	M14X80	25	07400.140.080
M5X16	200	07400.050.016	M8X100	100	07400.080.100	M14X90	25	07400.140.090
M5X18	200	07400.050.018	M10X16	200	07400.100.016	M14X100	25	07400.140.100
M5X20	200	07400.050.020	M10X20	200	07400.100.020	M16X20	50	07400.160.020
M5X22	200	07400.050.022	M10X25	200	07400.100.025	M16X25	50	07400.160.025
M5X25	200	07400.050.025	M10X30	200	07400.100.030	M16X30	50	07400.160.030
M5X30	200	07400.050.030	M10X35	100	07400.100.035	M16X35	50	07400.160.035
M5X35	200	07400.050.035	M10X40	100	07400.100.040	M16X40	50	07400.160.040
M5X40	200	07400.050.040	M10X45	100	07400.100.045	M16X45	50	07400.160.045
M5X45	200	07400.050.045	M10X50	100	07400.100.050	M16X50	50	07400.160.050
M5X50	200	07400.050.050	M10X55	100	07400.100.055	M16X55	50	07400.160.055
M5X60	200	07400.050.060	M10X60	100	07400.100.060	M16X60	50	07400.160.060
M5X70	200	07400.050.070	M10X65	100	07400.100.065	M16X70	25	07400.160.070
M6X8	200	07400.060.008	M10X70	100	07400.100.070	M16X80	25	07400.160.080
M6X10	200	07400.060.010	M10X75	100	07400.100.075	M16X90	25	07400.160.090
M6X12	200	07400.060.012	M10X80	100	07400.100.080	M16X100	25	07400.160.100
M6X14	200	07400.060.014	M10X90	100	07400.100.090	M16X110	25	07400.160.110
M6X16	200	07400.060.016	M10X100	50	07400.100.100	M16X120	25	07400.160.120
M6X18	200	07400.060.018	M10X120	50	07400.100.120	M16X130	25	07400.160.130
M6X20	200	07400.060.020	M12X20	100	07400.120.020	M16X140	25	07400.160.140
						M16X160	25	07400.160.160

07400 Śruby z łbem stożkowym płaskim z gniazdem sześciokątnym								
d x L	☒	Kod artykułu	d x L	☒	Kod artykułu	d x L	☒	Kod artykułu
M18X50	25	07400.180.050	M20X70	10	07400.200.070	M24X60	10	07400.240.060
M18X60	25	07400.180.060	M20X80	10	07400.200.080	M24X70	10	07400.240.070
M18X70	25	07400.180.070	M20X90	10	07400.200.090	M24X80	10	07400.240.080
M18X80	25	07400.180.080	M20X100	10	07400.200.100	M24X90	10	07400.240.090
M18X90	25	07400.180.090	M20X110	10	07400.200.110	M24X100	10	07400.240.100
M18X100	25	07400.180.100	M20X120	10	07400.200.120	M24X110	10	07400.240.110
			M20X140	10	07400.200.140	M24X120	10	07400.240.120
M20X30	10	07400.200.030	M20X150	10	07400.200.150	M24X140	10	07400.240.140
M20X35	10	07400.200.035	M20X160	10	07400.200.160	M24X160	10	07400.240.160
M20X40	10	07400.200.040	M20X180	10	07400.200.180	M24X180	10	07400.240.180
M20X50	10	07400.200.050	M20X200	10	07400.200.200	M24X200	10	07400.240.200
M20X55	25	07400.200.055						
M20X60	10	07400.200.060	M24X50	10	07400.240.050			



• Ostrzeżenie: cynkowanie elektrolityczne tych produktów może wywołać kruchość wodorową.

07407 Śruby z łbem stożkowym płaskim z gniazdem sześciokątnym								D01A
Gwint	Metryczny							
Materiał	Stal							
Klasa	010.9							
Obróbka powierzchni	O cynk płatkowy bez Cr6+ wg ISO 10683 (flZnnc)							
d x L	☒	Kod artykułu	d x L	☒	Kod artykułu	d x L	☒	Kod artykułu
M6X16	200	07407.060.016	M10X20	200	07407.100.020	M12X70	100	07407.120.070
M6X20	200	07407.060.020	M10X25	200	07407.100.025	M12X80	100	07407.120.080
M6X25	200	07407.060.025	M10X30	200	07407.100.030			
M6X30	200	07407.060.030	M10X35	200	07407.100.035	M16X25	50	07407.160.025
M6X40	200	07407.060.040	M10X40	200	07407.100.040	M16X30	50	07407.160.030
			M10X50	100	07407.100.050	M16X40	50	07407.160.040
M8X16	200	07407.080.016	M10X60	100	07407.100.060	M16X50	50	07407.160.050
M8X20	200	07407.080.020				M16X60	50	07407.160.060
M8X25	200	07407.080.025	M12X30	100	07407.120.030			
M8X30	200	07407.080.030	M12X40	100	07407.120.040	M20X50	10	07407.200.050
M8X35	200	07407.080.035	M12X50	100	07407.120.050	M20X60	10	07407.200.060
M8X40	200	07407.080.040	M12X60	100	07407.120.060	M20X70	10	07407.200.070

• Powlekanie powierzchniowe ISO 10683 cynkowanie płatkowe eliminuje możliwości uszkodzenia, jakie może wywołać kruchość wodorowa.

51060 Śruby z łbem stożkowym płaskim z gniazdem sześciokątnym								Q05A
Gwint	Metryczny							
Materiał	Stal nierdzewna A2							
d x L	☒	Kod artykułu	d x L	☒	Kod artykułu	d x L	☒	Kod artykułu
M3X4*	1000	51060.030.004	M4X25	200	51060.040.025	M5X75*	100	51060.050.075
M3X5*	1000	51060.030.005	M4X30	200	51060.040.030	M5X80*	100	51060.050.080
M3X6	200	51060.030.006	M4X35	200	51060.040.035			
M3X8	200	51060.030.008	M4X40	200	51060.040.040	M6X8	200	51060.060.008
M3X10	200	51060.030.010	M4X45	200	51060.040.045	M6X10	200	51060.060.010
M3X12	200	51060.030.012	M4X50	200	51060.040.050	M6X12	200	51060.060.012
M3X14	200	51060.030.014	M4X55*	200	51060.040.055	M6X14	200	51060.060.014
M3X16	200	51060.030.016	M4X60*	100	51060.040.060	M6X16	200	51060.060.016
M3X18	200	51060.030.018				M6X18	200	51060.060.018
M3X20	200	51060.030.020	M5X6	500	51060.050.006	M6X20	200	51060.060.020
M3X22*	1000	51060.030.022	M5X8	200	51060.050.008	M6X22*	200	51060.060.022
M3X25	200	51060.030.025	M5X10	200	51060.050.010	M6X25	200	51060.060.025
M3X30*	1000	51060.030.030	M5X12	200	51060.050.012	M6X30	200	51060.060.030
M3X35*	500	51060.030.035	M5X14	200	51060.050.014	M6X35	200	51060.060.035
M3X40	200	51060.030.040	M5X16	200	51060.050.016	M6X40	200	51060.060.040
M3X45*	500	51060.030.045	M5X18	200	51060.050.018	M6X45	100	51060.060.045
M3X50	200	51060.030.050	M5X20	200	51060.050.020	M6X50	100	51060.060.050
			M5X22*	500	51060.050.022	M6X55	100	51060.060.055
M4X5*	1000	51060.040.005	M5X25	200	51060.050.025	M6X60	100	51060.060.060
M4X6	200	51060.040.006	M5X30	200	51060.050.030	M6X65	100	51060.060.065
M4X8	200	51060.040.008	M5X35	200	51060.050.035	M6X70	100	51060.060.070
M4X10	200	51060.040.010	M5X40	200	51060.050.040	M6X75*	100	51060.060.075
M4X12	200	51060.040.012	M5X45	200	51060.050.045	M6X80	100	51060.060.080
M4X14	200	51060.040.014	M5X50	100	51060.050.050	M6X90	100	51060.060.090
M4X16	200	51060.040.016	M5X55	200	51060.050.055	M6X100	100	51060.060.100
M4X18	200	51060.040.018	M5X60	100	51060.050.060	M6X110*	100	51060.060.110
M4X20	200	51060.040.020	M5X65*	100	51060.050.065	M6X120*	100	51060.060.120
M4X22*	500	51060.040.022	M5X70	100	51060.050.070	M6X130*	100	51060.060.130

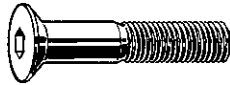
51060 Śruby z łbem stożkowym płaskim z gniazdem sześciokątnym								
d x L	☒	Kod artykułu	d x L	☒	Kod artykułu	d x L	☒	Kod artykułu
M6X140*	100	51060.060.140	M10X70	50	51060.100.070	M16X60	25	51060.160.060
M6X150*	100	51060.060.150	M10X75*	50	51060.100.075	M16X65*	25	51060.160.065
M8X10	200	51060.080.010	M10X80	50	51060.100.080	M16X70	25	51060.160.070
M8X12	200	51060.080.012	M10X90	50	51060.100.090	M16X75*	25	51060.160.075
M8X14*	200	51060.080.014	M10X100	50	51060.100.100	M16X80	25	51060.160.080
M8X16	200	51060.080.016	M10X110*	50	51060.100.110	M16X90	25	51060.160.090
M8X18	200	51060.080.018	M10X120	50	51060.100.120	M16X100	10	51060.160.100
M8X20	200	51060.080.020	M10X130*	50	51060.100.130	M16X110	10	51060.160.110
M8X22*	200	51060.080.022	M10X140*	50	51060.100.140	M16X120	10	51060.160.120
M8X25	100	51060.080.025	M10X150*	50	51060.100.150	M16X130	10	51060.160.130
M8X30	100	51060.080.030	M10X160*	50	51060.100.160	M16X140*	25	51060.160.140
M8X35	100	51060.080.035	M10X170*	25	51060.100.170	M16X150*	25	51060.160.150
M8X40	100	51060.080.040	M10X180*	25	51060.100.180	M20X30*	25	51060.200.030
M8X45	100	51060.080.045	M10X190*	25	51060.100.190	M20X35*	25	51060.200.035
M8X50	100	51060.080.050	M10X200*	25	51060.100.200	M20X40	25	51060.200.040
M8X55	100	51060.080.055	M12X16	50	51060.120.016	M20X45*	25	51060.200.045
M8X60	100	51060.080.060	M12X18*	50	51060.120.018	M20X50	10	51060.200.050
M8X65	100	51060.080.065	M12X20	50	51060.120.020	M20X55	10	51060.200.055
M8X70	50	51060.080.070	M12X25	50	51060.120.025	M20X60	5	51060.200.060
M8X75*	100	51060.080.075	M12X30	50	51060.120.030	M20X65*	25	51060.200.065
M8X80	50	51060.080.080	M12X35	50	51060.120.035	M20X70	10	51060.200.070
M8X90	50	51060.080.090	M12X40	50	51060.120.040	M20X75*	25	51060.200.075
M8X100	50	51060.080.100	M12X45	50	51060.120.045	M20X80	10	51060.200.080
M8X110	50	51060.080.110	M12X50	50	51060.120.050	M20X90	10	51060.200.090
M8X120	50	51060.080.120	M12X55	50	51060.120.055	M20X100	10	51060.200.100
M8X130*	50	51060.080.130	M12X60	50	51060.120.060	M20X110*	25	51060.200.110
M8X140*	50	51060.080.140	M12X65*	50	51060.120.065	M20X120*	25	51060.200.120
M8X150*	50	51060.080.150	M12X70	25	51060.120.070	M20X130*	25	51060.200.130
M8X160*	50	51060.080.160	M12X75*	25	51060.120.075	M20X140*	25	51060.200.140
M8X170*	25	51060.080.170	M12X80	25	51060.120.080	M20X150*	25	51060.200.150
M8X180*	25	51060.080.180	M12X90	25	51060.120.090	M24X40*	10	51060.240.040
M8X190*	25	51060.080.190	M12X100	25	51060.120.100	M24X45*	10	51060.240.045
M8X200*	25	51060.080.200	M12X110*	25	51060.120.110	M24X50	10	51060.240.050
M10X12*	100	51060.100.012	M12X120*	25	51060.120.120	M24X55*	10	51060.240.055
M10X14*	100	51060.100.014	M12X130*	25	51060.120.130	M24X60	10	51060.240.060
M10X16	100	51060.100.016	M12X140*	25	51060.120.140	M24X65*	10	51060.240.065
M10X18	100	51060.100.018	M12X150*	25	51060.120.150	M24X70	10	51060.240.070
M10X20	100	51060.100.020	M12X160*	25	51060.120.160	M24X75*	10	51060.240.075
M10X22*	100	51060.100.022	M12X170*	25	51060.120.170	M24X80	10	51060.240.080
M10X25	100	51060.100.025	M12X180*	25	51060.120.180	M24X90	10	51060.240.090
M10X30	100	51060.100.030	M12X200*	25	51060.120.200	M24X100	10	51060.240.100
M10X35	100	51060.100.035	M16X25	25	51060.160.025	M24X110	10	51060.240.110
M10X40	100	51060.100.040	M16X30	25	51060.160.030	M24X120	10	51060.240.120
M10X45	100	51060.100.045	M16X35	25	51060.160.035	M24X130	10	51060.240.130
M10X50	100	51060.100.050	M16X40	25	51060.160.040	M24X140	10	51060.240.140
M10X55	100	51060.100.055	M16X45	25	51060.160.045	M24X150	10	51060.240.150
M10X60	50	51060.100.060	M16X50	25	51060.160.050			
M10X65*	50	51060.100.065	M16X55*	25	51060.160.055			

55060 Śruby z łbem stożkowym płaskim z gniazdem sześciokątnym		Q45A
Gwint	Metryczny	
Materiał	Stal nierdzewna A4	
		
		

d x L	☒	Kod artykułu	d x L	☒	Kod artykułu	d x L	☒	Kod artykułu
M3X4*	1000	55060.030.004	M4X8	200	55060.040.008	M5X12	200	55060.050.012
M3X5*	1000	55060.030.005	M4X10	200	55060.040.010	M5X14	200	55060.050.014
M3X6	200	55060.030.006	M4X12	200	55060.040.012	M5X16	200	55060.050.016
M3X8	200	55060.030.008	M4X14	200	55060.040.014	M5X18	200	55060.050.018
M3X10	200	55060.030.010	M4X16	200	55060.040.016	M5X20	200	55060.050.020
M3X12	200	55060.030.012	M4X18	200	55060.040.018	M5X22*	500	55060.050.022
M3X14	200	55060.030.014	M4X20	200	55060.040.020	M5X25	200	55060.050.025
M3X16	200	55060.030.016	M4X22*	500	55060.040.022	M5X30	200	55060.050.030
M3X18	200	55060.030.018	M4X25	200	55060.040.025	M5X35	200	55060.050.035
M3X20	200	55060.030.020	M4X30	200	55060.040.030	M5X40	200	55060.050.040
M3X22*	1000	55060.030.022	M4X35	200	55060.040.035	M5X45	200	55060.050.045
M3X25	200	55060.030.025	M4X40	200	55060.040.040	M5X50	200	55060.050.050
M3X30*	1000	55060.030.030	M4X45*	200	55060.040.045	M5X55*	200	55060.050.055
M3X35*	500	55060.030.035	M4X50	200	55060.040.050	M5X60	100	55060.050.060
M3X40*	500	55060.030.040	M4X55*	200	55060.040.055	M5X65*	100	55060.050.065
M3X45*	500	55060.030.045	M4X60*	100	55060.040.060	M5X70*	100	55060.050.070
M3X50*	200	55060.030.050	M5X6*	500	55060.050.006	M5X75*	100	55060.050.075
M4X5*	1000	55060.040.005	M5X8	200	55060.050.008	M5X80*	100	55060.050.080
M4X6	200	55060.040.006	M5X10	200	55060.050.010	M6X8	200	55060.060.008

55060 Śruby z łbem stożkowym płaskim z gniazdem sześciokątnym ←								
d x L	☒	Kod artykułu	d x L	☒	Kod artykułu	d x L	☒	Kod artykułu
M6X10	200	55060.060.010				M12X190*	25	55060.120.190
M6X12	200	55060.060.012	M10X12*	100	55060.100.012	M12X200	10	55060.120.200
M6X14	200	55060.060.014	M10X14*	100	55060.100.014			
M6X16	200	55060.060.016	M10X16	100	55060.100.016	M16X25	25	55060.160.025
M6X18	200	55060.060.018	M10X18	100	55060.100.018	M16X30	25	55060.160.030
M6X20	200	55060.060.020	M10X20	100	55060.100.020	M16X35	25	55060.160.035
M6X22*	200	55060.060.022	M10X22*	100	55060.100.022	M16X40	25	55060.160.040
M6X25	200	55060.060.025	M10X25	100	55060.100.025	M16X45	25	55060.160.045
M6X30	200	55060.060.030	M10X30	100	55060.100.030	M16X50	25	55060.160.050
M6X35	200	55060.060.035	M10X35	100	55060.100.035	M16X55*	25	55060.160.055
M6X40	200	55060.060.040	M10X40	100	55060.100.040	M16X60	25	55060.160.060
M6X45	100	55060.060.045	M10X45	100	55060.100.045	M16X65*	25	55060.160.065
M6X50	100	55060.060.050	M10X50	100	55060.100.050	M16X70	25	55060.160.070
M6X55	100	55060.060.055	M10X55	100	55060.100.055	M16X75*	25	55060.160.075
M6X60	100	55060.060.060	M10X60	50	55060.100.060	M16X80	25	55060.160.080
M6X65*	100	55060.060.065	M10X65*	50	55060.100.065	M16X90	25	55060.160.090
M6X70	100	55060.060.070	M10X70	50	55060.100.070	M16X100	10	55060.160.100
M6X75*	100	55060.060.075	M10X75*	50	55060.100.075	M16X110*	25	55060.160.110
M6X80	100	55060.060.080	M10X80	50	55060.100.080	M16X120*	25	55060.160.120
M6X90*	100	55060.060.090	M10X90	50	55060.100.090	M16X130*	25	55060.160.130
M6X100*	100	55060.060.100	M10X100	50	55060.100.100	M16X140*	25	55060.160.140
M6X110*	100	55060.060.110	M10X110*	50	55060.100.110	M16X150*	25	55060.160.150
M6X120*	100	55060.060.120	M10X120	50	55060.100.120			
M6X130*	100	55060.060.130	M10X130*	50	55060.100.130	M20X30*	25	55060.200.030
M6X140*	100	55060.060.140	M10X140*	50	55060.100.140	M20X35*	25	55060.200.035
M6X150*	100	55060.060.150	M10X150*	50	55060.100.150	M20X40	10	55060.200.040
			M10X160*	50	55060.100.160	M20X45	10	55060.200.045
M8X10	200	55060.080.010	M10X170*	25	55060.100.170	M20X50	10	55060.200.050
M8X12	200	55060.080.012	M10X180*	25	55060.100.180	M20X55	10	55060.200.055
M8X14*	200	55060.080.014	M10X190*	25	55060.100.190	M20X60	10	55060.200.060
M8X16	200	55060.080.016	M10X200*	25	55060.100.200	M20X65*	25	55060.200.065
M8X18	200	55060.080.018				M20X70	10	55060.200.070
M8X20	200	55060.080.020	M12X16*	50	55060.120.016	M20X75*	25	55060.200.075
M8X22*	200	55060.080.022	M12X20	50	55060.120.020	M20X80*	25	55060.200.080
M8X25	100	55060.080.025	M12X22*	50	55060.120.022	M20X90	10	55060.200.090
M8X30	100	55060.080.030	M12X25	50	55060.120.025	M20X100	10	55060.200.100
M8X35	100	55060.080.035	M12X30	50	55060.120.030	M20X110*	25	55060.200.110
M8X40	100	55060.080.040	M12X35	50	55060.120.035	M20X120*	25	55060.200.120
M8X45	100	55060.080.045	M12X40	50	55060.120.040	M20X130*	25	55060.200.130
M8X50	100	55060.080.050	M12X45	50	55060.120.045	M20X140*	25	55060.200.140
M8X55	100	55060.080.055	M12X50	50	55060.120.050	M20X150*	25	55060.200.150
M8X60	100	55060.080.060	M12X55	50	55060.120.055			
M8X65*	100	55060.080.065	M12X60	50	55060.120.060	M24X40*	10	55060.240.040
M8X70	50	55060.080.070	M12X65*	50	55060.120.065	M24X45*	10	55060.240.045
M8X75*	100	55060.080.075	M12X70	25	55060.120.070	M24X50*	10	55060.240.050
M8X80	50	55060.080.080	M12X75*	25	55060.120.075	M24X55*	10	55060.240.055
M8X90	50	55060.080.090	M12X80	25	55060.120.080	M24X60*	10	55060.240.060
M8X100	50	55060.080.100	M12X90	25	55060.120.090	M24X65*	10	55060.240.065
M8X110*	50	55060.080.110	M12X100	25	55060.120.100	M24X70*	10	55060.240.070
M8X120*	50	55060.080.120	M12X110*	25	55060.120.110	M24X75*	10	55060.240.075
M8X130*	50	55060.080.130	M12X120	25	55060.120.120	M24X80*	10	55060.240.080
M8X140*	50	55060.080.140	M12X130*	25	55060.120.130	M24X90*	10	55060.240.090
M8X150*	50	55060.080.150	M12X140*	25	55060.120.140	M24X100*	10	55060.240.100
M8X160*	50	55060.080.160	M12X150*	25	55060.120.150	M24X110*	10	55060.240.110
M8X170*	25	55060.080.170	M12X160*	25	55060.120.160	M24X120*	10	55060.240.120
M8X180*	25	55060.080.180	M12X170*	25	55060.120.170	M24X130*	10	55060.240.130
M8X200*	25	55060.080.200	M12X180*	25	55060.120.180	M24X150*	10	55060.240.150

45008 Śruby z łbem stożkowym płaskim z gniazdem sześciokątnym					W010
Gwint	Metryczny	ISO	≈10642		
Materiał	Aluminium P40	DIN	≈7991		
		NEN	≈2359		
		BS	≈4168-8		

d x L	☒	Kod artykułu	d x L	☒	Kod artykułu	d x L	☒	Kod artykułu
M3X8	200	45008.030.008	M3X16	200	45008.030.016	M4X10	200	45008.040.010
M3X12	200	45008.030.012				M4X16	200	45008.040.016

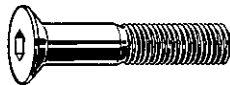
45208 Śruby z łbem stożkowym płaskim z gniazdem sześciokątnym				W010
Gwint	Metryczny	ISO	≈10642	
Materiał	Aluminium P60	DIN	≈7991	
		NEN	≈2359	
		BS	≈4168-8	

d x L	☒	Kod artykułu	d x L	☒	Kod artykułu	d x L	☒	Kod artykułu
M5X20	200	45208.050.020	M6X10	200	45208.060.010	M8X20	200	45208.080.020
			M6X25	200	45208.060.025			

Śruby z łbem stożkowym płaskim z gniazdem sześciokarbowym

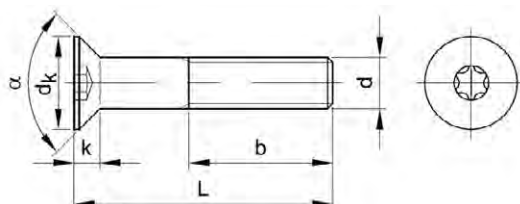

ISO ≈10642
DIN ≈7991
NF ≈E25-107

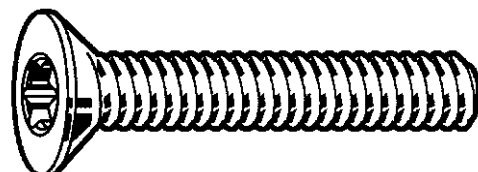

Informacje techniczne

d	b (min.)	dk	k (maks.)	Nasadka	P	α
M4	14	8	2.3	T20	0.7	90°
M5	16	10	2.8	T25	0.8	90°
M6	18	12	3.3	T30	1	90°
M8	22	16	4.4	T40	1.25	90°

- W związku z niestandardową geometrią łba elementy złączne mają ograniczoną obciążalność.
- W przypadku znakowania śrub o ograniczonej obciążalności, symbol standardowego oznaczenia poprzedza cyfra "0", tak więc 8.8→08.8 ; 10.9→010.9 oraz 12.9→012.9
- Dla elementów złącznych ze stali nierdzewnej oznaczenie następuje poprzez oznaczenie cechy danej klasy na przykład: 70 (A2-70 → A2).
- Tymczasowo mogą pojawić się stare i nowe formy znakowania na śrubach.

Grupy katalogowe

Gwint	Gniazdo	Materiał	Klasa	Obróbka powierzchni	Kod	Strona
M	Sześciokarbowy	St	08.8	Ocynk.	07450	2-44
M	Sześciokarbowy	St.St. A2			51047	2-44
M	Sześciokarbowy	St.St. A4			55047	2-45

07450 Śruby z łbem stożkowym płaskim z gniazdem sześciokarbowym				D02A
Gwint	Metryczny	Materiał	Stal	
Klasa	08.8	Obróbka powierzchni	Ocynkowane	



d x L	☒	Kod artykułu	d x L	☒	Kod artykułu	d x L	☒	Kod artykułu
M4X10	200	07450.040.010	M5X30	200	07450.050.030	M6X40	200	07450.060.040
M4X12	200	07450.040.012	M5X35	100	07450.050.035	M8X16	200	07450.080.016
M4X16	200	07450.040.016	M5X40	100	07450.050.040	M8X20	200	07450.080.020
M4X20	200	07450.040.020				M8X25	200	07450.080.025
M4X25	200	07450.040.025	M6X10	200	07450.060.010	M8X30	200	07450.080.030
			M6X12	200	07450.060.012	M8X35	100	07450.080.035
M5X10	200	07450.050.010	M6X16	200	07450.060.016	M8X40	100	07450.080.040
M5X12	200	07450.050.012	M6X20	200	07450.060.020	M8X45	100	07450.080.045
M5X16	200	07450.050.016	M6X25	200	07450.060.025	M8X50	100	07450.080.050
M5X20	200	07450.050.020	M6X30	200	07450.060.030			
M5X25	200	07450.050.025	M6X35	200	07450.060.035			

51047 Śruby z łbem stożkowym płaskim z gniazdem sześciokarbowym				Q05A
Gwint	Metryczny	Materiał	Stal nierdzewna A2	



d x L	☒	Kod artykułu	d x L	☒	Kod artykułu	d x L	☒	Kod artykułu
M4X10*	500	51047.040.010	M5X12	500	51047.050.012	M6X14*	200	51047.060.014
M4X12	500	51047.040.012	M5X16*	500	51047.050.016	M6X16*	200	51047.060.016
M4X16*	500	51047.040.016	M5X20	500	51047.050.020	M6X20*	200	51047.060.020
M4X20*	500	51047.040.020	M5X25*	500	51047.050.025	M6X25*	200	51047.060.025
M5X10*	500	51047.050.010	M6X12	200	51047.060.012	M6X30*	200	51047.060.030

55047 Śruby z łbem stożkowym płaskim z gniazdem sześciokarbowym Q45A

Gwint Metryczny
 Materiał Stal nierdzewna A4

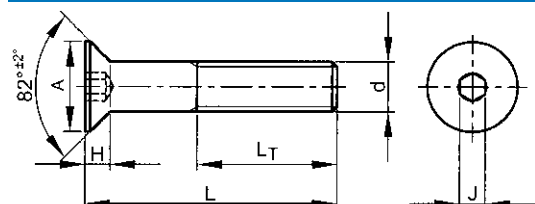

d x L	☒	Kod artykułu	d x L	☒	Kod artykułu	d x L	☒	Kod artykułu
M4X10*	500	55047.040.010	M5X12*	500	55047.050.012	M6X16*	200	55047.060.016
M4X12*	500	55047.040.012	M5X16*	500	55047.050.016	M6X20*	200	55047.060.020
M4X16*	500	55047.040.016	M5X20*	500	55047.050.020	M6X25*	200	55047.060.025
M4X20*	500	55047.040.020	M5X25*	500	55047.050.025	M6X30*	200	55047.060.030
M5X10*	500	55047.050.010	M6X12*	200	55047.060.012			

Śruby z łbem stożkowym płaskim z gniazdem sześciokątnym UNC

ASME ≈B18.3
 BS ≈2470

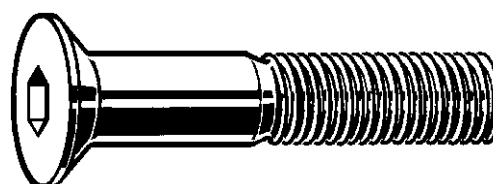
Informacje techniczne

d	A	H	J	L _T (min.)	Zwoje gwintu na cal
No.2	0.197	0.064	0.050	0.62	56
No.3	0.226	0.073	1/16	0.62	48
No.4	0.255	0.083	1/16	0.75	40
No.5	0.281	0.09	5/64	0.75	40
No.6	0.307	0.097	5/64	0.75	32
No.8	0.359	0.112	3/32	0.88	32
No.10	0.411	0.127	1/8	0.88	24
1/4	0.531	0.161	5/32	1	20
5/16	0.656	0.198	3/16	1.12	18
3/8	0.781	0.234	7/32	1.25	16
7/16	0.844	0.234	1/4	1.38	14
1/2	0.938	0.251	5/16	1.5	13
5/8	1.188	0.324	3/8	1.75	11
3/4	1.438	0.396	1/2	2	10
7/8	1.688	0.468	9/16	2.25	9
1 Inch	1.938	0.54	5/8	2.5	8
1.1/4	2.438	0.683	7/8	3.12	7

- W związku z niestandardową geometrią łba elementy złączne mają ograniczoną nośność.
- UWAGA: ponieważ norma produktu wyznacza tolerancję gwintu 3A dla rozmiarów gwintu do 1 cala, cynkowanie może spowodować problemy z pasowaniem gwintu.

Grupy katalogowe

Gwint	Gniazdo	Materiał	Klasa	Obróbka powierzchni	Kod	Strona
UNC	Gniazdo sześciokątne	St	Grade 5		U07410	2-46
UNC	Gniazdo sześciokątne	St	Grade 5	Ocynk.	U07415	2-47
UNC	Gniazdo sześciokątne	St.St. A2 (AISI304/18-8)	F837		U51060	2-47

Gwint Calowy, zunifikowany grubozwojny (UNC)
Materiał Stal
Klasa Grade 5

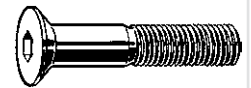
2

d x L	☒	Kod artykułu	d x L	☒	Kod artykułu	d x L	☒	Kod artykułu
NO.2-56X1/8 ft*	100	U07410.008.0012	NO.10-24X5/16 ft*	100	U07410.019.0031	7/16-14X1 Inch ft*	25	U07410.043.0100
NO.2-56X3/16 ft*	100	U07410.008.0018	NO.10-24X3/8 ft*	100	U07410.019.0037	7/16-14X1.1/4 ft*	25	U07410.043.0125
NO.2-56X1/4 ft*	100	U07410.008.0025	NO.10-24X7/16 ft*	100	U07410.019.0043	7/16-14X1.1/2*	25	U07410.043.0150
NO.2-56X5/16 ft*	100	U07410.008.0031	NO.10-24X1/2 ft*	100	U07410.019.0050	7/16-14X1.3/4*	10	U07410.043.0175
NO.2-56X3/8 ft*	100	U07410.008.0037	NO.10-24X5/8 ft*	100	U07410.019.0062	7/16-14X2 Inch*	10	U07410.043.0200
NO.2-56X1/2 ft*	100	U07410.008.0050	NO.10-24X3/4 ft*	100	U07410.019.0075	7/16-14X2.1/4*	10	U07410.043.0225
NO.2-56X5/8 ft*	100	U07410.008.0062	NO.10-24X7/8 ft*	100	U07410.019.0087	7/16-14X2.1/2*	10	U07410.043.0250
NO.2-56X3/4*	100	U07410.008.0075	NO.10-24X1 Inch*	100	U07410.019.0100	7/16-14X3 Inch*	10	U07410.043.0300
NO.2-56X7/8*	100	U07410.008.0087	NO.10-24X1.1/4*	100	U07410.019.0125	7/16-14X3.1/2*	5	U07410.043.0350
NO.2-56X1 Inch*	100	U07410.008.0100	NO.10-24X1.1/2*	100	U07410.019.0150	7/16-14X4 Inch*	5	U07410.043.0400
			NO.10-24X1.3/4*	100	U07410.019.0175			
NO.3-48X3/16 ft*	100	U07410.009.0018	NO.10-24X2 Inch*	100	U07410.019.0200	1/2-13X3/4 ft*	10	U07410.050.0075
NO.3-48X1/4 ft*	100	U07410.009.0025	NO.10-24X2.1/4*	100	U07410.019.0225	1/2-13X7/8 ft*	10	U07410.050.0087
NO.3-48X5/16 ft*	100	U07410.009.0031	NO.10-24X2.1/2*	100	U07410.019.0250	1/2-13X1 Inch ft*	10	U07410.050.0100
NO.3-48X3/8 ft*	100	U07410.009.0037	NO.10-24X3 Inch*	100	U07410.019.0300	1/2-13X1.1/4 ft*	10	U07410.050.0125
NO.3-48X1/2 ft*	100	U07410.009.0050				1/2-13X1.3/8 ft*	10	U07410.050.0137
NO.3-48X5/8 ft*	100	U07410.009.0062	1/4-20X3/8 ft*	100	U07410.025.0037	1/2-13X1.1/2 ft*	10	U07410.050.0150
NO.3-48X3/4*	100	U07410.009.0075	1/4-20X1/2 ft*	100	U07410.025.0050	1/2-13X1.3/4*	10	U07410.050.0175
NO.3-48X1 Inch*	100	U07410.009.0100	1/4-20X5/8 ft*	100	U07410.025.0062	1/2-13X2 Inch*	10	U07410.050.0200
			1/4-20X3/4 ft*	100	U07410.025.0075	1/2-13X2.1/4*	10	U07410.050.0225
NO.4-40X3/16 ft*	100	U07410.011.0018	1/4-20X7/8 ft*	100	U07410.025.0087	1/2-13X2.1/2*	10	U07410.050.0250
NO.4-40X1/4 ft*	100	U07410.011.0025	1/4-20X1 Inch ft*	100	U07410.025.0100	1/2-13X2.3/4*	10	U07410.050.0275
NO.4-40X5/16 ft*	100	U07410.011.0031	1/4-20X1.1/8*	100	U07410.025.0112	1/2-13X3 Inch*	5	U07410.050.0300
NO.4-40X3/8 ft*	100	U07410.011.0037	1/4-20X1.1/4*	100	U07410.025.0125	1/2-13X3.1/4*	5	U07410.050.0325
NO.4-40X7/16 ft*	100	U07410.011.0043	1/4-20X1.1/2*	100	U07410.025.0150	1/2-13X3.1/2*	5	U07410.050.0350
NO.4-40X1/2 ft*	100	U07410.011.0050	1/4-20X1.3/4*	100	U07410.025.0175	1/2-13X4 Inch*	5	U07410.050.0400
NO.4-40X5/8 ft*	100	U07410.011.0062	1/4-20X2 Inch*	50	U07410.025.0200	1/2-13X4.1/2*	5	U07410.050.0450
NO.4-40X3/4 ft*	100	U07410.011.0075	1/4-20X2.1/4*	50	U07410.025.0225	1/2-13X5 Inch*	5	U07410.050.0500
NO.4-40X7/8*	100	U07410.011.0087	1/4-20X2.1/2*	50	U07410.025.0250	1/2-13X5.1/2*	5	U07410.050.0550
NO.4-40X1 Inch*	100	U07410.011.0100	1/4-20X2.3/4*	50	U07410.025.0275	1/2-13X6 Inch*	5	U07410.050.0600
NO.4-40X1.1/4*	100	U07410.011.0125	1/4-20X3 Inch*	25	U07410.025.0300	1/2-13X7 Inch*	5	U07410.050.0700
			1/4-20X3.1/2*	25	U07410.025.0350	1/2-13X8 Inch*	5	U07410.050.0800
			1/4-20X4 Inch*	25	U07410.025.0400			
NO.5-40X1/4 ft*	100	U07410.012.0025				5/8-11X1 Inch ft*	10	U07410.062.0100
NO.5-40X3/8 ft*	100	U07410.012.0037	5/16-18X3/8 ft*	100	U07410.031.0037	5/8-11X1.1/4 ft*	10	U07410.062.0125
NO.5-40X1/2 ft*	100	U07410.012.0050	5/16-18X1/2 ft*	100	U07410.031.0050	5/8-11X1.1/2 ft*	10	U07410.062.0150
NO.5-40X5/8 ft*	100	U07410.012.0062	5/16-18X5/8 ft*	100	U07410.031.0062	5/8-11X1.3/4 ft*	10	U07410.062.0175
NO.5-40X3/4 ft*	100	U07410.012.0075	5/16-18X3/4 ft*	100	U07410.031.0075	5/8-11X2 Inch*	5	U07410.062.0200
NO.5-40X1 Inch*	100	U07410.012.0100	5/16-18X7/8 ft*	100	U07410.031.0087	5/8-11X2.1/4*	5	U07410.062.0225
NO.5-40X1.1/4*	100	U07410.012.0125	5/16-18X1 Inch ft*	50	U07410.031.0100	5/8-11X2.1/2*	5	U07410.062.0250
NO.5-40X1.1/2*	100	U07410.012.0150	5/16-18X1.1/8 ft*	50	U07410.031.0112	5/8-11X2.3/4*	5	U07410.062.0275
			5/16-18X1.1/4*	50	U07410.031.0125	5/8-11X3 Inch*	5	U07410.062.0300
NO.6-32X3/16 ft*	100	U07410.013.0018	5/16-18X1.1/2*	50	U07410.031.0150	5/8-11X3.1/2*	5	U07410.062.0350
NO.6-32X1/4 ft*	100	U07410.013.0025	5/16-18X1.3/4*	50	U07410.031.0175	5/8-11X4 Inch*	5	U07410.062.0400
NO.6-32X5/16 ft*	100	U07410.013.0031	5/16-18X2 Inch*	50	U07410.031.0200	5/8-11X4.1/2*	5	U07410.062.0450
NO.6-32X3/8 ft*	100	U07410.013.0037	5/16-18X2.1/4*	25	U07410.031.0225	5/8-11X5 Inch*	5	U07410.062.0500
NO.6-32X7/16 ft*	100	U07410.013.0043	5/16-18X2.1/2*	25	U07410.031.0250	5/8-11X5.1/2*	5	U07410.062.0550
NO.6-32X1/2 ft*	100	U07410.013.0050	5/16-18X2.3/4*	25	U07410.031.0275	5/8-11X6 Inch*	5	U07410.062.0600
NO.6-32X5/8 ft*	100	U07410.013.0062	5/16-18X3 Inch*	25	U07410.031.0300	5/8-11X6.1/2*	5	U07410.062.0650
NO.6-32X3/4 ft*	100	U07410.013.0075	5/16-18X3.1/2*	25	U07410.031.0350	5/8-11X7 Inch*	5	U07410.062.0700
NO.6-32X7/8*	100	U07410.013.0087	5/16-18X4 Inch*	10	U07410.031.0400	5/8-11X8 Inch*	5	U07410.062.0800
NO.6-32X1 Inch*	100	U07410.013.0100						
NO.6-32X1.1/4*	100	U07410.013.0125	3/8-16X1/2 ft*	50	U07410.037.0050	3/4-10X1 Inch ft*	5	U07410.075.0100
NO.6-32X1.1/2*	100	U07410.013.0150	3/8-16X5/8 ft*	50	U07410.037.0062	3/4-10X1.1/4 ft*	5	U07410.075.0125
NO.6-32X1.3/4*	100	U07410.013.0175	3/8-16X3/4 ft*	50	U07410.037.0075	3/4-10X1.1/2 ft*	5	U07410.075.0150
NO.6-32X2 Inch*	100	U07410.013.0200	3/8-16X7/8 ft*	50	U07410.037.0087	3/4-10X1.3/4 ft*	5	U07410.075.0175
NO.6-32X2.1/4*	100	U07410.013.0225	3/8-16X1 Inch ft*	50	U07410.037.0100	3/4-10X2 Inch ft*	5	U07410.075.0200
NO.6-32X2.1/2*	100	U07410.013.0250	3/8-16X1.1/4 ft*	50	U07410.037.0125	3/4-10X2.1/4*	5	U07410.075.0225
			3/8-16X1.3/8*	50	U07410.037.0137	3/4-10X2.1/2*	5	U07410.075.0250
NO.8-32X1/4 ft*	100	U07410.016.0025	3/8-16X1.1/2*	25	U07410.037.0150	3/4-10X2.3/4*	5	U07410.075.0275
NO.8-32X5/16 ft*	100	U07410.016.0031	3/8-16X1.3/4*	25	U07410.037.0175	3/4-10X3 Inch*	5	U07410.075.0300
NO.8-32X3/8 ft*	100	U07410.016.0037	3/8-16X2 Inch*	25	U07410.037.0200	3/4-10X3.1/4*	5	U07410.075.0325
NO.8-32X7/16 ft*	100	U07410.016.0043	3/8-16X2.1/4*	25	U07410.037.0225	3/4-10X3.1/2*	5	U07410.075.0350
NO.8-32X1/2 ft*	100	U07410.016.0050	3/8-16X2.1/2*	25	U07410.037.0250	3/4-10X4 Inch*	5	U07410.075.0400
NO.8-32X5/8 ft*	100	U07410.016.0062	3/8-16X2.3/4*	25	U07410.037.0275	3/4-10X4.1/2*	5	U07410.075.0450
NO.8-32X3/4 ft*	100	U07410.016.0075	3/8-16X3 Inch*	10	U07410.037.0300	3/4-10X5 Inch*	5	U07410.075.0500
NO.8-32X7/8 ft*	100	U07410.016.0087	3/8-16X3.1/2*	10	U07410.037.0350	3/4-10X6 Inch*	5	U07410.075.0600
NO.8-32X1 Inch*	100	U07410.016.0100	3/8-16X4 Inch*	10	U07410.037.0400	3/4-10X6.1/2*	1	U07410.075.0650
NO.8-32X1.1/4*	100	U07410.016.0125	3/8-16X4.1/2*	10	U07410.037.0450	3/4-10X7 Inch*	1	U07410.075.0700
NO.8-32X1.1/2*	100	U07410.016.0150	3/8-16X5 Inch*	10	U07410.037.0500	3/4-10X8 Inch*	1	U07410.075.0800
NO.8-32X1.3/4*	100	U07410.016.0175	3/8-16X5.1/2*	10	U07410.037.0550			
NO.8-32X2 Inch*	100	U07410.016.0200	3/8-16X6 Inch*	10	U07410.037.0600	7/8-9X2 Inch ft*	5	U07410.087.0200
NO.8-32X2.1/4*	100	U07410.016.0225				7/8-9X2.1/2*	5	U07410.087.0250
NO.8-32X2.1/2*	100	U07410.016.0250	7/16-14X3/4 ft*	25	U07410.043.0075	7/8-9X3 Inch*	5	U07410.087.0300
			7/16-14X7/8 ft*	25	U07410.043.0087	7/8-9X3.1/2*	5	U07410.087.0350

U07410 Śruby z łbem stożkowym płaskim z gniazdem sześciokątnym UNC

d x L	☒	Kod artykułu	d x L	☒	Kod artykułu	d x L	☒	Kod artykułu
7/8-9X4 Inch*	5	U07410.087.0400	1.-8X2.1/2 ft*	5	U07410.100.0250	1.-8X8 Inch*	1	U07410.100.0800
7/8-9X4.1/2*	5	U07410.087.0450	1.-8X2.3/4*	5	U07410.100.0275			
7/8-9X5 Inch*	5	U07410.087.0500	1.-8X3 Inch*	5	U07410.100.0300	1.1/4-7X3 Inch ft*	1	U07410.125.0300
7/8-9X6 Inch*	1	U07410.087.0600	1.-8X3.1/2*	5	U07410.100.0350	1.1/4-7X3.1/2*	1	U07410.125.0350
7/8-9X6.1/2*	1	U07410.087.0650	1.-8X4 Inch*	5	U07410.100.0400	1.1/4-7X4 Inch*	1	U07410.125.0400
7/8-9X7 Inch*	1	U07410.087.0700	1.-8X4.1/2*	5	U07410.100.0450	1.1/4-7X5 Inch*	1	U07410.125.0500
7/8-9X8 Inch*	1	U07410.087.0800	1.-8X5 Inch*	5	U07410.100.0500	1.1/4-7X6 Inch*	1	U07410.125.0600
			1.-8X6 Inch*	1	U07410.100.0600	1.1/4-7X7 Inch*	1	U07410.125.0700
1.-8X2 Inch ft*	5	U07410.100.0200	1.-8X6.1/2*	1	U07410.100.0650	1.1/4-7X8 Inch*	1	U07410.125.0800
1.-8X2.1/4 ft*	5	U07410.100.0225	1.-8X7 Inch*	1	U07410.100.0700			

* ft = z pełnym gwintem

U07415 Śruby z łbem stożkowym płaskim z gniazdem sześciokątnym UNC

X05A

Gwint	Całowy, zunifikowany grubozwojny (UNC)
Materiał	Stal
Klasa	Grade 5
Obróbka powierzchni	Ocynkowane





d x L	☒	Kod artykułu	d x L	☒	Kod artykułu	d x L	☒	Kod artykułu
NO.4-40X1/4 ft*	100	U07415.011.0025	NO.10-24X5/8 ft*	100	U07415.019.0062	5/16-18X1.1/2*	50	U07415.031.0150
NO.4-40X3/8 ft*	100	U07415.011.0037	NO.10-24X3/4 ft*	100	U07415.019.0075	5/16-18X1.3/4*	50	U07415.031.0175
NO.4-40X1/2 ft*	100	U07415.011.0050	NO.10-24X1 Inch*	100	U07415.019.0100	5/16-18X2 Inch*	50	U07415.031.0200
NO.4-40X5/8 ft*	100	U07415.011.0062	NO.10-24X1.1/4*	100	U07415.019.0125	5/16-18X2.1/2*	25	U07415.031.0250
NO.4-40X3/4 ft*	100	U07415.011.0075	NO.10-24X1.1/2*	100	U07415.019.0150			
NO.4-40X1 Inch*	100	U07415.011.0100				3/8-16X1/2 ft*	50	U07415.037.0050
			1/4-20X3/8 ft*	100	U07415.025.0037	3/8-16X3/4 ft*	50	U07415.037.0075
NO.6-32X1/4 ft*	100	U07415.013.0025	1/4-20X1/2 ft*	100	U07415.025.0050	3/8-16X1 Inch ft*	50	U07415.037.0100
NO.6-32X3/8 ft*	100	U07415.013.0037	1/4-20X5/8 ft*	100	U07415.025.0062	3/8-16X1.1/4 ft*	50	U07415.037.0125
NO.6-32X1/2 ft*	100	U07415.013.0050	1/4-20X3/4 ft*	100	U07415.025.0075	3/8-16X1.1/2*	25	U07415.037.0150
NO.6-32X5/8 ft*	100	U07415.013.0062	1/4-20X1 Inch ft*	100	U07415.025.0100	3/8-16X1.3/4*	25	U07415.037.0175
NO.6-32X3/4 ft*	100	U07415.013.0075	1/4-20X1.1/4*	100	U07415.025.0125	3/8-16X2 Inch*	25	U07415.037.0200
			1/4-20X1.1/2*	100	U07415.025.0150			
NO.8-32X3/8 ft*	100	U07415.016.0037	1/4-20X1.3/4*	100	U07415.025.0175	1/2-13X3/4 ft*	10	U07415.050.0075
NO.8-32X1/2 ft*	100	U07415.016.0050	1/4-20X2 Inch*	50	U07415.025.0200	1/2-13X1 Inch ft*	10	U07415.050.0100
NO.8-32X5/8 ft*	100	U07415.016.0062				1/2-13X1.1/4 ft*	10	U07415.050.0125
NO.8-32X3/4 ft*	100	U07415.016.0075	5/16-18X1/2 ft*	100	U07415.031.0050	1/2-13X1.1/2 ft*	10	U07415.050.0150
NO.8-32X1 Inch*	100	U07415.016.0100	5/16-18X5/8 ft*	100	U07415.031.0062	1/2-13X1.3/4*	10	U07415.050.0175
			5/16-18X3/4 ft*	100	U07415.031.0075	1/2-13X2 Inch*	10	U07415.050.0200
NO.10-24X3/8 ft*	100	U07415.019.0037	5/16-18X1 Inch ft*	50	U07415.031.0100	1/2-13X2.1/2*	10	U07415.050.0250
NO.10-24X1/2 ft*	100	U07415.019.0050	5/16-18X1.1/4*	50	U07415.031.0125	1/2-13X3 Inch*	5	U07415.050.0300

* ft = z pełnym gwintem

U51060 Śruby z łbem stożkowym płaskim z gniazdem sześciokątnym UNC

X15A

Gwint	Całowy, zunifikowany grubozwojny (UNC)
Materiał	Stal nierdzewna A2 (AISI 304/18-8)
Klasa	F837





d x L	☒	Kod artykułu	d x L	☒	Kod artykułu	d x L	☒	Kod artykułu
NO.2-56X1/8 ft*	100	U51060.008.0012	NO.4-40X1/2 ft*	100	U51060.011.0050	NO.8-32X1/4 ft*	100	U51060.016.0025
NO.2-56X3/16 ft*	100	U51060.008.0018	NO.4-40X5/8 ft*	100	U51060.011.0062	NO.8-32X5/16 ft*	100	U51060.016.0031
NO.2-56X1/4 ft*	100	U51060.008.0025	NO.4-40X3/4 ft*	100	U51060.011.0075	NO.8-32X3/8 ft*	100	U51060.016.0037
NO.2-56X5/16 ft*	100	U51060.008.0031	NO.4-40X1 Inch*	100	U51060.011.0100	NO.8-32X7/16 ft*	100	U51060.016.0043
NO.2-56X3/8 ft*	100	U51060.008.0037				NO.8-32X1/2 ft*	100	U51060.016.0050
NO.2-56X1/2 ft*	100	U51060.008.0050	NO.5-40X1/4 ft*	100	U51060.012.0025	NO.8-32X1/2 ft*	100	U51060.016.0050
NO.2-56X5/8 ft*	100	U51060.008.0062	NO.5-40X5/16 ft*	100	U51060.012.0031	NO.8-32X5/8 ft*	100	U51060.016.0062
NO.2-56X3/4 ft*	100	U51060.008.0075	NO.5-40X3/8 ft*	100	U51060.012.0037	NO.8-32X3/4 ft*	100	U51060.016.0075
NO.2-56X7/8 ft*	100	U51060.008.0087	NO.5-40X1/2 ft*	100	U51060.012.0050	NO.8-32X7/8 ft*	100	U51060.016.0087
NO.2-56X1 Inch*	100	U51060.008.0100	NO.5-40X5/8 ft*	100	U51060.012.0062	NO.8-32X1 Inch*	100	U51060.016.0100
			NO.5-40X3/4 ft*	100	U51060.012.0075	NO.8-32X1.1/4*	100	U51060.016.0125
NO.3-48X3/16 ft*	100	U51060.009.0018	NO.5-40X1 Inch*	100	U51060.012.0100	NO.8-32X1.1/2*	100	U51060.016.0150
NO.3-48X1/4 ft*	100	U51060.009.0025				NO.8-32X1.3/4*	100	U51060.016.0175
NO.3-48X5/16 ft*	100	U51060.009.0031	NO.6-32X1/4 ft*	100	U51060.013.0025			
NO.3-48X3/8 ft*	100	U51060.009.0037	NO.6-32X5/16 ft*	100	U51060.013.0031	NO.10-24X5/16 ft*	100	U51060.019.0031
NO.3-48X1/2 ft*	100	U51060.009.0050	NO.6-32X3/8 ft*	100	U51060.013.0037	NO.10-24X3/8 ft*	100	U51060.019.0037
NO.3-48X5/8 ft*	100	U51060.009.0062	NO.6-32X7/16 ft*	100	U51060.013.0043	NO.10-24X7/16 ft*	100	U51060.019.0043
NO.3-48X3/4 ft*	100	U51060.009.0075	NO.6-32X1/2 ft*	100	U51060.013.0050	NO.10-24X1/2 ft*	100	U51060.019.0050
NO.3-48X1 Inch*	100	U51060.009.0100	NO.6-32X5/8 ft*	100	U51060.013.0062	NO.10-24X5/8 ft*	100	U51060.019.0062
			NO.6-32X3/4 ft*	100	U51060.013.0075	NO.10-24X3/4 ft*	100	U51060.019.0075
NO.4-40X3/16 ft*	100	U51060.011.0018	NO.6-32X7/8 ft*	100	U51060.013.0087	NO.10-24X7/8 ft*	100	U51060.019.0087
NO.4-40X1/4 ft*	100	U51060.011.0025	NO.6-32X1 Inch*	100	U51060.013.0100	NO.10-24X1 Inch*	100	U51060.019.0100
NO.4-40X5/16 ft*	100	U51060.011.0031	NO.6-32X1.1/4*	100	U51060.013.0125	NO.10-24X1.1/4*	100	U51060.019.0125
NO.4-40X3/8 ft*	100	U51060.011.0037	NO.6-32X1.1/2*	100	U51060.013.0150	NO.10-24X1.1/2*	100	U51060.019.0150
NO.4-40X7/16 ft*	100	U51060.011.0043						

U51060 Śruby z łbem stożkowym płaskim z gniazdem sześciokątnym UNC

d x L	☒	Kod artykułu	d x L	☒	Kod artykułu	d x L	☒	Kod artykułu
NO.10-24X1.3/4*	100	U51060.019.0175	5/16-18X2.1/4*	25	U51060.031.0225	1/2-13X2.1/2*	10	U51060.050.0250
NO.10-24X2 Inch*	100	U51060.019.0200	5/16-18X2.1/2*	25	U51060.031.0250	1/2-13X3 Inch*	5	U51060.050.0300
			5/16-18X3 Inch*	25	U51060.031.0300	1/2-13X3.1/2*	5	U51060.050.0350
1/4-20X3/8 ft*	100	U51060.025.0037				1/2-13X4 Inch*	5	U51060.050.0400
1/4-20X1/2 ft*	100	U51060.025.0050	3/8-16X1/2 ft*	50	U51060.037.0050			
1/4-20X5/8 ft*	100	U51060.025.0062	3/8-16X5/8 ft*	50	U51060.037.0062	5/8-11X1 Inch ft*	10	U51060.062.0100
1/4-20X3/4 ft*	100	U51060.025.0075	3/8-16X3/4 ft*	50	U51060.037.0075	5/8-11X1.1/4 ft*	10	U51060.062.0125
1/4-20X7/8 ft*	100	U51060.025.0087	3/8-16X7/8 ft*	50	U51060.037.0087	5/8-11X1.1/2 ft*	10	U51060.062.0150
1/4-20X1 Inch ft*	100	U51060.025.0100	3/8-16X1 Inch ft*	50	U51060.037.0100	5/8-11X1.3/4 ft*	10	U51060.062.0175
1/4-20X1.1/4*	100	U51060.025.0125	3/8-16X1.1/4 ft*	50	U51060.037.0125	5/8-11X2 Inch*	5	U51060.062.0200
1/4-20X1.1/2*	100	U51060.025.0150	3/8-16X1.1/2*	25	U51060.037.0150	5/8-11X2.1/4*	5	U51060.062.0225
1/4-20X1.3/4*	100	U51060.025.0175	3/8-16X1.3/4*	25	U51060.037.0175	5/8-11X2.1/2*	5	U51060.062.0250
1/4-20X2 Inch*	50	U51060.025.0200	3/8-16X2 Inch*	25	U51060.037.0200	5/8-11X3 Inch*	5	U51060.062.0300
1/4-20X2.1/2*	50	U51060.025.0250	3/8-16X2.1/4*	25	U51060.037.0225	5/8-11X3.1/2*	5	U51060.062.0350
			3/8-16X2.1/2*	25	U51060.037.0250	5/8-11X4 Inch*	5	U51060.062.0400
			3/8-16X3 Inch*	10	U51060.037.0300			
5/16-18X3/8 ft*	100	U51060.031.0037				3/4-10X1.1/4 ft*	5	U51060.075.0125
5/16-18X1/2 ft*	100	U51060.031.0050	1/2-13X3/4 ft*	10	U51060.050.0075	3/4-10X1.1/2 ft*	5	U51060.075.0150
5/16-18X5/8 ft*	100	U51060.031.0062	1/2-13X7/8 ft*	10	U51060.050.0087	3/4-10X1.3/4 ft*	5	U51060.075.0175
5/16-18X3/4 ft*	100	U51060.031.0075	1/2-13X1 Inch ft*	10	U51060.050.0100	3/4-10X2 Inch ft*	5	U51060.075.0200
5/16-18X7/8 ft*	100	U51060.031.0087	1/2-13X1.1/4 ft*	10	U51060.050.0125	3/4-10X2.1/2*	5	U51060.075.0250
5/16-18X1 Inch ft*	50	U51060.031.0100	1/2-13X1.1/2 ft*	10	U51060.050.0150	3/4-10X3 Inch*	5	U51060.075.0300
5/16-18X1.1/4*	50	U51060.031.0125	1/2-13X1.1/2 ft*	10	U51060.050.0150	3/4-10X3.1/2*	5	U51060.075.0350
5/16-18X1.1/2*	50	U51060.031.0150	1/2-13X1.3/4*	10	U51060.050.0175	3/4-10X4 Inch*	5	U51060.075.0400
5/16-18X1.3/4*	50	U51060.031.0175	1/2-13X2 Inch*	10	U51060.050.0200			
5/16-18X2 Inch*	50	U51060.031.0200	1/2-13X2.1/4*	10	U51060.050.0225			

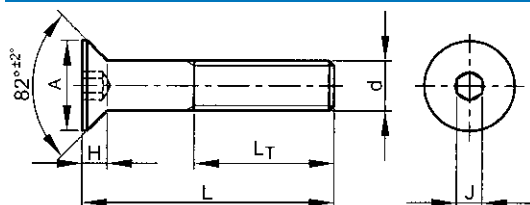
* ft = z pełnym gwintem

Śruby z łbem stożkowym płaskim z gniazdem sześciokątnym UNF

ASME ≈B18.3
BS ≈2470

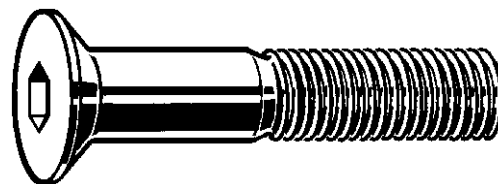
Informacje techniczne

d	A	H	J	L _T (min.)	Zwoje gwintu na cal
No.0	0.138	0.044	0.035	0.5	80
No.1	0.168	0.054	0.050	0.62	72
No.4	0.255	0.083	1/16	0.75	48
No.6	0.307	0.097	5/64	0.75	40
No.8	0.359	0.112	3/32	0.88	36
No.10	0.411	0.127	1/8	0.88	32
1/4	0.531	0.161	5/32	1	28
5/16	0.656	0.198	3/16	1.12	24
3/8	0.781	0.234	7/32	1.25	24
7/16	0.844	0.234	1/4	1.38	20
1/2	0.938	0.251	5/16	1.5	20
5/8	1.188	0.324	3/8	1.75	18
3/4	1.438	0.396	1/2	2	16

- W związku z niestandardową geometrią łba elementy złączne mają ograniczoną nośność.
- UWAGA: ponieważ norma produktu wyznacza tolerancję gwintu 3A dla rozmiarów gwintu do 1 cala, cynkowanie może spowodować problemy z pasowaniem gwintu.

Grupy katalogowe

Gwint	Gniazdo	Materiał	Klasa	Obróbka powierzchni	Kod	Strona
UNF	Gniazdo sześciokątne	St	Grade 5		U07566	2-49
UNF	Gniazdo sześciokątne	St	Grade 5	Ocyнк. mech.	07560	2-49
UNF	Gniazdo sześciokątne	St.St. A2 (AISI304/18-8)	F837		U51566	2-50

U07566	Śruby z łbem stożkowym płaskim z gniazdem sześciokątnym UNF		X05A
Gwint	Całowy, zunifikowany drobnozwojny (UNF)		
Materiał	Stal		
Klasa	Grade 5		

d x L	☒	Kod artykułu	d x L	☒	Kod artykułu	d x L	☒	Kod artykułu
NO.0-80X1/8 ft*	100	U07566.006.0012	NO.10-32X1.1/8*	100	U07566.019.0112	3/8-24X2.1/2*	25	U07566.037.0250
NO.0-80X3/16 ft*	100	U07566.006.0018	NO.10-32X1.1/4*	100	U07566.019.0125	3/8-24X2.3/4*	25	U07566.037.0275
NO.0-80X1/4 ft*	100	U07566.006.0025	NO.10-32X1.1/2*	100	U07566.019.0150	3/8-24X3 Inch*	10	U07566.037.0300
NO.0-80X5/16 ft*	100	U07566.006.0031	NO.10-32X1.3/4*	100	U07566.019.0175	3/8-24X3.1/4*	10	U07566.037.0325
NO.0-80X3/8 ft*	100	U07566.006.0037	NO.10-32X2 Inch*	100	U07566.019.0200	3/8-24X3.1/2*	10	U07566.037.0350
NO.0-80X1/2 ft*	100	U07566.006.0050	NO.10-32X2.1/4*	100	U07566.019.0225			
NO.0-80X5/8*	100	U07566.006.0062	NO.10-32X2.1/2*	100	U07566.019.0250	7/16-20X3/4 ft*	25	U07566.043.0075
NO.0-80X3/4*	100	U07566.006.0075	NO.10-32X3 Inch*	100	U07566.019.0300	7/16-20X1 Inch ft*	25	U07566.043.0100
NO.0-80X1 Inch*	100	U07566.006.0100				7/16-20X1.1/4 ft*	25	U07566.043.0125
			1/4-28X3/8 ft*	100	U07566.025.0037	7/16-20X1.1/2*	25	U07566.043.0150
			1/4-28X1/2 ft*	100	U07566.025.0050	7/16-20X1.3/4*	10	U07566.043.0175
			1/4-28X5/8 ft*	100	U07566.025.0062	7/16-20X2 Inch*	10	U07566.043.0200
			1/4-28X3/4 ft*	100	U07566.025.0075	7/16-20X2.1/2*	10	U07566.043.0250
			1/4-28X7/8 ft*	100	U07566.025.0087	7/16-20X3 Inch*	10	U07566.043.0300
			1/4-28X1 Inch ft*	100	U07566.025.0100			
			1/4-28X1.1/4*	100	U07566.025.0125	1/2-20X3/4 ft*	10	U07566.050.0075
			1/4-28X1.1/2*	100	U07566.025.0150	1/2-20X1 Inch ft*	10	U07566.050.0100
			1/4-28X1.3/4*	100	U07566.025.0175	1/2-20X1.1/4 ft*	10	U07566.050.0125
			1/4-28X2 Inch*	50	U07566.025.0200	1/2-20X1.1/2 ft*	10	U07566.050.0150
			1/4-28X2.1/4*	50	U07566.025.0225	1/2-20X1.3/4*	10	U07566.050.0175
			1/4-28X2.1/2*	50	U07566.025.0250	1/2-20X2 Inch*	10	U07566.050.0200
			1/4-28X3 Inch*	25	U07566.025.0300	1/2-20X2.1/4*	10	U07566.050.0225
			1/4-28X3.1/2*	25	U07566.025.0350	1/2-20X2.1/2*	10	U07566.050.0250
						1/2-20X3 Inch*	5	U07566.050.0300
			5/16-24X3/8 ft*	100	U07566.031.0037	1/2-20X3.1/2*	5	U07566.050.0350
			5/16-24X1/2 ft*	100	U07566.031.0050	1/2-20X4 Inch*	5	U07566.050.0400
			5/16-24X5/8 ft*	100	U07566.031.0062			
			5/16-24X3/4 ft*	100	U07566.031.0075	5/8-18X1 Inch ft*	10	U07566.062.0100
			5/16-24X7/8 ft*	100	U07566.031.0087	5/8-18X1.1/4 ft*	10	U07566.062.0125
			5/16-24X1 Inch ft*	50	U07566.031.0100	5/8-18X1.1/2 ft*	10	U07566.062.0150
			5/16-24X1.1/4*	50	U07566.031.0125	5/8-18X1.3/4 ft*	10	U07566.062.0175
			5/16-24X1.1/2*	50	U07566.031.0150	5/8-18X2 Inch*	5	U07566.062.0200
			5/16-24X1.3/4*	50	U07566.031.0175	5/8-18X2.1/4*	5	U07566.062.0225
			5/16-24X2 Inch*	50	U07566.031.0200	5/8-18X2.1/2*	5	U07566.062.0250
			5/16-24X2.1/4*	25	U07566.031.0225	5/8-18X3 Inch*	5	U07566.062.0300
			5/16-24X2.1/2*	25	U07566.031.0250	5/8-18X3.1/2*	5	U07566.062.0350
			5/16-24X3 Inch*	25	U07566.031.0300	5/8-18X4 Inch*	5	U07566.062.0400
			5/16-24X3.1/2*	25	U07566.031.0350			
						3/4-16X1.1/4 ft*	5	U07566.075.0125
			3/8-24X1/2 ft*	50	U07566.037.0050	3/4-16X1.1/2 ft*	5	U07566.075.0150
			3/8-24X5/8 ft*	50	U07566.037.0062	3/4-16X1.3/4 ft*	5	U07566.075.0175
			3/8-24X3/4 ft*	50	U07566.037.0075	3/4-16X2 Inch ft*	5	U07566.075.0200
			3/8-24X7/8 ft*	50	U07566.037.0087	3/4-16X2.1/4*	5	U07566.075.0225
			3/8-24X1 Inch ft*	50	U07566.037.0100	3/4-16X2.1/2*	5	U07566.075.0250
			3/8-24X1.1/4 ft*	50	U07566.037.0125	3/4-16X3 Inch*	5	U07566.075.0300
			3/8-24X1.1/2*	25	U07566.037.0150	3/4-16X3.1/2*	5	U07566.075.0350
			3/8-24X1.3/4*	25	U07566.037.0175	3/4-16X4 Inch*	5	U07566.075.0400
			3/8-24X2 Inch*	25	U07566.037.0200			
			3/8-24X2.1/4*	25	U07566.037.0225			

* ft = z pełnym gwintem

07560	Śruby z łbem stożkowym płaskim z gniazdem sześciokątnym UNF		X05A
Gwint	Całowy, zunifikowany drobnozwojny (UNF)		
Materiał	Stal		
Klasa	Grade 5		
Obróbka powierzchni	Ocynowane mechanicznie		

d x L	☒	Kod artykułu	d x L	☒	Kod artykułu	d x L	☒	Kod artykułu
1/4X3/4	100	07560.063.019	3/8X1 Inch	100	07560.096.025	5/8X2 Inch	25	07560.158.050
5/16X1 Inch	100	07560.079.025	1/2X1.1/4	50	07560.127.031			

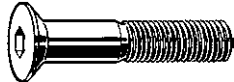
U51566	Śruby z łbem stożkowym płaskim z gniazdem sześciokątnym UNF		X15A
Gwint	Całowy, zunifikowany drobnozwojny (UNF)		
Materiał	Stal nierdzewna A2 (AISI 304/18-8)		
Klasa	F837		
			
			

d x L	☒	Kod artykułu	d x L	☒	Kod artykułu	d x L	☒	Kod artykułu
NO.0-80X1/8 ft*	100	U51566.006.0012	NO.6-40X1 Inch*	100	U51566.013.0100	NO.10-32X2.1/4*	100	U51566.019.0225
NO.0-80X3/16 ft*	100	U51566.006.0018	NO.10-32X5/16 ft*	100	U51566.019.0031	1/4-28X3/8 ft*	100	U51566.025.0037
NO.0-80X1/4 ft*	100	U51566.006.0025	NO.10-32X3/8 ft*	100	U51566.019.0037	1/4-28X1/2 ft*	100	U51566.025.0050
NO.0-80X5/16 ft*	100	U51566.006.0031	NO.10-32X7/16 ft*	100	U51566.019.0043	1/4-28X5/8 ft*	100	U51566.025.0062
NO.0-80X3/8 ft*	100	U51566.006.0037	NO.10-32X1/2 ft*	100	U51566.019.0050	1/4-28X3/4 ft*	100	U51566.025.0075
NO.0-80X1/2 ft*	100	U51566.006.0050	NO.10-32X5/8 ft*	100	U51566.019.0062	1/4-28X7/8 ft*	100	U51566.025.0087
NO.1-72X1/8 ft*	100	U51566.007.0012	NO.10-32X3/4 ft*	100	U51566.019.0075	1/4-28X1 Inch ft*	100	U51566.025.0100
NO.1-72X3/16 ft*	100	U51566.007.0018	NO.10-32X7/8 ft*	100	U51566.019.0087	1/4-28X1.1/4*	100	U51566.025.0125
NO.1-72X1/4 ft*	100	U51566.007.0025	NO.10-32X1 Inch*	100	U51566.019.0100	1/4-28X1.1/2*	100	U51566.025.0150
NO.1-72X5/16 ft*	100	U51566.007.0031	NO.10-32X1.1/4*	100	U51566.019.0125	1/4-28X1.3/4*	100	U51566.025.0175
NO.1-72X3/8 ft*	100	U51566.007.0037	NO.10-32X1.1/2*	100	U51566.019.0150	1/4-28X2 Inch*	50	U51566.025.0200
NO.1-72X1/2 ft*	100	U51566.007.0050	NO.10-32X1.3/4*	100	U51566.019.0175			
NO.6-40X3/8 ft*	100	U51566.013.0037	NO.10-32X2 Inch*	100	U51566.019.0200	5/16-24X3/8 ft*	100	U51566.031.0037

* ft = z pełnym gwintem

Śruby z łbem stożkowym płaskim z gniazdem sześciokątnym BSW

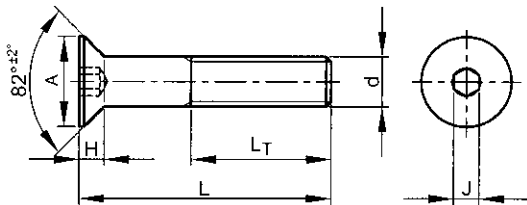

BS ≈2470

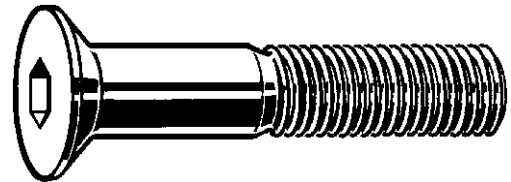

Informacje techniczne

d	A	H	J	L _T (min.)	Zwoje gwintu na cal
1/2	23.8	6.4	5/16	38	12

- Gwint Whitworth'a (BSW/BSF) nie jest zalecany do międzynarodowego stosowania. Zaleca się stosowanie gwintu metrycznego (M/MF) lub zunifikowanego (UNC/UNF).<pli:>
- W zależności od dostępności dostarczona może zostać również klasa 012.9.
- W związku z niestandardową geometrią łba elementy złączne mają ograniczoną nośność.
- W zależności od dostępności wymiary mogą się różnić.

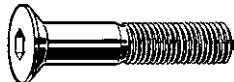
07600	Śruby z łbem stożkowym płaskim z gniazdem sześciokątnym BSW		X08A
Gwint	Całowy, Whitworth'a (BSW)		
Materiał	Stal		
Klasa	010.9		
			
			

d x L	☒	Kod artykułu	d x L	☒	Kod artykułu	d x L	☒	Kod artykułu
1/2X25MM	50	07600.127.025	1/2X30MM	50	07600.127.031	1/2X38MM	50	07600.127.038

Ostrzeżenie: cynkowanie elektrolityczne tych produktów może wywołać kruchość wodorową.

Śruby z łbem kulistym z gniazdem sześciokątnym

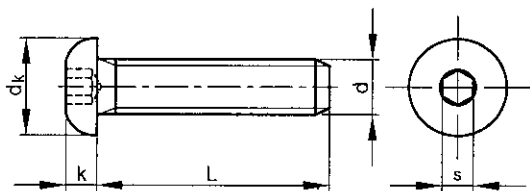

ISO 7380-1
ASME ≈B18.3.4M
NF ≈E25-126
BS ≈4168-6

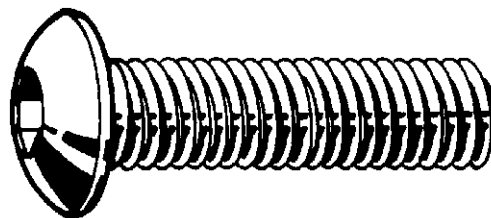

2

Informacje techniczne

d	d _k (maks.)	k (maks.)	P	Pelen gwint L ≤	s
M3	5.7	1.65	0.5	12	2
M4	7.6	2.2	0.7	16	2.5
M5	9.5	2.75	0.8	30	3
M6	10.5	3.3	1	30	4
M8	14	4.4	1.25	40	5
M10	17.5	5.5	1.5	40	6
M12	21	6.6	1.75	50	8
M16	28	8.8	2	45	10

- W związku z niestandardową geometrią łba elementy złączne mają ograniczoną obciążalność.
- W przypadku znakowania śrub o ograniczonej obciążalności, symbol standardowego oznaczenia poprzedza cyfra "0", tak więc 8.8→08.8 ; 10.9→010.9 oraz 12.9→012.9
- Dla elementów złącznych ze stali nierdzewnej oznaczenie następuje poprzez oznaczenie cechy danej klasy na przykład: 70 (A2-70 → A2).
- Tymczasowo mogą pojawić się stare i nowe formy znakowania na śrubach.

Grupy katalogowe

Gwint	Gniazdo	Materiał	Klasa	Obróbka powierzchni	Kod	Strona
M	Gniazdo sześciokątne	St	010.9		07150	2-51
M	Gniazdo sześciokątne	St	010.9	Ocynk.	07151	2-52
M	Gniazdo sześciokątne	St.St. A2	70		51030	2-52
M	Gniazdo sześciokątne	St.St. A4	70		55030	2-53

07150 Śruby z łbem kulistym z gniazdem sześciokątnym

D04A

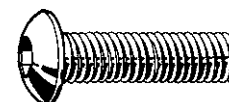

Gwint Metryczny
Materiał Stal
Klasa 010.9



d x L	☒	Kod artykułu	d x L	☒	Kod artykułu	d x L	☒	Kod artykułu
M3X6	200	07150.030.006	M5X60	200	07150.050.060	M8X55	200	07150.080.055
M3X8	200	07150.030.008	M5X70	200	07150.050.070	M8X60	200	07150.080.060
M3X10	200	07150.030.010				M8X70	200	07150.080.070
M3X12	200	07150.030.012	M6X6	200	07150.060.006	M8X80	200	07150.080.080
M3X16	200	07150.030.016	M6X8	200	07150.060.008	M8X90	100	07150.080.090
M3X20	200	07150.030.020	M6X10	200	07150.060.010	M8X100	100	07150.080.100
M3X25	200	07150.030.025	M6X12	200	07150.060.012			
M3X30	200	07150.030.030	M6X14	200	07150.060.014	M10X12	200	07150.100.012
			M6X16	200	07150.060.016	M10X16	200	07150.100.016
M4X6	200	07150.040.006	M6X20	200	07150.060.020	M10X20	200	07150.100.020
M4X8	200	07150.040.008	M6X25	200	07150.060.025	M10X25	200	07150.100.025
M4X10	200	07150.040.010	M6X30	200	07150.060.030	M10X30	200	07150.100.030
M4X12	200	07150.040.012	M6X35	200	07150.060.035	M10X35	100	07150.100.035
M4X16	200	07150.040.016	M6X40	200	07150.060.040	M10X40	100	07150.100.040
M4X20	200	07150.040.020	M6X45	200	07150.060.045	M10X45	100	07150.100.045
M4X25	200	07150.040.025	M6X50	200	07150.060.050	M10X50	100	07150.100.050
M4X30	200	07150.040.030	M6X55	200	07150.060.055	M10X55	100	07150.100.055
M4X35	200	07150.040.035	M6X60	200	07150.060.060	M10X60	100	07150.100.060
M4X40	200	07150.040.040	M6X70	200	07150.060.070	M10X70	100	07150.100.070
M4X50	200	07150.040.050				M10X80	100	07150.100.080
			M8X8	200	07150.080.008	M10X90	100	07150.100.090
M5X6	200	07150.050.006	M8X10	200	07150.080.010	M10X100	100	07150.100.100
M5X8	200	07150.050.008	M8X12	200	07150.080.012			
M5X10	200	07150.050.010	M8X14	200	07150.080.014	M12X20	100	07150.120.020
M5X12	200	07150.050.012	M8X16	200	07150.080.016	M12X25	100	07150.120.025
M5X16	200	07150.050.016	M8X18	200	07150.080.018	M12X30	100	07150.120.030
M5X20	200	07150.050.020	M8X20	200	07150.080.020	M12X35	100	07150.120.035
M5X25	200	07150.050.025	M8X25	200	07150.080.025	M12X40	100	07150.120.040
M5X30	200	07150.050.030	M8X30	200	07150.080.030	M12X45	100	07150.120.045
M5X35	200	07150.050.035	M8X35	200	07150.080.035	M12X50	100	07150.120.050
M5X40	200	07150.050.040	M8X40	200	07150.080.040	M12X55	100	07150.120.055
M5X45	200	07150.050.045	M8X45	200	07150.080.045	M12X60	100	07150.120.060
M5X50	200	07150.050.050	M8X50	200	07150.080.050	M12X70	100	07150.120.070

07150 Śruby z łbem kulistym z gniazdem sześciokątnym								
d x L	☒	Kod artykułu	d x L	☒	Kod artykułu	d x L	☒	Kod artykułu
M12X80	50	07150.120.080				M16X60	50	07150.160.060
M12X90	50	07150.120.090	M16X30	50	07150.160.030	M16X70	50	07150.160.070
M12X100	50	07150.120.100	M16X35	50	07150.160.035	M16X80	25	07150.160.080
M12X110	50	07150.120.110	M16X40	50	07150.160.040			
M12X120	50	07150.120.120	M16X45	50	07150.160.045			

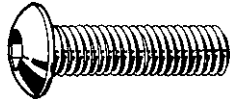
• Ostrzeżenie: cynkowanie elektrolityczne tych produktów może wywołać kruchość wodorową.

07151 Śruby z łbem kulistym z gniazdem sześciokątnym								D04A
Gwint	Metryczny							
Materiał	Stal							
Klasa	010.9							
Obróbka powierzchni	Ocynkowane							
								

d x L	☒	Kod artykułu	d x L	☒	Kod artykułu	d x L	☒	Kod artykułu
M3X5	200	07151.030.005	M5X70	200	07151.050.070	M8X100	100	07151.080.100
M3X6	200	07151.030.006						
M3X8	200	07151.030.008	M6X6	200	07151.060.006	M10X12	200	07151.100.012
M3X10	200	07151.030.010	M6X8	200	07151.060.008	M10X16	200	07151.100.016
M3X12	200	07151.030.012	M6X10	200	07151.060.010	M10X20	200	07151.100.020
M3X16	200	07151.030.016	M6X12	200	07151.060.012	M10X25	200	07151.100.025
M3X20	200	07151.030.020	M6X16	200	07151.060.016	M10X30	200	07151.100.030
M3X25	200	07151.030.025	M6X20	200	07151.060.020	M10X35	100	07151.100.035
M3X30	200	07151.030.030	M6X25	200	07151.060.025	M10X40	100	07151.100.040
			M6X30	200	07151.060.030	M10X45	100	07151.100.045
M4X6	200	07151.040.006	M6X35	200	07151.060.035	M10X50	100	07151.100.050
M4X8	200	07151.040.008	M6X40	200	07151.060.040	M10X55	100	07151.100.055
M4X10	200	07151.040.010	M6X45	200	07151.060.045	M10X60	100	07151.100.060
M4X12	200	07151.040.012	M6X50	200	07151.060.050	M10X70	100	07151.100.070
M4X16	200	07151.040.016	M6X55	200	07151.060.055	M10X80	100	07151.100.080
M4X20	200	07151.040.020	M6X60	200	07151.060.060	M10X90	100	07151.100.090
M4X25	200	07151.040.025	M6X70	200	07151.060.070	M10X100	100	07151.100.100
M4X30	200	07151.040.030						
M4X35	200	07151.040.035	M8X8	200	07151.080.008	M12X16	100	07151.120.016
M4X40	200	07151.040.040	M8X10	200	07151.080.010	M12X20	100	07151.120.020
M4X50	200	07151.040.050	M8X12	200	07151.080.012	M12X25	100	07151.120.025
			M8X14	200	07151.080.014	M12X30	100	07151.120.030
M5X6	200	07151.050.006	M8X16	200	07151.080.016	M12X35	100	07151.120.035
M5X8	200	07151.050.008	M8X20	200	07151.080.020	M12X40	100	07151.120.040
M5X10	200	07151.050.010	M8X25	200	07151.080.025	M12X45	100	07151.120.045
M5X12	200	07151.050.012	M8X30	200	07151.080.030	M12X50	100	07151.120.050
M5X16	200	07151.050.016	M8X35	200	07151.080.035	M12X55	100	07151.120.055
M5X20	200	07151.050.020	M8X40	200	07151.080.040	M12X60	100	07151.120.060
M5X25	200	07151.050.025	M8X45	200	07151.080.045	M12X70	100	07151.120.070
M5X30	200	07151.050.030	M8X50	200	07151.080.050	M12X80	50	07151.120.080
M5X35	200	07151.050.035	M8X55	200	07151.080.055	M12X90	50	07151.120.090
M5X40	200	07151.050.040	M8X60	200	07151.080.060	M12X100	50	07151.120.100
M5X45	200	07151.050.045	M8X70	200	07151.080.070	M12X110	50	07151.120.110
M5X50	200	07151.050.050	M8X80	100	07151.080.080	M12X120	50	07151.120.120
M5X60	200	07151.050.060	M8X90	100	07151.080.090			

• Ostrzeżenie: cynkowanie elektrolityczne tych produktów może wywołać kruchość wodorową.

51030 Śruby z łbem kulistym z gniazdem sześciokątnym								Q05A
Gwint	Metryczny							
Materiał	Stal nierdzewna A2							
Klasa	70							
								

d x L	☒	Kod artykułu	d x L	☒	Kod artykułu	d x L	☒	Kod artykułu
M3X3*	1000	51030.030.003	M3X35*	500	51030.030.035	M4X20	50	51030.040.020
M3X4	1000	51030.030.004	M3X40*	500	51030.030.040	M4X22*	500	51030.040.022
M3X5	50	51030.030.005	M3X45*	500	51030.030.045	M4X25	50	51030.040.025
M3X6	50	51030.030.006	M3X50*	200	51030.030.050	M4X30	50	51030.040.030
M3X8	50	51030.030.008				M4X35	50	51030.040.035
M3X10	50	51030.030.010	M4X4*	1000	51030.040.004	M4X40	200	51030.040.040
M3X12	50	51030.030.012	M4X5*	1000	51030.040.005	M4X45*	200	51030.040.045
M3X14*	1000	51030.030.014	M4X6	50	51030.040.006	M4X50*	200	51030.040.050
M3X16	50	51030.030.016	M4X8	50	51030.040.008	M4X55*	200	51030.040.055
M3X18*	1000	51030.030.018	M4X10	50	51030.040.010	M4X60*	100	51030.040.060
M3X20	50	51030.030.020	M4X12	50	51030.040.012			
M3X22*	1000	51030.030.022	M4X14*	1000	51030.040.014	M5X5*	500	51030.050.005
M3X25	50	51030.030.025	M4X16	50	51030.040.016	M5X6	50	51030.050.006
M3X30*	1000	51030.030.030	M4X18*	1000	51030.040.018	M5X8	50	51030.050.008

51030 Śruby z łbem kulistym z gniazdem sześciokątnym								
d x L	☒	Kod artykułu	d x L	☒	Kod artykułu	d x L	☒	Kod artykułu
M5X10	50	51030.050.010	M6X70	100	51030.060.070	M10X25	25	51030.100.025
M5X12	50	51030.050.012	M6X75*	100	51030.060.075	M10X30	25	51030.100.030
M5X14*	500	51030.050.014	M6X80	100	51030.060.080	M10X35	25	51030.100.035
M5X16	50	51030.050.016	M6X90*	100	51030.060.090	M10X40	25	51030.100.040
M5X18*	500	51030.050.018	M6X100*	100	51030.060.100	M10X45	10	51030.100.045
M5X20	50	51030.050.020	M6X120*	100	51030.060.120	M10X50	10	51030.100.050
M5X22*	500	51030.050.022				M10X55	10	51030.100.055
M5X25	25	51030.050.025	M8X8	25	51030.080.008	M10X60	10	51030.100.060
M5X30	25	51030.050.030	M8X10	25	51030.080.010	M10X65*	50	51030.100.065
M5X35	25	51030.050.035	M8X12	25	51030.080.012	M10X70	50	51030.100.070
M5X40	25	51030.050.040	M8X14*	200	51030.080.014	M10X75*	50	51030.100.075
M5X45	25	51030.050.045	M8X16	25	51030.080.016	M10X80	50	51030.100.080
M5X50	25	51030.050.050	M8X18*	200	51030.080.018	M10X90*	50	51030.100.090
M5X55*	200	51030.050.055	M8X20	25	51030.080.020	M10X100*	50	51030.100.100
M5X60*	100	51030.050.060	M8X22*	200	51030.080.022	M10X110*	50	51030.100.110
M5X65*	100	51030.050.065	M8X25	25	51030.080.025	M10X120*	50	51030.100.120
M5X70*	100	51030.050.070	M8X30	25	51030.080.030			
M5X75*	100	51030.050.075	M8X35	25	51030.080.035	M12X16*	50	51030.120.016
M5X80*	100	51030.050.080	M8X40	25	51030.080.040	M12X18*	50	51030.120.018
			M8X45	25	51030.080.045	M12X20	10	51030.120.020
M6X6	25	51030.060.006	M8X50	25	51030.080.050	M12X22*	50	51030.120.022
M6X8	25	51030.060.008	M8X55	25	51030.080.055	M12X25	10	51030.120.025
M6X10	25	51030.060.010	M8X60	25	51030.080.060	M12X30	10	51030.120.030
M6X12	25	51030.060.012	M8X65*	100	51030.080.065	M12X35	10	51030.120.035
M6X14	200	51030.060.014	M8X70*	100	51030.080.070	M12X40	10	51030.120.040
M6X16	25	51030.060.016	M8X75*	100	51030.080.075	M12X45	10	51030.120.045
M6X18*	200	51030.060.018	M8X80	100	51030.080.080	M12X50	10	51030.120.050
M6X20	25	51030.060.020	M8X90*	100	51030.080.090	M12X55	10	51030.120.055
M6X22*	200	51030.060.022	M8X100*	50	51030.080.100	M12X60	10	51030.120.060
M6X25	25	51030.060.025	M8X110*	50	51030.080.110	M12X65*	50	51030.120.065
M6X30	25	51030.060.030	M8X120*	50	51030.080.120	M12X70	10	51030.120.070
M6X35	25	51030.060.035				M12X75*	25	51030.120.075
M6X40	25	51030.060.040	M10X12	25	51030.100.012	M12X80*	25	51030.120.080
M6X45	25	51030.060.045	M10X14*	100	51030.100.014	M12X90*	25	51030.120.090
M6X50	25	51030.060.050	M10X16	25	51030.100.016	M12X100*	25	51030.120.100
M6X55	25	51030.060.055	M10X18*	100	51030.100.018	M12X110*	25	51030.120.110
M6X60	25	51030.060.060	M10X20	25	51030.100.020	M12X120*	25	51030.120.120
M6X65*	100	51030.060.065	M10X22*	100	51030.100.022			

55030 Śruby z łbem kulistym z gniazdem sześciokątnym			Q45A	
Gwint	Metryczny			
Material	Stal nierdzewna A4			
Klasa	70			

d x L	☒	Kod artykułu	d x L	☒	Kod artykułu	d x L	☒	Kod artykułu
M3X4*	1000	55030.030.004	M4X40*	200	55030.040.040	M6X14*	200	55030.060.014
M3X5*	1000	55030.030.005	M4X45*	200	55030.040.045	M6X16	25	55030.060.016
M3X6	50	55030.030.006	M4X50*	200	55030.040.050	M6X18*	200	55030.060.018
M3X8	50	55030.030.008	M4X55*	200	55030.040.055	M6X20	25	55030.060.020
M3X10	50	55030.030.010	M4X60*	100	55030.040.060	M6X22*	200	55030.060.022
M3X12	50	55030.030.012				M6X25	25	55030.060.025
M3X14*	1000	55030.030.014	M5X5*	500	55030.050.005	M6X30	25	55030.060.030
M3X16	50	55030.030.016	M5X6*	500	55030.050.006	M6X35	25	55030.060.035
M3X18*	1000	55030.030.018	M5X8	50	55030.050.008	M6X40	25	55030.060.040
M3X20	50	55030.030.020	M5X10	50	55030.050.010	M6X45	25	55030.060.045
M3X22*	1000	55030.030.022	M5X12	50	55030.050.012	M6X50	25	55030.060.050
M3X25	50	55030.030.025	M5X14*	500	55030.050.014	M6X55	25	55030.060.055
M3X30*	1000	55030.030.030	M5X16	50	55030.050.016	M6X60	25	55030.060.060
M3X35*	500	55030.030.035	M5X18*	500	55030.050.018	M6X65*	100	55030.060.065
M3X40*	500	55030.030.040	M5X20	50	55030.050.020	M6X70*	100	55030.060.070
M3X45*	500	55030.030.045	M5X22*	500	55030.050.022	M6X75*	100	55030.060.075
M3X50*	200	55030.030.050	M5X25	25	55030.050.025	M6X80*	100	55030.060.080
			M5X30	25	55030.050.030	M6X90*	100	55030.060.090
M4X4*	1000	55030.040.004	M5X35	25	55030.050.035	M6X100*	100	55030.060.100
M4X5*	1000	55030.040.005	M5X40	25	55030.050.040	M6X120*	100	55030.060.120
M4X6	50	55030.040.006	M5X45	25	55030.050.045			
M4X8	50	55030.040.008	M5X50	25	55030.050.050	M8X8*	500	55030.080.008
M4X10	50	55030.040.010	M5X55*	200	55030.050.055	M8X10	25	55030.080.010
M4X12	50	55030.040.012	M5X60*	100	55030.050.060	M8X12	25	55030.080.012
M4X14*	1000	55030.040.014	M5X65*	100	55030.050.065	M8X14*	200	55030.080.014
M4X16	50	55030.040.016	M5X70*	100	55030.050.070	M8X16	25	55030.080.016
M4X18*	1000	55030.040.018	M5X80*	100	55030.050.080	M8X18*	200	55030.080.018
M4X20	50	55030.040.020				M8X20	25	55030.080.020
M4X22*	500	55030.040.022	M6X6*	500	55030.060.006	M8X22*	200	55030.080.022
M4X25	50	55030.040.025	M6X8	25	55030.060.008	M8X25	25	55030.080.025
M4X30	50	55030.040.030	M6X10	25	55030.060.010	M8X30	25	55030.080.030
M4X35*	200	55030.040.035	M6X12	25	55030.060.012	M8X35	25	55030.080.035

55030 Śruby z łbem kulistym z gniazdem sześciokątnym								
d x L	☒	Kod artykułu	d x L	☒	Kod artykułu	d x L	☒	Kod artykułu
M8X40	25	55030.080.040	M10X20	25	55030.100.020			
M8X45	25	55030.080.045	M10X22*	100	55030.100.022	M12X16*	50	55030.120.016
M8X50	25	55030.080.050	M10X25	25	55030.100.025	M12X20*	50	55030.120.020
M8X55	25	55030.080.055	M10X30	25	55030.100.030	M12X25*	50	55030.120.025
M8X60	25	55030.080.060	M10X35	25	55030.100.035	M12X30*	50	55030.120.030
M8X65*	100	55030.080.065	M10X40	25	55030.100.040	M12X35*	50	55030.120.035
M8X70*	100	55030.080.070	M10X45	10	55030.100.045	M12X40*	50	55030.120.040
M8X75*	100	55030.080.075	M10X50	10	55030.100.050	M12X45*	50	55030.120.045
M8X80*	100	55030.080.080	M10X55	10	55030.100.055	M12X50*	50	55030.120.050
M8X90*	100	55030.080.090	M10X60	10	55030.100.060	M12X55*	50	55030.120.055
M8X100*	50	55030.080.100	M10X65*	50	55030.100.065	M12X60*	50	55030.120.060
M8X110*	50	55030.080.110	M10X70*	50	55030.100.070	M12X65*	50	55030.120.065
M8X120*	50	55030.080.120	M10X75*	50	55030.100.075	M12X70*	50	55030.120.070
			M10X80*	50	55030.100.080	M12X80*	25	55030.120.080
M10X12*	100	55030.100.012	M10X90*	50	55030.100.090	M12X90*	25	55030.120.090
M10X14*	100	55030.100.014	M10X100*	50	55030.100.100	M12X100*	25	55030.120.100
M10X16	25	55030.100.016	M10X110*	50	55030.100.110	M12X110*	25	55030.120.110
M10X18*	100	55030.100.018	M10X120*	50	55030.100.120	M12X120*	25	55030.120.120

Śruby z łbem kulistym z gniazdem sześciokarbowym

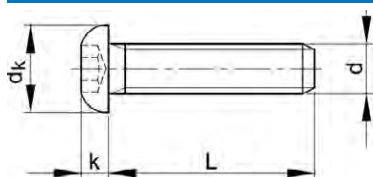

ISO ≈7380-1
 ASME ≈B18.3.4M
 NF ≈E25-126
 BS ≈4168-6

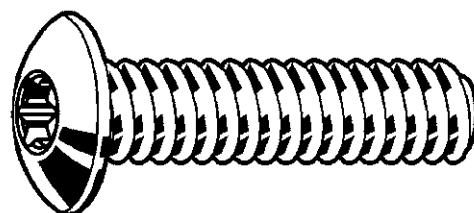

Informacje techniczne

d	d _k (maks.)	k (maks.)	Nasadka	P
M3	5.7	1.65	T10	0.5
M4	7.6	2.2	T20	0.7
M5	9.5	2.75	T25	0.8
M6	10.5	3.3	T30	1
M8	14	4.4	T40	1.25
M10	17.5	5.5	T50	1.50

- W związku z niestandardową geometrią łba elementy złączne mają ograniczoną obciążalność.
- W przypadku znakowania śrub o ograniczonej obciążalności, symbol standardowego oznaczenia poprzedza cyfra "0", tak więc 8.8→08.8 ; 10.9→010.9 oraz 12.9→012.9
- Dla elementów złącznych ze stali nierdzewnej oznaczenie następuje poprzez oznaczenie cechy danej klasy na przykład: 70 (A2-70 → A2).
- Tymczasowo mogą pojawić się stare i nowe formy znakowania na śrubach.

Grupy katalogowe

Gwint	Gniazdo	Materiał	Klasa	Obróbka powierzchni	Kod	Strona
M	Sześciokarbowy	St	010.9	O cynk.	07290	2-54
M	Sześciokarbowy	St.St. A2			51029	2-55
M	Sześciokarbowy	St.St. A4			55032	2-55

07290 Śruby z łbem kulistym z gniazdem sześciokarbowym				D04A
Gwint	Metryczny			
Materiał	Stal			
Klasa	010.9			
Obróbka powierzchni	O cynkowane			

d x L	☒	Kod artykułu	d x L	☒	Kod artykułu	d x L	☒	Kod artykułu
M4X10	200	07290.040.010	M5X20	200	07290.050.020			
M4X12	200	07290.040.012	M5X25	200	07290.050.025	M8X12	200	07290.080.012
M4X16	200	07290.040.016				M8X16	200	07290.080.016
M4X20	200	07290.040.020	M6X10	200	07290.060.010	M8X20	200	07290.080.020
			M6X12	200	07290.060.012	M8X25	200	07290.080.025
M5X10	200	07290.050.010	M6X16	200	07290.060.016	M8X30	200	07290.080.030
M5X12	200	07290.050.012	M6X20	200	07290.060.020	M8X35	200	07290.080.035
M5X16	200	07290.050.016	M6X25	200	07290.060.025	M8X40	200	07290.080.040

- Ostrzeżenie: cynkowanie elektrolityczne tych produktów może wywołać kruchość wodorową.

51029		Śruby z łbem kulistym z gniazdem sześciokąrtowym		Q45A	
Gwint	Metryczny				
Materiał	Stal nierdzewna A2				

d x L	☒	Kod artykułu	d x L	☒	Kod artykułu	d x L	☒	Kod artykułu
M3X3*	1000	51029.030.003	M5X10*	500	51029.050.010	M8X10*	200	51029.080.010
M3X4*	1000	51029.030.004	M5X12*	500	51029.050.012	M8X12*	200	51029.080.012
M3X5*	500	51029.030.005	M5X14*	500	51029.050.014	M8X14*	200	51029.080.014
M3X6*	500	51029.030.006	M5X16*	500	51029.050.016	M8X16	200	51029.080.016
M3X8*	500	51029.030.008	M5X18*	500	51029.050.018	M8X18*	200	51029.080.018
M3X10*	1000	51029.030.010	M5X20*	500	51029.050.020	M8X20*	200	51029.080.020
M3X12*	1000	51029.030.012	M5X22*	500	51029.050.022	M8X22*	200	51029.080.022
M3X14*	1000	51029.030.014	M5X25*	500	51029.050.025	M8X25*	200	51029.080.025
M3X16*	1000	51029.030.016	M5X30*	500	51029.050.030	M8X30*	200	51029.080.030
M3X18*	1000	51029.030.018	M5X35*	500	51029.050.035	M8X35*	200	51029.080.035
M3X20	1000	51029.030.020	M5X40*	500	51029.050.040	M8X40*	200	51029.080.040
M3X22*	1000	51029.030.022	M5X45*	200	51029.050.045	M8X45*	200	51029.080.045
M3X25*	1000	51029.030.025	M5X50*	200	51029.050.050	M8X50*	200	51029.080.050
M3X30*	1000	51029.030.030	M5X60*	100	51029.050.060	M8X55*	200	51029.080.055
M3X35*	500	51029.030.035	M6X6*	500	51029.060.006	M8X60*	200	51029.080.060
M3X40*	500	51029.030.040	M6X8*	500	51029.060.008	M8X70*	100	51029.080.070
M4X4*	1000	51029.040.004	M6X10*	500	51029.060.010	M8X80*	100	51029.080.080
M4X5*	1000	51029.040.005	M6X12*	500	51029.060.012	M8X88*	500	51029.080.088
M4X6	500	51029.040.006	M6X14*	500	51029.060.014	M8X100*	50	51029.080.100
M4X8	1000	51029.040.008	M6X16*	500	51029.060.016	M8X120*	50	51029.080.120
M4X10*	1000	51029.040.010	M6X18*	200	51029.060.018	M10X12*	100	51029.100.012
M4X12*	1000	51029.040.012	M6X20*	500	51029.060.020	M10X20*	100	51029.100.020
M4X16*	1000	51029.040.016	M6X22*	200	51029.060.022	M10X25*	100	51029.100.025
M4X18*	1000	51029.040.018	M6X25*	200	51029.060.025	M10X30*	100	51029.100.030
M4X20*	500	51029.040.020	M6X30*	200	51029.060.030	M10X35*	100	51029.100.035
M4X25*	500	51029.040.025	M6X35*	200	51029.060.035	M10X40*	100	51029.100.040
M4X30*	500	51029.040.030	M6X40*	200	51029.060.040	M10X45*	100	51029.100.045
M4X35*	200	51029.040.035	M6X45*	100	51029.060.045	M10X50*	50	51029.100.050
M4X40*	200	51029.040.040	M6X50*	100	51029.060.050	M10X60*	50	51029.100.060
M5X5*	500	51029.050.005	M6X55*	100	51029.060.055	M10X70*	50	51029.100.070
M5X6*	500	51029.050.006	M6X60*	100	51029.060.060	M10X80*	50	51029.100.080
M5X8	500	51029.050.008	M6X70*	100	51029.060.070	M10X100*	50	51029.100.100
			M6X80*	100	51029.060.080			

55032		Śruby z łbem kulistym z gniazdem sześciokąrtowym		Q45A	
Gwint	Metryczny				
Materiał	Stal nierdzewna A4				

d x L	☒	Kod artykułu	d x L	☒	Kod artykułu	d x L	☒	Kod artykułu
M3X4*	1000	55032.030.004	M4X8*	1000	55032.040.008	M5X8*	500	55032.050.008
M3X6*	1000	55032.030.006	M4X20*	500	55032.040.020	M6X10*	500	55032.060.010
M3X8*	1000	55032.030.008	M5X6*	500	55032.050.006	M6X30*	200	55032.060.030
M4X6*	1000	55032.040.006						

Śruby z łbem kulistym z gniazdem sześciokątnym UNC

2

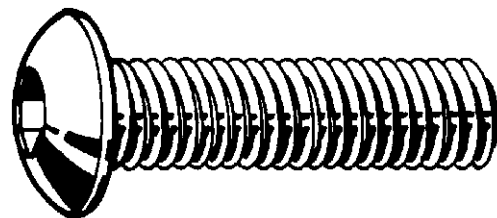
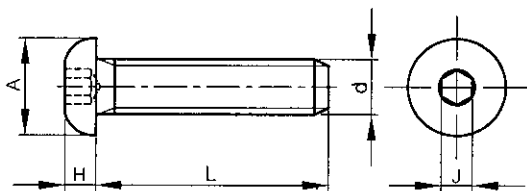

Informacje techniczne

d	A	H	J	Zwoje gwintu na cal
No.1	0.139	0.039	0.050	64
No.2	0.164	0.046	0.050	56
No.3	0.188	0.052	1/16	48
No.4	0.213	0.059	1/16	40
No.5	0.238	0.066	5/64	40
No.6	0.262	0.073	5/64	32
No.8	0.312	0.087	3/32	32
No.10	0.361	0.101	1/8	24
1/4	0.437	0.132	5/32	20
5/16	0.547	0.166	3/16	18
3/8	0.656	0.199	7/32	16
1/2	0.875	0.265	5/16	13
5/8	1.000	0.331	3/8	11

- W związku z niestandardową geometrią łba elementy złączne mają ograniczoną obciążalność.

Grupy katalogowe

Gwint	Gniazdo	Materiał	Klasa	Obróbka powierzchni	Kod	Strona
UNC	Gniazdo sześciokątne	St	Grade 5		U07150	2-56
UNC	Gniazdo sześciokątne	St	Grade 5	Ocynk.	U07151	2-57
UNC	Gniazdo sześciokątne	St.St. A2 (AISI304/18-8)	F879		U51030	2-57

U07150 Śruby z łbem kulistym z gniazdem sześciokątnym UNC

X05A

Gwint	Calowy, zunifikowany grubozwojny (UNC)
Materiał	Stal
Klasa	Grade 5



d x L	☒	Kod artykułu	d x L	☒	Kod artykułu	d x L	☒	Kod artykułu
NO.1-64X3/8*	100	U07150.007.0037	NO.4-40X7/8*	100	U07150.011.0087	NO.8-32X1.1/2*	100	U07150.016.0150
NO.1-64X1/2*	100	U07150.007.0050	NO.4-40X1 Inch*	100	U07150.011.0100	NO.8-32X2 Inch*	100	U07150.016.0200
NO.1-64X3/4*	100	U07150.007.0075						
NO.2-56X1/8*	100	U07150.008.0012	NO.5-40X1/4*	100	U07150.012.0025	NO.10-24X1/4*	100	U07150.019.0025
NO.2-56X3/16*	100	U07150.008.0018	NO.5-40X3/8*	100	U07150.012.0037	NO.10-24X3/8*	100	U07150.019.0037
NO.2-56X1/4*	100	U07150.008.0025	NO.5-40X1/2*	100	U07150.012.0050	NO.10-24X1/2*	100	U07150.019.0050
NO.2-56X5/16*	100	U07150.008.0031	NO.5-40X3/4*	100	U07150.012.0075	NO.10-24X5/8*	100	U07150.019.0062
NO.2-56X3/8*	100	U07150.008.0037	NO.5-40X1 Inch*	100	U07150.012.0100	NO.10-24X3/4*	100	U07150.019.0075
NO.2-56X1/2*	100	U07150.008.0050				NO.10-24X7/8*	100	U07150.019.0087
NO.2-56X5/8*	100	U07150.008.0062	NO.6-32X3/16*	100	U07150.013.0018	NO.10-24X1 Inch*	100	U07150.019.0100
NO.2-56X3/4*	100	U07150.008.0075	NO.6-32X1/4*	100	U07150.013.0025	NO.10-24X1.1/4*	100	U07150.019.0125
NO.2-56X1 Inch*	100	U07150.008.0100	NO.6-32X5/16*	100	U07150.013.0031	NO.10-24X1.1/2*	100	U07150.019.0150
			NO.6-32X3/8*	100	U07150.013.0037	NO.10-24X2 Inch*	100	U07150.019.0200
			NO.6-32X1/2*	100	U07150.013.0050			
NO.3-48X3/16*	100	U07150.009.0018	NO.6-32X5/8*	100	U07150.013.0062	1/4-20X3/8*	100	U07150.025.0037
NO.3-48X1/4*	100	U07150.009.0025	NO.6-32X7/8*	100	U07150.013.0075	1/4-20X1/2*	100	U07150.025.0050
NO.3-48X5/16*	100	U07150.009.0031	NO.6-32X3/4*	100	U07150.013.0087	1/4-20X5/8*	100	U07150.025.0062
NO.3-48X3/8*	100	U07150.009.0037	NO.6-32X1 Inch*	100	U07150.013.0100	1/4-20X3/4*	100	U07150.025.0075
NO.3-48X1/2*	100	U07150.009.0050	NO.6-32X1.1/4*	100	U07150.013.0125	1/4-20X1 Inch*	100	U07150.025.0100
NO.3-48X5/8*	100	U07150.009.0062	NO.6-32X1.1/2*	100	U07150.013.0150	1/4-20X1.1/2*	100	U07150.025.0150
NO.3-48X3/4*	100	U07150.009.0075	NO.6-32X2 Inch*	100	U07150.013.0200	1/4-20X2 Inch*	50	U07150.025.0200
NO.3-48X1 Inch*	100	U07150.009.0100				1/4-20X2.1/2*	50	U07150.025.0250
			NO.8-32X3/16*	100	U07150.016.0018	1/4-20X3 Inch*	25	U07150.025.0300
NO.4-40X1/8*	100	U07150.011.0012	NO.8-32X1/4*	100	U07150.016.0025	1/4-20X3.1/2*	25	U07150.025.0350
NO.4-40X3/16*	100	U07150.011.0018	NO.8-32X5/16*	100	U07150.016.0031			
NO.4-40X1/4*	100	U07150.011.0025	NO.8-32X3/8*	100	U07150.016.0037	5/16-18X3/8*	100	U07150.031.0037
NO.4-40X5/16*	100	U07150.011.0031	NO.8-32X1/2*	100	U07150.016.0050	5/16-18X1/2*	100	U07150.031.0050
NO.4-40X3/8*	100	U07150.011.0037	NO.8-32X5/8*	100	U07150.016.0062	5/16-18X5/8*	100	U07150.031.0062
NO.4-40X7/16*	100	U07150.011.0043	NO.8-32X3/4*	100	U07150.016.0075	5/16-18X3/4*	100	U07150.031.0075
NO.4-40X1/2*	100	U07150.011.0050	NO.8-32X1 Inch*	100	U07150.016.0100	5/16-18X7/8*	100	U07150.031.0087
NO.4-40X5/8*	100	U07150.011.0062	NO.8-32X1.1/4*	100	U07150.016.0125	5/16-18X1 Inch*	50	U07150.031.0100
NO.4-40X3/4*	100	U07150.011.0075						

U07150 Śruby z łbem kulistym z gniazdem sześciokątnym UNC								
d x L	☒	Kod artykułu	d x L	☒	Kod artykułu	d x L	☒	Kod artykułu
5/16-18X1.1/4*	50	U07150.031.0125	3/8-16X1.3/4*	25	U07150.037.0175	1/2-13X2 Inch*	10	U07150.050.0200
5/16-18X1.1/2*	50	U07150.031.0150	3/8-16X2 Inch*	25	U07150.037.0200	1/2-13X2.1/2*	10	U07150.050.0250
5/16-18X2 Inch*	50	U07150.031.0200	3/8-16X2.1/4*	25	U07150.037.0225	1/2-13X3 Inch*	5	U07150.050.0300
3/8-16X1/2*	50	U07150.037.0050	3/8-16X2.1/2*	25	U07150.037.0250	5/8-11X1 Inch*	10	U07150.062.0100
3/8-16X5/8*	50	U07150.037.0062	3/8-16X2.3/4*	25	U07150.037.0275	5/8-11X1.1/2*	10	U07150.062.0150
3/8-16X3/4*	50	U07150.037.0075	1/2-13X3/4*	10	U07150.050.0075	5/8-11X2 Inch*	5	U07150.062.0200
3/8-16X7/8*	50	U07150.037.0087	1/2-13X1 Inch*	10	U07150.050.0100	5/8-11X2.1/2*	5	U07150.062.0250
3/8-16X1 Inch*	50	U07150.037.0100	1/2-13X1.1/4*	10	U07150.050.0125	5/8-11X3 Inch*	5	U07150.062.0300
3/8-16X1.1/4*	50	U07150.037.0125	1/2-13X1.1/2*	10	U07150.050.0150			
3/8-16X1.1/2*	25	U07150.037.0150	1/2-13X1.3/4*	10	U07150.050.0175			

U07151 Śruby z łbem kulistym z gniazdem sześciokątnym UNC				X05A
Gwint	Całowy, zunifikowany grubozwojny (UNC)			
Material	Stal			
Klasa	Grade 5			
Obróbka powierzchni	Ocynkowane			

d x L	☒	Kod artykułu	d x L	☒	Kod artykułu	d x L	☒	Kod artykułu
NO.4-40X1/4*	100	U07151.011.0025	NO.10-24X5/8*	100	U07151.019.0062	5/16-18X1.1/2*	50	U07151.031.0150
NO.4-40X3/8*	100	U07151.011.0037	NO.10-24X3/4*	100	U07151.019.0075	3/8-16X1/2*	50	U07151.037.0050
NO.4-40X1/2*	100	U07151.011.0050	NO.10-24X7/8*	100	U07151.019.0087	3/8-16X3/4*	50	U07151.037.0075
NO.6-32X1/4*	100	U07151.013.0025	NO.10-24X1 Inch*	100	U07151.019.0100	3/8-16X1 Inch*	50	U07151.037.0100
NO.6-32X3/8*	100	U07151.013.0037	1/4-20X3/8*	100	U07151.025.0037	3/8-16X1.1/4*	50	U07151.037.0125
NO.6-32X1/2*	100	U07151.013.0050	1/4-20X1/2*	100	U07151.025.0050	3/8-16X1.1/2*	25	U07151.037.0150
NO.6-32X5/8*	100	U07151.013.0062	1/4-20X5/8*	100	U07151.025.0062	1/2-13X1 Inch*	10	U07151.050.0100
NO.8-32X1/4*	100	U07151.016.0025	1/4-20X3/4*	100	U07151.025.0075	1/2-13X1.1/4*	10	U07151.050.0125
NO.8-32X3/8*	100	U07151.016.0037	1/4-20X7/8*	100	U07151.025.0087	1/2-13X1.1/2*	10	U07151.050.0150
NO.8-32X1/2*	100	U07151.016.0050	1/4-20X1 Inch*	100	U07151.025.0100	1/2-13X2 Inch*	10	U07151.050.0200
NO.8-32X5/8*	100	U07151.016.0062	1/4-20X1.1/2*	100	U07151.025.0150	5/8-11X1 Inch*	10	U07151.062.0100
NO.8-32X3/4*	100	U07151.016.0075	5/16-18X3/8*	100	U07151.031.0037	5/8-11X1.1/2*	10	U07151.062.0150
NO.8-32X1 Inch*	100	U07151.016.0100	5/16-18X1/2*	100	U07151.031.0050	5/8-11X2 Inch*	5	U07151.062.0200
NO.10-24X3/8*	100	U07151.019.0037	5/16-18X3/4*	100	U07151.031.0075			
NO.10-24X1/2*	100	U07151.019.0050	5/16-18X1 Inch*	50	U07151.031.0100			
			5/16-18X1.1/4*	50	U07151.031.0125			

U51030 Śruby z łbem kulistym z gniazdem sześciokątnym UNC				X15A
Gwint	Całowy, zunifikowany grubozwojny (UNC)			
Material	Stal nierdzewna A2 (AISI 304/18-8)			
Klasa	F879			

d x L	☒	Kod artykułu	d x L	☒	Kod artykułu	d x L	☒	Kod artykułu
NO.1-64X3/8*	100	U51030.007.0037	NO.4-40X5/8*	100	U51030.011.0062	NO.8-32X3/8*	100	U51030.016.0037
NO.1-64X1/2*	100	U51030.007.0050	NO.4-40X3/4*	100	U51030.011.0075	NO.8-32X7/16*	100	U51030.016.0043
NO.1-64X3/4*	100	U51030.007.0075	NO.4-40X7/8*	100	U51030.011.0087	NO.8-32X1/2*	100	U51030.016.0050
NO.2-56X1/8*	100	U51030.008.0012	NO.4-40X1 Inch*	100	U51030.011.0100	NO.8-32X5/8*	100	U51030.016.0062
NO.2-56X3/16*	100	U51030.008.0018	NO.5-40X1/4*	100	U51030.012.0025	NO.8-32X3/4*	100	U51030.016.0075
NO.2-56X1/4*	100	U51030.008.0025	NO.5-40X5/16*	100	U51030.012.0031	NO.8-32X7/8*	100	U51030.016.0087
NO.2-56X5/16*	100	U51030.008.0031	NO.5-40X3/8*	100	U51030.012.0037	NO.8-32X1 Inch*	100	U51030.016.0100
NO.2-56X3/8*	100	U51030.008.0037	NO.5-40X1/2*	100	U51030.012.0050	NO.8-32X1.1/4*	100	U51030.016.0125
NO.2-56X1/2*	100	U51030.008.0050	NO.5-40X5/8*	100	U51030.012.0062	NO.8-32X1.1/2*	100	U51030.016.0150
NO.2-56X5/8*	100	U51030.008.0062	NO.5-40X3/4*	100	U51030.012.0075	NO.10-24X1/4*	100	U51030.019.0025
NO.2-56X3/4*	100	U51030.008.0075	NO.5-40X1 Inch*	100	U51030.012.0100	NO.10-24X5/16*	100	U51030.019.0031
NO.2-56X1 Inch*	100	U51030.008.0100	NO.6-32X3/16*	100	U51030.013.0018	NO.10-24X3/8*	100	U51030.019.0037
NO.3-48X3/16*	100	U51030.009.0018	NO.6-32X1/4*	100	U51030.013.0025	NO.10-24X1/2*	100	U51030.019.0050
NO.3-48X1/4*	100	U51030.009.0025	NO.6-32X5/16*	100	U51030.013.0031	NO.10-24X5/8*	100	U51030.019.0062
NO.3-48X5/16*	100	U51030.009.0031	NO.6-32X3/8*	100	U51030.013.0037	NO.10-24X3/4*	100	U51030.019.0075
NO.3-48X3/8*	100	U51030.009.0037	NO.6-32X7/16*	100	U51030.013.0043	NO.10-24X7/8*	100	U51030.019.0087
NO.3-48X1/2*	100	U51030.009.0050	NO.6-32X1/2*	100	U51030.013.0050	NO.10-24X1 Inch*	100	U51030.019.0100
NO.3-48X3/4*	100	U51030.009.0075	NO.6-32X5/8*	100	U51030.013.0062	NO.10-24X1.1/4*	100	U51030.019.0125
NO.3-48X1 Inch*	100	U51030.009.0100	NO.6-32X3/4*	100	U51030.013.0075	NO.10-24X1.1/2*	100	U51030.019.0150
NO.4-40X1/8*	100	U51030.011.0012	NO.6-32X7/8*	100	U51030.013.0087	NO.10-24X1.3/4*	100	U51030.019.0175
NO.4-40X3/16*	100	U51030.011.0018	NO.6-32X1 Inch*	100	U51030.013.0100	NO.10-24X2 Inch*	100	U51030.019.0200
NO.4-40X1/4*	100	U51030.011.0025	NO.6-32X1.1/4*	100	U51030.013.0125			
NO.4-40X5/16*	100	U51030.011.0031	NO.6-32X1.1/2*	100	U51030.013.0150			
NO.4-40X3/8*	100	U51030.011.0037	NO.8-32X3/16*	100	U51030.016.0018	1/4-20X5/16*	100	U51030.025.0031
NO.4-40X7/16*	100	U51030.011.0043	NO.8-32X1/4*	100	U51030.016.0025	1/4-20X3/8*	100	U51030.025.0037
NO.4-40X1/2*	100	U51030.011.0050	NO.8-32X5/16*	100	U51030.016.0031	1/4-20X1/2*	100	U51030.025.0050
						1/4-20X5/8*	100	U51030.025.0062
						1/4-20X3/4*	100	U51030.025.0075

U51030 Śruby z łbem kulistym z gniazdem sześciokątnym UNC								
d x L	☒	Kod artykułu	d x L	☒	Kod artykułu	d x L	☒	Kod artykułu
1/4-20X7/8*	100	U51030.025.0087	5/16-18X1 Inch*	50	U51030.031.0100	3/8-16X2 Inch*	25	U51030.037.0200
1/4-20X1 Inch*	100	U51030.025.0100	5/16-18X1.1/4*	50	U51030.031.0125	3/8-16X2.1/2*	25	U51030.037.0250
1/4-20X1.1/4*	100	U51030.025.0125	5/16-18X1.1/2*	50	U51030.031.0150	3/8-16X3 Inch*	10	U51030.037.0300
1/4-20X1.1/2*	100	U51030.025.0150	5/16-18X1.3/4*	50	U51030.031.0175			
1/4-20X1.3/4*	100	U51030.025.0175	5/16-18X2 Inch*	50	U51030.031.0200	1/2-13X1 Inch*	10	U51030.050.0100
1/4-20X2 Inch*	50	U51030.025.0200				1/2-13X1.1/4*	10	U51030.050.0125
			3/8-16X1/2*	50	U51030.037.0050	1/2-13X1.1/2*	10	U51030.050.0150
5/16-18X3/8*	100	U51030.031.0037	3/8-16X3/4*	50	U51030.037.0075	1/2-13X1.3/4*	10	U51030.050.0175
5/16-18X1/2*	100	U51030.031.0050	3/8-16X1 Inch*	50	U51030.037.0100	1/2-13X2 Inch*	10	U51030.050.0200
5/16-18X5/8*	100	U51030.031.0062	3/8-16X1.1/4*	50	U51030.037.0125	1/2-13X2.1/2*	10	U51030.050.0250
5/16-18X3/4*	100	U51030.031.0075	3/8-16X1.1/2*	25	U51030.037.0150	1/2-13X3 Inch*	5	U51030.050.0300
5/16-18X7/8*	100	U51030.031.0087	3/8-16X1.3/4*	25	U51030.037.0175			

Śruby z łbem kulistym z gniazdem sześciokątnym UNF

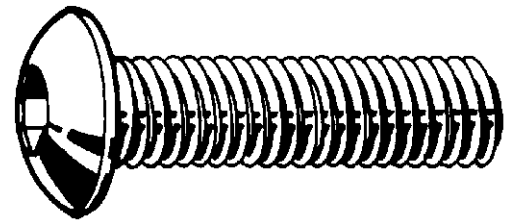
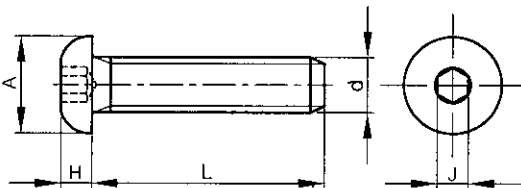

Informacje techniczne

d	A	H	J	Zwoje gwintu na cal
No.0	0.114	0.032	0.035	80
No.1	0.139	0.039	0.050	72
No.10	0.361	0.101	1/8	32
1/4	0.437	0.132	5/32	28
5/16	0.547	0.166	3/16	24
3/8	0.656	0.199	7/32	24

* W związku z niestandardową geometrią łba elementy złączne mają ograniczoną obciążalność.

Grupy katalogowe

Gwint	Gniazdo	Materiał	Klasa	Kod	Strona
UNF	Gniazdo sześciokątne	St	Grade 5	U07230	2-58
UNF	Gniazdo sześciokątne	St.St. A2 (AISI304/18-8)	F879	U51130	2-59

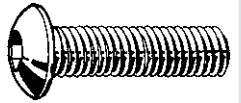
U07230 Śruby z łbem kulistym z gniazdem sześciokątnym UNF		X05A
Gwint	Calowy, zunifikowany drobnozwojny (UNF)	 
Materiał	Stal	
Klasa	Grade 5	

d x L	☒	Kod artykułu	d x L	☒	Kod artykułu	d x L	☒	Kod artykułu
NO.0-80X1/8*	100	U07230.006.0012	NO.10-32X1/4*	100	U07230.019.0025	1/4-28X5/8*	100	U07230.025.0062
NO.0-80X3/16*	100	U07230.006.0018	NO.10-32X5/16*	100	U07230.019.0031	1/4-28X3/4*	100	U07230.025.0075
NO.0-80X1/4*	100	U07230.006.0025	NO.10-32X3/8*	100	U07230.019.0037	1/4-28X1 Inch*	100	U07230.025.0100
NO.0-80X5/16*	100	U07230.006.0031	NO.10-32X1/2*	100	U07230.019.0050	1/4-28X1.1/2*	100	U07230.025.0150
NO.0-80X3/8*	100	U07230.006.0037	NO.10-32X5/8*	100	U07230.019.0062	1/4-28X2 Inch*	50	U07230.025.0200
NO.0-80X1/2*	100	U07230.006.0050	NO.10-32X3/4*	100	U07230.019.0075			
			NO.10-32X7/8*	100	U07230.019.0087	5/16-24X3/8*	100	U07230.031.0037
NO.1-72X3/16*	100	U07230.007.0018	NO.10-32X1 Inch*	100	U07230.019.0100	5/16-24X1/2*	100	U07230.031.0050
NO.1-72X1/4*	100	U07230.007.0025	NO.10-32X1.1/4*	100	U07230.019.0125	5/16-24X5/8*	100	U07230.031.0062
NO.1-72X5/16*	100	U07230.007.0031	NO.10-32X1.1/2*	100	U07230.019.0150	5/16-24X3/4*	100	U07230.031.0075
NO.1-72X3/8*	100	U07230.007.0037	NO.10-32X1.3/4*	100	U07230.019.0175	5/16-24X1 Inch*	50	U07230.031.0100
NO.1-72X1/2*	100	U07230.007.0050	NO.10-32X2 Inch*	100	U07230.019.0200			
NO.1-72X5/8*	100	U07230.007.0062				3/8-24X1/2*	50	U07230.037.0050
NO.1-72X3/4*	100	U07230.007.0075	1/4-28X3/8*	100	U07230.025.0037	3/8-24X3/4*	50	U07230.037.0075
			1/4-28X1/2*	100	U07230.025.0050	3/8-24X1 Inch*	50	U07230.037.0100

U51130	Śruby z łbem kulistym z gniazdem sześciokątnym UNF		X15A
Gwint	Calowy, zunifikowany drobnozwojny (UNF)		
Materiał	Stal nierdzewna A2 (AISI 304/18-8)		
Klasa	F879		

d x L	☒	Kod artykułu	d x L	☒	Kod artykułu	d x L	☒	Kod artykułu
NO.0-80X1/8	100	U51130.006.0012	NO.1-72X1/2*	100	U51130.007.0050	NO.10-32X1 Inch*	100	U51130.019.0100
NO.0-80X3/16*	100	U51130.006.0018	NO.1-72X5/8*	100	U51130.007.0062	NO.10-32X1.1/4*	100	U51130.019.0125
NO.0-80X1/4*	100	U51130.006.0025	NO.1-72X3/4*	100	U51130.007.0075	NO.10-32X1.1/2*	100	U51130.019.0150
NO.0-80X5/16*	100	U51130.006.0031				NO.10-32X1.3/4*	100	U51130.019.0175
NO.0-80X3/8*	100	U51130.006.0037	NO.10-32X1/4*	100	U51130.019.0025	NO.10-32X2 Inch*	100	U51130.019.0200
NO.0-80X1/2*	100	U51130.006.0050	NO.10-32X5/16*	100	U51130.019.0031			
			NO.10-32X3/8*	100	U51130.019.0037	1/4-28X2 Inch*	50	U51130.025.0200
NO.1-72X1/8*	100	U51130.007.0012	NO.10-32X7/16*	100	U51130.019.0043			
NO.1-72X3/16*	100	U51130.007.0018	NO.10-32X1/2*	100	U51130.019.0050	5/16-24X3/8*	100	U51130.031.0037
NO.1-72X1/4*	100	U51130.007.0025	NO.10-32X5/8*	100	U51130.019.0062	5/16-24X1/2*	100	U51130.031.0050
NO.1-72X5/16*	100	U51130.007.0031	NO.10-32X3/4*	100	U51130.019.0075	5/16-24X1 Inch*	50	U51130.031.0100
NO.1-72X3/8*	100	U51130.007.0037	NO.10-32X7/8*	100	U51130.019.0087	5/16-24X1.1/2*	50	U51130.031.0150

Śruby z łbem kulistym z gniazdem sześciokątnym z kołnierzem walcowym

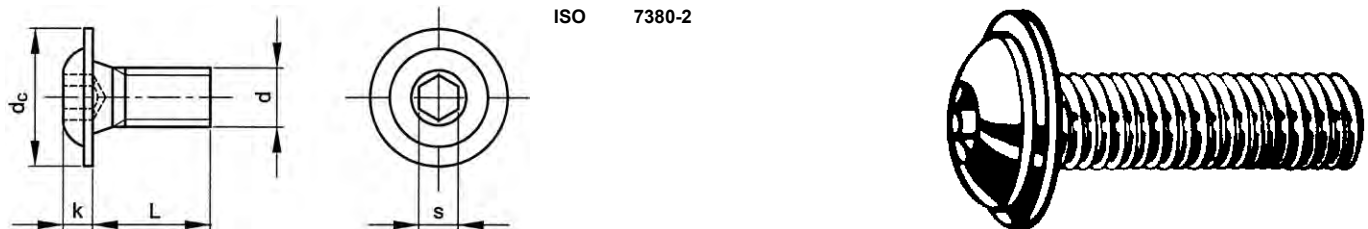

Informacje techniczne

d	d _c (maks.)	k (maks.)	P	Pelen gwint L ≤	s
M3	6.9	1.65	0.5	12	2
M4	9.4	2.2	0.7	16	2.5
M5	11.8	2.75	0.8	30	3
M6	13.6	3.3	1	30	4
M8	17.8	4.4	1.25	40	5
M10	21.9	5.5	1.5	40	6
M12	26.0	6.6	1.75	50	8

- W związku z niestandardową geometrią łba elementy złączne mają ograniczoną obciążalność.
- W przypadku znakowania śrub o ograniczonej obciążalności, symbol standardowego oznaczenia poprzedza cyfra "0", tak więc 8.8→08.8 ; 10.9→010.9 oraz 12.9→012.9
- Dla elementów złącznych ze stali nierdzewnej oznaczenie następuje poprzez oznaczenie cechy danej klasy na przykład: 70 (A2-70 → A2).
- Tymczasowo mogą pojawić się stare i nowe formy znakowania na śrubach.

Grupy katalogowe

Gwint	Gniazdo	Materiał	Klasa	Obróbka powierzchni	Kod	Strona
M	Gniazdo sześciokątne	St	010.9	Ocynk.	07141	2-59
M	Gniazdo sześciokątne	St.St. A2			51028	2-60
M	Gniazdo sześciokątne	St.St. A4			55025	2-61

07141	Śruby z łbem kulistym z gniazdem sześciokątnym z kołnierzem walcowym		D04A
Gwint	Metryczny		
Materiał	Stal		
Klasa	010.9		
Obróbka powierzchni	Ocynkowane		

d x L	☒	Kod artykułu	d x L	☒	Kod artykułu	d x L	☒	Kod artykułu
M3X6	200	07141.030.006	M4X10	200	07141.040.010	M5X10	200	07141.050.010
M3X8	200	07141.030.008	M4X12	200	07141.040.012	M5X12	200	07141.050.012
M3X10	200	07141.030.010	M4X16	200	07141.040.016	M5X16	200	07141.050.016
M3X12	200	07141.030.012	M4X20	200	07141.040.020	M5X20	200	07141.050.020
M3X16	200	07141.030.016	M4X25	200	07141.040.025	M5X25	200	07141.050.025
M3X20	200	07141.030.020	M4X30	200	07141.040.030	M5X30	200	07141.050.030
M3X25	200	07141.030.025	M4X40	200	07141.040.040	M5X40	200	07141.050.040
M3X30	200	07141.030.030	M4X45	200	07141.040.045	M5X45	200	07141.050.045
						M5X50	200	07141.050.050
M4X6	200	07141.040.006	M5X6	200	07141.050.006			
M4X8	200	07141.040.008	M5X8	200	07141.050.008	M6X8	200	07141.060.008

07141 Śruby z łbem kulistym z gniazdem sześciokątnym z kołnierzem walcowym ←

d x L	☒	Kod artykułu	d x L	☒	Kod artykułu	d x L	☒	Kod artykułu
M6X10	200	07141.060.010	M8X25	200	07141.080.025	M10X50	100	07141.100.050
M6X12	200	07141.060.012	M8X30	200	07141.080.030	M10X60	100	07141.100.060
M6X16	200	07141.060.016	M8X35	200	07141.080.035			
M6X20	200	07141.060.020	M8X40	200	07141.080.040	M12X20	100	07141.120.020
M6X25	200	07141.060.025	M8X45	200	07141.080.045	M12X25	100	07141.120.025
M6X30	200	07141.060.030	M8X50	200	07141.080.050	M12X30	100	07141.120.030
M6X35	200	07141.060.035	M8X60	200	07141.080.060	M12X35	100	07141.120.035
M6X40	200	07141.060.040				M12X40	100	07141.120.040
M6X50	200	07141.060.050	M10X16	200	07141.100.016	M12X45	100	07141.120.045
M6X60	200	07141.060.060	M10X20	200	07141.100.020	M12X50	100	07141.120.050
			M10X25	200	07141.100.025	M12X60	100	07141.120.060
M8X10	200	07141.080.010	M10X30	200	07141.100.030	M12X70	100	07141.120.070
M8X12	200	07141.080.012	M10X35	100	07141.100.035	M12X80	50	07141.120.080
M8X16	200	07141.080.016	M10X40	100	07141.100.040			
M8X20	200	07141.080.020	M10X45	100	07141.100.045			

• Ostrzeżenie: cynkowanie elektrolityczne tych produktów może wywołać kruchość wodorową.

51028 Śruby z łbem kulistym z gniazdem sześciokątnym z kołnierzem walcowym R09A

Gwint Metryczny
Materiał Stal nierdzewna A2

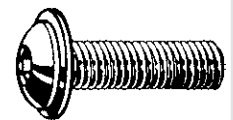

d x L	☒	Kod artykułu	d x L	☒	Kod artykułu	d x L	☒	Kod artykułu
M3X3*	1000	51028.030.003	M5X40	200	51028.050.040	M8X70*	100	51028.080.070
M3X4*	1000	51028.030.004	M5X45*	200	51028.050.045	M8X75*	100	51028.080.075
M3X5*	1000	51028.030.005	M5X50*	200	51028.050.050	M8X80*	100	51028.080.080
M3X6	50	51028.030.006	M5X55*	200	51028.050.055	M8X90*	100	51028.080.090
M3X8	50	51028.030.008	M5X60*	100	51028.050.060	M8X100*	50	51028.080.100
M3X10	50	51028.030.010	M5X65*	100	51028.050.065	M8X110*	50	51028.080.110
M3X12	50	51028.030.012	M5X70*	100	51028.050.070	M8X120*	50	51028.080.120
M3X14*	1000	51028.030.014	M5X75*	100	51028.050.075			
M3X16	50	51028.030.016	M5X80*	100	51028.050.080	M10X12*	100	51028.100.012
M3X18*	1000	51028.030.018				M10X14*	100	51028.100.014
M3X20	50	51028.030.020	M6X6*	500	51028.060.006	M10X16	25	51028.100.016
M3X22*	1000	51028.030.022	M6X8	25	51028.060.008	M10X18*	100	51028.100.018
M3X25*	1000	51028.030.025	M6X10	25	51028.060.010	M10X20	25	51028.100.020
M3X30*	1000	51028.030.030	M6X12	25	51028.060.012	M10X22*	100	51028.100.022
M3X35*	500	51028.030.035	M6X14*	200	51028.060.014	M10X25	25	51028.100.025
M3X40*	500	51028.030.040	M6X16	25	51028.060.016	M10X30	10	51028.100.030
M3X45*	500	51028.030.045	M6X18*	200	51028.060.018	M10X35	10	51028.100.035
M3X50*	200	51028.030.050	M6X20	25	51028.060.020	M10X40	10	51028.100.040
			M6X22	200	51028.060.022	M10X45*	100	51028.100.045
M4X4*	1000	51028.040.004	M6X25	25	51028.060.025	M10X50*	50	51028.100.050
M4X5*	1000	51028.040.005	M6X30	25	51028.060.030	M10X55*	50	51028.100.055
M4X6	50	51028.040.006	M6X35	25	51028.060.035	M10X60*	50	51028.100.060
M4X8	50	51028.040.008	M6X40	25	51028.060.040	M10X65*	50	51028.100.065
M4X10	50	51028.040.010	M6X45	100	51028.060.045	M10X70*	50	51028.100.070
M4X12	50	51028.040.012	M6X50	100	51028.060.050	M10X75*	50	51028.100.075
M4X14*	1000	51028.040.014	M6X55*	100	51028.060.055	M10X80*	50	51028.100.080
M4X16	50	51028.040.016	M6X60	100	51028.060.060	M10X90*	50	51028.100.090
M4X18*	1000	51028.040.018	M6X65*	100	51028.060.065	M10X100*	50	51028.100.100
M4X20	50	51028.040.020	M6X70*	100	51028.060.070	M10X110*	50	51028.100.110
M4X22*	500	51028.040.022	M6X75*	100	51028.060.075	M10X120*	50	51028.100.120
M4X25	50	51028.040.025	M6X80*	100	51028.060.080			
M4X30	50	51028.040.030	M6X90*	100	51028.060.090	M12X16*	50	51028.120.016
M4X35*	200	51028.040.035	M6X100*	100	51028.060.100	M12X18*	50	51028.120.018
M4X40*	200	51028.040.040	M6X120*	100	51028.060.120	M12X20*	50	51028.120.020
M4X45*	200	51028.040.045				M12X25*	50	51028.120.025
M4X50*	200	51028.040.050	M8X8*	500	51028.080.008	M12X30*	50	51028.120.030
M4X55*	200	51028.040.055	M8X10	25	51028.080.010	M12X35*	50	51028.120.035
M4X60*	100	51028.040.060	M8X12	25	51028.080.012	M12X40*	50	51028.120.040
			M8X14*	200	51028.080.014	M12X45*	50	51028.120.045
M5X5	500	51028.050.005	M8X16	25	51028.080.016	M12X50*	50	51028.120.050
M5X6*	500	51028.050.006	M8X18*	200	51028.080.018	M12X55*	50	51028.120.055
M5X8	50	51028.050.008	M8X20	25	51028.080.020	M12X60*	50	51028.120.060
M5X10	50	51028.050.010	M8X22*	200	51028.080.022	M12X65*	50	51028.120.065
M5X12	50	51028.050.012	M8X25	25	51028.080.025	M12X70*	50	51028.120.070
M5X14*	500	51028.050.014	M8X30	25	51028.080.030	M12X75*	25	51028.120.075
M5X16	50	51028.050.016	M8X35	25	51028.080.035	M12X80*	25	51028.120.080
M5X18*	500	51028.050.018	M8X40	25	51028.080.040	M12X90*	25	51028.120.090
M5X20	50	51028.050.020	M8X45	100	51028.080.045	M12X100*	25	51028.120.100
M5X22*	500	51028.050.022	M8X50	100	51028.080.050	M12X110*	25	51028.120.110
M5X25	25	51028.050.025	M8X55*	100	51028.080.055	M12X120*	25	51028.120.120
M5X30	25	51028.050.030	M8X60*	100	51028.080.060			
M5X35	200	51028.050.035	M8X65*	100	51028.080.065			

55025		Śruby z łbem kulistym z gniazdem sześciokątnym z kołnierzem walcowym		R49A	
Gwint	Metryczny				
Material	Stal nierdzewna A4				

d x L	✉	Kod artykułu	d x L	✉	Kod artykułu	d x L	✉	Kod artykułu
M3X3*	1000	55025.030.003	M5X12*	500	55025.050.012	M8X10*	500	55025.080.010
M3X4*	1000	55025.030.004	M5X14*	500	55025.050.014	M8X12*	500	55025.080.012
M3X5*	1000	55025.030.005	M5X16*	500	55025.050.016	M8X14*	200	55025.080.014
M3X6*	1000	55025.030.006	M5X18*	500	55025.050.018	M8X16*	200	55025.080.016
M3X8*	1000	55025.030.008	M5X20*	500	55025.050.020	M8X18*	200	55025.080.018
M3X10*	1000	55025.030.010	M5X22*	500	55025.050.022	M8X20*	200	55025.080.020
M3X12*	1000	55025.030.012	M5X25*	200	55025.050.025	M8X22*	200	55025.080.022
M3X14*	1000	55025.030.014	M5X30*	200	55025.050.030	M8X25*	100	55025.080.025
M3X16*	1000	55025.030.016	M5X35*	200	55025.050.035	M8X30*	100	55025.080.030
M3X18*	1000	55025.030.018	M5X40*	200	55025.050.040	M8X35*	100	55025.080.035
M3X20*	1000	55025.030.020	M5X45*	200	55025.050.045	M8X40*	100	55025.080.040
M3X22*	1000	55025.030.022	M5X50*	200	55025.050.050	M8X45*	100	55025.080.045
M3X25*	1000	55025.030.025	M5X60*	100	55025.050.060	M8X50*	100	55025.080.050
M3X30*	1000	55025.030.030				M8X55*	100	55025.080.055
			M6X6*	500	55025.060.006	M8X60*	100	55025.080.060
M4X4*	1000	55025.040.004	M6X8*	500	55025.060.008	M8X65*	100	55025.080.065
M4X5*	1000	55025.040.005	M6X10*	500	55025.060.010	M8X70*	100	55025.080.070
M4X6*	1000	55025.040.006	M6X12*	200	55025.060.012	M8X75*	100	55025.080.075
M4X8*	1000	55025.040.008	M6X14*	200	55025.060.014	M8X80*	100	55025.080.080
M4X10*	1000	55025.040.010	M6X16*	200	55025.060.016	M8X90*	100	55025.080.090
M4X12*	1000	55025.040.012	M6X18*	200	55025.060.018	M8X100*	50	55025.080.100
M4X14*	1000	55025.040.014	M6X20*	200	55025.060.020			
M4X16*	1000	55025.040.016	M6X22*	200	55025.060.022	M10X12*	100	55025.100.012
M4X18*	1000	55025.040.018	M6X25*	200	55025.060.025	M10X16*	100	55025.100.016
M4X20*	500	55025.040.020	M6X30*	200	55025.060.030	M10X20*	100	55025.100.020
M4X22*	500	55025.040.022	M6X35*	200	55025.060.035	M10X25*	100	55025.100.025
M4X25*	500	55025.040.025	M6X40*	200	55025.060.040	M10X30*	100	55025.100.030
M4X30*	500	55025.040.030	M6X45*	100	55025.060.045	M10X35*	100	55025.100.035
M4X35*	200	55025.040.035	M6X50*	100	55025.060.050	M10X40*	100	55025.100.040
M4X40*	200	55025.040.040	M6X55*	100	55025.060.055	M10X45*	100	55025.100.045
M4X45*	200	55025.040.045	M6X60*	100	55025.060.060	M10X50*	50	55025.100.050
M4X50*	200	55025.040.050	M6X65*	100	55025.060.065	M10X55*	50	55025.100.055
			M6X70*	100	55025.060.070	M10X60*	50	55025.100.060
M5X5*	500	55025.050.005	M6X75*	100	55025.060.075	M10X80*	50	55025.100.080
M5X6*	500	55025.050.006				M10X90*	50	55025.100.090
M5X8*	500	55025.050.008	M8X8*	500	55025.080.008	M10X100*	50	55025.100.100
M5X10*	500	55025.050.010						

Śruby z łbem kulistym z gniazdem sześciokątnym i kołnierzem walcowym

2

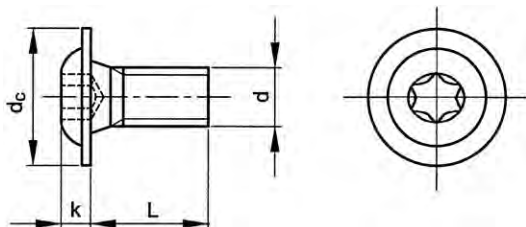

ISO ≈7380-2

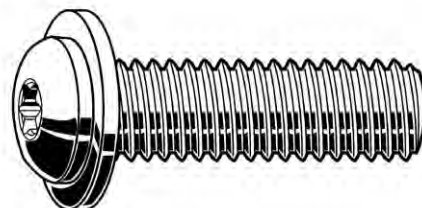

Informacje techniczne

d	d _c (maks.)	k (maks.)	Nasadka	P
M3	6.9	1.65	T10	0.5
M4	9.4	2.2	T20	0.7
M5	11.8	2.75	T25	0.8
M6	13.6	3.3	T30	1
M8	17.8	4.4	T40	1.25
M10	21.9	5.5	T50	1.50

- W związku z niestandardową geometrią łba elementy złączne mają ograniczoną obciążalność.
- Dla elementów złącznych ze stali nierdzewnej oznaczenie następuje poprzez oznaczenie cechy danej klasy na przykład: 70 (A2-70 → A2).

51041 Śruby z łbem kulistym z gniazdem sześciokątnym i kołnierzem walcowym

Q05A

Gwint Metryczny
Materiał Stal nierdzewna A2

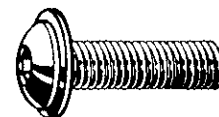

d x L	☒	Kod artykułu	d x L	☒	Kod artykułu	d x L	☒	Kod artykułu
M3X4*	1000	51041.030.004	M5X6*	500	51041.050.006	M6X40*	200	51041.060.040
M3X5*	1000	51041.030.005	M5X8*	500	51041.050.008	M6X45*	100	51041.060.045
M3X6*	1000	51041.030.006	M5X10	500	51041.050.010	M6X50*	100	51041.060.050
M3X8*	1000	51041.030.008	M5X12	500	51041.050.012	M6X55*	100	51041.060.055
M3X10*	1000	51041.030.010	M5X14*	500	51041.050.014	M6X60*	100	51041.060.060
M3X12*	1000	51041.030.012	M5X16*	500	51041.050.016			
M3X14*	1000	51041.030.014	M5X18*	500	51041.050.018	M8X8*	500	51041.080.008
M3X16*	1000	51041.030.016	M5X20*	500	51041.050.020	M8X10*	200	51041.080.010
M3X18*	1000	51041.030.018	M5X22*	500	51041.050.022	M8X12*	200	51041.080.012
M3X20*	1000	51041.030.020	M5X25*	500	51041.050.025	M8X16*	200	51041.080.016
M3X22*	1000	51041.030.022	M5X30*	200	51041.050.030	M8X20*	200	51041.080.020
M3X25*	1000	51041.030.025	M5X35*	200	51041.050.035	M8X25*	100	51041.080.025
			M5X40*	200	51041.050.040	M8X30*	100	51041.080.030
M4X4*	1000	51041.040.004	M5X45*	200	51041.050.045	M8X35*	100	51041.080.035
M4X5*	1000	51041.040.005	M5X50*	200	51041.050.050	M8X40*	100	51041.080.040
M4X6*	1000	51041.040.006	M5X60*	100	51041.050.060	M8X45*	100	51041.080.045
M4X8*	1000	51041.040.008				M8X50*	100	51041.080.050
M4X10*	1000	51041.040.010	M6X6*	500	51041.060.006	M8X55*	100	51041.080.055
M4X12*	1000	51041.040.012	M6X8*	500	51041.060.008	M8X60*	100	51041.080.060
M4X14*	1000	51041.040.014	M6X10*	500	51041.060.010	M8X70*	100	51041.080.070
M4X16*	1000	51041.040.016	M6X12*	500	51041.060.012	M8X80*	100	51041.080.080
M4X20*	500	51041.040.020	M6X14*	500	51041.060.014			
M4X22*	500	51041.040.022	M6X16*	200	51041.060.016	M10X16*	100	51041.100.016
M4X25*	500	51041.040.025	M6X18*	200	51041.060.018	M10X20*	100	51041.100.020
M4X30*	500	51041.040.030	M6X20*	200	51041.060.020	M10X25*	100	51041.100.025
M4X35*	200	51041.040.035	M6X22*	200	51041.060.022	M10X30*	100	51041.100.030
M4X40*	200	51041.040.040	M6X25*	200	51041.060.025	M10X35*	100	51041.100.035
			M6X30*	200	51041.060.030	M10X60*	50	51041.100.060
M5X5*	500	51041.050.005	M6X35*	200	51041.060.035			

Śruby samozabezpieczające z łbem walcowym z gniazdem sześciokątnym z kołnierzem stożkowym

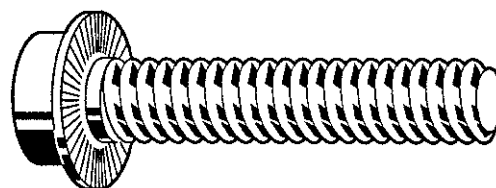
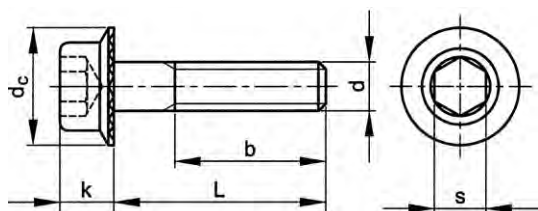

2

Informacje techniczne

d	b	d _c (maks.)	k (maks.)	P	Pełen gwint L ≤	s
M5	22	11	5	0.8	-	4
M6	24	13.5	6	1	25	5
M8	28	17	8	1.25	30	6
M10	32	19.5	10	1.5	35	8
M12	36	22.5	12	1.75	35	10

- Śruby samozabezpieczające z łbem sześciokątnym z kołnierzem stożkowym RIPP, oznaczone są klasą właściwości 100 z minimalną wytrzymałością na rozciąganie 1040 N/mm², są one nawęglane i w związku z tym nie mogą zostać umieszczone w klasie 10.9.

Specjalne właściwości śrub samozabezpieczających z łbem sześciokątnym z kołnierzem stożkowym RIPP:

- ząbkowany (wielorokowy) kołnierz zapobiega uszkodzeniom podczas montażu, zapobiega samopoluzowaniu i zmniejsza relaksację (rozluźnienie)
- kołnierz pozwala na rozproszczenie nagromadzonych sił na większym obszarze, tym samym zmniejszając nacisk na powierzchnię
- kołnierz może zakryć duże (nadwymiarowe) otwory i/lub otwory narzędziowe
- podkładka i/lub element blokujący nie jest konieczny.

MONTAŻ Z OBCIĄŻENIEM WSTĘPNYM F_m w kN, a MOMENT SKRĘCAJĄCY M_a w Nm

Klasa	Dopasowanie materiału	M5		M6		M8		M10		M12		M16	
		FM	MA	FM	MA	FM	MA	FM	MA	FM	MA	FM	MA
100	Stal (R _m < 800 N/mm ²)	9	11	12,6	19	23,2	42	37	85	54	130	102	330
	Stal (R _m ≥ 800 N/mm ²)	9	10	12,6	18	23,2	37	37	80	54	120	102	310
	Stal zgrzewna/ żeliwo ciągliwe	9	9	12,6	16	23,2	35	37	75	54	115	102	300

07095 RIPP Śruby samozabezpieczające z łbem walcowym z gniazdem sześciokątnym z kołnierzem stożkowym

D93A

Gwint: Metryczny
Materiał: Stal
Klasa: 100

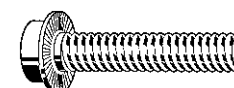

d x L	☒	Kod artykułu	d x L	☒	Kod artykułu	d x L	☒	Kod artykułu	
M5X10	500	07095.050.010	M8X12	200	07095.080.012	M10X35	100	07095.100.035	
M5X12	500	07095.050.012		200	07095.080.016	M10X40	100	07095.100.040	
M5X16	500	07095.050.016		200	07095.080.020	M12X20	100	07095.120.020	
M5X20	500	07095.050.020		200	07095.080.025		100	07095.120.025	
M6X10	500	07095.060.010		200	07095.080.030		M12X25	100	07095.120.030
	500	07095.060.012	200	07095.080.040	M12X30		100	07095.120.035	
	500	07095.060.016	M10X20	200	07095.100.020		M12X35	100	07095.120.040
	500	07095.060.020		200	07095.100.025	M12X40	100	07095.120.045	
	500	07095.060.025		200	07095.100.030	M12X45	100	07095.120.050	
500	07095.060.030	M10X25		200		M12X50	100	07095.120.050	
M6X20	500					M10X30	200		
M6X25	500								
M6X30	500								

- Ostrzeżenie: cynkowanie elektrolityczne tych produktów może wywołać kruchość wodorową.

Śruby pasowane f9 z łbem walcowym z gniazdem sześciokątnym, metryczne f9

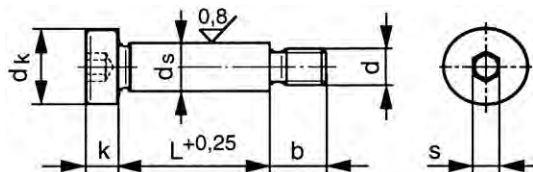

ISO ≈7379
ASME ≈B18.3.3M
BS ≈4168-7



Informacje techniczne

d	Tolerancja f9 (min.)	Tolerancja f9 (maks.)	b	d _k (maks.)	d _s (nom.)	k (maks.)	P	s
M5	5.960	5.990	9.5	10.22	6	4.5	0.8	3
M6	7.951	7.987	11	13.27	8	5.5	1	4
M8	9.951	9.987	13	16.27	10	7	1.25	5
M10	11.941	11.984	16	18.27	12	9	1.5	6
M12	15.941	15.984	18	24.33	16	11	1.75	8
M16	19.928	19.980	22	30.33	20	14	2	10
M20	23.928	23.980	27	36.39	24	16	2.5	12

- W związku z niestandardową geometrią łba elementy złączne mają ograniczoną obciążalność.
- W przypadku znakowania śrub o ograniczonej obciążalności, symbol standardowego oznaczenia poprzedza cyfra "0", tak więc 8.8→08.8 ; 10.9→010.9 oraz 12.9→012.9
- Dla elementów złącznych ze stali nierdzewnej oznaczenie następuje poprzez oznaczenie cechy danej klasy na przykład: 70 (A2-70 → A2).
- Tymczasowo mogą pojawić się stare i nowe formy znakowania na śrubach.

Przykład zastosowania

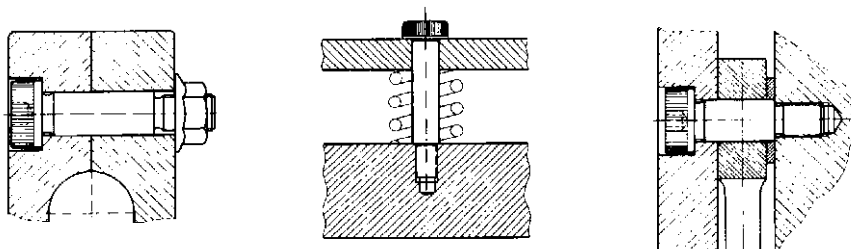

Grupy katalogowe

Gwint	Gniazdo	Materiał	Klasa	Kod	Strona
M	Gniazdo sześciokątne	St	012.9	07111	2-64
M	Gniazdo sześciokątne	St.St. A2		51044	2-65

07111 Śruby pasowane f9 z łbem walcowym z gniazdem sześciokątnym, metryczne f9		D93A
Gwint	Metryczny	
Materiał	Stal	
Klasa	012.9	



(d) d _s x L	☒	Kod artykułu	(d) d _s x L	☒	Kod artykułu	(d) d _s x L	☒	Kod artykułu
M5 6X6	50	07111.050.006	M6 8X40	50	07111.060.040	M8 10X100	25	07111.080.100
M5 6X8	50	07111.050.008	M6 8X45	50	07111.060.045	M8 10X120	25	07111.080.120
M5 6X10	50	07111.050.010	M6 8X50	50	07111.060.050			
M5 6X12	50	07111.050.012	M6 8X60	50	07111.060.060	M10 12X12	25	07111.100.012
M5 6X16	50	07111.050.016	M6 8X70	50	07111.060.070	M10 12X16	25	07111.100.016
M5 6X20	50	07111.050.020				M10 12X20	25	07111.100.020
M5 6X25	50	07111.050.025	M8 10X10	50	07111.080.010	M10 12X25	25	07111.100.025
M5 6X30	50	07111.050.030	M8 10X12	50	07111.080.012	M10 12X30	25	07111.100.030
M5 6X35	50	07111.050.035	M8 10X16	50	07111.080.016	M10 12X35	25	07111.100.035
M5 6X40	50	07111.050.040	M8 10X20	50	07111.080.020	M10 12X40	25	07111.100.040
M5 6X45	50	07111.050.045	M8 10X25	50	07111.080.025	M10 12X45	25	07111.100.045
M5 6X50	50	07111.050.050	M8 10X30	50	07111.080.030	M10 12X50	25	07111.100.050
			M8 10X35	50	07111.080.035	M10 12X55	25	07111.100.055
M6 8X8	50	07111.060.008	M8 10X40	50	07111.080.040	M10 12X60	25	07111.100.060
M6 8X10	50	07111.060.010	M8 10X45	50	07111.080.045	M10 12X70	25	07111.100.070
M6 8X12	50	07111.060.012	M8 10X50	50	07111.080.050	M10 12X80	25	07111.100.080
M6 8X16	50	07111.060.016	M8 10X55	50	07111.080.055	M10 12X90	25	07111.100.090
M6 8X20	50	07111.060.020	M8 10X60	50	07111.080.060	M10 12X100	25	07111.100.100
M6 8X25	50	07111.060.025	M8 10X70	50	07111.080.070	M10 12X120	25	07111.100.120
M6 8X30	50	07111.060.030	M8 10X80	50	07111.080.080			
M6 8X35	50	07111.060.035	M8 10X90	50	07111.080.090	M12 16X20	25	07111.120.020



07111 Śruby pasowane f9 z łbem walcowym z gniazdem sześciokątnym, metryczne f9

(d) d _s x L	☒	Kod artykułu	(d) d _s x L	☒	Kod artykułu	(d) d _s x L	☒	Kod artykułu
M12 16X25	25	07111.120.025	M12 16X120	25	07111.120.120	M16 20X100	10	07111.160.100
M12 16X30	25	07111.120.030				M16 20X120	10	07111.160.120
M12 16X35	25	07111.120.035	M16 20X30	10	07111.160.030			
M12 16X40	25	07111.120.040	M16 20X35	10	07111.160.035	M20 24X50	5	07111.200.050
M12 16X45	25	07111.120.045	M16 20X40	10	07111.160.040	M20 24X55	5	07111.200.055
M12 16X50	25	07111.120.050	M16 20X45	10	07111.160.045	M20 24X60	5	07111.200.060
M12 16X55	25	07111.120.055	M16 20X50	10	07111.160.050	M20 24X70	5	07111.200.070
M12 16X60	25	07111.120.060	M16 20X55	10	07111.160.055	M20 24X80	5	07111.200.080
M12 16X70	25	07111.120.070	M16 20X60	10	07111.160.060	M20 24X90	5	07111.200.090
M12 16X80	25	07111.120.080	M16 20X70	10	07111.160.070	M20 24X100	5	07111.200.100
M12 16X90	25	07111.120.090	M16 20X80	10	07111.160.080	M20 24X120	5	07111.200.120
M12 16X100	25	07111.120.100	M16 20X90	10	07111.160.090			

• Ostrzeżenie: cynkowanie elektrolityczne tych produktów może wywołać kruchość wodorową.

51044 Śruby pasowane f9 z łbem walcowym z gniazdem sześciokątnym, metryczne f9 Q05A

Gwint	Metryczny
Materiał	Stal nierdzewna A2

(d) d _s x L	☒	Kod artykułu	(d) d _s x L	☒	Kod artykułu	(d) d _s x L	☒	Kod artykułu
(M5)6X10	10	51044.050.010	(M8)10X20	10	51044.080.020	(M10)12X80	5	51044.100.080
(M5)6X12	10	51044.050.012	(M8)10X25	10	51044.080.025	(M10)12X100	5	51044.100.100
(M5)6X16	10	51044.050.016	(M8)10X30	10	51044.080.030			
(M5)6X20	10	51044.050.020	(M8)10X40	10	51044.080.040	(M12)16X30	5	51044.120.030
(M5)6X25	10	51044.050.025	(M8)10X50	10	51044.080.050	(M12)16X40	5	51044.120.040
(M5)6X30	10	51044.050.030	(M8)10X60	10	51044.080.060	(M12)16X50	5	51044.120.050
(M5)6X40	10	51044.050.040	(M8)10X70	10	51044.080.070	(M12)16X60	5	51044.120.060
			(M8)10X80	10	51044.080.080	(M12)16X70	5	51044.120.070
(M6)8X12	10	51044.060.012				(M12)16X80	5	51044.120.080
(M6)8X16	10	51044.060.016	(M10)12X16	5	51044.100.016	(M12)16X100	5	51044.120.100
(M6)8X20	10	51044.060.020	(M10)12X20	5	51044.100.020			
(M6)8X25	10	51044.060.025	(M10)12X25	5	51044.100.025	(M16)20X40	3	51044.160.040
(M6)8X30	10	51044.060.030	(M10)12X30	5	51044.100.030	(M16)20X50	3	51044.160.050
(M6)8X40	10	51044.060.040	(M10)12X40	5	51044.100.040	(M16)20X60	3	51044.160.060
(M6)8X50	10	51044.060.050	(M10)12X50	5	51044.100.050	(M16)20X70	3	51044.160.070
(M8)10X16	10	51044.080.016	(M10)12X60	5	51044.100.060	(M16)20X80	3	51044.160.080
			(M10)12X70	5	51044.100.070			

Śruby pasowane z łbem walcowym z gniazdem sześciokątnym UNC

2

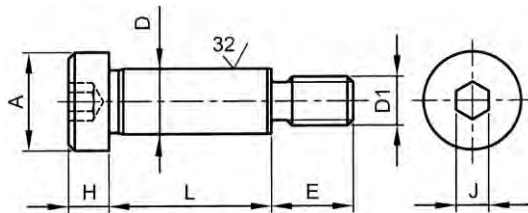

ASME B18.3
BS 2470



Informacje techniczne

D	A (maks.)	E	H (maks.)	J	Zwoje gwintu na cal
1/4	0.375	0.375	0.188	1/8	24
5/16	0.438	0.438	0.219	5/32	20
3/8	0.562	0.500	0.250	3/16	18
1/2	0.750	0.625	0.312	1/4	16
5/8	0.875	0.750	0.375	5/16	13
3/4	1.000	0.875	0.500	3/8	11
1 Inch	1.312	1.000	0.625	1/2	10

- W związku z niestandardową geometrią łba elementy złączne mają ograniczoną obciążalność.
- W przypadku znakowania śrub o ograniczonej obciążalności, symbol standardowego oznaczenia poprzedza cyfra "0", tak więc 8.8→08.8 ; 10.9→010.9 oraz 12.9→012.9
- Dla elementów złącznych ze stali nierdzewnej oznaczenie następuje poprzez oznaczenie cechy danej klasy na przykład: 70 (A2-70 → A2).
- Tymczasowo mogą pojawić się stare i nowe formy znakowania na śrubach.

Przykład zastosowania

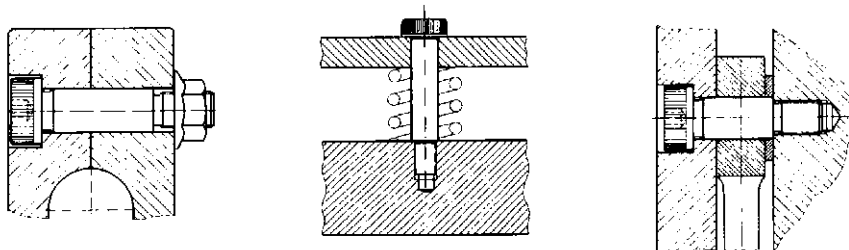

Grupy katalogowe

Gwint	Gniazdo	Materiał	Klasa	Kod	Strona
UNC	Gniazdo sześciokątne	St	Grade 5	U07111	2-66
UNC	Gniazdo sześciokątne	St	012.9	07116	2-67
UNC	Gniazdo sześciokątne	St.St. A2 (AISI304/18-8)		U51044	2-67

U07111 Śruby pasowane z łbem walcowym z gniazdem sześciokątnym UNC

X05A

Gwint Calowy, zunifikowany grubozwojny (UNC)
Materiał Stal
Klasa Grade 5



(D ₁) Dx L	☒	Kod artykułu	(D ₁) Dx L	☒	Kod artykułu	(D ₁) Dx L	☒	Kod artykułu
(10-24)1/4X1/4*	25	U07111.025.0025	(1/4-20)5/16X7/8*	10	U07111.031.0087	(5/16-18)3/8X2 Inch*	10	U07111.037.0200
(10-24)1/4X3/8*	25	U07111.025.0037	(1/4-20)5/16X1 Inch*	10	U07111.031.0100	(5/16-18)3/8X2 1/4*	5	U07111.037.0225
(10-24)1/4X1/2*	25	U07111.025.0050	(1/4-20)5/16X1.1/4*	10	U07111.031.0125	(5/16-18)3/8X2 1/2*	5	U07111.037.0250
(10-24)1/4X5/8*	25	U07111.025.0062	(1/4-20)5/16X1.1/2*	5	U07111.031.0150	(5/16-18)3/8X2 3/4*	5	U07111.037.0275
(10-24)1/4X3/4*	25	U07111.025.0075	(1/4-20)5/16X1.3/4*	5	U07111.031.0175	(5/16-18)3/8X3 Inch*	5	U07111.037.0300
(10-24)1/4X7/8*	10	U07111.025.0087	(1/4-20)5/16X2 Inch*	5	U07111.031.0200	(5/16-18)3/8X3 1/4*	5	U07111.037.0325
(10-24)1/4X1 Inch*	10	U07111.025.0100	(1/4-20)5/16X2 1/4*	5	U07111.031.0225	(5/16-18)3/8X3 1/2*	5	U07111.037.0350
(10-24)1/4X1.1/4*	10	U07111.025.0125	(1/4-20)5/16X2 1/2*	5	U07111.031.0250	(5/16-18)3/8X3 3/4*	5	U07111.037.0375
(10-24)1/4X1.1/2*	10	U07111.025.0150	(1/4-20)5/16X3 Inch*	5	U07111.031.0300	(5/16-18)3/8X4 Inch*	5	U07111.037.0400
(10-24)1/4X1.3/4*	10	U07111.025.0175				(5/16-18)3/8X4 1/2*	5	U07111.037.0450
(10-24)1/4X2 Inch*	10	U07111.025.0200	(5/16-18)3/8X1/4*	10	U07111.037.0025	(5/16-18)3/8X5 Inch*	5	U07111.037.0500
(10-24)1/4X2 1/4*	10	U07111.025.0225	(5/16-18)3/8X3/8*	10	U07111.037.0037	(5/16-18)3/8X6 Inch*	5	U07111.037.0600
(10-24)1/4X2 1/2*	10	U07111.025.0250	(5/16-18)3/8X1/2*	10	U07111.037.0050			
(10-24)1/4X3 Inch*	10	U07111.025.0300	(5/16-18)3/8X5/8*	10	U07111.037.0062	(3/8-16)1/2X3/8*	5	U07111.050.0037
			(5/16-18)3/8X3/4*	10	U07111.037.0075	(3/8-16)1/2X1/2*	5	U07111.050.0050
(1/4-20)5/16X1/4*	10	U07111.031.0025	(5/16-18)3/8X7/8*	10	U07111.037.0087	(3/8-16)1/2X5/8*	5	U07111.050.0062
(1/4-20)5/16X3/8*	10	U07111.031.0037	(5/16-18)3/8X1 Inch*	10	U07111.037.0100	(3/8-16)1/2X3/4*	5	U07111.050.0075
(1/4-20)5/16X1/2*	10	U07111.031.0050	(5/16-18)3/8X1.1/4*	10	U07111.037.0125	(3/8-16)1/2X7/8*	5	U07111.050.0087
(1/4-20)5/16X5/8*	10	U07111.031.0062	(5/16-18)3/8X1.1/2*	10	U07111.037.0150	(3/8-16)1/2X1 Inch*	5	U07111.050.0100
(1/4-20)5/16X3/4*	10	U07111.031.0075	(5/16-18)3/8X1.3/4*	10	U07111.037.0175	(3/8-16)1/2X1.1/4*	5	U07111.050.0125

U07111 Śruby pasowane z łbem walcowym z gniazdem sześciokątnym UNC

(D ₁) Dx L	☒	Kod artykułu	(D ₁) Dx L	☒	Kod artykułu	(D ₁) Dx L	☒	Kod artykułu
(3/8-16)1/2X1.1/2*	5	U07111.050.0150	(1/2-13)5/8X2 3/4*	1	U07111.062.0275	(5/8-11)3/4X3 1/4*	1	U07111.075.0325
(3/8-16)1/2X1.3/4*	5	U07111.050.0175	(1/2-13)5/8X3 Inch*	1	U07111.062.0300	(5/8-11)3/4X3 1/2*	1	U07111.075.0350
(3/8-16)1/2X2 Inch*	5	U07111.050.0200	(1/2-13)5/8X3 1/4*	1	U07111.062.0325	(5/8-11)3/4X3 3/4*	1	U07111.075.0375
(3/8-16)1/2X2 1/4*	5	U07111.050.0225	(1/2-13)5/8X3 1/2*	1	U07111.062.0350	(5/8-11)3/4X4 Inch*	1	U07111.075.0400
(3/8-16)1/2X2 1/2*	5	U07111.050.0250	(1/2-13)5/8X3 3/4*	1	U07111.062.0375	(5/8-11)3/4X4 1/4*	1	U07111.075.0425
(3/8-16)1/2X2 3/4*	5	U07111.050.0275	(1/2-13)5/8X4 Inch*	1	U07111.062.0400	(5/8-11)3/4X4 1/2*	1	U07111.075.0450
(3/8-16)1/2X3 Inch*	5	U07111.050.0300	(1/2-13)5/8X4 1/4*	1	U07111.062.0425	(5/8-11)3/4X4 3/4*	1	U07111.075.0475
(3/8-16)1/2X3 1/4*	5	U07111.050.0325	(1/2-13)5/8X4 1/2*	1	U07111.062.0450	(5/8-11)3/4X5 Inch*	1	U07111.075.0500
(3/8-16)1/2X3 1/2*	5	U07111.050.0350	(1/2-13)5/8X4 3/4*	1	U07111.062.0475	(5/8-11)3/4X5 1/2*	1	U07111.075.0550
(3/8-16)1/2X3 3/4*	5	U07111.050.0375	(1/2-13)5/8X5 Inch*	1	U07111.062.0500	(5/8-11)3/4X6 Inch*	1	U07111.075.0600
(3/8-16)1/2X4 Inch*	5	U07111.050.0400	(1/2-13)5/8X5 1/2*	1	U07111.062.0550	(5/8-11)3/4X7 Inch*	1	U07111.075.0700
(3/8-16)1/2X4 1/4*	5	U07111.050.0425	(1/2-13)5/8X6 Inch*	1	U07111.062.0600	(5/8-11)3/4X8 Inch*	1	U07111.075.0800
(3/8-16)1/2X4 1/2*	5	U07111.050.0450						
(3/8-16)1/2X4 3/4*	5	U07111.050.0475	(5/8-11)3/4X1/2*	1	U07111.075.0050	(3/4-10)1X1 Inch*	1	U07111.100.0100
(3/8-16)1/2X5 Inch*	5	U07111.050.0500	(5/8-11)3/4X3/4*	1	U07111.075.0075	(3/4-10)1X1.1/2*	1	U07111.100.0150
(3/8-16)1/2X5 1/2*	1	U07111.050.0550	(5/8-11)3/4X1 Inch*	1	U07111.075.0100	(3/4-10)1X1.3/4*	1	U07111.100.0175
(3/8-16)1/2X6 Inch*	1	U07111.050.0600	(5/8-11)3/4X1 1/4*	1	U07111.075.0125	(3/4-10)1X2 Inch*	1	U07111.100.0200
			(5/8-11)3/4X1 1/2*	1	U07111.075.0150	(3/4-10)1X2 1/2*	1	U07111.100.0250
(1/2-13)5/8X1.1/4*	5	U07111.062.0125	(5/8-11)3/4X1.3/4*	1	U07111.075.0175	(3/4-10)1X3 Inch*	1	U07111.100.0300
(1/2-13)5/8X1.1/2*	1	U07111.062.0150	(5/8-11)3/4X2 Inch*	1	U07111.075.0200	(3/4-10)1X3 1/2*	1	U07111.100.0350
(1/2-13)5/8X1.3/4*	1	U07111.062.0175	(5/8-11)3/4X2 1/4*	1	U07111.075.0225	(3/4-10)1X4 Inch*	1	U07111.100.0400
(1/2-13)5/8X2 Inch*	1	U07111.062.0200	(5/8-11)3/4X2 1/2*	1	U07111.075.0250	(3/4-10)1X5 Inch*	1	U07111.100.0500
(1/2-13)5/8X2 1/4*	1	U07111.062.0225	(5/8-11)3/4X2 3/4*	1	U07111.075.0275	(3/4-10)1X6 Inch*	1	U07111.100.0600
(1/2-13)5/8X2 1/2*	1	U07111.062.0250	(5/8-11)3/4X3 Inch*	1	U07111.075.0300			

07116 Śruby pasowane z łbem walcowym z gniazdem sześciokątnym UNC

Gwint Calowy, zunifikowany grubozwojny (UNC)
Material Stal
Klasa 012.9

X05A

(D ₁) Dx L	☒	Kod artykułu	(D ₁) Dx L	☒	Kod artykułu	(D ₁) Dx L	☒	Kod artykułu
(NO.10)1/4X3/4	25	07116.048.019	(5/16)3/8X1 Inch	10	07116.079.025	(3/8)1/2X4 Inch	5	07116.096.101
(NO.10)1/4X1 Inch	25	07116.048.025	(5/16)3/8X1.1/4	10	07116.079.031			
(NO.10)1/4X1.1/4	25	07116.048.031	(5/16)3/8X1.1/2	10	07116.079.038	(1/2)5/8X1.1/4	5	07116.127.031
(NO.10)1/4X1.1/2	10	07116.048.038	(5/16)3/8X1.3/4	10	07116.079.044	(1/2)5/8X1.1/2	5	07116.127.038
(NO.10)1/4X2 Inch	10	07116.048.050	(5/16)3/8X2 Inch	10	07116.079.050	(1/2)5/8X2 Inch	5	07116.127.050
			(5/16)3/8X2.1/2	10	07116.079.063	(1/2)5/8X2.1/2	5	07116.127.063
(1/4)5/16X1 Inch	25	07116.063.025	(5/16)3/8X3 Inch	10	07116.079.076	(1/2)5/8X3 Inch	5	07116.127.076
(1/4)5/16X1.1/4	25	07116.063.031				(1/2)5/8X3.1/2	3	07116.127.088
(1/4)5/16X1.1/2	25	07116.063.038	(3/8)1/2X1 Inch	10	07116.096.025	(1/2)5/8X4 Inch	3	07116.127.101
(1/4)5/16X1.3/4	10	07116.063.044	(3/8)1/2X1.1/4	10	07116.096.031			
(1/4)5/16X2 Inch	10	07116.063.050	(3/8)1/2X1.1/2	10	07116.096.038	(5/8)3/4X2 Inch	3	07116.158.050
(1/4)5/16X2.1/4	10	07116.063.057	(3/8)1/2X2 Inch	10	07116.096.050	(5/8)3/4X2.1/2	3	07116.158.063
(1/4)5/16X2.1/2	10	07116.063.063	(3/8)1/2X2.1/2	5	07116.096.063	(5/8)3/4X3 Inch	3	07116.158.076
			(3/8)1/2X3 Inch	5	07116.096.076	(5/8)3/4X3.1/2	3	07116.158.088
(5/16)3/8X3/4	10	07116.079.019	(3/8)1/2X3.1/2	5	07116.096.088	(5/8)3/4X4 Inch	3	07116.158.101

* Ostrzeżenie: cynkowanie elektrolityczne tych produktów może wywołać kruchość wodorową.

U51044 Śruby pasowane z łbem walcowym z gniazdem sześciokątnym UNC

Gwint Calowy, zunifikowany grubozwojny (UNC)
Material Stal nierdzewna A2 (AISI 304/18-8)

X15A

(D ₁) Dx L	☒	Kod artykułu	(D ₁) Dx L	☒	Kod artykułu	(D ₁) Dx L	☒	Kod artykułu
(10-24)1/4X1/4*	5	U51044.025.0025	(1/4-20)5/16X1/2*	5	U51044.031.0050	(5/16-18)3/8X3/4*	5	U51044.037.0075
(10-24)1/4X5/16*	5	U51044.025.0031	(1/4-20)5/16X5/8*	5	U51044.031.0062	(5/16-18)3/8X1 Inch*	2	U51044.037.0100
(10-24)1/4X3/8*	5	U51044.025.0037	(1/4-20)5/16X3/4*	5	U51044.031.0075	(5/16-18)3/8X1.1/4*	2	U51044.037.0125
(10-24)1/4X1/2*	5	U51044.025.0050	(1/4-20)5/16X1 Inch*	5	U51044.031.0100	(5/16-18)3/8X1.1/2*	2	U51044.037.0150
(10-24)1/4X5/8*	5	U51044.025.0062	(1/4-20)5/16X1.1/4*	5	U51044.031.0125			
(10-24)1/4X3/4*	5	U51044.025.0075	(1/4-20)5/16X1.1/2*	5	U51044.031.0150	(3/8-16)1/2X3/8*	5	U51044.050.0037
(10-24)1/4X1 Inch*	5	U51044.025.0100				(3/8-16)1/2X1/2*	5	U51044.050.0050
(10-24)1/4X1.1/4*	5	U51044.025.0125	(5/16-18)3/8X1/4*	5	U51044.037.0025	(3/8-16)1/2X5/8*	5	U51044.050.0062
(10-24)1/4X1.1/2*	2	U51044.025.0150	(5/16-18)3/8X5/16*	5	U51044.037.0031	(3/8-16)1/2X3/4*	5	U51044.050.0075
			(5/16-18)3/8X3/8*	5	U51044.037.0037	(3/8-16)1/2X1 Inch*	5	U51044.050.0100
(1/4-20)5/16X1/4*	5	U51044.031.0025	(5/16-18)3/8X1/2*	5	U51044.037.0050	(3/8-16)1/2X1.1/4*	5	U51044.050.0125
(1/4-20)5/16X5/16*	5	U51044.031.0031	(5/16-18)3/8X5/8*	5	U51044.037.0062	(3/8-16)1/2X1.1/2*	2	U51044.050.0150
(1/4-20)5/16X3/8*	5	U51044.031.0037						

Śruby pasowane h8 z łbem walcowym z gniazdem sześciokątnym, metryczne

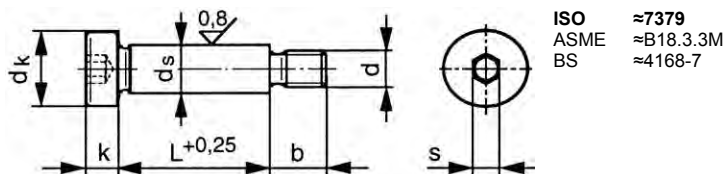

ISO ≈7379
ASME ≈B18.3.3M
BS ≈4168-7



Informacje techniczne

d	Tolerancja h8 (min.)	Tolerancja h8 (maks.)	b	dk (maks.)	ds (nom.)	k (maks.)	P	s
M5	5.982	6.000	9.5	10.22	6	4.5	0.8	3
M6	7.978	8.000	11	13.27	8	5.5	1	4
M8	9.978	10.000	13	16.27	10	7	1.25	5
M10	11.973	12.000	16	18.27	12	9	1.5	6
M12	15.973	16.000	18	24.33	16	11	1.75	8

- W związku z niestandardową geometrią łba elementy złączne mają ograniczoną obciążalność.
- W przypadku znakowania śrub o ograniczonej obciążalności, symbol standardowego oznaczenia poprzedza cyfra "0", tak więc 8.8→08.8 ; 10.9→010.9 oraz 12.9→012.9
- Dla elementów złącznych ze stali nierdzewnej oznaczenie następuje poprzez oznaczenie cechy danej klasy na przykład: 70 (A2-70 → A2).
- Tymczasowo mogą pojawić się stare i nowe formy znakowania na śrubach.

Przykład zastosowania

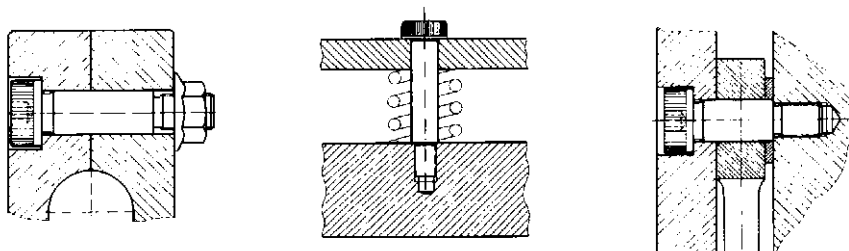

07117 Śruby pasowane h8 z łbem walcowym z gniazdem sześciokątnym, metryczne

D93A

Gwint Metryczny
Materiał Stal
Klasa 012.9



(d) ds x L	☒	Kod artykułu	(d) ds x L	☒	Kod artykułu	(d) ds x L	☒	Kod artykułu
M5 6X10	50	07117.050.010	M8 10X16	50	07117.080.016	M10 12X60	25	07117.100.060
M5 6X12	50	07117.050.012	M8 10X20	50	07117.080.020	M10 12X70	25	07117.100.070
M5 6X16	50	07117.050.016	M8 10X25	50	07117.080.025	M10 12X80	25	07117.100.080
M5 6X20	50	07117.050.020	M8 10X30	50	07117.080.030	M10 12X90	25	07117.100.090
M5 6X25	50	07117.050.025	M8 10X40	50	07117.080.040	M10 12X100	25	07117.100.100
M5 6X30	50	07117.050.030	M8 10X50	50	07117.080.050	M12 16X30	25	07117.120.030
M5 6X40	50	07117.050.040	M8 10X60	50	07117.080.060	M12 16X40	25	07117.120.040
M6 8X10	50	07117.060.010	M8 10X70	50	07117.080.070	M12 16X50	25	07117.120.050
M6 8X12	50	07117.060.012	M10 12X16	25	07117.100.016	M12 16X60	25	07117.120.060
M6 8X16	50	07117.060.016	M10 12X20	25	07117.100.020	M12 16X70	25	07117.120.070
M6 8X20	50	07117.060.020	M10 12X25	25	07117.100.025	M12 16X80	25	07117.120.080
M6 8X25	50	07117.060.025	M10 12X30	25	07117.100.030	M12 16X90	25	07117.120.090
M6 8X30	50	07117.060.030	M10 12X40	25	07117.100.040	M12 16X100	25	07117.120.100
M6 8X40	50	07117.060.040	M10 12X50	25	07117.100.050	M12 16X120	25	07117.120.120
M6 8X50	50	07117.060.050						

- Ostrzeżenie: cynkowanie elektrolityczne tych produktów może wywołać kruchość wodorową.

Wkręty dociskowe z gniazdem sześciokątnym z końcem wgłębionym, metryczne

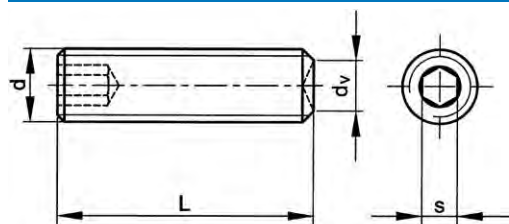

DIN	916
ISO	4029
NEN	2343
ASME	B18.3.6M
NF	E27-183
BS	4168-5



2

Informacje techniczne

d	d _v	P	s	d	d _v	P	s
M1.6	0.8	0.35	0.7	M8	5	1.25	4
M2	1	0.4	0.9	M10	6	1.5	5
M2.5	1.2	0.45	1.3	M12	8	1.75	6
M3	1.4	0.5	1.5	M14	9	2	6
M4	2	0.7	2	M16	10	2	8
M5	2.5	0.8	2.5	M20	14	2.5	10
M6	3	1	3	M24	16	3	12

Grupy katalogowe

Gwint	Gniazdo	Materiał	Klasa	Obróbka powierzchni	Kod	Strona
M	Gniazdo sześciokątne	St	45H		07840	2-69
M	Gniazdo sześciokątne	St	45H	Ocynek.	07850	2-70
M	Gniazdo sześciokątne	St	45H	Ocynek. żłt. pas.	07930	2-70
M	Gniazdo sześciokątne	St.St. A2			51260	2-71
M	Gniazdo sześciokątne	St.St. A4			55260	2-71

07840 Wkręty dociskowe z gniazdem sześciokątnym z końcem wgłębionym, metryczne

D05A

Gwint: Metryczny
Materiał: Stal
Klasa: 45H



d x L	☒	Kod artykułu	d x L	☒	Kod artykułu	d x L	☒	Kod artykułu
M2X2	200	07840.020.002	M5X8	200	07840.050.008	M8X60	100	07840.080.060
M2X3	200	07840.020.003	M5X10	200	07840.050.010	M8X70	100	07840.080.070
M2X4	200	07840.020.004	M5X12	200	07840.050.012	M8X80	100	07840.080.080
M2X6	200	07840.020.006	M5X16	200	07840.050.016			
M2X8	200	07840.020.008	M5X20	200	07840.050.020	M10X8	200	07840.100.008
M2X10	200	07840.020.010	M5X25	200	07840.050.025	M10X10	200	07840.100.010
M2X12	200	07840.020.012	M5X30	200	07840.050.030	M10X12	200	07840.100.012
			M5X35	200	07840.050.035	M10X16	200	07840.100.016
M3X3	200	07840.030.003	M5X40	200	07840.050.040	M10X20	200	07840.100.020
M3X4	200	07840.030.004	M5X50	200	07840.050.050	M10X25	100	07840.100.025
M3X5	200	07840.030.005				M10X30	100	07840.100.030
M3X6	200	07840.030.006	M6X6	200	07840.060.006	M10X35	100	07840.100.035
M3X8	200	07840.030.008	M6X8	200	07840.060.008	M10X40	100	07840.100.040
M3X10	200	07840.030.010	M6X10	200	07840.060.010	M10X45	100	07840.100.045
M3X12	200	07840.030.012	M6X12	200	07840.060.012	M10X50	100	07840.100.050
M3X16	200	07840.030.016	M6X16	200	07840.060.016	M10X60	100	07840.100.060
M3X20	200	07840.030.020	M6X20	200	07840.060.020	M10X70	100	07840.100.070
M3X25	200	07840.030.025	M6X25	200	07840.060.025	M10X80	100	07840.100.080
M3X30	200	07840.030.030	M6X30	200	07840.060.030			
			M6X35	200	07840.060.035	M12X10	100	07840.120.010
M4X4	200	07840.040.004	M6X40	200	07840.060.040	M12X12	100	07840.120.012
M4X5	200	07840.040.005	M6X45	200	07840.060.045	M12X16	100	07840.120.016
M4X6	200	07840.040.006	M6X50	200	07840.060.050	M12X20	100	07840.120.020
M4X8	200	07840.040.008	M6X60	200	07840.060.060	M12X25	100	07840.120.025
M4X10	200	07840.040.010	M6X70	200	07840.060.070	M12X30	100	07840.120.030
M4X12	200	07840.040.012				M12X35	100	07840.120.035
M4X16	200	07840.040.016	M8X8	200	07840.080.008	M12X40	100	07840.120.040
M4X20	200	07840.040.020	M8X10	200	07840.080.010	M12X45	100	07840.120.045
M4X25	200	07840.040.025	M8X12	200	07840.080.012	M12X50	100	07840.120.050
M4X30	200	07840.040.030	M8X16	200	07840.080.016	M12X55	100	07840.120.055
M4X35	200	07840.040.035	M8X20	200	07840.080.020	M12X60	100	07840.120.060
M4X40	200	07840.040.040	M8X25	200	07840.080.025	M12X70	100	07840.120.070
M4X50	100	07840.040.050	M8X30	200	07840.080.030	M12X80	100	07840.120.080
			M8X35	100	07840.080.035	M12X90	100	07840.120.090
M5X4	200	07840.050.004	M8X40	100	07840.080.040	M12X100	50	07840.120.100
M5X5	200	07840.050.005	M8X45	100	07840.080.045	M12X110	50	07840.120.110
M5X6	200	07840.050.006	M8X50	100	07840.080.050			

07840 Wkręty dociskowe z gniazdem sześciokątnym z końcem wgłębionym, metryczne								
d x L	☒	Kod artykułu	d x L	☒	Kod artykułu	d x L	☒	Kod artykułu
M14X16	100	07840.140.016	M16X40	50	07840.160.040	M20X65	10	07840.200.065
M14X20	100	07840.140.020	M16X45	50	07840.160.045	M20X70	10	07840.200.070
M14X25	100	07840.140.025	M16X50	50	07840.160.050	M20X80	10	07840.200.080
M14X30	50	07840.140.030	M16X60	25	07840.160.060	M20X100	10	07840.200.100
M14X35	50	07840.140.035	M16X70	25	07840.160.070	M20X120	10	07840.200.120
M14X40	50	07840.140.040	M16X80	25	07840.160.080			
M14X50	50	07840.140.050	M16X100	25	07840.160.100	M24X25	25	07840.240.025
M14X60	50	07840.140.060	M16X130	25	07840.160.130	M24X40	10	07840.240.040
M14X110	50	07840.140.110				M24X50	10	07840.240.050
			M20X20	25	07840.200.020	M24X60	10	07840.240.060
M16X16	50	07840.160.016	M20X25	10	07840.200.025	M24X70	10	07840.240.070
M16X20	50	07840.160.020	M20X30	10	07840.200.030	M24X90	10	07840.240.090
M16X25	50	07840.160.025	M20X40	10	07840.200.040	M24X100	10	07840.240.100
M16X30	50	07840.160.030	M20X50	10	07840.200.050			
M16X35	50	07840.160.035	M20X60	10	07840.200.060			

• Ostrzeżenie: cynkowanie elektrolityczne tych produktów może wywołać kruchość wodorową.

07850 Wkręty dociskowe z gniazdem sześciokątnym z końcem wgłębionym, metryczne D05A

Gwint Metryczny
 Materiał Stal
 Klasa 45H
 Obróbka powierzchni O cynkowane



d x L	☒	Kod artykułu	d x L	☒	Kod artykułu	d x L	☒	Kod artykułu
M3X4	200	07850.030.004	M6X8	200	07850.060.008	M10X16	200	07850.100.016
M3X5	200	07850.030.005	M6X10	200	07850.060.010	M10X20	200	07850.100.020
M3X6	200	07850.030.006	M6X12	200	07850.060.012	M10X25	100	07850.100.025
M3X8	200	07850.030.008	M6X16	200	07850.060.016	M10X30	100	07850.100.030
M3X10	200	07850.030.010	M6X20	200	07850.060.020	M10X35	100	07850.100.035
M3X12	200	07850.030.012	M6X25	200	07850.060.025	M10X40	100	07850.100.040
M3X16	200	07850.030.016	M6X30	200	07850.060.030	M10X50	100	07850.100.050
			M6X35	200	07850.060.035	M10X60	100	07850.100.060
M4X4	200	07850.040.004	M6X40	200	07850.060.040			
M4X5	200	07850.040.005				M12X10	100	07850.120.010
M4X6	200	07850.040.006	M8X6	200	07850.080.006	M12X12	100	07850.120.012
M4X8	200	07850.040.008	M8X8	200	07850.080.008	M12X16	100	07850.120.016
M4X10	200	07850.040.010	M8X10	200	07850.080.010	M12X20	100	07850.120.020
M4X12	200	07850.040.012	M8X12	200	07850.080.012	M12X25	100	07850.120.025
M4X16	200	07850.040.016	M8X16	200	07850.080.016	M12X30	100	07850.120.030
M4X20	200	07850.040.020	M8X20	200	07850.080.020	M12X35	100	07850.120.035
			M8X25	200	07850.080.025	M12X40	100	07850.120.040
M5X6	200	07850.050.006	M8X30	200	07850.080.030	M12X50	100	07850.120.050
M5X8	200	07850.050.008	M8X35	100	07850.080.035	M12X60	100	07850.120.060
M5X10	200	07850.050.010	M8X40	100	07850.080.040			
M5X12	200	07850.050.012	M8X50	100	07850.080.050	M16X20	50	07850.160.020
M5X16	200	07850.050.016	M8X70	100	07850.080.070	M16X25	50	07850.160.025
M5X20	200	07850.050.020				M16X30	50	07850.160.030
M5X25	200	07850.050.025	M10X8	200	07850.100.008	M16X40	50	07850.160.040
M5X30	200	07850.050.030	M10X10	200	07850.100.010	M16X50	50	07850.160.050
			M10X12	200	07850.100.012	M16X60	25	07850.160.060
M6X6	200	07850.060.006						

• Ostrzeżenie: cynkowanie elektrolityczne tych produktów może wywołać kruchość wodorową.



07930 Wkręty dociskowe z gniazdem sześciokątnym z końcem wgłębionym, metryczne D05A

Gwint Metryczny
 Materiał Stal
 Klasa 45H
 Obróbka powierzchni O cynkowane, po żółtej pasywacji





d x L	☒	Kod artykułu	d x L	☒	Kod artykułu	d x L	☒	Kod artykułu
M5X16	200	07930.050.016	M6X40	200	07930.060.040	M10X25	100	07930.100.025
M5X20	200	07930.050.020				M10X30	100	07930.100.030
			M8X25	200	07930.080.025	M10X40	100	07930.100.040
M6X16	200	07930.060.016	M8X30	200	07930.080.030	M10X50	100	07930.100.050
M6X20	200	07930.060.020	M8X40	100	07930.080.040	M10X60	100	07930.100.060
M6X25	200	07930.060.025	M8X50	100	07930.080.050			
M6X30	200	07930.060.030						

• Ostrzeżenie: cynkowanie elektrolityczne tych produktów może wywołać kruchość wodorową.

51260		Wkręty dociskowe z gniazdem sześciokątnym z końcem wgłębionym, metryczne		R03A	
Gwint	Metryczny				
Materiał	Stal nierdzewna A2				
					
					

d x L	☒	Kod artykułu	d x L	☒	Kod artykułu	d x L	☒	Kod artykułu
M1,6X3	25	51260.016.003	M5X4*	500	51260.050.004	M10X10	100	51260.100.010
M1,6X4	25	51260.016.004	M5X5	200	51260.050.005	M10X12	100	51260.100.012
M1,6X5	25	51260.016.005	M5X6	200	51260.050.006	M10X16	100	51260.100.016
M1,6X6	25	51260.016.006	M5X8	200	51260.050.008	M10X20	100	51260.100.020
			M5X10	200	51260.050.010	M10X25	100	51260.100.025
M2X3	50	51260.020.003	M5X12	200	51260.050.012	M10X30	100	51260.100.030
M2X4	50	51260.020.004	M5X14*	500	51260.050.014	M10X35	100	51260.100.035
M2X5	50	51260.020.005	M5X16	200	51260.050.016	M10X40	100	51260.100.040
M2X6	50	51260.020.006	M5X20	200	51260.050.020	M10X45*	100	51260.100.045
M2X8	50	51260.020.008	M5X25	200	51260.050.025	M10X50	100	51260.100.050
M2X10*	500	51260.020.010	M5X30	200	51260.050.030	M10X60	100	51260.100.060
M2X12*	500	51260.020.012	M5X35*	200	51260.050.035			
			M5X40*	200	51260.050.040	M12X10*	100	51260.120.010
M2,5X3*	500	51260.025.003				M12X12	100	51260.120.012
M2,5X4	50	51260.025.004	M6X5	200	51260.060.005	M12X16	100	51260.120.016
M2,5X5	50	51260.025.005	M6X6	200	51260.060.006	M12X20	100	51260.120.020
M2,5X6	50	51260.025.006	M6X8	200	51260.060.008	M12X25	100	51260.120.025
M2,5X8	50	51260.025.008	M6X10	200	51260.060.010	M12X30	100	51260.120.030
M2,5X10*	500	51260.025.010	M6X12	200	51260.060.012	M12X35	100	51260.120.035
M2,5X12*	500	51260.025.012	M6X14*	200	51260.060.014	M12X40	100	51260.120.040
			M6X16	200	51260.060.016	M12X45*	100	51260.120.045
M3X3	200	51260.030.003	M6X20	200	51260.060.020	M12X50	100	51260.120.050
M3X4	200	51260.030.004	M6X25	200	51260.060.025	M12X55*	100	51260.120.055
M3X5	200	51260.030.005	M6X30	200	51260.060.030	M12X60*	100	51260.120.060
M3X6	200	51260.030.006	M6X35	200	51260.060.035	M12X70*	50	51260.120.070
M3X8	200	51260.030.008	M6X40	200	51260.060.040			
M3X10	200	51260.030.010	M6X45*	200	51260.060.045	M16X16	50	51260.160.016
M3X12	200	51260.030.012	M6X50	200	51260.060.050	M16X20	100	51260.160.020
M3X16	200	51260.030.016	M6X60	200	51260.060.060	M16X25	50	51260.160.025
M3X20	200	51260.030.020				M16X30	50	51260.160.030
M3X25*	500	51260.030.025	M8X6	200	51260.080.006	M16X35*	50	51260.160.035
M3X30	200	51260.030.030	M8X8	200	51260.080.008	M16X40*	50	51260.160.040
			M8X10	200	51260.080.010	M16X45*	50	51260.160.045
M4X3	500	51260.040.003	M8X12	200	51260.080.012	M16X50*	50	51260.160.050
M4X4	200	51260.040.004	M8X16	200	51260.080.016	M16X60*	50	51260.160.060
M4X5	200	51260.040.005	M8X20	200	51260.080.020	M16X70*	50	51260.160.070
M4X6	200	51260.040.006	M8X25	200	51260.080.025	M16X80*	25	51260.160.080
M4X8	200	51260.040.008	M8X30	100	51260.080.030			
M4X10	200	51260.040.010	M8X35	100	51260.080.035	M20X20*	50	51260.200.020
M4X12	200	51260.040.012	M8X40	100	51260.080.040	M20X25*	50	51260.200.025
M4X16	200	51260.040.016	M8X45	200	51260.080.045	M20X30*	50	51260.200.030
M4X20	200	51260.040.020	M8X50	100	51260.080.050	M20X35*	50	51260.200.035
M4X25	200	51260.040.025	M8X60	100	51260.080.060	M20X40*	50	51260.200.040
M4X30	200	51260.040.030	M8X70	200	51260.080.070	M20X60*	50	51260.200.060
M4X35*	200	51260.040.035	M8X80*	200	51260.080.080	M20X70*	25	51260.200.070
						M20X80*	25	51260.200.080

55260		Wkręty dociskowe z gniazdem sześciokątnym z końcem wgłębionym, metryczne		R43A	
Gwint	Metryczny				
Materiał	Stal nierdzewna A4				
					
					

d x L	☒	Kod artykułu	d x L	☒	Kod artykułu	d x L	☒	Kod artykułu
M2X3	50	55260.020.003				M5X16	200	55260.050.016
M2X4	50	55260.020.004	M4X4	200	55260.040.004	M5X20	200	55260.050.020
M2X6	50	55260.020.006	M4X5	200	55260.040.005	M5X25	200	55260.050.025
			M4X6	200	55260.040.006	M5X30	200	55260.050.030
M2,5X4	50	55260.025.004	M4X8	200	55260.040.008	M5X35*	200	55260.050.035
M2,5X6	50	55260.025.006	M4X10	200	55260.040.010	M5X40	200	55260.050.040
			M4X12	200	55260.040.012			
M3X3	200	55260.030.003	M4X16	200	55260.040.016	M6X6	200	55260.060.006
M3X4	200	55260.030.004	M4X20	200	55260.040.020	M6X8	200	55260.060.008
M3X5	200	55260.030.005	M4X25	200	55260.040.025	M6X10	200	55260.060.010
M3X6	200	55260.030.006	M4X30*	200	55260.040.030	M6X12	200	55260.060.012
M3X8	200	55260.030.008				M6X14*	200	55260.060.014
M3X10	200	55260.030.010	M5X5	200	55260.050.005	M6X16	200	55260.060.016
M3X12	200	55260.030.012	M5X6	200	55260.050.006	M6X20	200	55260.060.020
M3X16	200	55260.030.016	M5X8	200	55260.050.008	M6X25	200	55260.060.025
M3X20	200	55260.030.020	M5X10	200	55260.050.010	M6X30	200	55260.060.030
M3X30*	200	55260.030.030	M5X12	200	55260.050.012	M6X35*	200	55260.060.035

55260 Wkręty dociskowe z gniazdem sześciokątnym z końcem wgłębionym, metryczne								
d x L	☒	Kod artykułu	d x L	☒	Kod artykułu	d x L	☒	Kod artykułu
M6X40	200	55260.060.040	M10X16	100	55260.100.016	M12X50	100	55260.120.050
M6X45*	200	55260.060.045	M10X20	100	55260.100.020	M16X16	50	55260.160.016
M6X50	200	55260.060.050	M10X25	100	55260.100.025	M16X20	50	55260.160.020
M6X60*	200	55260.060.060	M10X30	100	55260.100.030	M16X25*	50	55260.160.025
M8X8	200	55260.080.008	M10X35*	100	55260.100.035	M16X30*	50	55260.160.030
M8X10	200	55260.080.010	M10X40	100	55260.100.040	M16X35*	50	55260.160.035
M8X12	200	55260.080.012	M10X45*	100	55260.100.045	M16X40*	50	55260.160.040
M8X16	200	55260.080.016	M10X50	100	55260.100.050	M16X45*	50	55260.160.045
M8X20	200	55260.080.020	M10X60*	100	55260.100.060	M16X50*	50	55260.160.050
M8X25	200	55260.080.025	M12X10	100	55260.120.010	M16X60*	50	55260.160.060
M8X30	100	55260.080.030	M12X12	100	55260.120.012	M16X70*	50	55260.160.070
M8X35	100	55260.080.035	M12X16	100	55260.120.016	M16X90	50	55260.160.090
M8X40	100	55260.080.040	M12X20	100	55260.120.020	M20X20*	50	55260.200.020
M8X45*	200	55260.080.045	M12X25	100	55260.120.025	M20X25*	50	55260.200.025
M8X50	100	55260.080.050	M12X30	100	55260.120.030	M20X30*	50	55260.200.030
M10X10	100	55260.100.010	M12X35*	100	55260.120.035	M20X50	50	55260.200.050
M10X12	100	55260.100.012	M12X40	100	55260.120.040	M20X70*	25	55260.200.070
			M12X45*	100	55260.120.045			

Wkręty dociskowe z gniazdem sześciokątnym z końcem wgłębionym, metryczne drzew

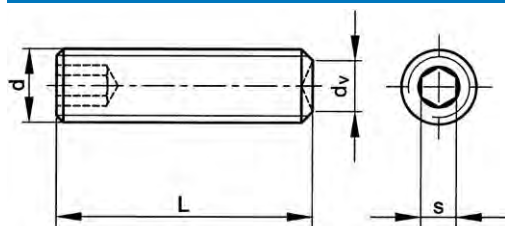

DIN ≈916
 ISO ≈4029
 NEN ≈2343
 ASME ≈B18.3.6M
 NF ≈E27-183
 BS ≈4168-5

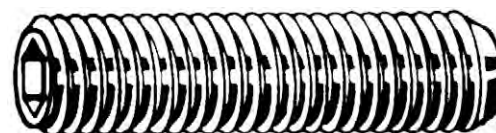

Informacje techniczne

d	d _v	s	d	d _v	s
M8	5	4	M12	8	6
M10	6	5	M16	10	8

07852 Wkręty dociskowe z gniazdem sześciokątnym z końcem wgłębionym, metryczne drobnozwojne D93A

Gwint Metryczny drobnozwojny
 Materiał Stal
 Klasa 45H



d x P x L	☒	Kod artykułu	d x P x L	☒	Kod artykułu	d x P x L	☒	Kod artykułu
M8X1,00X10	100	07852.080.010	M10X1,25X16	50	07852.100.016	M12X1,50X25	50	07852.120.025
M8X1,00X12	100	07852.080.012	M10X1,25X20	50	07852.100.020	M12X1,50X30	50	07852.120.030
M8X1,00X16	100	07852.080.016	M10X1,25X25	50	07852.100.025	M12X1,50X40	50	07852.120.040
M8X1,00X20	100	07852.080.020	M10X1,25X30	50	07852.100.030	M12X1,50X50	50	07852.120.050
M8X1,00X25	50	07852.080.025	M10X1,25X40	50	07852.100.040	M16X1,50X20	25	07852.160.020
M8X1,00X30	50	07852.080.030	M10X1,25X50	50	07852.100.050	M16X1,50X25	25	07852.160.025
M8X1,00X40	50	07852.080.040	M12X1,50X10	50	07852.120.010	M16X1,50X30	25	07852.160.030
M8X1,00X50	50	07852.080.050	M12X1,50X12	50	07852.120.012	M16X1,50X40	25	07852.160.040
M10X1,25X10	50	07852.100.010	M12X1,50X16	50	07852.120.016	M16X1,50X50	25	07852.160.050
M10X1,25X12	50	07852.100.012	M12X1,50X20	50	07852.120.020			

• Ostrzeżenie: cynkowanie elektrolityczne tych produktów może wywołać kruchość wodorową.

Wkręty dociskowe z gniazdem sześciokątnym z końcem wgłębionym UNC

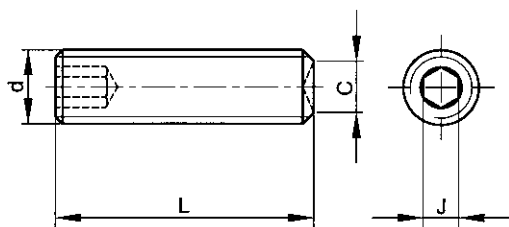

ASME ≈B18.3
BS ≈2470

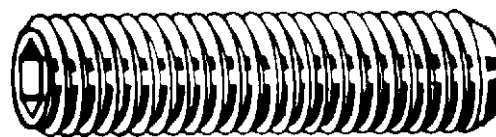

2

Informacje techniczne

d	C (maks.)	J	Zwoje gwintu na cal	d	C (maks.)	J	Zwoje gwintu na cal
No.2	0.047	0.035	56	5/16	0.172	5/32	18
No.3	0.054	0.050	48	3/8	0.212	3/16	16
No.4	0.061	0.050	40	7/16	0.252	7/32	14
No.5	0.067	1/16	40	1/2	0.291	1/4	13
No.6	0.074	1/16	32	5/8	0.371	5/16	11
No.8	0.087	5/64	32	3/4	0.450	3/8	10
No.10	0.102	3/32	24	7/8	0.530	1/2	9
1/4	0.132	1/8	20	1 Inch	0.609	9/16	8

Grupy katalogowe

Gwint	Gniazdo	Material	Kod	Strona
UNC	Gniazdo sześciokątne	St	U07840	2-73
UNC	Gniazdo sześciokątne	St.St. A2 (AISI304/18-8)	U51260	2-74

U07840 Wkręty dociskowe z gniazdem sześciokątnym z końcem wgłębionym UNC

X05A

Gwint Calowy, zunifikowany grubozwojny (UNC)
Material Stal



d x L	☒	Kod artykułu	d x L	☒	Kod artykułu	d x L	☒	Kod artykułu
NO.2-56X3/16*	100	U07840.008.0006	NO.6-32X5/16*	100	U07840.013.0031	1/4-20X1/2*	100	U07840.025.0050
NO.2-56X3/32*	100	U07840.008.0009	NO.6-32X3/8*	100	U07840.013.0037	1/4-20X5/8*	100	U07840.025.0062
NO.2-56X1/8*	100	U07840.008.0012	NO.6-32X1/2*	100	U07840.013.0050	1/4-20X3/4*	100	U07840.025.0075
NO.2-56X3/16*	100	U07840.008.0018	NO.6-32X5/8*	100	U07840.013.0062	1/4-20X7/8*	100	U07840.025.0087
NO.2-56X1/4*	100	U07840.008.0025	NO.6-32X3/4*	100	U07840.013.0075	1/4-20X1 Inch*	100	U07840.025.0100
			NO.6-32X7/8*	100	U07840.013.0087	1/4-20X1.1/8*	100	U07840.025.0112
NO.3-48X3/32*	100	U07840.009.0009	NO.6-32X7/16*	100	U07840.013.0100	1/4-20X1.1/4*	100	U07840.025.0125
NO.3-48X1/8*	100	U07840.009.0012	NO.6-32X1 Inch*	100		1/4-20X1.1/2*	100	U07840.025.0150
NO.3-48X3/16*	100	U07840.009.0018				1/4-20X1.3/4*	100	U07840.025.0175
NO.3-48X1/4*	100	U07840.009.0025	NO.8-32X1/8*	100	U07840.016.0012	1/4-20X2 Inch*	100	U07840.025.0200
NO.3-48X5/16*	100	U07840.009.0031	NO.8-32X3/16*	100	U07840.016.0018	1/4-20X2.1/4*	100	U07840.025.0225
NO.3-48X1/2*	100	U07840.009.0050	NO.8-32X1/4*	100	U07840.016.0025	1/4-20X2.1/2*	50	U07840.025.0250
NO.3-48X5/8*	100	U07840.009.0062	NO.8-32X5/16*	100	U07840.016.0031	1/4-20X2.1/2*	50	U07840.025.0300
NO.3-48X3/4*	100	U07840.009.0075	NO.8-32X3/8*	100	U07840.016.0037	1/4-20X3 Inch*		
			NO.8-32X7/16*	100	U07840.016.0043			
NO.4-40X3/32*	100	U07840.011.0009	NO.8-32X1/2*	100	U07840.016.0050	5/16-18X3/16*	100	U07840.031.0018
NO.4-40X1/8*	100	U07840.011.0012	NO.8-32X5/8*	100	U07840.016.0062	5/16-18X1/4*	100	U07840.031.0025
NO.4-40X3/16*	100	U07840.011.0018	NO.8-32X3/4*	100	U07840.016.0075	5/16-18X5/16*	100	U07840.031.0031
NO.4-40X1/4*	100	U07840.011.0025	NO.8-32X7/8*	100	U07840.016.0087	5/16-18X3/8*	100	U07840.031.0037
NO.4-40X5/16*	100	U07840.011.0031	NO.8-32X1 Inch*	100	U07840.016.0100	5/16-18X7/16*	100	U07840.031.0043
NO.4-40X3/8*	100	U07840.011.0037	NO.8-32X1.1/4*	100	U07840.016.0125	5/16-18X1/2*	100	U07840.031.0050
NO.4-40X1/2*	100	U07840.011.0050	NO.8-32X1.1/2*	100	U07840.016.0150	5/16-18X5/8*	100	U07840.031.0062
NO.4-40X5/8*	100	U07840.011.0062				5/16-18X3/4*	100	U07840.031.0075
NO.4-40X3/4*	100	U07840.011.0075	NO.10-24X1/8*	100	U07840.019.0012	5/16-18X7/8*	100	U07840.031.0087
NO.4-40X1 Inch*	100	U07840.011.0100	NO.10-24X3/16*	100	U07840.019.0018	5/16-18X1 Inch*	100	U07840.031.0100
			NO.10-24X1/4*	100	U07840.019.0025	5/16-18X1.1/4*	100	U07840.031.0125
NO.5-40X1/8*	100	U07840.012.0012	NO.10-24X5/16*	100	U07840.019.0031	5/16-18X1.1/2*	100	U07840.031.0150
NO.5-40X3/16*	100	U07840.012.0018	NO.10-24X3/8*	100	U07840.019.0037	5/16-18X1.3/4*	100	U07840.031.0175
NO.5-40X1/4*	100	U07840.012.0025	NO.10-24X1/2*	100	U07840.019.0050	5/16-18X2 Inch*	100	U07840.031.0200
NO.5-40X5/16*	100	U07840.012.0031	NO.10-24X5/8*	100	U07840.019.0062	5/16-18X2.1/4*	100	U07840.031.0225
NO.5-40X3/8*	100	U07840.012.0037	NO.10-24X3/4*	100	U07840.019.0075	5/16-18X2.1/2*	50	U07840.031.0250
NO.5-40X7/16*	100	U07840.012.0043	NO.10-24X7/8*	100	U07840.019.0087	5/16-18X2.3/4*	50	U07840.031.0275
NO.5-40X1/2*	100	U07840.012.0050	NO.10-24X1 Inch*	100	U07840.019.0100			
NO.5-40X5/8*	100	U07840.012.0062	NO.10-24X1.1/4*	100	U07840.019.0125	3/8-16X1/4*	100	U07840.037.0025
NO.5-40X3/4*	100	U07840.012.0075	NO.10-24X1.1/2*	100	U07840.019.0150	3/8-16X5/16*	100	U07840.037.0031
NO.5-40X1 Inch*	100	U07840.012.0100	NO.10-24X2 Inch*	50	U07840.019.0200	3/8-16X3/8*	100	U07840.037.0037
						3/8-16X7/16*	100	U07840.037.0043
NO.6-32X1/8*	100	U07840.013.0012	1/4-20X3/16*	100	U07840.025.0018	3/8-16X1/2*	100	U07840.037.0050
NO.6-32X3/16*	100	U07840.013.0018	1/4-20X1/4*	100	U07840.025.0025	3/8-16X5/8*	100	U07840.037.0062
NO.6-32X1/4*	100	U07840.013.0025	1/4-20X5/16*	100	U07840.025.0031	3/8-16X3/4*	100	U07840.037.0075
			1/4-20X3/8*	100	U07840.025.0037	3/8-16X7/8*	100	U07840.037.0087

U07840 Wkręty dociskowe z gniazdem sześciokątnym z końcem wgłębionym UNC

d x L	☒	Kod artykułu	d x L	☒	Kod artykułu	d x L	☒	Kod artykułu
3/8-16X1 Inch*	100	U07840.037.0100	1/2-13X3/4*	25	U07840.050.0075	3/4-10X5/8*	5	U07840.075.0062
3/8-16X1.1/4*	100	U07840.037.0125	1/2-13X7/8*	25	U07840.050.0087	3/4-10X3/4*	5	U07840.075.0075
3/8-16X1.1/2*	50	U07840.037.0150	1/2-13X1 Inch*	25	U07840.050.0100	3/4-10X7/8*	5	U07840.075.0087
3/8-16X1.3/4*	50	U07840.037.0175	1/2-13X1.1/4*	25	U07840.050.0125	3/4-10X1 Inch*	5	U07840.075.0100
3/8-16X2 Inch*	25	U07840.037.0200	1/2-13X1.1/2*	25	U07840.050.0150	3/4-10X1.1/4*	5	U07840.075.0125
3/8-16X2.1/4*	25	U07840.037.0225	1/2-13X1.3/4*	25	U07840.050.0175	3/4-10X1.1/2*	5	U07840.075.0150
3/8-16X2.1/2*	25	U07840.037.0250	1/2-13X2 Inch*	10	U07840.050.0200	3/4-10X1.3/4*	5	U07840.075.0175
3/8-16X2.3/4*	10	U07840.037.0275	1/2-13X2.1/4*	10	U07840.050.0225	3/4-10X2 Inch*	5	U07840.075.0200
3/8-16X3 Inch*	10	U07840.037.0300	1/2-13X2.1/2*	10	U07840.050.0250	3/4-10X2.1/2*	5	U07840.075.0250
			1/2-13X2.3/4*	10	U07840.050.0275	3/4-10X3 Inch*	5	U07840.075.0300
			1/2-13X3 Inch*	10	U07840.050.0300	3/4-10X3.1/2*	5	U07840.075.0350
			1/2-13X3.1/2*	10	U07840.050.0350	3/4-10X4 Inch*	5	U07840.075.0400
			1/2-13X4 Inch*	10	U07840.050.0400			
7/16-14X3/8*	50	U07840.043.0037	5/8-11X1/2*	10	U07840.062.0050	7/8-9X7/8*	5	U07840.087.0087
7/16-14X7/16*	50	U07840.043.0043	5/8-11X5/8*	10	U07840.062.0062	7/8-9X1 Inch*	5	U07840.087.0100
7/16-14X1/2*	50	U07840.043.0050	5/8-11X3/4*	10	U07840.062.0075	7/8-9X1.1/4*	5	U07840.087.0125
7/16-14X5/8*	50	U07840.043.0062	5/8-11X1 Inch*	10	U07840.062.0100	7/8-9X1.1/2*	5	U07840.087.0150
7/16-14X3/4*	50	U07840.043.0075	5/8-11X1.1/4*	10	U07840.062.0125	7/8-9X2 Inch*	5	U07840.087.0200
7/16-14X7/8*	50	U07840.043.0087	5/8-11X1.1/2*	10	U07840.062.0150	7/8-9X2.1/2*	1	U07840.087.0250
7/16-14X1 Inch*	50	U07840.043.0100	5/8-11X1.3/4*	10	U07840.062.0175	7/8-9X3 Inch*	1	U07840.087.0300
7/16-14X1.1/4*	25	U07840.043.0125	5/8-11X2 Inch*	10	U07840.062.0200	7/8-9X4 Inch*	1	U07840.087.0400
7/16-14X1.1/2*	25	U07840.043.0150	5/8-11X2.1/4*	10	U07840.062.0225			
7/16-14X1.3/4*	25	U07840.043.0175	5/8-11X2.1/2*	10	U07840.062.0250	1.-8X1 Inch*	1	U07840.100.0100
7/16-14X2 Inch*	10	U07840.043.0200	5/8-11X3 Inch*	5	U07840.062.0300	1.-8X1.1/2*	1	U07840.100.0150
7/16-14X2.1/4*	10	U07840.043.0225	5/8-11X3.1/2*	5	U07840.062.0350	1.-8X2 Inch*	1	U07840.100.0200
			5/8-11X4 Inch*	5	U07840.062.0400	1.-8X2.1/2*	1	U07840.100.0250
1/2-13X3/8*	50	U07840.050.0037				1.-8X3 Inch*	1	U07840.100.0300
1/2-13X7/16*	50	U07840.050.0043						
1/2-13X1/2*	50	U07840.050.0050						
1/2-13X5/8*	50	U07840.050.0062						

U51260 Wkręty dociskowe z gniazdem sześciokątnym z końcem wgłębionym UNC
X15A

Gwint Całowy, zunifikowany grubozwojny (UNC)
Materiał Stal nierdzewna A2 (AISI 304/18-8)



d x L	☒	Kod artykułu	d x L	☒	Kod artykułu	d x L	☒	Kod artykułu
NO.2-56X1/16	100	U51260.008.0006	NO.8-32X1/4*	100	U51260.016.0025	1/4-20X1 Inch*	50	U51260.025.0100
NO.2-56X3/32*	100	U51260.008.0009	NO.8-32X5/16*	100	U51260.016.0031			
NO.2-56X1/8*	100	U51260.008.0012	NO.8-32X3/8*	100	U51260.016.0037	5/16-18X1/4*	100	U51260.031.0025
NO.2-56X3/16*	100	U51260.008.0018	NO.8-32X7/16*	100	U51260.016.0043	5/16-18X5/16*	100	U51260.031.0031
NO.2-56X1/4*	100	U51260.008.0025	NO.8-32X1/2*	100	U51260.016.0050	5/16-18X3/8*	100	U51260.031.0037
						5/16-18X1/2*	100	U51260.031.0050
NO.3-48X3/32*	100	U51260.009.0009	NO.10-24X3/16*	100	U51260.019.0018	5/16-18X5/8*	100	U51260.031.0062
NO.3-48X1/8*	100	U51260.009.0012	NO.10-24X1/4*	100	U51260.019.0025	5/16-18X3/4*	50	U51260.031.0075
NO.3-48X3/16*	100	U51260.009.0018	NO.10-24X5/16*	100	U51260.019.0031	5/16-18X1 Inch*	50	U51260.031.0100
			NO.10-24X3/8*	100	U51260.019.0037			
NO.4-40X1/8*	100	U51260.011.0012	NO.10-24X1/2*	100	U51260.019.0050	3/8-16X5/16*	50	U51260.037.0031
NO.4-40X3/16*	100	U51260.011.0018	NO.10-24X5/8*	100	U51260.019.0062	3/8-16X3/8*	50	U51260.037.0037
NO.4-40X1/4*	100	U51260.011.0025	NO.10-24X3/4*	100	U51260.019.0075	3/8-16X1/2*	50	U51260.037.0050
						3/8-16X5/8*	50	U51260.037.0062
NO.6-32X1/8*	100	U51260.013.0012	1/4-20X3/16*	100	U51260.025.0018	3/8-16X3/4*	50	U51260.037.0075
NO.6-32X3/16*	100	U51260.013.0018	1/4-20X1/4*	100	U51260.025.0025	3/8-16X1 Inch*	50	U51260.037.0100
NO.6-32X1/4*	100	U51260.013.0025	1/4-20X5/16*	100	U51260.025.0031			
NO.6-32X5/16*	100	U51260.013.0031	1/4-20X3/8*	100	U51260.025.0037	1/2-13X1/2*	50	U51260.050.0050
NO.6-32X3/8*	100	U51260.013.0037	1/4-20X1/2*	100	U51260.025.0050	1/2-13X5/8*	25	U51260.050.0062
			1/4-20X5/8*	100	U51260.025.0062	1/2-13X3/4*	25	U51260.050.0075
NO.8-32X1/8*	100	U51260.016.0012	1/4-20X3/4*	100	U51260.025.0075	1/2-13X1 Inch*	25	U51260.050.0100
NO.8-32X3/16*	100	U51260.016.0018						

Wkręty dociskowe z końcem wgłębionym UNF

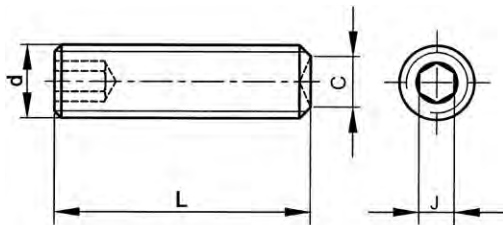

ASME ≈B18.3

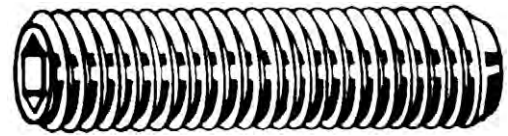

2

Informacje techniczne

d	C (maks.)	J	Zwoje gwintu na cal
No.4	0.061	0.05	48
No.5	0.067	1/16	44
No.6	0.074	1/16	40
No.8	0.087	5/64	36
No.10	0.102	3/32	32
1/4	0.132	1/8	28
5/16	0.172	5/32	24
3/8	0.212	3/16	24
7/16	0.252	7/32	20
1/2	0.291	1/4	20
5/8	0.371	5/16	18
3/4	0.450	3/8	16

Grupy katalogowe

Gwint	Gniazdo	Materiał	Kod	Strona
UNF	Gniazdo sześciokątne	St	U07852	2-75
UNF	Gniazdo sześciokątne	St.St. A2 (AISI304/18-8)	U51261	2-76

U07852 Wkręty dociskowe z końcem wgłębionym UNF

X05A

Gwint Calowy, zunifikowany drobnozwojny (UNF)
Materiał Stal



d x L	☒	Kod artykułu	d x L	☒	Kod artykułu	d x L	☒	Kod artykułu
NO.4-48X1/8*	100	U07852.011.0012	NO.10-32X1.3/4*	100	U07852.019.0175	3/8-24X3/4*	100	U07852.037.0075
NO.4-48X3/16*	100	U07852.011.0018	NO.10-32X2 Inch*	50	U07852.019.0200	3/8-24X1 Inch*	100	U07852.037.0100
NO.4-48X1/4*	100	U07852.011.0025				3/8-24X1.1/4*	100	U07852.037.0125
NO.4-48X1/2*	100	U07852.011.0050	1/4-28X3/16*	100	U07852.025.0018	3/8-24X1.1/2*	50	U07852.037.0150
			1/4-28X1/4*	100	U07852.025.0025	3/8-24X1.3/4*	50	U07852.037.0175
NO.5-44X1/8*	100	U07852.012.0012	1/4-28X5/16*	100	U07852.025.0031	3/8-24X2 Inch*	25	U07852.037.0200
NO.5-44X3/16*	100	U07852.012.0018	1/4-28X3/8*	100	U07852.025.0037	3/8-24X2.1/2*	25	U07852.037.0250
NO.5-44X1/4*	100	U07852.012.0025	1/4-28X1/2*	100	U07852.025.0050			
			1/4-28X5/8*	100	U07852.025.0062	7/16-20X3/8*	50	U07852.043.0037
NO.6-40X1/8*	100	U07852.013.0012	1/4-28X3/4*	100	U07852.025.0075	7/16-20X7/16*	50	U07852.043.0043
NO.6-40X3/16*	100	U07852.013.0018	1/4-28X1 Inch*	100	U07852.025.0100	7/16-20X1/2*	50	U07852.043.0050
NO.6-40X1/4*	100	U07852.013.0025	1/4-28X1.1/4*	100	U07852.025.0125	7/16-20X5/8*	50	U07852.043.0062
NO.6-40X5/16*	100	U07852.013.0031	1/4-28X1.1/2*	100	U07852.025.0150	7/16-20X3/4*	50	U07852.043.0075
NO.6-40X3/8*	100	U07852.013.0037	1/4-28X1.3/4*	100	U07852.025.0175	7/16-20X7/8*	50	U07852.043.0087
NO.6-40X1/2*	100	U07852.013.0050	1/4-28X2 Inch*	100	U07852.025.0200	7/16-20X1 Inch*	50	U07852.043.0100
			1/4-28X2.1/2*	50	U07852.025.0250	7/16-20X1.1/4*	25	U07852.043.0125
						7/16-20X1.1/2*	25	U07852.043.0150
NO.8-36X1/8*	100	U07852.016.0012				7/16-20X1.3/4*	25	U07852.043.0175
NO.8-36X3/16*	100	U07852.016.0018	5/16-24X1/4*	100	U07852.031.0025	7/16-20X2 Inch*	10	U07852.043.0200
NO.8-36X1/4*	100	U07852.016.0025	5/16-24X5/16*	100	U07852.031.0031			
NO.8-36X5/16*	100	U07852.016.0031	5/16-24X3/8*	100	U07852.031.0037			
NO.8-36X3/8*	100	U07852.016.0037	5/16-24X1/2*	100	U07852.031.0050	1/2-20X3/8*	25	U07852.050.0037
NO.8-36X1/2*	100	U07852.016.0050	5/16-24X5/8*	100	U07852.031.0062	1/2-20X1/2*	50	U07852.050.0050
			5/16-24X3/4*	100	U07852.031.0075	1/2-20X5/8*	50	U07852.050.0062
NO.10-32X1/8*	100	U07852.019.0012	5/16-24X1 Inch*	100	U07852.031.0100	1/2-20X3/4*	25	U07852.050.0075
NO.10-32X3/16*	100	U07852.019.0018	5/16-24X1.1/4*	100	U07852.031.0125	1/2-20X1 Inch*	25	U07852.050.0100
NO.10-32X1/4*	100	U07852.019.0025	5/16-24X1.1/2*	100	U07852.031.0150	1/2-20X1.1/4*	25	U07852.050.0125
NO.10-32X5/16*	100	U07852.019.0031	5/16-24X1.3/4*	100	U07852.031.0175	1/2-20X1.1/2*	10	U07852.050.0150
NO.10-32X3/8*	100	U07852.019.0037	5/16-24X2 Inch*	100	U07852.031.0200	1/2-20X1.3/4*	25	U07852.050.0175
NO.10-32X1/2*	100	U07852.019.0050	5/16-24X2.1/2*	50	U07852.031.0250	1/2-20X2 Inch*	10	U07852.050.0200
NO.10-32X5/8*	100	U07852.019.0062				1/2-20X2.1/2*	10	U07852.050.0250
NO.10-32X3/4*	100	U07852.019.0075	3/8-24X1/4*	100	U07852.037.0025	1/2-20X3 Inch*	10	U07852.050.0300
NO.10-32X7/8*	100	U07852.019.0087	3/8-24X5/16*	100	U07852.037.0031			
NO.10-32X1 Inch*	100	U07852.019.0100	3/8-24X3/8*	100	U07852.037.0037	5/8-18X1/2*	10	U07852.062.0050
NO.10-32X1.1/4*	100	U07852.019.0125	3/8-24X1/2*	100	U07852.037.0050	5/8-18X5/8*	10	U07852.062.0062
NO.10-32X1.1/2*	100	U07852.019.0150	3/8-24X5/8*	100	U07852.037.0062	5/8-18X3/4*	10	U07852.062.0075

U07852 Wkręty dociskowe z końcem wgłębnym UNF								
d x L	☒	Kod artykułu	d x L	☒	Kod artykułu	d x L	☒	Kod artykułu
5/8-18X1 Inch*	10	U07852.062.0100				3/4-16X1.3/4*	5	U07852.075.0175
5/8-18X1.1/2*	10	U07852.062.0150	3/4-16X3/4*	5	U07852.075.0075	3/4-16X2 Inch*	5	U07852.075.0200
5/8-18X2 Inch*	10	U07852.062.0200	3/4-16X1 Inch*	5	U07852.075.0100	3/4-16X2.1/2*	5	U07852.075.0250
5/8-18X2.1/2*	10	U07852.062.0250	3/4-16X1.1/2*	5	U07852.075.0150	3/4-16X3 Inch*	5	U07852.075.0300

U51261 Wkręty dociskowe z końcem wgłębnym UNF		X15A
Gwint	Całowy, zunifikowany drobnozwojny (UNF)	
Materiał	Stal nierdzewna A2 (AISI 304/18-8)	
		
		

d x L	☒	Kod artykułu	d x L	☒	Kod artykułu	d x L	☒	Kod artykułu
NO.10-32X3/16*	100	U51261.019.0018	NO.10-32X3/8*	100	U51261.019.0037	NO.10-32X5/8*	100	U51261.019.0062
NO.10-32X1/4*	100	U51261.019.0025	NO.10-32X1/2*	100	U51261.019.0050	NO.10-32X3/4*	100	U51261.019.0075
NO.10-32X5/16*	100	U51261.019.0031						

Wkręty dociskowe z gniazdem sześciokątnym z radełkowanym końcem wgłębnym, metryczne

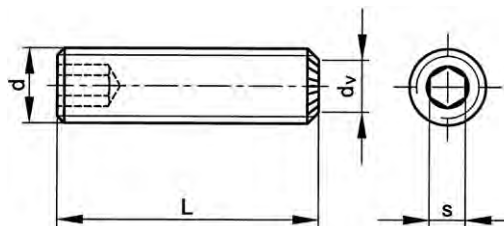

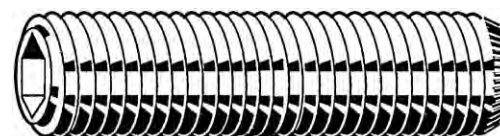

DIN ≈916
ISO ≈4029
NEN ≈2343
ASME ≈B18.3.6M
NF ≈E27-183
BS ≈4168-5



Informacje techniczne

d	d _v	P	s	d	d _v	P	s
M3	1.4	0.5	1.5	M6	3	1	3
M4	2	0.7	2	M8	5	1.25	4
M5	2.5	0.8	2.5				

07890 Wkręty dociskowe z gniazdem sześciokątnym z radełkowanym końcem wgłębnym, metryczne		D05A
Gwint	Metryczny	
Materiał	Stal	
Klasa	45H	
		
		

d x L	☒	Kod artykułu	d x L	☒	Kod artykułu	d x L	☒	Kod artykułu
M3X4	200	07890.030.004	M5X5	200	07890.050.005	M6X12	200	07890.060.012
M3X5	200	07890.030.005	M5X6	200	07890.050.006	M6X16	200	07890.060.016
M3X6	200	07890.030.006	M5X8	200	07890.050.008	M6X20	200	07890.060.020
M3X8	200	07890.030.008	M5X10	200	07890.050.010	M6X25	200	07890.060.025
M3X10	200	07890.030.010	M5X12	200	07890.050.012	M8X8	200	07890.080.008
M4X5	200	07890.040.005	M5X16	200	07890.050.016	M8X10	200	07890.080.010
M4X6	200	07890.040.006	M5X20	200	07890.050.020	M8X12	200	07890.080.012
M4X8	200	07890.040.008				M8X16	200	07890.080.016
M4X10	200	07890.040.010	M6X6	200	07890.060.006	M8X20	200	07890.080.020
M4X12	200	07890.040.012	M6X8	200	07890.060.008	M8X25	200	07890.080.025
M4X16	200	07890.040.016	M6X10	200	07890.060.010	M8X30	200	07890.080.030

• Ostrzeżenie: cynkowanie elektrolityczne tych produktów może wywołać kruchość wodorową.

Wkręty dociskowe radełkowane UNC

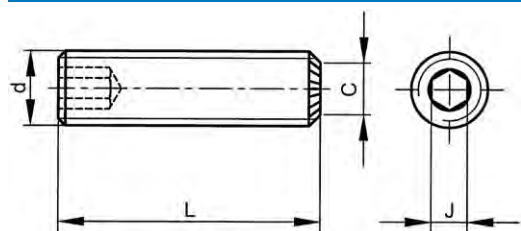

ASME ≈B18.3

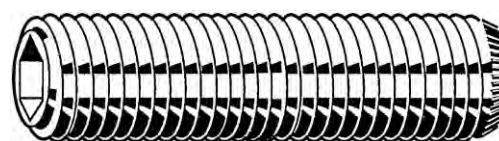

2

Informacje techniczne

d	C (maks.)	J	Zwoje gwintu na cal
No.4	0.054	0.05	40
No.6	0.074	1/16	32
No.8	0.087	5/64	32
No.10	0.102	3/32	24
1/4	0.132	1/8	20
5/16	0.172	5/32	18
3/8	0.212	3/16	16
1/2	0.291	1/4	13

U07890 Wkręty dociskowe z końcem wgłębionym i radełkowaną końcówką UNC

X05A

Gwint Calowy, zunifikowany grubozwojny (UNC)
Material Stal



d x L	☒	Kod artykułu	d x L	☒	Kod artykułu	d x L	☒	Kod artykułu
NO.4-40X1/8*	100	U07890.011.0012	NO.10-24X1/4*	100	U07890.019.0025	5/16-18X5/16*	100	U07890.031.0031
NO.6-32X1/8*	100	U07890.013.0012	NO.10-24X5/16*	100	U07890.019.0031	5/16-18X3/8*	100	U07890.031.0037
NO.6-32X3/16*	100	U07890.013.0018	NO.10-24X3/8*	100	U07890.019.0037	5/16-18X1/2*	100	U07890.031.0050
NO.6-32X1/4*	100	U07890.013.0025	NO.10-24X1/2*	100	U07890.019.0050	5/16-18X5/8*	100	U07890.031.0062
NO.6-32X5/16*	100	U07890.013.0031	NO.10-24X3/4*	100	U07890.019.0075	5/16-18X3/4*	100	U07890.031.0075
NO.6-32X3/8*	100	U07890.013.0037	NO.10-24X1 Inch*	100	U07890.019.0100	5/16-18X1 Inch*	100	U07890.031.0100
NO.6-32X1/2*	100	U07890.013.0050	1/4-20X3/16*	100	U07890.025.0018	3/8-16X3/8*	100	U07890.037.0037
NO.8-32X1/8*	100	U07890.016.0012	1/4-20X1/4*	100	U07890.025.0025	3/8-16X1/2*	100	U07890.037.0050
NO.8-32X3/16*	100	U07890.016.0018	1/4-20X5/16*	100	U07890.025.0031	3/8-16X5/8*	100	U07890.037.0062
NO.8-32X1/4*	100	U07890.016.0025	1/4-20X3/8*	100	U07890.025.0037	3/8-16X3/4*	100	U07890.037.0075
NO.8-32X5/16*	100	U07890.016.0031	1/4-20X1/2*	100	U07890.025.0050	3/8-16X1 Inch*	100	U07890.037.0100
NO.8-32X3/8*	100	U07890.016.0037	1/4-20X5/8*	100	U07890.025.0062	1/2-13X1/2*	50	U07890.050.0050
NO.8-32X1/2*	100	U07890.016.0050	1/4-20X3/4*	100	U07890.025.0075	1/2-13X5/8*	25	U07890.050.0062
NO.8-32X5/8*	100	U07890.016.0062	1/4-20X1 Inch*	100	U07890.025.0100	1/2-13X3/4*	25	U07890.050.0075
NO.8-32X3/4*	100	U07890.016.0075	1/4-20X1.1/4*	100	U07890.025.0125	1/2-13X1 Inch*	25	U07890.050.0100
NO.10-24X3/16*	100	U07890.019.0018	5/16-18X1/4*	100	U07890.031.0025	1/2-13X1.1/4*	25	U07890.050.0125

Wkręty dociskowe radełkowane UNF

2

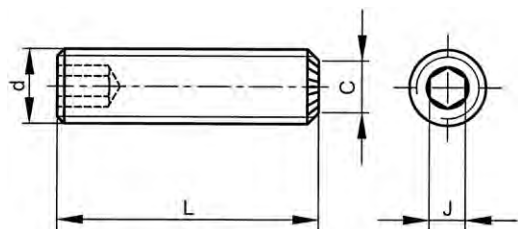

ASME ≈B18.3

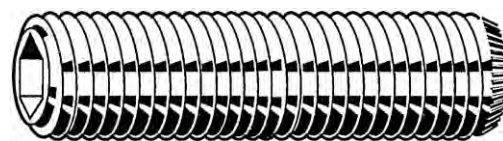

Informacje techniczne

d	C (maks.)	J	Zwoje gwintu na cal
No.10	0.102	3/32	32
1/4	0.132	1/8	28
5/16	0.172	5/32	24
3/8	0.212	3/16	24

U07891 Wkręty dociskowe z końcem wgłębionym i radełkowaną końcówką UNF

X05A

Gwint: Całowy, zunifikowany drobnozwojny (UNF)
 Materiał: Stal



d x L	☒	Kod artykułu	d x L	☒	Kod artykułu	d x L	☒	Kod artykułu
NO.10-32X3/16*	100	U07891.019.0018	1/4-28X5/16*	100	U07891.025.0031	5/16-24X5/8*	100	U07891.031.0062
NO.10-32X1/4*	100	U07891.019.0025	1/4-28X3/8*	100	U07891.025.0037	5/16-24X3/4*	100	U07891.031.0075
NO.10-32X5/16*	100	U07891.019.0031	1/4-28X1/2*	100	U07891.025.0050			
NO.10-32X3/8*	100	U07891.019.0037				3/8-24X3/8*	100	U07891.037.0037
NO.10-32X1/2*	100	U07891.019.0050	5/16-24X1/4*	100	U07891.031.0025	3/8-24X1/2*	100	U07891.037.0050
			5/16-24X5/16*	100	U07891.031.0031	3/8-24X5/8*	100	U07891.037.0062
1/4-28X3/16*	100	U07891.025.0018	5/16-24X3/8*	100	U07891.031.0037	3/8-24X3/4*	50	U07891.037.0075
1/4-28X1/4*	100	U07891.025.0025	5/16-24X1/2*	100	U07891.031.0050			

Wkręty dociskowe z gniazdem sześciokątnym z końcem płaskim

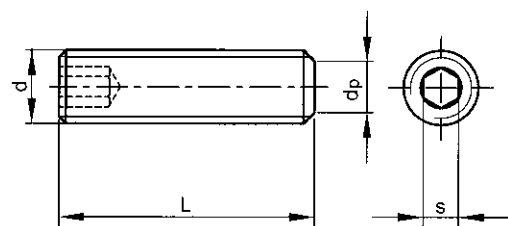

DIN 913
 ISO 4026
 NEN 2341
 ASME B18.3.6M
 NF E27-180
 BS 4168-2



Informacje techniczne

d	d _p (maks.)	P	s	d	d _p (maks.)	P	s
M1.6	0.8	0.35	0.7	M6	4	1	3
M2	1	0.4	0.9	M8	5.5	1.25	4
M2.5	1.5	0.45	1.3	M10	7	1.5	5
M3	2	0.5	1.5	M12	8.5	1.75	6
M4	2.5	0.7	2	M16	12	2	8
M5	3.5	0.8	2.5	M20	15	2.5	10

Grupy katalogowe

Gwint	Gniazdo	Materiał	Klasa	Obróbka powierzchni	Kod	Strona
M	Gniazdo sześciokątne	St	45H		07810	2-79
M	Gniazdo sześciokątne	St	45H	Ocynk.	07860	2-79
M	Gniazdo sześciokątne	St.St. A2			51240	2-80
M	Gniazdo sześciokątne	St.St. A4			55240	2-80

07810		Wkręty dociskowe z gniazdem sześciokątnym z końcem płaskim		D05A	
Gwint	Metryczny				
Materiał	Stal				
Klasa	45H				

d x L	☒	Kod artykułu	d x L	☒	Kod artykułu	d x L	☒	Kod artykułu
M3X3	200	07810.030.003	M6X8	200	07810.060.008	M10X40	100	07810.100.040
M3X4	200	07810.030.004	M6X10	200	07810.060.010	M10X50	100	07810.100.050
M3X5	200	07810.030.005	M6X12	200	07810.060.012	M10X60	100	07810.100.060
M3X6	200	07810.030.006	M6X16	200	07810.060.016	M10X70	100	07810.100.070
M3X8	200	07810.030.008	M6X20	200	07810.060.020	M10X80	100	07810.100.080
M3X10	200	07810.030.010	M6X25	200	07810.060.025	M10X100	50	07810.100.100
M3X12	200	07810.030.012	M6X30	200	07810.060.030			
M3X16	200	07810.030.016	M6X35	200	07810.060.035	M12X12	100	07810.120.012
M3X20	200	07810.030.020	M6X40	200	07810.060.040	M12X16	100	07810.120.016
			M6X45	200	07810.060.045	M12X20	100	07810.120.020
M4X4	200	07810.040.004	M6X50	200	07810.060.050	M12X25	100	07810.120.025
M4X5	200	07810.040.005				M12X30	100	07810.120.030
M4X6	200	07810.040.006	M8X6	200	07810.080.006	M12X35	100	07810.120.035
M4X8	200	07810.040.008	M8X8	200	07810.080.008	M12X40	100	07810.120.040
M4X10	200	07810.040.010	M8X10	200	07810.080.010	M12X50	100	07810.120.050
M4X12	200	07810.040.012	M8X12	200	07810.080.012	M12X60	25	07810.120.060
M4X16	200	07810.040.016	M8X16	200	07810.080.016	M12X70	100	07810.120.070
M4X20	200	07810.040.020	M8X20	200	07810.080.020			
M4X25	200	07810.040.025	M8X25	200	07810.080.025	M16X16	50	07810.160.016
M4X30	200	07810.040.030	M8X30	200	07810.080.030	M16X20	50	07810.160.020
			M8X35	100	07810.080.035	M16X25	50	07810.160.025
M5X5	200	07810.050.005	M8X40	100	07810.080.040	M16X30	50	07810.160.030
M5X6	200	07810.050.006	M8X50	100	07810.080.050	M16X35	50	07810.160.035
M5X8	200	07810.050.008	M8X60	100	07810.080.060	M16X40	50	07810.160.040
M5X10	200	07810.050.010	M8X70	100	07810.080.070	M16X50	50	07810.160.050
M5X12	200	07810.050.012	M8X80	100	07810.080.080	M16X60	25	07810.160.060
M5X16	200	07810.050.016				M16X70	100	07810.160.070
M5X20	200	07810.050.020	M10X10	25	07810.100.010	M16X80	25	07810.160.080
M5X25	200	07810.050.025	M10X12	200	07810.100.012	M16X90	25	07810.160.090
M5X30	200	07810.050.030	M10X16	200	07810.100.016	M16X100	25	07810.160.100
M5X35	100	07810.050.035	M10X20	200	07810.100.020			
M5X40	100	07810.050.040	M10X25	100	07810.100.025	M20X20	10	07810.200.020
M6X6	200	07810.060.006	M10X30	100	07810.100.030	M20X25	10	07810.200.025

• Ostrzeżenie: cynkowanie elektrolityczne tych produktów może wywołać kruchość wodorową.



07860		Wkręty dociskowe z gniazdem sześciokątnym z końcem płaskim		D05A	
Gwint	Metryczny				
Materiał	Stal				
Klasa	45H				
Obróbka powierzchni	Ocynkowane				

d x L	☒	Kod artykułu	d x L	☒	Kod artykułu	d x L	☒	Kod artykułu
M3X6	200	07860.030.006	M5X20	200	07860.050.020	M8X30	200	07860.080.030
M3X8	200	07860.030.008	M5X25	200	07860.050.025	M8X40	100	07860.080.040
M3X10	200	07860.030.010						
M3X12	200	07860.030.012	M6X6	200	07860.060.006	M10X10	200	07860.100.010
			M6X8	200	07860.060.008	M10X12	200	07860.100.012
M4X4	200	07860.040.004	M6X10	200	07860.060.010	M10X16	200	07860.100.016
M4X5	200	07860.040.005	M6X12	200	07860.060.012	M10X20	200	07860.100.020
M4X6	200	07860.040.006	M6X16	200	07860.060.016	M10X25	100	07860.100.025
M4X8	200	07860.040.008	M6X20	200	07860.060.020	M10X30	100	07860.100.030
M4X10	200	07860.040.010	M6X25	200	07860.060.025	M10X40	100	07860.100.040
M4X12	200	07860.040.012	M6X30	200	07860.060.030	M10X50	100	07860.100.050
M4X16	200	07860.040.016						
M4X20	200	07860.040.020	M8X8	200	07860.080.008	M12X12	100	07860.120.012
			M8X10	200	07860.080.010	M12X16	100	07860.120.016
M5X6	200	07860.050.006	M8X12	200	07860.080.012	M12X20	100	07860.120.020
M5X8	200	07860.050.008	M8X16	200	07860.080.016	M12X25	100	07860.120.025
M5X10	200	07860.050.010	M8X20	200	07860.080.020	M12X30	100	07860.120.030
M5X12	200	07860.050.012	M8X25	200	07860.080.025	M12X40	100	07860.120.040
M5X16	200	07860.050.016						

• Ostrzeżenie: cynkowanie elektrolityczne tych produktów może wywołać kruchość wodorową.

51240 Wkręty dociskowe z gniazdem sześciokątnym z końcem płaskim R03A



Gwint Metryczny
Materiał Stal nierdzewna A2

d x L	☒	Kod artykułu	d x L	☒	Kod artykułu	d x L	☒	Kod artykułu
M1,6X2*	200	51240.016.002	M5X5	500	51240.050.005	M10X30	100	51240.100.030
M1,6X3	200	51240.016.003	M5X6	200	51240.050.006	M10X35*	100	51240.100.035
M1,6X6*	200	51240.016.006	M5X8	200	51240.050.008	M10X40	100	51240.100.040
M2X2	500	51240.020.002	M5X10	200	51240.050.010	M10X45*	100	51240.100.045
M2X3*	500	51240.020.003	M5X12	200	51240.050.012	M10X50*	100	51240.100.050
M2X4	200	51240.020.004	M5X14*	500	51240.050.014	M10X60*	100	51240.100.060
M2X5*	500	51240.020.005	M5X16	200	51240.050.016	M10X70*	100	51240.100.070
M2X6*	500	51240.020.006	M5X20	200	51240.050.020	M10X80	100	51240.100.080
M2X8*	500	51240.020.008	M5X25*	200	51240.050.025	M10X90*	100	51240.100.090
M2X10*	500	51240.020.010	M5X30*	200	51240.050.030	M12X12*	100	51240.120.012
M2X12*	500	51240.020.012	M5X35*	200	51240.050.035	M12X16*	100	51240.120.016
M2X16*	500	51240.020.016	M5X40*	200	51240.050.040	M12X20*	100	51240.120.020
M2,5X3*	500	51240.025.003	M6X5	200	51240.060.005	M12X25*	100	51240.120.025
M2,5X4	500	51240.025.004	M6X6	200	51240.060.006	M12X30*	100	51240.120.030
M2,5X5*	500	51240.025.005	M6X8	200	51240.060.008	M12X35*	100	51240.120.035
M2,5X6*	500	51240.025.006	M6X10	200	51240.060.010	M12X40*	100	51240.120.040
M2,5X8*	500	51240.025.008	M6X12	200	51240.060.012	M12X45*	100	51240.120.045
M2,5X10*	500	51240.025.010	M6X14*	200	51240.060.014	M12X50*	100	51240.120.050
M2,5X12*	500	51240.025.012	M6X16	200	51240.060.016	M12X55*	100	51240.120.055
M2,5X16*	500	51240.025.016	M6X20	200	51240.060.020	M12X60*	100	51240.120.060
M3X3	200	51240.030.003	M6X25	200	51240.060.025	M12X70	50	51240.120.070
M3X4*	500	51240.030.004	M6X30	200	51240.060.030	M12X80*	50	51240.120.080
M3X5*	500	51240.030.005	M6X35*	200	51240.060.035	M12X90*	50	51240.120.090
M3X6	200	51240.030.006	M6X40*	200	51240.060.040	M16X16*	50	51240.160.016
M3X8	200	51240.030.008	M6X45*	200	51240.060.045	M16X20*	50	51240.160.020
M3X10	200	51240.030.010	M6X50*	200	51240.060.050	M16X25*	50	51240.160.025
M3X12*	500	51240.030.012	M6X60*	200	51240.060.060	M16X30*	50	51240.160.030
M3X14*	500	51240.030.014	M6X70*	200	51240.060.070	M16X35*	50	51240.160.035
M3X16	200	51240.030.016	M8X6	200	51240.080.006	M16X40*	50	51240.160.040
M3X20*	500	51240.030.020	M8X8	200	51240.080.008	M16X45*	50	51240.160.045
M3X25*	500	51240.030.025	M8X10	200	51240.080.010	M16X50*	50	51240.160.050
M3X30*	200	51240.030.030	M8X12	200	51240.080.012	M16X60*	50	51240.160.060
M3X40*	200	51240.030.040	M8X16	200	51240.080.016	M16X70*	50	51240.160.070
M4X3*	500	51240.040.003	M8X20	200	51240.080.020	M16X80*	25	51240.160.080
M4X4	200	51240.040.004	M8X25	100	51240.080.025	M16X90*	25	51240.160.090
M4X5	200	51240.040.005	M8X30	100	51240.080.030	M16X100*	25	51240.160.100
M4X6	200	51240.040.006	M8X35*	200	51240.080.035	M20X20*	50	51240.200.020
M4X8	200	51240.040.008	M8X40	100	51240.080.040	M20X25*	50	51240.200.025
M4X10	200	51240.040.010	M8X45*	200	51240.080.045	M20X30*	50	51240.200.030
M4X12	200	51240.040.012	M8X50	200	51240.080.050	M20X35*	50	51240.200.035
M4X16	200	51240.040.016	M8X60*	200	51240.080.060	M20X40*	50	51240.200.040
M4X20	200	51240.040.020	M8X70*	200	51240.080.070	M20X45*	50	51240.200.045
M4X25*	500	51240.040.025	M8X80*	200	51240.080.080	M20X50*	50	51240.200.050
M4X30	200	51240.040.030	M10X10	100	51240.100.010	M20X60*	50	51240.200.060
M4X40*	200	51240.040.040	M10X12	100	51240.100.012	M20X70*	25	51240.200.070
M5X4	500	51240.050.004	M10X16	100	51240.100.016	M20X80*	25	51240.200.080
			M10X20	100	51240.100.020	M20X90*	25	51240.200.090
			M10X25	100	51240.100.025	M20X100*	25	51240.200.100

55240 Wkręty dociskowe z gniazdem sześciokątnym z końcem płaskim R43A

Gwint Metryczny
Materiał Stal nierdzewna A4

d x L	☒	Kod artykułu	d x L	☒	Kod artykułu	d x L	☒	Kod artykułu
M3X4*	500	55240.030.004	M4X8	200	55240.040.008	M5X12	200	55240.050.012
M3X5	500	55240.030.005	M4X10	200	55240.040.010	M5X16	200	55240.050.016
M3X6	200	55240.030.006	M4X12	200	55240.040.012	M5X20	200	55240.050.020
M3X8	200	55240.030.008	M4X16	200	55240.040.016	M5X25	200	55240.050.025
M3X10	200	55240.030.010	M4X20	200	55240.040.020	M5X30	200	55240.050.030
M3X12	200	55240.030.012	M4X25	200	55240.040.025	M5X35*	200	55240.050.035
M3X16	200	55240.030.016	M4X30*	200	55240.040.030	M5X40*	200	55240.050.040
M3X20	200	55240.030.020	M5X5	500	55240.050.005	M6X6	200	55240.060.006
M4X4	200	55240.040.004	M5X6	200	55240.050.006	M6X8	200	55240.060.008
M4X5	200	55240.040.005	M5X8	200	55240.050.008	M6X10	200	55240.060.010
M4X6	200	55240.040.006	M5X10	200	55240.050.010	M6X12	200	55240.060.012

55240 Wkręty dociskowe z gniazdem sześciokątnym z końcem płaskim								
d x L	☒	Kod artykułu	d x L	☒	Kod artykułu	d x L	☒	Kod artykułu
M6X14*	200	55240.060.014	M8X50*	200	55240.080.050	M12X40	100	55240.120.040
M6X16	200	55240.060.016	M8X60*	200	55240.080.060	M12X45*	100	55240.120.045
M6X20	200	55240.060.020				M12X50*	100	55240.120.050
M6X25	200	55240.060.025	M10X10*	200	55240.100.010	M12X60*	100	55240.120.060
M6X30	200	55240.060.030	M10X12	100	55240.100.012	M12X70*	50	55240.120.070
M6X35*	200	55240.060.035	M10X16	100	55240.100.016			
M6X40*	200	55240.060.040	M10X20	100	55240.100.020	M16X16*	50	55240.160.016
M6X45*	200	55240.060.045	M10X25	100	55240.100.025	M16X20*	50	55240.160.020
M6X50*	200	55240.060.050	M10X30	100	55240.100.030	M16X25*	50	55240.160.025
M6X60*	200	55240.060.060	M10X35*	100	55240.100.035	M16X30*	50	55240.160.030
			M10X40	100	55240.100.040	M16X35*	50	55240.160.035
M8X8	200	55240.080.008	M10X45*	100	55240.100.045	M16X40*	50	55240.160.040
M8X10	200	55240.080.010	M10X50	100	55240.100.050	M16X45*	50	55240.160.045
M8X12	200	55240.080.012	M10X60*	100	55240.100.060	M16X50*	50	55240.160.050
M8X16	200	55240.080.016				M16X60	50	55240.160.060
M8X20	200	55240.080.020	M12X12*	100	55240.120.012			
M8X25	100	55240.080.025	M12X16	100	55240.120.016	M20X25*	50	55240.200.025
M8X30	100	55240.080.030	M12X20	100	55240.120.020	M20X30*	50	55240.200.030
M8X35*	200	55240.080.035	M12X25	100	55240.120.025	M20X40*	50	55240.200.040
M8X40	100	55240.080.040	M12X30	100	55240.120.030	M20X50*	50	55240.200.050
M8X45*	200	55240.080.045	M12X35*	100	55240.120.035	M20X60*	50	55240.200.060

Wkręty dociskowe z gniazdem sześciokątnym z końcem płaskim

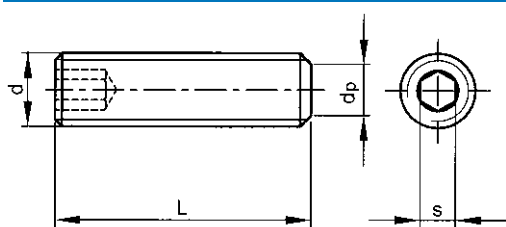

DIN ≈913
 ISO ≈4026
 NEN ≈2341
 ASME ≈B18.3.6M
 NF ≈E27-180
 BS ≈4168-2



Informacje techniczne

d	d _p (maks.)	s	d	d _p (maks.)	s
M8	5.5	4	M12	8.5	6
M10	7	5	M16	12	8

07812 Wkręty dociskowe z gniazdem sześciokątnym z końcem płaskim

D93A

Gwint Metryczny drobnoszwojny
Materiał Stal
Klasa 45H



d x P x L	☒	Kod artykułu	d x P x L	☒	Kod artykułu	d x P x L	☒	Kod artykułu
M8X1,00X10	200	07812.080.010	M10X1,25X16	100	07812.100.016	M12X1,50X25	100	07812.120.025
M8X1,00X12	200	07812.080.012	M10X1,25X20	100	07812.100.020	M12X1,50X30	100	07812.120.030
M8X1,00X16	200	07812.080.016	M10X1,25X25	100	07812.100.025	M12X1,50X40	100	07812.120.040
M8X1,00X20	200	07812.080.020	M10X1,25X30	100	07812.100.030	M12X1,50X50	100	07812.120.050
M8X1,00X25	100	07812.080.025	M10X1,25X40	100	07812.100.040			
M8X1,00X30	100	07812.080.030	M10X1,25X50	100	07812.100.050	M16X1,50X20	50	07812.160.020
M8X1,00X40	100	07812.080.040				M16X1,50X25	50	07812.160.025
M8X1,00X50	100	07812.080.050	M12X1,50X10	100	07812.120.010	M16X1,50X30	50	07812.160.030
			M12X1,50X12	100	07812.120.012	M16X1,50X40	50	07812.160.040
M10X1,25X10	100	07812.100.010	M12X1,50X16	100	07812.120.016	M16X1,50X50	50	07812.160.050
M10X1,25X12	100	07812.100.012	M12X1,50X20	100	07812.120.020			

• Ostrzeżenie: cynkowanie elektrolityczne tych produktów może wywołać kruchość wodorową.

Wkręty dociskowe z końcem płaskim UNC

ASME ≈B18.3

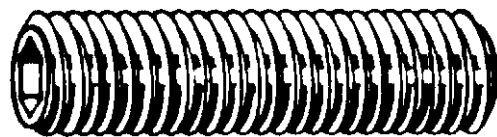
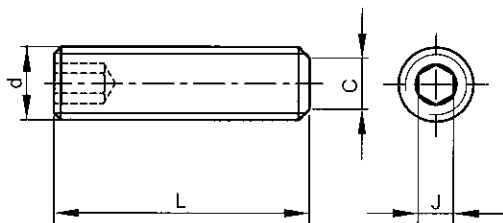

2

Informacje techniczne

d	C (maks.)	J	Zwoje gwintu na cal
No.4	0.061	0.05	40
No.5	0.067	1/16	40
No.6	0.074	1/16	32
No.8	0.087	5/64	32
No.10	0.102	3/32	24
1/4	0.132	1/8	20
5/16	0.172	5/32	18
3/8	0.212	3/16	16
7/16	0.252	7/32	14
1/2	0.291	1/4	13
5/8	0.371	5/16	11

U07810 Wkręty dociskowe z końcem płaskim UNC

X05A

Gwint Calowy, zunifikowany grubozwojny (UNC)
 Materiał Stal



d x L	☒	Kod artykułu	d x L	☒	Kod artykułu	d x L	☒	Kod artykułu
NO.4-40X1/8*	100	U07810.011.0012	NO.10-24X3/4*	100	U07810.019.0075	3/8-16X1 Inch*	100	U07810.037.0100
NO.4-40X3/16*	100	U07810.011.0018	NO.10-24X1 Inch*	100	U07810.019.0100	3/8-16X1.1/4*	100	U07810.037.0125
NO.4-40X1/4*	100	U07810.011.0025	NO.10-24X1.1/4*	100	U07810.019.0125	3/8-16X1.1/2*	50	U07810.037.0150
NO.4-40X3/8*	100	U07810.011.0037	NO.10-24X1.1/2*	100	U07810.019.0150	3/8-16X1.3/4*	50	U07810.037.0175
NO.5-40X1/8*	100	U07810.012.0012	1/4-20X3/16*	100	U07810.025.0018	3/8-16X2 Inch*	25	U07810.037.0200
NO.5-40X3/16*	100	U07810.012.0018	1/4-20X5/16*	100	U07810.025.0031	3/8-16X2.1/2*	25	U07810.037.0250
NO.5-40X1/4*	100	U07810.012.0025	1/4-20X3/8*	100	U07810.025.0037	7/16-14X3/8*	50	U07810.043.0037
NO.5-40X3/8*	100	U07810.012.0037	1/4-20X1/2*	100	U07810.025.0050	7/16-14X5/8*	50	U07810.043.0062
NO.5-40X1/2*	100	U07810.012.0050	1/4-20X5/8*	100	U07810.025.0062	7/16-14X3/4*	50	U07810.043.0075
NO.6-32X1/8*	100	U07810.013.0012	1/4-20X3/4*	100	U07810.025.0075	7/16-14X1 Inch*	50	U07810.043.0100
NO.6-32X3/16*	100	U07810.013.0018	1/4-20X1 Inch*	100	U07810.025.0100	1/2-13X3/8*	50	U07810.050.0037
NO.6-32X1/4*	100	U07810.013.0025	1/4-20X1.1/4*	100	U07810.025.0125	1/2-13X1/2*	50	U07810.050.0050
NO.6-32X5/16*	100	U07810.013.0031	1/4-20X1.1/2*	100	U07810.025.0150	1/2-13X5/8*	50	U07810.050.0062
NO.6-32X3/8*	100	U07810.013.0037	1/4-20X1.3/4*	100	U07810.025.0175	1/2-13X3/4*	25	U07810.050.0075
NO.6-32X1/2*	100	U07810.013.0050	1/4-20X2 Inch*	100	U07810.025.0200	1/2-13X1 Inch*	25	U07810.050.0100
NO.6-32X5/8*	100	U07810.013.0062	5/16-18X3/16*	100	U07810.031.0018	1/2-13X1.1/4*	25	U07810.050.0125
NO.6-32X3/4*	100	U07810.013.0075	5/16-18X1/4*	100	U07810.031.0025	1/2-13X1.1/2*	25	U07810.050.0150
NO.6-32X1 Inch*	100	U07810.013.0100	5/16-18X5/16*	100	U07810.031.0031	1/2-13X1.3/4*	25	U07810.050.0175
NO.8-32X1/8*	50	U07810.016.0012	5/16-18X3/8*	100	U07810.031.0037	1/2-13X2 Inch*	10	U07810.050.0200
NO.8-32X3/16*	100	U07810.016.0018	5/16-18X1/2*	100	U07810.031.0050	1/2-13X2.1/2*	10	U07810.050.0250
NO.8-32X1/4*	100	U07810.016.0025	5/16-18X5/8*	100	U07810.031.0062	1/2-13X3 Inch*	10	U07810.050.0300
NO.8-32X5/16*	100	U07810.016.0031	5/16-18X3/4*	100	U07810.031.0075	1/2-13X4 Inch*	10	U07810.050.0400
NO.8-32X3/8*	100	U07810.016.0037	5/16-18X1 Inch*	100	U07810.031.0100	5/8-11X1/2*	10	U07810.062.0050
NO.8-32X1/2*	100	U07810.016.0050	5/16-18X1.1/4*	100	U07810.031.0125	5/8-11X5/8*	10	U07810.062.0062
NO.8-32X5/8*	100	U07810.016.0062	5/16-18X1.1/2*	100	U07810.031.0150	5/8-11X3/4*	10	U07810.062.0075
NO.8-32X3/4*	100	U07810.016.0075	5/16-18X1.3/4*	100	U07810.031.0175	5/8-11X7/8*	10	U07810.062.0087
NO.8-32X1 Inch*	100	U07810.016.0100	5/16-18X2 Inch*	100	U07810.031.0200	5/8-11X1 Inch*	10	U07810.062.0100
NO.10-24X3/16*	100	U07810.019.0018	3/8-16X1/4*	100	U07810.037.0025	5/8-11X1.1/4*	10	U07810.062.0125
NO.10-24X1/4*	100	U07810.019.0025	3/8-16X5/16*	100	U07810.037.0031	5/8-11X1.1/2*	10	U07810.062.0150
NO.10-24X5/16*	100	U07810.019.0031	3/8-16X3/8*	100	U07810.037.0037	5/8-11X1.3/4*	10	U07810.062.0175
NO.10-24X3/8*	100	U07810.019.0037	3/8-16X1/2*	100	U07810.037.0050	5/8-11X2 Inch*	10	U07810.062.0200
NO.10-24X1/2*	100	U07810.019.0050	3/8-16X5/8*	100	U07810.037.0062	5/8-11X2.1/2*	10	U07810.062.0250
NO.10-24X5/8*	100	U07810.019.0062	3/8-16X3/4*	100	U07810.037.0075	5/8-11X3.1/2*	5	U07810.062.0350

Wkręty dociskowe z końcem stożkowym

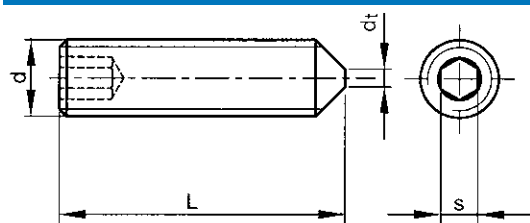

DIN	914
ISO	4027
NEN	2342
ASME	B18.3.6M
NF	E27-181
BS	4168-3

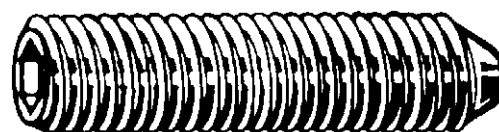

2

Informacje techniczne

d	d _t (maks.)	P	s	d	d _t (maks.)	P	s
M2	-	0.4	0.9	M8	2	1.25	4
M2.5	-	0.45	1.3	M10	2.5	1.5	5
M3	-	0.5	1.5	M12	3	1.75	6
M4	-	0.7	2	M16	4	2	8
M5	-	0.8	2.5	M20	5	2.5	10
M6	1.5	1	3				

Grupy katalogowe

Gwint	Gniazdo	Materiał	Klasa	Kod	Strona
M	Gniazdo sześciokątne	St	45H	07800	2-83
M	Gniazdo sześciokątne	St.St. A2		51250	2-84
M	Gniazdo sześciokątne	St.St. A4		55250	2-84

07800 Wkręty dociskowe z końcem stożkowym

D05A

Gwint	Metryczny
Materiał	Stal
Klasa	45H



d x L	☒	Kod artykułu	d x L	☒	Kod artykułu	d x L	☒	Kod artykułu
M3X3	200	07800.030.003	M5X20	200	07800.050.020	M10X10	200	07800.100.010
M3X4	200	07800.030.004	M5X25	200	07800.050.025	M10X12	200	07800.100.012
M3X5	200	07800.030.005	M5X30	200	07800.050.030	M10X16	200	07800.100.016
M3X6	200	07800.030.006				M10X20	200	07800.100.020
M3X8	200	07800.030.008	M6X6	200	07800.060.006	M10X25	100	07800.100.025
M3X10	200	07800.030.010	M6X8	200	07800.060.008	M10X30	100	07800.100.030
M3X12	200	07800.030.012	M6X10	200	07800.060.010	M10X40	100	07800.100.040
M3X16	200	07800.030.016	M6X12	200	07800.060.012	M10X50	100	07800.100.050
M3X20	200	07800.030.020	M6X16	200	07800.060.016			
			M6X20	200	07800.060.020			
M4X4	200	07800.040.004	M6X25	200	07800.060.025	M12X16	100	07800.120.016
M4X5	200	07800.040.005	M6X30	200	07800.060.030	M12X20	100	07800.120.020
M4X6	200	07800.040.006	M6X35	200	07800.060.035	M12X25	100	07800.120.025
M4X8	200	07800.040.008				M12X30	100	07800.120.030
M4X10	200	07800.040.010	M8X8	200	07800.080.008	M12X40	100	07800.120.040
M4X12	200	07800.040.012	M8X10	200	07800.080.010	M12X50	100	07800.120.050
M4X16	200	07800.040.016	M8X12	200	07800.080.012			
M4X20	200	07800.040.020	M8X16	200	07800.080.016	M16X16	50	07800.160.016
M4X25	200	07800.040.025	M8X20	200	07800.080.020	M16X20	50	07800.160.020
			M8X25	200	07800.080.025	M16X25	50	07800.160.025
M5X5	200	07800.050.005	M8X30	200	07800.080.030	M16X30	50	07800.160.030
M5X6	200	07800.050.006	M8X35	100	07800.080.035	M16X35	50	07800.160.035
M5X8	200	07800.050.008	M8X40	100	07800.080.040	M16X40	50	07800.160.040
M5X10	200	07800.050.010	M8X50	100	07800.080.050	M16X50	50	07800.160.050
M5X12	200	07800.050.012	M8X60	100	07800.080.060	M16X60	25	07800.160.060
M5X16	200	07800.050.016						

- Ostrzeżenie: cynkowanie elektrolityczne tych produktów może wywołać kruchość wodorową.

51250 Wkręty dociskowe z końcem stożkowym R03A

Gwint: Metryczny
 Materiał: Stal nierdzewna A2



d x L	☒	Kod artykułu	d x L	☒	Kod artykułu	d x L	☒	Kod artykułu
M2X3*	500	51250.020.003	M5X8	200	51250.050.008	M8X50*	200	51250.080.050
M2X4*	500	51250.020.004	M5X10	200	51250.050.010	M8X60*	200	51250.080.060
M2X5*	500	51250.020.005	M5X12	200	51250.050.012			
M2X6*	500	51250.020.006	M5X14*	500	51250.050.014	M10X10*	200	51250.100.010
M2X8*	500	51250.020.008	M5X16	200	51250.050.016	M10X12	100	51250.100.012
M2X10*	500	51250.020.010	M5X18*	500	51250.050.018	M10X16	100	51250.100.016
M2X12*	500	51250.020.012	M5X20	200	51250.050.020	M10X20	100	51250.100.020
			M5X25	200	51250.050.025	M10X25	100	51250.100.025
M2,5X3*	500	51250.025.003	M5X30*	200	51250.050.030	M10X30*	100	51250.100.030
M2,5X4	200	51250.025.004	M5X35*	200	51250.050.035	M10X35*	100	51250.100.035
M2,5X5*	500	51250.025.005	M5X40*	200	51250.050.040	M10X40*	100	51250.100.040
M2,5X6*	500	51250.025.006	M5X45*	200	51250.050.045	M10X45*	100	51250.100.045
M2,5X8*	500	51250.025.008	M5X50	200	51250.050.050	M10X50*	100	51250.100.050
M2,5X10*	500	51250.025.010				M10X60*	100	51250.100.060
M2,5X12*	500	51250.025.012	M6X5*	200	51250.060.005			
			M6X6	200	51250.060.006	M12X12*	100	51250.120.012
M3X3*	500	51250.030.003	M6X8	200	51250.060.008	M12X16*	100	51250.120.016
M3X4	500	51250.030.004	M6X10	200	51250.060.010	M12X20*	100	51250.120.020
M3X5*	500	51250.030.005	M6X12	200	51250.060.012	M12X25*	100	51250.120.025
M3X6*	500	51250.030.006	M6X14*	200	51250.060.014	M12X30*	100	51250.120.030
M3X8*	500	51250.030.008	M6X16	200	51250.060.016	M12X35	100	51250.120.035
M3X10*	500	51250.030.010	M6X20	200	51250.060.020	M12X40*	100	51250.120.040
M3X12*	500	51250.030.012	M6X22*	200	51250.060.022	M12X45*	100	51250.120.045
M3X16*	500	51250.030.016	M6X25	200	51250.060.025	M12X50*	100	51250.120.050
M3X20*	500	51250.030.020	M6X30*	200	51250.060.030	M12X55	100	51250.120.055
M3X25*	500	51250.030.025	M6X35*	200	51250.060.035	M12X60*	100	51250.120.060
M3X30*	200	51250.030.030	M6X40*	200	51250.060.040	M12X70*	50	51250.120.070
			M6X45*	200	51250.060.045			
M4X4	500	51250.040.004	M6X50*	200	51250.060.050	M16X16*	50	51250.160.016
M4X5	500	51250.040.005	M6X60*	200	51250.060.060	M16X20*	50	51250.160.020
M4X6	200	51250.040.006				M16X25*	50	51250.160.025
M4X8	200	51250.040.008	M8X6*	200	51250.080.006	M16X30*	50	51250.160.030
M4X10	200	51250.040.010	M8X8	200	51250.080.008	M16X40*	50	51250.160.040
M4X12	200	51250.040.012	M8X10	200	51250.080.010	M16X45*	50	51250.160.045
M4X14	200	51250.040.014	M8X12	200	51250.080.012	M16X50*	50	51250.160.050
M4X16	200	51250.040.016	M8X16	200	51250.080.016	M16X60*	50	51250.160.060
M4X20	200	51250.040.020	M8X20	200	51250.080.020	M16X70*	50	51250.160.070
M4X25*	500	51250.040.025	M8X25	100	51250.080.025			
M4X30*	200	51250.040.030	M8X30	200	51250.080.030	M20X20*	50	51250.200.020
			M8X35*	200	51250.080.035	M20X30*	50	51250.200.030
M5X5*	500	51250.050.005	M8X40*	200	51250.080.040	M20X40*	50	51250.200.040
M5X6	200	51250.050.006	M8X45*	200	51250.080.045	M20X50*	50	51250.200.050

55250 Wkręty dociskowe z końcem stożkowym R43A

Gwint: Metryczny
 Materiał: Stal nierdzewna A4



d x L	☒	Kod artykułu	d x L	☒	Kod artykułu	d x L	☒	Kod artykułu
M3X4*	500	55250.030.004	M5X12	200	55250.050.012	M8X8	200	55250.080.008
M3X5*	500	55250.030.005	M5X14*	500	55250.050.014	M8X10	200	55250.080.010
M3X6*	500	55250.030.006	M5X16	200	55250.050.016	M8X12	200	55250.080.012
M3X8*	500	55250.030.008	M5X20	200	55250.050.020	M8X16	200	55250.080.016
M3X10*	500	55250.030.010	M5X25*	200	55250.050.025	M8X20	200	55250.080.020
M3X12*	500	55250.030.012	M5X30*	200	55250.050.030	M8X25	100	55250.080.025
			M5X35*	200	55250.050.035	M8X30	100	55250.080.030
M4X4*	500	55250.040.004	M5X40*	200	55250.050.040	M8X35*	200	55250.080.035
M4X5*	500	55250.040.005				M8X40	100	55250.080.040
M4X6	200	55250.040.006	M6X6	200	55250.060.006	M8X45*	200	55250.080.045
M4X8	200	55250.040.008	M6X8	200	55250.060.008	M8X50*	200	55250.080.050
M4X10	200	55250.040.010	M6X10	200	55250.060.010			
M4X12	200	55250.040.012	M6X12	200	55250.060.012	M10X10*	200	55250.100.010
M4X16	200	55250.040.016	M6X14*	200	55250.060.014	M10X12	100	55250.100.012
M4X20	200	55250.040.020	M6X16	200	55250.060.016	M10X16	100	55250.100.016
M4X30*	200	55250.040.030	M6X20	200	55250.060.020	M10X20	100	55250.100.020
			M6X25	200	55250.060.025	M10X25	100	55250.100.025
M5X5*	500	55250.050.005	M6X30	200	55250.060.030	M10X30	100	55250.100.030
M5X6	200	55250.050.006	M6X35*	200	55250.060.035	M10X35*	100	55250.100.035
M5X8	200	55250.050.008	M6X40*	200	55250.060.040	M10X40	100	55250.100.040
M5X10	200	55250.050.010	M6X45*	200	55250.060.045			

55250 Wkręty dociskowe z końcem stożkowym								
d x L	☒	Kod artykułu	d x L	☒	Kod artykułu	d x L	☒	Kod artykułu
M10X50*	100	55250.100.050	M12X25*	100	55250.120.025			
			M12X30*	100	55250.120.030	M16X25*	50	55250.160.025
M12X12*	100	55250.120.012	M12X40*	100	55250.120.040	M16X30*	50	55250.160.030
M12X16*	100	55250.120.016	M12X45*	100	55250.120.045	M16X40*	50	55250.160.040
M12X20*	100	55250.120.020	M12X50*	100	55250.120.050			

Wkręty dociskowe z końcem stożkowym UNC

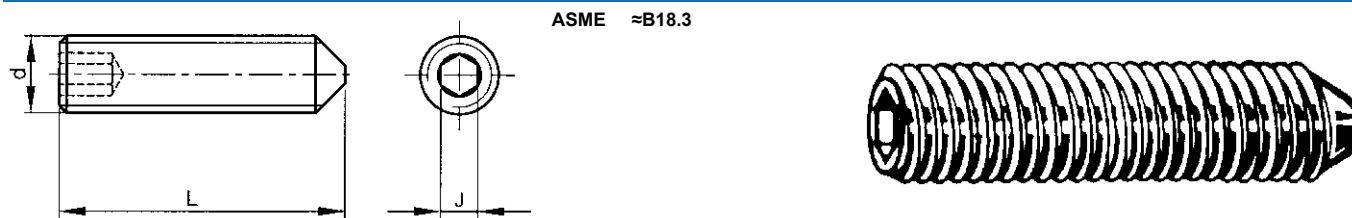

Informacje techniczne

d	J	Zwoje gwintu na cal
No.4	0.05	40
No.5	1/16	40
No.6	1/16	32
No.8	5/64	32
No.10	3/32	24
1/4	1/8	20
5/16	5/32	18
3/8	3/16	16
1/2	1/4	13

U07800 Wkręty dociskowe z końcem stożkowym UNC		X05A
Gwint	Calowy, zunifikowany grubozwojny (UNC)	
Material	Stal	

d x L	☒	Kod artykułu	d x L	☒	Kod artykułu	d x L	☒	Kod artykułu
NO.4-40X1/8*	100	U07800.011.0012	NO.10-24X3/8*	100	U07800.019.0037	5/16-18X5/8*	100	U07800.031.0062
			NO.10-24X1/2*	100	U07800.019.0050	5/16-18X3/4*	100	U07800.031.0075
NO.5-40X1/4*	100	U07800.012.0025				5/16-18X1 Inch*	100	U07800.031.0100
NO.6-32X1/8*	100	U07800.013.0012	1/4-20X1/4*	100	U07800.025.0025			
NO.6-32X3/16*	100	U07800.013.0018	1/4-20X5/16*	100	U07800.025.0031	3/8-16X3/8*	100	U07800.037.0037
NO.6-32X1/4*	100	U07800.013.0025	1/4-20X3/8*	100	U07800.025.0037	3/8-16X1/2*	100	U07800.037.0050
			1/4-20X1/2*	50	U07800.025.0050	3/8-16X3/4*	100	U07800.037.0075
NO.8-32X3/16*	100	U07800.016.0018	1/4-20X5/8*	100	U07800.025.0062	3/8-16X1 Inch*	100	U07800.037.0100
NO.8-32X1/4*	100	U07800.016.0025	1/4-20X3/4*	50	U07800.025.0075			
NO.8-32X3/8*	100	U07800.016.0037	1/4-20X1 Inch*	100	U07800.025.0100	1/2-13X1/2*	50	U07800.050.0050
						1/2-13X3/4*	25	U07800.050.0075
NO.10-24X1/4*	100	U07800.019.0025	5/16-18X5/16*	50	U07800.031.0031	1/2-13X1 Inch*	25	U07800.050.0100
NO.10-24X5/16*	100	U07800.019.0031	5/16-18X3/8*	100	U07800.031.0037			
			5/16-18X1/2*	100	U07800.031.0050			

Wkręty dociskowe z gniazdem sześciokątnym z czopem walcowym

2

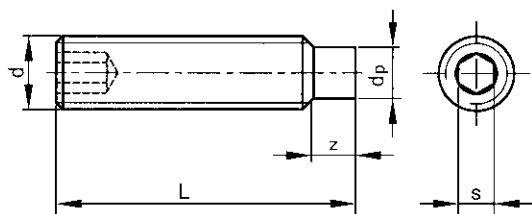

DIN 915
ISO 4028
NEN 2344
ASME B18.3.6M
NF E27-182
BS 4168-4

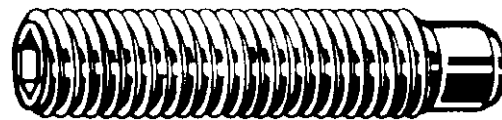

Informacje techniczne

d	z krótki L ≤	z krótki (min.)	z krótki (maks.)	z długi L ≥	z długi (min.)	z długi (maks.)	d _p (maks.)	P	s
M2	3	0.5	0.75	4	1	1.25	1	0.4	0.9
M2.5	4	0.63	0.88	5	1.25	1.5	1.5	0.45	1.3
M3	5	0.75	1	6	1.5	1.75	2	0.5	1.5
M4	6	1	1.25	8	2	2.25	2.5	0.7	2
M5	6	1.25	1.5	8	2.5	2.75	3.5	0.8	2.5
M6	8	1.5	1.75	10	3	3.25	4	1	3
M8	10	2	2.25	12	4	4.3	5.5	1.25	4
M10	12	2.5	2.75	16	5	5.3	7	1.5	5
M12	16	3	3.25	20	6	6.3	8.5	1.75	6
M16	20	4	4.3	25	8	8.36	12	2	8
M20	25	5	5.3	30	10	10.36	15	2.5	10

Grupy katalogowe

Gwint	Gniazdo	Materiał	Klasa	Kod	Strona
M	Gniazdo sześciokątne	St	45H	07820	2-86
M	Gniazdo sześciokątne	St.St. A2		51230	2-87
M	Gniazdo sześciokątne	St.St. A4		55230	2-87

07820 Wkręty dociskowe z gniazdem sześciokątnym z czopem walcowym



D05A

Gwint Metryczny
Materiał Stal
Klasa 45H





d x L	☒	Kod artykułu	d x L	☒	Kod artykułu	d x L	☒	Kod artykułu
M3X3	200	07820.030.003	M6X8	200	07820.060.008	M10X45	100	07820.100.045
M3X4	200	07820.030.004	M6X10	200	07820.060.010	M10X50	100	07820.100.050
M3X5	200	07820.030.005	M6X12	200	07820.060.012	M10X60	50	07820.100.060
M3X6	200	07820.030.006	M6X16	200	07820.060.016			
M3X8	200	07820.030.008	M6X20	200	07820.060.020	M12X12	100	07820.120.012
M3X10	200	07820.030.010	M6X25	200	07820.060.025	M12X16	100	07820.120.016
M3X12	200	07820.030.012	M6X30	200	07820.060.030	M12X20	100	07820.120.020
M3X16	200	07820.030.016	M6X40	200	07820.060.040	M12X25	100	07820.120.025
M3X20	200	07820.030.020	M6X50	200	07820.060.050	M12X30	100	07820.120.030
						M12X35	100	07820.120.035
M4X6	200	07820.040.006	M8X8	200	07820.080.008	M12X40	100	07820.120.040
M4X8	200	07820.040.008	M8X10	200	07820.080.010	M12X45	100	07820.120.045
M4X10	200	07820.040.010	M8X12	200	07820.080.012	M12X50	100	07820.120.050
M4X12	200	07820.040.012	M8X16	200	07820.080.016	M12X60	50	07820.120.060
M4X16	200	07820.040.016	M8X20	200	07820.080.020			
M4X20	200	07820.040.020	M8X25	200	07820.080.025	M16X16	50	07820.160.016
M4X25	200	07820.040.025	M8X30	200	07820.080.030	M16X20	50	07820.160.020
M4X30	200	07820.040.030	M8X35	100	07820.080.035	M16X25	50	07820.160.025
			M8X40	100	07820.080.040	M16X30	50	07820.160.030
M5X6	200	07820.050.006	M8X45	100	07820.080.045	M16X35	50	07820.160.035
M5X8	200	07820.050.008	M8X50	100	07820.080.050	M16X40	50	07820.160.040
M5X10	200	07820.050.010	M8X80	100	07820.080.080	M16X50	50	07820.160.050
M5X12	200	07820.050.012				M16X60	25	07820.160.060
M5X16	200	07820.050.016	M10X12	200	07820.100.012			
M5X20	200	07820.050.020	M10X16	200	07820.100.016	M20X30	25	07820.200.030
M5X25	200	07820.050.025	M10X20	200	07820.100.020	M20X40	25	07820.200.040
M5X30	200	07820.050.030	M10X25	100	07820.100.025	M20X50	10	07820.200.050
M5X40	200	07820.050.040	M10X30	100	07820.100.030	M20X60	25	07820.200.060
			M10X35	100	07820.100.035	M20X70	25	07820.200.070
M6X6	200	07820.060.006	M10X40	100	07820.100.040	M20X140	25	07820.200.140

• Ostrzeżenie: cynkowanie elektrolityczne tych produktów może wywołać kruchość wodorową.

51230		Wkręty dociskowe z gniazdem sześciokątnym z czopem walcowym		R03A
Gwint	Metryczny			
Material	Stal nierdzewna A2			
				 

d x L	✉	Kod artykułu	d x L	✉	Kod artykułu	d x L	✉	Kod artykułu
M2X3	500	51230.020.003				M8X35*	200	51230.080.035
M2X4*	500	51230.020.004				M8X40	100	51230.080.040
M2X5*	500	51230.020.005	M5X5*	500	51230.050.005	M8X45*	200	51230.080.045
M2X6*	500	51230.020.006	M5X6	200	51230.050.006	M8X50*	200	51230.080.050
M2X8*	500	51230.020.008	M5X8	200	51230.050.008	M8X60*	200	51230.080.060
M2X12*	500	51230.020.012	M5X10	200	51230.050.010			
			M5X12	200	51230.050.012			
M2,5X3*	500	51230.025.003	M5X16	200	51230.050.016	M10X10*	200	51230.100.010
M2,5X4*	500	51230.025.004	M5X18*	500	51230.050.018	M10X12	100	51230.100.012
M2,5X5*	500	51230.025.005	M5X20	200	51230.050.020	M10X16	100	51230.100.016
M2,5X6*	500	51230.025.006	M5X25*	200	51230.050.025	M10X20	100	51230.100.020
M2,5X8*	500	51230.025.008	M5X30*	200	51230.050.030	M10X25	100	51230.100.025
M2,5X10*	500	51230.025.010	M5X35*	200	51230.050.035	M10X30	100	51230.100.030
M2,5X12*	500	51230.025.012	M5X40*	200	51230.050.040	M10X35*	200	51230.100.035
						M10X40	100	51230.100.040
M3X3*	500	51230.030.003	M6X6	200	51230.060.006	M10X45*	200	51230.100.045
M3X4*	500	51230.030.004	M6X8	200	51230.060.008	M10X50*	200	51230.100.050
M3X5*	500	51230.030.005	M6X10	200	51230.060.010	M10X60*	200	51230.100.060
M3X6*	500	51230.030.006	M6X12	200	51230.060.012			
M3X8*	500	51230.030.008	M6X16	200	51230.060.016	M12X12*	100	51230.120.012
M3X10*	500	51230.030.010	M6X20	200	51230.060.020	M12X16*	100	51230.120.016
M3X12*	500	51230.030.012	M6X25	200	51230.060.025	M12X20*	100	51230.120.020
M3X16*	500	51230.030.016	M6X30	200	51230.060.030	M12X25*	100	51230.120.025
M3X20*	500	51230.030.020	M6X35*	200	51230.060.035	M12X30*	100	51230.120.030
M3X25*	500	51230.030.025	M6X40*	200	51230.060.040	M12X35*	100	51230.120.035
			M6X45*	200	51230.060.045	M12X40*	100	51230.120.040
M4X4*	500	51230.040.004	M6X50*	200	51230.060.050	M12X45*	100	51230.120.045
M4X5*	500	51230.040.005	M6X60*	200	51230.060.060	M12X50*	100	51230.120.050
M4X6	200	51230.040.006				M12X55*	100	51230.120.055
M4X8	200	51230.040.008	M8X8*	200	51230.080.008	M12X60*	100	51230.120.060
M4X10	200	51230.040.010	M8X10	200	51230.080.010			
M4X12*	500	51230.040.012	M8X12	200	51230.080.012	M16X20*	50	51230.160.020
M4X16	500	51230.040.016	M8X16	200	51230.080.016	M16X25	50	51230.160.025
M4X20*	500	51230.040.020	M8X20	200	51230.080.020	M16X30*	50	51230.160.030
M4X25*	500	51230.040.025	M8X25	100	51230.080.025	M16X40*	50	51230.160.040
M4X30*	200	51230.040.030	M8X30	100	51230.080.030	M16X50*	50	51230.160.050

55230		Wkręty dociskowe z gniazdem sześciokątnym z czopem walcowym		R43A
Gwint	Metryczny			
Material	Stal nierdzewna A4			
				 

d x L	✉	Kod artykułu	d x L	✉	Kod artykułu	d x L	✉	Kod artykułu
M3X4*	500	55230.030.004	M5X16*	500	55230.050.016	M8X25*	200	55230.080.025
M3X5*	500	55230.030.005	M5X20*	500	55230.050.020	M8X30*	200	55230.080.030
M3X6*	500	55230.030.006	M5X25*	200	55230.050.025			
M3X8*	500	55230.030.008				M10X10*	200	55230.100.010
			M6X6*	200	55230.060.006	M10X12*	200	55230.100.012
M4X4*	500	55230.040.004	M6X8*	200	55230.060.008	M10X16*	200	55230.100.016
M4X6*	500	55230.040.006	M6X10*	200	55230.060.010	M10X20*	200	55230.100.020
M4X8*	500	55230.040.008	M6X12*	200	55230.060.012	M10X25*	100	55230.100.025
M4X10	500	55230.040.010	M6X16*	200	55230.060.016	M10X30*	100	55230.100.030
M4X12*	500	55230.040.012	M6X20*	200	55230.060.020	M10X40*	100	55230.100.040
M4X16*	500	55230.040.016	M6X25*	200	55230.060.025			
M4X25*	500	55230.040.025	M6X30*	200	55230.060.030	M12X20*	100	55230.120.020
						M12X25*	100	55230.120.025
M5X6*	500	55230.050.006	M8X8*	200	55230.080.008	M12X30*	100	55230.120.030
M5X8	500	55230.050.008	M8X10*	200	55230.080.010	M12X40*	100	55230.120.040
M5X10*	500	55230.050.010	M8X12*	200	55230.080.012	M12X45*	100	55230.120.045
M5X12*	500	55230.050.012	M8X16*	200	55230.080.016			
M5X14*	500	55230.050.014	M8X20	200	55230.080.020	M16X40*	50	55230.160.040

Wkręty dociskowe z czopem walcowym UNC

2

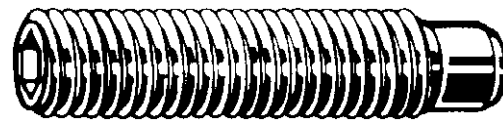
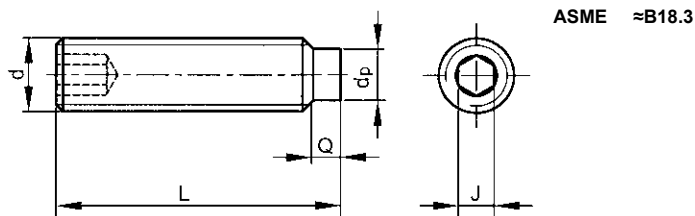

Informacje techniczne

d	d _p (maks.)	J	Q (max.)	Zwoje gwintu na cal
No.8	0.109	5/64	0.043	32
No.10	0.127	3/32	0.049	24
1/4	0.156	1/8	0.067	20
5/16	0.203	5/32	0.082	18
3/8	0.250	3/16	0.099	16
1/2	0.344	1/4	0.13	13
5/8	0.469	5/16	0.164	11

U07820 Wkręty dociskowe z czopem walcowym krótkim UNC

X05A

Gwint Calowy, zunifikowany grubozwojny (UNC)
Materiał Stal



d x L	☒	Kod artykułu	d x L	☒	Kod artykułu	d x L	☒	Kod artykułu
NO.8-32X3/16*	100	U07820.016.0018	1/4-20X5/16*	100	U07820.025.0031	3/8-16X5/8*	100	U07820.037.0062
NO.8-32X1/4*	100	U07820.016.0025	1/4-20X3/8*	100	U07820.025.0037	3/8-16X3/4*	100	U07820.037.0075
NO.8-32X5/16*	100	U07820.016.0031	1/4-20X1/2*	100	U07820.025.0050	3/8-16X1 Inch*	100	U07820.037.0100
NO.8-32X3/8*	100	U07820.016.0037	1/4-20X5/8*	100	U07820.025.0062	3/8-16X1.1/4*	100	U07820.037.0125
NO.8-32X1/2*	100	U07820.016.0050	1/4-20X3/4*	100	U07820.025.0075			
			1/4-20X1 Inch*	100	U07820.025.0100	1/2-13X1/2*	50	U07820.050.0050
NO.10-24X3/16*	100	U07820.019.0018				1/2-13X5/8*	50	U07820.050.0062
NO.10-24X1/4*	100	U07820.019.0025	5/16-18X5/16*	100	U07820.031.0031	1/2-13X3/4*	25	U07820.050.0075
NO.10-24X5/16*	100	U07820.019.0031	5/16-18X3/8*	100	U07820.031.0037	1/2-13X1 Inch*	25	U07820.050.0100
NO.10-24X3/8*	100	U07820.019.0037	5/16-18X1/2*	100	U07820.031.0050	1/2-13X1.1/4*	25	U07820.050.0125
NO.10-24X1/2*	100	U07820.019.0050						
			3/8-16X3/8*	100	U07820.037.0037	5/8-11X1 Inch*	10	U07820.062.0100
1/4-20X1/4*	100	U07820.025.0025	3/8-16X1/2*	100	U07820.037.0050	5/8-11X1.1/4*	10	U07820.062.0125

Wkręty dociskowe z gniazdem sześciokątnym z nylonowym czopem walcowym

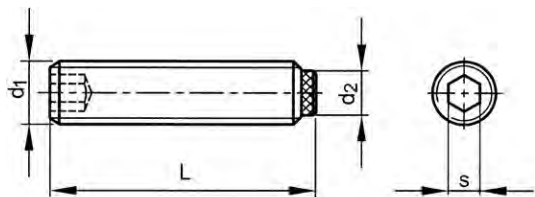

2

Informacje techniczne

d ₁	d ₂	P	s	d ₁	d ₂	P	s
M4	2.5	0.7	2	M8	5.5	1.25	4
M5	3	0.8	2.5	M10	7	1.5	5
M6	4	1	3				

- Wkręty dociskowe z gniazdem sześciokątnym z nylonowym czopem walcowym nadają się do dociskania, bez uszkodzenia, np. gwintowanych prętów, śrub dwustronnych i łączników z powierzchnią powlekaną.

56949 Wkręty dociskowe z gniazdem sześciokątnym z nylonowym czopem walcowym

W03A

Gwint: Metryczny
 Materiał: Stal
 Klasa: 5.8



d ₁ x L	☒	Kod artykułu	d ₁ x L	☒	Kod artykułu	d ₁ x L	☒	Kod artykułu
M4X6,5	25	56949.040.006	M5X11	25	56949.050.011	M8X10	10	56949.080.010
M4X7	25	56949.040.007	M5X12,5	25	56949.050.012	M8X12	10	56949.080.012
M4X8	25	56949.040.008	M5X16	25	56949.050.016	M8X13,6	10	56949.080.013
M4X9	25	56949.040.009	M5X17	25	56949.050.017	M8X20	10	56949.080.020
M4X10,5	25	56949.040.010						
M4X11	25	56949.040.011	M6X10	25	56949.060.010	M10X16	10	56949.100.016
			M6X11,3	25	56949.060.011	M10X18	10	56949.100.018
M5X8,5	25	56949.050.008	M6X26,3	10	56949.060.026	M10X26,9	10	56949.100.026
M5X9	25	56949.050.009				M10X27	10	56949.100.027
M5X10	25	56949.050.010						

Wkręty dociskowe z gniazdem sześciokątnym z końcem wgłębionym BSW

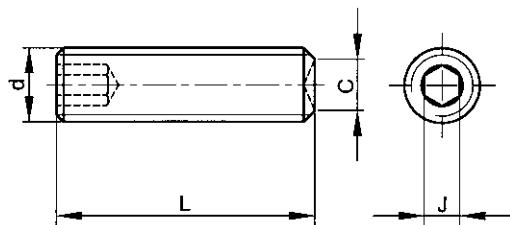

BS ≈2470
ASME ≈B18.3

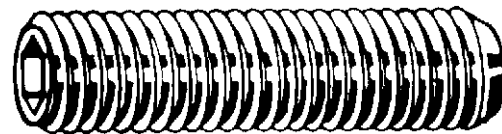

Informacje techniczne

d	C	J	Zwoje gwintu na cal
1/2	7.3	1/4	12

07940 Wkręty dociskowe z gniazdem sześciokątnym z końcem wgłębionym BSW X08A

Gwint: Całowy, Whitworth'a (BSW)
Materiał: Stal
Klasa: 45H

d x L	☒	Kod artykułu	d x L	☒	Kod artykułu	d x L	☒	Kod artykułu
1/2X1/2	100	07940.127.012	1/2X3/4	100	07940.127.020	1/2X1.1/2	50	07940.127.040
1/2X5/8	100	07940.127.016	1/2X1 Inch	50	07940.127.025			

• Ostrzeżenie: cynkowanie elektrolityczne tych produktów może wywołać kruchość wodorową.

Wkręty dociskowe z końcem owalnym UNC

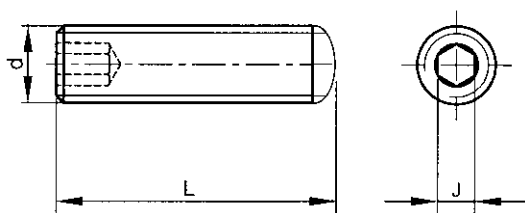

ASME ≈B18.3



Informacje techniczne

d	J	Zwoje gwintu na cal
No.6	1/16	32
No.8	5/64	32
No.10	3/32	24
1/4	1/8	20
5/16	5/32	18
3/8	3/16	16
1/2	1/4	13

U07845 Wkręty dociskowe z końcem owalnym UNC X05A

Gwint: Całowy, zunifikowany grubozwojny (UNC)
Materiał: Stal

d x L	☒	Kod artykułu	d x L	☒	Kod artykułu	d x L	☒	Kod artykułu
NO.6-32X1/4*	100	U07845.013.0025	1/4-20X1/4*	100	U07845.025.0025	5/16-18X1/2*	100	U07845.031.0050
NO.6-32X5/16*	100	U07845.013.0031	1/4-20X5/16*	100	U07845.025.0031	5/16-18X5/8*	100	U07845.031.0062
NO.6-32X3/8*	100	U07845.013.0037	1/4-20X3/8*	100	U07845.025.0037	5/16-18X3/4*	100	U07845.031.0075
NO.8-32X3/16*	100	U07845.016.0018	1/4-20X1/2*	100	U07845.025.0050	5/16-18X1 Inch*	100	U07845.031.0100
NO.8-32X1/4*	100	U07845.016.0025	1/4-20X5/8*	100	U07845.025.0062	3/8-16X3/8*	100	U07845.037.0037
NO.8-32X1/2*	100	U07845.016.0050	1/4-20X3/4*	100	U07845.025.0075	3/8-16X1/2*	100	U07845.037.0050
NO.10-24X3/16*	100	U07845.019.0018	1/4-20X1 Inch*	100	U07845.025.0100	3/8-16X5/8*	100	U07845.037.0062
NO.10-24X1/4*	100	U07845.019.0025				3/8-16X3/4*	100	U07845.037.0075
NO.10-24X3/8*	100	U07845.019.0037	5/16-18X1/4*	100	U07845.031.0025	3/8-16X1 Inch*	100	U07845.037.0100
NO.10-24X1/2*	100	U07845.019.0050	5/16-18X5/16*	100	U07845.031.0031			
			5/16-18X3/8*	100	U07845.031.0037	1/2-13X1/2*	50	U07845.050.0050

U07845 Wkręty dociskowe z końcem owalnym UNC								
d x L	☒	Kod artykułu	d x L	☒	Kod artykułu	d x L	☒	Kod artykułu
1/2-13X5/8*	50	U07845.050.0062	1/2-13X3/4*	25	U07845.050.0075	1/2-13X1 Inch*	25	U07845.050.0100

Zaślepki do śrub z łbem walcowym i gniazdem sześciokątnym

2

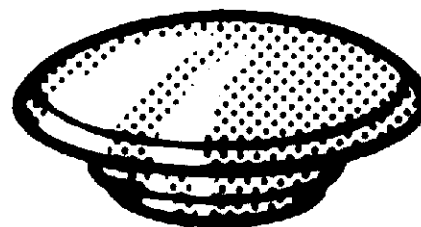
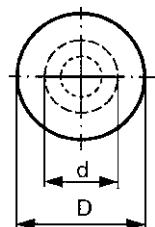
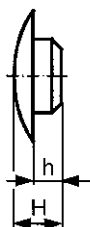

Informacje techniczne

W użyciu z	d	D	h	H	s
M5	4.3	9.1	1.5	2.8	4
M6	5.4	10.1	1.8	3.2	5
M8	6.3	13.1	2.4	3.8	6
M10	8.2	16	2.8	4.3	8
M12	10.5	18.2	3.4	5.5	10
M14	12.5	22.1	3.5	6.3	12
M16	14.5	23.8	3.8	7.5	14
M20	17.6	30.1	4.4	7.4	17

Przykłady zastosowania

Specjalne właściwości zaślepek dla śrub z gniazdem sześciokątnym:

- chronią przed korozją i gromadzeniem się brudu w gnieździe otworu
- staranny wygląd
- proste w montażu i możliwe ponowne użycie
- odporne na temperaturę od -60°C do +120°C
- kolor szary A RAL 7042
- **UWAGA:** łby śrub z gniazdem 6-kątnym **mogą być** tylko częściowo przykryte zaślepkami

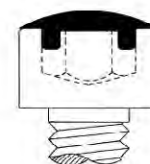

07760 Zaślepki do śrub z łbem walcowym i gniazdem sześciokątnym		D91A
Materiał	Plastik Polietylen	
Kolor	Szary	



W użyciu z / s	☒	Kod artykułu	W użyciu z / s	☒	Kod artykułu	W użyciu z / s	☒	Kod artykułu
M5/s=4	100	07760.050.001	M10/s=8	100	07760.100.001	M16/s=14	100	07760.160.001
M6/s=5	100	07760.060.001	M12/s=10	100	07760.120.001	M20/s=17	50	07760.200.001
M8/s=6	100	07760.080.001	M14/s=12	100	07760.140.001			

Korki rurowe z gniazdem sześciokątnym z zewnętrznym stożkowym gwintem metr. drob.

DIN 906

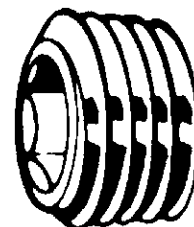
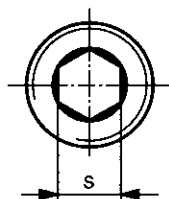
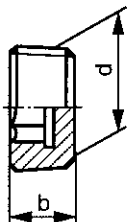

2

Informacje techniczne

d	b (js16)	s (D12)	d	b (js16)	s (D12)
M8	8	4	M22	10	10
M10	8	5	M24	12	12
M12	10	6	M26	12	12
M14	10	7	M27	12	12
M16	10	8	M30	12	17
M18	10	8	M36	15	19
M20	10	10	M42	18	22

Grupy katalogowe

Gwint	Gniazdo	Materiał	Kod	Strona
M.drob.	Gniazdo sześciokątne	St	07660	2-92
M.drob.	Gniazdo sześciokątne	St.St. A2	51961	2-92
M.drob.	Gniazdo sześciokątne	St.St. A4	55961	2-92

07660 Korki rurowe z gniazdem sześciokątnym z zewnętrznym stożkowym gwintem metr. drbzw.

D90A

Gwint Metryczny drobnozwojny
Materiał Stal



d x P	☒	Kod artykułu	d x P	☒	Kod artykułu	d x P	☒	Kod artykułu
M8X1,00	50	07660.080.100	M18X1,50	25	07660.180.150	M26X1,50	25	07660.260.150
M10X1,00	50	07660.100.100	M20X1,50	25	07660.200.150	M30X1,50	10	07660.300.150
M12X1,50	50	07660.120.150	M22X1,50	25	07660.220.150	M36X1,50	10	07660.360.150
M14X1,50	50	07660.140.150	M24X1,50	25	07660.240.150	M42X1,50	10	07660.420.150
M16X1,50	50	07660.160.150						

51961 Korki rurowe z gniazdem sześciokątnym z zewnętrznym stożkowym gwintem metr. drob.

R09A

Gwint Metryczny drobnozwojny
Materiał Stal nierdzewna A2



d x P	☒	Kod artykułu	d x P	☒	Kod artykułu	d x P	☒	Kod artykułu
M8X1,00*	50	51961.080.100	M18X1,50*	50	51961.180.150	M24X1,50*	10	51961.260.150
M10X1,00*	50	51961.100.100	M20X1,50*	25	51961.200.150	M27X2,00*	10	51961.270.200
M12X1,50*	50	51961.120.150	M22X1,50*	25	51961.220.150	M30X1,50*	10	51961.300.150
M14X1,50*	50	51961.140.150	M24X1,50*	25	51961.240.150	M30X2,00*	10	51961.300.200
M16X1,50*	50	51961.160.150						

55961 Korki rurowe z gniazdem sześciokątnym z zewnętrznym stożkowym gwintem metr. drob.

R49A

Gwint Metryczny drobnozwojny
Materiał Stal nierdzewna A4



d x P	☒	Kod artykułu	d x P	☒	Kod artykułu	d x P	☒	Kod artykułu
M8X1,00*	50	55961.080.100	M16X1,50*	50	55961.160.150	M22X1,50*	25	55961.220.150
M10X1,00*	50	55961.100.100	M18X1,50*	50	55961.180.150	M24X1,50*	25	55961.240.150
M12X1,50*	50	55961.120.150	M20X1,50*	25	55961.200.150	M30X1,50*	10	55961.300.150
M14X1,50*	50	55961.140.150						

Korki rurowe z gniazdem sześciokątnym z zewnętrznym stożkowym gwintem rurowym

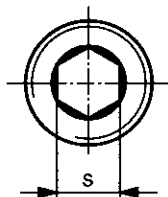
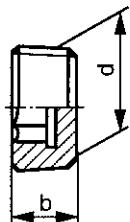

DIN 906

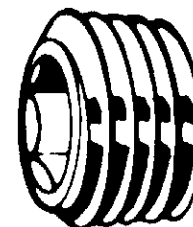

2

Informacje techniczne

d	b (js16)	s (D12)	Zwoje gwintu na cal	d	b (js16)	s (D12)	Zwoje gwintu na cal
R1/8	8	5	28	R1 Inch	12	17	11
R1/4	10	7	19	R1.1/4	18	22	11
R3/8	10	8	19	R1.1/2	20	24	11
R1/2	10	10	14	R2 Inch	22	30	11
R3/4	12	12	14				

Grupy katalogowe

Gwint	Gniazdo	Materiał	Kod	Strona
R	Gniazdo sześciokątne	St	07650	2-93
R	Gniazdo sześciokątne	St.St. A2	51962	2-93
R	Gniazdo sześciokątne	St.St. A4	55962	2-93

07650 Korki rurowe z gniazdem sześciokątnym z zewnętrznym stożkowym gwintem rurowym

D90A

Gwint Rurowy
Materiał Stal

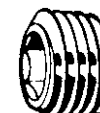

d	☒	Kod artykułu	d	☒	Kod artykułu	d	☒	Kod artykułu
R1/8	100	07650.031.001	R1/2	50	07650.127.001	R1.1/4	10	07650.317.001
R1/4	50	07650.063.001	R3/4	25	07650.191.001	R1.1/2	10	07650.381.001
R3/8	50	07650.096.001	R1 Inch	25	07650.254.001	R2 Inch	10	07650.508.001

51962 Korki rurowe z gniazdem sześciokątnym z zewnętrznym stożkowym gwintem rurowym

R09A

Gwint Rurowy
Materiał Stal nierdzewna A2



d	☒	Kod artykułu	d	☒	Kod artykułu	d	☒	Kod artykułu
R1/8*	50	51962.031.001	R1/2*	25	51962.127.001	R1 Inch*	10	51962.254.001
R1/4*	50	51962.063.001	R3/4*	25	51962.191.001	R1.1/4*	5	51962.317.001
R3/8*	50	51962.096.001						

55962 Korki rurowe z gniazdem sześciokątnym z zewnętrznym stożkowym gwintem rurowym

R49A

Gwint Rurowy
Materiał Stal nierdzewna A4

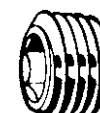

d	☒	Kod artykułu	d	☒	Kod artykułu	d	☒	Kod artykułu
R1/8*	50	55962.031.001	R1/2*	25	55962.127.001	R1.1/4*	5	55962.317.001
R1/4*	50	55962.063.001	R3/4*	25	55962.191.001	R1.1/2*	5	55962.381.001
R3/8*	50	55962.096.001	R1 Inch*	10	55962.254.001			

Korki gwintowe z gniazdem sześciokątnym z walcowym gwintem metrycznym drzew.

2

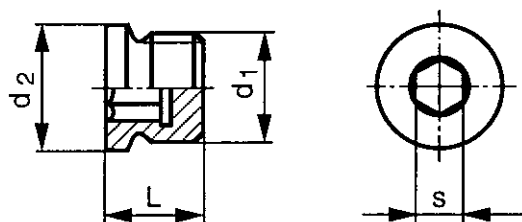

DIN 908

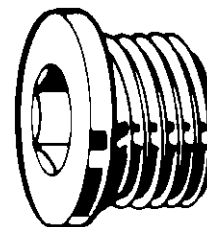

Informacje techniczne

d_1	d_2 (h14)	$L \approx$	s (D12)	d_1	d_2 (h14)	$L \approx$	s (D12)
M8 (#DIN)	12	10	4	M30	36	20	17
M10	14	11	5	M33	39	21	17
M12	17	15	6	M36	42	21	19
M14	19	15	6	M38	44	21	19
M16	21	15	8	M42	49	21	22
M18	23	16	8	M45	52	21	22
M20	25	18	10	M48	55	21	24
M22	27	18	10	M52	60	21	24
M24	29	18	12	M56	64	25	32
M26	31	20	12	M60	68	25	32
M27	32	20	12	M64	72	25	32

Grupy katalogowe

Gwint	Gniazdo	Materiał	Kod	Strona
M.drob.	Gniazdo sześciokątne	St	07640	2-94
M.drob.	Gniazdo sześciokątne	St.St. A4	55963	2-94

07640 Korki gwintowe z gniazdem sześciokątnym z walcowym gwintem metrycznym drzew.

D90A

Gwint Metryczny drobnozwojny
Materiał Stal

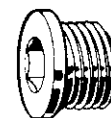

$d_1 \times P$	☒	Kod artykułu	$d_1 \times P$	☒	Kod artykułu	$d_1 \times P$	☒	Kod artykułu
M8X1,00	50	07640.080.100	M26X1,50	25	07640.260.150	M45X1,50	10	07640.450.150
M10X1,00	50	07640.100.100	M27X2,00	25	07640.270.200	M45X2,00	10	07640.450.200
M12X1,50	50	07640.120.150	M30X1,50	10	07640.300.150	M48X1,50	10	07640.480.150
M14X1,50	50	07640.140.150	M33X2,00	10	07640.330.200	M48X2,00	10	07640.480.200
M16X1,50	50	07640.160.150	M36X1,50	10	07640.360.150	M52X1,50	5	07640.520.150
M18X1,50	25	07640.180.150	M36X2,00	10	07640.360.200	M52X2,00	5	07640.520.200
M20X1,50	25	07640.200.150	M38X1,50	10	07640.380.150	M56X2,00	5	07640.560.200
M22X1,50	25	07640.220.150	M42X1,50	10	07640.420.150	M60X2,00	3	07640.600.200
M24X1,50	25	07640.240.150	M42X2,00	10	07640.420.200	M64X2,00	3	07640.640.200

55963 Korki gwintowe z gniazdem sześciokątnym z walcowym gwintem metrycznym drzew.

R49A

Gwint Metryczny drobnozwojny
Materiał Stal nierdzewna A4

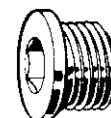

$d_1 \times P$	☒	Kod artykułu	$d_1 \times P$	☒	Kod artykułu	$d_1 \times P$	☒	Kod artykułu
M10X1,00	50	55963.100.100	M18X1,50*	50	55963.180.150	M26X1,50*	10	55963.260.150
M12X1,50*	50	55963.120.150	M20X1,50*	25	55963.200.150	M27X2,00*	10	55963.270.200
M14X1,50*	50	55963.140.150	M22X1,50*	25	55963.220.150	M30X1,50*	10	55963.300.150
M16X1,50*	50	55963.160.150	M24X1,50*	25	55963.240.150	M30X2,00*	10	55963.300.200

Korki z gniazdem sześciokątnym z walcowym gwintem rurowym

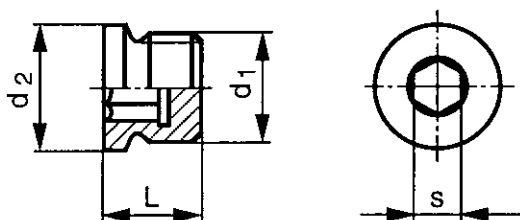

DIN 908

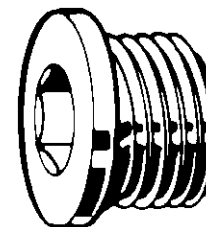

2

Informacje techniczne

d_1	d_2 (h14)	$L \approx$	s (D12)	Zwoje gwintu na cal
G1/8A	14	11	5	28
G1/4A	18	15	6	19
G3/8A	22	15	8	19
G1/2A	26	18	10	14
G3/4A	32	20	12	14
G1 Inch.A	39	21	17	11
G1.1/4A	49	21	22	11
G1.1/2A	55	21	24	11
G1.3/4A	62	25	32	11
G2 Inch.A	68	25	32	11

Grupy katalogowe

Gwint	Gniazdo	Materiał	Kod	Strona
G	Gniazdo sześciokątne	St	07620	2-95
G	Gniazdo sześciokątne	St.St. A2	51964	2-95
G	Gniazdo sześciokątne	St.St. A4	55964	2-95

07620 Korki z gniazdem sześciokątnym z walcowym gwintem rurowym

D90A

Gwint Rurowy
Material Stal

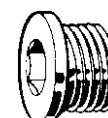

d_1	☒	Kod artykułu	d_1	☒	Kod artykułu	d_1	☒	Kod artykułu
G1/8A	50	07620.031.001	G1/2A	50	07620.127.001	G1.1/4A	10	07620.317.001
G1/4A	50	07620.063.001	G3/4A	25	07620.191.001	G1.1/2A	10	07620.381.001
G3/8A	50	07620.096.001	G1 Inch.A	25	07620.254.001			

51964 Korki z gniazdem sześciokątnym z walcowym gwintem rurowym

R09A

Gwint Rurowy
Material Stal nierdzewna A2

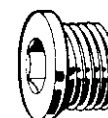

d_1	☒	Kod artykułu	d_1	☒	Kod artykułu	d_1	☒	Kod artykułu
G1/8A*	50	51964.031.001	G1/2A*	25	51964.127.001	G1.1/4A*	5	51964.317.001
G1/4A*	50	51964.063.001	G3/4A*	25	51964.191.001	G1.1/2A*	5	51964.381.001
G3/8A*	50	51964.096.001	G1 Inch.A*	10	51964.254.001	G2 Inch.A*	5	51964.508.001

55964 Korki z gniazdem sześciokątnym z walcowym gwintem rurowym

R49A

Gwint Rurowy
Material Stal nierdzewna A4

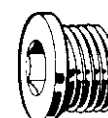

d_1	☒	Kod artykułu	d_1	☒	Kod artykułu	d_1	☒	Kod artykułu
G1/8A*	50	55964.031.001	G3/4A*	25	55964.191.001	G1.1/2A*	5	55964.381.001
G1/4A*	50	55964.063.001	G1 Inch.A*	10	55964.254.001	G1.3/4A*	5	55964.444.001
G3/8A	50	55964.096.001	G1.1/4A*	5	55964.317.001	G2 Inch.A*	5	55964.508.001
G1/2A*	25	55964.127.001						

Korki gwintowe z łbem sześciokątnym z walcowym gwintem metrycznym drbzw.

2

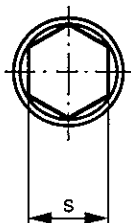
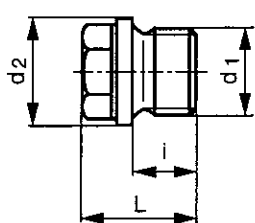

DIN 910

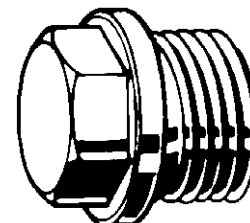

Informacje techniczne

d_1	d_2 (h14)	i	$L \approx$	s	d_1	d_2 (h14)	i	$L \approx$	s
M8 (#DIN)	14	8	17	10	M22	27	14	26	19
M10	14	8	17	10	M24	29	14	27	22
M12	17	12	21	13	M26	31	16	30	24
M14	19	12	21	13	M27	32	16	30	24
M16	21	12	21	17	M30	36	16	30	24
M18	23	12	24	17	M36	42	16	32	27
M20	25	14	26	19	M42	49	16	33	30

Grupy katalogowe

Gwint	Gniazdo	Materiał	Kod	Strona
M.drob.	Sześciokąt	St	07680	2-96
M.drob.	Sześciokąt	St.St. A2	51965	2-96
M.drob.	Sześciokąt	St.St. A4	55965	2-96

07680 Korki gwintowe z łbem sześciokątnym z walcowym gwintem metrycznym drobnozwojnym

D90A

Gwint Metryczny drobnozwojny
Materiał Stal

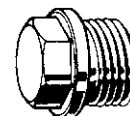

d_1 x P	☒	Kod artykułu	d_1 x P	☒	Kod artykułu	d_1 x P	☒	Kod artykułu
M8X1,00	50	07680.080.100	M18X1,50	25	07680.180.150	M26X1,50	25	07680.260.150
M10X1,00	50	07680.100.100	M20X1,50	25	07680.200.150	M30X1,50	10	07680.300.150
M12X1,50	50	07680.120.150	M22X1,50	25	07680.220.150	M36X1,50	10	07680.360.150
M14X1,50	50	07680.140.150	M24X1,50	25	07680.240.150	M42X1,50	10	07680.420.150
M16X1,50	50	07680.160.150						

51965 Korki gwintowe z łbem sześciokątnym z walcowym gwintem metrycznym drobnozwojnym

R09A

Gwint Metryczny drobnozwojny
Materiał Stal nierdzewna A2

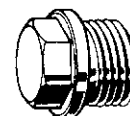

d_1 x P	☒	Kod artykułu	d_1 x P	☒	Kod artykułu	d_1 x P	☒	Kod artykułu
M10X1,00*	50	51965.100.100	M18X1,50*	50	51965.180.150	M26X1,50*	10	51965.260.150
M12X1,50*	50	51965.120.150	M20X1,50*	25	51965.200.150	M27X2,00*	10	51965.270.200
M14X1,50*	50	51965.140.150	M22X1,50*	25	51965.220.150	M30X1,50*	10	51965.300.150
M16X1,50*	50	51965.160.150	M24X1,50*	25	51965.240.150			

55965 Korki gwintowe z łbem sześciokątnym z walcowym gwintem metrycznym drobnozwojnym

R49A

Gwint Metryczny drobnozwojny
Materiał Stal nierdzewna A4

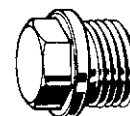

d_1 x P	☒	Kod artykułu	d_1 x P	☒	Kod artykułu	d_1 x P	☒	Kod artykułu
M10X1,00	25	55965.100.100	M18X1,50	10	55965.180.150	M26X1,50*	10	55965.260.150
M12X1,50	25	55965.120.150	M20X1,50	10	55965.200.150	M27X2,00*	10	55965.270.200
M14X1,50	25	55965.140.150	M22X1,50	10	55965.220.150	M30X1,50*	10	55965.300.150
M16X1,50	25	55965.160.150	M24X1,50	10	55965.240.150	M30X2,00*	5	55965.300.200

Korki gwintowe z łbem sześciokątnym z walcowym gwintem rurowym

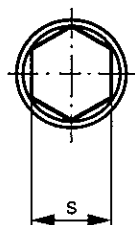
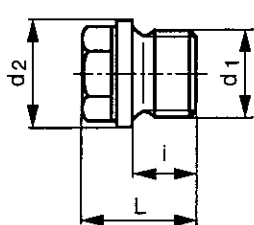

DIN 910

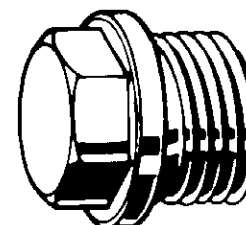

2

Informacje techniczne

d_1	d_2 (h14)	i	$L \approx$	s	Zwoje gwintu na cal
G1/8A	14	8	17	10	28
G1/4A	18	12	21	13	19
G3/8A	22	12	21	17	19
G3/8Ax8	22	8	17	17	19
G1/2A	26	14	26	19	14
G5/8A (#DIN)	28	14	26	19	14
G3/4A	32	16	30	24	14
G3/4Ax12	32	12	26	24	14
G1 Inch.A	39	16	32	27	11
G1.1/8A	44	16	32	27	11
G1.1/4A	49	16	33	30	11
G1.1/2A	55	16	33	30	11
G1.3/4A	62	20	40	36	11
G2 Inch.A	68	20	40	36	11
G2.1/2A (#DIN)	85	20	40	36	11

Grupy katalogowe

Gwint	Gniazdo	Materiał	Kod	Strona
G	Sześciokąt	St	07670	2-97
G	Sześciokąt	St.St. A2	51966	2-97
G	Sześciokąt	St.St. A4	55966	2-98
G	Sześciokąt	Mosiądz	47220	2-98

07670 Korki gwintowe z łbem sześciokątnym z walcowym gwintem rurowym

D90A

Gwint Rurowy
Materiał Stal

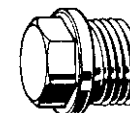

d_1	☒	Kod artykułu	d_1	☒	Kod artykułu	d_1	☒	Kod artykułu
G1/8A	50	07670.031.001	G1/2A	50	07670.127.001	G1.1/4A	10	07670.317.001
G1/4A	50	07670.063.001	G3/4A	25	07670.191.001	G1.1/2A	10	07670.381.001
G3/8A	50	07670.096.001	G3/4Ax12	25	07670.191.012	G2 Inch.A	10	07670.508.001
G3/8Ax8	50	07670.096.008	G1 Inch.A	25	07670.254.001	G2.1/2A (#DIN)	10	07670.635.001



51966 Korki gwintowe z łbem sześciokątnym z walcowym gwintem rurowym

R09A

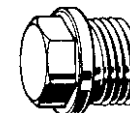

Gwint Rurowy
Materiał Stal nierdzewna A2

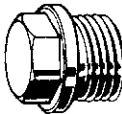

d_1	☒	Kod artykułu	d_1	☒	Kod artykułu	d_1	☒	Kod artykułu
G1/8A*	50	51966.031.001	G1/2A*	25	51966.127.001	G1.1/4A*	5	51966.317.001
G1/4A*	50	51966.063.001	G3/4A*	25	51966.191.001	G1.1/2A*	5	51966.381.001
G3/8A*	50	51966.096.001	G1 Inch.A*	10	51966.254.001	G2 Inch.A*	5	51966.508.001

55966	Korki gwintowe z łbem sześciokątnym z walcowym gwintem rurowym	R49A
Gwint	Rurowy	
Materiał	Stal nierdzewna A4	
		

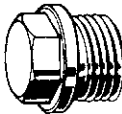
d_1	☒	Kod artykułu	d_1	☒	Kod artykułu	d_1	☒	Kod artykułu
G1/8A	50	55966.031.001	G5/8A*	25	55966.158.001	G1.1/4A	5	55966.317.001
G1/4A	25	55966.063.001	G3/4A	10	55966.191.001	G1.1/2A*	5	55966.381.001
G3/8A	25	55966.096.001	G1 Inch.A	10	55966.254.001	G1.3/4A*	5	55966.444.001
G1/2A	25	55966.127.001	G1.1/8A*	5	55966.285.001	G2 Inch.A*	5	55966.508.001

47220	Korki gwintowe z łbem sześciokątnym z walcowym gwintem rurowym	M01A
Gwint	Rurowy	
Materiał	Mosiądz	
		

d_1	☒	Kod artykułu	d_1	☒	Kod artykułu	d_1	☒	Kod artykułu
G1/4A	100	47220.063.001	G1/2A	50	47220.127.001	G1 Inch.A	10	47220.254.001
G3/8A	50	47220.096.001	G3/4A	25	47220.191.001			

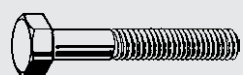

1 Śruby



2 Produkty z gniazdem sześciokątnym



3 Nakrętki, nitonakrętki & wkładki



4 Pręty gwintowane & śruby dwustronne



5 Haki & śruby oczkowe



6 Wkręty

I Index



7 Podkładki & pierścienie uszczelniające typu “O-ring”



8 Kotwy, kołki, dyble



9 Nity, kołki & wpusty



10 Elementy łączące systemowe, meblowe & zabezpieczające

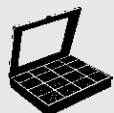

11 Zestawy

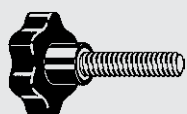

12 Części konstrukcyjne & części maszynowe



13 Przemysł morski

T Technologia łączenia

Nakrętki, nitonakrętki & wkładki³

3

 Strona 3-5 DIN 934 (1987) DIN, metryczna	 Strona 3-14 DIN 934 (1987) Metryczna, drobny gwint	 Strona 3-17 ISO 4032 ISO, metryczna	 Strona 3-20 ASME ≈B18.2.2 UNC	 Strona 3-23 ASME ≈B18.2.2 Nacinana maszynowo, UNC
 Strona 3-23 ASME ≈B18.2.2 UNF	 Strona 3-26 ASME ≈B18.2.2 Nacinana maszynowo, UNF	 Strona 3-27 DIN ≈934 (1954) BSW	 Strona 3-28 BS ≈1083 (1965) BSF	 Strona 3-29 DIN ≈934 (1987) 1xd, metryczna
 Strona 3-30 DIN ≈934 (1954) 1xd BSW	 Strona 3-31 DIN 555 (1987) ≥ 4 , metryczna	 Strona 3-32 DIN 439 B (1987) Metryczna, niska	 Strona 3-35 DIN 439 B (1987) Metryczna, niska, drobny gwint	 Strona 3-38 DIN 936 Metryczna, niska
 Strona 3-39 DIN 936 Metryczna, niska, drobny gwint	 Strona 3-39 ISO 4035 Metryczna, niska	 Strona 3-40 ASME ≈B18.2.2 UNC niska	 Strona 3-40 DIN 431 A Do rur	 Strona 3-41 Nakrętki, typ caterpillar, UNF
 Strona 3-42 Nakrętki do wydechów	 Strona 3-43 DIN 6334 3xd, metryczna	 Strona 3-45 Wysoka metryczna	 Strona 3-46 Z wewnętrznym i zewnętrznym gwintem	 Strona 3-47 Z gwintem wewnętrznym z obu stron
 Strona 3-47 Zwężki rurowe	 Strona 3-48 DIN 985 (1987) Samohamowna, metryczna	 Strona 3-52 DIN 985 (1987) Metryczna, drobny gwint	 Strona 3-53 DIN 982 Samohamowna, wysoka, metryczna	 Strona 3-55 ASME B18.16.6 NE UNC
 Strona 3-57 ASME B18.16.6 NTE UNC	 Strona 3-58 ASME B18.16.6 NTE UNF	 Strona 3-59 ASME B18.16.6 NU UNC	 Strona 3-60 ASME B18.16.6 NTU UNC	 Strona 3-61 ASME B18.16.6 NE UNF
 Strona 3-63 BSW	 Strona 3-63 BSF	 Strona 3-64 Zabezpieczająca, metryczna	 Strona 3-65 Plastikowe, Metryczna	 Strona 3-65 DIN 980V(1987) Zabezpieczająca, metryczna
 Strona 3-67 DIN 980V(1987) Metryczna, drobny gwint	 Strona 3-68 IFI 100/107 Toplock UNC	 Strona 3-69 IFI 100/107 Toplock UNF	 Strona 3-71 Typ H100-ESN, metryczna	 Strona 3-72 Typ H130-ESN, metryczna
 Strona 3-73 Typ USN, metryczna	 Strona 3-73 RIPP, metryczna	 Strona 3-74 SECURIT, metryczna	 Strona 3-75 Nakrętka sześciokątna samozabezpieczająca	 Strona 3-76 DIN 6923 (1983) Z kołnierzem, metryczna

Nakrętki, nitonakrętki & wkładki 3

3

 <p>Strona 3-78 DIN ≈6923</p> <p>Z ząbkowanym kołnierzem, metryczna</p>	 <p>Strona 3-80 IFI-100/107</p> <p>Kołnierzowa UNC</p>	 <p>Strona 3-81 DIN 6926</p> <p>Z plastikową wkładką, metryczna</p>	 <p>Strona 3-82 DIN ≈6926</p> <p>Z kołnierzem ząbkowanym i wkładką</p>	 <p>Strona 3-83</p> <p>NORD-LOCK</p>
 <p>Strona 3-83</p> <p>Z kołnierzem stożkowym</p>	 <p>Strona 3-84</p> <p>COMBY, metryczna</p>	 <p>Strona 3-84 DIN 7967</p> <p>PAL, metryczna</p>	 <p>Strona 3-86 DIN 935-1</p> <p>Koronowa metryczna</p>	 <p>Strona 3-88 DIN 935</p> <p>Metryczna, drobny gwint</p>
 <p>Strona 3-89 DIN 979</p> <p>Niska, metryczna</p>	 <p>Strona 3-90 DIN 937</p> <p>Niska metryczna</p>	 <p>Strona 3-91 DIN 979</p> <p>Niska, metryczna, drobny gwint</p>	 <p>Strona 3-92 BS ≈1768</p> <p>UNF</p>	 <p>Strona 3-94</p> <p>KALEI, metryczna</p>
 <p>Strona 3-96</p> <p>Okrągła, metryczna</p>	 <p>Strona 3-97 DIN 1587 (1987)</p> <p>Kołpakowa metryczna</p>	 <p>Strona 3-99</p> <p>Kołpakowa BSW</p>	 <p>Strona 3-100</p> <p>Spawana metryczna</p>	 <p>Strona 3-101 DIN 917</p> <p>Ślepa metryczna</p>
 <p>Strona 3-102 DIN 986</p> <p>Z plastikową wkładką, metryczna</p>	 <p>Strona 3-103 ASME ≈B18.17</p> <p>Model amerykański, metryczna</p>	 <p>Strona 3-104 DIN 315</p> <p>Okrągłe skrzydełka, metryczna</p>	 <p>Strona 3-106 DIN ≈313 (1956)</p> <p>BSW</p>	 <p>Strona 3-107 DIN 80701</p> <p>Nakrętka motylkowa cysternowa</p>
 <p>Strona 3-107 DIN 80704</p> <p>Nakrętka z uchem</p>	 <p>Strona 3-108</p> <p>Z kołnierzem, metryczna, plastik</p>	 <p>Strona 3-108</p> <p>Metryczna, plastik</p>	 <p>Strona 3-109 DIN 929</p> <p>Do zgrzewania, sześciokątna</p>	 <p>Strona 3-110</p> <p>Z kołnierzem, metryczna</p>
 <p>Strona 3-111</p> <p>Zgrzewana punktowo, metryczna</p>	 <p>Strona 3-112 DIN 928</p> <p>Do zgrzewania, kwadratowa</p>	 <p>Strona 3-113 DIN 466</p> <p>Radełkowana, wysoka</p>	 <p>Strona 3-114 DIN 467</p> <p>Radełkowana, niska</p>	 <p>Strona 3-115</p> <p>Radełkowana, plastik</p>
 <p>Strona 3-116 DIN 562</p> <p>Kwadratowa, niska</p>	 <p>Strona 3-117 DIN 557</p> <p>Kwadratowa, metryczna</p>	 <p>Strona 3-118</p> <p>Metryczna</p>	 <p>Strona 3-119</p> <p>Nakrętka koszykowa, typ SMG</p>	 <p>Strona 3-120</p> <p>Nakrętka szybkiego montażu</p>
 <p>Strona 3-121</p> <p>Jacknut wkładka gwintowa</p>	 <p>Strona 3-122 DIN 1804 W</p> <p>Nakrętka łożyskowa</p>	 <p>Strona 3-123 DIN 546</p> <p>Z rowkiem, metryczna</p>	 <p>Strona 3-124</p> <p>Okrągła, metryczna</p>	 <p>Strona 3-125</p> <p>Nakrętka łożyskowa drobny gwint, Typ GUK</p>
 <p>Strona 3-126</p> <p>Z rowkiem, metryczna</p>	 <p>Strona 3-128</p> <p>Nitonakrętki walcowe</p>	 <p>Strona 3-129</p> <p>Nitonakrętki walcowe stal nierdzewna</p>	 <p>Strona 3-130</p> <p>Nitonakrętki z trzpieniem 6-kątnym stal nierdzewna</p>	 <p>Strona 3-131</p> <p>Nitonakrętki stożkowe, otwarte, stal ocynk</p>

Nakrętki, nitonakrętki & wkładki **3**

 Strona 3-132 Nitonakrętka stożkowa, stal nierdzewna	 Strona 3-133 Nitonakrętka stożkowa, aluminium	 Strona 3-134 Nitonakrętka kołnier stożkowa obniżona st. ocynk	 Strona 3-134 Nitonakrętka kołnier stożkowa obniżona stal nierdz.	 Strona 3-135 Nitonakrętka kołnier stożkowa obniżona aluminium
 Strona 3-135 Nitonakrętka kołn. stożkowa obniżona, ocynk, otwarte	 Strona 3-136 Nitonakrętka kołn. stożkowa obn. nierdz. otwarte	 Strona 3-136 Nitonakrętka walcowa, zamknięta, stal ocynk	 Strona 3-137 Nitonakrętka walcowa, zamknięta, aluminium	 Strona 3-138 Nitonakrętka stożkowa, zamknięta, stal ocynk
 Strona 3-139 Nitośruby z kołnierzem walcowym, ocynk	 Strona 3-140 FABORY Nitownica ręczna do nitonakrętek	 Strona 3-141 Zestaw do nitonakrętek w walizce	 Strona 3-143 AMECOIL Gwintownik maszynowy metryczny	 Strona 3-144 AMECOIL gwintownik masz. drobnozwojny
 Strona 3-144 AMECOIL, gwintownik (świece zapłonowe)	 Strona 3-145 AMECOIL, gwintownik maszynowy, UNC	 Strona 3-145 AMECOIL, gwintownik maszynowy, UNF	 Strona 3-146 AMECOIL, metryczna DIN 8140-1A	 Strona 3-147 AMECOIL, metryczna drobna DIN 8140-1A
 Strona 3-147 AMECOIL, metryczna bardzo drobna DIN 8140-1A	 Strona 3-148 AMECOIL, UNC	 Strona 3-149 AMECOIL, UNF	 Strona 3-149 AMECOIL, metryczne	 Strona 3-150 AMECOIL, metryczny drobny
 Strona 3-150 AMECOIL, metryczny bardzo drobny	 Strona 3-151 AMECOIL, UNC	 Strona 3-152 AMECOIL, UNF	 Strona 3-152 AMECOIL, BSW	 Strona 3-153 AMECOIL Zestaw naprawczy
 Strona 3-154 AMECOIL narzędzie do osadzania wkładek	 Strona 3-155 AMECOIL narzędzie do osadzania wkładek z wypos.	 Strona 3-156 AMECOIL końcówki do narzędzi osadzających	 Strona 3-158 AMECOIL łącznik	 Strona 3-159 AMECOIL trzpień do odłamania
 Strona 3-159 AMECOIL, wyciągacz	 Strona 3-160 V-COIL Rapid zestaw metryczny	 Strona 3-160 V-COIL zestaw do gwintów metrycznych	 Strona 3-161 V-COIL zestaw do gwintów niemetrycznych	 Strona 3-162 V-COIL zestaw do świec zapłonowych
 Strona 3-163 V-COIL Asortyment Metryczny	 Strona 3-164 V-COIL Asortyment Metryczny Rapid	 Strona 3-164 V-COIL Asortyment Niemetryczny	 Strona 3-166 Narzędzia V-COIL	 Strona 3-169 Narzędzia V-COIL Rapid
 Strona 3-172 Wkładki samogwintujące typ 302	 Strona 3-173 Wkładki samogwintujące typ 307-308	 Strona 3-174 Wkładki samogwintujące typ 302 2	 Strona 3-175 Wkładki samogwintujące typ 308 2	 Strona 3-176 Narzędzie do wkładek typ 610

Nakrętki, nitonakrętki & wkładki **3**

3

<p>Strona 3-176</p>  <p>Narzędzie typ 620</p>	<p>Strona 3-177</p>  <p>Części do typu 620</p>	<p>Strona 3-178</p>  <p>Narzędzie typ 6102</p>
--	---	---

Nakrętki sześciokątne

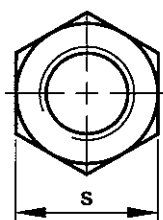
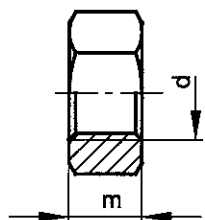

DIN 934 (1987)
NEN 1560
NF E25-401

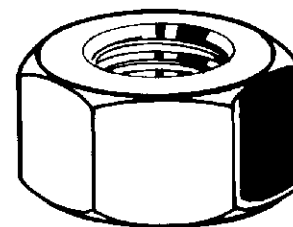

Informacje techniczne

d	m	P	s	d	m	P	s
M1	0.8	0.25	2.5	M20	16	2.5	30
M1.2	1	0.25	3	M22	18	2.5	32
M1.4	1.2	0.3	3	M24	19	3	36
M1.6	1.3	0.35	3.2	M27	22	3	41
M1.7 (#DIN)	1.4	0.35	3.5	M30	24	3.5	46
M2	1.6	0.4	4	M33	26	3.5	50
M2.3 (#DIN)	1.8	0.4	4.5	M36	29	4	55
M2.5	2	0.45	5	M39	31	4	60
M2.6 (#DIN)	2	0.45	5	M42	34	4.5	65
M3	2.4	0.5	5.5	M45	36	4.5	70
M3.5	2.8	0.6	6	M48	38	5	75
M4	3.2	0.7	7	M52	42	5	80
M5	4	0.8	8	M56	45	5.5	85
M6	5	1	10	M60	48	5.5	90
M7	5.5	1	11	M64	51	6	95
M8	6.5	1.25	13	M68	54	6	100
M10 (#DIN)	8	1.5	15	M72X6	58	6	105
M10	8	1.5	17	M76X6	61	6	110
M12	10	1.75	19	M80X6	64	6	115
M14	11	2	22	M90X6	72	6	130
M16	13	2	24	M100X6	80	6	145
M18	15	2.5	27	M110X6	88	6	155

Grupy katalogowe

Gwint	Gniazdo	Materiał	Klasa	Obróbka powierzchni	Kolor	Kod	Strona
M	Sześciokąt	St	8			01100	3-6
M	Sześciokąt	St	8		Duże Opakowanie	01110	3-6
M	Sześciokąt	St	8		lewy gwint	11040	3-6
M	Sześciokąt	St	8	ZNTHP-NC6		01325	3-6
M	Sześciokąt	St	8	Ocynk.		01300	3-7
M	Sześciokąt	St	8	Ocynk.	Duże Opakowanie	01310	3-7
M	Sześciokąt	St	8	Ocynk.	lewy gwint	11042	3-7
M	Sześciokąt	St	8	Ocynk. żłt. pas.		01320	3-7
M	Sześciokąt	St	8	Ocynk. czrn. pas.		01326	3-7
M	Sześciokąt	St	8	FLZNNC-NC6		01336	3-8
M	Sześciokąt	St	8	Ocynk. gor.	izometryczna	01500	3-8
M	Sześciokąt	St	8	Ocynk. gor.	nadwymiarowa	01560	3-8
M	Sześciokąt	St	10			04120	3-8
M	Sześciokąt	St	10	Ocynk.		04121	3-9
M	Sześciokąt	St	10	Ocynk. żłt. pas.		04122	3-9
M	Sześciokąt	St	10	Ocynk. gor.	nadwymiarowa	04119	3-9
M	Sześciokąt	St	10	FLZNNC-NC6		04125	3-9
M	Sześciokąt	St	12			04190	3-9
M	Sześciokąt	Stal automatowa	6	Ocynk.	toczona	11300	3-10
M	Sześciokąt	St.St. A2	70			51080	3-10
M	Sześciokąt	St.St. A2	70		Duże Opakowanie	51100	3-10
M	Sześciokąt	St.St. A2	70	COMBIFLON		51082	3-10
M	Sześciokąt	St.St. A2	70	METALFORM		51089	3-11
M	Sześciokąt	St.St. A2	70		lewy gwint	51162	3-11
M	Sześciokąt	St.St. A2	80			53080	3-11
M	Sześciokąt	St.St. A4	70			55080	3-11
M	Sześciokąt	St.St. A4	70		Duże Opakowanie	55100	3-12
M	Sześciokąt	St.St. A4	80			53580	3-12
M	Sześciokąt	St.St. A4	80		lewy gwint	53162	3-12
M	Sześciokąt	St.St. A5	70			55089	3-12
M	Sześciokąt	Al P40				45080	3-12
M	Sześciokąt	Al P60		Anod. żółto		45280	3-13

Grupy katalogowe

Gwint	Gniazdo	Materiał	Klasa	Obróbka powierzchni	Kolor	Kod	Strona
M	Sześciokąt	Kuprodr Cu5	60			45850	3-13
M	Sześciokąt	Ti	Gr.2			45920	3-13
M	Sześciokąt	Mosiądz Cu2/Cu3				47000	3-13
M	Sześciokąt	Mosiądz Cu2/Cu3		Nikl.		47050	3-13
M	Sześciokąt	Plastik PA	PA 6.6		Biały	56200	3-14

3

01100 Nakrętki sześciokątne A01B

Gwint	Metryczny
Materiał	Stal
Klasa	8



d	☒	Kod artykułu	d	☒	Kod artykułu	d	☒	Kod artykułu
M2,5	250	01100.025.001	M20	50	01100.200.001	M52	1	01100.520.001
M3	250	01100.030.001	M22	25	01100.220.001	M56	1	01100.560.001
M4	250	01100.040.001	M24	25	01100.240.001	M60	1	01100.600.001
M5	250	01100.050.001	M27	10	01100.270.001	M64	1	01100.640.001
M6	250	01100.060.001	M30	10	01100.300.001	M68	1	01100.680.001
M7	250	01100.070.001	M33	5	01100.330.001	M72X6,00	1	01100.720.001
M8	250	01100.080.001	M36	5	01100.360.001	M76X6,00	1	01100.760.001
M10	250	01100.100.001	M39	5	01100.390.001	M80X6,00	1	01100.800.001
M12	100	01100.120.001	M42	5	01100.420.001	M90X6,00	1	01100.900.001
M14	100	01100.140.001	M45	4	01100.450.001	M100X6,00	1	01100.982.001
M16	100	01100.160.001	M48	4	01100.480.001	M110X6,00	1	01100.984.001
M18	50	01100.180.001						

01110 Nakrętki sześciokątne A01B

Gwint	Metryczny
Materiał	Stal
Klasa	8

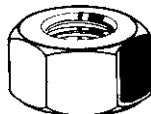
d	☒	Kod artykułu	d	☒	Kod artykułu	d	☒	Kod artykułu
M3	2500	01110.030.001	M10	1000	01110.100.001	M20	150	01110.200.001
M4	2500	01110.040.001	M12	700	01110.120.001	M24	50	01110.240.001
M5	2500	01110.050.001	M14	400	01110.140.001	M27	50	01110.270.001
M6	2000	01110.060.001	M16	300	01110.160.001	M30	50	01110.300.001
M8	2000	01110.080.001	M18	200	01110.180.001	M68	5	01110.680.001

11040 Nakrętki sześciokątne z lewym gwintem F01A

Gwint	Metryczny
Materiał	Stal
Klasa	8



d	☒	Kod artykułu	d	☒	Kod artykułu	d	☒	Kod artykułu
M4	250	11040.040.001	M14	50	11040.140.001	M30	5	11040.300.001
M5	250	11040.050.001	M16	50	11040.160.001	M33	2	11040.330.001
M6	250	11040.060.001	M18	25	11040.180.001	M36	2	11040.360.001
M8	100	11040.080.001	M20	25	11040.200.001	M39	2	11040.390.001
M10	100	11040.100.001	M22	10	11040.220.001	M42	2	11040.420.001
M10 s=15	100	11040.100.150	M24	10	11040.240.001	M48	2	11040.480.001
M12	50	11040.120.001	M27	5	11040.270.001			

01325 Nakrętki sześciokątne A95A

Gwint	Metryczny
Materiał	Stal
Klasa	8
Obróbka powierzchni	O cynk, gruba pasywacja Cr ³⁺



d	☒	Kod artykułu	d	☒	Kod artykułu	d	☒	Kod artykułu
M4	250	01325.040.001	M8	250	01325.080.001	M12	100	01325.120.001
M5	250	01325.050.001	M10	250	01325.100.001	M16	100	01325.160.001
M6	250	01325.060.001						

01300 Nakrętki sześciokątne		A05B
Gwint	Metryczny	
Materiał	Stal	
Klasa	8	
Obróbka powierzchni	Ocynkowane	
		

d	☒	Kod artykułu	d	☒	Kod artykułu	d	☒	Kod artykułu
M2	1000	01300.020.001	M14	100	01300.140.001	M36	5	01300.360.001
M2,5	1000	01300.025.001	M16	100	01300.160.001	M39	5	01300.390.001
M3	250	01300.030.001	M18	50	01300.180.001	M42	5	01300.420.001
M4	250	01300.040.001	M20	50	01300.200.001	M45	4	01300.450.001
M5	250	01300.050.001	M22	25	01300.220.001	M48	4	01300.480.001
M6	250	01300.060.001	M24	25	01300.240.001	M52	1	01300.520.001
M7	250	01300.070.001	M27	10	01300.270.001	M56	1	01300.560.001
M8	250	01300.080.001	M30	10	01300.300.001	M60	1	01300.600.001
M10	250	01300.100.001	M33	5	01300.330.001	M64	1	01300.640.001
M12	100	01300.120.001						

3

01310 Nakrętki sześciokątne		A05B
Gwint	Metryczny	
Materiał	Stal	
Klasa	8	
Obróbka powierzchni	Ocynkowane	
		

d	☒	Kod artykułu	d	☒	Kod artykułu	d	☒	Kod artykułu
M3	2500	01310.030.001	M10	1000	01310.100.001	M20	150	01310.200.001
M4	2500	01310.040.001	M12	700	01310.120.001	M24	50	01310.240.001
M5	2500	01310.050.001	M14	400	01310.140.001	M27	50	01310.270.001
M6	2000	01310.060.001	M16	300	01310.160.001	M30	50	01310.300.001
M8	2000	01310.080.001	M18	200	01310.180.001			

11042 Nakrętki sześciokątne z lewym gwintem		F01A
Gwint	Metryczny	
Materiał	Stal	
Klasa	8	
Obróbka powierzchni	Ocynkowane	
		

d	☒	Kod artykułu	d	☒	Kod artykułu	d	☒	Kod artykułu
M4	250	11042.040.001	M8	100	11042.080.001	M16	50	11042.160.001
M5	250	11042.050.001	M10	100	11042.100.001	M24	25	11042.240.001
M6	250	11042.060.001	M12	50	11042.120.001			



01320 Nakrętki sześciokątne		A06A
Gwint	Metryczny	
Materiał	Stal	
Klasa	8	
Obróbka powierzchni	Ocynkowane, po żółtej pasywacji	

d	☒	Kod artykułu	d	☒	Kod artykułu	d	☒	Kod artykułu
M3	250	01320.030.001	M12	100	01320.120.001	M27	10	01320.270.001
M4	250	01320.040.001	M14	100	01320.140.001	M30	10	01320.300.001
M5	250	01320.050.001	M16	100	01320.160.001	M33	5	01320.330.001
M6	250	01320.060.001	M18	50	01320.180.001	M36	5	01320.360.001
M7	250	01320.070.001	M20	50	01320.200.001	M39	5	01320.390.001
M8	250	01320.080.001	M22	25	01320.220.001	M42	5	01320.420.001
M10	250	01320.100.001	M24	25	01320.240.001			

01326 Nakrętki sześciokątne		A06A
Gwint	Metryczny	
Materiał	Stal	
Klasa	8	
Obróbka powierzchni	Ocynkowane, po czarnej pasywacji	

d	☒	Kod artykułu	d	☒	Kod artykułu	d	☒	Kod artykułu
M3	250	01326.030.001	M5	250	01326.050.001	M8	250	01326.080.001
M4	250	01326.040.001	M6	250	01326.060.001	M10	250	01326.100.001

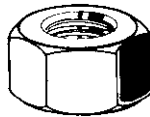
01326 Nakrętki sześciokątne								
d	☒	Kod artykułu	d	☒	Kod artykułu	d	☒	Kod artykułu
M12	100	01326.120.001	M16	100	01326.160.001	M24	25	01326.240.001
M14	100	01326.140.001	M20	50	01326.200.001			



01336 Nakrętki sześciokątne								A96A
Gwint	Metryczny							
Materiał	Stal							
Klasa	8							
Obróbka powierzchni	O cynk płatkowy bez Cr6+ wg ISO 10683 (fIZnnc)							
								

d	☒	Kod artykułu	d	☒	Kod artykułu	d	☒	Kod artykułu
M4	250	01336.040.001	M12	700	01336.120.001	M22	125	01336.220.001
M5	250	01336.050.001	M14	400	01336.140.001	M24	50	01336.240.001
M6	2000	01336.060.001	M16	300	01336.160.001	M27	50	01336.270.001
M8	2000	01336.080.001	M18	200	01336.180.001	M30	50	01336.300.001
M10	1000	01336.100.001	M20	150	01336.200.001	M36	25	01336.360.001

01500 Nakrętki sześciokątne z gwintem montażowym								A08A
Gwint	Metryczny							
Materiał	Stal							
Klasa	8							
Obróbka powierzchni	O cynkowane na gorąco							
								

d	☒	Kod artykułu	d	☒	Kod artykułu	d	☒	Kod artykułu
M6	100	01500.060.001	M18	50	01500.180.001	M33	5	01500.330.001
M8	100	01500.080.001	M20	50	01500.200.001	M36	5	01500.360.001
M10	100	01500.100.001	M22	50	01500.220.001	M39	3	01500.390.001
M12	100	01500.120.001	M24	50	01500.240.001	M42	3	01500.420.001
M14	100	01500.140.001	M27	10	01500.270.001	M45	4	01500.450.001
M16	50	01500.160.001	M30	10	01500.300.001	M48	4	01500.480.001

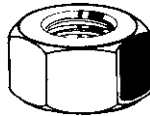
- Te nakrętki sześciokątne są stosowane między innymi do śrub cynkowanych na gorąco i wkrętów z gwintem IZOMETRYCZNYM DOPASOWANYM, jak również do cynkowanych na gorąco prętów gwintowanych z gwintem IZOMETRYCZNYM DOPASOWANYM.
- Nakrętki są gwintowane po cynkowaniu i odpowiadają klasie tolerancji 6H. Mimo braku powłoki na gwincie nakrętka zamontowana nie ma obniżonej odporności antykorozyjnej.

01560 Nakrętki sześciokątne z nadwymiarowym gwintem								A08A
Gwint	Metryczny							
Materiał	Stal							
Klasa	8							
Obróbka powierzchni	O cynkowane na gorąco							
								

d	☒	Kod artykułu	d	☒	Kod artykułu	d	☒	Kod artykułu
M8	250	01560.080.001	M22	25	01560.220.001	M42	5	01560.420.001
M10	250	01560.100.001	M24	25	01560.240.001	M45	4	01560.450.001
M12	100	01560.120.001	M27	25	01560.270.001	M48	4	01560.480.001
M14	100	01560.140.001	M30	10	01560.300.001	M52	1	01560.520.001
M16	100	01560.160.001	M33	5	01560.330.001	M56	1	01560.560.001
M18	50	01560.180.001	M36	5	01560.360.001	M60	1	01560.600.001
M20	50	01560.200.001	M39	5	01560.390.001	M64	1	01560.640.001

- Te nakrętki sześciokątne są stosowane między innymi do śrub cynkowanych na gorąco z gwintem NADWYMIAROWYM i wkrętów z gwintem NADWYMIAROWYM, jak również do cynkowanych na gorąco prętów gwintowanych z gwintem NADWYMIAROWYM.
- Po cynkowaniu nakrętki są gwintowane nadwymiarowo wg ISO 965-5 co daje idealne dopasowanie do nadwymiarowego gwintu śruby w gorącym ocynku.
- Mimo braku powłoki na gwincie nakrętka zamontowana nie ma obniżonej odporności antykorozyjnej.

04120 Nakrętki sześciokątne								C01C
Gwint	Metryczny							
Materiał	Stal							
Klasa	10							
								

d	☒	Kod artykułu	d	☒	Kod artykułu	d	☒	Kod artykułu
M5	250	04120.050.001	M18	50	04120.180.001	M33	5	04120.330.001
M6	250	04120.060.001	M20	50	04120.200.001	M36	5	04120.360.001
M8	250	04120.080.001	M22	25	04120.220.001	M39	5	04120.390.001
M10	250	04120.100.001	M24	25	04120.240.001	M42	5	04120.420.001
M12	100	04120.120.001	M27	25	04120.270.001	M48	5	04120.480.001
M14	100	04120.140.001	M30	25	04120.300.001	M56	5	04120.560.001
M16	100	04120.160.001						

04121 Nakrętki sześciokątne				C01C				
Gwint	Metryczny							
Materiał	Stal							
Klasa	[10]							
Obróbka powierzchni	Ocynkowane							
d	☒	Kod artykułu	d	☒	Kod artykułu	d	☒	Kod artykułu
M3	250	04121.030.001	M10	250	04121.100.001	M20	50	04121.200.001
M4	250	04121.040.001	M12	100	04121.120.001	M24	25	04121.240.001
M5	250	04121.050.001	M14	100	04121.140.001	M30	25	04121.300.001
M6	250	04121.060.001	M16	100	04121.160.001	M36	10	04121.360.001
M8	250	04121.080.001						

3

04122 Nakrętki sześciokątne				C03A				
Gwint	Metryczny							
Materiał	Stal							
Klasa	[10]							
Obróbka powierzchni	Ocynkowane, po żółtej pasywacji							
d	☒	Kod artykułu	d	☒	Kod artykułu	d	☒	Kod artykułu
M6	250	04122.060.001	M12	100	04122.120.001	M18	50	04122.180.001
M8	250	04122.080.001	M14	100	04122.140.001	M20	20	04122.200.001
M10	250	04122.100.001	M16	100	04122.160.001	M24	25	04122.240.001

04119 Nakrętka sześciokątna z gwintem nadwymiarowym				C01A				
Gwint	Metryczny							
Materiał	Stal							
Klasa	[10]							
Obróbka powierzchni	Ocynkowane na gorąco							
d	☒	Kod artykułu	d	☒	Kod artykułu	d	☒	Kod artykułu
M10	500	04119.100.001	M20	100	04119.200.001	M30	25	04119.300.001
M12	100	04119.120.001	M24	50	04119.240.001	M36	15	04119.360.001
M16	100	04119.160.001	M27	25	04119.270.001			

- Te nakrętki sześciokątne są stosowane między innymi do śrub cynkowanych na gorąco z gwintem NADWYMIAROWYM i wkrętów z gwintem NADWYMIAROWYM, jak również do cynkowanych na gorąco gwintowanych prętów z gwintem NADWYMIAROWYM.
- Po cynkowaniu nakrętki są gwintowane nadwymiarowo wg ISO 965-5 co daje idealne dopasowanie do nadwymiarowego gwintu śruby w gorącym ocynku.
- Mimo braku powłoki na gwincie nakrętka zamontowana nie ma obniżonej odporności antykorozyjnej.

04125 Nakrętki sześciokątne				C02A				
Gwint	Metryczny							
Materiał	Stal							
Klasa	[10]							
Obróbka powierzchni	Ocynk płatkowy bez Cr6+ wg ISO 10683 (flZnnc)							
d	☒	Kod artykułu	d	☒	Kod artykułu	d	☒	Kod artykułu
M4	250	04125.040.001	M10	250	04125.100.001	M20	50	04125.200.001
M5	250	04125.050.001	M12	100	04125.120.001	M24	25	04125.240.001
M6	250	04125.060.001	M14	100	04125.140.001	M30	25	04125.300.001
M8	250	04125.080.001	M16	100	04125.160.001			

04190 Nakrętki sześciokątne				C01C				
Gwint	Metryczny							
Materiał	Stal							
Klasa	[12]							
Obróbka powierzchni								
d	☒	Kod artykułu	d	☒	Kod artykułu	d	☒	Kod artykułu
M6	250	04190.060.001	M14	100	04190.140.001	M24	25	04190.240.001
M8	250	04190.080.001	M16	100	04190.160.001	M30	25	04190.300.001
M10	250	04190.100.001	M20	50	04190.200.001	M36	10	04190.360.001
M12	100	04190.120.001						

11300 Nakrętki sześciokątne toczone F01A

Gwint Metryczny
 Materiał Stal automatowa
 Klasa [6]
 Obróbka powierzchni Ocynkowane

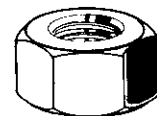

d	☒	Kod artykułu	d	☒	Kod artykułu	d	☒	Kod artykułu
M1,6	500	11300.016.001	M2,3	500	11300.023.001	M2,6	500	11300.026.001
M2	500	11300.020.001	M2,5	500	11300.025.001	M3,5	250	11300.035.001

3
51080 Nakrętki sześciokątne Q01A

Gwint Metryczny
 Materiał Stal nierdzewna A2
 Klasa 70

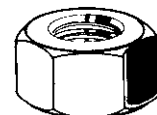

d	☒	Kod artykułu	d	☒	Kod artykułu	d	☒	Kod artykułu
M1	200	51080.010.001	M7	200	51080.070.001	M27	10	51080.270.001
M1,2	200	51080.012.001	M8	200	51080.080.001	M30	5	51080.300.001
M1,4	200	51080.014.001	M10	200	51080.100.001	M33	5	51080.330.001
M1,6	200	51080.016.001	M12	200	51080.120.001	M36	5	51080.360.001
M2	500	51080.020.001	M14	100	51080.140.001	M39	5	51080.390.001
M2,5	500	51080.025.001	M16	100	51080.160.001	M42	5	51080.420.001
M3	500	51080.030.001	M18	50	51080.180.001	M45	5	51080.450.001
M4	500	51080.040.001	M20	50	51080.200.001	M48	5	51080.480.001
M5	500	51080.050.001	M22	20	51080.220.001	M52*	5	51080.520.001
M6	500	51080.060.001	M24	20	51080.240.001			

• Rozmiary o średnicy > M24 mają minimalnie klasę właściwości 50.

51100 Nakrętki sześciokątne Q01A

Gwint Metryczny
 Materiał Stal nierdzewna A2
 Klasa 70

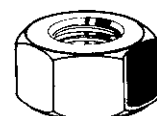

d	☒	Kod artykułu	d	☒	Kod artykułu	d	☒	Kod artykułu
M1,7*	1000	51100.017.001	M5	2500	51100.050.001	M20	150	51100.200.001
M2,3*	1000	51100.023.001	M6	2000	51100.060.001	M24	50	51100.240.001
M2,6*	1000	51100.026.001	M8	2000	51100.080.001	M27	25	51100.270.001
M3	2500	51100.030.001	M10	1000	51100.100.001	M30	10	51100.300.001
M3,5*	1000	51100.035.001	M12	700	51100.120.001			
M4	2500	51100.040.001	M16	300	51100.160.001			

• Rozmiary o średnicy > M24 mają minimalnie klasę właściwości 50.

51082 Nakrętki sześciokątne R09A

Gwint Metryczny
 Materiał Stal nierdzewna A2
 Klasa 70
 Obróbka powierzchni COMBIFLON

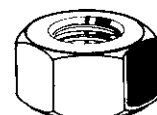

d	☒	Kod artykułu	d	☒	Kod artykułu	d	☒	Kod artykułu
M6	250	51082.060.001	M10	100	51082.100.001	M16	50	51082.160.001
M8	100	51082.080.001	M12	100	51082.120.001	M20	25	51082.200.001

- Właściwości specjalne Combiflon:
- Utrwalona cienka powłoka, kolor srebrny, redukcja efektu korozji czarnej.
- Redukuje średnią wartość współczynnika tarcia.
- Dla montażu śruby/nakrętki stosujemy Combiflon tylko na sam materiał (np. Nakrętkę).
- Redukuje korozję bimetaliczną.

51089 Nakrętki sześciokątne		Q01A
Gwint	Metryczny	
Materiał	Stal nierdzewna A2	
Klasa	70	
Obróbka powierzchni	METALFORM	

d	☒	Kod artykułu	d	☒	Kod artykułu	d	☒	Kod artykułu
M4	250	51089.040.001	M8	100	51089.080.001	M16	50	51089.160.001
M5	250	51089.050.001	M10	100	51089.100.001	M20	25	51089.200.001
M6	250	51089.060.001	M12	100	51089.120.001	M24	10	51089.240.001

- Cechy szczególne METALFORM:
- To suchy, częściowo widoczny środek smarujący eliminujący możliwość zakleszczenia gwintowanych łączników ze stali nierdzewnej.
- Oprócz tego współczynnik tarcia jest zmniejszany do bardziej stałej wartości.
- W przypadku połączeń śruby/nakrętki do zapobiegania zakleszczeniu wystarczy nasmarowanie nakrętki METALFORM.
- Po nałożeniu może zostać łatwo usunięte przy pomocy rozpuszczalnika, więc nie ma przeciwwskazań do stosowania w przemyśle żywnościowym.

3

51162 Nakrętki sześciokątne z lewym gwintem		R09A
Gwint	Metryczny	
Materiał	Stal nierdzewna A2	
Klasa	70	

d	☒	Kod artykułu	d	☒	Kod artykułu	d	☒	Kod artykułu
M4	100	51162.040.001	M12	25	51162.120.001	M22	5	51162.220.001
M5	100	51162.050.001	M14	25	51162.140.001	M24	5	51162.240.001
M6	100	51162.060.001	M16	10	51162.160.001	M27*	10	51162.270.001
M8	50	51162.080.001	M18	10	51162.180.001	M30	3	51162.300.001
M10	50	51162.100.001	M20	10	51162.200.001			

- Rozmiary o średnicy > M24 mają minimalnie klasę właściwości 50.

53080 Nakrętki sześciokątne		R11A
Gwint	Metryczny	
Materiał	Stal nierdzewna A2	
Klasa	80	

d	☒	Kod artykułu	d	☒	Kod artykułu	d	☒	Kod artykułu
M4*	500	53080.040.001	M8*	100	53080.080.001	M16*	50	53080.160.001
M5*	500	53080.050.001	M10*	100	53080.100.001	M20*	50	53080.200.001
M6*	200	53080.060.001	M12*	100	53080.120.001			

55080 Nakrętki sześciokątne		Q41A
Gwint	Metryczny	
Materiał	Stal nierdzewna A4	
Klasa	70	

d	☒	Kod artykułu	d	☒	Kod artykułu	d	☒	Kod artykułu
M1,2*	200	55080.012.001	M6	500	55080.060.001	M24	20	55080.240.001
M1,4*	200	55080.014.001	M7	200	55080.070.001	M27	10	55080.270.001
M1,6	200	55080.016.001	M8	200	55080.080.001	M30	5	55080.300.001
M2	500	55080.020.001	M10	200	55080.100.001	M33	5	55080.330.001
M2,5	500	55080.025.001	M12	200	55080.120.001	M36	5	55080.360.001
M2,6*	1000	55080.026.001	M14	100	55080.140.001	M39	5	55080.390.001
M3	500	55080.030.001	M16	100	55080.160.001	M42	5	55080.420.001
M3,5*	1000	55080.035.001	M18	50	55080.180.001	M45	5	55080.450.001
M4	500	55080.040.001	M20	50	55080.200.001	M48	5	55080.480.001
M5	500	55080.050.001	M22	20	55080.220.001	M52*	5	55080.520.001

- Rozmiary o średnicy > M24 mają minimalnie klasę właściwości 50.

55100		Nakrętki sześciokątne		Q41A	
Gwint	Metryczny	Materiał	Stal nierdzewna A4		
Klasa	70				
					

d	☒	Kod artykułu	d	☒	Kod artykułu	d	☒	Kod artykułu
M3	2500	55100.030.001	M6	2000	55100.060.001	M12	700	55100.120.001
M4	2500	55100.040.001	M8	2000	55100.080.001	M16	300	55100.160.001
M5	2500	55100.050.001	M10	1000	55100.100.001			

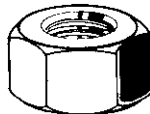
53580		Nakrętki sześciokątne		R11A	
Gwint	Metryczny	Materiał	Stal nierdzewna A4		
Klasa	80				
					

d	☒	Kod artykułu	d	☒	Kod artykułu	d	☒	Kod artykułu
M6	100	53580.060.001	M12	25	53580.120.001	M20	10	53580.200.001
M8	50	53580.080.001	M16	25	53580.160.001	M24	10	53580.240.001
M10	50	53580.100.001						

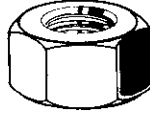
53162		Nakrętki sześciokątne z lewym gwintem		R11A	
Gwint	Metryczny	Materiał	Stal nierdzewna A4		
Klasa	80				
					

d	☒	Kod artykułu	d	☒	Kod artykułu	d	☒	Kod artykułu
M5*	100	53162.050.001	M14*	50	53162.140.001	M22*	25	53162.220.001
M6*	100	53162.060.001	M16*	25	53162.160.001	M24*	25	53162.240.001
M8*	100	53162.080.001	M18*	25	53162.180.001	M27*	10	53162.270.001
M10*	100	53162.100.001	M20*	25	53162.200.001	M30*	10	53162.300.001
M12*	50	53162.120.001						



55089		Nakrętki sześciokątne		Q45A	
Gwint	Metryczny	Materiał	Stal nierdzewna A5		
Klasa	70				
					

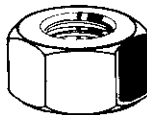

d	☒	Kod artykułu	d	☒	Kod artykułu	d	☒	Kod artykułu
M5*	500	55089.050.001	M10*	200	55089.100.001	M20*	50	55089.200.001
M6*	500	55089.060.001	M12*	100	55089.120.001	M24*	50	55089.240.001
M8*	200	55089.080.001	M16*	100	55089.160.001			

45080		Nakrętki sześciokątne		W01A	
Gwint	Metryczny	Materiał	Aluminium P40		
					

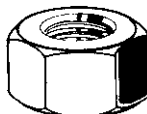

d	☒	Kod artykułu	d	☒	Kod artykułu	d	☒	Kod artykułu
M3	250	45080.030.001	M6	250	45080.060.001	M10	100	45080.100.001
M4	250	45080.040.001	M8	100	45080.080.001	M12	100	45080.120.001
M5	250	45080.050.001						

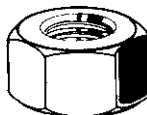

45280 Nakrętki sześciokątne				W01A				
Gwint	Metryczny							
Materiał	Aluminium P60							
Obróbka powierzchni	Anodyzowane na żółto							
d	✉	Kod artykułu	d	✉	Kod artykułu	d	✉	Kod artykułu
M6	250	45280.060.001	M12	100	45280.120.001	M20	25	45280.200.001
M8	100	45280.080.001	M16	50	45280.160.001	M24	10	45280.240.001
M10	100	45280.100.001						

45850 Nakrętki sześciokątne				M11A				
Gwint	Metryczny							
Materiał	Kuprodur Cu5							
Klasa	60							
								
d	✉	Kod artykułu	d	✉	Kod artykułu	d	✉	Kod artykułu
M6	100	45850.060.001	M10	50	45850.100.001	M16	10	45850.160.001
M8	50	45850.080.001	M12	25	45850.120.001			

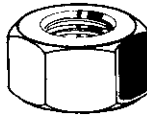
45920 Nakrętki sześciokątne				W01A				
Gwint	Metryczny			DIN	≈934 (1987)			
Materiał	Tytan Grade 2			NEN	≈1560			
Klasa	Gr.2			NF	≈E25-401			
								
d	✉	Kod artykułu	d	✉	Kod artykułu	d	✉	Kod artykułu
M6	25	45920.060.001	M8	25	45920.080.001	M10	10	45920.100.001

- Tytan grade 2 (numer materiału 3.7035) z wysokim składem czystego tytanu zapewnia stabilność produktu i jego przydatność w bardzo korozyjnych środowiskach, w których nie zdają egzaminu inne materiały np. stal nierdzewna.
- Tytan Grade 2, jest również odpowiedni do innych zastosowań z lekkim obciążeniem.

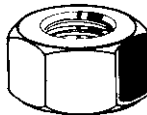
47000 Nakrętki sześciokątne				M01A				
Gwint	Metryczny							
Materiał	Mosiądz Cu2/Cu3							
								
d	✉	Kod artykułu	d	✉	Kod artykułu	d	✉	Kod artykułu
M2	250	47000.020.001	M7	250	47000.070.001	M18	10	47000.180.001
M2,5	250	47000.025.001	M8	250	47000.080.001	M20	10	47000.200.001
M3	250	47000.030.001	M10	100	47000.100.001	M22	10	47000.220.001
M4	250	47000.040.001	M12	50	47000.120.001	M24	10	47000.240.001
M5	250	47000.050.001	M14	50	47000.140.001	M27	10	47000.270.001
M6	250	47000.060.001	M16	25	47000.160.001	M30	5	47000.300.001

47050 Nakrętki sześciokątne				M01A				
Gwint	Metryczny							
Materiał	Mosiądz Cu2/Cu3							
Obróbka powierzchni	Niklowane							
								
d	✉	Kod artykułu	d	✉	Kod artykułu	d	✉	Kod artykułu
M1,4	500	47050.014.001	M3,5	250	47050.035.001	M8	250	47050.080.001
M1,6	500	47050.016.001	M4	250	47050.040.001	M10	100	47050.100.001
M2	250	47050.020.001	M5	250	47050.050.001	M12	50	47050.120.001
M2,5	250	47050.025.001	M6	250	47050.060.001	M16	25	47050.160.001
M3	250	47050.030.001						

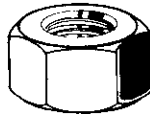
56200	Nakrętki sześciokątne plastikowe				W02A
Gwint	Metryczny	DIN	≈934 (1987)		
Materiał	Plastik Poliamid (nylon)	NEN	≈1560		
Klasa	PA 6.6	NF	≈E25-401		
Kolor	Biały				

d	☒	Kod artykułu	d	☒	Kod artykułu	d	☒	Kod artykułu
M3	200	56200.030.001	M8	50	56200.080.001	M14	25	56200.140.001
M4	200	56200.040.001	M10	50	56200.100.001	M16	25	56200.160.001
M5	200	56200.050.001	M12	25	56200.120.001	M20	10	56200.200.001
M6	100	56200.060.001						

3

Nakrętki sześciokątne, metryczne drobnozwojne

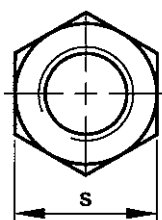
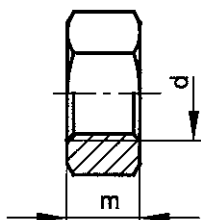

DIN 934 (1987)
NEN 1560
NF E25-401

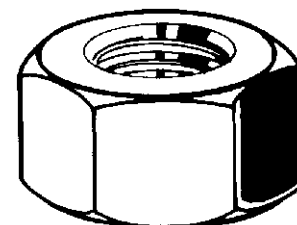

Informacje techniczne

d	m	s	d	m	s
M4 (#DIN)	3.2	7	M33 (#DIN)	26	50
M6 (#DIN)	5	10	M33	26	50
M8	6.5	13	M36 (#DIN)	29	55
M10	8	17	M36	29	55
M12 (#DIN)	10	19	M38 (#DIN)	31	60
M12	10	19	M39 (#DIN)	31	60
M14	11	22	M39	31	60
M16	13	24	M40 (#DIN)	31	60
M18 (#DIN)	15	27	M42 (#DIN)	34	65
M18	15	27	M42	34	65
M20	16	30	M45 (#DIN)	36	70
M22 (#DIN)	18	32	M45	36	70
M22	18	32	M48 (#DIN)	38	75
M24 (#DIN)	19	36	M48	38	75
M24	19	36	M52 (#DIN)	42	80
M26 (#DIN)	22	41	M52	42	80
M27 (#DIN)	22	41	M56 (#DIN)	45	85
M27	22	41	M56	45	85
M28 (#DIN)	22	41	M60 (#DIN)	48	90
M30 (#DIN)	24	46	M60	48	90
M30	24	46	M64	51	95
M32 (#DIN)	26	50	M68	54	100

Grupy katalogowe

Gwint	Gniazdo	Materiał	Klasa	Obróbka powierzchni	Kod	Strona
M.drob.	Sześciokąt	St	8		01120	3-15
M.drob.	Sześciokąt	St	8	lewy gwint	01130	3-15
M.drob.	Sześciokąt	St	8	Ocynk.	01330	3-15
M.drob.	Sześciokąt	St	8	Ocynk. żłt. pas.	01340	3-15
M.drob.	Sześciokąt	St	10		04180	3-16
M.drob.	Sześciokąt	Stal automatowa	6	lewy gwint	11007	3-16
M.drob.	Sześciokąt	St.St. A2	70		51160	3-16
M.drob.	Sześciokąt	St.St. A4	70		55160	3-16

01120 Nakrętki sześciokątne, metryczne drobnozwojne		A09A
Gwint	Metryczny drobnozwojny	
Materiał	Stal	
Klasa	8	



d x P	☒	Kod artykułu	d x P	☒	Kod artykułu	d x P	☒	Kod artykułu
M4X0,75 (#DIN)	250	01120.040.075	M22X2,00	25	01120.220.200	M39X3,00	5	01120.390.300
M6X0,75 (#DIN)	250	01120.060.075	M24X1,50 (#DIN)	25	01120.240.150	M40X1,50 (#DIN)	2	01120.400.150
M8X1,00	250	01120.080.100	M24X2,00	25	01120.240.200	M40X2,00 (#DIN)	2	01120.400.200
M10X1,00	250	01120.100.100	M26X1,50 (#DIN)	10	01120.260.150	M42X1,50 (#DIN)	5	01120.420.150
M10X1,25	250	01120.100.125	M27X1,50 (#DIN)	25	01120.270.150	M42X3,00	5	01120.420.300
M12X1,00 (#DIN)	100	01120.120.100	M27X2,00	25	01120.270.200	M45X1,50 (#DIN)	4	01120.450.150
M12X1,25	100	01120.120.125	M28X2,00 (#DIN)	10	01120.280.200	M45X3,00	4	01120.450.300
M12X1,50	100	01120.120.150	M30X1,00 (#DIN)	10	01120.300.100	M48X1,50 (#DIN)	4	01120.480.150
M14X1,50	100	01120.140.150	M30X1,50 (#DIN)	25	01120.300.150	M48X2,00 (#DIN)	2	01120.480.200
M16X1,00	50	01120.160.100	M30X2,00	25	01120.300.200	M48X3,00	4	01120.480.300
M16X1,50	100	01120.160.150	M32X2,00 (#DIN)	5	01120.320.200	M52X1,50 (#DIN)	1	01120.520.150
M18X1,00 (#DIN)	25	01120.180.100	M33X1,50 (#DIN)	10	01120.330.150	M52X3,00	1	01120.520.300
M18X1,50	50	01120.180.150	M33X2,00	10	01120.330.200	M56X2,00 (#DIN)	1	01120.560.200
M18X2,00	50	01120.180.200	M36X1,50 (#DIN)	10	01120.360.150	M56X4,00	1	01120.560.400
M20X1,50	50	01120.200.150	M36X2,00 (#DIN)	10	01120.360.200	M60X2,00 (#DIN)	1	01120.600.200
M20X2,00	50	01120.200.200	M36X3,00	10	01120.360.300	M60X4,00	1	01120.600.400
M22X1,00 (#DIN)	10	01120.220.100	M38X1,50 (#DIN)	2	01120.380.150	M64X4,00	1	01120.640.400
M22X1,50	25	01120.220.150	M39X1,50 (#DIN)	5	01120.390.150	M68X4,00	1	01120.680.400

3

01130 Nakrętki sześciokątne MF z lewym gwintem		A09A
Gwint	Metryczny drobnozwojny	
Materiał	Stal	
Klasa	8	



d x P	☒	Kod artykułu	d x P	☒	Kod artykułu	d x P	☒	Kod artykułu
M12X1,25	50	01130.120.125	M24X1,50 (#DIN)	10	01130.240.150	M36X1,50 (#DIN)	2	01130.360.150
M12X1,50	50	01130.120.150	M24X2,00	10	01130.240.200	M36X2,00 (#DIN)	2	01130.360.200
M14X1,50	50	01130.140.150	M27X1,50 (#DIN)	10	01130.270.150	M42X1,50 (#DIN)	1	01130.420.150
M16X1,50	25	01130.160.150	M27X2,00	10	01130.270.200	M45X3,00	1	01130.450.300
M18X1,50	10	01130.180.150	M30X1,50 (#DIN)	10	01130.300.150	M48X1,50 (#DIN)	1	01130.480.150
M20X2,00	10	01130.200.200	M30X2,00	10	01130.300.200	M48X3,00	1	01130.480.300
M22X2,00	10	01130.220.200	M33X2,00	5	01130.330.200			

01330 Nakrętki sześciokątne, metryczne drobnozwojne		A09A
Gwint	Metryczny drobnozwojny	
Materiał	Stal	
Klasa	8	
Obróbka powierzchni	Ocynkowane	



d x P	☒	Kod artykułu	d x P	☒	Kod artykułu	d x P	☒	Kod artykułu
M8X1,00	250	01330.080.100	M12X1,25	100	01330.120.125	M18X1,50	50	01330.180.150
M10X1,00	250	01330.100.100	M12X1,50	100	01330.120.150	M20X1,50	50	01330.200.150
M10X1,25	250	01330.100.125	M14X1,50	100	01330.140.150	M24X1,50	50	01330.240.150
M12X1,00	100	01330.120.100	M16X1,50	100	01330.160.150	M39X3,00	1	01330.390.300

01340 Nakrętki sześciokątne, metryczne drobnozwojne		A09A
Gwint	Metryczny drobnozwojny	
Materiał	Stal	
Klasa	8	
Obróbka powierzchni	Ocynkowane, po żółtej pasywacji	

d x P	☒	Kod artykułu	d x P	☒	Kod artykułu	d x P	☒	Kod artykułu
M6X0,75 (#DIN)	250	01340.060.075	M18X1,50	50	01340.180.150	M27X1,50 (#DIN)	25	01340.270.150
M8X1,00	250	01340.080.100	M18X2,00	50	01340.180.200	M27X2,00	25	01340.270.200
M10X1,00	250	01340.100.100	M20X1,50	50	01340.200.150	M30X1,50 (#DIN)	25	01340.300.150
M10X1,25	250	01340.100.125	M20X2,00	50	01340.200.200	M30X2,00	25	01340.300.200
M12X1,00 (#DIN)	100	01340.120.100	M22X1,50	25	01340.220.150	M33X1,50 (#DIN)	10	01340.330.150
M12X1,25 (#DIN)	100	01340.120.125	M22X2,00	25	01340.220.200	M33X2,00	10	01340.330.200
M12X1,50 (#DIN)	100	01340.120.150	M24X1,50 (#DIN)	25	01340.240.150	M36X1,50 (#DIN)	10	01340.360.150
M14X1,50	100	01340.140.150	M24X2,00	25	01340.240.200	M36X3,00	10	01340.360.300
M16X1,50	100	01340.160.150						

04180	Nakrętki sześciokątne, metryczne drobnozwojne	C02A
Gwint	Metryczny drobnozwojny	
Materiał	Stal	
Klasa	[10]	
		

d x P	☒	Kod artykułu	d x P	☒	Kod artykułu	d x P	☒	Kod artykułu
M8X1,00	250	04180.080.100	M14X1,50	100	04180.140.150	M22X1,50	50	04180.220.150
M10X1,00	250	04180.100.100	M16X1,50	100	04180.160.150	M24X2,00	50	04180.240.200
M10X1,25	250	04180.100.125	M18X1,50	50	04180.180.150	M27X2,00	10	04180.270.200
M12X1,25	100	04180.120.125	M20X1,50	50	04180.200.150	M30X2,00	5	04180.300.200
M12X1,50	100	04180.120.150						

11007	Nakrętki sześciokątne MF toczone z lewym gwintem	F01B
Gwint	Metryczny drobnozwojny	
Materiał	Stal automatowa	
Klasa	[6]	
		

d x P	☒	Kod artykułu	d x P	☒	Kod artykułu	d x P	☒	Kod artykułu
M10X1,00	250	11007.100.100	M20X2,00	50	11007.200.200	M33X2,00	5	11007.330.200
M12X1,25	100	11007.120.125	M24X1,50 (≠DIN)	25	11007.240.150	M36X1,50 (≠DIN)	5	11007.360.150
M12X1,50	100	11007.120.150	M24X2,00	25	11007.240.200	M45X3,00	4	11007.450.300
M14X1,50	100	11007.140.150	M27X2,00	25	11007.270.200	M48X1,50 (≠DIN)	4	11007.480.150
M16X1,50	100	11007.160.150	M30X1,50 (≠DIN)	25	11007.300.150			
M18X1,50	50	11007.180.150	M30X2,00	25	11007.300.200			

51160	Nakrętki sześciokątne, metryczne drobnozwojne	R09A
Gwint	Metryczny drobnozwojny	
Materiał	Stal nierdzewna A2	
Klasa	70	
		

d x P	☒	Kod artykułu	d x P	☒	Kod artykułu	d x P	☒	Kod artykułu
M8X1,00	100	51160.080.100	M16X1,50	50	51160.160.150	M27X1,50*	25	51160.270.150
M10X1,00	100	51160.100.100	M18X1,50	25	51160.180.150	M27X2,00*	25	51160.270.200
M10X1,25	100	51160.100.125	M20X1,50	25	51160.200.150	M30X1,50*	25	51160.300.150
M12X1,00	50	51160.120.100	M20X2,00*	50	51160.200.200	M30X2,00*	25	51160.300.200
M12X1,25	100	51160.120.125	M22X1,50	10	51160.220.150	M36X1,50*	10	51160.360.150
M12X1,50	100	51160.120.150	M24X1,50 (≠DIN)	10	51160.240.150	M36X3,00*	10	51160.360.300
M14X1,50	50	51160.140.150	M24X2,00	10	51160.240.200			

• Rozmiary o średnicy > M24 mają minimalnie klasę właściwości 50.

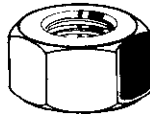
55160	Nakrętki sześciokątne, metryczne drobnozwojne	R49A
Gwint	Metryczny drobnozwojny	
Materiał	Stal nierdzewna A4	
Klasa	70	
		

d x P	☒	Kod artykułu	d x P	☒	Kod artykułu	d x P	☒	Kod artykułu
M8X1,00	100	55160.080.100	M16X1,50	50	55160.160.150	M27X1,50*	25	55160.270.150
M10X1,00	100	55160.100.100	M18X1,50	25	55160.180.150	M27X2,00*	25	55160.270.200
M10X1,25	100	55160.100.125	M20X1,50	25	55160.200.150	M30X1,50 (≠DIN)*	25	55160.300.150
M12X1,25	100	55160.120.125	M22X1,50	10	55160.220.150	M30X2,00*	25	55160.300.200
M12X1,50	100	55160.120.150	M24X1,50 (≠DIN)	10	55160.240.150			
M14X1,50	50	55160.140.150	M24X2,00	10	55160.240.200			

• Rozmiary o średnicy > M24 mają minimalnie klasę właściwości 50.

Nakrętki sześciokątne

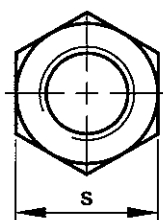
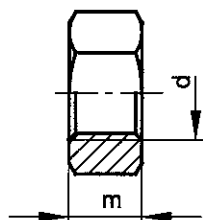

ISO 4032

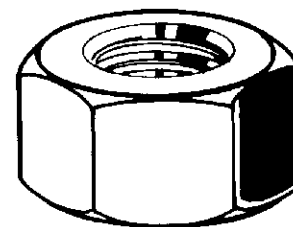

Informacje techniczne

d	m (maks.)	P	s	d	m (maks.)	P	s
M2	1.6	0.4	4	M16	14.8	2	24
M2.5	2	0.45	5	M18	15.8	2.5	27
M3	2.4	0.5	5.5	M20	18	2.5	30
M4	3.2	0.7	7	M22	19.4	2.5	34
M5	4.7	0.8	8	M24	21.5	3	36
M6	5.2	1	10	M27	23.8	3	41
M8	6.8	1.25	13	M30	25.6	3.5	46
M10	8.4	1.5	16	M33	28.7	3.5	50
M12	10.8	1.75	18	M36	31	4	55
M14	12.8	2	21	M39	34	4	60

Grupy katalogowe

Gwint	Gniazdo	Materiał	Klasa	Obróbka powierzchni	Kod	Strona
M	Sześciokąt	St	8		01104	3-17
M	Sześciokąt	St	8	Ocynk.	01301	3-17
M	Sześciokąt	St	8	Ocynk. żłt. pas.	01321	3-18
M	Sześciokąt	St	8	FLZNNC-NC6	01337	3-18
M	Sześciokąt	St	8	Ocynk. gor. izometryczna	01510	3-18
M	Sześciokąt	St	10		04124	3-18
M	Sześciokąt	St	10	Ocynk.	04127	3-19
M	Sześciokąt	St	10	FLZNNC-NC6	04130	3-19
M	Sześciokąt	St	5-2	do zbiorników ciśnieniowych	08781	3-19
M	Sześciokąt	St.St. A2	70		51081	3-19
M	Sześciokąt	St.St. A2	80		53581	3-20
M	Sześciokąt	St.St. A4	70		55081	3-20

01104 Nakrętki sześciokątne

A01B

Gwint Metryczny
Materiał Stal
Klasa 8

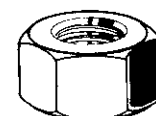

d	Kod artykułu	d	Kod artykułu	d	Kod artykułu
M3	250 01104.030.001	M12	100 01104.120.001	M30	10 01104.300.001
M4	250 01104.040.001	M14	100 01104.140.001	M33	5 01104.330.001
M5	250 01104.050.001	M16	100 01104.160.001	M36	5 01104.360.001
M6	250 01104.060.001	M20	50 01104.200.001	M39	5 01104.390.001
M8	250 01104.080.001	M24	25 01104.240.001		
M10	250 01104.100.001	M27	10 01104.270.001		

01301 Nakrętki sześciokątne

A05B

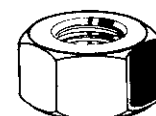

Gwint Metryczny
Materiał Stal
Klasa 8
Obróbka powierzchni Ocynkowane



d	Kod artykułu	d	Kod artykułu	d	Kod artykułu
M2	1000 01301.020.001	M10	250 01301.100.001	M24	25 01301.240.001
M2,5	1000 01301.025.001	M12	250 01301.120.001	M27	10 01301.270.001
M3	250 01301.030.001	M14	100 01301.140.001	M30	10 01301.300.001
M4	250 01301.040.001	M16	100 01301.160.001	M33	5 01301.330.001
M5	250 01301.050.001	M18	50 01301.180.001	M36	5 01301.360.001
M6	250 01301.060.001	M20	50 01301.200.001	M 39	5 01301.390.001
M8	250 01301.080.001	M22	25 01301.220.001		

01321 Nakrętki sześciokątne		A06A
Gwint	Metryczny	
Materiał	Stal	
Klasa	8	
Obróbka powierzchni	Ocynkowane, po żółtej pasywacji	

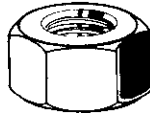
d	☒	Kod artykułu	d	☒	Kod artykułu	d	☒	Kod artykułu
M3	250	01321.030.001	M12	100	01321.120.001	M27	10	01321.270.001
M4	250	01321.040.001	M14	100	01321.140.001	M30	10	01321.300.001
M5	250	01321.050.001	M16	100	01321.160.001	M33	5	01321.330.001
M6	250	01321.060.001	M18	50	01321.180.001	M36	5	01321.360.001
M8	250	01321.080.001	M20	50	01321.200.001			
M10	250	01321.100.001	M24	25	01321.240.001			



01337 Nakrętki sześciokątne		A96A	
Gwint	Metryczny		
Materiał	Stal		
Klasa	8		
Obróbka powierzchni	Ocynk platkowy bez Cr6+ wg ISO 10683 (fZnnc)		
			

d	☒	Kod artykułu	d	☒	Kod artykułu	d	☒	Kod artykułu
M3	250	01337.030.001	M12	100	01337.120.001	M30	10	01337.300.001
M4	250	01337.040.001	M14	100	01337.140.001	M33	5	01337.330.001
M5	250	01337.050.001	M16	100	01337.160.001	M36	5	01337.360.001
M6	250	01337.060.001	M20	50	01337.200.001	M39	5	01337.390.001
M8	250	01337.080.001	M24	25	01337.240.001			
M10	250	01337.100.001	M27	10	01337.270.001			

01510 Nakrętki sześciokątne z gwintem montażowym		A05B	
Gwint	Metryczny		
Materiał	Stal		
Klasa	8		
Obróbka powierzchni	Ocynkowane na gorąco		
			

d	☒	Kod artykułu	d	☒	Kod artykułu	d	☒	Kod artykułu
M6	250	01510.060.001	M16	100	01510.160.001	M27	10	01510.270.001
M8	250	01510.080.001	M18	50	01510.180.001	M30	10	01510.300.001
M10	250	01510.100.001	M20	50	01510.200.001	M33	5	01510.330.001
M12	100	01510.120.001	M22	25	01510.220.001	M36	5	01510.360.001
M14	100	01510.140.001	M24	25	01510.240.001			

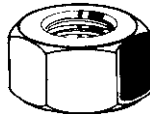
- Te nakrętki sześciokątne są stosowane między innymi do śrub cynkowanych na gorąco i wkrętów z gwintem IZOMETRYCZNYM DOPASOWANYM, jak również do cynkowanych na gorąco prętów gwintowanych z gwintem IZOMETRYCZNYM DOPASOWANYM.
- Nakrętki są gwintowane po cynkowaniu i odpowiadają klasie tolerancji 6H. Mimo braku powłoki na gwincie nakrętka zamontowana nie ma obniżonej odporności antykorozyjnej.

04124 Nakrętki sześciokątne		A05B	
Gwint	Metryczny		
Materiał	Stal		
Klasa	10		
			

d	☒	Kod artykułu	d	☒	Kod artykułu	d	☒	Kod artykułu
M5	250	04124.050.001	M16	100	04124.160.001	M30	10	04124.300.001
M6	250	04124.060.001	M18	50	04124.180.001	M33	5	04124.330.001
M8	250	04124.080.001	M20	50	04124.200.001	M36	5	04124.360.001
M10	250	04124.100.001	M22	50	04124.220.001	M39	5	04124.390.001
M12	100	04124.120.001	M24	25	04124.240.001			
M14	100	04124.140.001	M27	10	04124.270.001			

04127 Nakrętki sześciokątne		A05B
Gwint	Metryczny	
Materiał	Stal	
Klasa	10	
Obróbka powierzchni	Ocynkowane	

d	☒	Kod artykułu	d	☒	Kod artykułu	d	☒	Kod artykułu
M3	250	04127.030.001	M12	100	04127.120.001	M24	25	04127.240.001
M4	250	04127.040.001	M14	100	04127.140.001	M27	10	04127.270.001
M5	250	04127.050.001	M16	100	04127.160.001	M30	10	04127.300.001
M6	250	04127.060.001	M18	50	04127.180.001	M33	5	04127.330.001
M8	250	04127.080.001	M20	50	04127.200.001	M36	5	04127.360.001
M10	250	04127.100.001	M22	50	04127.220.001	M39	5	04127.390.001

04130 Nakrętki sześciokątne		C02A
Gwint	Metryczny	
Materiał	Stal	
Klasa	10	
Obróbka powierzchni	Ocynek płatkowy bez Cr6+ wg ISO 10683 (flZnnc)	

d	☒	Kod artykułu	d	☒	Kod artykułu	d	☒	Kod artykułu
M5	250	04130.050.001	M16	100	04130.160.001	M30	10	04130.300.001
M6	250	04130.060.001	M18	100	04130.180.001	M33	5	04130.330.001
M8	250	04130.080.001	M20	100	04130.200.001	M36	5	04130.360.001
M10	250	04130.100.001	M22	50	04130.220.001	M39	5	04130.390.001
M12	250	04130.120.001	M24	25	04130.240.001			
M14	250	04130.140.001	M27	10	04130.270.001			

08781 Nakrętki sześciokątne do zbiorników ciśnieniowych		E11A
Gwint	Metryczny	
Materiał	Stal	
Klasa	5-2	

d	☒	Kod artykułu	d	☒	Kod artykułu	d	☒	Kod artykułu
M8	250	08781.080.001	M20	100	08781.200.001	M30	25	08781.300.001
M10	250	08781.100.001	M24	50	08781.240.001	M33	5	08781.330.001
M12	100	08781.120.001	M27	50	08781.270.001	M36	5	08781.360.001
M16	100	08781.160.001						

- Specjalne cechy nakrętek sześciokątnych do naczyń ciśnieniowych etc.:
- Są przeznaczone do stosowania w naczyniach ciśnieniowych, urządzeniach parowych, wyposażenia i złącz z kołnierzeniami w temperaturach od - 10°C do + 300°C, nadciśnieniem maks. 40 bar.
- Spełniają wymagania AD-Merkblatt W7, TRD 106 z "Technischer Überwachungsverein (TÜV)" oraz ISO 898-2 i DIN 267-13.
- Zgodnie z TÜV-Merkblatt Werkstoffe 1253, producent otrzymał certyfikat na dostarczanie tych śrub bez certyfikatu 3.1 wystarcza znak handlowy i oznaczenie klasy.
- Certyfikat jest również zaakceptowany "Lloyd's Register Energy".

51081 Nakrętki sześciokątne		R09A
Gwint	Metryczny	
Materiał	Stal nierdzewna A2	
Klasa	70	

d	☒	Kod artykułu	d	☒	Kod artykułu	d	☒	Kod artykułu
M5*	1000	51081.050.001	M12*	200	51081.120.001	M18*	50	51081.180.001
M6	1000	51081.060.001	M14*	100	51081.140.001	M20	50	51081.200.001
M8	500	51081.080.001	M16*	100	51081.160.001	M22*	25	51081.220.001
M10	200	51081.100.001						

53581	Nakrętki sześciokątne	R11A
Gwint	Metryczny	
Materiał	Stal nierdzewna A2	
Klasa	80	

d	☒	Kod artykułu	d	☒	Kod artykułu	d	☒	Kod artykułu
M6*	1000	53581.060.001	M12*	200	53581.120.001	M20*	50	53581.200.001
M8*	500	53581.080.001	M16*	100	53581.160.001	M24*	25	53581.240.001
M10*	200	53581.100.001						

3

55081	Nakrętki sześciokątne	R49A
Gwint	Metryczny	
Materiał	Stal nierdzewna A4	
Klasa	70	

d	☒	Kod artykułu	d	☒	Kod artykułu	d	☒	Kod artykułu
M6*	1000	55081.060.001	M12*	200	55081.120.001	M20*	50	55081.200.001
M8*	500	55081.080.001	M14*	100	55081.140.001	M24*	25	55081.240.001
M10*	200	55081.100.001	M16	100	55081.160.001			

Nakrętki sześciokątne, UNC

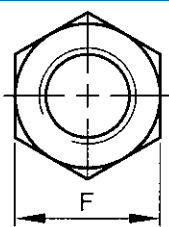
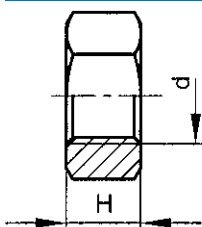

ASME ≈B18.2.2
BS ≈1768

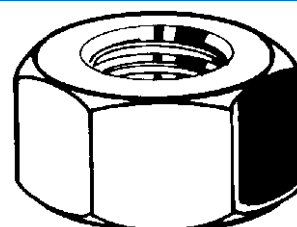

Informacje techniczne

d	F	H	Zwoje gwintu na cal	d	F	H	Zwoje gwintu na cal
1/4	7/16	7/32	20	3/4	1.1/8	41/64	10
5/16	1/2	17/64	18	7/8	1.5/16	3/4	9
3/8	9/16	21/64	16	1 inch	1.1/2	55/64	8
7/16	11/16	3/8	14	1.1/8	1.11/16	31/32	7
1/2	3/4	7/16	13	1.1/4	1.7/8	1 1/16	7
9/16	7/8	31/64	12	1.1/2	2.1/4	1 9/32	6
5/8	15/16	35/64	11				

Grupy katalogowe

Gwint	Gniazdo	Materiał	Klasa	Obróbka powierzchni	Kod	Strona
UNC	Sześciokąt	St	Grade 2		U08100	3-20
UNC	Sześciokąt	St	Grade 2	Ocynk.	U08110	3-21
UNC	Sześciokąt	St	Grade 5		U01100	3-21
UNC	Sześciokąt	St	Grade 5	Ocynk.	U01300	3-21
UNC	Sześciokąt	St	Grade 8		U04120	3-21
UNC	Sześciokąt	St	Grade 8	Ocynk. żłt. pas.	U04122	3-22
UNC	Sześciokąt	St.St. A2 (AISI304/18-8)	F594		U51080	3-22
UNC	Sześciokąt	St.St. A4 (AISI316/18-10)	F594		U55080	3-22

U08100	Nakrętki sześciokątne, UNC	X01A
Gwint	Całowy, zunifikowany grubozwojny (UNC)	
Materiał	Stal	
Klasa	Grade 2	

d	☒	Kod artykułu	d	☒	Kod artykułu	d	☒	Kod artykułu
1/4-20*	100	U08100.025.0001	1/2-13*	50	U08100.050.0001	7/8-9*	10	U08100.087.0001
5/16-18*	100	U08100.031.0001	9/16-12*	25	U08100.056.0001	1.-8*	5	U08100.100.0001
3/8-16*	100	U08100.037.0001	5/8-11*	25	U08100.062.0001	1.1/8-7*	5	U08100.112.0001
7/16-14*	50	U08100.043.0001	3/4-10*	20	U08100.075.0001	1.1/4-7*	5	U08100.125.0001

U08100 Nakrętki sześciokątne, UNC

d	☒	Kod artykułu
1.1/2-6*	5	U08100.150.0001

U08110 Nakrętki sześciokątne, UNC X01A

Gwint Calowy, zunifikowany grubzwojny (UNC)
Materiał Stal
Klasa Grade 2
Obróbka powierzchni Ocynkowane

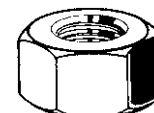

d	☒	Kod artykułu	d	☒	Kod artykułu	d	☒	Kod artykułu
1/4-20*	100	U08110.025.0001	9/16-12*	25	U08110.056.0001	1.-8*	5	U08110.100.0001
5/16-18*	100	U08110.031.0001	5/8-11*	25	U08110.062.0001	1.1/8-7*	5	U08110.112.0001
3/8-16*	100	U08110.037.0001	3/4-10*	20	U08110.075.0001	1.1/4-7*	5	U08110.125.0001
7/16-14*	50	U08110.043.0001	7/8-9*	10	U08110.087.0001	1.1/2-6*	5	U08110.150.0001
1/2-13*	50	U08110.050.0001						

U01100 Nakrętki sześciokątne, UNC X01A

Gwint Calowy, zunifikowany grubzwojny (UNC)
Materiał Stal
Klasa Grade 5

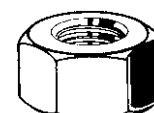

d	☒	Kod artykułu	d	☒	Kod artykułu	d	☒	Kod artykułu
1/4-20*	100	U01100.025.0001	9/16-12*	25	U01100.056.0001	1.-8*	5	U01100.100.0001
5/16-18*	100	U01100.031.0001	5/8-11*	25	U01100.062.0001	1.1/8-7*	5	U01100.112.0001
3/8-16*	100	U01100.037.0001	3/4-10*	20	U01100.075.0001	1.1/4-7*	5	U01100.125.0001
7/16-14*	50	U01100.043.0001	7/8-9*	10	U01100.087.0001	1.1/2-6*	5	U01100.150.0001
1/2-13*	50	U01100.050.0001						

U01300 Nakrętki sześciokątne, UNC X01A

Gwint Calowy, zunifikowany grubzwojny (UNC)
Materiał Stal
Klasa Grade 5
Obróbka powierzchni Ocynkowane

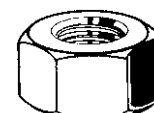

d	☒	Kod artykułu	d	☒	Kod artykułu	d	☒	Kod artykułu
1/4-20*	100	U01300.025.0001	9/16-12*	25	U01300.056.0001	1.-8*	5	U01300.100.0001
5/16-18*	100	U01300.031.0001	5/8-11*	25	U01300.062.0001	1.1/8-7*	5	U01300.112.0001
3/8-16*	100	U01300.037.0001	3/4-10*	20	U01300.075.0001	1.1/4-7*	5	U01300.125.0001
7/16-14*	50	U01300.043.0001	7/8-9*	10	U01300.087.0001	1.1/2-6*	5	U01300.150.0001
1/2-13*	50	U01300.050.0001						

U04120 Nakrętki sześciokątne, UNC X01A

Gwint Calowy, zunifikowany grubzwojny (UNC)
Materiał Stal
Klasa Grade 8

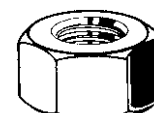

d	☒	Kod artykułu	d	☒	Kod artykułu	d	☒	Kod artykułu
1/4-20*	100	U04120.025.0001	9/16-12*	25	U04120.056.0001	1.-8*	5	U04120.100.0001
5/16-18*	100	U04120.031.0001	5/8-11*	25	U04120.062.0001	1.1/8-7*	5	U04120.112.0001
3/8-16*	100	U04120.037.0001	3/4-10*	20	U04120.075.0001	1.1/4-7*	5	U04120.125.0001
7/16-14*	50	U04120.043.0001	7/8-9*	10	U04120.087.0001	1.1/2-6*	5	U04120.150.0001
1/2-13*	50	U04120.050.0001						

U04122 Nakrętki sześciokątne, UNC X01A

Gwint Calowy, zunifikowany gruboźwojny (UNC)
Materiał Stal
Klasa Grade 8
Obróbka powierzchni Ocynkowane, po żółtej pasywacji

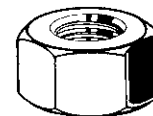

d	☒	Kod artykułu	d	☒	Kod artykułu	d	☒	Kod artykułu
1/4-20*	100	U04122.025.0001	9/16-12*	25	U04122.056.0001	1.-8*	5	U04122.100.0001
5/16-18*	100	U04122.031.0001	5/8-11*	25	U04122.062.0001	1.1/8-7*	5	U04122.112.0001
3/8-16*	100	U04122.037.0001	3/4-10*	20	U04122.075.0001	1.1/4-7*	5	U04122.125.0001
7/16-14*	50	U04122.043.0001	7/8-9*	10	U04122.087.0001	1.1/2-6*	5	U04122.150.0001
1/2-13*	50	U04122.050.0001						

U51080 Nakrętki sześciokątne, UNC X15A

Gwint Calowy, zunifikowany gruboźwojny (UNC)
Materiał Stal nierdzewna A2 (AISI 304/18-8)
Klasa F594

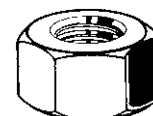

d	☒	Kod artykułu	d	☒	Kod artykułu	d	☒	Kod artykułu
1/4-20*	50	U51080.025.0001	9/16-12*	25	U51080.056.0001	1.-8*	5	U51080.100.0001
5/16-18*	50	U51080.031.0001	5/8-11*	25	U51080.062.0001	1.1/8-7*	5	U51080.112.0001
3/8-16*	50	U51080.037.0001	3/4-10*	20	U51080.075.0001	1.1/4-7*	5	U51080.125.0001
7/16-14*	25	U51080.043.0001	7/8-9*	5	U51080.087.0001	1.1/2-6*	5	U51080.150.0001
1/2-13*	25	U51080.050.0001						

U55080 Nakrętki sześciokątne, UNC X15A

Gwint Calowy, zunifikowany gruboźwojny (UNC)
Materiał Stal nierdzewna A4 (AISI 316/18-10)
Klasa F594

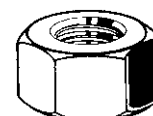

d	☒	Kod artykułu	d	☒	Kod artykułu	d	☒	Kod artykułu
1/4-20*	50	U55080.025.0001	9/16-12*	25	U55080.056.0001	1.-8*	5	U55080.100.0001
5/16-18*	50	U55080.031.0001	5/8-11*	25	U55080.062.0001	1.1/8-7*	5	U55080.112.0001
3/8-16*	50	U55080.037.0001	3/4-10*	20	U55080.075.0001	1.1/4-7*	5	U55080.125.0001
7/16-14*	25	U55080.043.0001	7/8-9*	5	U55080.087.0001	1.1/2-6*	5	U55080.150.0001
1/2-13*	25	U55080.050.0001						

Nakrętki sześciokątne nacinane maszynowo, UNC

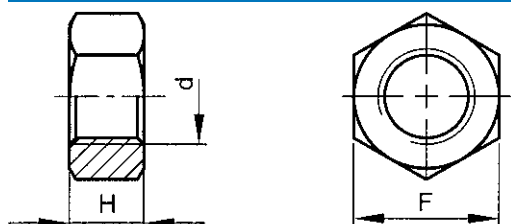

ASME ≈B18.2.2

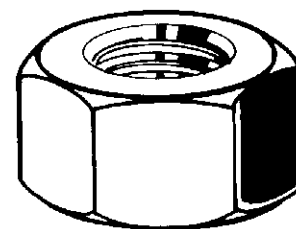

Informacje techniczne

d	F	H	Zwoje gwintu na cal	d	F	H	Zwoje gwintu na cal
No.6	5/16	2.9	32	No.10	3/8	3.3	24
No.8	11/32	3.3	32	No.12	7/16	4.1	24

11740 Nakrętki sześciokątne nacinane maszynowo, UNC

X09A

Gwint Calowy, zunifikowany grubozwojny (UNC)
Materiał Stal automatowa
Klasa 6
Obróbka powierzchni O cynkowane

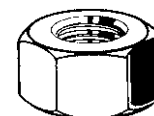

d	☒	Kod artykułu	d	☒	Kod artykułu	d	☒	Kod artykułu
NO.6 = 3,51MM	250	11740.035.001	NO.10 = 4,83MM	250	11740.048.001	NO.12 = 5,49MM	250	11740.054.001
NO.8 = 4,17MM	250	11740.041.001						

Nakrętki sześciokątne, UNF

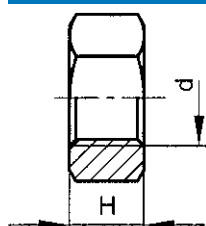

ASME ≈B18.2.2
BS ≈1768

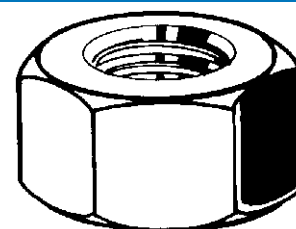

Informacje techniczne

d	F	H	Zwoje gwintu na cal	d	F	H	Zwoje gwintu na cal
1/4	7/16	7/32	28	3/4	1.1/8	41/64	16
5/16	1/2	17/64	24	7/8	1.5/16	3/4	14
3/8	9/16	21/64	24	1 Inch-14G	1.1/2	55/64	14
7/16	11/16	3/8	20	1.1/8	1.11/16	31/32	12
1/2	3/4	7/16	20	1.1/4	1.7/8	1 1/16	12
9/16	7/8	31/64	18	1.1/2	2.1/4	1 9/32	12
5/8	15/16	35/64	18				

Grupy katalogowe

Gwint	Gniazdo	Materiał	Klasa	Obróbka powierzchni	Kod	Strona
UNF	Sześciokąt	St	Grade 2		U08160	3-24
UNF	Sześciokąt	St	Grade 2	O cynk.	U08161	3-24
UNF	Sześciokąt	St	Grade 5		U01120	3-24
UNF	Sześciokąt	St	Grade 5	O cynk.	U01330	3-24
UNF	Sześciokąt	St	Grade 8		U04180	3-24
UNF	Sześciokąt	St	Grade 8	O cynk.	U04162	3-25
UNF	Sześciokąt	St	Grade 8	O cynk. żłt. pas.	U04181	3-25
UNF	Sześciokąt	St.St. A2 (AISI304/18-8)	F594		U51160	3-25

U08160 Nakrętki sześciokątne, UNF X01A

Gwint Calowy, zunifikowany drobnozwojny (UNF)
Materiał Stal
Klasa Grade 2



d	☒	Kod artykułu	d	☒	Kod artykułu	d	☒	Kod artykułu
1/4-28*	100	U08160.025.0002	9/16-18*	25	U08160.056.0002	1.-14*	5	U08160.100.0003
5/16-24*	100	U08160.031.0002	5/8-18*	25	U08160.062.0002	1.1/8-12*	5	U08160.112.0002
3/8-24*	100	U08160.037.0002	3/4-16*	20	U08160.075.0002	1.1/4-12*	5	U08160.125.0002
7/16-20*	50	U08160.043.0002	7/8-14*	10	U08160.087.0002	1.1/2-12*	5	U08160.150.0002
1/2-20*	50	U08160.050.0002						

U08161 Nakrętki sześciokątne, UNF X01A

Gwint Calowy, zunifikowany drobnozwojny (UNF)
Materiał Stal
Klasa Grade 2
Obróbka powierzchni Ocynkowane



d	☒	Kod artykułu	d	☒	Kod artykułu	d	☒	Kod artykułu
1/4-28*	100	U08161.025.0002	9/16-18*	25	U08161.056.0002	1.-14*	5	U08161.100.0003
5/16-24*	100	U08161.031.0002	5/8-18*	25	U08161.062.0002	1.1/8-12*	5	U08161.112.0002
3/8-24*	100	U08161.037.0002	3/4-16*	20	U08161.075.0002	1.1/4-12*	5	U08161.125.0002
7/16-20*	50	U08161.043.0002	7/8-14*	10	U08161.087.0002	1.1/2-12*	5	U08161.150.0002
1/2-20*	50	U08161.050.0002						

U01120 Nakrętki sześciokątne, UNF X01A

Gwint Calowy, zunifikowany drobnozwojny (UNF)
Materiał Stal
Klasa Grade 5



d	☒	Kod artykułu	d	☒	Kod artykułu	d	☒	Kod artykułu
1/4-28*	100	U01120.025.0002	9/16-18*	25	U01120.056.0002	1.-14*	5	U01120.100.0003
5/16-24*	100	U01120.031.0002	5/8-18*	25	U01120.062.0002	1.1/8-12*	5	U01120.112.0002
3/8-24*	100	U01120.037.0002	3/4-16*	20	U01120.075.0002	1.1/4-12*	5	U01120.125.0002
7/16-20*	50	U01120.043.0002	7/8-14*	10	U01120.087.0002	1.1/2-12*	5	U01120.150.0002
1/2-20*	50	U01120.050.0002						

U01330 Nakrętki sześciokątne, UNF X01A

Gwint Calowy, zunifikowany drobnozwojny (UNF)
Materiał Stal
Klasa Grade 5
Obróbka powierzchni Ocynkowane

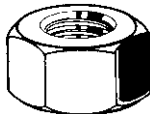
d	☒	Kod artykułu	d	☒	Kod artykułu	d	☒	Kod artykułu
1/4-28*	100	U01330.025.0002	9/16-18*	25	U01330.056.0002	1.-14*	5	U01330.100.0003
5/16-24*	100	U01330.031.0002	5/8-18*	25	U01330.062.0002	1.1/8-12*	5	U01330.112.0002
3/8-24*	100	U01330.037.0002	3/4-16*	20	U01330.075.0002	1.1/4-12*	5	U01330.125.0002
7/16-20*	50	U01330.043.0002	7/8-14*	10	U01330.087.0002	1.1/2-12*	5	U01330.150.0002
1/2-20*	50	U01330.050.0002						

U04180 Nakrętki sześciokątne, UNF X01A

Gwint Calowy, zunifikowany drobnozwojny (UNF)
Materiał Stal
Klasa Grade 8



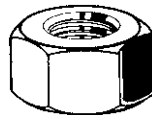

d	☒	Kod artykułu	d	☒	Kod artykułu	d	☒	Kod artykułu
1/4-28*	100	U04180.025.0002	9/16-18*	25	U04180.056.0002	1.-14*	5	U04180.100.0003
5/16-24*	100	U04180.031.0002	5/8-18*	25	U04180.062.0002	1.1/8-12*	5	U04180.112.0002
3/8-24*	100	U04180.037.0002	3/4-16*	20	U04180.075.0002	1.1/4-12*	5	U04180.125.0002
7/16-20*	50	U04180.043.0002	7/8-14*	10	U04180.087.0002	1.1/2-12*	5	U04180.150.0002
1/2-20*	50	U04180.050.0002						

U04162 Nakrętki sześciokątne, UNF							X01A	
Gwint	Całowy, zunifikowany drobnozwojny (UNF)						 	
Materiał	Stal							
Klasa	Grade 8							
Obróbka powierzchni	Ocynkowane							
d	✉	Kod artykułu	d	✉	Kod artykułu	d	✉	Kod artykułu
1/4-28*	100	U04162.025.0002	9/16-18*	25	U04162.056.0002	1.-14*	5	U04162.101.0002
5/16-24*	100	U04162.031.0002	5/8-18*	25	U04162.062.0002	1.1/8-12*	5	U04162.112.0002
3/8-24*	100	U04162.037.0002	3/4-16*	20	U04162.075.0002	1.1/4-12*	5	U04162.125.0002
7/16-20*	50	U04162.043.0002	7/8-14*	10	U04162.087.0002	1.1/2-12*	5	U04162.150.0002
1/2-20*	50	U04162.050.0002						

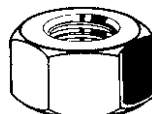
3

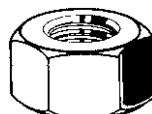
U04181 Nakrętki sześciokątne, UNF							X01A	
Gwint	Całowy, zunifikowany drobnozwojny (UNF)							
Materiał	Stal							
Klasa	Grade 8							
Obróbka powierzchni	Ocynkowane, po żółtej pasywacji							
d	✉	Kod artykułu	d	✉	Kod artykułu	d	✉	Kod artykułu
1/4-28*	100	U04181.025.0002	9/16-18*	25	U04181.056.0002	1.-14*	5	U04181.100.0003
5/16-24*	100	U04181.031.0002	5/8-18*	25	U04181.062.0002	1.1/8-12*	5	U04181.112.0002
3/8-24*	100	U04181.037.0002	3/4-16*	20	U04181.075.0002	1.1/4-12*	5	U04181.125.0002
7/16-20*	50	U04181.043.0002	7/8-14*	10	U04181.087.0002	1.1/2-12*	5	U04181.150.0002
1/2-20*	50	U04181.050.0002						

U51160 Nakrętki sześciokątne, UNF							X15A	
Gwint	Całowy, zunifikowany drobnozwojny (UNF)						 	
Materiał	Stal nierdzewna A2 (AISI 304/18-8)							
Klasa	F594							
Obróbka powierzchni								
d	✉	Kod artykułu	d	✉	Kod artykułu	d	✉	Kod artykułu
1/4-28	50	U51160.025.0002	9/16-18*	25	U51160.056.0002	1.-14*	5	U51160.101.0002
5/16-24*	50	U51160.031.0002	5/8-18*	25	U51160.062.0002	1.1/8-12*	5	U51160.112.0002
3/8-24*	50	U51160.037.0002	3/4-16*	20	U51160.075.0002	1.1/4-12*	5	U51160.125.0002
7/16-20*	25	U51160.043.0002	7/8-14*	5	U51160.087.0002	1.1/2-12*	5	U51160.150.0002
1/2-20*	25	U51160.050.0002						

Nakrętki sześciokątne nacinane maszynowo, UNF

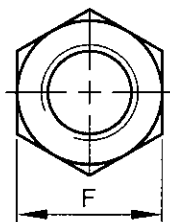
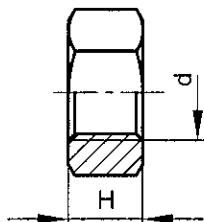

ASME ≈B18.2.2

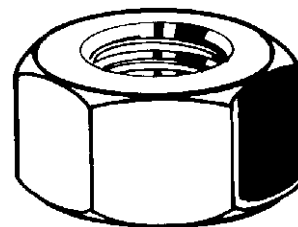

3

Informacje techniczne

d	F	H (mm)	Zwoje gwintu na cal	d	F	H (mm)	Zwoje gwintu na cal
No.4	1/4	2.5	48	No.8	11/32	3.3	36
No.5	5/16	2.9	44	No.10	3/8	3.3	32
No.6	5/16	2.9	40				

Grupy katalogowe

Gwint	Gniazdo	Materiał	Obróbka powierzchni	Kod	Strona
UNF	Sześciokąt	Stal automatowa	Ocynk.	11750	3-26
UNF	Sześciokąt	Mosiądz Cu3		47170	3-26

11750 Nakrętki sześciokątne nacinane maszynowo, UNF X09A

Gwint Calowy, zunifikowany drobnozwojny (UNF)
Materiał Stal automatowa
Obróbka powierzchni Ocynkowane

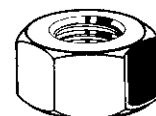

d	☒	Kod artykułu	d	☒	Kod artykułu	d	☒	Kod artykułu
NO.4 = 2,85MM	250	11750.028.001	NO.8 = 4,17MM	250	11750.041.001	NO.10 = 4,83MM	250	11750.048.001
NO.5 = 3,18MM	250	11750.031.001						

47170 Nakrętki sześciokątne nacinane maszynowo, UNF X09A

Gwint Calowy, zunifikowany drobnozwojny (UNF)
Materiał Mosiądz Cu3

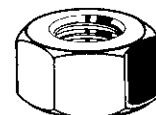

d	☒	Kod artykułu	d	☒	Kod artykułu
NO.6-40 = 3,52MM	250	47170.035.001	NO.10-32 = 4,83MM	100	47170.048.001

Nakrętki sześciokątne, BSW

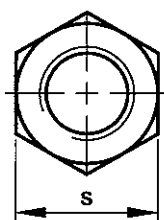
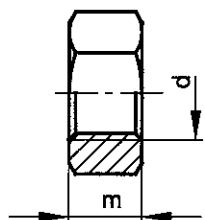

DIN ≈934 (1954)
NEN ≈2338 (1960)

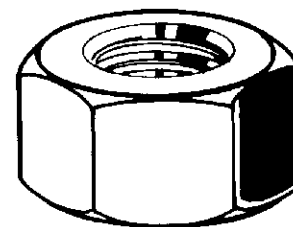

Informacje techniczne

d	m	s	Zwoje gwintu na cal	d	m	s	Zwoje gwintu na cal
1/8	2.4	5.5	40	3/4	16	32	10
5/32	3.2	7	32	7/8	18	36	9
3/16	4.8	10	24	1 Inch	20	41	8
1/4	5.5	11	20	1.1/8	22	46	7
5/16	6.5	14	18	1.1/4	25	50	7
5/16 (#DIN)	6.5	13	18	1.3/8	28	55	6
3/8	8	17	16	1.1/2	30	60	6
7/16	9.5	19	14	1.5/8	32	65	5
1/2	11	22	12	1.3/4	35	70	5
9/16	11	22	12	2 Inch	40	80	4.5
5/8	13	27	11	2.1/4	45	85	4

- Gwint Whitworth'a (BSW/BSF) nie jest zalecany do międzynarodowego stosowania. Zaleca się stosowanie gwintu metrycznego (M/MF) lub zunifikowanego (UNC/UNF).
- W zależności od dostępności wymiary mogą się różnić.

Grupy katalogowe

Gwint	Gniazdo	Materiał	Klasa	Obróbka powierzchni	Kod	Strona
BSW	Sześciokąt	St	8		03460	3-27
BSW	Sześciokąt	St	8	Ocynk.	03600	3-27
BSW	Sześciokąt	Stal automatowa	6		11200	3-28
BSW	Sześciokąt	Mosiądz Cu3			47100	3-28

03460 Nakrętki sześciokątne, BSW

X03A

Gwint: Calowy, Whitworth'a (BSW)
Materiał: Stal
Klasa: 8

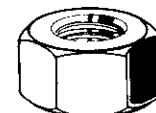

d	☒	Kod artykułu	d	☒	Kod artykułu	d	☒	Kod artykułu
3/16	250	03460.047.001	7/16	100	03460.111.001	3/4	50	03460.191.001
1/4	250	03460.063.001	1/2	100	03460.127.001	7/8	25	03460.222.001
5/16	250	03460.079.001	5/8	100	03460.158.001	1 Inch	25	03460.254.001
3/8	250	03460.096.001						

03600 Nakrętki sześciokątne, BSW

X03A

Gwint: Calowy, Whitworth'a (BSW)
Materiał: Stal
Klasa: 8
Obróbka powierzchni: Ocynkowane

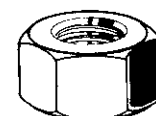

d	☒	Kod artykułu	d	☒	Kod artykułu	d	☒	Kod artykułu
3/16	250	03600.047.001	3/8	250	03600.096.001	3/4	50	03600.191.001
1/4	250	03600.063.001	1/2	100	03600.127.001	7/8	25	03600.222.001
5/16	250	03600.079.001	5/8	100	03600.158.001	1 Inch	25	03600.254.001

11200	Nakrętki sześciokątne, BSW	X08A
Gwint	Całowy, Whitworth'a (BSW)	
Materiał	Stal automatowa	
Klasa	6	

d	☒	Kod artykułu	d	☒	Kod artykułu	d	☒	Kod artykułu
1/8	250	11200.031.001	1/2	100	11200.127.001	1.1/4	10	11200.317.001
5/32	250	11200.039.001	9/16	100	11200.142.001	1.3/8	10	11200.349.001
3/16	250	11200.047.001	5/8	50	11200.158.001	1.1/2	5	11200.381.001
1/4	250	11200.063.001	3/4	25	11200.191.001	1.5/8	5	11200.412.001
5/16 (#DIN)	250	11200.079.001	7/8	25	11200.222.001	1.3/4	4	11200.444.001
3/8	100	11200.096.001	1 Inch	25	11200.254.001	2 Inch	1	11200.508.001
7/16	100	11200.111.001	1.1/8	25	11200.285.001	2.1/4	1	11200.571.001

47100	Nakrętki sześciokątne, BSW	X08A
Gwint	Całowy, Whitworth'a (BSW)	
Materiał	Mosiądz Cu3	
Klasa		

d	☒	Kod artykułu	d	☒	Kod artykułu	d	☒	Kod artykułu
1/8	250	47100.031.001	5/16	250	47100.079.001	3/4	10	47100.191.001
5/32	250	47100.039.001	3/8	100	47100.096.001	7/8	10	47100.222.001
3/16	250	47100.047.001	1/2	50	47100.127.001	1 Inch	5	47100.254.001
1/4	250	47100.063.001	5/8	25	47100.158.001			

Nakrętki sześciokątne, BSF

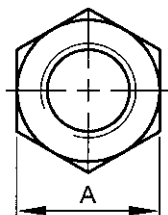
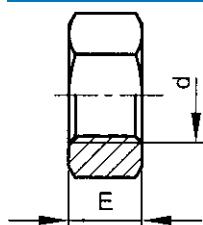

BS ≈1083 (1965)

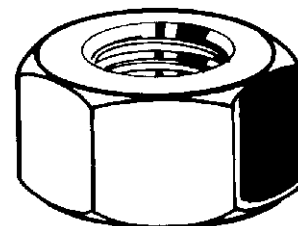

Informacje techniczne

d	A	E	Zwoje gwintu na cal	d	A	E	Zwoje gwintu na cal
1/4	0.445	5.1	26	5/8	1.01	14.3	14
5/16	0.525	6.4	22	3/4	1.2	17.5	12
3/8	0.6	7.9	20	7/8	1.3	19	11
7/16	0.71	9.5	18	1 Inch	1.48	22.2	10
1/2	0.82	11.1	16				

- Gwint Whitworth'a (BSW/BSF) nie jest zalecany do międzynarodowego stosowania.
- Zaleca się stosowanie gwintu metrycznego (M/MF) lub zunifikowanego (UNC/UNF).

03060	Nakrętki sześciokątne, BSF	X90A
Gwint	Całowy, Whitwortha, drobnozwojny (BSF)	
Materiał	Stal	
Klasa	≥6	

d	☒	Kod artykułu	d	☒	Kod artykułu	d	☒	Kod artykułu
1/4	100	03060.063.001	7/16	100	03060.111.001	3/4	50	03060.191.001
5/16	100	03060.079.001	1/2	100	03060.127.001	7/8	25	03060.222.001
3/8	100	03060.096.001	5/8	50	03060.158.001	1 Inch	25	03060.254.001

Nakrętki sześciokątne, wysokość 1xd

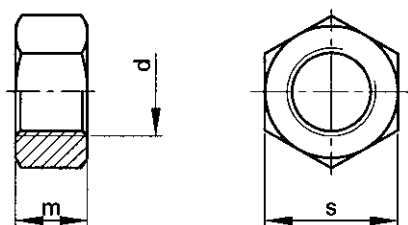

DIN ≈934 (1987)
NEN ≈1560
NF ≈E25-401

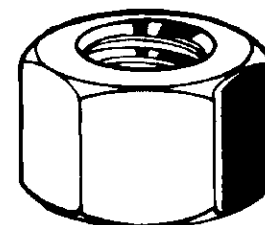

Informacje techniczne

d	m	P	s	d	m	P	s
M3	3	0.5	5.5	M27	27	3	41
M4	4	0.7	7	M30	30	3.5	46
M5	5	0.8	8	M33	33	3.5	50
M6	6	1	10	M36	36	4	55
M8	8	1.25	13	M39	39	4	60
M10	10	1.5	17	M42	42	4.5	65
M12	12	1.75	19	M45	45	4.5	70
M14	14	2	22	M48	48	5	75
M16	16	2	24	M52	52	5	80
M18	18	2.5	27	M56	56	5.5	85
M20	20	2.5	30	M60	60	5.5	90
M22	22	2.5	32	M64	64	6	95
M24	24	3	36	M72	72	6	105

Grupy katalogowe

Gwint	Gniazdo	Materiał	Klasa	Kod	Strona
M	Sześciokąt	St	≥ 6	11080	3-29
M	Sześciokąt	St.St. A2		51109	3-29
M	Sześciokąt	St.St. A4		55109	3-30

11080 Nakrętki sześciokątne, wysokość 1xd

F01A

Gwint Metryczny
Materiał Stal
Klasa ≥|6|

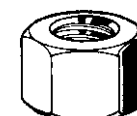

d	☒	Kod artykułu	d	☒	Kod artykułu	d	☒	Kod artykułu
M4	250	11080.040.001	M20	25	11080.200.001	M45	4	11080.450.001
M5	250	11080.050.001	M22	25	11080.220.001	M48	4	11080.480.001
M6	250	11080.060.001	M24	25	11080.240.001	M52	1	11080.520.001
M8	100	11080.080.001	M27	10	11080.270.001	M56	1	11080.560.001
M10	100	11080.100.001	M30	10	11080.300.001	M60	1	11080.600.001
M12	100	11080.120.001	M33	10	11080.330.001	M64	1	11080.640.001
M14	100	11080.140.001	M36	5	11080.360.001	M72	1	11080.720.001
M16	50	11080.160.001	M39	5	11080.390.001			
M18	25	11080.180.001	M42	5	11080.420.001			

51109 Nakrętki sześciokątne, wysokość 1xd

R09A

Gwint Metryczny
Materiał Stal nierdzewna A2

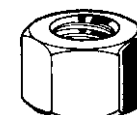

d	☒	Kod artykułu	d	☒	Kod artykułu	d	☒	Kod artykułu
M3*	1000	51109.030.001	M5*	1000	51109.050.001	M8*	200	51109.080.001

55109	Nakrętki sześciokątne, wysokość 1xd	R09A
Gwint	Metryczny	
Materiał	Stal nierdzewna A4	

d	☒	Kod artykułu	d	☒	Kod artykułu	d	☒	Kod artykułu
M3*	1000	55109.030.001	M6*	1000	55109.060.001	M12*	100	55109.120.001
M4*	1000	55109.040.001	M8*	1000	55109.080.001	M16*	50	55109.160.001
M5*	1000	55109.050.001	M10*	100	55109.100.001			

3

Nakrętki sześciokątne nacinane maszynowo, wysokość BSW 1xd

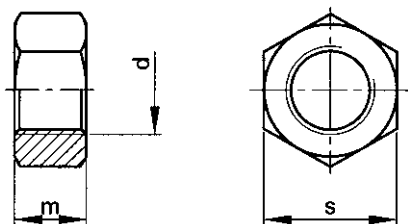

DIN ≈934 (1954)
NEN ≈2338 (1960)

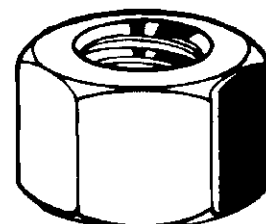

Informacje techniczne

d	m	s	Zwoje gwintu na cal	d	m	s	Zwoje gwintu na cal
5/16	7.9	13	18	1 Inch	25.4	41	8
3/8	9.5	17	16	1.1/4	31.8	50	7
1/2	12.7	22	12	1.1/2	38.1	60	6
5/8	15.9	27	11	1.5/8	41.3	65	5
3/4	19.1	32	10				

11280	Nakrętki sześciokątne nacinane maszynowo, wysokość BSW 1xd	X08A
Gwint	Calowy, Whitworth'a (BSW)	
Materiał	Stal automatowa	
Klasa	6	

d	☒	Kod artykułu	d	☒	Kod artykułu	d	☒	Kod artykułu
5/16	100	11280.079.001	5/8	50	11280.158.001	1.1/4	10	11280.317.001
3/8	100	11280.096.001	3/4	25	11280.191.001	1.1/2	5	11280.381.001
1/2	50	11280.127.001	1 Inch	10	11280.254.001	1.5/8	5	11280.412.001

Nakrętki sześciokątne DIN 555

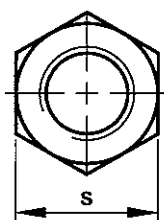
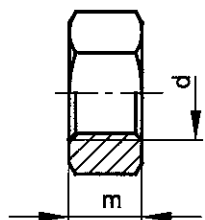

DIN 555 (1987)
NEN 697
NF E25-402

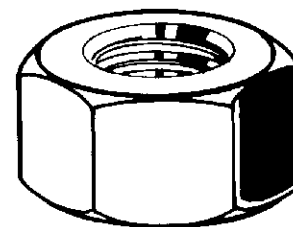

Informacje techniczne

d	m	P	s	d	m	P	s
M6	4	0.8	10	M33	26	3.5	50
M10	8	1.5	17	M36	29	4	55
M12	10	1.75	19	M39	31	4	60
M16	13	2	24	M42	34	4.5	65
M18 (≠DIN)	15	2.5	27	M45	36	4.5	70
M20	16	2.5	30	M48	38	5	75
M22	18	2.5	32	M52	42	5	80
M24	19	3	36	M56	45	5.5	85
M27	22	3	41	M64	51	6	95
M30	24	3.5	46				

Grupy katalogowe

Gwint	Gniazdo	Materiał	Klasa	Obróbka powierzchni	Kod	Strona
M	Sześciokąt	St	≥ 4		08100	3-31
M	Sześciokąt	St	≥ 4	Ocynk.	08110	3-31

08100 Nakrętki sześciokątne DIN 555

E01A

Gwint Metryczny
Materiał Stal
Klasa ≥|4|

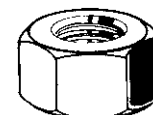

d	☒	Kod artykułu	d	☒	Kod artykułu	d	☒	Kod artykułu
M6	500	08100.060.001	M24	50	08100.240.001	M42	5	08100.420.001
M10	500	08100.100.001	M27	25	08100.270.001	M45	4	08100.450.001
M12	500	08100.120.001	M30	25	08100.300.001	M48	4	08100.480.001
M16	200	08100.160.001	M33	10	08100.330.001	M52	4	08100.520.001
M18 (≠DIN)	100	08100.180.001	M36	10	08100.360.001	M56	1	08100.560.001
M20	100	08100.200.001	M39	5	08100.390.001	M64	1	08100.640.001
M22	50	08100.220.001						

08110 Nakrętki sześciokątne DIN 555

E03A

Gwint Metryczny
Materiał Stal
Klasa ≥|4|
Obróbka powierzchni Ocynkowane

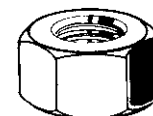

d	☒	Kod artykułu	d	☒	Kod artykułu	d	☒	Kod artykułu
M12	500	08110.120.001	M27	25	08110.270.001	M42	5	08110.420.001
M16	200	08110.160.001	M30	25	08110.300.001	M45	4	08110.450.001
M20	100	08110.200.001	M33	10	08110.330.001	M48	4	08110.480.001
M24	50	08110.240.001	M36	10	08110.360.001			

Nakrętki sześciokątne niskie, metryczne

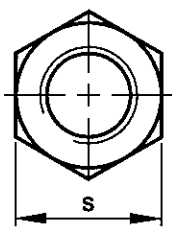
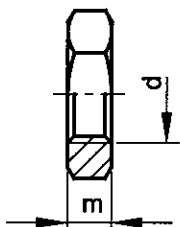

DIN 439 (1987)
NEN 2334 B
ASME B18.2.4.5M
NF E25-405-1

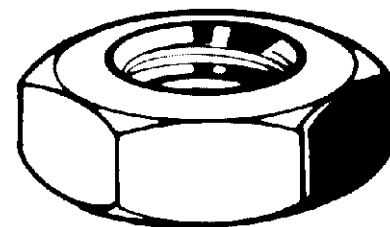

3

Informacje techniczne

d	m	P	s	d	m	P	s
M1.6	1	0.35	3.2	M22	11	2.5	32
M2	1.2	0.4	4	M24	10	3	36
M2.5	1.6	0.45	5	M27	13.5	3	41
M3	1.8	0.5	5.5	M30	15	3.5	46
M4	2.2	0.7	7	M33	16.5	3.5	50
M5	2.7	0.8	8	M36	18	4	55
M6	3.2	1	10	M39	19.5	4	60
M8	4	1.25	13	M42	21	4.5	65
M10	5	1.5	17	M45	22.5	4.5	70
M12	6	1.75	19	M48	24	5	75
M14	7	2	22	M52	26	5	80
M16	8	2	24	M56 (#DIN)	28	5.5	85
M18	9	2.5	27	M60 (#DIN)	30	5.5	90
M20	10	2.5	30				

Grupy katalogowe

Gwint	Gniazdo	Materiał	Klasa	Obróbka powierzchni	Kod	Strona
M	Sześciokąt	St	04		11060	3-32
M	Sześciokąt	St	04	Ocynk.	11360	3-32
M	Sześciokąt	St	04	Ocynk. lewy gwint	11382	3-33
M	Sześciokąt	St	04	Ocynk. żłt. pas.	11350	3-33
M	Sześciokąt	St	04	Ocynk. gor. nadwymiarowa	01580	3-33
M	Sześciokąt	St	04	Ocynk. gor. izometryczna	01586	3-33
M	Sześciokąt	St.St. A2	35		51090	3-34
M	Sześciokąt	St.St. A2	35	lewy gwint	51093	3-34
M	Sześciokąt	St.St. A4	35		55090	3-34
M	Sześciokąt	Mosiądz Cu2			47030	3-34

11060 Nakrętki sześciokątne niskie, metryczne

F01A

Gwint Metryczny
Materiał Stal
Klasa 04

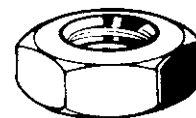

d	☒	Kod artykułu	d	☒	Kod artykułu	d	☒	Kod artykułu
M3	250	11060.030.001	M16	50	11060.160.001	M36	5	11060.360.001
M4	250	11060.040.001	M18	25	11060.180.001	M39	5	11060.390.001
M5	250	11060.050.001	M20	25	11060.200.001	M42	5	11060.420.001
M6	250	11060.060.001	M22	25	11060.220.001	M45	4	11060.450.001
M8	100	11060.080.001	M24	25	11060.240.001	M48	4	11060.480.001
M10	100	11060.100.001	M27	10	11060.270.001	M52	1	11060.520.001
M12	100	11060.120.001	M30	10	11060.300.001	M56	1	11060.560.001
M14	100	11060.140.001	M33	10	11060.330.001	M60	1	11060.600.001

11360 Nakrętki sześciokątne niskie, metryczne

F01A

Gwint Metryczny
Materiał Stal
Klasa 04
Obróbka powierzchni Ocynkowane

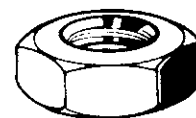

d	☒	Kod artykułu	d	☒	Kod artykułu	d	☒	Kod artykułu
M2	250	11360.020.001	M4	250	11360.040.001	M8	100	11360.080.001
M2,5	250	11360.025.001	M5	250	11360.050.001	M10	100	11360.100.001
M3	250	11360.030.001	M6	250	11360.060.001	M12	100	11360.120.001

11360 Nakrętki sześciokątne niskie, metryczne

d	☒	Kod artykułu	d	☒	Kod artykułu	d	☒	Kod artykułu
M14	100	11360.140.001	M24	25	11360.240.001	M39	5	11360.390.001
M16	50	11360.160.001	M27	10	11360.270.001	M42	5	11360.420.001
M18	25	11360.180.001	M30	10	11360.300.001	M45	4	11360.450.001
M20	25	11360.200.001	M33	10	11360.330.001	M48	4	11360.480.001
M22	25	11360.220.001	M36	5	11360.360.001			

11382 Nakrętki sześciokątne niskie z lewym gwintem F01A

Gwint	Metryczny							
Materiał	Stal							
Klasa	04							
Obróbka powierzchni	Ocynkowane							
								

d	☒	Kod artykułu	d	☒	Kod artykułu	d	☒	Kod artykułu
M5	250	11382.050.001	M12	100	11382.120.001	M24	25	11382.240.001
M6	250	11382.060.001	M16	50	11382.160.001	M27	10	11382.270.001
M8	100	11382.080.001	M20	25	11382.200.001	M30	10	11382.300.001
M10	100	11382.100.001						

11350 Nakrętki sześciokątne niskie, metryczne F01A

Gwint	Metryczny							
Materiał	Stal							
Klasa	04							
Obróbka powierzchni	Ocynkowane, po żółtej pasywacji							

d	☒	Kod artykułu	d	☒	Kod artykułu	d	☒	Kod artykułu
M3	250	11350.030.001	M10	100	11350.100.001	M20	25	11350.200.001
M4	250	11350.040.001	M12	100	11350.120.001	M22	25	11350.220.001
M5	250	11350.050.001	M14	100	11350.140.001	M24	25	11350.240.001
M6	250	11350.060.001	M16	50	11350.160.001	M27	10	11350.270.001
M8	100	11350.080.001	M18	25	11350.180.001	M30	10	11350.300.001



01580 Nakrętki sześciokątne niskie z nadwymiarowym gwintem A08A

Gwint	Metryczny							
Materiał	Stal							
Klasa	04							
Obróbka powierzchni	Ocynkowane na gorąco							
								

d	☒	Kod artykułu	d	☒	Kod artykułu	d	☒	Kod artykułu
M12	100	01580.120.001	M20	50	01580.200.001	M24	25	01580.240.001
M14	100	01580.140.001	M22	25	01580.220.001	M30	25	01580.300.001
M16	100	01580.160.001						

- Te nakrętki sześciokątne są stosowane między innymi do śrub cynkowanych na gorąco z gwintem NADWYMIAROWYM i wkrętów z gwintem NADWYMIAROWYM, jak również do cynkowanych na gorąco gwintowanych prętów z gwintem NADWYMIAROWYM.
- Nakrętki są gwintowane po galwanizowaniu i NIE odpowiadają tolerancjom ISO-metrycznym.
- Mimo braku powłoki na gwincie nakrętka zamontowana nie ma obniżonej odporności antykorozyjnej.

01586 Nakrętki sześciokątne niskie z gwintem izometrycznym dopasowanym A08A

Gwint	Metryczny							
Materiał	Stal							
Klasa	04							
Obróbka powierzchni	Ocynkowane na gorąco							
								

d	☒	Kod artykułu	d	☒	Kod artykułu	d	☒	Kod artykułu
M12	100	01586.120.001	M16	50	01586.160.001	M24	25	01586.240.001
M14	100	01586.140.001	M20	25	01586.200.001	M30	25	01586.300.001

- Te nakrętki sześciokątne są stosowane między innymi do śrub cynkowanych na gorąco i wkrętów z gwintem IZOMETRYCZNYM MONTAŻOWYM, jak również do cynkowanych na gorąco prętów gwintowanych z gwintem IZOMETRYCZNYM MONTAŻOWYM.
- Nakrętki są gwintowane po galwanizowaniu i odpowiadają klasie tolerancji 6H.
- Mimo braku powłoki na gwincie nakrętka zamontowana nie ma obniżonej odporności antykorozyjnej.

51090 Nakrętki sześciokątne niskie, metryczne R09A

Gwint Metryczny
 Materiał Stal nierdzewna A2
 Klasa 35



d	☒	Kod artykułu	d	☒	Kod artykułu	d	☒	Kod artykułu
M1,6	250	51090.016.001	M10	100	51090.100.001	M27	5	51090.270.001
M2	250	51090.020.001	M12	50	51090.120.001	M30	3	51090.300.001
M2,5	250	51090.025.001	M14	50	51090.140.001	M33*	10	51090.330.001
M3	250	51090.030.001	M16	50	51090.160.001	M36	10	51090.360.001
M4	250	51090.040.001	M18	25	51090.180.001	M39*	10	51090.390.001
M5	250	51090.050.001	M20	25	51090.200.001	M42*	10	51090.420.001
M6	250	51090.060.001	M22	10	51090.220.001	M48*	10	51090.480.001
M8	100	51090.080.001	M24	10	51090.240.001			

51093 Nakrętki sześciokątne niskie z lewym gwintem R09A

Gwint Metryczny
 Materiał Stal nierdzewna A2
 Klasa 35



d	☒	Kod artykułu	d	☒	Kod artykułu	d	☒	Kod artykułu
M5	200	51093.050.001	M10	100	51093.100.001	M20	25	51093.200.001
M6	200	51093.060.001	M12	50	51093.120.001	M24	25	51093.240.001
M8	100	51093.080.001	M16	50	51093.160.001			

55090 Nakrętki sześciokątne niskie, metryczne R49A

Gwint Metryczny
 Materiał Stal nierdzewna A4
 Klasa 35



d	☒	Kod artykułu	d	☒	Kod artykułu	d	☒	Kod artykułu
M2	250	55090.020.001	M12	50	55090.120.001	M30	3	55090.300.001
M2,5	250	55090.025.001	M14	50	55090.140.001	M33*	10	55090.330.001
M3	250	55090.030.001	M16	50	55090.160.001	M36*	10	55090.360.001
M4	250	55090.040.001	M18	25	55090.180.001	M39*	10	55090.390.001
M5	250	55090.050.001	M20	25	55090.200.001	M42*	10	55090.420.001
M6	250	55090.060.001	M22	10	55090.220.001	M45*	10	55090.450.001
M8	100	55090.080.001	M24	10	55090.240.001	M48*	10	55090.480.001
M10	100	55090.100.001	M27	5	55090.270.001			

47030 Nakrętki sześciokątne niskie, metryczne M01C

Gwint Metryczny
 Materiał Mosiądz Cu2



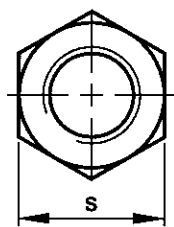
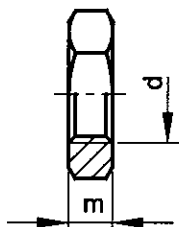

d	☒	Kod artykułu	d	☒	Kod artykułu	d	☒	Kod artykułu
M3	250	47030.030.001	M8	100	47030.080.001	M16	50	47030.160.001
M4	250	47030.040.001	M10	100	47030.100.001	M20	50	47030.200.001
M5	250	47030.050.001	M12	100	47030.120.001	M24	25	47030.240.001
M6	250	47030.060.001						

Nakrętki sześciokątne niskie, metryczne drobnozwojne

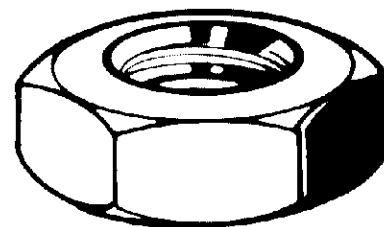

DIN 439 (1987)
NEN 2334 B
ASME B18.2.4.5M
NF E25-453



Informacje techniczne

d	m	s	d	m	s
M8	4	13	M33	16.5	50
M10	5	17	M35 (#DIN)	17.5	55
M12	6	19	M36	18	55
M14	7	22	M38 (#DIN)	19	60
M16	8	24	M39	19.5	60
M18	9	27	M40 (#DIN)	20	60
M20	10	30	M42	21	65
M22	11	32	M45	22.5	70
M24	12	36	M48	24	75
M27	13.5	41	M52	26	80
M28 (#DIN)	14	41	M56 (#DIN)	28	85
M30	15	46	M64 (#DIN)	32	95
M32 (#DIN)	16	50			

Grupy katalogowe

Gwint	Gniazdo	Materiał	Klasa	Obróbka powierzchni	Kod	Strona
M.drob.	Sześciokąt	St	04		11070	3-35
M.drob.	Sześciokąt	St	04		11074	3-36
M.drob.	Sześciokąt	St	04	Ocynk.	11380	3-36
M.drob.	Sześciokąt	St	04	Ocynk.	11075	3-36
M.drob.	Sześciokąt	St.St. A2	35		51092	3-36
M.drob.	Sześciokąt	St.St. A2	35		51166	3-37
M.drob.	Sześciokąt	St.St. A4	35		55092	3-37
M.drob.	Sześciokąt	St.St. A4	35		55166	3-37

11070 Nakrętki sześciokątne niskie, metryczne drobnozwojne

F01B

Gwint Metryczny drobnozwojny
Materiał Stal
Klasa 04

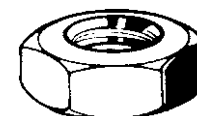

d x P	☒	Kod artykułu	d x P	☒	Kod artykułu	d x P	☒	Kod artykułu
M8X1,00	100	11070.080.100	M22X1,50	25	11070.220.150	M39X3,00	3	11070.390.300
M10X1,00	100	11070.100.100	M22X2,00	25	11070.220.200	M40X1,50 (#DIN)	3	11070.400.150
M10X1,25	100	11070.100.125	M24X1,50	25	11070.240.150	M40X2,00 (#DIN)	3	11070.400.200
M12X0,75 (#DIN)	100	11070.120.075	M24X2,00 (#DIN)	25	11070.240.200	M42X1,50	3	11070.420.150
M12X1,00 (#DIN)	100	11070.120.100	M27X1,50	10	11070.270.150	M45X1,50	1	11070.450.150
M12X1,25	100	11070.120.125	M27X2,00	10	11070.270.200	M45X2,00	1	11070.450.200
M12X1,50	100	11070.120.150	M30X1,50	10	11070.300.150	M45X3,00	1	11070.450.300
M14X1,00 (#DIN)	100	11070.140.100	M30X2,00	10	11070.300.200	M48X1,50	1	11070.480.150
M14X1,25 (#DIN)	100	11070.140.125	M32X1,50	10	11070.320.150	M48X2,00	1	11070.480.200
M14X1,50	100	11070.140.150	M32X2,00	5	11070.320.200	M48X3,00	1	11070.480.300
M16X1,00 (#DIN)	50	11070.160.100	M33X1,50	5	11070.330.150	M52X1,50	1	11070.520.150
M16X1,50	50	11070.160.150	M33X2,00	5	11070.330.200	M52X2,00	1	11070.520.200
M18X1,00 (#DIN)	25	11070.180.100	M35X1,50 (#DIN)	3	11070.350.150	M52X3,00	1	11070.520.300
M18X2,00	25	11070.180.200	M36X1,50	3	11070.360.150	M56X2,00 (#DIN)	1	11070.560.200
M20X1,00 (#DIN)	25	11070.200.100	M36X3,00	3	11070.360.300	M56X4,00 (#DIN)	1	11070.560.400
M20X1,50	25	11070.200.150	M38X1,50 (#DIN)	3	11070.380.150	M64X1,50 (#DIN)	1	11070.640.150
M20X2,00	25	11070.200.200	M39X1,50	3	11070.390.150	M64X2,00 (#DIN)	1	11070.640.200
M22X1,00 (#DIN)	25	11070.220.100	M39X2,00	3	11070.390.200	M64X4,00 (#DIN)	1	11070.640.400

11074 Nakrętki sześciokątne niskie z lewym gwintem, metryczne drobnozwojne F01B

Gwint: Metryczny drobnozwojny
 Materiał: Stal
 Klasa: 04

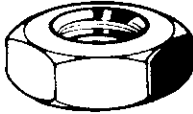
d x P	☒	Kod artykułu	d x P	☒	Kod artykułu	d x P	☒	Kod artykułu
M10X1,00	50	11074.100.100	M22X1,50	10	11074.220.150	M36X3,00	3	11074.360.300
M12X1,00 (≠DIN)	50	11074.120.100	M22X2,00	10	11074.220.200	M38X1,50 (≠DIN)	3	11074.380.150
M12X1,50	50	11074.120.150	M27X1,50	5	11074.270.150	M42X1,50	3	11074.420.150
M14X1,50	50	11074.140.150	M27X2,00	5	11074.270.200	M42X3,00	3	11074.420.300
M16X1,00 (≠DIN)	50	11074.160.100	M28X1,50 (≠DIN)	5	11074.280.150	M45X3,00	1	11074.450.300
M16X1,50	25	11074.160.150	M30X2,00	5	11074.300.200	M48X1,50	1	11074.480.150
M18X1,50	10	11074.180.150	M33X1,50	5	11074.330.150	M48X3,00	1	11074.480.300
M20X1,50	10	11074.200.150	M36X1,50	3	11074.360.150			
M20X2,00	10	11074.200.200	M36X2,00	3	11074.360.200			

11380 Nakrętki sześciokątne niskie, metryczne drobnozwojne F01B

Gwint: Metryczny drobnozwojny
 Materiał: Stal
 Klasa: 04
 Obróbka powierzchni: Ocynkowane

d x P	☒	Kod artykułu	d x P	☒	Kod artykułu	d x P	☒	Kod artykułu
M8X1,00	100	11380.080.100	M14X1,50	100	11380.140.150	M24X1,50	25	11380.240.150
M10X1,00	100	11380.100.100	M16X1,00 (≠DIN)	50	11380.160.100	M24X2,00	25	11380.240.200
M10X1,25	100	11380.100.125	M16X1,50	50	11380.160.150	M27X1,50	10	11380.270.150
M12X1,00 (≠DIN)	100	11380.120.100	M18X1,00 (≠DIN)	25	11380.180.100	M27X2,00	10	11380.270.200
M12X1,25	100	11380.120.125	M18X1,50	25	11380.180.150	M30X1,50	10	11380.300.150
M12X1,50	100	11380.120.150	M20X1,00 (≠DIN)	25	11380.200.100	M30X2,00	10	11380.300.200
M14X1,00 (≠DIN)	100	11380.140.100	M20X1,50	25	11380.200.150	M36X1,50	3	11380.360.150
M14X1,25 (≠DIN)	100	11380.140.125	M22X1,50	25	11380.220.150	M36X3,00	3	11380.360.300

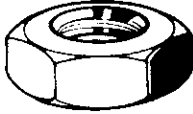
11075 Nakrętki sześciokątne niskie z lewym gwintem, metryczne drobnozwojne F01B

Gwint: Metryczny drobnozwojny
 Materiał: Stal
 Klasa: 04
 Obróbka powierzchni: Ocynkowane

d x P	☒	Kod artykułu	d x P	☒	Kod artykułu	d x P	☒	Kod artykułu
M12X1,00 (≠DIN)	50	11075.120.100	M16X1,50	25	11075.160.150	M24X2,00	10	11075.240.200
M12X1,50	50	11075.120.150	M18X1,50	10	11075.180.150	M27X2,00	5	11075.270.200
M14X1,50	50	11075.140.150	M20X1,50	10	11075.200.150	M30X2,00	5	11075.300.200
M16X1,00 (≠DIN)	50	11075.160.100						

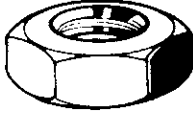
51092 Nakrętki sześciokątne niskie, metryczne drobnozwojne R09A

Gwint: Metryczny drobnozwojny
 Materiał: Stal nierdzewna A2
 Klasa: 35

d x P	☒	Kod artykułu	d x P	☒	Kod artykułu	d x P	☒	Kod artykułu
M8X0,75*	200	51092.080.075	M14X1,50	50	51092.140.150	M24X1,50	10	51092.240.150
M8X1,00	100	51092.080.100	M16X1,50	50	51092.160.150	M24X2,00	10	51092.240.200
M10X1,00	100	51092.100.100	M18X1,50	25	51092.180.150	M27X1,50	3	51092.270.150
M10X1,25	100	51092.100.125	M20X1,50	25	51092.200.150	M30X1,50	3	51092.300.150
M12X1,00	100	51092.120.100	M20X2,00*	50	51092.200.200	M30X2,00	3	51092.300.200
M12X1,25	100	51092.120.125	M22X1,50	10	51092.220.150	M33X2,00*	10	51092.330.200
M12X1,50	100	51092.120.150	M22X2,00*	25	51092.220.200			

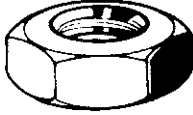
51166	Nakrętki sześciokątne niskie z lewym gwintem, metryczne drobnozwojne		R09A
Gwint	Metryczny drobnozwojny		 
Materiał	Stal nierdzewna A2		
Klasa	35		

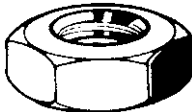
d x P	☒	Kod artykułu	d x P	☒	Kod artykułu	d x P	☒	Kod artykułu
M16X1,50	50	51166.160.150	M27X2,00	3	51166.270.200	M30X2,00	3	51166.300.200
M20X1,50	25	51166.200.150						

55092	Nakrętki sześciokątne niskie, metryczne drobnozwojne		R49A
Gwint	Metryczny drobnozwojny		 
Materiał	Stal nierdzewna A4		
Klasa	35		

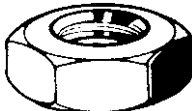
d x P	☒	Kod artykułu	d x P	☒	Kod artykułu	d x P	☒	Kod artykułu
M8X1,00	100	55092.080.100	M16X1,50	50	55092.160.150	M24X2,00	10	55092.240.200
M10X1,00	100	55092.100.100	M18X1,50	25	55092.180.150	M27X1,50*	25	55092.270.150
M10X1,25	100	55092.100.125	M20X1,50	25	55092.200.150	M27X2,00*	25	55092.270.200
M12X1,00*	100	55092.120.100	M22X1,50	10	55092.220.150	M30X1,50	10	55092.300.150
M12X1,25	100	55092.120.125	M22X2,00*	25	55092.220.200	M30X2,00*	10	55092.300.200
M12X1,50	100	55092.120.150	M24X1,50	10	55092.240.150	M33X2,00*	10	55092.330.200
M14X1,50	50	55092.140.150						

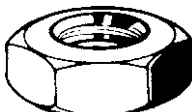
55166	Nakrętki sześciokątne niskie, drobnozwojne, lewy gwint		R49A
Gwint	Metryczny drobnozwojny		 
Materiał	Stal nierdzewna A4		
Klasa	35		

d x P	☒	Kod artykułu	d x P	☒	Kod artykułu
M16X1,50*	50	55166.160.150	M20X1,50*	50	55166.200.150

Nakrętki sześciokątne niskie

DIN 936

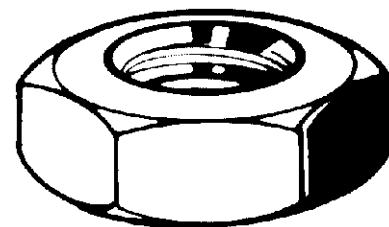
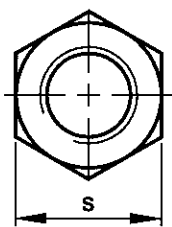
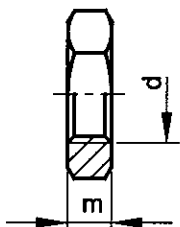

3

Informacje techniczne

d	m	P	s
M8	5	1.25	13
M10	6	1.5	17
M12	7	1.75	19
M14	8	2	22
M16	8	2	24
M18	9	2.5	27
M20	9	2.5	30
M22	10	2.5	32
M24	10	3	36
M27	12	3	41
M30	12	3.5	46
M33	14	3.5	50
M36	14	4	55
M39	16	4	60

Grupy katalogowe

Gwint	Gniazdo	Materiał	Kod	Strona
M	Sześciokąt	St.St. A2	51221	3-38
M	Sześciokąt	St.St. A4	55221	3-38

51221 Nakrętki sześciokątne niskie

R09A

Gwint Metryczny
Materiał Stal nierdzewna A2

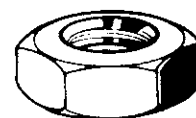

d	☒	Kod artykułu	d	☒	Kod artykułu	d	☒	Kod artykułu
M8*	500	51221.080.001	M18*	50	51221.180.001	M30*	25	51221.300.001
M10*	200	51221.100.001	M20*	50	51221.200.001	M33*	10	51221.330.001
M12*	200	51221.120.001	M22*	50	51221.220.001	M36*	10	51221.360.001
M14*	100	51221.140.001	M24*	25	51221.240.001	M39*	10	51221.390.001
M16*	100	51221.160.001	M27*	25	51221.270.001			

55221 Nakrętki sześciokątne niskie

R49A

Gwint Metryczny
Materiał Stal nierdzewna A4

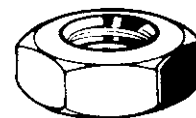

d	☒	Kod artykułu	d	☒	Kod artykułu	d	☒	Kod artykułu
M10*	200	55221.100.001	M16*	100	55221.160.001	M24*	25	55221.240.001
M12*	200	55221.120.001	M20*	50	55221.200.001	M27*	25	55221.270.001
M14*	100	55221.140.001						

Nakrętki sześciokątne niskie, drobnozwojne DIN 936

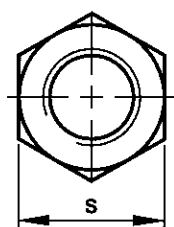
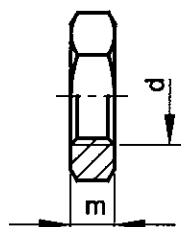

DIN 936

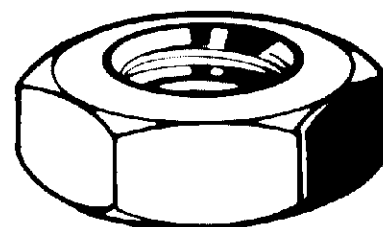

Informacje techniczne

d	m	P	s
M10	6	17	1
M12	7	19	1
M20	9	30	1.5
M24	10	36	2

51222 Nakrętki sześciokątne niskie, drobnozwojne DIN 936

R09A

Gwint: Metryczny drobnozwojny
 Materiał: Stal nierdzewna A2
 Klasa: 35

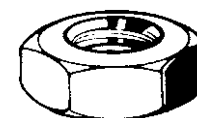

d x P	☒	Kod artykułu	d x P	☒	Kod artykułu	d x P	☒	Kod artykułu
M10X1,00*	100	51222.100.100	M20X1,50*	100	51222.200.150	M24X2,00*	50	51222.240.200
M12X1,00*	100	51222.120.100						

Nakrętki sześciokątne niskie, ISO 4035

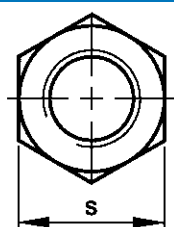
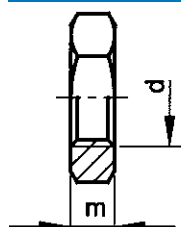

ISO 4035

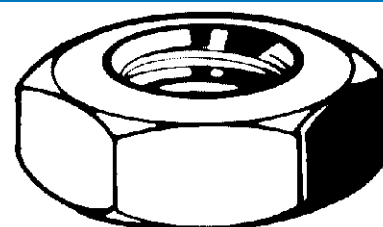

Informacje techniczne

d	m (maks.)	P	s
M12	6	1.75	18
M16	8	2	24
M20	10	2.5	30
M24	12	3	36
M27	14	3	41
M30	15	3.5	46
M36	18	4	55

01587 Nakrętki sześciokątne niskie, ISO 4035

A08A

Gwint: Metryczny
 Materiał: Stal
 Obróbka powierzchni: Ocynkowane na gorąco

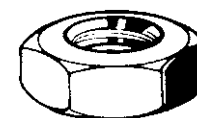

d	☒	Kod artykułu	d	☒	Kod artykułu	d	☒	Kod artykułu
M12	100	01587.120.001	M24	50	01587.240.001	M30	25	01587.300.001
M16	100	01587.160.001	M27	50	01587.270.001	M36	10	01587.360.001
M20	100	01587.200.001						

- Te nakrętki sześciokątne są stosowane między innymi do śrub cynkowanych na gorąco i wkrętów z gwintem IZOMETRYCZNYM MONTAŻOWYM, jak również do cynkowanych na gorąco prętów gwintowanych z gwintem IZOMETRYCZNYM MONTAŻOWYM.
- Nakrętki są gwintowane po galwanizowaniu i odpowiadają klasie tolerancji 6H.
- Mimo braku powłoki na gwincie, zamontowana nakrętka nie wpływa niekorzystnie na odporność na korozję.

Przeciwnakrętki, toczone, UNC

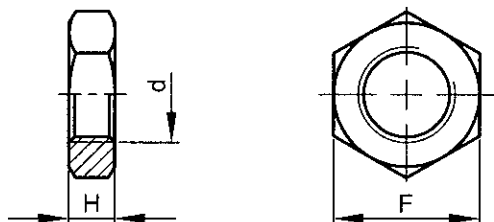

ASME ≈B18.2.2

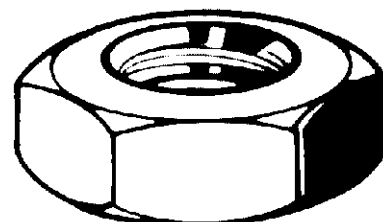

3

Informacje techniczne

d	F	H (mm)	Zwoje gwintu na cal	d	F	H (mm)	Zwoje gwintu na cal
1/4	7/16	4	20	3/4	1.1/8	10.7	10
5/16	1/2	4.8	18	7/8	1.5/16	12.3	9
3/8	9/16	5.6	16	1 Inch	1.1/2	13.9	8
7/16	11/16	6.4	14	1.1/8	1.11/16	18.3	7
1/2	3/4	7.9	13	1.1/4	1.7/8	18.3	7
5/8	15/16	9.5	11	1.1/2	2.1/4	21.4	6

11840 Przeciwnakrętki, toczone, UNC

X09A

Gwint Calowy, zunifikowany grubozwojny (UNC)
Materiał Stal automatowa
Klasa 04
Obróbka powierzchni Ocynkowane

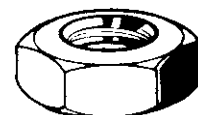

d	☒	Kod artykułu	d	☒	Kod artykułu	d	☒	Kod artykułu
1/4	250	11840.063.001	1/2	100	11840.127.001	1 Inch	25	11840.254.001
5/16	250	11840.079.001	5/8	100	11840.158.001	1.1/8	10	11840.285.001
3/8	250	11840.096.001	3/4	50	11840.191.001	1.1/4	10	11840.317.001
7/16	100	11840.111.001	7/8	25	11840.222.001	1.1/2	5	11840.381.001

Nakrętki sześciokątne do rur

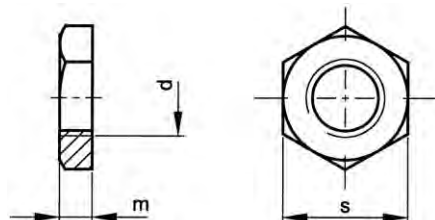

DIN 431 A

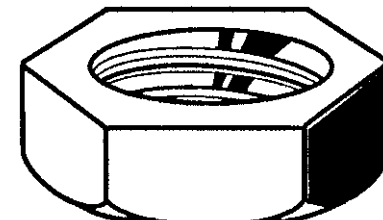

Informacje techniczne

d	m (maks.)	s	Zwoje gwintu na cal	d	m (maks.)	s	Zwoje gwintu na cal
G 1/8	6.48	18	28	G 7/8	9.58	41	14
G 1/4	6.48	21	19	G 1 Inch	10.58	46	11
G 3/8	7.58	27	19	G 1.1/4	11.7	55	11
G 1/2	8.58	34	14	G 1.1/2	12.7	60	11
G 5/8	8.58	34	14	G 2 Inch	13.7	75	11
G 3/4	9.58	36	14				

Grupy katalogowe

Gwint	Gniazdo	Materiał	Kod	Strona
G	Sześciokąt	St.St. A2	51200	3-41
G	Sześciokąt	St.St. A4	55200	3-41

51200 Nakrętki sześciokątne do rur		R09A
Gwint	Rurowy	
Materiał	Stal nierdzewna A2	
		

d	☒	Kod artykułu	d	☒	Kod artykułu	d	☒	Kod artykułu
G1/8*	100	51200.031.001	G5/8*	25	51200.158.001	G1.1/4*	5	51200.317.001
G1/4*	100	51200.063.001	G3/4*	25	51200.191.001	G1.1/2*	5	51200.381.001
G3/8*	50	51200.096.001	G7/8*	10	51200.222.001	G2 Inch*	5	51200.508.001
G1/2*	50	51200.127.001	G1 Inch*	10	51200.254.001			

55200 Nakrętki sześciokątne do rur		R49A
Gwint	Rurowy	
Materiał	Stal nierdzewna A4	
		

d	☒	Kod artykułu	d	☒	Kod artykułu	d	☒	Kod artykułu
G1/8	50	55200.031.001	G1/2	25	55200.127.001	G1.1/4	1	55200.317.001
G1/4	50	55200.063.001	G5/8	25	55200.158.001	G1.1/2	1	55200.381.001
G5/16*	10	55200.079.001	G3/4	10	55200.191.001	G2 Inch	1	55200.508.001
G3/8	50	55200.096.001	G1 Inch	4	55200.254.001			

Caterpillar, UNF

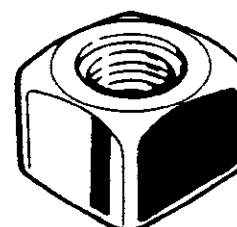
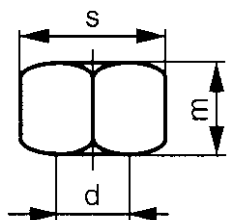

Informacje techniczne

d x m	s (mm)	Zwoje gwintu na cal	d x m	s (mm)	Zwoje gwintu na cal
7/16x16	19	20	3/4x19	28	16
1/2x18	19	20	3/4x21	28	16
9/16x19	22	18	7/8x23	33.3	14
5/8x18	24	18	1 Inchx25.2	38.1	14
5/8x19	25	18	1 Inchx33	38.1	14

- 1-calowe nakrętki do chłapaczy są klasy 6.
- Odpowiadających im śrub szukaj w sekcji 1 katalogu.

Grupy katalogowe

Gwint	Gniazdo	Materiał	Klasa	Kod	Strona
UNF	Sześciokąt	Stal automatowa		typ wysoki	06060 3-41
UNF	Sześciokąt	St	12	typ niski	06070 3-42
UNF	Kwadratowy łeb	St	12	kwadrat	06080 3-42

06060 Nakrętki wysokie, UNF		Y90A
Gwint	Calowy, zunifikowany drobnozwojny (UNF)	
Materiał	Stal automatowa	
		

d x m	☒	Kod artykułu
1 Inchx33	25	06060.256.001

06070 Nakrętki niskie, UNF		Y90A	
Gwint	Całowy, zunifikowany drobnozwojny (UNF)		
Materiał	Stal		
Klasa	12		
d x m	✉ Kod artykułu	d x m	✉ Kod artykułu
5/8x18	50 06070.158.001	7/8x23	25 06070.222.001
3/4x21	50 06070.191.001	1 Inchx25,2	25 06070.256.001

3

06080 Nakrętki kwadratowe, UNF		Y90A	
Gwint	Całowy, zunifikowany drobnozwojny (UNF)		
Materiał	Stal		
Klasa	12		
d x m	✉ Kod artykułu	d x m	✉ Kod artykułu
7/16x16	100 06080.111.001	5/8x19	50 06080.158.001
1/2x18	100 06080.127.001	3/4x19	50 06080.191.001
9/16x19	50 06080.142.001	1 Inchx25,2	25 06080.256.001

Nakrętki do wydechów

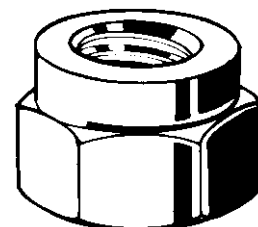
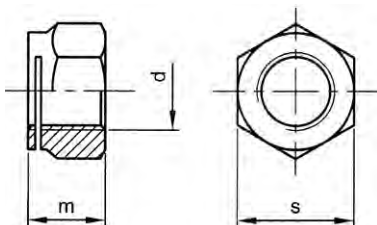

Grupy katalogowe

Gwint	Gniazdo	Materiał	Obróbka powierzchni	Kod	Strona
M	Sześciokąt	St	Miedz. typ samozabezpieczający	72130	3-42
M.drob.	Sześciokąt	St	Miedz. typ samozabezpieczający	72131	3-42
UNC	Sześciokąt	Mosiądz		72122	3-43
UNF	Sześciokąt	Mosiądz		72123	3-43

72130 THERMAG Nakrętki do wydechów		Y92F	
Gwint	Metryczny		
Materiał	Stal		
Obróbka powierzchni	Miedziowane		
d	✉ Kod artykułu	d	✉ Kod artykułu
M8 s=12	100 72130.080.120	M10 s=14	100 72130.100.140
M8 s=13	100 72130.080.130	M10 s=17	100 72130.100.170
M12 s=17	50 72130.120.170		

- Odporność na temperaturę od -70°C do +400°C.

72131 THERMAG Nakrętki do wydechów		Y92F	
Gwint	Metryczny drobnozwojny		
Materiał	Stal		
Obróbka powierzchni	Miedziowane		
d x P	✉ Kod artykułu		
M10X1,25 s=14	100 72131.100.125		

- Odporność na temperaturę od -70°C do +400°C.

72122	Nakrętki do wydechów		Y92F
Gwint	Cалowy, zunifikowany grubozwojny (UNC)		
Materiał	Mosiądz		
			

d	☒	Kod artykułu	d	☒	Kod artykułu
5/16		50 72122.079.001	3/8		25 72122.096.001

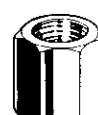
72123	Nakrętki do wydechów		Y92F
Gwint	Cалowy, zunifikowany drobnozwojny (UNF)		
Materiał	Mosiądz		
			

d	☒	Kod artykułu	d	☒	Kod artykułu	d	☒	Kod artykułu
5/16		50 72123.079.001	3/8		25 72123.096.001	1/2		10 72123.127.001

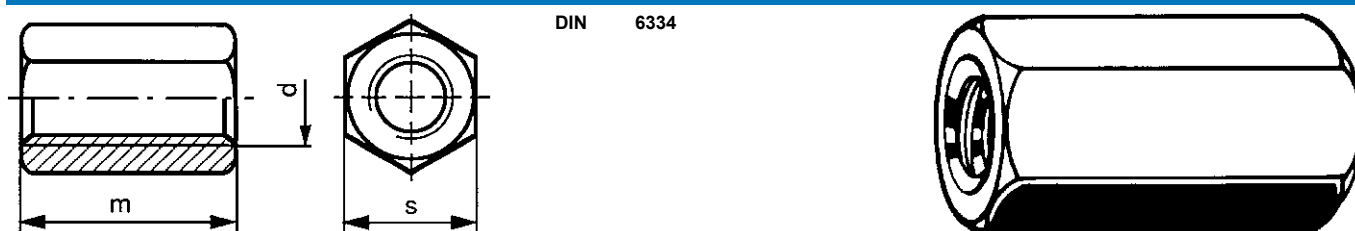

Nakrętki sześciokątne łączące, wysokość 3xd



Informacje techniczne							
d	m	P	s	d	m	P	s
M5	15	0.8	8	M20	60	2.5	30
M6	18	1	10	M22	66	2.5	32
M8	24	1.25	13	M24	72	3	36
M10	30	1.5	17	M27	81	3	41
M12	36	1.75	19	M30	90	3.5	46
M14	42	2	22	M36	108	4	55
M16	48	2	24	M42	126	4.5	65
M18	54	2.5	27	M48	144	5	75

• Te nakrętki łączące są stosowane między innymi do łączenia prętów gwintowanych.

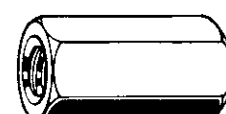
Grupy katalogowe						
Gwint	Gniazdo	Materiał	Klasa	Obróbka powierzchni	Kod	Strona
M	Sześciokąt	Stal automatowa		Ocynk.	11400	3-43
M	Sześciokąt	St		Ocynk. gor.	11417	3-44
M	Sześciokąt	St		Ocynk. gor.	11411	3-44
M	Sześciokąt	St	10	Ocynk.	11418	3-44
M	Sześciokąt	St.St. A1			51106	3-44
M	Sześciokąt	St.St. A4			55106	3-44
M	Sześciokąt	Mosiądz			47195	3-45

11400	Nakrętki sześciokątne łączące, wysokość 3xd		F01C
Gwint	Metryczny		
Materiał	Stal automatowa		
Obróbka powierzchni	Ocynkowane		
			

d	☒	Kod artykułu	d	☒	Kod artykułu	d	☒	Kod artykułu
M5		100 11400.050.001	M12		50 11400.120.001	M24		10 11400.240.001
M6		100 11400.060.001	M14		25 11400.140.001	M27		10 11400.270.001
M8		100 11400.080.001	M16		25 11400.160.001	M30		10 11400.300.001
M10		50 11400.100.001	M20		25 11400.200.001			

11417 Nakrętka łącząca 6-kątna izometryczna F01A

Gwint Metryczny
 Materiał Stal
 Obróbka powierzchni Ocynkowane na gorąco



d	☒	Kod artykułu	d	☒	Kod artykułu	d	☒	Kod artykułu
M16	25	11417.160.001	M24	10	11417.240.001	M42	5	11417.420.001
M20	25	11417.200.001	M30	10	11417.300.001			

3

- Te nakrętki sześciokątne są stosowane między innymi do śrub cynkowanych na gorąco i wkrętów z gwintem IZOMETRYCZNYM MONTAŻOWYM, jak również do cynkowanych na gorąco prętów gwintowanych z gwintem IZOMETRYCZNYM MONTAŻOWYM.
- Nakrętki są gwintowane po galwanizowaniu i odpowiadają klasie tolerancji 6H.
- Mimo braku powłoki na gwincie, zamontowana nakrętka nie wpływa niekorzystnie na odporność na korozję.

11411 Nakrętka łącząca 6-kątna z gwintem nadwymiarowym F01A

Gwint Metryczny
 Materiał Stal
 Obróbka powierzchni Ocynkowane na gorąco

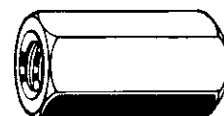

d	☒	Kod artykułu	d	☒	Kod artykułu	d	☒	Kod artykułu
M10	100	11411.100.001	M16	25	11411.160.001	M24	10	11411.240.001
M12	100	11411.120.001	M20	25	11411.200.001	M30	10	11411.300.001

11418 Nakrętki sześciokątne łączące, wysokość 3xd F01C

Gwint Metryczny
 Materiał Stal
 Klasa |10|
 Obróbka powierzchni Ocynkowane

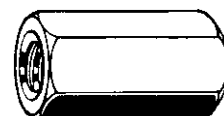

d	☒	Kod artykułu	d	☒	Kod artykułu	d	☒	Kod artykułu
M6	50	11418.060.001	M16	25	11418.160.001	M30	5	11418.300.001
M8	50	11418.080.001	M18	10	11418.180.001	M36	3	11418.360.001
M10	50	11418.100.001	M20	10	11418.200.001	M42	3	11418.420.001
M12	25	11418.120.001	M22	10	11418.220.001	M48	3	11418.480.001
M14	25	11418.140.001	M24	5	11418.240.001			

51106 Nakrętki sześciokątne łączące, wysokość 3xd R09A

Gwint Metryczny
 Materiał Stal nierdzewna A1

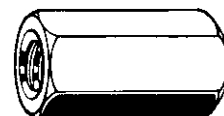

d	☒	Kod artykułu	d	☒	Kod artykułu	d	☒	Kod artykułu
M5	50	51106.050.001	M12	25	51106.120.001	M20	10	51106.200.001
M6	50	51106.060.001	M14*	50	51106.140.001	M24	5	51106.240.001
M8	50	51106.080.001	M16	10	51106.160.001	M30*	10	51106.300.001
M10	25	51106.100.001						

- W zależności od dostępności może zostać dostarczona stal A1, jak również stal A2.

55106 Nakrętki sześciokątne łączące, wysokość 3xd R49A

Gwint Metryczny
 Materiał Stal nierdzewna A4

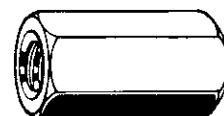

d	☒	Kod artykułu	d	☒	Kod artykułu	d	☒	Kod artykułu
M5	50	55106.050.001	M12	25	55106.120.001	M20	10	55106.200.001
M6	50	55106.060.001	M14*	50	55106.140.001	M24	5	55106.240.001
M8	50	55106.080.001	M16	10	55106.160.001	M30*	10	55106.300.001
M10	25	55106.100.001						

47195	Nakrętki sześciokątne łączące, wysokość 3xd		M11C
Gwint	Metryczny		
Materiał	Mosiądz		
			

d	☒	Kod artykułu	d	☒	Kod artykułu	d	☒	Kod artykułu
M5	100	47195.050.001	M10	50	47195.100.001	M20	25	47195.200.001
M6	100	47195.060.001	M12	50	47195.120.001	M24	10	47195.240.001
M8	100	47195.080.001	M16	25	47195.160.001			

3

Nakrętki łączące sześciokątne wysokie



Informacje techniczne

d	P	s
M6	1	10
M8	1.25	13
M10	1.5	17
M12	1.75	19
M16	2	24
M20	2.5	30
M24	3	36
M30	3.5	46

Grupy katalogowe

Gwint	Gniazdo	Materiał	Klasa	Obróbka powierzchni	Kod	Strona
M	Sześciokąt	Stal automatowa		Ocynk.	11408	3-45
M	Sześciokąt	St.St. A2	50		51101	3-45
M	Sześciokąt	St.St. A4	50		55101	3-46

11408	Nakrętki łączące sześciokątne wysokie		F01C
Gwint	Metryczny		
Materiał	Stal automatowa		
Obróbka powierzchni	Ocynkowane		
			

d x m	☒	Kod artykułu	d x m	☒	Kod artykułu	d x m	☒	Kod artykułu
M6X30	100	11408.060.030	M10X40	100	11408.100.040	M12X40	50	11408.120.040
M8X30	100	11408.080.030						

51101	Nakrętki łączące sześciokątne wysokie		R09A
Gwint	Metryczny		
Materiał	Stal nierdzewna A2		
Klasa	50		
			

d x m	☒	Kod artykułu	d x m	☒	Kod artykułu	d x m	☒	Kod artykułu
M6X25*	100	51101.060.025	M10X40*	100	51101.100.040	M16X50*	25	51101.160.050
M6X30*	100	51101.060.030	M12X30*	50	51101.120.030	M20X50*	25	51101.200.050
M8X25*	100	51101.080.025	M12X40*	50	51101.120.040	M24X50*	25	51101.240.050
M8X30*	100	51101.080.030	M16X40*	25	51101.160.040	M30X60*	10	51101.300.060
M10X25*	100	51101.100.025						

55101	Nakrętki łączące sześciokątne wysokie	R49A
Gwint	Metryczny	
Materiał	Stal nierdzewna A4	
Klasa	50	
		

d x m	☒	Kod artykułu	d x m	☒	Kod artykułu	d x m	☒	Kod artykułu
M6X25*	100	55101.060.025	M12X30*	50	55101.120.030	M24X50*	25	55101.240.050
M8X30*	100	55101.080.030	M16X40*	25	55101.160.040	M30X60*	10	55101.300.060
M10X30*	100	55101.100.030	M20X50*	25	55101.200.050			

3

Części odległościowe z gwintem wewnętrznym i zewnętrznym, typ H1202

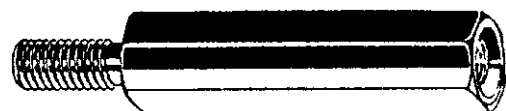
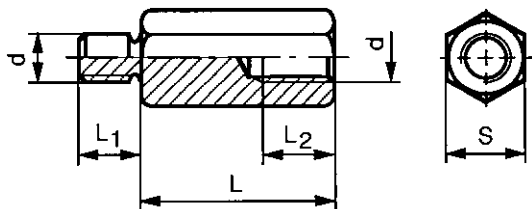

Informacje techniczne

d	L ₁	P	s	d	L ₁	P	s
M2.5	5.6	0.45	4	M4	8	0.7	7
M3	6	0.5	5.5	M5	10	0.8	8

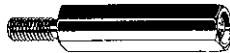
11398	Części odległościowe z gwintem wewnętrznym i zewnętrznym, typ H1202	F01C
Gwint	Metryczny	
Materiał	Stal automatowa	
Klasa	[6]	
Obróbka powierzchni	Ocynkowane	
		

d x L x L ₂	☒	Kod artykułu	d x L x L ₂	☒	Kod artykułu	d x L x L ₂	☒	Kod artykułu
M2,5X10X3	100	11398.025.010	M3X25X7	100	11398.030.025	M4X35X9	100	11398.040.035
M2,5X15X7	100	11398.025.015	M3X30X7	100	11398.030.030	M4X40X9	100	11398.040.040
M2,5X20X7	100	11398.025.020	M3X35X7	100	11398.030.035	M4X50X9	100	11398.040.050
M2,5X25X7	100	11398.025.025	M3X40X7	100	11398.030.040	M5X10X6	100	11398.050.010
M3X5X3	100	11398.030.005	M3X45X7	100	11398.030.045	M5X15X11	100	11398.050.015
M3X8X5	100	11398.030.008	M3X50X7	100	11398.030.050	M5X20X11	100	11398.050.020
M3X10X7	100	11398.030.010	M4X5X3	100	11398.040.005	M5X25X11	100	11398.050.025
M3X12X7	100	11398.030.012	M4X10X6	100	11398.040.010	M5X30X11	100	11398.050.030
M3X13,5X7	100	11398.030.013	M4X15X9	100	11398.040.015	M5X35X11	100	11398.050.035
M3X15X7	100	11398.030.015	M4X20X9	100	11398.040.020	M5X40X11	100	11398.050.040
M3X18X7	100	11398.030.018	M4X25X9	100	11398.040.025	M5X50X11	100	11398.050.050
M3X20X7	100	11398.030.020	M4X30X9	100	11398.040.030			

Części odległościowe z 2x gwintem wewnętrznym, typ H1200

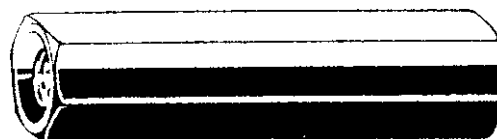
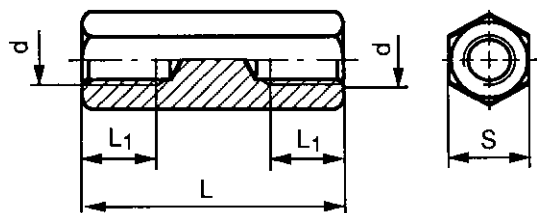

Informacje techniczne

d	P	s	d	P	s
M2.5	0.45	4	M4	0.7	7
M3	0.5	5.5	M5	0.8	8

3

11396 Części odległościowe z 2x gwintem wewnętrznym, typ H1200

F01C

Gwint: Metryczny
 Materiał: Stal automatowa
 Klasa: |6|
 Obróbka powierzchni: Ocynkowane

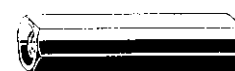

d x L x L ₁	☒	Kod artykułu	d x L x L ₁	☒	Kod artykułu	d x L x L ₁	☒	Kod artykułu
M2,5X15X7	100	11396.025.015	M3X35X7	100	11396.030.035	M4X40X9	100	11396.040.040
M2,5X20X7	100	11396.025.020	M3X40X7	100	11396.030.040	M4X50X9	100	11396.040.050
M2,5X25X7	100	11396.025.025	M3X45X7	100	11396.030.045	M5X15X15	100	11396.050.015
M3X5X5	100	11396.030.005	M3X50X7	100	11396.030.050	M5X20X9	100	11396.050.020
M3X8,5X8,5	100	11396.030.008	M4X10X10	100	11396.040.010	M5X25X9	100	11396.050.025
M3X10X10	100	11396.030.010	M4X15X15	100	11396.040.015	M5X30X9	100	11396.050.030
M3X12X12	100	11396.030.012	M4X20X9	100	11396.040.020	M5X35X9	100	11396.050.035
M3X15X7	100	11396.030.015	M4X25X9	100	11396.040.025	M5X40X9	100	11396.050.040
M3X20X7	100	11396.030.020	M4X30X9	100	11396.040.030	M5X45X9	100	11396.050.045
M3X25X7	100	11396.030.025	M4X35X9	100	11396.040.035	M5X50X9	100	11396.050.050
M3X30X7	100	11396.030.030						

Zwężki rurowe

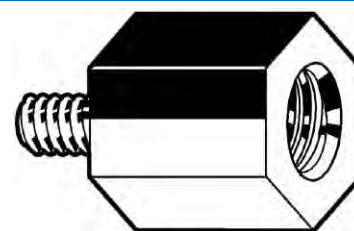
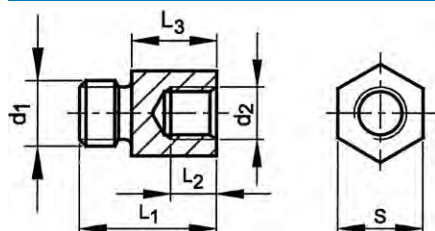

Informacje techniczne

d ₂ / d ₁	L ₁	L ₂	L ₃	P/P	s
M6/M8	20	7	12	1/1.25	13
M6/M10	21	7	13	1/1.25	13
M8/M6	19	7	12	1.25/1	13
M8/M10	21	7	13	1.25/1.5	13
M8/M12	23	7	13	1.25/1.75	13
M10/M6	22	9	15	1.5/1	13
M10/M8	23	9	15	1.5/1.25	13
M10/M12	23	8	13	1.5/1.75	13
M10/M16	32	9	18	1.5/2	19
M12/M8	23	8	15	1.75/1.25	17
M12/M10	25	8	15	1.75/1.5	17
M16/M10	32	13	22	2/1.5	24
M16/M12	32	13	22	2/1.75	24

11393	Zwężki rurowe	F01C
Gwint	Metryczny	
Materiał	Stal automatowa	
Obróbka powierzchni	Ocynkowane	

$d_2/d_1 \times s$	☒	Kod artykułu	$d_2/d_1 \times s$	☒	Kod artykułu	$d_2/d_1 \times s$	☒	Kod artykułu
M6XM8/s=13	25	11393.060.080	M10XM6/s=13	25	11393.100.060	M12XM8/s=17	10	11393.120.080
M6XM10/s=13	25	11393.060.100	M10XM8/s=13	25	11393.100.080	M12XM10/s=17	10	11393.120.100
M8XM6/s=13	25	11393.080.060	M10XM12/s=13	25	11393.100.120	M16XM10/s=24	5	11393.160.100
M8XM10/s=13	25	11393.080.100	M10XM16/s=17	10	11393.100.160	M16XM12/s=24	5	11393.160.120
M8XM12/s=13	25	11393.080.120						

3

Nakrętki sześciokątne samozabezpieczające z wkładką plastikową, metryczne

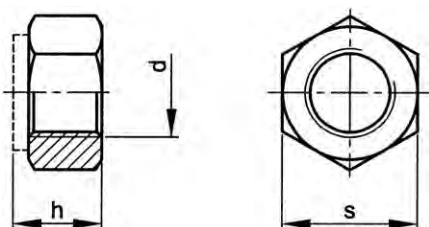

DIN 985 (1987)
ISO 7040
NF E25-412

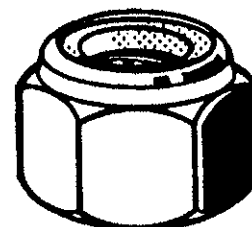

Informacje techniczne

d	h	P	s	d	h	P	s
M2.5 (#DIN)	3.5	0.45	5	M24	24	3	36
M3	4	0.5	5.5	M27	27	3	41
M4	5	0.7	7	M30	30	3.5	46
M5	5	0.8	8	M33	33	3.5	50
M6	6	1	10	M36	36	4	55
M7	7.5	1	11	M39	39	4	60
M8	8	1.25	13	M42	42	4.5	65
M10	10	1.5	17	M45	45	4.5	70
M12	12	1.75	19	M48	48	5	75
M14	14	2	22	M52 (#DIN)	52	5	80
M16	16	2	24	M56 (#DIN)	56	5.5	85
M18	18.5	2.5	27	M60 (#DIN)	60	5.5	90
M20	20	2.5	30	M64 (#DIN)	64	6	95
M22	22	2.5	32				



Grupy katalogowe

Gwint	Gniazdo	Materiał	Klasa	Obróbka powierzchni	Kod	Strona
M	Sześciokąt	St	≥ 5	Ocynk.	12300	3-48
M	Sześciokąt	St	≥ 5	Ocynk.	12310	3-49
M	Sześciokąt	St	≥ 5	Ocynk. żłt. pas.	12302	3-49
M	Sześciokąt	St	6	FLZNNC-NC6	12307	3-49
M	Sześciokąt	St	8	Ocynk.	12348	3-49
M	Sześciokąt	St	8	Ocynk. żłt. pas.	12350	3-50
M	Sześciokąt	St	10	Ocynk.	12410	3-50
M	Sześciokąt	St	10	Ocynk. żłt. pas.	12450	3-50
M	Sześciokąt	St.St. A2			51730	3-50
M	Sześciokąt	St.St. A2		METALFORM	51729	3-50
M	Sześciokąt	St.St. A2		METALFORM	51728	3-51
M	Sześciokąt	St.St. A4			55730	3-51
M	Sześciokąt	Al Dural			45110	3-51

12300	Nakrętki sześciokątne samozabezpieczające z wkładką plastikową, metryczne	F06A
Gwint	Metryczny	
Materiał	Stal	
Klasa	≥ 5	
Obróbka powierzchni	Ocynkowane	

d	☒	Kod artykułu	d	☒	Kod artykułu	d	☒	Kod artykułu
M2,5	250	12300.025.001	M5	250	12300.050.001	M8	250	12300.080.001
M3	250	12300.030.001	M6	250	12300.060.001	M10	200	12300.100.001
M4	250	12300.040.001	M7	250	12300.070.001	M12	100	12300.120.001

12300 Nakrętki sześciokątne samozabezpieczające z wkładką plastikową, metryczne								
d	☒	Kod artykułu	d	☒	Kod artykułu	d	☒	Kod artykułu
M14	100	12300.140.001	M27	10	12300.270.001	M45	4	12300.450.001
M16	50	12300.160.001	M30	10	12300.300.001	M48	4	12300.480.001
M18	50	12300.180.001	M33	5	12300.330.001	M52	1	12300.520.001
M20	25	12300.200.001	M36	5	12300.360.001	M56	1	12300.560.001
M22	25	12300.220.001	M39	5	12300.390.001	M60	1	12300.600.001
M24	25	12300.240.001	M42	5	12300.420.001	M64	1	12300.640.001

12310 Nakrętki sześciokątne samozabezpieczające z wkładką plastikową, metryczne								F06A
Gwint	Metryczny							
Materiał	Stal							
Klasa	≥ 5							
Obróbka powierzchni	Ocynkowane							
								
d	☒	Kod artykułu	d	☒	Kod artykułu	d	☒	Kod artykułu
M3	2500	12310.030.001	M6	2500	12310.060.001	M12	500	12310.120.001
M4	2500	12310.040.001	M8	2000	12310.080.001	M16	250	12310.160.001
M5	2500	12310.050.001	M10	750	12310.100.001			

12302 Nakrętki sześciokątne samozabezpieczające z wkładką plastikową, metryczne								F05A
Gwint	Metryczny							
Materiał	Stal							
Klasa	≥ 5							
Obróbka powierzchni	Ocynkowane, po żółtej pasywacji							
d	☒	Kod artykułu	d	☒	Kod artykułu	d	☒	Kod artykułu
M3	250	12302.030.001	M8	250	12302.080.001	M18	50	12302.180.001
M4	250	12302.040.001	M10	100	12302.100.001	M20	25	12302.200.001
M5	250	12302.050.001	M12	100	12302.120.001	M22	25	12302.220.001
M6	250	12302.060.001	M14	100	12302.140.001	M24	25	12302.240.001
M7	200	12302.070.001	M16	50	12302.160.001			

12307 Nakrętki sześciokątne samozabezpieczające z wkładką plastikową, metryczne								A96A
Gwint	Metryczny							
Materiał	Stal							
Klasa	6							
Obróbka powierzchni	O cynk płatkowy bez Cr6+ wg ISO 10683 (flZnnc)							
								
d	☒	Kod artykułu	d	☒	Kod artykułu	d	☒	Kod artykułu
M6	250	12307.060.001	M14	100	12307.140.001	M22	25	12307.220.001
M8	250	12307.080.001	M16	50	12307.160.001	M24	25	12307.240.001
M10	200	12307.100.001	M18	50	12307.180.001	M27	10	12307.270.001
M12	100	12307.120.001	M20	25	12307.200.001	M30	10	12307.300.001

12348 Nakrętki sześciokątne samozabezpieczające z wkładką plastikową, metryczne								F05A
Gwint	Metryczny							
Materiał	Stal							
Klasa	8							
Obróbka powierzchni	Ocynkowane							
								
d	☒	Kod artykułu	d	☒	Kod artykułu	d	☒	Kod artykułu
M4	250	12348.040.001	M14	100	12348.140.001	M27	10	12348.270.001
M5	250	12348.050.001	M16	50	12348.160.001	M30	10	12348.300.001
M6	250	12348.060.001	M18	50	12348.180.001	M33	5	12348.330.001
M8	250	12348.080.001	M20	25	12348.200.001	M36	5	12348.360.001
M10	200	12348.100.001	M22	25	12348.220.001			
M12	100	12348.120.001	M24	25	12348.240.001			

12350 Nakrętki sześciokątne samozabezpieczające z wkładką plastikową, metryczne		F05A
Gwint	Metryczny	
Materiał	Stal	
Klasa	8	
Obróbka powierzchni	Ocynkowane, po żółtej pasywacji	

d	☒	Kod artykułu	d	☒	Kod artykułu	d	☒	Kod artykułu
M6	250	12350.060.001	M14	100	12350.140.001	M24	25	12350.240.001
M8	250	12350.080.001	M16	50	12350.160.001	M27	10	12350.270.001
M10	200	12350.100.001	M20	25	12350.200.001	M30	10	12350.300.001
M12	100	12350.120.001						

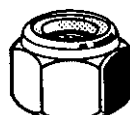
12410 Nakrętki sześciokątne samozabezpieczające z wkładką plastikową, metryczne		F05A
Gwint	Metryczny	
Materiał	Stal	
Klasa	10	
Obróbka powierzchni	Ocynkowane	

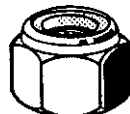

d	☒	Kod artykułu	d	☒	Kod artykułu	d	☒	Kod artykułu
M5	250	12410.050.001	M14	100	12410.140.001	M22	25	12410.220.001
M6	250	12410.060.001	M16	50	12410.160.001	M24	25	12410.240.001
M8	250	12410.080.001	M18	50	12410.180.001	M27	10	12410.270.001
M10	200	12410.100.001	M20	25	12410.200.001	M30	10	12410.300.001
M12	100	12410.120.001						

12450 Nakrętki sześciokątne samozabezpieczające z wkładką plastikową, metryczne		F05A
Gwint	Metryczny	
Materiał	Stal	
Klasa	10	
Obróbka powierzchni	Ocynkowane, po żółtej pasywacji	

d	☒	Kod artykułu	d	☒	Kod artykułu	d	☒	Kod artykułu
M6	250	12450.060.001	M14	100	12450.140.001	M24	25	12450.240.001
M8	250	12450.080.001	M16	50	12450.160.001	M27	10	12450.270.001
M10	200	12450.100.001	M20	25	12450.200.001	M30	10	12450.300.001
M12	100	12450.120.001						

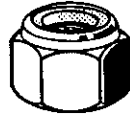
51730 Nakrętki sześciokątne samozabezpieczające z wkładką plastikową, metryczne		R09A
Gwint	Metryczny	
Materiał	Stal nierdzewna A2	



d	☒	Kod artykułu	d	☒	Kod artykułu	d	☒	Kod artykułu
M2,5	200	51730.025.001	M10	100	51730.100.001	M22	25	51730.220.001
M3	200	51730.030.001	M12	50	51730.120.001	M24	10	51730.240.001
M4	200	51730.040.001	M14	50	51730.140.001	M27	5	51730.270.001
M5	200	51730.050.001	M16	20	51730.160.001	M30	5	51730.300.001
M6	200	51730.060.001	M18	50	51730.180.001	M36	5	51730.360.001
M8	100	51730.080.001	M20	20	51730.200.001			

- Nakrętki sześciokątne samozabezpieczające ze stali nierdzewnej z wkładką plastikową mogą powodować zacieranie się gwintu śruby powodując pęknięcie.
- Zaleca się stosowanie do nakrętek sześciokątnych samozabezpieczających ze stali nierdzewnej z wkładką plastikową METALFORM, patrz grupa artykułów 51729 i 51728 lub mieszanki smarującej i zapobiegającej zatarciu NEVERSEEZ.

51729 METALFORM Nakrętki sześciokątne samozabezpieczające z wkładką plastikową, metryczne		R09A
Gwint	Metryczny	
Materiał	Stal nierdzewna A2	
Obróbka powierzchni	METALFORM	



d	☒	Kod artykułu	d	☒	Kod artykułu	d	☒	Kod artykułu
M4	100	51729.040.001	M8	50	51729.080.001	M16	10	51729.160.001
M5	100	51729.050.001	M10	50	51729.100.001	M20	10	51729.200.001
M6	100	51729.060.001	M12	25	51729.120.001			

51729 METALFORM Nakrętki sześciokątne samozabezpieczające z wkładką plastikową, metryczne

- Cechy szczególne METALFORM:
- To suchy, częściowo widoczny środek smarujący eliminujący możliwość zakleszczenia gwintowanych łączników ze stali nierdzewnej.
- Oprócz tego współczynnik tarcia jest zmniejszany do bardziej stałej wartości.
- W przypadku połączeń śruba/nakrętka, do zapobiegania zakleszczeniu wystarcza nasmarowanie nakrętki METALFORM.
- Po nałożeniu może zostać łatwo usunięty przy pomocy rozpuszczalnika, więc nie ma przeciwwskazań do stosowania w przemyśle żywnościowym.

51728 METALFORM Nakrętki sześciokątne samozabezpieczające z wkładką plastikową, metryczne
R09A

Gwint Metryczny
Materiał Stal nierdzewna A2
Obróbka powierzchni METALFORM



3

d	☒	Kod artykułu	d	☒	Kod artykułu	d	☒	Kod artykułu
M6		1000 51728.060.001	M8		500 51728.080.001	M10		500 51728.100.001

- Cechy szczególne METALFORM:
- To suchy, częściowo widoczny środek smarujący eliminujący możliwość zakleszczenia gwintowanych łączników ze stali nierdzewnej.
- Oprócz tego współczynnik tarcia jest zmniejszany do bardziej stałej wartości.
- W przypadku połączeń śruba/nakrętka, do zapobiegania zakleszczeniu wystarcza nasmarowanie nakrętki METALFORM.
- Po nałożeniu może zostać łatwo usunięty przy pomocy rozpuszczalnika, więc nie ma przeciwwskazań do stosowania w przemyśle żywnościowym.

55730 Nakrętki sześciokątne samozabezpieczające z wkładką plastikową, metryczne
R49A

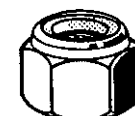
Gwint Metryczny
Materiał Stal nierdzewna A4



d	☒	Kod artykułu	d	☒	Kod artykułu	d	☒	Kod artykułu
M2,5*		500 55730.025.001	M10		100 55730.100.001	M22*		25 55730.220.001
M3		200 55730.030.001	M12		50 55730.120.001	M24		10 55730.240.001
M4		200 55730.040.001	M14		50 55730.140.001	M27		5 55730.270.001
M5		200 55730.050.001	M16		20 55730.160.001	M30		5 55730.300.001
M6		200 55730.060.001	M18		50 55730.180.001	M33		5 55730.330.001
M8		100 55730.080.001	M20		20 55730.200.001			

- Nakrętki sześciokątne samozabezpieczające ze stali nierdzewnej z wkładką plastikową mogą powodować zacieranie się gwintu śruby powodując pęknięcie.
- Zaleca się stosowanie do nakrętek sześciokątnych samozabezpieczających ze stali nierdzewnej z wkładką plastikową METALFORM, patrz grupa artykułów 51729 i 51728 lub mieszanki smarującej i zapobiegającej zatarciu NEVERSEEZ.

45110 Nakrętki sześciokątne samozabezpieczające z wkładką plastikową, metryczne
W010

Gwint Metryczny
Materiał Aluminium Dural
DIN ≈985 (1987)
ISO ≈7040
NF ≈E25-412



d	☒	Kod artykułu	d	☒	Kod artykułu	d	☒	Kod artykułu
M3		200 45110.030.001	M6		200 45110.060.001	M12		50 45110.120.001
M4		200 45110.040.001	M8		100 45110.080.001	M16		20 45110.160.001
M5		200 45110.050.001	M10		100 45110.100.001			

Nakrętki sześciokątne samozabezpieczające z wkładką plastikową, drobnozwojne

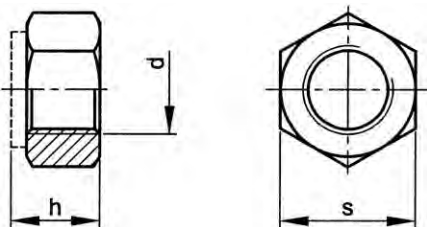

DIN 985 (1987)
ISO 10512
NF E25-412

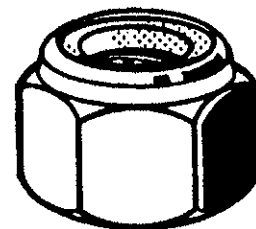

3

Informacje techniczne

d	h	s	d	h	s
M8	8	13	M27	27	41
M10	10	17	M30	30	46
M12	12	19	M33	33	50
M14	14	22	M36	36	55
M16	16	24	M39	39	60
M18	18.5	27	M42	42	65
M20	20	30	M45	45	70
M22	22	32	M48	48	75
M24	24	36			

Grupy katalogowe

Gwint	Gniazdo	Materiał	Klasa	Obróbka powierzchni	Kod	Strona
M.drob.	Sześciokąt	St	≥ 5	Ocynk.	12320	3-52
M.drob.	Sześciokąt	St	8	Ocynk. żłt. pas.	12352	3-52
M.drob.	Sześciokąt	St	10	Ocynk. żłt. pas.	12422	3-53
M.drob.	Sześciokąt	St.St. A2		Gleitmo	51739	3-53
M.drob.	Sześciokąt	St.St. A4		Gleitmo	55739	3-53

12320 Nakrętki sześciokątne samozabezpieczające z wkładką plastikową, drobnozwojne

F05A

Gwint Metryczny drobnozwojny
Materiał Stal
Klasa ≥|5|
Obróbka powierzchni Ocynkowane



d x P	☒	Kod artykułu	d x P	☒	Kod artykułu	d x P	☒	Kod artykułu
M8X1,00	250	12320.080.100	M20X2,00	25	12320.200.200	M33X2,00	5	12320.330.200
M10X1,00	200	12320.100.100	M22X1,50	25	12320.220.150	M36X1,50 (≠DIN)	5	12320.360.150
M10X1,25	200	12320.100.125	M24X1,50 (≠DIN)	25	12320.240.150	M36X3,00	5	12320.360.300
M12X1,00 (≠DIN)	100	12320.120.100	M24X2,00	25	12320.240.200	M39X3,00	5	12320.390.300
M12X1,25	100	12320.120.125	M27X1,50 (≠DIN)	10	12320.270.150	M42X1,50 (≠DIN)	5	12320.420.150
M12X1,50	100	12320.120.150	M27X2,00	10	12320.270.200	M42X3,00	5	12320.420.300
M14X1,50	100	12320.140.150	M30X1,50 (≠DIN)	10	12320.300.150	M45X3,00	4	12320.450.300
M16X1,50	50	12320.160.150	M30X2,00	10	12320.300.200	M48X1,50 (≠DIN)	4	12320.480.150
M18X1,50	50	12320.180.150	M33X1,50 (≠DIN)	5	12320.330.150	M48X3,00	4	12320.480.300
M20X1,50	25	12320.200.150						

12352 Nakrętki sześciokątne samozabezpieczające z wkładką plastikową, drobnozwojne

F05A

Gwint Metryczny drobnozwojny
Materiał Stal
Klasa |8|
Obróbka powierzchni Ocynkowane, po żółtej pasywacji

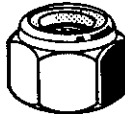

d x P	☒	Kod artykułu	d x P	☒	Kod artykułu	d x P	☒	Kod artykułu
M10X1,00	200	12352.100.100	M12X1,50	100	12352.120.150	M20X1,50	25	12352.200.150
M10X1,25	200	12352.100.125	M14X1,50	100	12352.140.150	M24X2,00	25	12352.240.200
M12X1,25	100	12352.120.125	M16X1,50	50	12352.160.150			

12422	Nakrętki sześciokątne samozabezpieczające z wkładką plastikową, drobnozwojne		F05A
Gwint	Metryczny drobnozwojny		
Materiał	Stal		
Klasa	[10]		
Obróbka powierzchni	Ocynkowane, po żółtej pasywacji		

d x P	☒	Kod artykułu	d x P	☒	Kod artykułu	d x P	☒	Kod artykułu
M8X1,00	250	12422.080.100	M14X1,50	100	12422.140.150	M20X1,50	25	12422.200.150
M10X1,00	200	12422.100.100	M16X1,50	50	12422.160.150	M24X1,50	25	12422.240.150
M12X1,50	100	12422.120.150	M18X1,50	50	12422.180.150			

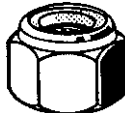
51739	Nakrętki sześciokątne samozabezpieczające z wkładką plastikową, drobnozwojne		R09A
Gwint	Metryczny drobnozwojny		
Materiał	Stal nierdzewna A2		
Obróbka powierzchni	Gleitmo		

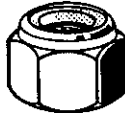

d x P	☒	Kod artykułu	d x P	☒	Kod artykułu	d x P	☒	Kod artykułu
M12X1,50*	200	51739.120.150	M14X1,50*	100	51739.140.150	M16X1,50*	100	51739.160.150

55739	Nakrętki sześciokątne samozabezpieczające z wkładką plastikową, drobnozwojne		R49A
Gwint	Metryczny drobnozwojny		
Materiał	Stal nierdzewna A4		
Obróbka powierzchni	Gleitmo		



d x P	☒	Kod artykułu	d x P	☒	Kod artykułu
M10X1,00*	200	55739.100.100	M14X1,50*	100	55739.140.150

Nakrętki sześciokątne samozabezpieczające z wkładką plastikową, wysokie

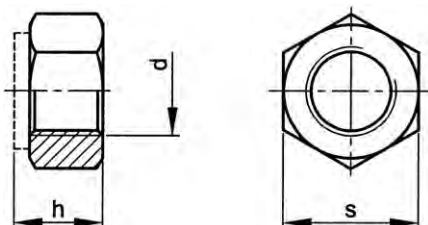

DIN 982
ISO ≈7040
NF ≈E25-409

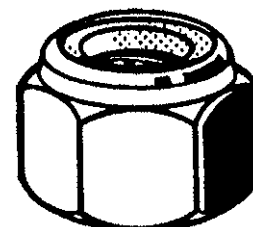



Informacje techniczne

d	h	P	s	d	h	P	s
M4	4.7	0.7	7	M14	16	2	22
M5	6.3	0.8	8	M16	18	2	24
M6	8	1	10	M18	20	2.5	27
M8	9.5	1.25	13	M20	22	2.5	30
M10	11.5	1.5	17	M22	25	2.5	32
M12	14	1.75	19	M24	28	3	36

Grupy katalogowe



Gwint	Gniazdo	Materiał	Klasa	Obróbka powierzchni	Kod	Strona
M	Sześciokąt	St	8	Ocynk.	12600	3-54
M	Sześciokąt	St	10	Ocynk. żłt. pas.	12662	3-54
M	Sześciokąt	St.St. A2			51718	3-54
M	Sześciokąt	St.St. A4			55718	3-54

12600	Nakrętki sześciokątne samozabezpieczające z wkładką plastikową, wysokie				F05A
Gwint	Metryczny				 
Materiał	Stal				
Klasa	8				
Obróbka powierzchni	Ocynkowane				

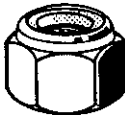

d	☒	Kod artykułu	d	☒	Kod artykułu	d	☒	Kod artykułu
M5	250	12600.050.001	M12	100	12600.120.001	M20	25	12600.200.001
M6	250	12600.060.001	M14	100	12600.140.001	M22	25	12600.220.001
M8	250	12600.080.001	M16	50	12600.160.001	M24	25	12600.240.001
M10	200	12600.100.001	M18	50	12600.180.001			

12662	Nakrętki sześciokątne samozabezpieczające z wkładką plastikową, wysokie				F05A
Gwint	Metryczny				
Materiał	Stal				
Klasa	10				
Obróbka powierzchni	Ocynkowane, po żółtej pasywacji				

d	☒	Kod artykułu	d	☒	Kod artykułu	d	☒	Kod artykułu
M6	250	12662.060.001	M12	100	12662.120.001	M20	25	12662.200.001
M8	250	12662.080.001	M14	100	12662.140.001	M24	25	12662.240.001
M10	200	12662.100.001	M16	50	12662.160.001			

51718	Nakrętki sześciokątne samozabezpieczające z wkładką plastikową, wysokie				R09A	
Gwint	Metryczny		DIN	≈982		 
Materiał	Stal nierdzewna A2					

d	☒	Kod artykułu	d	☒	Kod artykułu	d	☒	Kod artykułu
M4	200	51718.040.001	M10	100	51718.100.001	M16*	50	51718.160.001
M5*	200	51718.050.001	M12	50	51718.120.001	M20*	25	51718.200.001
M6	200	51718.060.001	M14*	50	51718.140.001	M24*	10	51718.240.001
M8	200	51718.080.001						

55718	Nakrętki sześciokątne samozabezpieczające z wkładką plastikową, wysokie				R49A	
Gwint	Metryczny		DIN	≈982		 
Materiał	Stal nierdzewna A4					

d	☒	Kod artykułu	d	☒	Kod artykułu	d	☒	Kod artykułu
M5	200	55718.050.001	M10	50	55718.100.001	M16	10	55718.160.001
M6	100	55718.060.001	M12	25	55718.120.001	M20	10	55718.200.001
M8	50	55718.080.001	M14	25	55718.140.001	M24	5	55718.240.001

- Nakrętki sześciokątne samozabezpieczające ze stali nierdzewnej z wkładką plastikową mogą powodować zacieranie się gwintu śruby powodując pęknięcie.
- Zaleca się stosowanie do nakrętek sześciokątnych samozabezpieczających ze stali nierdzewnej z wkładką plastikową METALFORM, patrz grupa artykułów 51729 i 51728 lub mieszanki smarującej i zapobiegającej zatarciu NEVERSEEZ.

Nakrętki sześciokątne z wkładką nylonową, UNC typ NE, ASME B18.16.6

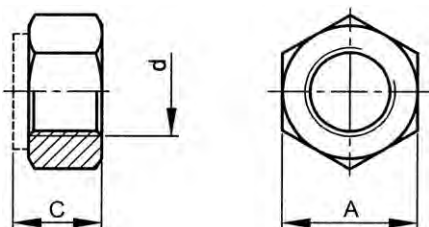

ASME B18.16.6

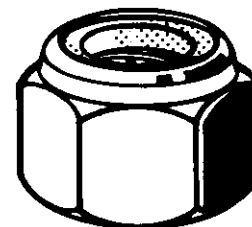

Informacje techniczne

d	A	C	Zwoje gwintu na cal	d	A	C	Zwoje gwintu na cal
No.2	0.251	0.153	56	7/16	0.627	0.468	14
No.3	0.251	0.153	48	1/2	0.752	0.609	13
No.4	0.251	0.153	40	9/16	0.877	0.656	12
No.5	0.251	0.153	40	5/8	0.940	0.765	11
No.6	0.313	0.188	32	3/4	1.064	0.890	10
No.8	0.345	0.239	32	7/8	1.252	0.999	9
No.10	0.376	0.249	24	1 Inch	1.440	1.078	8
1/4	0.439	0.328	20	1.1/8	1.627	1.203	7
5/16	0.502	0.359	18	1.1/4	1.815	1.422	7
3/8	0.564	0.468	16	1.1/2	2.197	1.640	6

Grupy katalogowe

Gwint	Gniazdo	Materiał	Klasa	Obróbka powierzchni	Kod	Strona
UNC	Sześciokąt	St	Grade 2	Ocynk.	U12300	3-55
UNC	Sześciokąt	St	Grade 5	Ocynk.	U12348	3-55
UNC	Sześciokąt	St	Grade 8		U12411	3-56
UNC	Sześciokąt	St	Grade 8	Ocynk. żłt. pas.	U12450	3-56
UNC	Sześciokąt	St.St. A2 (AISI304/18-8)			U51738	3-56
UNC	Sześciokąt	St.St. A4 (AISI316/18-10)			U55730	3-56

U12300 Nakrętki sześciokątne z wkładką nylonową, GR.2 ocynkowane -NE

X09A

Gwint	Całowy, zunifikowany grubozwojny (UNC)
Materiał	Stal
Klasa	Grade 2
Obróbka powierzchni	Ocynkowane



d	☒	Kod artykułu	d	☒	Kod artykułu	d	☒	Kod artykułu
NO.2-56*	100	U12300.008.0001	1/4-20*	100	U12300.025.0001	3/4-10*	10	U12300.075.0001
NO.3-48*	100	U12300.009.0001	5/16-18*	100	U12300.031.0001	7/8-9*	5	U12300.087.0001
NO.4-40*	100	U12300.011.0001	3/8-16*	50	U12300.037.0001	1-8*	5	U12300.100.0001
NO.5-40*	100	U12300.012.0001	7/16-14*	25	U12300.043.0001	1.1/8-7*	5	U12300.112.0001
NO.6-32*	100	U12300.013.0001	1/2-13*	25	U12300.050.0001	1.1/4-7*	5	U12300.125.0001
NO.8-32*	100	U12300.016.0001	9/16-12*	25	U12300.056.0001	1.1/2-6*	5	U12300.150.0001
NO.10-24*	100	U12300.019.0001	5/8-11*	10	U12300.062.0001			

U12348 Nakrętki sześciokątne z wkładką nylonową -NE

X01A

Gwint	Całowy, zunifikowany grubozwojny (UNC)
Materiał	Stal
Klasa	Grade 5
Obróbka powierzchni	Ocynkowane

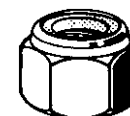

d	☒	Kod artykułu	d	☒	Kod artykułu	d	☒	Kod artykułu
1/4-20*	100	U12348.025.0001	1/2-13*	25	U12348.050.0001	3/4-10*	10	U12348.075.0001
5/16-18*	100	U12348.031.0001	9/16-12*	25	U12348.056.0001	7/8-9*	5	U12348.087.0001
3/8-16*	50	U12348.037.0001	5/8-11*	10	U12348.062.0001	1-8*	5	U12348.100.0001
7/16-14*	25	U12348.043.0001						

U12411	Nakrętki sześciokątne z wkładką nylonową -NE	X01A
Gwint	Całowy, zunifikowany gruboziomyjny (UNC)	
Materiał	Stal	
Klasa	Grade 8	
		

d	☒	Kod artykułu	d	☒	Kod artykułu	d	☒	Kod artykułu
1/4-20*	100	U12411.025.0001	9/16-12*	25	U12411.056.0001	1.-8*	5	U12411.100.0001
5/16-18*	100	U12411.031.0001	5/8-11*	10	U12411.062.0001	1.1/8-7*	5	U12411.112.0001
3/8-16*	50	U12411.037.0001	3/4-10*	10	U12411.075.0001	1.1/4-7*	5	U12411.125.0001
7/16-14*	25	U12411.043.0001	7/8-9*	5	U12411.087.0001	1.1/2-6*	5	U12411.150.0001
1/2-13*	25	U12411.050.0001						

U12450	Nakrętki sześciokątne z wkładką nylonową -NE	X01A
Gwint	Całowy, zunifikowany gruboziomyjny (UNC)	
Materiał	Stal	
Klasa	Grade 8	
Obróbka powierzchni	Ocynkowane, po żółtej pasywacji	
		

d	☒	Kod artykułu	d	☒	Kod artykułu	d	☒	Kod artykułu
1/4-20*	100	U12450.025.0001	9/16-12*	25	U12450.056.0001	1.-8*	5	U12450.100.0001
5/16-18*	100	U12450.031.0001	5/8-11*	10	U12450.062.0001	1.1/8-7*	5	U12450.112.0001
3/8-16*	50	U12450.037.0001	3/4-10*	10	U12450.075.0001	1.1/4-7*	5	U12450.125.0001
7/16-14*	25	U12450.043.0001	7/8-9*	5	U12450.087.0001	1.1/2-6*	5	U12450.150.0001
1/2-13*	25	U12450.050.0001						

U51738	Nakrętki sześciokątne z wkładką nylonową -NE	X15A
Gwint	Całowy, zunifikowany gruboziomyjny (UNC)	
Materiał	Stal nierdzewna A2 (AISI 304/18-8)	
		

d	☒	Kod artykułu	d	☒	Kod artykułu	d	☒	Kod artykułu
NO.2-56*	50	U51738.008.0001	1/4-20*	50	U51738.025.0001	3/4-10*	5	U51738.075.0001
NO.3-48*	50	U51738.009.0001	5/16-18*	50	U51738.031.0001	7/8-9*	5	U51738.087.0001
NO.4-40*	50	U51738.011.0001	3/8-16*	50	U51738.037.0001	1.-8*	5	U51738.100.0001
NO.5-40*	50	U51738.012.0001	7/16-14*	25	U51738.043.0001	1.1/8-7*	2	U51738.112.0001
NO.6-32*	50	U51738.013.0001	1/2-13*	10	U51738.050.0001	1.1/4-7*	2	U51738.125.0001
NO.8-32*	50	U51738.016.0001	9/16-12*	10	U51738.056.0001	1.1/2-6*	2	U51738.150.0001
NO.10-24*	50	U51738.019.0001	5/8-11*	10	U51738.062.0001			

U55730	Nakrętki sześciokątne z wkładką nylonową -NE	X15A
Gwint	Całowy, zunifikowany gruboziomyjny (UNC)	
Materiał	Stal nierdzewna A4 (AISI 316/18-10)	
		

d	☒	Kod artykułu	d	☒	Kod artykułu	d	☒	Kod artykułu
NO.4-40*	50	U55730.011.0001	5/16-18*	50	U55730.031.0001	5/8-11*	10	U55730.062.0001
NO.6-32*	50	U55730.013.0001	3/8-16*	50	U55730.037.0001	3/4-10*	5	U55730.075.0001
NO.8-32*	50	U55730.016.0001	7/16-14*	25	U55730.043.0001	7/8-9*	5	U55730.087.0001
NO.10-24*	50	U55730.019.0001	1/2-13*	10	U55730.050.0001	1.-8*	5	U55730.100.0001
1/4-20*	50	U55730.025.0001	9/16-12*	10	U55730.056.0001			

Nakrętki obniżone z wkładką nylonową, UNC typ NTE, ASME B18.16.6

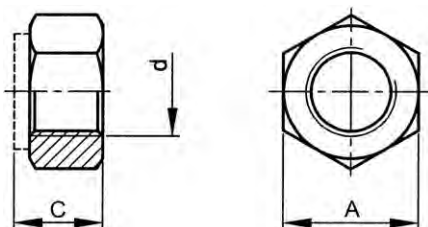

ASME B18.16.6

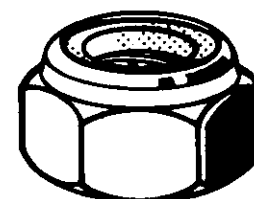

Informacje techniczne

d	A	C	Zwoje gwintu na cal
No.4	0.251	0.124	40
No.5	0.251	0.124	40
No.6	0.313	0.140	32
No.8	0.345	0.187	32
No.10	0.376	0.187	24
1/4	0.439	0.218	20
5/16	0.502	0.265	18
3/8	0.564	0.281	16
7/16	0.627	0.328	14
1/2	0.752	0.328	13
9/16	0.877	0.374	12
5/8	0.940	0.406	11
3/4	1.064	0.421	10
7/8	1.252	0.484	9
1 Inch	1.44	0.578	8

Grupy katalogowe

Gwint	Gniazdo	Materiał	Klasa	Obróbka powierzchni	Kod	Strona
UNC	Sześciokąt	St	Grade 2	Ocynk.	U12423	3-57
UNC	Sześciokąt	St.St. A2 (AISI304/18-8)			U51730	3-57

U12423 Nakrętki obniżone z wkładką nylonową -NTE

X01A

Gwint	Calowy, zunifikowany grubozwojny (UNC)
Materiał	Stal
Klasa	Grade 2
Obróbka powierzchni	Ocynkowane



d	☒	Kod artykułu	d	☒	Kod artykułu	d	☒	Kod artykułu
NO.4-40*	100	U12423.011.0001	1/4-20*	100	U12423.025.0001	9/16-12*	25	U12423.056.0001
NO.5-40*	100	U12423.012.0001	5/16-18*	100	U12423.031.0001	5/8-11*	10	U12423.062.0001
NO.6-32*	100	U12423.013.0001	3/8-16*	50	U12423.037.0001	3/4-10*	10	U12423.075.0001
NO.8-32*	100	U12423.016.0001	7/16-14*	25	U12423.043.0001	7/8-9*	5	U12423.087.0001
NO.10-24*	100	U12423.019.0001	1/2-13*	25	U12423.050.0001	1-8*	5	U12423.100.0001

U51730 Nakrętki obniżone z wkładką nylonową, nierdzewne 304, UNC typ -NTE

X15A

Gwint	Calowy, zunifikowany grubozwojny (UNC)
Materiał	Stal nierdzewna A2 (AISI 304/18-8)



d	☒	Kod artykułu	d	☒	Kod artykułu	d	☒	Kod artykułu
NO.4-40*	50	U51730.011.0001	1/4-20*	50	U51730.025.0001	5/8-11*	10	U51730.062.0001
NO.5-40*	50	U51730.012.0001	5/16-18*	50	U51730.031.0001	3/4-10*	5	U51730.075.0001
NO.6-32*	50	U51730.013.0001	3/8-16*	50	U51730.037.0001	7/8-9*	5	U51730.087.0001
NO.8-32*	50	U51730.016.0001	7/16-14*	25	U51730.043.0001	1-8*	5	U51730.100.0001
NO.10-24*	50	U51730.019.0001	1/2-13*	10	U51730.050.0001			

Nakrętki zabezpieczające obniżone z wkładką nyl. UNF typ NTE, ASME B18.16.6

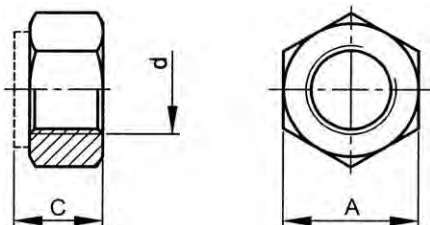

ASME B18.16.6

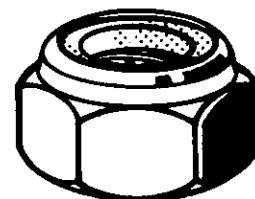

3

Informacje techniczne

d	A	C	Zwoje gwintu na cal
No.10	0.187	0.376	32
1/4	0.218	0.439	28
5/16	0.265	0.502	24
3/8	0.281	0.564	24
7/16	0.328	0.627	20
1/2	0.328	0.752	20
9/16	0.374	0.877	18
5/8	0.406	0.94	18
3/4	0.421	1.064	16
7/8	0.484	1.252	14
1 Inch	0.578	1.440	14
1.1/8	0.672	1.627	12
1.1/4	0.765	1.815	12
1.1/2	0.828	2.197	12

Grupy katalogowe

Gwint	Gniazdo	Materiał	Klasa	Obróbka powierzchni	Kod	Strona
UNF	Sześciokąt	St	Grade 2	Ocyнк.	U12380	3-58
UNF	Sześciokąt	St	Grade 8	Ocyнк.	U12381	3-58
UNF	Sześciokąt	St.St. A2 (AISI304/18-8)			U51422	3-59

U12380 Nakrętki zabezpieczające obniżone z wkładką nyl. -NTE

X01A

Gwint	Całowy, zunifikowany drobnozwojny (UNF)
Materiał	Stal
Klasa	Grade 2
Obróbka powierzchni	Ocyнкowane



d	☒	Kod artykułu	d	☒	Kod artykułu	d	☒	Kod artykułu
NO.10-32*	100	U12380.019.0002	1/2-20*	25	U12380.050.0002	1.-14*	5	U12380.101.0002
1/4-28*	100	U12380.025.0002	9/16-18*	25	U12380.056.0002	1.1/8-12*	5	U12380.112.0002
5/16-24*	100	U12380.031.0002	5/8-18*	10	U12380.062.0002	1.1/4-12*	5	U12380.125.0002
3/8-24*	50	U12380.037.0002	3/4-16*	10	U12380.075.0002	1.1/2-12*	5	U12380.150.0002
7/16-20*	25	U12380.043.0002	7/8-14*	5	U12380.087.0002			



U12381 Nakrętki zabezpieczające obniżone z wkładką nyl. -NTE

X01A

Gwint	Całowy, zunifikowany drobnozwojny (UNF)
Materiał	Stal
Klasa	Grade 8
Obróbka powierzchni	Ocyнкowane



d	☒	Kod artykułu	d	☒	Kod artykułu	d	☒	Kod artykułu
1/4-28*	100	U12381.025.0002	3/4-16*	10	U12381.075.0002	1.1/8-12*	5	U12381.112.0002
5/16-24*	100	U12381.031.0002	7/8-14*	5	U12381.087.0002	1.1/4-12*	5	U12381.125.0002
1/2-20*	25	U12381.050.0002	1.-14*	5	U12381.101.0002	1.1/2-12*	5	U12381.150.0002
5/8-18*	10	U12381.062.0002						

U51422	Nakrętki zabezpieczające obniżone z wkładką nyl. -NTE			X15A
Gwint	Całowy, zunifikowany drobnozwojny (UNF)			
Materiał	Stal nierdzewna A2 (AISI 304/18-8)			
				

d	☒	Kod artykułu	d	☒	Kod artykułu	d	☒	Kod artykułu
NO.10-32*	50	U51422.019.0002	7/16-20*	25	U51422.043.0002	3/4-16*	5	U51422.075.0002
1/4-28*	50	U51422.025.0002	1/2-20*	10	U51422.050.0002	7/8-14*	5	U51422.087.0002
5/16-24*	50	U51422.031.0002	5/8-18*	10	U51422.062.0002	1.-14*	5	U51422.101.0002
3/8-24*	50	U51422.037.0002						

3

Nakrętki zabezpieczające z wkładką nylonową, UNC typ NU, ASME B18.16.6

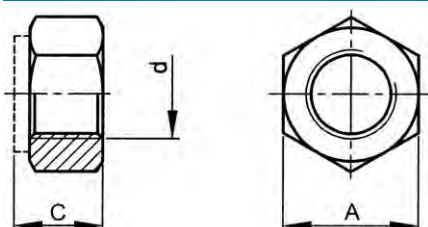

ASME B18.16.6

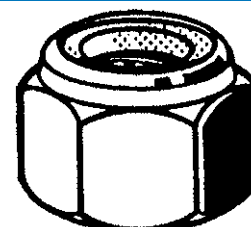

Informacje techniczne

d	A	C	Zwoje gwintu na cal
1/4	0.506	0.39	20
5/16	0.566	0.453	18
3/8	0.691	0.562	16
7/16	0.754	0.609	14
1/2	0.879	0.718	13
9/16	0.942	0.812	12
5/8	1.067	0.874	11
3/4	1.255	1.015	10
7/8	1.444	1.14	9
1 Inch	1.632	1.312	8
1.1/8	1.82	1.469	7
1.1/4	2.008	1.672	7
1.1/2	2.384	1.953	6

Grupy katalogowe

Gwint	Gniazdo	Materiał	Klasa	Obróbka powierzchni	Kod	Strona
UNC	Sześciokąt	St	Grade 2	Ocynk.	U12601	3-59
UNC	Sześciokąt	St.St. A2 (AISI304/18-8)			U51718	3-60

U12601	Nakrętki zabezpieczające z wkładką nylonową -NU			X01A
Gwint	Całowy, zunifikowany grubozwojny (UNC)			
Materiał	Stal			
Klasa	Grade 2			
Obróbka powierzchni	Ocynkowane			
				

d	☒	Kod artykułu	d	☒	Kod artykułu	d	☒	Kod artykułu
1/4-20*	100	U12601.025.0001	9/16-12*	25	U12601.056.0001	1.-8*	5	U12601.100.0001
5/16-18*	100	U12601.031.0001	5/8-11*	10	U12601.062.0001	1.1/8-7*	5	U12601.112.0001
3/8-16*	50	U12601.037.0001	3/4-10*	10	U12601.075.0001	1.1/4-7*	5	U12601.125.0001
7/16-14*	25	U12601.043.0001	7/8-9*	5	U12601.087.0001	1.1/2-6*	5	U12601.150.0001
1/2-13*	25	U12601.050.0001						

U51718	Nakrętki zabezpieczające z wkładką nylonową -NU	X15A
Gwint	Całowy, zunifikowany grubożwojny (UNC)	
Materiał	Stal nierdzewna A2 (AISI 304/18-8)	

d	☒	Kod artykułu	d	☒	Kod artykułu	d	☒	Kod artykułu
1/4-20*	50	U51718.025.0001	5/8-11*	10	U51718.062.0001	1.1/8-7*	5	U51718.112.0001
5/16-18*	50	U51718.031.0001	3/4-10*	5	U51718.075.0001	1.1/4-7*	5	U51718.125.0001
3/8-16*	50	U51718.037.0001	7/8-9*	5	U51718.087.0001	1.1/2-6*	2	U51718.150.0001
1/2-13*	10	U51718.050.0001	1.-8*	5	U51718.100.0001			

3

Nakrętki zabezpieczające obniżone z wkładką nylonową, UNC typ NTU, ASME B18.16.6

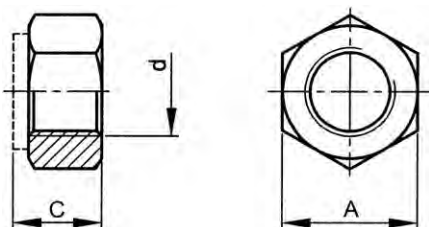

ASME B18.16.6

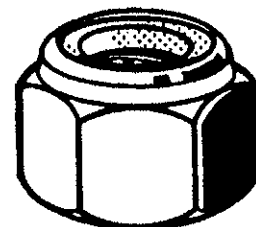

Informacje techniczne



d	A	C	Zwoje gwintu na cal
1/4	0.502	0.296	20
5/16	0.564	0.328	18
3/8	0.690	0.421	16
7/16	0.752	0.453	14
1/2	0.877	0.546	13
9/16	0.940	0.578	12
5/8	1.064	0.624	11
3/4	1.252	0.718	10
7/8	1.440	0.796	9
1 Inch	1.627	0.922	8
1.1/8	1.814	1.000	7
1.1/4	2.008	1.14	7
1.1/2	2.384	1.344	6

Grupy katalogowe

Gwint	Gniazdo	Materiał	Klasa	Obróbka powierzchni	Kod	Strona
UNC	Sześciokąt	St	Grade 2	Ocynek.	U12705	3-60
UNC	Sześciokąt	St.St. A2 (AISI304/18-8)			U51705	3-61

U12705	Nakrętki zabezpieczające obniżone z wkładką nylonową -NTU	X01A
Gwint	Całowy, zunifikowany grubożwojny (UNC)	
Materiał	Stal	
Klasa	Grade 2	
Obróbka powierzchni	Ocynkowane	

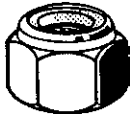
d	☒	Kod artykułu	d	☒	Kod artykułu	d	☒	Kod artykułu
1/4-20*	100	U12705.025.0001	9/16-12*	25	U12705.056.0001	1.-8*	5	U12705.100.0001
5/16-18*	100	U12705.031.0001	5/8-11*	10	U12705.062.0001	1.1/8-7*	5	U12705.112.0001
3/8-16*	50	U12705.037.0001	3/4-10*	10	U12705.075.0001	1.1/4-7*	5	U12705.125.0001
7/16-14*	25	U12705.043.0001	7/8-9*	5	U12705.087.0001	1.1/2-6*	5	U12705.150.0001
1/2-13*	25	U12705.050.0001						

U51705	Nakrętki zabezpieczające obniżone z wkładką nylonową -NTU	X15A
Gwint	Calowy, zunifikowany grubozwojny (UNC)	
Materiał	Stal nierdzewna A2 (AISI 304/18-8)	
		

d	☒	Kod artykułu	d	☒	Kod artykułu	d	☒	Kod artykułu
1/4-20*	50	U51705.025.0001	7/16-14*	25	U51705.043.0001	3/4-10*	5	U51705.075.0001
5/16-18*	50	U51705.031.0001	1/2-13*	10	U51705.050.0001	7/8-9*	5	U51705.087.0001
3/8-16*	50	U51705.037.0001	5/8-11*	10	U51705.062.0001	1-8*	5	U51705.100.0001

Nakrętki zabezpieczające z wkładką nylonową, UNF typ NE, ASME B18.16.6

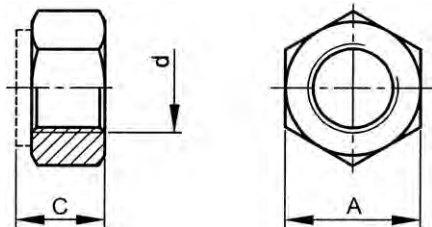

ASME B18.16.6

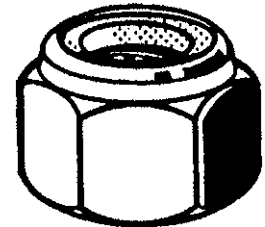

Informacje techniczne

d	A	C	Zwoje gwintu na cal	d	A	C	Zwoje gwintu na cal
No.10	0.376	0.249	32	3/4	1.064	0.89	16
1/4	0.439	0.328	28	7/8	1.252	0.999	14
5/16	0.502	0.359	24	1 Inch-12G	1.440	1.078	12
3/8	0.564	0.468	24	1 Inch-14G	1.440	1.078	14
7/16	0.627	0.468	20	1.1/8	1.627	1.203	12
1/2	0.752	0.609	20	1.1/4	1.422	1.815	12
9/16	0.877	0.656	18	1.1/2	2.197	1.640	12
5/8	0.94	0.765	18				

- W zależności od dostępności wymiary mogą się różnić.
- Jeżeli podczas zamówienia nie określi się gwintu UNF z 12 zwojami na cal, to dostarczamy typ z 14 zwojami na cal (UNS).

Grupy katalogowe

Gwint	Gniazdo	Materiał	Klasa	Obróbka powierzchni	Kod	Strona
UNF	Sześciokąt	St	Grade 2	Ocynk.	U12320	3-61
UNF	Sześciokąt	St	Grade 5	Ocynk.	U12353	3-62
UNF	Sześciokąt	St	Grade 8		U12421	3-62
UNF	Sześciokąt	St	Grade 8	Ocynk. żłt. pas.	U12422	3-62
UNF	Sześciokąt	St.St. A2 (AISI304/18-8)			U51411	3-62
UNF	Sześciokąt	St.St. A4 (AISI316/18-10)			U55411	3-62

U12320	Nakrętki zabezpieczające z wkładką nylonową -NE	X09A
Gwint	Calowy, zunifikowany drobnozwojny (UNF)	
Materiał	Stal	
Klasa	Grade 2	
Obróbka powierzchni	Ocynkowane	

d	☒	Kod artykułu	d	☒	Kod artykułu	d	☒	Kod artykułu
NO.10-32*	100	U12320.019.0002	1/2-20*	25	U12320.050.0002	1-14*	5	U12320.101.0002
1/4-28*	100	U12320.025.0002	9/16-18*	25	U12320.056.0002	1.1/8-12*	5	U12320.112.0002
5/16-24*	100	U12320.031.0002	5/8-18*	10	U12320.062.0002	1.1/4-12*	5	U12320.125.0002
3/8-24*	50	U12320.037.0002	3/4-16*	10	U12320.075.0002	1.1/2-12*	5	U12320.150.0002
7/16-20*	25	U12320.043.0002	7/8-14*	5	U12320.087.0002			

U12353	Nakrętki zabezpieczające z wkładką nylonową -NE		X01A
Gwint	Całowy, zunifikowany drobnozwojny (UNF)		 
Materiał	Stal		
Klasa	Grade 5		
Obróbka powierzchni	Ocynkowane		

d	☒	Kod artykułu	d	☒	Kod artykułu	d	☒	Kod artykułu
1/4-28*	100	U12353.025.0002	7/16-20*	25	U12353.043.0002	5/8-18*	10	U12353.062.0002
5/16-24*	100	U12353.031.0002	1/2-20*	25	U12353.050.0002	3/4-16*	10	U12353.075.0002
3/8-24*	50	U12353.037.0002						

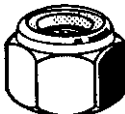
U12421	Nakrętki zabezpieczające z wkładką nylonową -NE		X01A
Gwint	Całowy, zunifikowany drobnozwojny (UNF)		 
Materiał	Stal		
Klasa	Grade 8		
Obróbka powierzchni			

d	☒	Kod artykułu	d	☒	Kod artykułu	d	☒	Kod artykułu
1/4-28*	100	U12421.025.0002	9/16-18*	25	U12421.056.0002	1.-14*	5	U12421.101.0002
5/16-24*	100	U12421.031.0002	5/8-18*	10	U12421.062.0002	1.1/8-12*	5	U12421.112.0002
3/8-24*	50	U12421.037.0002	3/4-16*	10	U12421.075.0002	1.1/4-12*	5	U12421.125.0002
7/16-20*	25	U12421.043.0002	7/8-14*	5	U12421.087.0002	1.1/2-12*	5	U12421.150.0002
1/2-20*	25	U12421.050.0002						

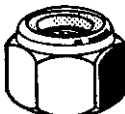
U12422	Nakrętki zabezpieczające z wkładką nylonową-NE		X01A
Gwint	Całowy, zunifikowany drobnozwojny (UNF)		 
Materiał	Stal		
Klasa	Grade 8		
Obróbka powierzchni	Ocynkowane, po żółtej pasywacji		

d	☒	Kod artykułu	d	☒	Kod artykułu	d	☒	Kod artykułu
1/4-28*	100	U12422.025.0002	9/16-18*	25	U12422.056.0002	1.-14*	5	U12422.101.0002
5/16-24*	100	U12422.031.0002	5/8-18*	10	U12422.062.0002	1.1/8-12*	5	U12422.112.0002
3/8-24*	50	U12422.037.0002	3/4-16*	10	U12422.075.0002	1.1/4-12*	5	U12422.125.0002
7/16-20*	25	U12422.043.0002	7/8-14*	5	U12422.087.0002	1.1/2-12*	5	U12422.150.0002
1/2-20*	25	U12422.050.0002						

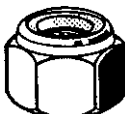
U51411	Nakrętki zabezpieczające z wkładką nylonową -NE		X15A
Gwint	Całowy, zunifikowany drobnozwojny (UNF)		 
Materiał	Stal nierdzewna A2 (AISI 304/18-8)		
Obróbka powierzchni			
Obróbka powierzchni			

d	☒	Kod artykułu	d	☒	Kod artykułu	d	☒	Kod artykułu
NO.10-32*	50	U51411.019.0002	7/16-20*	25	U51411.043.0002	3/4-16*	5	U51411.075.0002
1/4-28*	50	U51411.025.0002	1/2-20*	10	U51411.050.0002	7/8-14*	5	U51411.087.0002
5/16-24*	50	U51411.031.0002	9/16-18*	10	U51411.056.0002	1.-14*	5	U51411.101.0002
3/8-24*	50	U51411.037.0002	5/8-18*	10	U51411.062.0002			

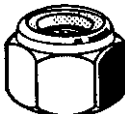
U55411	Nakrętki zabezpieczające z wkładką nylonową -NE		X15A
Gwint	Całowy, zunifikowany drobnozwojny (UNF)		 
Materiał	Stal nierdzewna A4 (AISI 316/18-10)		
Obróbka powierzchni			
Obróbka powierzchni			

d	☒	Kod artykułu	d	☒	Kod artykułu	d	☒	Kod artykułu
NO.10-32*	50	U55411.019.0002	7/16-20*	25	U55411.043.0002	3/4-16*	5	U55411.075.0002
1/4-28*	50	U55411.025.0002	1/2-20*	10	U55411.050.0002	7/8-14*	5	U55411.087.0002
5/16-24*	50	U55411.031.0002	9/16-18*	10	U55411.056.0002	1.-14*	5	U55411.101.0002
3/8-24*	50	U55411.037.0002	5/8-18*	10	U55411.062.0002			

Nakrętki sześciokątne samozabezpieczające, BSW

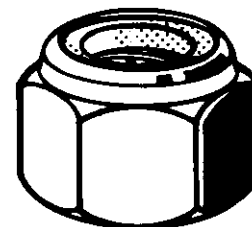
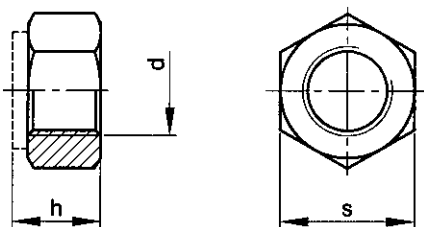

Informacje techniczne

d	h	s	Zwoje gwintu na cal	d	h	s	Zwoje gwintu na cal
1/4	8.3	7/16	20	5/8	19.4	15/16	11
5/16	9.1	1/2	18	3/4	22.6	1.1/8	10
3/8	11.9	9/16	16	7/8	25.3	1.5/16	9
1/2	15.5	3/4	12	1 Inch	27.6	1.1/2	8

- Te nakrętki sześciokątne samozabezpieczające nie są znormalizowane. W zależności od dostępności wymiary mogą się różnić.
- Gwint Whitworth'a (BSW/BSF) nie jest zalecany do międzynarodowego stosowania. Zaleca się stosowanie gwintu metrycznego (M/MF) lub zunifikowanego (UNC/UNF).

12340 Nakrętki sześciokątne samozabezpieczające, BSW

X08A

Gwint: Całowy, Whitworth'a (BSW)
 Materiał: Stal
 Klasa: 6
 Obróbka powierzchni: Ocynkowane

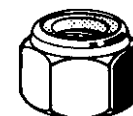

d	☒	Kod artykułu	d	☒	Kod artykułu	d	☒	Kod artykułu
1/4	100	12340.063.001	1/2	50	12340.127.001	7/8	10	12340.222.001
5/16	100	12340.079.001	5/8	25	12340.158.001	1 Inch	10	12340.254.001
3/8	100	12340.096.001	3/4	25	12340.191.001			

Nakrętki sześciokątne samozabezpieczające, BSF

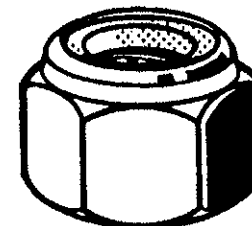
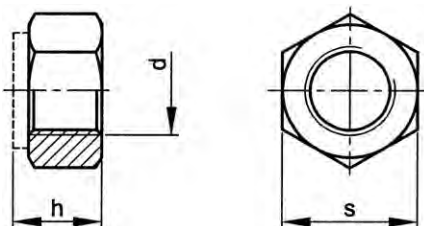

Informacje techniczne

d	h	s	Zwoje gwintu na cal	d	h	s	Zwoje gwintu na cal
1/4	8.3	7/16	26	1/2	15.5	3/4	16
5/16	9.1	1/2	22	9/16	16.7	7/8	16
3/8	11.9	9/16	20	5/8	19.4	15/16	14
7/16	11.9	11/16	18	3/4	22.6	1.1/8	12

- Te nakrętki sześciokątne samozabezpieczające nie są znormalizowane.
- W zależności od dostępności wymiary mogą się różnić.
- Gwint Whitworth'a (BSW/BSF) nie jest zalecany do międzynarodowego stosowania.
- Zaleca się stosowanie gwintu metrycznego (M/MF) lub zunifikowanego (UNC/UNF).

12400 Nakrętki sześciokątne samozabezpieczające, BSF

X90A

Gwint: Całowy, Whitwortha, drobnozwojny (BSF)
 Materiał: Stal
 Klasa: 6
 Obróbka powierzchni: Ocynkowane



d	☒	Kod artykułu	d	☒	Kod artykułu	d	☒	Kod artykułu
1/4	100	12400.063.001	7/16	100	12400.111.001	5/8	25	12400.158.001
5/16	100	12400.079.001	1/2	50	12400.127.001	3/4	25	12400.191.001
3/8	100	12400.096.001	9/16	50	12400.142.001			

Nakrętki sześciokątne samozabezpieczające, całe ze stali nierdzewnej

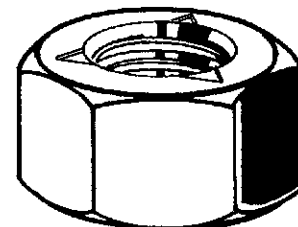
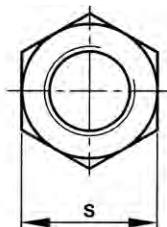
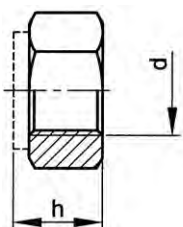

3

Informacje techniczne

d	h	P	s	d	h	P	s
M3	2.4	0.5	5.5	M12	10	1.75	19
M4	3.2	0.7	7	M14	11	2	22
M5	4	0.8	8	M16	13	2	24
M6	5	1	10	M20	16	2.5	30
M7	5.5	1	11	M24	19	3	36
M8	6.5	1.25	13	M18	15	2.5	27
M10	8	1.5	17	M22	18	2.5	32

- Blokowanie jest uzyskiwane przez miejscowo promieniowe odkształcenie gwintu.

Grupy katalogowe

Gwint	Gniazdo	Materiał	Klasa	Kod	Strona
M	Sześciokąt	St.St. A2	70	51720	3-64
M	Sześciokąt	St.St. A4	80	55720	3-64

51720 Nakrętki sześciokątne samozabezpieczające, całe ze stali nierdzewnej

R09A

Gwint Metryczny
Materiał Stal nierdzewna A2
Klasa 70

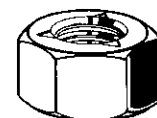

d	☒	Kod artykułu	d	☒	Kod artykułu	d	☒	Kod artykułu
M3	100	51720.030.001	M8	50	51720.080.001	M18*	50	51720.180.001
M4	100	51720.040.001	M10	50	51720.100.001	M20	10	51720.200.001
M5	100	51720.050.001	M12	25	51720.120.001	M22*	25	51720.220.001
M6	100	51720.060.001	M14	25	51720.140.001	M24	5	51720.240.001
M7*	200	51720.070.001	M16	10	51720.160.001			

55720 Nakrętki sześciokątne samozabezpieczające, całe ze stali nierdzewnej

R49A

Gwint Metryczny
Materiał Stal nierdzewna A4
Klasa 80

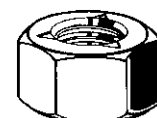

d	☒	Kod artykułu	d	☒	Kod artykułu	d	☒	Kod artykułu
M3*	200	55720.030.001	M8*	200	55720.080.001	M16*	50	55720.160.001
M4*	200	55720.040.001	M10*	100	55720.100.001	M20*	50	55720.200.001
M5*	200	55720.050.001	M12*	100	55720.120.001	M24*	10	55720.240.001
M6*	200	55720.060.001	M14*	50	55720.140.001			

Nakrętki sześciokątne samozabezpieczające, plastikowe

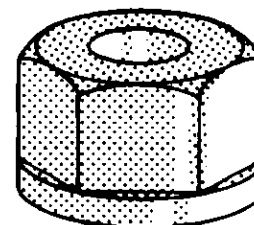
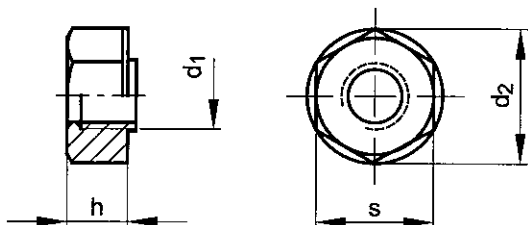

Informacje techniczne

d ₁	d ₂	h	P	s	d ₁	d ₂	h	P	s
M4	9.3	6.4	0.7	7	M6	11.4	8	1	10
M5	10.5	7.3	0.8	9	M8	16.2	10.3	1.25	14

56220 Nakrętki sześciokątne samozabezpieczające, plastikowe

W02A

Gwint Metryczny
Materiał Plastik Poliamid (nylon)
Klasa PA 6.6
Kolor Biały

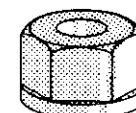

d ₁	☒	Kod artykułu	d ₁	☒	Kod artykułu	d ₁	☒	Kod artykułu
M4	100	56220.040.001	M6	100	56220.060.001	M8	50	56220.080.001
M5	100	56220.050.001						

Nakrętki sześciokątne samozabezpieczające, całe ze stali, metryczne

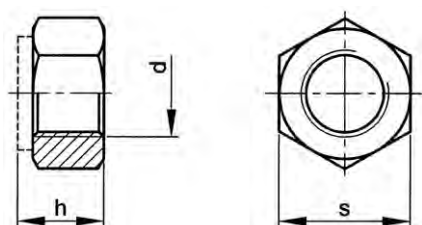

DIN 980V(1987)
ISO 7042
NEN 2452
NF E25-410
BS 4929-1

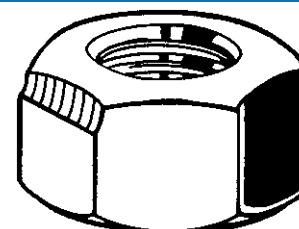

Informacje techniczne

d	h (max.)	P	s	d	h (max.)	P	s
M5	5.1	0.8	8	M18	18	2.5	27
M6	6	1	10	M20	20	2.5	30
M8	8	1.25	13	M22	22	2.5	32
M10	10	1.5	17	M24	24	3	36
M12	12	1.75	19	M27	27	3	41
M14	14	2	22	M30	30	3.5	46
M16	16	2	24	M36	36	4	55

Grupy katalogowe

Gwint	Gniazdo	Materiał	Klasa	Obróbka powierzchni	Kod	Strona
M	Sześciokąt	St	8	Ocynk.	12858	3-65
M	Sześciokąt	St	8	Ocynk. żłt. pas.	12880	3-66
M	Sześciokąt	St	10	Ocynk.	12910	3-66

12858 STOVER Nakrętki sześciokątne samozabezpieczające, całe ze stali

F01J

Gwint Metryczny
Materiał Stal
Klasa 8
Obróbka powierzchni Ocynkowane

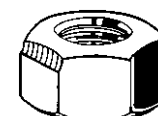

d	☒	Kod artykułu	d	☒	Kod artykułu	d	☒	Kod artykułu
M5	250	12858.050.001	M14	100	12858.140.001	M24	25	12858.240.001
M6	250	12858.060.001	M16	50	12858.160.001	M27	25	12858.270.001
M8	250	12858.080.001	M18	25	12858.180.001	M30	25	12858.300.001
M10	200	12858.100.001	M20	25	12858.200.001	M36	10	12858.360.001
M12	100	12858.120.001	M22	25	12858.220.001			

12858 STOVER Nakrętki sześciokątne samozabezpieczające, całe ze stali

Cechy szczególne nakrętek sześciokątnych samozabezpieczających STOVER:

- Jednoczęściowa nakrętka w całości z metalu, klasy I8I, zgodn. z DIN 980 V.
- Blokowanie jest osiągnięte przez deformację promieniową części nakrętki. Najpierw nakrętka swobodnie obraca się na śrubie do momentu dojścia do elementu blokującego, po czym siła blokująca rośnie stopniowo do poziomu maksymalnego. To progresywne działanie blokujące rozpraszające nacisk na dużej powierzchni zapobiega uszkodzeniu gwintu.
- Odporność na wstrząsy, wibracje i obciążenia dynamiczne.
- Wielokrotnego użytku.

12880 STOVER Nakrętki sześciokątne samozabezpieczające, całe ze stali
F01J

Gwint Metryczny
Materiał Stal
Klasa 8
Obróbka powierzchni Ocynkowane, po żółtej pasywacji

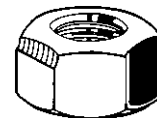

d	☒	Kod artykułu	d	☒	Kod artykułu	d	☒	Kod artykułu
M6	4000	12880.060.001	M10	750	12880.100.001	M14	250	12880.140.001
M8	2000	12880.080.001	M12	500	12880.120.001	M16	100	12880.160.001

Cechy szczególne nakrętek sześciokątnych samozabezpieczających STOVER:

- Jednoczęściowa nakrętka w całości z metalu, klasy I8I, zgodn. z DIN 980 V.
- Blokowanie jest osiągnięte przez deformację promieniową części nakrętki. Najpierw nakrętka swobodnie obraca się na śrubie do momentu dojścia do elementu blokującego, po czym siła blokująca rośnie stopniowo do poziomu maksymalnego.
- To progresywne działanie blokujące rozpraszające nacisk na dużej powierzchni zapobiega uszkodzeniu gwintu.
- Odporność na wstrząsy, wibracje i obciążenia dynamiczne.
- Wielokrotnego użytku.

12910 Nakrętki sześciokątne samozabezpieczające, całe ze stali, metryczne
F01J

Gwint Metryczny
Materiał Stal
Klasa 10
Obróbka powierzchni Ocynkowane

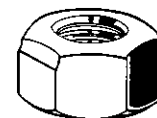

d	☒	Kod artykułu	d	☒	Kod artykułu	d	☒	Kod artykułu
M6	250	12910.060.001	M14	100	12910.140.001	M22	50	12910.220.001
M8	250	12910.080.001	M16	50	12910.160.001	M24	50	12910.240.001
M10	200	12910.100.001	M18	50	12910.180.001	M30	25	12910.300.001
M12	100	12910.120.001	M20	50	12910.200.001			

Cechy szczególne nakrętek sześciokątnych samozabezpieczających:

- Jednoczęściowa nakrętka w całości z metalu, klasy 10, zgodn. z DIN 980 V.
- Blokowanie jest osiągnięte przez deformację promieniową części nakrętki. Najpierw nakrętka swobodnie obraca się na śrubie do momentu dojścia do elementu blokującego, po czym siła blokująca rośnie stopniowo do poziomu maksymalnego.
- To progresywne działanie blokujące rozpraszające nacisk na dużej powierzchni zapobiega uszkodzeniu gwintu.
- Odporność na wstrząsy, wibracje i obciążenia dynamiczne.
- Wielokrotnego użytku.

Nakrętki sześciokątne samozabezpieczające, całe ze stali, metryczne drobnozwojne

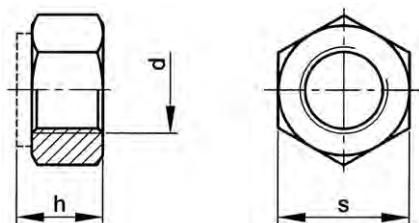

DIN 980V(1987)
ISO 10513
NEN 2452
NF E25-410

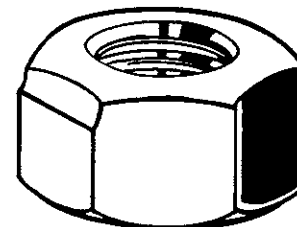

Informacje techniczne

d	h (max.)	s	d	h (max.)	s
M8	8	13	M16	16	24
M10	10	17	M18	18	27
M12	12	19	M20	20	30
M14	14	22	M24	24	36

3

12912 Nakrętki sześciokątne samozabezpieczające, całe ze stali, metryczne drobnozwojne

F01J

Gwint Metryczny drobnozwojny
Materiał Stal
Klasa |8|
Obróbka powierzchni Ocynkowane



d x P	✉	Kod artykułu	d x P	✉	Kod artykułu	d x P	✉	Kod artykułu
M8X1,00	250	12912.080.100	M12X1,50	200	12912.120.150	M20X1,50	50	12912.200.150
M10X1,00	250	12912.100.100	M14X1,50	200	12912.140.150	M24X1,50	50	12912.240.150
M10X1,25	250	12912.100.125	M16X1,50	100	12912.160.150	M24X2,00	50	12912.240.200
M12X1,25	200	12912.120.125	M18X1,50	100	12912.180.150			

- Cechy szczególne nakrętek sześciokątnych samozabezpieczających:
- Jednoczęściowa nakrętka w całości z metalu, klasy |8|, zgodn. z DIN 980 V.
- Blokowanie jest osiągane przez deformację promieniową części nakrętki. Najpierw nakrętka swobodnie obraca się na śrubie do momentu dojścia do elementu blokującego, po czym siła blokująca rośnie stopniowo do poziomu maksymalnego. To progresywne działanie blokujące rozpraszające nacisk na dużej powierzchni zapobiega uszkodzeniu gwintu.
- Odporność na wstrząsy, wibracje i obciążenia dynamiczne.
- Wielokrotnego użytku.

Nakrętki zabezpieczające sześciokątne stożkowe, allmetal Toplock, IFI-100/107

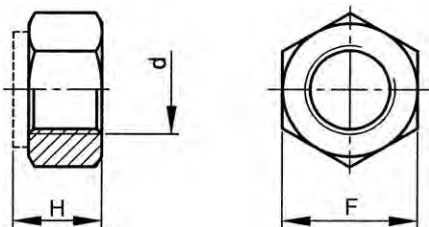

IFI 100/107

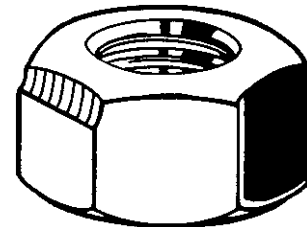

3

Informacje techniczne

d	F	H	Zwoje gwintu na cal
No.8	11/32	0.171	32
1/4	7/16	0.288	20
5/16	1/2	0.336	18
3/8	9/16	0.415	16
7/16	11/16	0.463	14
1/2	3/4	0.573	13
9/16	7/8	0.621	12
5/8	15/16	0.731	11
3/4	1.1/8	0.827	10
7/8	1.5/16	0.922	9
1 Inch	1.1/2	1.018	8
1.1/8	1.11/16	1.176	7
1.1/4	1.7/8	1.272	7
1.1/2	2.1/4	1.526	6

Grupy katalogowe

Gwint	Gniazdo	Materiał	Klasa	Obróbka powierzchni	Kod	Strona
UNC	Sześciokąt	St	Grade 8	Ocynk.	U12910	3-68
UNC	Sześciokąt	St	Grade 8	Ocynk. żłt. pas.	U12920	3-68
UNC	Sześciokąt	St.St. A2 (AISI304/18-8)			U51915	3-69
UNC	Sześciokąt	St.St. A4 (AISI316/18-10)			U55915	3-69

U12910 Nakrętki zabezpieczające allmetal Toplock (IFI-100/107)

X01A

Gwint	Całowy, zunifikowany grubozwojny (UNC)
Materiał	Stal
Klasa	Grade 8
Obróbka powierzchni	Ocynkowane

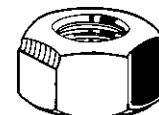

d	☒	Kod artykułu	d	☒	Kod artykułu	d	☒	Kod artykułu
1/4-20*	100	U12910.025.0001	9/16-12*	25	U12910.056.0001	1.-8*	5	U12910.100.0001
5/16-18*	100	U12910.031.0001	5/8-11*	10	U12910.062.0001	1.1/8-7*	5	U12910.112.0001
3/8-16*	50	U12910.037.0001	3/4-10*	10	U12910.075.0001	1.1/4-7*	5	U12910.125.0001
7/16-14*	25	U12910.043.0001	7/8-9*	5	U12910.087.0001	1.1/2-6*	5	U12910.150.0001
1/2-13*	25	U12910.050.0001						

U12920 Nakrętki zabezpieczające allmetal Toplock (IFI-100/107)

X01A

Gwint	Całowy, zunifikowany grubozwojny (UNC)
Materiał	Stal
Klasa	Grade 8
Obróbka powierzchni	Ocynkowane, po żółtej pasywacji

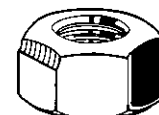

d	☒	Kod artykułu	d	☒	Kod artykułu	d	☒	Kod artykułu
1/4-20*	100	U12920.025.0001	1/2-13*	25	U12920.050.0001	1.-8*	5	U12920.100.0001
5/16-18*	100	U12920.031.0001	5/8-11*	10	U12920.062.0001	1.1/8-7*	5	U12920.112.0001
3/8-16*	50	U12920.037.0001	3/4-10*	10	U12920.075.0001	1.1/4-7*	5	U12920.125.0001
7/16-14*	25	U12920.043.0001	7/8-9*	5	U12920.087.0001	1.1/2-6*	5	U12920.150.0001

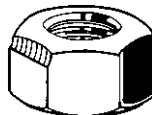
U51915	Nakrętki zabezpieczające allmetal Toplock (IFI-100/107)			X15A
Gwint	Całowy, zunifikowany grubozwojny (UNC)			 
Materiał	Stal nierdzewna A2 (AISI 304/18-8)			

d	☒	Kod artykułu	d	☒	Kod artykułu	d	☒	Kod artykułu
NO 8-32	50	U51915.016.0001	7/16-14*	25	U51915.043.0001	3/4-10*	5	U51915.075.0001
1/4-20*	50	U51915.025.0001	1/2-13*	10	U51915.050.0001	7/8-9*	5	U51915.087.0001
5/16-18*	50	U51915.031.0001	9/16-12*	10	U51915.056.0001	1.-8*	5	U51915.100.0001
3/8-16*	50	U51915.037.0001	5/8-11*	10	U51915.062.0001			

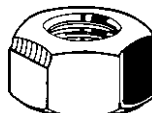
U55915	Nakrętki zabezpieczające allmetal Toplock (IFI-100/107)			X15A
Gwint	Całowy, zunifikowany grubozwojny (UNC)			 
Materiał	Stal nierdzewna A4 (AISI 316/18-10)			

d	☒	Kod artykułu	d	☒	Kod artykułu	d	☒	Kod artykułu
1/4-20*	50	U55915.025.0001	1/2-13*	10	U55915.050.0001	3/4-10*	5	U55915.075.0001
5/16-18*	50	U55915.031.0001	9/16-12*	10	U55915.056.0001	7/8-9*	5	U55915.087.0001
3/8-16*	50	U55915.037.0001	5/8-11*	10	U55915.062.0001	1.-8*	5	U55915.100.0001
7/16-14*	25	U55915.043.0001						

Nakrętki zabezpieczające sześciokątne stożkowe, allmetal Toplock, UNF, IFI-100/107

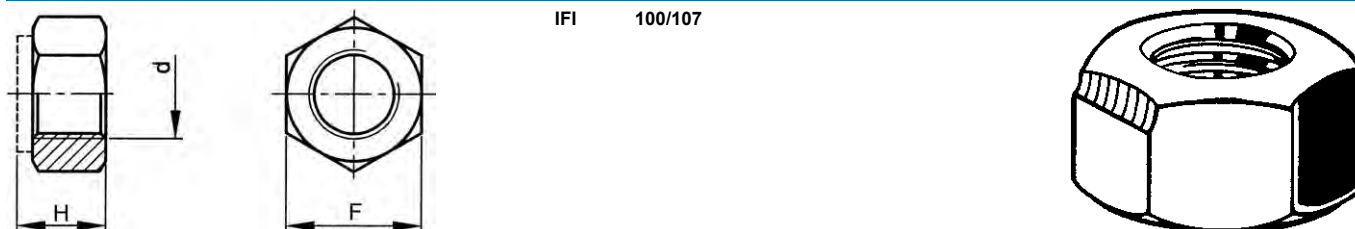

Informacje techniczne			
d	F	H	Zwoje gwintu na cal
No.10	3/8	0.241	32
1/4	7/16	0.288	28
5/16	1/2	0.336	24
3/8	9/16	0.415	24
7/16	11/16	0.463	20
1/2	3/4	0.573	20
9/16	7/8	0.621	18
5/8	15/16	0.731	18
3/4	1.1/8	0.827	16
7/8	1.5/16	0.922	14
1 Inch	1.1/2	1.018	14
1.1/8	1.11/16	1.176	12
1.1/4	1.7/8	1.272	12
1.1/2	2.1/4	1.526	12

Grupy katalogowe						
Gwint	Gniazdo	Materiał	Klasa	Obróbka powierzchni	Kod	Strona
UNF	Sześciokąt	St	Grade 8	Ocynk.	U12950	3-70
UNF	Sześciokąt	St	Grade 8	Ocynk. żłt. pas.	U12960	3-70
UNF	Sześciokąt	St.St. A2 (AISI304/18-8)			U51960	3-70

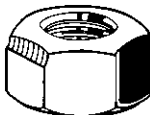
U12950	Nakrętki zabezpieczające sześciokątne stożkowe, allmetal Toplock (IFI-100/107)	X01A
Gwint	Całowy, zunifikowany drobnozwojny (UNF)	 
Materiał	Stal	
Klasa	Grade 8	
Obróbka powierzchni	Ocynkowane	

d	☒	Kod artykułu	d	☒	Kod artykułu	d	☒	Kod artykułu
1/4-28*	100	U12950.025.0002	9/16-18*	25	U12950.056.0002	1.-14*	5	U12950.101.0002
5/16-24*	100	U12950.031.0002	5/8-18*	10	U12950.062.0002	1.1/8-12*	5	U12950.112.0002
3/8-24*	50	U12950.037.0002	3/4-16*	10	U12950.075.0002	1.1/4-12*	5	U12950.125.0002
7/16-20*	25	U12950.043.0002	7/8-14*	5	U12950.087.0002	1.1/2-12*	5	U12950.150.0002
1/2-20*	25	U12950.050.0002						

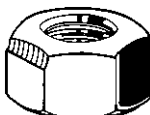
U12960	Nakrętki zabezpieczające sześciokątne stożkowe, allmetal Toplock (IFI-100/107)	X01A
Gwint	Całowy, zunifikowany drobnozwojny (UNF)	 
Materiał	Stal	
Klasa	Grade 8	
Obróbka powierzchni	Ocynkowane, po żółtej pasywacji	

d	☒	Kod artykułu	d	☒	Kod artykułu	d	☒	Kod artykułu
1/4-28*	100	U12960.025.0002	1/2-20*	25	U12960.050.0002	3/4-16*	10	U12960.075.0002
5/16-24*	100	U12960.031.0002	9/16-18*	25	U12960.056.0002	7/8-14*	5	U12960.087.0002
3/8-24*	50	U12960.037.0002	5/8-18*	10	U12960.062.0002	1.-14*	5	U12960.101.0002

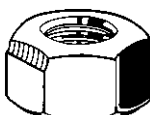
U51960	Nakrętki zabezpieczające sześciokątne stożkowe, allmetal Toplock (IFI-100/107)	X15A
Gwint	Całowy, zunifikowany drobnozwojny (UNF)	 
Materiał	Stal nierdzewna A2 (AISI 304/18-8)	

d	☒	Kod artykułu	d	☒	Kod artykułu	d	☒	Kod artykułu
NO.10-32*	50	U51960.019.0002	3/8-24*	50	U51960.037.0002	5/8-18*	10	U51960.062.0002
1/4-28*	50	U51960.025.0002	7/16-20*	25	U51960.043.0002	3/4-16*	5	U51960.075.0002
5/16-24*	50	U51960.031.0002	1/2-20*	10	U51960.050.0002			

Nakrętki sześciokątne samozabezpieczające, całe ze stali, typ H100-ESN

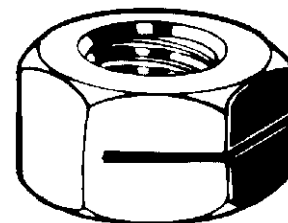
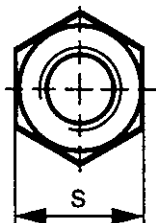
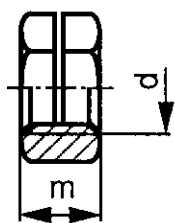

Informacje techniczne

d	m	P	s	d	m	P	s
M4	4	0.7	7	M14	14	2	21
M5	5	0.8	8	M16	16	2	24
M6	6	1	10	M18	18	2.5	27
M7	7	1	11	M20	20	2.5	30
M8	8	1.25	13	M22	22	2.5	34
M10	10	1.5	16	M24	24	3	36
M12	12	1.75	18	M27	27	3	41

- Te nakrętki sześciokątne samozabezpieczające SNEP należy stosować w połączeniu ze śrubami z klasą właściwości ≤ 6.8.

Grupy katalogowe

Gwint	Gniazdo	Materiał	Obróbka powierzchni	Kod	Strona
M	Sześciokąt	St	Ocynk.	13100	3-71
M	Sześciokąt	St.St. A1/A2		51710	3-71
M	Sześciokąt	Al P60	Anod.	45300	3-72

13100 SNEP Nakrętki sześciokątne samozabezpieczające, całe z metalu, typ H100-ESN

F01E

Gwint: Metryczny
 Materiał: Stal
 Obróbka powierzchni: Ocynkowane



d	☒	Kod artykułu	d	☒	Kod artykułu	d	☒	Kod artykułu
M4	250	13100.040.001	M10	200	13100.100.001	M20	25	13100.200.001
M5	250	13100.050.001	M12	100	13100.120.001	M22	25	13100.220.001
M6	250	13100.060.001	M14	100	13100.140.001	M24	25	13100.240.001
M7	250	13100.070.001	M16	50	13100.160.001	M27	10	13100.270.001
M8	250	13100.080.001	M18	50	13100.180.001			

Cechy szczególne nakrętek sześciokątnych samozabezpieczających SNEP:

- To jednoczęściowa nakrętka, cała z metalu.
- Blokowanie jest osiągnięte przez elastyczne, osiowe przesunięcie częściowo oddzielonych i ściśniętych części nakrętki w stosunku do siebie. Najpierw nakrętka swobodnie obraca się na śrubie do momentu osiągnięcia rowka, zaciśnięcie się na gwincie jest uzyskiwane przez elastyczną reakcję materiału niezależną od momentu obrotowego.
- Cynkowana z grubością warstwy około 7 µm.
- Odporność na wstrząsy, wibracje i obciążenia dynamiczne.
- Wielokrotnego użytku.
- Odporność na temperatury od -100°C do + 260°C.

51710 SNEP Nakrętki sześciokątne samozabezpieczające, całe ze stali nierdzewnej A1, typ H100-ESN

R09A

Gwint: Metryczny
 Materiał: Stal nierdzewna A1/A2



d	☒	Kod artykułu	d	☒	Kod artykułu	d	☒	Kod artykułu
M4	100	51710.040.001	M8	50	51710.080.001	M12	25	51710.120.001
M5	100	51710.050.001	M10	50	51710.100.001	M16	10	51710.160.001
M6	100	51710.060.001						

Cechy szczególne nakrętek sześciokątnych samozabezpieczających SNEP:

- To jednoczęściowa nakrętka, cała z metalu.
- Blokowanie jest osiągnięte przez elastyczne, osiowe przesunięcie częściowo oddzielonych i ściśniętych części nakrętki w stosunku do siebie. Najpierw nakrętka swobodnie obraca się na śrubie do momentu osiągnięcia rowka, zaciśnięcie się na gwincie jest uzyskiwane przez elastyczną reakcję materiału niezależną od momentu obrotowego.
- Odporność na wstrząsy, wibracje i obciążenia dynamiczne.
- Wielokrotnego użytku.
- Odporność na temperatury od -100°C do + 260°C.
- Nakrętki sześciokątne samozabezpieczające SNEP ze stali nierdzewnej są dostarczane ze specjalnym smarem zapobiegającym zakleszczaniu się.
- W zależności od dostępności może zostać dostarczona stal A1, jak również stal A2.

45300	SNEP Nakrętki sześciokątne samozabezpieczające, całe z aluminium, typ H100-ESN		W01A
Gwint	Metryczny		
Materiał	Aluminium P60		
Obróbka powierzchni	Anodyzowane		

d	☒	Kod artykułu	d	☒	Kod artykułu	d	☒	Kod artykułu
M8	200	45300.080.001	M12	100	45300.120.001	M16	50	45300.160.001
M10	100	45300.100.001						

3

- Bezbarwne anodyzowane.

Nakrętki sześciokątne samozabezpieczające, całe ze stali, typ H130-ESN

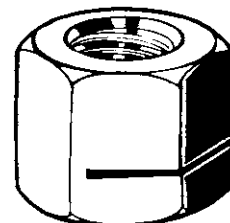
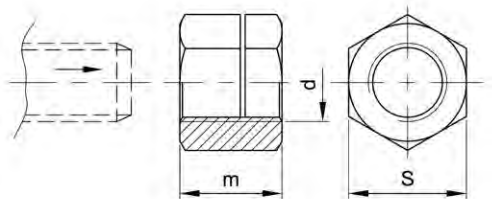

Informacje techniczne

d	m	P	s	d	m	P	s
M4	5.2	0.7	7	M12	15.6	1.75	18
M5	6.5	0.8	8	M14	18.2	2	21
M6	7.8	1	10	M16	20.8	2	24
M7	9.1	1	11	M18	23.4	2.5	27
M8	10.4	1.25	13	M20	26	2.5	30
M10	13	1.5	16	M24	31.2	3	36

13200	SNEP Nakrętki sześciokątne samozabezpieczające, całe ze stali, typ H130-ESN		F01E
Gwint	Metryczny		
Materiał	Stal		
Obróbka powierzchni	O cynkowane		



d	☒	Kod artykułu	d	☒	Kod artykułu	d	☒	Kod artykułu
M4	250	13200.040.001	M8	250	13200.080.001	M16	50	13200.160.001
M5	250	13200.050.001	M10	200	13200.100.001	M18	50	13200.180.001
M6	250	13200.060.001	M12	100	13200.120.001	M20	25	13200.200.001
M7	250	13200.070.001	M14	100	13200.140.001	M24	25	13200.240.001

- Te nakrętki sześciokątne samozabezpieczające SNEP należy stosować w połączeniu ze śrubami z klasą właściwości ≤ 8.8 .

Nakrętki sześciokątne samozabezpieczające, całe ze stali, typ USN

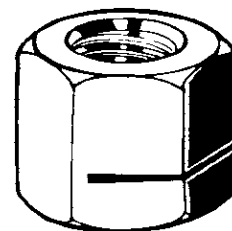
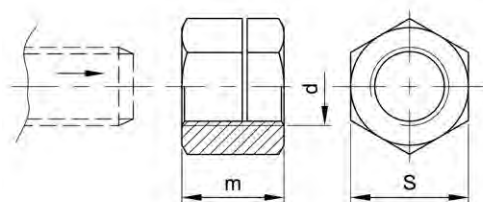

Informacje techniczne

d	m	P	s	d	m	P	s
M30	30	3.5	46	M39	39	4	60
M33	33	3.5	50	M42	42	4.5	65
M36	36	4	55	M45	45	4.5	70

13190 SNEP Nakrętki sześciokątne samozabezpieczające, całe ze stali, typ USN

F01E

Gwint Metryczny
 Materiał Stal
 Obróbka powierzchni Ocynkowane

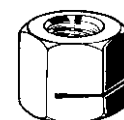

d	Kod artykułu	d	Kod artykułu	d	Kod artykułu
M30	10 13190.300.001	M36	5 13190.360.001	M42	5 13190.420.001
M33	10 13190.330.001	M39	5 13190.390.001	M45	4 13190.450.001

- Te nakrętki sześciokątne samozabezpieczające SNEP należy stosować w połączeniu ze śrubami z klasą właściwości ≤ 6.8 .
- Na życzenie dostępne są nakrętki sześciokątne samozabezpieczające SNEP typu USN, aż do rozmiaru M80 włącznie.

Nakrętki sześciokątne samozabezpieczające z kołnierzem stożkowym

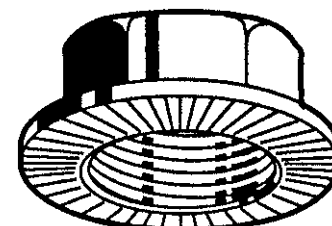
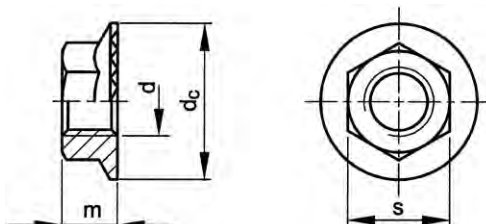

Informacje techniczne

d	d _c	m	P	s	d	d _c	m	P	s
M5	11.2	4.3	0.8	8	M10	21	8.5	1.5	15
M6	14.2	5.5	1	10	M12	24	10	1.75	17
M8	18.2	7	1.25	13	M16	31	14	2	22

Specjalne właściwości śrub samozabezpieczających z łbem sześciokątnym z kołnierzem stożkowym RIPP:

- ząbkowany (wielorowkowy) kołnierz zapobiega uszkodzeniom podczas montażu, zapobiega samopoluzowaniu i zmniejsza relaksację (rozluźnienie),
- kołnierz pozwala na rozproszczenie nagromadzonych sił na większym obszarze, tym samym zmniejszając nacisk na powierzchnię,
- kołnierz może zakryć duże (nadwymiarowe) otwory i/lub otwory narzędziowe,
- podkładka i/lub element blokujący nie jest konieczny.

MONTAŻ Z OBCIĄŻENIEM WSTĘPNYM F_m w kN, a MOMENT SKRĘCAJĄCY M_a w Nm

Klasa	Dopasowanie materiału	M5		M6		M8		M10		M12		M16	
		FM	MA	FM	MA	FM	MA	FM	MA	FM	MA	FM	MA
10	Stal (R _m < 800 N/mm ²)	9	11	12,6	19	23,2	42	37	85	54	130	102	330
	Stal (R _m ≥ 800 N/mm ²)	9	10	12,6	18	23,2	37	37	80	54	120	102	310
	Stal zgrzewna/ zeliwo ciągliwe	9	9	12,6	16	23,2	35	37	75	54	115	102	300

Grupy katalogowe

Gwint	Gniazdo	Materiał	Klasa	Obróbka powierzchni	Kod	Strona
M	Sześciokąt	St	10		12470	3-74
M	Sześciokąt	St	10	Ocynk.	12471	3-74
M	Sześciokąt	St	10	FLZNNC-NC6	12474	3-74

12470 RIPP Nakrętki sześciokątne samozabezpieczające z kołnierzem stożkowym F92A								
Gwint	Metryczny							
Materiał	Stal							
Klasa	10							
d	☒	Kod artykułu	d	☒	Kod artykułu	d	☒	Kod artykułu
M5	500	12470.050.001	M8	200	12470.080.001	M12	200	12470.120.001
M6	500	12470.060.001	M10	200	12470.100.001	M16	100	12470.160.001

12471 RIPP Nakrętki sześciokątne samozabezpieczające z kołnierzem stożkowym F92A								
Gwint	Metryczny							
Materiał	Stal							
Klasa	10							
Obróbka powierzchni	Ocynkowane							
d	☒	Kod artykułu	d	☒	Kod artykułu	d	☒	Kod artykułu
M5	500	12471.050.001	M8	200	12471.080.001	M12	200	12471.120.001
M6	500	12471.060.001	M10	200	12471.100.001	M16	100	12471.160.001

12474 RIPP Nakrętki sześciokątne samozabezpieczające z kołnierzem stożkowym F92A								
Gwint	Metryczny							
Materiał	Stal							
Klasa	10							
Obróbka powierzchni	Ocynk płatkowy bez Cr6+ wg ISO 10683 (flZnnc)							
d	☒	Kod artykułu	d	☒	Kod artykułu	d	☒	Kod artykułu
M5	250	12474.050.001	M8	200	12474.080.001	M12	200	12474.120.001
M6	250	12474.060.001	M10	200	12474.100.001	M16	100	12474.160.001

Nakrętki sześciokątne samozabezpieczające, całe z metalu



Informacje techniczne

d	d ₁	h	P	s	d	d ₁	h	P	s
M6	12	7.5	1	10	M10	20.4	12.5	1.5	17
M8	16.8	10	1.25	14	M12	25	15	1.75	21

Specjalne właściwości nakrętek sześciokątnych samozabezpieczających SECURIT:

- dwuczęściowa, całkowicie metalowa nakrętka, składająca się z wewnętrznego stożka, który jest nagwintowany i rowkowany na całej wysokości, i stożka zewnętrznego (sześciokątnego z imakiem na kołnierzu na górze), które są połączone ze sobą. Podczas działania momentu obrotowego stożek wewnętrzny zostaje zaciśnięty na całym obwodzie gwintu ze wzrastającą siłą,
- możliwość ponownego użycia,
- odporne na temperaturę do +350°C.

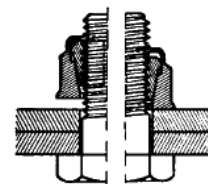

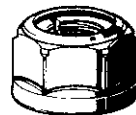
13000	SECURITY Nakrętka sześciokątna samozabezpieczająca, całe z metalu					F93A
Gwint	Metryczny					
Materiał	Stal					
Klasa	6					
Obróbka powierzchni	Ocynkowane, po żółtej pasywacji					

d	☒	Kod artykułu	d	☒	Kod artykułu	d	☒	Kod artykułu
M6	50	13000.060.001	M10	25	13000.100.001	M12	10	13000.120.001
M8	25	13000.080.001						

Nakrętka sześciokątna samozabezpieczająca



Informacje techniczne

d	d _c	m	P	s	d	d _c	m	P	s
M5	11.2	4.3	0.8	8	M10	21	7.9	1.5	15
M6	14.25	5.5	1	10	M12	24	8.7	1.75	17
M8	18.25	7	1.25	13	M16	31	11.2	2	22

- Klasa 8 będzie stosowana z klasą właściwości 8.8 i 90, a klasa 10 z klasą właściwości 10.9 i 100.

Specjalne właściwości nakrętek sześciokątnych samozabezpieczających:

- sprężysty, ząbkowany brzeg kołnierza, daje doskonałe własności samozabezpieczające,
- wewnątrz sprężystego brzegu kołnierza nadaje optymalne obciążenie wstępne konstrukcji,
- podkładka i/lub element blokujący nie jest konieczny a nawet niewskazany,

MONTAŻ Z OBCIĄŻENIEM WSTĘPNYM F_m w kN, i MOMENT SKRĘCAJĄCY M_a w Nm

Klasa	Dopasowanie materiału	M5		M6		M8		M10		M12		M16	
		FM	MA	FM	MA	FM	MA	FM	MA	FM	MA	FM	MA
8	Stal	6,35	9	9	16	16,5	34	26,2	58	--	--	--	--
	Stal zgrzewna/ żeliwo ciągliwe	6,35	7	9	13	16,5	28	26,2	49	--	--	--	--
10	Stal	--	--	--	--	--	--	--	--	54	120	102	280
	Stal zgrzewna/ żeliwo ciągliwe	--	--	--	--	--	--	--	--	54	105	102	260

Grupy katalogowe

Gwint	Gniazdo	Materiał	Klasa	Obróbka powierzchni	Kod	Strona
M	Sześciokąt	St	8/10		01150	3-75
M	Sześciokąt	St	8/10	Ocynk.	01149	3-76
M	Sześciokąt	St	8/10	FLZNNC-NC6	01155	3-76

01150	Nakrętka sześciokątna samozabezpieczająca					F92A
Gwint	Metryczny					
Materiał	Stal					
Klasa	8/10					

d	☒	Kod artykułu	d	☒	Kod artykułu	d	☒	Kod artykułu
M5 - CL.8	500	01150.050.001	M8 - CL.8	200	01150.080.001	M12 - CL.10	200	01150.120.001
M6 - CL.8	500	01150.060.001	M10 - CL.10	200	01150.100.001	M16 - CL.10	100	01150.160.001

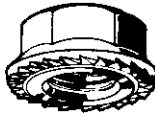

01149 Nakrętka sześciokątna samozabezpieczająca		F92A	
Gwint	Metryczny		
Materiał	Stal		
Klasa	8/10		
Obróbka powierzchni	Ocynkowane		
			
d	☒ Kod artykułu	d	☒ Kod artykułu
M6 - CL.8	500 01149.060.001	M10 - CL.8	200 01149.100.001
M8 - CL.8	200 01149.080.001	M12 - CL.10	200 01149.120.001
		M16 - CL.10	100 01149.160.001

3

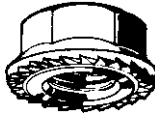
01155 Nakrętka sześciokątna samozabezpieczająca		F92A	
Gwint	Metryczny		
Materiał	Stal		
Klasa	8/10		
Obróbka powierzchni	Ocynk płatkowy bez Cr6+ wg ISO 10683 (flZnnc)		
			
d	☒ Kod artykułu	d	☒ Kod artykułu
M6	500 01155.060.001	M10	200 01155.100.001
M8	200 01155.080.001	M12	200 01155.120.001
		M16	100 01155.160.001

Nakrętki sześciokątne z kołnierzem stożkowym

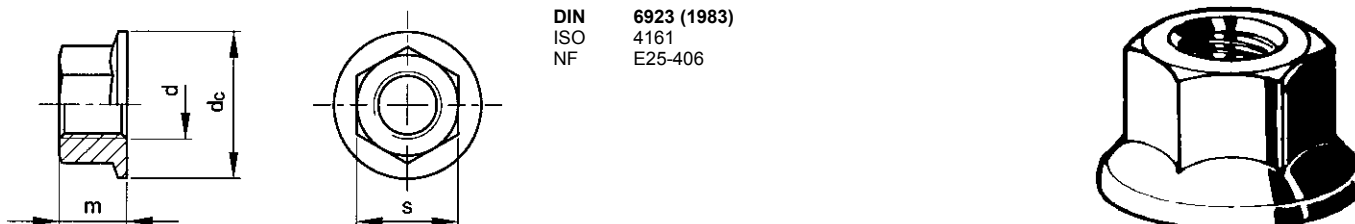

DIN 6923 (1983)
ISO 4161
NF E25-406

Informacje techniczne

d	d _c (maks.)	m (maks.)	P	s
M4 (#DIN)	9.8	4.5	0.7	7
M5	11.8	5	0.8	8
M6	14.2	6	1	10
M8	17.9	8	1.25	13
M10	21.8	10	1.5	15
M12	26	12	1.75	18
M14	29.9	14	2	21
M16	34.5	16	2	24
M20	42.8	20	2.5	30
M24 (#DIN)	51	24	3	36

- Specjalne cechy nakrętek sześciokątnych z kołnierzem stożkowym:
- Kołnierz pozwala na rozłożenie przenoszonych obciążeń na większym obszarze, zmniejszając nacisk na powierzchnię.
- Kołnierz może przykryć duże (nadwymiarowe) otwory i/lub otwory narzędziowe.
- Nie jest potrzebna podkładka.

Grupy katalogowe

Gwint	Gniazdo	Materiał	Klasa	Obróbka powierzchni	Kod	Strona
M	Sześciokąt	St	8	Ocynk.	11590	3-77
M	Sześciokąt	St	8	Ocynk. żłt. pas.	11595	3-77
M	Sześciokąt	St	10	Ocynk.	11598	3-77
M	Sześciokąt	St.St. A2	70		51108	3-77
M	Sześciokąt	St.St. A4	70		55108	3-77

11590 Nakrętki sześciokątne z kołnierzem stożkowym		F01X
Gwint	Metryczny	
Materiał	Stal	
Klasa	8	
Obróbka powierzchni	Ocynkowane	

d	☒	Kod artykułu	d	☒	Kod artykułu	d	☒	Kod artykułu
M4	250	11590.040.001	M10	100	11590.100.001	M16	50	11590.160.001
M5	250	11590.050.001	M12	100	11590.120.001	M20	50	11590.200.001
M6	250	11590.060.001	M14	50	11590.140.001	M24	25	11590.240.001
M8	250	11590.080.001						

11595 Nakrętki sześciokątne z kołnierzem stożkowym		F01X
Gwint	Metryczny	
Materiał	Stal	
Klasa	8	
Obróbka powierzchni	Ocynkowane, po żółtej pasywacji	

d	☒	Kod artykułu	d	☒	Kod artykułu	d	☒	Kod artykułu
M5	250	11595.050.001	M10	100	11595.100.001	M14	50	11595.140.001
M6	250	11595.060.001	M12	100	11595.120.001	M16	50	11595.160.001
M8	250	11595.080.001						

11598 Nakrętki sześciokątne z kołnierzem stożkowym		F01X
Gwint	Metryczny	
Materiał	Stal	
Klasa	10	
Obróbka powierzchni	Ocynkowane	

d	☒	Kod artykułu	d	☒	Kod artykułu	d	☒	Kod artykułu
M5	250	11598.050.001	M10	100	11598.100.001	M16	50	11598.160.001
M6	250	11598.060.001	M12	100	11598.120.001	M20	50	11598.200.001
M8	250	11598.080.001	M14	50	11598.140.001	M24	25	11598.240.001

51108 Nakrętki sześciokątne z kołnierzem stożkowym		R09A
Gwint	Metryczny	
Materiał	Stal nierdzewna A2	
Klasa	70	

d	☒	Kod artykułu	d	☒	Kod artykułu	d	☒	Kod artykułu
M4	100	51108.040.001	M6	250	51108.060.001	M10	100	51108.100.001
M5	250	51108.050.001	M8	250	51108.080.001	M12	100	51108.120.001

55108 Nakrętki sześciokątne z kołnierzem stożkowym		R49A
Gwint	Metryczny	
Materiał	Stal nierdzewna A4	
Klasa	70	

d	☒	Kod artykułu	d	☒	Kod artykułu	d	☒	Kod artykułu
M4*	500	55108.040.001	M6*	200	55108.060.001	M8*	100	55108.080.001
M5*	500	55108.050.001						

Nakrętki sześciokątne z ząbkowanym kołnierzem stożkowym

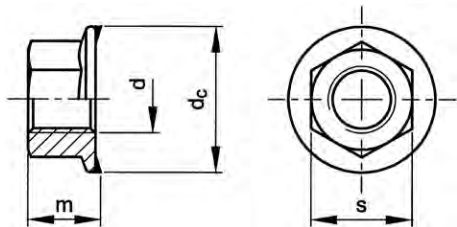

DIN ≈6923
ISO ≈4161
NF ≈E25-406

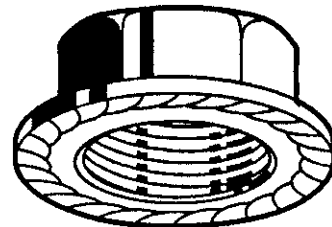

3

Informacje techniczne

d	d _c (maks.)	m (maks.)	P	s
M3	7.8	3.8	0.5	6
M4 (≠DIN)	9.6	4.5	0.7	7
M5	11.8	5	0.8	8
M6	14.2	6	1	10
M8	17.9	8	1.25	13
M10	21.8	10	1.5	15
M12	26	12	1.75	18
M14	29.9	14	2	21
M16	34.5	16	2	24

- Specjalne cechy nakrętek sześciokątnych z ząbkowanym kołnierzem stożkowym:
- Kołnierz pozwala na rozłożenie przenoszonych obciążeń na większym obszarze, zmniejszając nacisk na powierzchnię.
- Kołnierz może przykryć duże (nadwymiarowe) otwory i/lub otwory narzędziowe.
- Nie jest potrzebna podkładka.
- Ząbkowana krawędź kołnierza zapewnia doskonale właściwości samozabezpieczające.

Grupy katalogowe

Gwint	Gniazdo	Materiał	Klasa	Obróbka powierzchni	Kod	Strona
M	Sześciokąt	St	8		11609	3-78
M	Sześciokąt	St	8	Ocynk.	11610	3-78
M	Sześciokąt	St	8	Ocynk. żłt. pas.	11611	3-79
M	Sześciokąt	St.St. A2			51119	3-79
M	Sześciokąt	St.St. A4			55119	3-79

11609 Nakrętki sześciokątne z ząbkowanym kołnierzem stożkowym

F01X

Gwint Metryczny
Materiał Stal
Klasa 8



d	☒	Kod artykułu	d	☒	Kod artykułu	d	☒	Kod artykułu
M5	250	11609.050.001	M8	250	11609.080.001	M12	100	11609.120.001
M6	250	11609.060.001	M10	100	11609.100.001	M16	50	11609.160.001

11610 Nakrętki sześciokątne z ząbkowanym kołnierzem stożkowym

F01X



Gwint Metryczny
Materiał Stal
Klasa 8
Obróbka powierzchni Ocynkowane



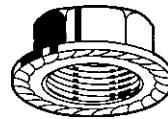

d	☒	Kod artykułu	d	☒	Kod artykułu	d	☒	Kod artykułu
M4	250	11610.040.001	M8	250	11610.080.001	M14	50	11610.140.001
M5	250	11610.050.001	M10	100	11610.100.001	M16	50	11610.160.001
M6	250	11610.060.001	M12	100	11610.120.001			

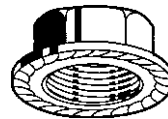
11611 Nakrętki sześciokątne z ząbkowanym kołnierzem stożkowym		F01X
Gwint	Metryczny	
Materiał	Stal	
Klasa	8	
Obróbka powierzchni	Ocynkowane, po żółtej pasywacji	

d	☒	Kod artykułu	d	☒	Kod artykułu	d	☒	Kod artykułu
M4	250	11611.040.001	M8	250	11611.080.001	M14	50	11611.140.001
M5	250	11611.050.001	M10	100	11611.100.001	M16	50	11611.160.001
M6	250	11611.060.001	M12	100	11611.120.001			

51119 Nakrętki sześciokątne z ząbkowanym kołnierzem stożkowym		R09A	
Gwint	Metryczny		
Materiał	Stal nierdzewna A2		
			

d	☒	Kod artykułu	d	☒	Kod artykułu	d	☒	Kod artykułu
M3	500	51119.030.001	M6	200	51119.060.001	M12*	100	51119.120.001
M4	500	51119.040.001	M8	100	51119.080.001	M16*	50	51119.160.001
M5	500	51119.050.001	M10	100	51119.100.001			

55119 Nakrętki sześciokątne z ząbkowanym kołnierzem stożkowym		R49A	
Gwint	Metryczny		
Materiał	Stal nierdzewna A4		
			

d	☒	Kod artykułu	d	☒	Kod artykułu	d	☒	Kod artykułu
M3*	500	55119.030.001	M6*	200	55119.060.001	M12*	100	55119.120.001
M4*	500	55119.040.001	M8*	100	55119.080.001	M16*	50	55119.160.001
M5*	500	55119.050.001	M10*	100	55119.100.001			

Nakrętki sześciokątne kołnierzowe kontrolujące

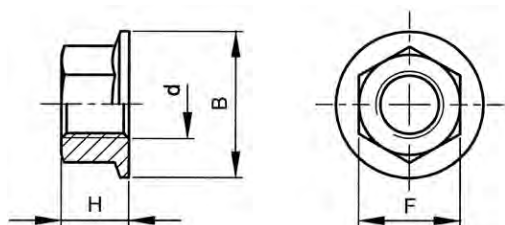

IFI 100/107

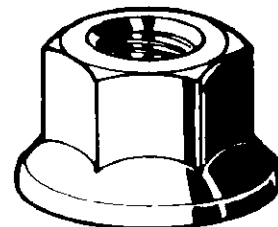

3

Informacje techniczne

d	B	F	H	Zwoje gwintu na cal
No.8	0.375	11/32	0.191	32
No.10	0.475	3/8	0.241	24
1/4	0.560	7/16	0.300	20
5/16	0.680	1/2	0.365	18
3/8	0.810	9/16	0.425	16
7/16	0.930	11/16	0.495	14
1/2	1.07	3/4	0.555	13
5/8	1.330	15/16	0.690	11
3/4	1.585	1.1/8	0.825	10
7/8	1.750	1.5/16	0.790	9
1 Inch	2.06	1.1/2	0.900	8

Grupy katalogowe

Gwint	Gniazdo	Materiał	Klasa	Obróbka powierzchni	Kod	Strona
UNC	Sześciokąt	St	Grade 2	Ocynk.	U12100	3-80
UNC	Sześciokąt	St	Grade 8	Ocynk.	U12120	3-80

U12100 Nakrętki kołnierzowe kontrolujące, allmetal (IFI-100/107)

X01A

Gwint	Całowy, zunifikowany grubozwojny (UNC)
Materiał	Stal
Klasa	Grade 2
Obróbka powierzchni	Ocynkowane

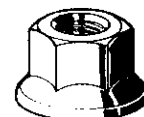

d	☒	Kod artykułu	d	☒	Kod artykułu	d	☒	Kod artykułu
NO.8-32*	100	U12100.016.0001	3/8-16*	50	U12100.037.0001	3/4-10*	10	U12100.075.0001
NO.10-24*	100	U12100.019.0001	7/16-14*	25	U12100.043.0001	7/8-9*	5	U12100.087.0001
1/4-20*	100	U12100.025.0001	1/2-13*	25	U12100.050.0001	1.-8*	5	U12100.100.0001
5/16-18*	100	U12100.031.0001	5/8-11*	10	U12100.062.0001			

U12120 Nakrętki kołnierzowe kontrolujące, allmetal (IFI-100/107)

X01A

Gwint	Całowy, zunifikowany grubozwojny (UNC)
Materiał	Stal
Klasa	Grade 8
Obróbka powierzchni	Ocynkowane

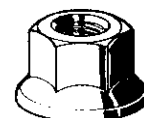

d	☒	Kod artykułu	d	☒	Kod artykułu	d	☒	Kod artykułu
1/4-20*	100	U12120.025.0001	7/16-14*	25	U12120.043.0001	3/4-10*	10	U12120.075.0001
5/16-18*	100	U12120.031.0001	1/2-13*	25	U12120.050.0001	7/8-9*	5	U12120.087.0001
3/8-16*	50	U12120.037.0001	5/8-11*	10	U12120.062.0001	1.-8*	5	U12120.100.0001

Nakrętki samozabezpieczające kołnierzowe z niemetaliczną wkładką

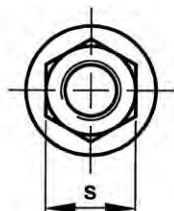
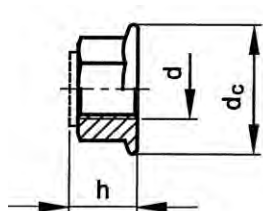

DIN 6926
ISO 7043

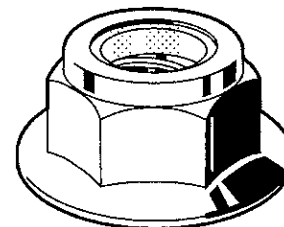

Informacje techniczne

d	d _c (maks.)	h (max.)	P	s
M4	10	4.65	0.7	7
M5	11.8	7.1	0.8	8
M6	14.2	9.1	1	10
M8	17.9	11.1	1.25	13
M10	21.8	13.5	1.5	15
M12	26	16.1	1.75	18
M16	34.5	20.3	2	24

Grupy katalogowe

Gwint	Gniazdo	Materiał	Klasa	Obróbka powierzchni	Kod	Strona
M	Sześciokąt	St	8	Ocynk.	12460	3-81
M	Sześciokąt	St.St. A2	70		51738	3-81
M	Sześciokąt	St.St. A4	70		55738	3-81

12460 Nakrętki samozabezpieczające kołnierzowe z niemetaliczną wkładką						F01X
Gwint	Metryczny					
Materiał	Stal					
Klasa	8					
Obróbka powierzchni	Ocynkowane					

d	✉	Kod artykułu	d	✉	Kod artykułu	d	✉	Kod artykułu
M5	250	12460.050.001	M8	250	12460.080.001	M12	100	12460.120.001
M6	250	12460.060.001	M10	200	12460.100.001	M16	50	12460.160.001

51738 Nakrętki samozabezpieczające kołnierzowe z niemetaliczną wkładką						R09A
Gwint	Metryczny					
Materiał	Stal nierdzewna A2					
Klasa	70					

d	✉	Kod artykułu	d	✉	Kod artykułu	d	✉	Kod artykułu
M4*	500	51738.040.001	M6*	500	51738.060.001	M10*	100	51738.100.001
M5*	500	51738.050.001	M8*	100	51738.080.001	M12*	100	51738.120.001

55738 Nakrętki samozabezpieczające kołnierzowe z niemetaliczną wkładką						R49A
Gwint	Metryczny					
Materiał	Stal nierdzewna A4					
Klasa	70					

d	✉	Kod artykułu	d	✉	Kod artykułu	d	✉	Kod artykułu
M4*	500	55738.040.001	M6*	500	55738.060.001	M10*	100	55738.100.001
M5*	500	55738.050.001	M8*	100	55738.080.001			

Nakrętki samozabezpieczające kołnierzowe z niemetaliczną wkładką, ząbkowane

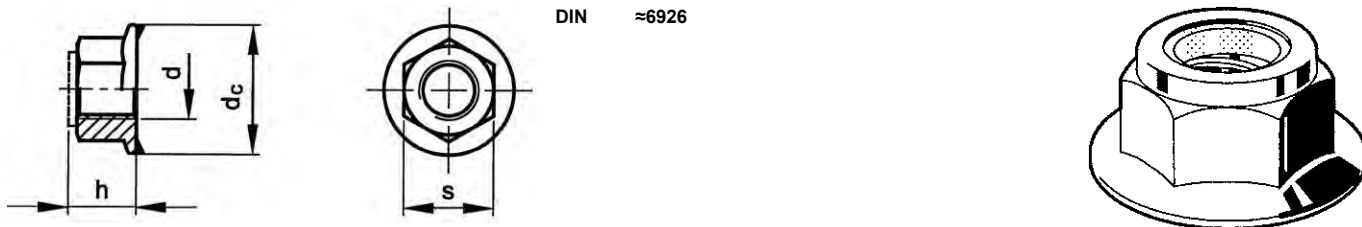

DIN ≈6926

3

Informacje techniczne

d	d _c (maks.)	h (maks.)	P	s
M4	10	4.65	0.7	7
M5	11.8	7.1	0.8	8
M6	14.2	9.1	1	10
M8	17.9	11.1	1.25	13
M10	21.8	13.5	1.5	15
M12	26	16.1	1.75	18

Grupy katalogowe

Gwint	Gniazdo	Materiał	Klasa	Kod	Strona
M	Sześciokąt	St.St. A2	50	51734	3-82
M	Sześciokąt	St.St. A4	50	55734	3-82

51734 Nakrętki samozabezpieczające kołnierzowe z niemetaliczną wkładką, ząbkowane					R09A
Gwint	Metryczny				
Materiał	Stal nierdzewna A2				
Klasa	50				

d	☒	Kod artykułu	d	☒	Kod artykułu	d	☒	Kod artykułu
M4*	500	51734.040.001	M6*	500	51734.060.001	M10*	100	51734.100.001
M5*	500	51734.050.001	M8*	100	51734.080.001	M12*	100	51734.120.001

55734 Nakrętki samozabezpieczające kołnierzowe z niemetaliczną wkładką, ząbkowane					R49A
Gwint	Metryczny				
Materiał	Stal nierdzewna A4				
Klasa	50				

d	☒	Kod artykułu	d	☒	Kod artykułu	d	☒	Kod artykułu
M4*	500	55734.040.001	M6*	100	55734.060.001	M10*	100	55734.100.001
M5*	500	55734.050.001	M8*	100	55734.080.001	M12*	100	55734.120.001

Nakrętki do kół

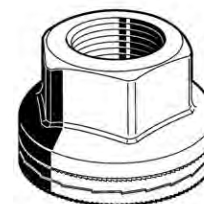
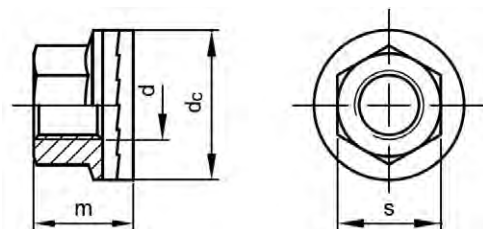

Informacje techniczne

d x P	d _c	m	Moment dokręcania w Nm	Obciążenie wstępne montażu kN	s
M22x1,5	46	27	600-650	≈ 200	32

3

12479 NORD-LOCK nakrętki do kół

NL2A

Gwint	Metryczny bardzo drobnoszwyjny
Materiał	Stal
Klasa	10
Obróbka powierzchni	Delta Protekt®

NORD-LOCK
Bolt securing system



d x P	✉ Kod artykułu
M22X1,5	20 12479.220.150

Nakrętki z podkładką stożkową

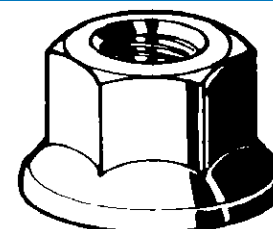
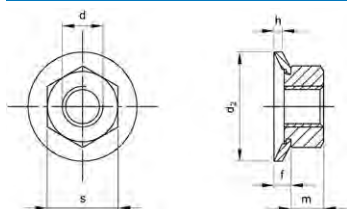

Informacje techniczne

d ₂	d ₂	f	h	m	P	s
M3	8	1	0.5	2.4	0.5	5.5
M4	10	1	0.6	3.2	0.7	5.5
M5	12	1.35	1.25	4	0.8	8
M6	18	1.7	1.5	5	1	10
M8	18	2.2	1.5	6.5	1.25	13
M10	22	1.6	1.7	8	1.5	17

51112 COMBY Nakrętki z podkładką stożkową

R09A

Gwint	Metryczny
Materiał	Stal nierdzewna A2

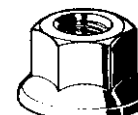

d	✉ Kod artykułu	d	✉ Kod artykułu	d	✉ Kod artykułu
M3*	1000 51112.030.008	M5*	500 51112.050.015	M8*	100 51112.080.018
M4*	1000 51112.040.010	M6*	500 51112.060.018	M10*	200 51112.100.022

Nakrętki sześciokątne samozabezpieczające z ząbkowaną podkładką zabezpieczającą przed wypadnięciem po rozłączeniu

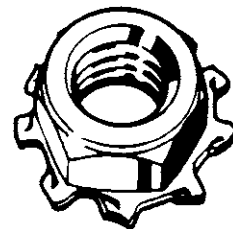
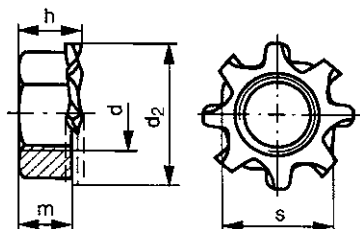

3

Informacje techniczne

d	d ₂	h	m	P	s
M3	6.6	3.1	2.4	0.5	5.5
M4	8	4	3.2	0.7	7
M5	9.2	5.1	4	0.8	8
M6	11.4	6.1	5	1	10
M8	14.9	7.9	6.5	1.25	13

11490 COMBY Nakrętki sześciokątne samozabezpieczające z ząbkowaną podkładką zabezpieczającą przed wypadnięciem po rozłączeniu F01X

Gwint Metryczny
 Materiał Stal
 Obróbka powierzchni Ocynkowane

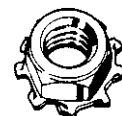

d	☒	Kod artykułu	d	☒	Kod artykułu	d	☒	Kod artykułu
M3	250	11490.030.001	M5	250	11490.050.001	M8	200	11490.080.001
M4	250	11490.040.001	M6	250	11490.060.001			

Nakrętki kontruujące samozabezpieczające

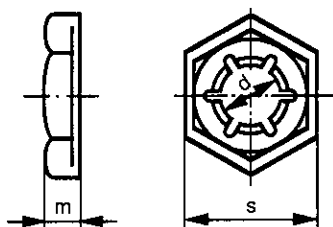

DIN 7967
 NF E27-460

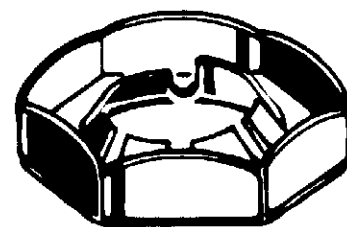

Informacje techniczne

d	m	P	s	d	m	P	s
M4	2.5	0.7	7	M18	5.5	2.5	27
M5	2.5	0.8	8	M20	6	2.5	30
M6	3	1	10	M22	6	2.5	32
M8	3.5	1.25	13	M24	7	3	36
M10	4	1.5	17	M27	7	3	41
M12	4.5	1.75	19	M30	8	3.5	46
M14	5	2	22	M36	9	4	55
M16	5	2	24	M42	11	4.5	65

Specjalne właściwości samozabezpieczających nakrętek kontruujących PAL:

- muszą być nałożone na gwint i na ile to możliwe dokręcone ciasno palcami, następnie zablokowane przez od jednej czwartej do połowy obrotu kluczem. Oprócz siły zacisku A, jednocześnie działająca siła promieniowa B spowoduje dalsze działanie akcji blokowania,
- często używane jako nakrętka zabezpieczająca nad nakrętką sześciokątną,
- demontaż przez mocne zaciśnięcie nakrętki sześciokątnej.

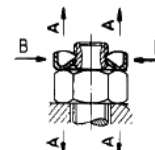

Grupy katalogowe

Gwint	Gniazdo	Materiał	Obróbka powierzchni	Kod	Strona
M	Sześciokąt	Stal sprężynowa	Ocynk.	12530	3-85
M	Sześciokąt	Stal sprężynowa	Ocynk. gor.	12531	3-85
M	Sześciokąt	St.St. A2		51735	3-85
M	Sześciokąt	St.St. A4		55735	3-85



12530 PAL Nakrętki kontrolujące samozabezpieczające		F01X
Gwint	Metryczny	 
Materiał	Stal sprężynowa	
Obróbka powierzchni	Ocynkowane	

d	✉	Kod artykułu	d	✉	Kod artykułu	d	✉	Kod artykułu
M5	200	12530.050.001	M14	100	12530.140.001	M24	100	12530.240.001
M6	200	12530.060.001	M16	100	12530.160.001	M27	100	12530.270.001
M8	100	12530.080.001	M18	100	12530.180.001	M30	100	12530.300.001
M10	100	12530.100.001	M20	100	12530.200.001	M36	100	12530.360.001
M12	100	12530.120.001	M22	100	12530.220.001	M42	50	12530.420.001



• Ostrzeżenie: cynkowanie elektrolityczne tych produktów może wywołać kruchość wodorową.

12531 Nakrętki kontrolujące samozabezpieczające PAL		F01A
Gwint	Metryczny	 
Materiał	Stal sprężynowa	
Obróbka powierzchni	Ocynkowane na gorąco	

d	✉	Kod artykułu	d	✉	Kod artykułu	d	✉	Kod artykułu
M10	100	12531.100.001	M20	100	12531.200.001	M30	100	12531.300.001
M12	100	12531.120.001	M24	50	12531.240.001	M36	25	12531.360.001
M16	100	12531.160.001	M27	100	12531.270.001			

51735 PAL Nakrętki kontrolujące samozabezpieczające		R09A
Gwint	Metryczny	 
Materiał	Stal nierdzewna A2	
	DIN ≈7967 NF ≈E27-460	

d	✉	Kod artykułu	d	✉	Kod artykułu	d	✉	Kod artykułu
M4*	500	51735.040.001	M8	100	51735.080.001	M16	50	51735.160.001
M5*	500	51735.050.001	M10	100	51735.100.001	M20	50	51735.200.001
M6	200	51735.060.001	M12	50	51735.120.001	M24	50	51735.240.001

55735 Nakrętki zabezpieczające		R49A
Gwint	Metryczny	 
Materiał	Stal nierdzewna A4	
	DIN ≈7967 NF ≈E27-460	

d	✉	Kod artykułu	d	✉	Kod artykułu	d	✉	Kod artykułu
M4*	500	55735.040.001	M10*	100	55735.100.001	M20*	100	55735.200.001
M5*	500	55735.050.001	M12*	100	55735.120.001	M24*	50	55735.240.001
M6	100	55735.060.001	M16*	100	55735.160.001	M27*	50	55735.270.001
M8	100	55735.080.001						

Nakrętki koronowe, metryczne

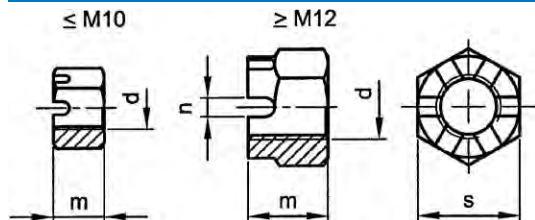

DIN 935-1
NEN 729

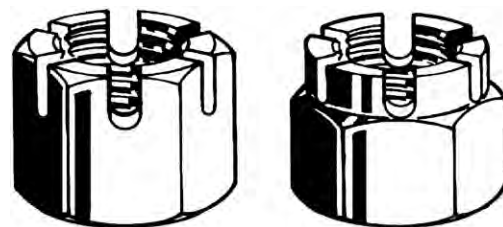

3

Informacje techniczne

d	Liczba rowków	m	n	P	s	Zawlecza DIN 94
M5	6	6	1.4	0.8	8	1.2x12
M6	6	7.5	2	1	10	1.6x14
M8	6	9.5	2.5	1.25	13	2x16
M10	6	12	2.8	1.5	17 (16)	2.5x20
M12	6	15	3.5	1.75	19 (18)	3.2x22
M14	6	16	3.5	2	22 (21)	3.2x25
M16	6	19	4.5	2	24	4x28
M18	6	21	4.5	2.5	27	4x32
M20	6	22	4.5	2.5	30	4x36
M22	6	26	5.5	2.5	32 (34)	5x36
M24	6	27	5.5	3	36	5x40
M27	6	30	5.5	3	41	5x45
M30	6	33	7	3.5	46	6.3x50
M33	6	35	7	3.5	50	6.3x56
M36	6	38	7	4	55	6.3x63
M39	6	40	7	4	60	6.3x71
M42	8	46	9	4.5	65	8x71
M45	8	48	9	4.5	70	8x80
M48	8	50	9	5	75	8x80
M52	8	54	9	5	80	8x90
M56	8	57	9	5.5	85	8x100
M60	8	63	11	5.5	90	10x100
M64	8	66	11	6	95	10x100

- Wartości sugerowane dla zalecanych zawleczek zgodn. z DIN 94 (ISO 1234).
- W zależności od dostępności wymiary mogą się różnić.

Grupy katalogowe

Gwint	Gniazdo	Materiał	Klasa	Obróbka powierzchni	Kod	Strona
M	Sześciokąt	St	4		12000	3-86
M	Sześciokąt	St	4	Ocynk.	12010	3-87
M	Sześciokąt	St.St. A2			51220	3-87
M	Sześciokąt	St.St. A4			55220	3-87

12000 Nakrętki koronowe, metryczne

F01D

Gwint Metryczny
Materiał Stal
Klasa 4

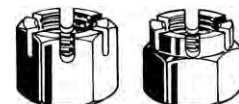

d	☒	Kod artykułu	d	☒	Kod artykułu	d	☒	Kod artykułu
M5	100	12000.050.001	M20	25	12000.200.001	M42	4	12000.420.001
M6	100	12000.060.001	M22	25	12000.220.001	M45	3	12000.450.001
M8	100	12000.080.001	M24	25	12000.240.001	M48	3	12000.480.001
M10	100	12000.100.001	M27	10	12000.270.001	M52	1	12000.520.001
M12	100	12000.120.001	M30	10	12000.300.001	M56	1	12000.560.001
M14	50	12000.140.001	M33	10	12000.330.001	M60	1	12000.600.001
M16	50	12000.160.001	M36	5	12000.360.001	M64	1	12000.640.001
M18	50	12000.180.001	M39	4	12000.390.001			

- Nakrętki koronowe do M12 włącznie mają klasę 5, a powyżej M12 klasę 4.
- Nakrętki koronowe do rozmiaru M39 włącznie są dostarczane z 6 rowkami, a powyżej M39 z 8 rowkami.

12010 Nakrętki koronowe, metryczne		F01D
Gwint	Metryczny	
Materiał	Stal	
Klasa	4	
Obróbka powierzchni	Ocynkowane	

d	☒	Kod artykułu	d	☒	Kod artykułu	d	☒	Kod artykułu
M6	100	12010.060.001	M16	50	12010.160.001	M27	10	12010.270.001
M8	100	12010.080.001	M20	25	12010.200.001	M30	10	12010.300.001
M10	100	12010.100.001	M22	25	12010.220.001	M33	10	12010.330.001
M12	100	12010.120.001	M24	25	12010.240.001	M36	5	12010.360.001
M14	50	12010.140.001						

- Nakrętki koronowe do M12 włącznie mają klasę 5, a powyżej M12 klasę 4.
- Nakrętki koronowe do rozmiaru M39 włącznie są dostarczane z 6 rowkami, a powyżej M39 z 8 rowkami.

51220 Nakrętki koronowe, metryczne		R09A
Gwint	Metryczny	
Materiał	Stal nierdzewna A2	

d	☒	Kod artykułu	d	☒	Kod artykułu	d	☒	Kod artykułu
M5	50	51220.050.001	M14	25	51220.140.001	M22*	25	51220.220.001
M6	50	51220.060.001	M16	10	51220.160.001	M24	5	51220.240.001
M8	50	51220.080.001	M18	10	51220.180.001	M27	3	51220.270.001
M10	50	51220.100.001	M20	5	51220.200.001	M30	1	51220.300.001
M12	25	51220.120.001						

55220 Nakrętki koronowe, metryczne		R49A
Gwint	Metryczny	
Materiał	Stal nierdzewna A4	

d	☒	Kod artykułu	d	☒	Kod artykułu	d	☒	Kod artykułu
M5	50	55220.050.001	M12	25	55220.120.001	M20	5	55220.200.001
M6	50	55220.060.001	M14	25	55220.140.001	M24	5	55220.240.001
M8	50	55220.080.001	M16	10	55220.160.001	M27	3	55220.270.001
M10	50	55220.100.001	M18	10	55220.180.001	M30	1	55220.300.001

Nakrętki koronowe, metryczne drobnozwojne

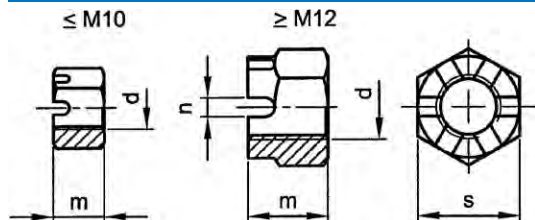

DIN 935
NEN 729

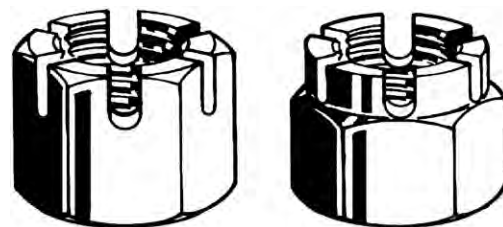

3

Informacje techniczne

d	Liczba rowków	m	n	s	Zawlecзка DIN 94
M8	6	9.5	2.5	13	2x16
M10	6	12	2.8	17 (16)	2.5x20
M12	6	15	3.5	19 (18)	3.2x22
M14	6	16	3.5	22 (21)	3.2x25
M16	6	19	4.5	24	4x28
M18	6	21	4.5	27	4x32
M20	6	22	4.5	30	4x36
M22	6	26	5.5	32 (34)	5x36
M24	6	27	5.5	36	5x40
M27	6	30	5.5	41	5x45
M30	6	33	7	46	6.3x50
M36	6	38	7	55	6.3x63
M42	8	46	9	65	8x71

- Wartości sugerowane dla zalecanych zawleczek zgodn. z DIN 94 (ISO 1234).
- W zależności od dostępności wymiary mogą się różnić.

12020 Nakrętki koronowe, metryczne drobnozwojne

F01D

Gwint Metryczny drobnozwojny
Materiał Stal
Klasa 4

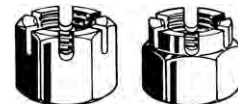

d x P	☒	Kod artykułu	d x P	☒	Kod artykułu	d x P	☒	Kod artykułu
M8X1,00	100	12020.080.100	M18X1,50	50	12020.180.150	M30X1,50 (≠DIN)	10	12020.300.150
M10X1,00	100	12020.100.100	M20X1,50	25	12020.200.150	M30X2,00	10	12020.300.200
M12X1,50	100	12020.120.150	M22X1,50	25	12020.220.150	M36X1,50 (≠DIN)	5	12020.360.150
M14X1,50	50	12020.140.150	M24X1,50 (≠DIN)	25	12020.240.150	M42X1,50 (≠DIN)	5	12020.420.150
M16X1,50	50	12020.160.150	M27X1,50 (≠DIN)	10	12020.270.150			

Nakrętki koronowe niskie, metryczne

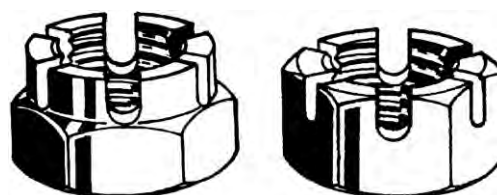
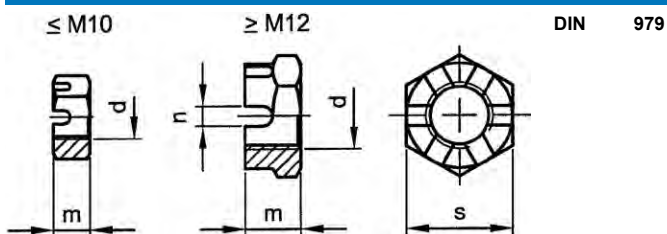

Informacje techniczne

d	m	n	P	s	Zawlecзка DIN 94
M6	5	2	1	10	1.6x14
M8	6.5	2.5	1.25	13	2x16
M10	9	2.8	1.5	17	2.5x20
M12	10	3.5	1.75	19 (18)	3.2x22
M14	11	3.5	2	22 (21)	3.2x25
M16	13	4.5	2	24	4x28
M18	15	4.5	2.5	27	4x32
M20	16	4.5	2.5	30	4x36
M22	18	5.5	2.5	32 (34)	5x36
M24	19	5.5	3	36	5x40
M27	22	5.5	3	41	5x45
M30	24	7	3.5	46	6.3x50

- Wartości sugerowane dla zalecanych zawleczek zgodn. z DIN 94 (ISO 1234).
- W zależności od dostępności wymiary mogą się różnić.

Grupy katalogowe

Gwint	Gniazdo	Materiał	Klasa	Kod	Strona
M	Sześciokąt	St	04	12060	3-89
M	Sześciokąt	St.St. A2	35	51224	3-89

12060 Nakrętki koronowe niskie, metryczne

F01D

Gwint Metryczny
Materiał Stal
Klasa 04



d	☒	Kod artykułu	d	☒	Kod artykułu	d	☒	Kod artykułu
M8	100	12060.080.001	M16	50	12060.160.001	M24	25	12060.240.001
M10	100	12060.100.001	M18	50	12060.180.001	M27	10	12060.270.001
M12	100	12060.120.001	M20	25	12060.200.001	M30	10	12060.300.001
M14	50	12060.140.001	M22	25	12060.220.001			

51224 Nakrętki koronowe niskie, metryczne

R05A

Gwint Metryczny
Materiał Stal nierdzewna A2
Klasa 35



d	☒	Kod artykułu	d	☒	Kod artykułu	d	☒	Kod artykułu
M8*	50	51224.080.001	M12*	50	51224.120.001	M16*	25	51224.160.001
M10*	50	51224.100.001						

Nakrętki koronowe niskie

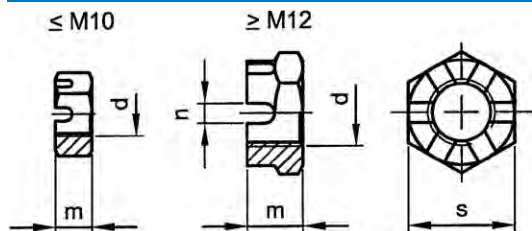

DIN 937

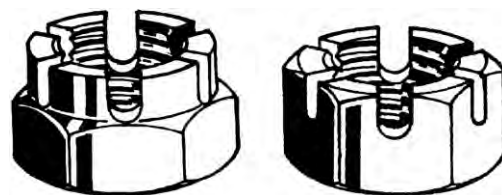

3

Informacje techniczne

d	m	n	P	s	Zawlecзка DIN 94
M6	6	2	1	10	1.6x14
M8	8	2.5	1.25	13	2x16
M10	8	2.8	1.5	17 (16)	2.5x20
M12	10	3.5	1.75	19	3.2x22
M16	12	4.5	2	24	4x28
M18	13	4.5	2.5	27	4x32
M20	13	4.5	2.5	30	4x36

Grupy katalogowe

Gwint	Gniazdo	Materiał	Klasa	Kod	Strona
M	Sześciokąt	St.St. A2	35	51225	3-90
M	Sześciokąt	St.St. A4	35	55225	3-90

51225	Nakrętki koronowe niskie	R05A
Gwint	Metryczny	
Materiał	Stal nierdzewna A2	
Klasa	35	

d	☒	Kod artykułu	d	☒	Kod artykułu	d	☒	Kod artykułu
M10*	50	51225.100.001	M16*	50	51225.160.001	M20*	25	51225.200.001

55225	Nakrętki koronowe niskie	R45A
Gwint	Metryczny	
Materiał	Stal nierdzewna A4	
Klasa	35	

d	☒	Kod artykułu	d	☒	Kod artykułu	d	☒	Kod artykułu
M6*	100	55225.060.001	M10*	50	55225.100.001	M16*	50	55225.160.001
M8*	100	55225.080.001	M12*	50	55225.120.001	M18*	25	55225.180.001

Nakrętki koronowe niskie, metryczne drobnozwojne

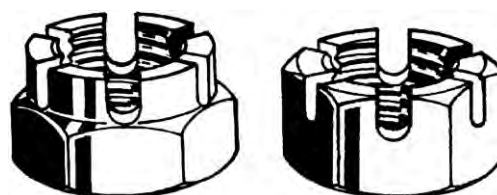
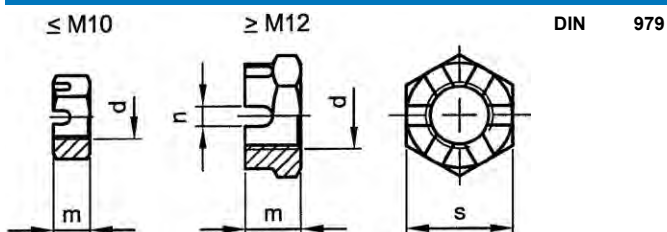

Informacje techniczne

d	m	n	s	Zawlecza DIN 94
M8	6.5	2.5	13	2X16
M10	8	2.8	17 (16)	2.5X20
M12	10	3.5	19 (18)	3.2X22
M14	11	3.5	22 (21)	3.2X25
M16	13	4.5	24	4X28
M18	15	4.5	27	4X32
M20	16	4.5	30	4X36
M22	18	5.5	32 (34)	5x36
M24	19	5.5	36	5x40
M27	22	5.6	41	5x45
M30	24	7	46	6.3x50
M39	31	7	60	6.3x71

- Wartości sugerowane dla zalecanych zawleczek zgodn. z DIN 94 (ISO 1234).
- W zależności od dostępności wymiary mogą się różnić.

12080 Nakrętki koronowe niskie, metryczne drobnozwojne

F01D

Gwint Metryczny drobnozwojny
 Materiał Stal
 Klasa ≥ 04



d x P	☒	Kod artykułu	d x P	☒	Kod artykułu	d x P	☒	Kod artykułu
M8X1,00	100	12080.080.100	M18X1,50	50	12080.180.150	M27X1,50 (#DIN)	10	12080.270.150
M10X1,00	100	12080.100.100	M20X1,50	25	12080.200.150	M30X1,50 (#DIN)	10	12080.300.150
M12X1,50	100	12080.120.150	M22X1,50	25	12080.220.150	M30X2,00	10	12080.300.200
M14X1,50	50	12080.140.150	M24X1,50 (#DIN)	25	12080.240.150	M39X1,50 (#DIN)	5	12080.390.150
M16X1,50	50	12080.160.150						

Nakrętki koronowe, UNF

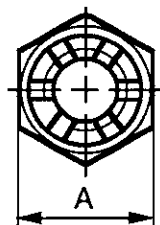
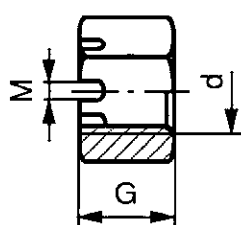

BS ≈1768

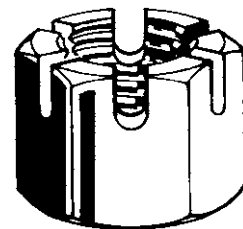

3

Informacje techniczne

d	A	G	M	Zwoje gwintu na cal
1/4	7/16	5.7	2	28
3/8	9/16	8	3.2	24
7/16	11/16	9.7	3.2	20
1/2	3/4	11.2	4	20
5/8	15/16	14	4.8	18
3/4	1.1/8	16.5	4.8	16
7/8	1.5/16	19.3	4.8	14
1 Inch-12G	1.1/2	22.2	6.4	12
1 Inch-14G	1.1/2	22.2	6.4	14
1.1/4	1.7/8	27.6	8	12
1.1/2	2.1/4	33.3	9.5	12

- W zależności od dostępności wymiary mogą się różnić.
- Jeżeli podczas zamówienia nie określi się gwintu UNF z 12 zwojami na cal, to dostarczamy typ z 14 zwojami na cal (UNS).

12161 Nakrętki koronowe, UNF		X09A
Gwint	Całowy, zunifikowany drobnozwojny (UNF)	
Materiał	Stal	
Klasa	6	

d	☒	Kod artykułu	d	☒	Kod artykułu	d	☒	Kod artykułu
1/4	100	12161.063.001	5/8	25	12161.158.001	1-14G	10	12161.256.001
3/8	100	12161.096.001	3/4	25	12161.191.001	1.1/4	10	12161.317.001
7/16	50	12161.111.001	7/8	25	12161.222.001	1.1/2	5	12161.381.001
1/2	50	12161.127.001	1-12G	10	12161.255.001			

KALEI Nakrętki dociskowe



Informacje ogólne

Przy pomocy nakrętek dociskowych KALEI, cienkie arkusze materiału od grubości 1 mm, mogą być dostarczane z całkowicie obciążalnym gwintem. To jest idealne rozwiązanie dla przemysłu przetwórczego arkuszy blach metalowych i/lub plastiku.

Zasada działania

Specjalnie uformowany kołnierz zaciska się mocno w materiale w taki sposób, że nakrętka dociskowa KALEI jest zabezpieczona przed ściągającym luzem osiowym, jak również od obracania się zgodnie z kierunkiem ruchu wskazówek zegara, patrząc od strony montażu.

Montaż

Należy wycentrować nakrętkę dociskową KALEI nad wywierconym lub wybitym otworem (tolerancja średnicy otworu $d_2 = H11$). Mechaniczne wstawienie lub wbicie młotkiem osadza ząbkowany kołnierz w ścianach otworu (użycie odpowiednich narzędzi ułatwia montaż). Śruby są wkręcane w nakrętki dociskowe KALEI od strony kołnierza. Podczas dokręcania kołnierz będzie jeszcze mocniej zamocowany w materiale.

Typ

Stal cynkowana i stal nierdzewna z wysokościami kołnierza (Kh) od 0,9 mm aż do 3,9 mm włącznie. Na żądanie dostępne są specjalne nakrętki dociskowe KALEI z wyższymi kołnierzami do stosowania w lekkich materiałach, tworzywach sztucznych, itd., jak również niemetryczne nakrętki dociskowe KALEI.

Właściwości

- idealna metoda zabezpieczająca cienkie arkusze blachy z obciążalnym gwintem,
- prosty i szybki montaż, bez zgrzewania lub nitowania,
- bezpieczne osadzanie w arkuszach blach przez specjalnie nachylony ząbkowany i nawęglony kołnierz,
- możliwe do zastosowania w stali, aluminium i tworzywach sztucznych,
- dostępne dla materiałów o różnej grubości.

3

Kolejność montażu

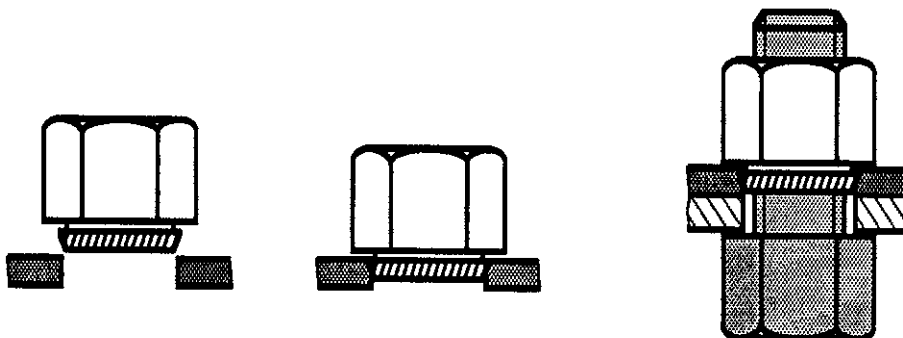

Nakrętki wciskane

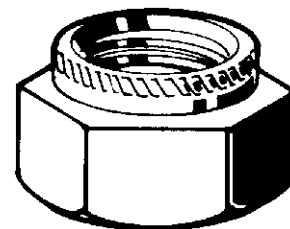
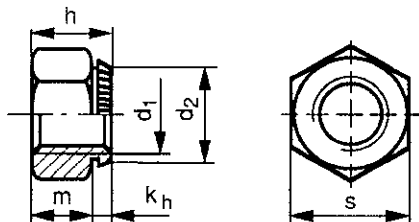

3

Informacje techniczne

d ₁	d ₂	Grubość materiału (min.)	h	k _h	m	Otwór ø (H11)	P	s
M3	4.5	1	3	0.9	2.1	4.5	0.5	5.5
M3 (Kh1.4)	4.5	1.5	3	1.4	1.6	4.5	0.5	5.5
M3 (Kh1.8)	4.5	2	3	1.8	1.2	4.5	0.5	5.5
M4	5.5	1	3.2	0.9	2.3	5.5	0.7	7
M4 (Kh1.4)	5.5	1.5	3.2	1.4	1.8	5.5	0.7	7
M4 (Kh1.8)	5.5	2	4.5	1.8	2.7	5.5	0.7	7
M5	6.5	1	4	0.9	3.1	6.5	0.8	8
M5 (Kh1.4)	6.5	1.5	4	1.4	2.6	6.5	0.8	8
M5 (Kh1.8)	6.5	2	5	1.8	3.2	6.5	0.8	8
M6	8	1	5	0.9	4.1	8	1	10
M6 (Kh1.4)	8	1.5	5	1.4	3.6	8	1	10
M6 (Kh1.8)	8	2	5	1.8	3.2	8	1	10
M8	10	2	6.5	1.8	4.7	10	1.25	13
M10	12.5	2	8	1.8	6.2	12.5	1.5	15
M12	14.5	3	10	2.8	7.2	14.5	1.75	17
M16	18.5	3	13	2.4	10.6	18.5	2	22
M20	23	4	16	3.9	12.1	23	2.5	27

Grupy katalogowe

Gwint	Gniazdo	Materiał	Klasa	Obróbka powierzchni	Kod	Strona	
M	Sześciokąt	St	6	Ocynk.	15000	3-94	
M	Sześciokąt	St.St. A1			15060	3-94	
M	Sześciokąt	St	6	Ocynk.	Kh=1,4	15010	3-95
M	Sześciokąt	St.St. A1			Kh=1,4	15070	3-95
M	Sześciokąt	St	6	Ocynk.	Kh=1,8	15020	3-95
M	Sześciokąt	St.St. A1			Kh=1,8	15080	3-95

15000 KALEI Nakrętki wciskane

F01E

Gwint Metryczny
Materiał Stal
Klasa 6
Obróbka powierzchni Ocynkowane

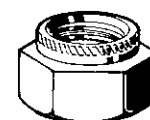

d ₁	☒	Kod artykułu	d ₁	☒	Kod artykułu	d ₁	☒	Kod artykułu
M3	250	15000.030.001	M6	250	15000.060.001	M12	100	15000.120.001
M4	250	15000.040.001	M8	250	15000.080.001	M16	50	15000.160.001
M5	250	15000.050.001	M10	100	15000.100.001	M20	25	15000.200.001

15060 KALEI Nakrętki wciskane

F01E

Gwint Metryczny
Materiał Stal nierdzewna A1

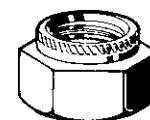

d ₁	☒	Kod artykułu	d ₁	☒	Kod artykułu	d ₁	☒	Kod artykułu
M3	100	15060.030.001	M6	100	15060.060.001	M12	50	15060.120.001
M4	100	15060.040.001	M8	50	15060.080.001	M16	25	15060.160.001
M5	100	15060.050.001	M10	50	15060.100.001			

15010 KALEI Nakrętki wciskane, Kh=1,4		F01E	
Gwint	Metryczny	 	
Materiał	Stal		
Klasa	6		
Obróbka powierzchni	Ocynkowane		

d ₁	☒	Kod artykułu	d ₁	☒	Kod artykułu	d ₁	☒	Kod artykułu
M3		250 15010.030.001	M5		250 15010.050.001	M6		250 15010.060.001
M4		250 15010.040.001						

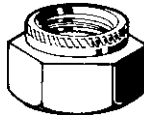
15070 KALEI Nakrętki wciskane, Kh=1,4		F01E	
Gwint	Metryczny	 	
Materiał	Stal nierdzewna A1		
Klasa	6		
Obróbka powierzchni	Ocynkowane		

d ₁	☒	Kod artykułu	d ₁	☒	Kod artykułu	d ₁	☒	Kod artykułu
M3		100 15070.030.001	M5		100 15070.050.001	M6		100 15070.060.001
M4		100 15070.040.001						

15020 KALEI Nakrętki wciskane, Kh=1,8		F01E	
Gwint	Metryczny	 	
Materiał	Stal		
Klasa	6		
Obróbka powierzchni	Ocynkowane		

d ₁	☒	Kod artykułu	d ₁	☒	Kod artykułu	d ₁	☒	Kod artykułu
M3		250 15020.030.001	M5		250 15020.050.001	M6		250 15020.060.001
M4		250 15020.040.001						

15080 KALEI Nakrętki wciskane, Kh=1,8		F01E	
Gwint	Metryczny	 	
Materiał	Stal nierdzewna A1		
Klasa	6		
Obróbka powierzchni	Ocynkowane		

d ₁	☒	Kod artykułu	d ₁	☒	Kod artykułu	d ₁	☒	Kod artykułu
M3		100 15080.030.001	M5		100 15080.050.001	M6		100 15080.060.001
M4		100 15080.040.001						

Nakrętki wciskane okrągłe

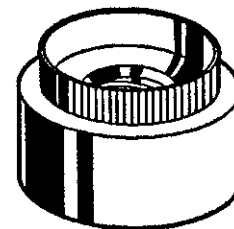
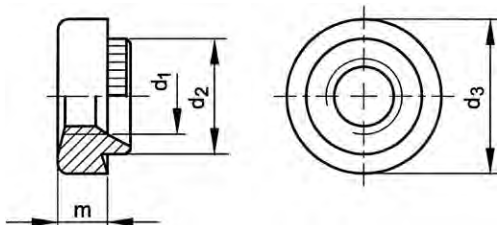

3

Informacje techniczne

d_1	d_2	d_3	m	Otwór \varnothing	P
M3	5.8	7.9	3.2	5.9	0.5
M4	6.9	9.5	3.8	6.95	0.7
M5	8.3	11.1	4.4	8.35	0.8
M6	9.6	12.7	5.7	9.65	1
M8	13	15.9	6.4	13.1	1.25
M10	15.4	19.1	7.6	15.5	1.5

12480 Nakrętki wciskane okrągłe

F01X

Gwint Metryczny
 Materiał Stal
 Obróbka powierzchni Ocynkowane

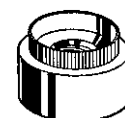

$d_1 - p$	☒	Kod artykułu	$d_1 - p$	☒	Kod artykułu	$d_1 - p$	☒	Kod artykułu
M3-1,0MM	250	12480.030.010	M4-3,0MM	250	12480.040.030	M6-2,5MM	250	12480.060.025
M3-1,5MM	250	12480.030.015	M5-1,0MM	250	12480.050.010	M6-3,0MM	250	12480.060.030
M3-1,8MM	250	12480.030.018	M5-1,5MM	250	12480.050.015	M6-4,0MM	250	12480.060.040
M3-2,5MM	250	12480.030.025	M5-2,0MM	250	12480.050.020	M8-1,5MM	250	12480.080.015
M4-1,0MM	250	12480.040.010	M5-2,5MM	250	12480.050.025	M8-2,0MM	250	12480.080.020
M4-1,5MM	250	12480.040.015	M5-3,0MM	250	12480.050.030	M8-2,5MM	250	12480.080.025
M4-2,0MM	250	12480.040.020	M6-1,5MM	250	12480.060.015	M8-3,0MM	250	12480.080.030
M4-2,5MM	250	12480.040.025	M6-2,0MM	250	12480.060.020	M10-3,0MM	100	12480.100.030

• p = Grubość materiału = Zakres uchwytu.

Nakrętki kołpakowe sześciokątne, wysokie

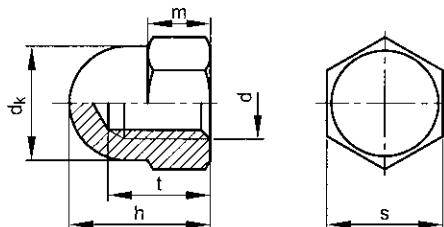

DIN 1587 (1987)
NEN 1618

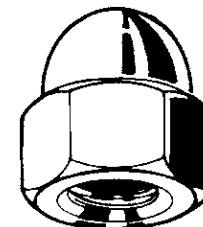

Informacje techniczne

d	d _k (maks.)	h	m (maks.)	P	s	t
M3 (#DIN)	5	6.5	2.5	0.5	5.5	4.5
M4	6.5	8	3.2	0.7	7	5.5
M5	7.5	10	4	0.8	8	7.5
M6	9.5	12	5	1	10	8
M7 (#DIN)	9.5	12	5	1	10	8
M8	12.5	15	6.5	1.25	13	11
M10	16	18	8	1.5	17	13
M12	18	22	10	1.75	19	16
M14	21	25	11	2	22	18
M16	23	28	13	2	24	21
M18	26	32	15	2.5	27	25
M20	28	34	16	2.5	30	26
M22	31	39	18	2.5	32	29
M24	34	42	19	3	36	31
M27 (#DIN)	40	47	20	3	41	35
M30 (#DIN)	42	52	24	3.5	46	38

Grupy katalogowe

Gwint	Gniazdo	Materiał	Klasa	Obróbka powierzchni	Kolor	Kod	Strona
M	Sześciokąt	St	6			16500	3-97
M	Sześciokąt	St	6	Ocynk.		16510	3-97
M	Sześciokąt	St	6	Ocynk. czrn. pas.		16516	3-98
M	Sześciokąt	St.St. A1	50			51400	3-98
M	Sześciokąt	St.St. A4	50			55400	3-98
M	Sześciokąt	St.St. A4	50	toczony		55402	3-98
M	Sześciokąt	Mosiądz Cu3				47340	3-98
M	Sześciokąt	Mosiądz Cu3		Niki.		47360	3-99
M	Sześciokąt	Plastik PA	PA 6.6		Biały	56250	3-99

16500 Nakrętki kołpakowe sześciokątne, wysokie

F01H

Gwint Metryczny
Materiał Stal
Klasa |6|



d	☒	Kod artykułu	d	☒	Kod artykułu	d	☒	Kod artykułu
M6	250	16500.060.001	M16	50	16500.160.001	M24	10	16500.240.001
M8	250	16500.080.001	M18	50	16500.180.001	M27	10	16500.270.001
M10	200	16500.100.001	M20	25	16500.200.001	M30	10	16500.300.001
M12	100	16500.120.001						

16510 Nakrętki kołpakowe sześciokątne, wysokie

F01H

Gwint Metryczny
Materiał Stal
Klasa |6|
Obróbka powierzchni Ocynkowane



d	☒	Kod artykułu	d	☒	Kod artykułu	d	☒	Kod artykułu
M3	250	16510.030.001	M10	200	16510.100.001	M18	25	16510.180.001
M4	250	16510.040.001	M12	100	16510.120.001	M20	25	16510.200.001
M5	250	16510.050.001	M14	50	16510.140.001	M22	10	16510.220.001
M6	250	16510.060.001	M16	50	16510.160.001	M24	10	16510.240.001
M8	250	16510.080.001						

16516	Nakrętki kołpakowe sześciokątne, wysokie	F01H
Gwint	Metryczny	
Materiał	Stal	
Klasa	[6]	
Obróbka powierzchni	Ocynkowane, po czarnej pasywacji	

d	☒	Kod artykułu	d	☒	Kod artykułu	d	☒	Kod artykułu
M5	250	16516.050.001	M6	250	16516.060.001	M8	250	16516.080.001

3

51400	Nakrętki kołpakowe sześciokątne, wysokie	R09A
Gwint	Metryczny	
Materiał	Stal nierdzewna A1	
Klasa	50	



d	☒	Kod artykułu	d	☒	Kod artykułu	d	☒	Kod artykułu
M3	100	51400.030.001	M10	50	51400.100.001	M22	5	51400.220.001
M4	100	51400.040.001	M12	25	51400.120.001	M24	5	51400.240.001
M5	100	51400.050.001	M14	10	51400.140.001	M27	3	51400.270.001
M6	100	51400.060.001	M16	10	51400.160.001	M30	1	51400.300.001
M7*	200	51400.070.001	M18	10	51400.180.001			
M8	50	51400.080.001	M20	5	51400.200.001			

• W zależności od dostępności może zostać dostarczona stal A1, jak również stal A2.

55400	Nakrętki kołpakowe sześciokątne, wysokie	R49A
Gwint	Metryczny	
Materiał	Stal nierdzewna A4	
Klasa	50	



d	☒	Kod artykułu	d	☒	Kod artykułu	d	☒	Kod artykułu
M3	100	55400.030.001	M10	50	55400.100.001	M20	5	55400.200.001
M4	100	55400.040.001	M12	25	55400.120.001	M22	5	55400.220.001
M5	100	55400.050.001	M14	10	55400.140.001	M24	5	55400.240.001
M6	100	55400.060.001	M16	10	55400.160.001	M27	3	55400.270.001
M8	50	55400.080.001	M18	10	55400.180.001	M30	1	55400.300.001

55402	Nakrętki kołpakowe sześciokątne, wysokie	R49A
Gwint	Metryczny	
Materiał	Stal nierdzewna A4	
Klasa	50	



d	☒	Kod artykułu	d	☒	Kod artykułu	d	☒	Kod artykułu
M5*	100	55402.050.001	M18*	25	55402.180.001	M24*	10	55402.240.001
M6*	100	55402.060.001						

47340	Nakrętki kołpakowe sześciokątne, wysokie	M11C
Gwint	Metryczny	
Materiał	Mosiądz Cu3	



d	☒	Kod artykułu	d	☒	Kod artykułu	d	☒	Kod artykułu
M3	500	47340.030.001	M8	100	47340.080.001	M16	10	47340.160.001
M4	200	47340.040.001	M10	50	47340.100.001	M20	10	47340.200.001
M5	200	47340.050.001	M12	25	47340.120.001	M24	5	47340.240.001
M6	200	47340.060.001	M14	25	47340.140.001			

47360	Nakrętki kołpakowe sześciokątne, wysokie		M11C
Gwint	Metryczny		
Materiał	Mosiądz Cu3		
Obróbka powierzchni	Niklowane		
			

d	☒	Kod artykułu	d	☒	Kod artykułu	d	☒	Kod artykułu
M3	500	47360.030.001	M6	200	47360.060.001	M12	25	47360.120.001
M4	200	47360.040.001	M8	100	47360.080.001	M16	10	47360.160.001
M5	200	47360.050.001	M10	50	47360.100.001	M20	10	47360.200.001

56250	Nakrętki kołpakowe sześciokątne, wysokie plastikowe		W02A
Gwint	Metryczny		
Materiał	Plastik Poliamid (nylon)		
Klasa	PA 6.6		
Kolor	Biały		
		DIN	≈1587 (1987)
		NEN	≈1618
		NF	≈E27-453

d	☒	Kod artykułu	d	☒	Kod artykułu	d	☒	Kod artykułu
M3	100	56250.030.001	M5	100	56250.050.001	M8	50	56250.080.001
M4	100	56250.040.001	M6	100	56250.060.001	M10	50	56250.100.001

Nakrętki kołpakowe sześciokątne, BSW

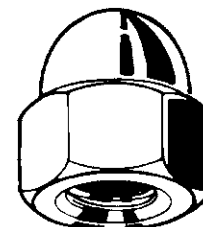
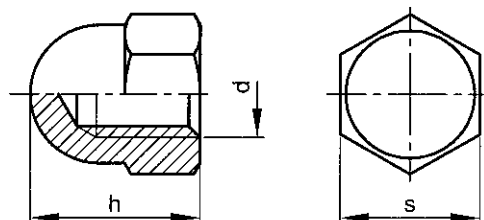

Informacje techniczne

d	h	s	Zwoje gwintu na cal	d	h	s	Zwoje gwintu na cal
1/4	12	11	20	5/8	32	27	11
5/16	15	13	18	3/4	39	32	10
1/2	25	22	12	7/8	42	36	9

- Gwint Whitworth'a (BSW/BSF) nie jest zalecany do międzynarodowego stosowania.
- Zaleca się stosowanie gwintu metrycznego (M/MF) lub zunifikowanego (UNC/UNF).

16540	Nakrętki kołpakowe sześciokątne, BSW		X08A
Gwint	Caliowy, Whitworth'a (BSW)		
Materiał	Stal		
Klasa	6		
			

d	☒	Kod artykułu	d	☒	Kod artykułu	d	☒	Kod artykułu
1/4	200	16540.063.001	1/2	25	16540.127.001	3/4	10	16540.191.001
5/16	100	16540.079.001	5/8	10	16540.158.001	7/8	10	16540.222.001

Nakrętki kołpakowe sześciokątne, wysokie z przyspawaną nakrętką ≈ DIN 1587

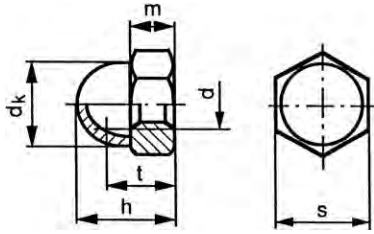

3

Informacje techniczne

d	d _k (maks.)	h	m (maks.)	P	s	t
M3	5	6.5	2.5	0.5	5.5	3
M4	6.5	6.5	3.2	0.7	7	4
M5	7.5	10	4	0.8	8	8
M6	9.5	12	5	1	10	10
M8	12.5	15	6.5	1.25	13	13
M10	16	18	8	1.5	16	15
M12	18	22	10	1.75	18	19
M16	23	28	13	2	24	26
M20	28	34	16	2.5	30	31

16300 Nakrętki kołpakowe sześciokątne, wysokie ze spawaną nakrętką

F01H

Gwint Metryczny
 Materiał Stal
 Klasa [6]
 Obróbka powierzchni Chromowany



d	☒	Kod artykułu	d	☒	Kod artykułu	d	☒	Kod artykułu
M3	250	16300.030.001	M6	200	16300.060.001	M12	50	16300.120.001
M4	200	16300.040.001	M8	200	16300.080.001	M16	25	16300.160.001
M5	200	16300.050.001	M10	100	16300.100.001	M20	10	16300.200.001

Nakrętki kołpakowe niskie

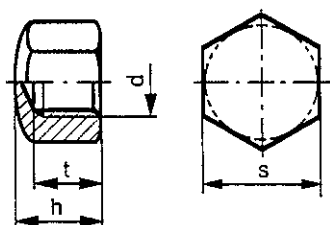

DIN 917
ISO 1617

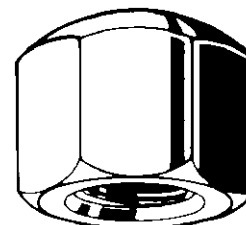

Informacje techniczne

d	h	P	s	t (min.)
M3 (#DIN)	4.5	0.5	5.5	3.5
M4	5.5	0.7	7	4.16
M5	7	0.8	8	4.96
M6	9	1	10	6.71
M8	12	1.25	13	9.21
M10	14	1.5	16	10.65
M12	16	1.75	18	13.15
M14	18	2	21	14.65
M16	20	2	24	16.65
M18	22	2.5	27	18.58
M20	25	2.5	30	20.58
M22	28	2.5	34	21.58
M24	30	3	36	23.58
M27	32	3	41	25.58
M30	34	3.5	46	27.58

Grupy katalogowe

Gwint	Gniazdo	Materiał	Klasa	Obróbka powierzchni	Kod	Strona
M	Sześciokąt	St	[6]	Ocynk.	16410	3-101
M	Sześciokąt	St.St. A1	50		51380	3-101
M	Sześciokąt	St.St. A4	50		55380	3-102
M	Sześciokąt	Mosiądz Cu3			47300	3-102

16410 Nakrętki kołpakowe niskie

F01H

Gwint Metryczny
Materiał Stal
Klasa [6]
Obróbka powierzchni Ocynkowane

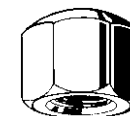

d	☒	Kod artykułu	d	☒	Kod artykułu	d	☒	Kod artykułu
M4	250	16410.040.001	M8	250	16410.080.001	M16	50	16410.160.001
M5	250	16410.050.001	M10	200	16410.100.001	M20	25	16410.200.001
M6	250	16410.060.001	M12	100	16410.120.001	M24	10	16410.240.001

51380 Nakrętki kołpakowe niskie

R09A

Gwint Metryczny
Materiał Stal nierdzewna A1
Klasa 50





d	☒	Kod artykułu	d	☒	Kod artykułu	d	☒	Kod artykułu
M3	200	51380.030.001	M10	50	51380.100.001	M20	5	51380.200.001
M4	100	51380.040.001	M12	25	51380.120.001	M22*	25	51380.220.001
M5	100	51380.050.001	M14*	50	51380.140.001	M24*	10	51380.240.001
M6	100	51380.060.001	M16	10	51380.160.001	M27*	10	51380.270.001
M8	50	51380.080.001	M18*	50	51380.180.001	M30*	10	51380.300.001

W zależności od dostępności może zostać dostarczona stal A1, jak również stal A2.

55380	Nakrętki kołpakowe niskie					R49A
Gwint	Metryczny					
Materiał	Stal nierdzewna A4					
Klasa	50					
						

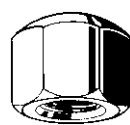
d	☒	Kod artykułu	d	☒	Kod artykułu	d	☒	Kod artykułu
M4	100	55380.040.001	M10	50	55380.100.001	M20	5	55380.200.001
M5	100	55380.050.001	M12	25	55380.120.001	M24	5	55380.240.001
M6	100	55380.060.001	M14*	50	55380.140.001	M27	1	55380.270.001
M8	50	55380.080.001	M16	10	55380.160.001	M30*	10	55380.300.001

47300	Nakrętki kołpakowe niskie					M11C
Gwint	Metryczny					
Materiał	Mosiądz Cu3					
Klasa						
						

d	☒	Kod artykułu	d	☒	Kod artykułu	d	☒	Kod artykułu
M3	200	47300.030.001	M8	100	47300.080.001	M14	25	47300.140.001
M4	200	47300.040.001	M10	50	47300.100.001	M16	10	47300.160.001
M5	200	47300.050.001	M12	25	47300.120.001	M20	10	47300.200.001
M6	200	47300.060.001						

Nakrętki kołpakowe sześciokątne samozabezpieczające z niemetaliczną wkładką

DIN 986

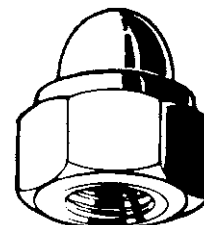
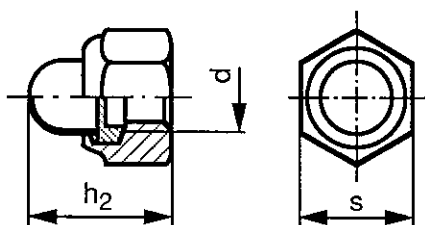



Informacje techniczne



d	h ₂	P	s	d	h ₂	P	s
M4	9.6	0.7	7	M10	18.1	1.5	16
M5	10.5	0.8	8	M12	22.5	1.75	18
M6	12	1	10	M16	27.5	2	24
M8	14	1.25	13	M20	35	2.5	30

Grupy katalogowe

Gwint	Gniazdo	Materiał	Klasa	Obróbka powierzchni	Kod	Strona
M	Sześciokąt	St	≥ 6	Ocyнк.	16450	3-102
M	Sześciokąt	St.St. A2			51405	3-103

16450	Nakrętki kołpakowe sześciokątne samozabezpieczające z niemetaliczną wkładką					F01H
Gwint	Metryczny					
Materiał	Stal					
Klasa	≥ 6					
Obróbka powierzchni	Ocyńkowane					
						

d	☒	Kod artykułu	d	☒	Kod artykułu	d	☒	Kod artykułu
M4	250	16450.040.001	M8	200	16450.080.001	M16	50	16450.160.001
M5	200	16450.050.001	M10	200	16450.100.001	M20	25	16450.200.001
M6	200	16450.060.001	M12	100	16450.120.001			

51405	Nakrętki kołpakowe sześciokątne samozabezpieczające z niemetaliczną wkładką					R09A
Gwint	Metryczny					 
Materiał	Stal nierdzewna A2					
Klasa						

d	☒	Kod artykułu	d	☒	Kod artykułu	d	☒	Kod artykułu
M4	100	51405.040.001	M8	50	51405.080.001	M12	25	51405.120.001
M5	100	51405.050.001	M10	50	51405.100.001	M16*	50	51405.160.001
M6	100	51405.060.001						

Nakrętki skrzydełkowe typu lekkiego (amerykańskie)

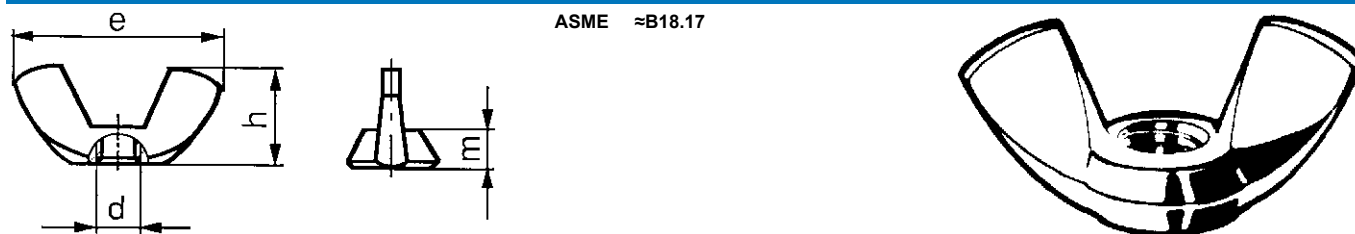

Informacje techniczne					
d	e ≈	h ≈	m ≈	P	
M3	18.5	8.8	3	0.5	
M4	18.5	8.8	3	0.7	
M5	22	10.5	4	0.8	
M6	26.8	12.9	4.9	1	
M8	30.3	14.8	5.4	1.25	
M10	35.3	17.3	6.3	1.5	
M12	47.5	22.5	7.9	1.75	
M14	65	30.8	10.6	2	
M16	65	30.8	10.6	2	
M20	66.5	31.2	12.2	2.5	

Grupy katalogowe						
Gwint	Gniazdo	Materiał	Klasa	Obróbka powierzchni	Kod	Strona
M	Skrzydełko	St	04	Ocynk.	16250	3-103
M	Skrzydełko	St.St. A2			51810	3-103
M	Skrzydełko	St.St. A4			55810	3-104

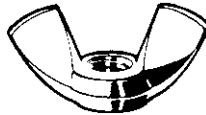
16250	Nakrętki skrzydełkowe typu lekkiego (amerykańskie)					F01X
Gwint	Metryczny					 
Materiał	Stal					
Klasa	04					
Obróbka powierzchni	Ocynkowane					

d	☒	Kod artykułu	d	☒	Kod artykułu	d	☒	Kod artykułu
M3	250	16250.030.001	M6	250	16250.060.001	M12	50	16250.120.001
M4	250	16250.040.001	M8	100	16250.080.001	M16	25	16250.160.001
M5	250	16250.050.001	M10	100	16250.100.001	M20	10	16250.200.001

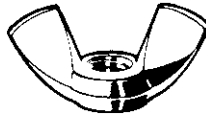
51810	Nakrętki skrzydełkowe typu lekkiego (amerykańskie)					R09A
Gwint	Metryczny					 
Materiał	Stal nierdzewna A2					
Klasa						

d	☒	Kod artykułu	d	☒	Kod artykułu	d	☒	Kod artykułu
M3	100	51810.030.001	M8	50	51810.080.001	M14	5	51810.140.001
M4	100	51810.040.001	M10	25	51810.100.001	M16	5	51810.160.001
M5	100	51810.050.001	M12	10	51810.120.001	M20	3	51810.200.001
M6	50	51810.060.001						

55810	Nakrętki skrzydełkowe typu lekkiego (amerykańskie)	R49A
Gwint	Metryczny	
Materiał	Stal nierdzewna A4	
		 

d	☒	Kod artykułu	d	☒	Kod artykułu	d	☒	Kod artykułu
M3	100	55810.030.001	M6	50	55810.060.001	M12	10	55810.120.001
M4	100	55810.040.001	M8	50	55810.080.001	M14*	50	55810.140.001
M5	100	55810.050.001	M10	25	55810.100.001	M16	5	55810.160.001

3

Nakrętki skrzydełkowe z okrągłymi skrzydełkami

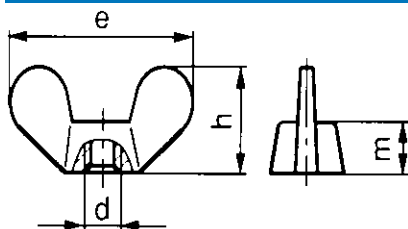

DIN 315
NEN 1625

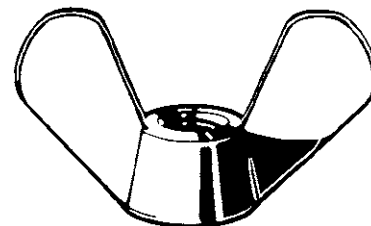

Informacje techniczne



d	e (maks.)	h (maks.)	m (min.)	P
M3 (#DIN)	17.6	8.6	2.9	0.5
M4	20	10.5	3.2	0.7
M5	26	13	4	0.8
M6	33	17	5	1
M8	39	20	6.5	1.25
M10	51	25	8	1.5
M12	65	33.5	10	1.75
M14 (#DIN)	65	33.5	11.2	2
M16	73	37.5	13	2
M20	90	46.5	16	2.5
M24	110	56.5	20	3

Grupy katalogowe

Gwint	Gniazdo	Materiał	Obróbka powierzchni	Kod	Strona
M	Skrzydełko	CI		16260	3-104
M	Skrzydełko	CI	Ocynk.	16270	3-104
M	Skrzydełko	St.St. A2		51800	3-105
M	Skrzydełko	St.St. A4		55800	3-105
M	Skrzydełko	Mosiądz		47550	3-105
M	Skrzydełko	Mosiądz	Nikl.	47560	3-105

16260	Nakrętki skrzydełkowe z okrągłymi skrzydełkami	F01X
Gwint	Metryczny	
Materiał	Żeliwo	
		 

d	☒	Kod artykułu	d	☒	Kod artykułu	d	☒	Kod artykułu
M6	200	16260.060.001	M10	100	16260.100.001	M12	50	16260.120.001
M8	100	16260.080.001						

16270	Nakrętki skrzydełkowe z okrągłymi skrzydełkami	F01X
Gwint	Metryczny	
Materiał	Żeliwo	
Obróbka powierzchni	Ocynkowane	
		 

d	☒	Kod artykułu	d	☒	Kod artykułu	d	☒	Kod artykułu
M4	250	16270.040.001	M8	100	16270.080.001	M14	50	16270.140.001
M5	250	16270.050.001	M10	100	16270.100.001	M16	20	16270.160.001
M6	200	16270.060.001	M12	50	16270.120.001	M20	10	16270.200.001

16270 Nakrętki skrzydełkowe z okrągłymi skrzydełkami

d	☒	Kod artykułu
M24	5	16270.240.001

51800 Nakrętki skrzydełkowe z okrągłymi skrzydełkami Q01A

Gwint	Metryczny		
Materiał	Stal nierdzewna A2		

d	☒	Kod artykułu	d	☒	Kod artykułu	d	☒	Kod artykułu
M4*	50	51800.040.001	M8	25	51800.080.001	M14*	10	51800.140.001
M5*	50	51800.050.001	M10	25	51800.100.001	M16*	10	51800.160.001
M6	50	51800.060.001	M12	25	51800.120.001			

55800 Nakrętki skrzydełkowe z okrągłymi skrzydełkami Q41A

Gwint	Metryczny		
Materiał	Stal nierdzewna A4		

d	☒	Kod artykułu	d	☒	Kod artykułu	d	☒	Kod artykułu
M4*	50	55800.040.001	M8*	50	55800.080.001	M14*	10	55800.140.001
M5*	50	55800.050.001	M10*	50	55800.100.001	M16*	10	55800.160.001
M6*	50	55800.060.001	M12*	25	55800.120.001			

47550 Nakrętki skrzydełkowe z okrągłymi skrzydełkami M11D

Gwint	Metryczny		
Materiał	Mosiądz		

d	☒	Kod artykułu	d	☒	Kod artykułu	d	☒	Kod artykułu
M3	250	47550.030.001	M8	100	47550.080.001	M16	20	47550.160.001
M4	250	47550.040.001	M10	100	47550.100.001	M20	10	47550.200.001
M5	250	47550.050.001	M12	50	47550.120.001	M24	5	47550.240.001
M6	200	47550.060.001	M14	50	47550.140.001			

47560 Nakrętki skrzydełkowe z okrągłymi skrzydełkami M11D

Gwint	Metryczny		
Materiał	Mosiądz		
Obróbka powierzchni	Nikiłowane		

d	☒	Kod artykułu	d	☒	Kod artykułu	d	☒	Kod artykułu
M4	250	47560.040.001	M8	100	47560.080.001	M12	50	47560.120.001
M5	250	47560.050.001	M10	100	47560.100.001	M16	20	47560.160.001
M6	200	47560.060.001						

Nakrętki skrzydełkowe, BSW

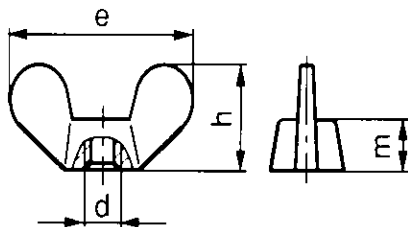

DIN ≈313 (1956)
NEN ≈2324 (1960)

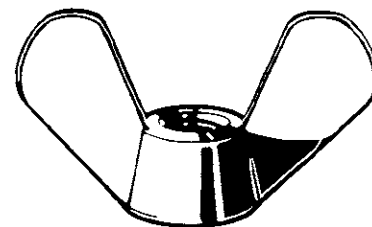

3

Informacje techniczne

d	e	h	m	Zwoje gwintu na cal
1/8 (#DIN)	17.6	8.6	2.9	40
5/32 (#DIN)	20	10.5	3.2	32
3/16 (#DIN)	26	13	4	24
1/4	33	17	5	20
5/16	39	20	6.5	18
3/8	51	25	8	16
1/2	65	33.5	10	12
5/8	73	37.5	13	11

- Gwint Whitworth'a (BSW/BSF) nie jest zalecany do międzynarodowego stosowania. Zaleca się stosowanie gwintu metrycznego (M/MF) lub zunifikowanego (UNC/UNF).
- W zależności od dostępności wymiary mogą się różnić.
- Nakrętki skrzydełkowe 1/8 cala są lekkimi nakrętkami typu amerykańskiego.

Grupy katalogowe

Gwint	Gniazdo	Materiał	Kod	Strona
BSW	Skrzydełko	CI	16280	3-106
BSW	Skrzydełko	Mosiądz Cu2	47570	3-106

16280 Nakrętki skrzydełkowe, BSW X08A

Gwint Cалowy, Whitworth'a (BSW)
Materiał Żelazo



d	⊗	Kod artykułu	d	⊗	Kod artykułu	d	⊗	Kod artykułu
1/8	250	16280.031.001	1/4	200	16280.063.001	1/2	50	16280.127.001
5/32	250	16280.039.001	5/16	100	16280.079.001	5/8	20	16280.158.001
3/16	250	16280.047.001	3/8	100	16280.096.001			

47570 Nakrętki skrzydełkowe, BSW X08A

Gwint Cалowy, Whitworth'a (BSW)
Materiał Mosiądz Cu2



d	⊗	Kod artykułu	d	⊗	Kod artykułu	d	⊗	Kod artykułu
5/32	250	47570.039.001	1/4	200	47570.063.001	3/8	100	47570.096.001
3/16	250	47570.047.001	5/16	100	47570.079.001			

Nakrętki z uchem

DIN 80701

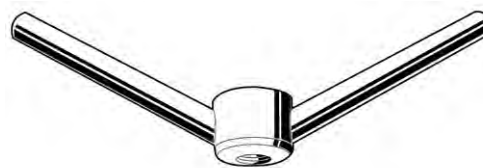

Informacje techniczne

d (h11)	d ₂	h ₁	h ₂	L ₂	P
M16	16	25	75	240	2
M20	16	25	75	240	2.5
M24	16	25	75	240	3

55792 Nakrętki z uchem R49A

Gwint Metryczny
 Materiał Stal nierdzewna A4
 Klasa 50



d	☒	Kod artykułu	d	☒	Kod artykułu	d	☒	Kod artykułu
M16*	5	55792.160.001	M20*	5	55792.200.001	M24*	5	55792.240.001

Nakrętki skrzydełkowe cysternowe

DIN 80704



Informacje techniczne

a	a	b	c	d ₂	d ₃	d ₄	h	m	P
M6	15	14	25	14	11.5	5	28	8	1.00
M8	20	18	32	18	15	6.5	36	10	1.25
M10	25	23	42	23	19	8	50	10	1.50
M12	27	27	48	24	20	10	52	15	1.75
M16	29	32	56	30	24	12	59	18	2.00
M20	32	36	64	36	28	13	66	21	2.50
M24	36	45	75	45	36	14	75	25	3.00

55793 Nakrętki skrzydełkowe cysternowe R49A

Gwint Metryczny
 Materiał Stal nierdzewna A4
 Klasa 50



d	☒	Kod artykułu	d	☒	Kod artykułu	d	☒	Kod artykułu
M6*	10	55793.060.001	M12*	5	55793.120.001	M20*	5	55793.200.001
M8*	10	55793.080.001	M16*	5	55793.160.001	M24*	5	55793.240.001
M10*	10	55793.100.001						

Nakrętki skrzydełkowe z kołnierzem, plastikowe

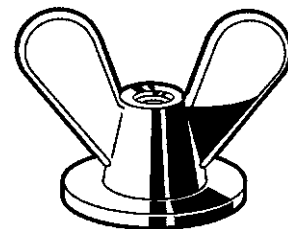
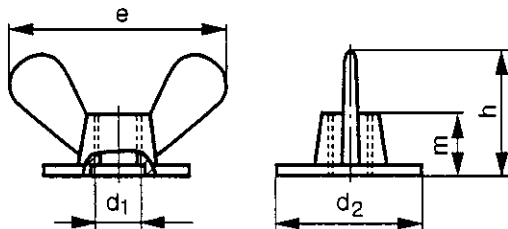

3

Informacje techniczne

d ₁	d ₂	e	h	m	P
M5	24	35	24	14	0.8
M6	24	35	24	14	1
M8	24	35	24	14	1.25

56290 Nakrętki skrzydełkowe z kołnierzem plastikowe

W02A

Gwint Metryczny
Materiał Plastik Poliamid (nylon)
Klasa PA 6.6
Kolor Biały



d ₁	☒	Kod artykułu	d ₁	☒	Kod artykułu	d ₁	☒	Kod artykułu
M5	100	56290.050.001	M6	50	56290.060.001	M8	50	56290.080.001

Nakrętki skrzydełkowe, plastikowe

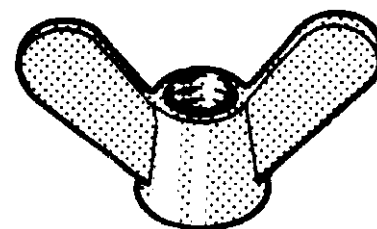
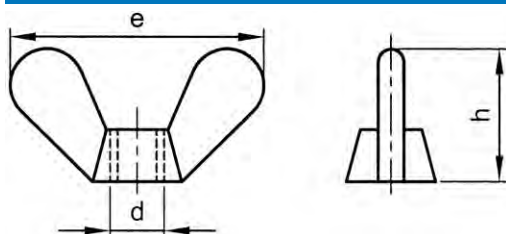

Informacje techniczne

d	e	h	m	P
M4	35	22	6	0.7
M5	35	22	6	0.8
M6	35	22	6	1
M8	35	22	14	1.25
M10	41	25	17	1.5

56280 Nakrętki skrzydełkowe plastikowe

W02A

Gwint Metryczny
Materiał Plastik Poliamid (nylon)
Klasa PA 6.6
Kolor Biały

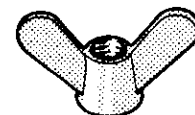

d	☒	Kod artykułu	d	☒	Kod artykułu	d	☒	Kod artykułu
M4	100	56280.040.001	M6	50	56280.060.001	M10	25	56280.100.001
M5	100	56280.050.001	M8	50	56280.080.001			

Nakrętki sześciokątne do zgrzewania

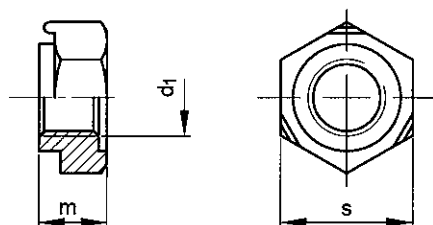

DIN 929

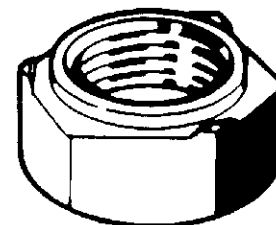

Informacje techniczne

d ₁	m (h14)	Otwór ø (H11)	P	s (h13)
M3	3	4.5	0.5	7.5
M4	3.5	6	0.7	9
M5	4	7	0.8	10
M6	5	8	1	11
M8	6.5	10.5	1.25	14
M10	8	12.5	1.5	17
M12	10	14.8	1.75	19
M14	11	16.8	2	22
M16	13	18.8	2	24

Grupy katalogowe

Gwint	Gniazdo	Materiał	Kod	Strona
M	Sześciokąt	St Max. 0,25%C	14020	3-109
M	Sześciokąt	St.St. A2	51180	3-109
M	Sześciokąt	St.St. A4	55180	3-109

14020 Nakrętki sześciokątne do zgrzewania

F01F

Gwint Metryczny
Materiał Stal Max. 0,25%C

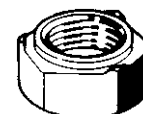

d ₁	☒	Kod artykułu	d ₁	☒	Kod artykułu	d ₁	☒	Kod artykułu
M3	1000	14020.030.001	M6	1000	14020.060.001	M12	100	14020.120.001
M4	1000	14020.040.001	M8	1000	14020.080.001	M14	100	14020.140.001
M5	1000	14020.050.001	M10	500	14020.100.001	M16	100	14020.160.001

- Te nakrętki mogą być stosowane ze śrubami klasy < 8.8.

51180 Nakrętki sześciokątne do zgrzewania

R09A

Gwint Metryczny
Materiał Stal nierdzewna A2

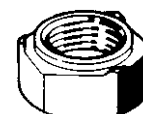

d ₁	☒	Kod artykułu	d ₁	☒	Kod artykułu	d ₁	☒	Kod artykułu
M3	100	51180.030.001	M6	100	51180.060.001	M12	25	51180.120.001
M4	100	51180.040.001	M8	50	51180.080.001	M16	25	51180.160.001
M5	100	51180.050.001	M10	50	51180.100.001			

55180 Nakrętki sześciokątne do zgrzewania

R49A

Gwint Metryczny
Materiał Stal nierdzewna A4

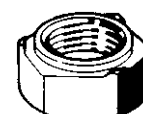

d ₁	☒	Kod artykułu	d ₁	☒	Kod artykułu	d ₁	☒	Kod artykułu
M3	100	55180.030.001	M6	100	55180.060.001	M12	25	55180.120.001
M4	100	55180.040.001	M8	50	55180.080.001	M16	25	55180.160.001
M5	100	55180.050.001	M10	50	55180.100.001			

Nakrętki do zgrzewania z gładkim kołnierzem

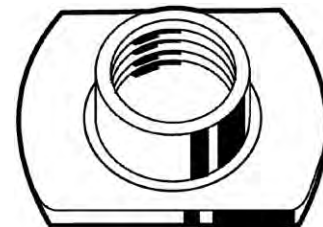
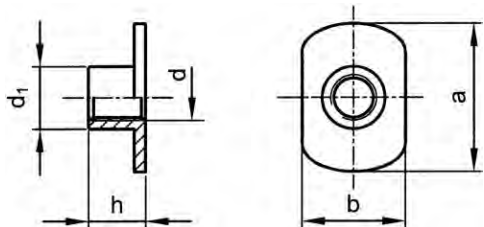

3

Informacje techniczne

d x a	a	b	d ₁	h	P
M3X17	17	9	4.6	5	0.5
M4X17	17	9	5	6	0.7
M5X19	19	11	6.4	7.5	0.8
M6X19	19	14	7.7	8.5	1
M6X22	22	14	7.7	8.5	1
M8X22	22	18	10.1	10	1.25
M8X26	26	18	10.1	10	1.25
M10X26	26	18	11.9	10.5	1.5

Grupy katalogowe

Gwint	Material	Kod	Strona
M	St	14230	3-110
M	St.St. A2	51182	3-110

14230 Nakrętki do zgrzewania z gładkim kołnierzem F01F

Gwint: Metryczny
Material: Stal



d x a	⊗	Kod artykułu	d x a	⊗	Kod artykułu	d x a	⊗	Kod artykułu
M4X17	1000	14230.040.001	M6X22	1000	14230.060.001	M10X26	500	14230.100.001
M5X19	1000	14230.050.001	M8X26	1000	14230.080.001			

51182 Nakrętki do zgrzewania z gładkim kołnierzem R09A

Gwint: Metryczny
Material: Stal nierdzewna A2



d x a	⊗	Kod artykułu	d x a	⊗	Kod artykułu	d x a	⊗	Kod artykułu
M3X17*	100	51182.030.017	M6X19*	100	51182.060.019	M8X26*	100	51182.080.026
M4X17*	100	51182.040.017	M6X22*	100	51182.060.022	M10X26*	100	51182.100.026
M5X19*	100	51182.050.019	M8X22*	100	51182.080.022			

Nakrętki do zgrzewania punktowego

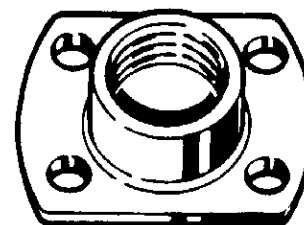
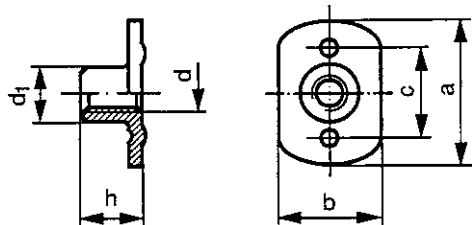

Informacje techniczne

d x d ₁	a	b	c	h	Liczba punktów spawu	P
M4X4.9	17	9	12	6	2	0.7
M4X5	17	9	12	6	2	0.7
M5X6.1	19	11	13	7.5	2	0.8
M5X6.4	19	11	14	7.5	2	0.8
M6X7.5	22	14	14	8.5	4	1
M6X7.7	22	14	16	8.5	2	1
M8X9.7	26	18	16	11	4	1.25
M8X10.1	26	18	16	10	4	1.25
M10X11.5	26	18	16	10.5	4	1.5
M10X11.9	26	18	16	10.5	4	1.5

Grupy katalogowe

Gwint	Materiał	Obróbka powierzchni	Kod	Strona
M	St		14200	3-111
M	St	Ocynk.	14210	3-111
M	St.St. A2		51183	3-111

14200 Nakrętki do zgrzewania punktowego

F01F

Gwint Metryczny
Materiał Stal

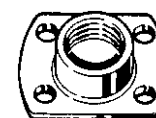

d x d ₁	☒	Kod artykułu	d x d ₁	☒	Kod artykułu	d x d ₁	☒	Kod artykułu
M4X5	1000	14200.040.001	M6X7,7	1000	14200.060.001	M10X11,9	500	14200.100.001
M5X6,4	1000	14200.050.001	M8X10,1	1000	14200.080.001			

14210 Nakrętki do zgrzewania punktowego

F01F

Gwint Metryczny
Materiał Stal
Obróbka powierzchni Ocynkowane



d x d ₁	☒	Kod artykułu	d x d ₁	☒	Kod artykułu	d x d ₁	☒	Kod artykułu
M5x6,4	1000	14210.050.001	M8x10,1	1000	14210.080.001	M10x11,9	500	14210.100.001
M6x7,7	1000	14210.060.001						

51183 Nakrętki do zgrzewania punktowego

R09A

Gwint Metryczny
Materiał Stal nierdzewna A2



d x d ₁	☒	Kod artykułu	d x d ₁	☒	Kod artykułu	d x d ₁	☒	Kod artykułu
M4x4,9	250	51183.040.001	M6x7,5	250	51183.060.001	M10x11,5	100	51183.100.001
M5x6,1	250	51183.050.001	M8x9,7	250	51183.080.001			

Nakrętki kwadratowe do zgrzewania

DIN 928

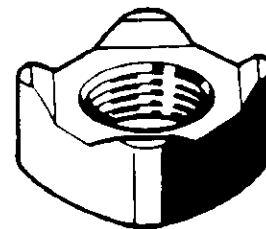
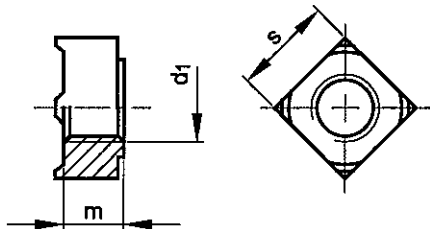

3

Informacje techniczne

d_1	m (h14)	Otwór \varnothing (H11)	P	s (h14)
M4	3.5	6	0.7	7
M5	4.2	7	0.8	9
M5 (#DIN)	4.2	7	0.8	8
M6	5	8	1	10
M8	6.5	10.5	1.25	14
M10	8	12.5	1.5	17
M12	9.5	14.8	1.75	19
M14	11.4	16.8	2	22

Grupy katalogowe

Gwint	Gniazdo	Materiał	Kod	Strona
M	Kwadratowy	St Max. 0,25%C	14000	3-112
M	Kwadratowy	St.St. A2	51178	3-112
M	Kwadratowy	St.St. A4	55178	3-112

14000 Nakrętki kwadratowe do zgrzewania

F01F

Gwint Metryczny
Materiał Stal Max. 0,25%C

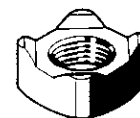

d_1	☒	Kod artykułu	d_1	☒	Kod artykułu	d_1	☒	Kod artykułu
M4	1000	14000.040.001	M8	1000	14000.080.001	M12	100	14000.120.001
M5	1000	14000.050.001	M10	500	14000.100.001	M14	100	14000.140.001
M6	1000	14000.060.001						

• Te nakrętki mogą być stosowane ze śrubami klasy < 8.8.

51178 Nakrętki kwadratowe do zgrzewania

R09A

Gwint Metryczny
Materiał Stal nierdzewna A2

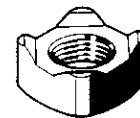

d_1	☒	Kod artykułu	d_1	☒	Kod artykułu	d_1	☒	Kod artykułu
M5	100	51178.050.001	M6	100	51178.060.001	M8	50	51178.080.001

55178 Nakrętki kwadratowe do zgrzewania

R49A

Gwint Metryczny
Materiał Stal nierdzewna A4

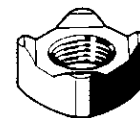

d	☒	Kod artykułu	d	☒	Kod artykułu	d	☒	Kod artykułu
M5*	200	55178.050.001	M6*	200	55178.060.001	M8*	200	55178.080.001

Nakrętki radełkowane z kołnierzem, wysokie

DIN 466

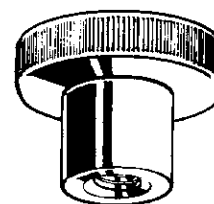
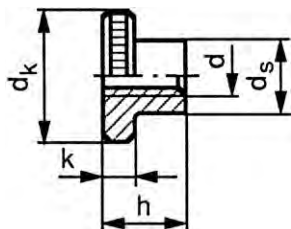

Informacje techniczne

d	d _k	d _s	h	k	P
M2	9	4.5	5.3	2	0.4
M3	12	6	7.5	2.5	0.5
M4	16	8	9.5	3.5	0.7
M5	20	10	11.5	4	0.8
M6	24	12	15	5	1
M8	30	16	18	6	1.25
M10	36	20	23	8	1.5

Grupy katalogowe

Gwint	Materiał	Klasa	Obróbka powierzchni	Kod	Strona
M	St	5	Ocynk.	16680	3-113
M	St.St. A1	50		51830	3-113
M	Mosiądz Cu3			47500	3-113

16680 Nakrętki radełkowane z kołnierzem, wysokie

F01X

Gwint	Metryczny
Materiał	Stal
Klasa	5
Obróbka powierzchni	Ocynkowane



d	☒	Kod artykułu	d	☒	Kod artykułu	d	☒	Kod artykułu
M3	100	16680.030.001	M5	50	16680.050.001	M8	25	16680.080.001
M4	50	16680.040.001	M6	25	16680.060.001	M10	10	16680.100.001

51830 Nakrętki radełkowane z kołnierzem, wysokie

R09A

Gwint	Metryczny
Materiał	Stal nierdzewna A1
Klasa	50



d	☒	Kod artykułu	d	☒	Kod artykułu	d	☒	Kod artykułu
M2*	100	51830.020.001	M5	25	51830.050.001	M8	10	51830.080.001
M3	50	51830.030.001	M6	10	51830.060.001	M10	5	51830.100.001
M4	25	51830.040.001						

47500 Nakrętki radełkowane z kołnierzem, wysokie

M11D

Gwint	Metryczny
Materiał	Mosiądz Cu3



d	☒	Kod artykułu	d	☒	Kod artykułu	d	☒	Kod artykułu
M3	100	47500.030.001	M5	50	47500.050.001	M8	25	47500.080.001
M4	50	47500.040.001	M6	25	47500.060.001	M10	10	47500.100.001

Nakrętki radełkowane, niskie

DIN 467

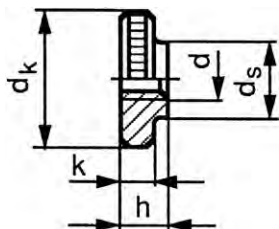

3

Informacje techniczne

d	dk	ds	h	k	P
M3	12	6	3	2.5	0.5
M4	16	8	4	3.5	0.7
M5	20	10	5	4	0.8
M6	24	12	6	5	1
M8	30	16	8	6	1.25
M10	36	20	10	8	1.5

Grupy katalogowe

Gwint	Materiał	Klasa	Obróbka powierzchni	Kod	Strona
M	St	5	Ocynk.	16690	3-114
M	St.St. A1	50		51840	3-114
M	Mosiądz Cu3			47510	3-114
M	Mosiądz Cu3		Nikl.	47511	3-115

16690 Nakrętki radełkowane, niskie		F01X
Gwint	Metryczny	
Materiał	Stal	
Klasa	5	
Obróbka powierzchni	Ocynkowane	

d	⊗	Kod artykułu	d	⊗	Kod artykułu	d	⊗	Kod artykułu
M3	100	16690.030.001	M5	50	16690.050.001	M8	25	16690.080.001
M4	50	16690.040.001	M6	25	16690.060.001	M10	10	16690.100.001

51840 Nakrętki radełkowane, niskie		R09A
Gwint	Metryczny	
Materiał	Stal nierdzewna A1	
Klasa	50	

d	⊗	Kod artykułu	d	⊗	Kod artykułu	d	⊗	Kod artykułu
M3	50	51840.030.001	M5	25	51840.050.001	M8	10	51840.080.001
M4	25	51840.040.001	M6	10	51840.060.001	M10	5	51840.100.001

47510 Nakrętki radełkowane, niskie		M11D
Gwint	Metryczny	
Materiał	Mosiądz Cu3	

d	⊗	Kod artykułu	d	⊗	Kod artykułu	d	⊗	Kod artykułu
M3	100	47510.030.001	M5	50	47510.050.001	M8	25	47510.080.001
M4	100	47510.040.001	M6	50	47510.060.001	M10	25	47510.100.001

47511 Nakrętki radełkowane, niskie		M01D
Gwint	Metryczny	
Materiał	Mosiądz Cu3	
Obróbka powierzchni	Niklowane	

d	☒	Kod artykułu	d	☒	Kod artykułu	d	☒	Kod artykułu
M3	100	47511.030.001	M5	50	47511.050.001	M8	25	47511.080.001
M4	100	47511.040.001	M6	50	47511.060.001	M10	25	47511.100.001

Nakrętki radełkowane, plastikowe

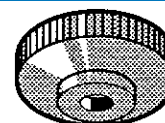
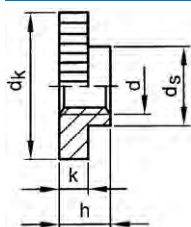

Informacje techniczne

d	dk	ds	h	k	P
M4	16	10	6	4.6	0.7
M5	16	10	6	4.6	0.8
M6	16	10	6	4.6	1

56240 Nakrętki radełkowane plastikowe		W02A
Gwint	Metryczny	
Materiał	Plastik Poliamid (nylon)	
Klasa	PA 6.6	
Kolor	Biały	

d	☒	Kod artykułu	d	☒	Kod artykułu	d	☒	Kod artykułu
M4	100	56240.040.001	M5	100	56240.050.001	M6	50	56240.060.001

Nakrętki kwadratowe, niskie

DIN 562

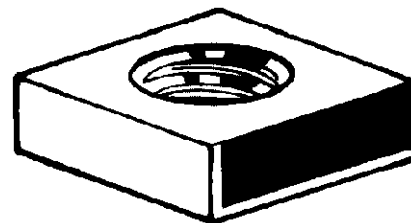
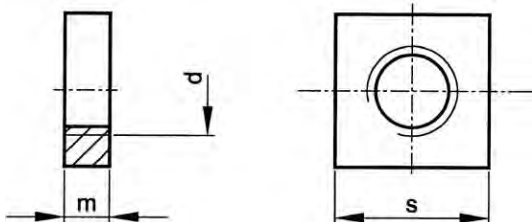

3

Informacje techniczne

d	m	P	s
M2	1.2	0.4	4
M2.5	1.6	0.45	5
M3	1.8	0.5	5.5
M4	2.2	0.7	7
M5	2.7	0.8	8
M6	3.2	1	10
M8	4	1.25	13
M10	5	1.5	16

Grupy katalogowe

Gwint	Gniazdo	Materiał	Klasa	Obróbka powierzchni	Kod	Strona
M	Kwadratowy	St	04	Ocynk.	24769	3-116
M	Kwadratowy	St	04	Ocynk.	24770	3-116 Duże Opakowanie
M	Kwadratowy	St.St. A2			51095	3-116
M	Kwadratowy	St.St. A4			55095	3-117

24769 Nakrętki kwadratowe, niskie F01X

Gwint Metryczny
 Materiał Stal
 Klasa 04
 Obróbka powierzchni Ocynkowane

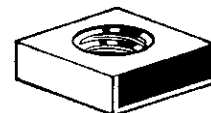

d	Kod artykułu	d	Kod artykułu	d	Kod artykułu
M3	250 24769.030.001	M5	250 24769.050.001	M8	250 24769.080.001
M4	250 24769.040.001	M6	250 24769.060.001	M10	250 24769.100.001

24770 Nakrętki kwadratowe, niskie F01X

Gwint Metryczny
 Materiał Stal
 Klasa 04
 Obróbka powierzchni Ocynkowane

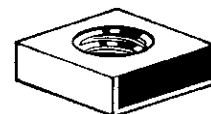

d	Kod artykułu	d	Kod artykułu	d	Kod artykułu
M3	2500 24770.030.001	M5	2500 24770.050.001	M8	1000 24770.080.001
M4	2500 24770.040.001	M6	2500 24770.060.001	M10	500 24770.100.001

51095 Nakrętki kwadratowe, niskie R09A

Gwint Metryczny
 Materiał Stal nierdzewna A2

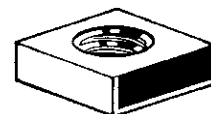

d	Kod artykułu	d	Kod artykułu	d	Kod artykułu
M2*	500 51095.020.001	M4	250 51095.040.001	M8	250 51095.080.001
M2.5*	500 51095.025.001	M5	250 51095.050.001	M10*	100 51095.100.001
M3	250 51095.030.001	M6	250 51095.060.001		

55095	Nakrętki kwadratowe, niskie				R49A
Gwint	Metryczny				
Materiał	Stal nierdzewna A4				

d	☒	Kod artykułu	d	☒	Kod artykułu	d	☒	Kod artykułu
M3	250	55095.030.001	M5	250	55095.050.001	M8	250	55095.080.001
M4	250	55095.040.001	M6	250	55095.060.001	M10*	100	55095.100.001

Nakrętki kwadratowe

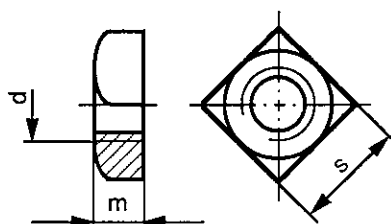

DIN 557
NF E25-404

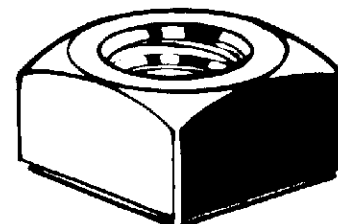

Informacje techniczne

d	m (h15)	P	s
M4 (#DIN)	3.2	0.7	7
M5	4	0.8	8
M6	5	1	10
M8	6.5	1.25	13
M10	8	1.5	17
M12	10	1.75	19

Grupy katalogowe

Gwint	Gniazdo	Materiał	Klasa	Obróbka powierzchni	Kod	Strona
M	Kwadratowy	St	≥5		11120	3-117
M	Kwadratowy	St	≥5	Ocynk.	11140	3-117
M	Kwadratowy	St.St. A2			51088	3-118
M	Kwadratowy	St.St. A4			55088	3-118

11120	Nakrętki kwadratowe				F01A
Gwint	Metryczny				
Materiał	Stal				
Klasa	≥5				

d	☒	Kod artykułu	d	☒	Kod artykułu	d	☒	Kod artykułu
M4	250	11120.040.001	M6	250	11120.060.001	M10	250	11120.100.001
M5	250	11120.050.001	M8	250	11120.080.001	M12	100	11120.120.001

11140	Nakrętki kwadratowe				F01A
Gwint	Metryczny				
Materiał	Stal				
Klasa	≥5				
Obróbka powierzchni	Ocynkowane				

d	☒	Kod artykułu	d	☒	Kod artykułu	d	☒	Kod artykułu
M4	250	11140.040.001	M6	250	11140.060.001	M10	250	11140.100.001
M5	250	11140.050.001	M8	250	11140.080.001	M12	100	11140.120.001

3

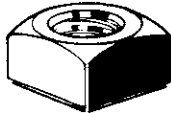

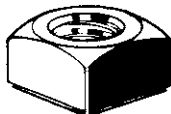
51088		Nakrętki kwadratowe				R09A	
Gwint		Metryczny					
Materiał		Stal nierdzewna A2				 	
d	☒	Kod artykułu	d	☒	Kod artykułu	d	☒
M5	200	51088.050.001	M8*	200	51088.080.001	M12*	100
M6*	200	51088.060.001	M10*	100	51088.100.001	M16*	100

55088		Nakrętki kwadratowe				R49A	
Gwint		Metryczny					
Materiał		Stal nierdzewna A4				 	
d	☒	Kod artykułu	d	☒	Kod artykułu	d	☒
M5	200	55088.050.001	M8	100	55088.080.001	M12*	100
M6	200	55088.060.001	M10	100	55088.100.001	M16*	100

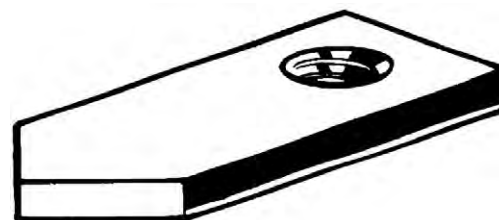
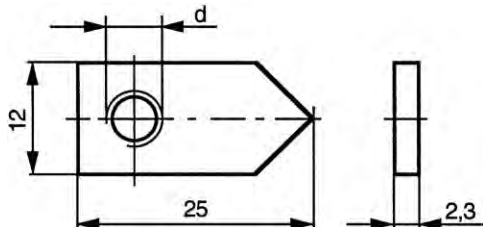
Nakrętki ostro zakończone



- Zastosowanie w kombinacji z naciętą krzyżowo śrubą grzybkową w skrzynkach lub szafkach.

24700		Nakrętki ostro zakończone				F01X	
Gwint		Metryczny					
Materiał		Stal				 	
Obróbka powierzchni		Ocynkowane					
d x P	☒	Kod artykułu					
M6X1	1000	24700.060.001					

Nakrętki koszykowe typ SMG

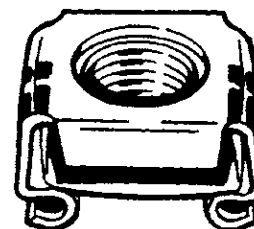
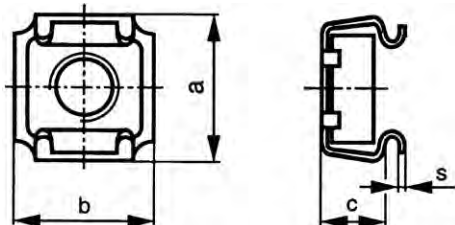

Informacje techniczne

Typ	a	b	c	Do śruby	g (tol. - 0,2mm)	Grubość materiału	r	s
M4-A	13.5	13.2	6	M4	9.5	0.7-1.6	0.5	0.5
M4-B	13.5	13.2	6	M4	9.5	1.7-2.7	0.5	0.5
M5-A	13.5	13.2	6	M5	9.5	0.7-1.6	0.5	0.5
M5-B	13.5	13.2	6	M5	9.5	1.7-2.7	0.5	0.5
M6-A	13.5	13.2	6	M6	9.5	0.7-1.6	0.5	0.5
M6-B	13.5	13.2	6	M6	9.5	1.7-2.7	0.5	0.5
M6-C	13.5	13.2	4.5	M6	9.5	1.7-2.7	0.5	0.5
M8-A	16.6	16	7.8	M8	12.3	1.0-1.7	0.5	0.6
M8-B	16.6	16	7.8	M8	12.3	1.8-3.2	0.5	0.6
M8-C	16.6	16	5.5	M8	12.3	1.8-3.2	0.5	0.6
M10-A	16.6	16	7.8	M10	12.3	1.0-1.7	0.5	0.6
M10-B	16.6	16	7.8	M10	12.3	1.8-3.2	0.5	0.6
M10-C	16.6	16	5.5	M10	12.3	1.8-3.2	0.5	0.6

Dane montażowe

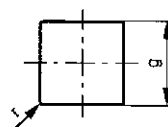
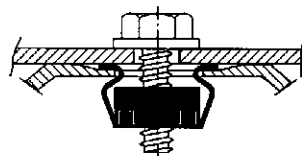

Grupy katalogowe

Gwint	Materiał	Obróbka powierzchni	Kod	Strona
M	Stal sprężynowa	Ocynk.	72350	3-119
M	St.St. A2		51128	3-119

72350 Nakrętki koszykowe typ SMG

Y93A

Gwint Metryczny
Materiał Stal sprężynowa
Obróbka powierzchni Ocynkowane

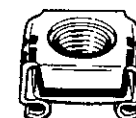

Typ	☒	Kod artykułu	Typ	☒	Kod artykułu	Typ	☒	Kod artykułu
M4 TYPE A	25	72350.040.001	M6 TYPE A	25	72350.060.001	M8 TYPE B	25	72350.080.002
M4 TYPE B	25	72350.040.002	M6 TYPE B	25	72350.060.002	M10 TYPE A	25	72350.100.001
M5 TYPE A	25	72350.050.001	M8 TYPE A	25	72350.080.001	M10 TYPE B	25	72350.100.002
M5 TYPE B	25	72350.050.002						

51128 Nakrętki koszykowe typ SMG

R05A

Gwint Metryczny
Materiał Stal nierdzewna A2

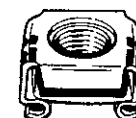

d	☒	Kod artykułu	d	☒	Kod artykułu	d	☒	Kod artykułu
M6 TYPE C*	500	51128.060.001	M8 TYPE C*	100	51128.080.001	M10 TYPE C*	100	51128.100.001

Nakrętki do szybkiego montażu typu SNU

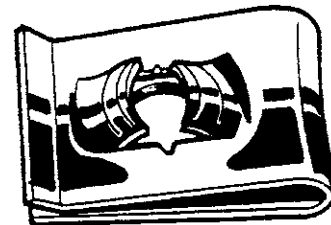
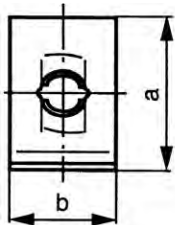

3

Informacje techniczne

Typ	a	b	c	Do śruby	Grubość materiału	s	x (min.)	y (min.)
SNU 1812	11.1	7.9	4.8	ST2.9	0.7-1.2	0.5	8.3	5.5
SNU 1219	16.4	11	6.7	ST3.5	0.7-1.6	0.6	11.4	6.1
SNU 0536	16.5	11	6.7	ST4.2	0.7-1.6	0.6	11.4	7.6
SNU 1561	24.6	11.1	15	ST4.2	0.7-1.6	0.6	11.4	10.7
SNU 0537	19.8	12.7	7.9	ST4.8	0.9-2.0	0.7	12.9	9.4
SNU 1747	12.2	16	5.5	ST4.8	0.9-1.6	0.7	-	-
SNU 0538	26.2	15.1	11.1	ST5.5	0.9-2.6	0.8	15.4	9.9
SNU 5113	27.3	14.3	13.1	ST6.3	0.8-1.8	0.9	14.7	10
SNU-M5	20.4	15	-	M5	-	0.6	-	-
SNU-M6	23.6	16	-	M6	-	0.8	-	-
SNU-M8	27.5	18	-	M8	-	1	-	-

- Ostrzeżenie: cynkowanie elektrolityczne tych produktów może wywołać kruchość wodorową.

Dane montażowe

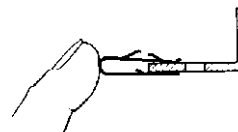
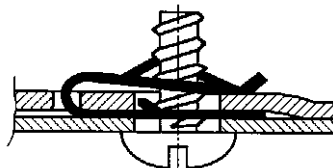
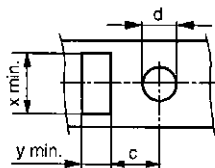

Grupy katalogowe

Gwint	Materiał	Obróbka powierzchni	Kod	Strona
M	Stal sprężynowa	Ocyнк.	72340	3-120
ST	Stal sprężynowa	Ocyнк. żłt. pas.	72293	3-120

72340 Nakrętki do szybkiego montażu typu SNU Y93A

Gwint Metryczny
 Materiał Stal sprężynowa
 Obróbka powierzchni Ocyнкowane



Typ	⊗	Kod artykułu	Typ	⊗	Kod artykułu	Typ	⊗	Kod artykułu
M5	50	72340.050.001	M6	50	72340.060.001	M8	50	72340.080.001

72293 Nakrętki do szybkiego montażu typu SNU Y93A

Gwint Samogwintujący
 Materiał Stal sprężynowa
 Obróbka powierzchni Ocyнкowane, po żółtej pasywacji



Typ	⊗	Kod artykułu	Typ	⊗	Kod artykułu	Typ	⊗	Kod artykułu
2,9MM = No.1812	100	72293.029.001	4,2MM = No.1561	50	72293.042.002	5,5MM = No.0538	50	72293.055.001
3,5MM = No.1219	100	72293.035.001	4,8MM = No.0537	50	72293.048.001	6,3MM = No.5113	50	72293.063.001
4,2MM = No.0536	50	72293.042.001	4,8MM = No.1747	50	72293.048.002			

Wkładka gwintowa Jacknut

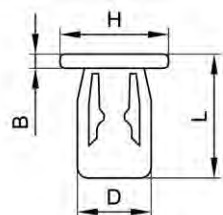

Informacje techniczne

Typ	4SJN	6SJN	8SJN
B	1.9	1.9	1.9
D	7.8	9.7	11.1
Do rozmiaru znam.	M4	M5	M6
Grubość materiału (maks.)	4.8	4.8	4.8
Grubość materiału (min.)	0.4	0.4	0.4
H	11.9	13.5	15.9
L	16.6	18.2	18.6
Moment dokręcania w Nm	1.3	2.2	3.4
Otwór $\varnothing \approx$	8.25	9.95	11.25
Siła wyciągająca w kN	1.4	2.8	4.7

- Dane montażowe: wartości ważne dla płytki stalowej 1,5mm.

Kolejność montażu

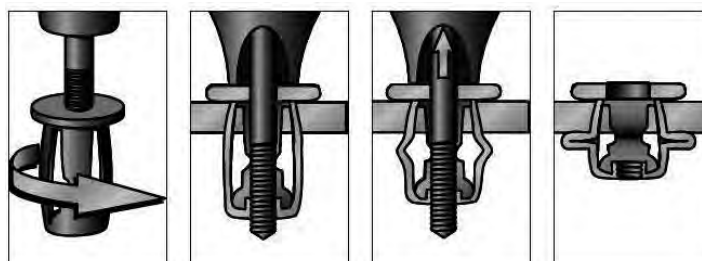

65411 Wkładka gwintowa Jacknut

N61B

Gwint Metryczny
Materiał Stal
Obróbka powierzchni Ocynkowane



Typ	☒	Kod artykułu	Typ	☒	Kod artykułu	Typ	☒	Kod artykułu
4SJN	100	65411.040.015	6SJN	100	65411.050.017	8SJN	100	65411.060.018

Nakrętki łożyskowe

DIN 1804 W

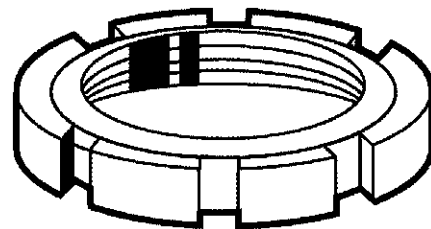
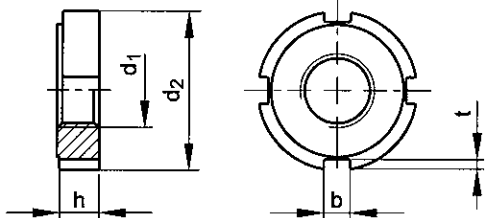

3

Informacje techniczne

d_1	b	d_2 (h11)	h (h14)	Liczba rowków	t
M10	5	25	6	4	2
M12	5	28	6	4	2
M14	5	30	7	4	2
M16	5	32	7	4	2
M18	6	34	8	4	2.5
M20	6	36	8	4	2.5
M22	6	40	9	4	2.5
M24	6	42	9	4	2.5
M26	7	45	10	4	3
M28	7	50	10	4	3
M30	7	50	10	4	3
M32	7	52	11	4	3
M35	7	55	11	4	3
M38	8	58	11	4	3.5
M40	8	62	12	4	3.5
M42	8	62	12	4	3.5
M45	8	68	12	6	3.5
M48	8	75	13	6	3.5
M50	8	75	13	6	3.5
M55	10	80	13	6	4
M58	10	90	13	6	4
M60	10	90	13	6	4
M62	10	95	14	6	4
M65	10	95	14	6	4
M68	10	100	14	6	4
M70	10	100	14	6	4
M72	10	110	14	6	4
M75	10	110	14	6	4
M80	10	115	16	6	4
M85	10	120	16	6	4
M90	10	130	16	6	4
M95	12	135	16	6	5
M100	12	145	16	6	5

- Nakrętki łożyskowe nadają się do zastosowania z podkładkami odginanymi z noskiem wewnętrznym zgodn. z DIN 462 i są łatwe w montażu przy pomocy klucza do nakrętek okrągłych z wcięciami zgodn. z DIN 1810.

Przykład zastosowania/dane montażowe

Nakrętka rowkowa okrągła do kluczy do nakrętek okrągłych z wcięciami według normy DIN 1804

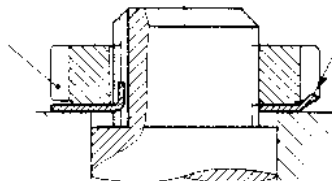

Podkładki odginane z noskiem wewnętrznym według normy DIN 462

11572	Nakrętki łożyskowe	F01X
Gwint	Metryczny drobnozwojny	
Materiał	Stal	
Klasa	[5]	

$d_1 \times P$	☒	Kod artykułu	$d_1 \times P$	☒	Kod artykułu	$d_1 \times P$	☒	Kod artykułu
M10X1,00	25	11572.100.100	M32X1,50	5	11572.320.150	M62X1,50	1	11572.620.150
M12X1,50	25	11572.120.150	M35X1,50	5	11572.350.150	M65X1,50	1	11572.650.150
M14X1,50	10	11572.140.150	M38X1,50	5	11572.380.150	M68X1,50	1	11572.680.150
M16X1,50	10	11572.160.150	M40X1,50	5	11572.400.150	M70X1,50	1	11572.700.150
M18X1,50	10	11572.180.150	M42X1,50	5	11572.420.150	M72X1,50	1	11572.720.150
M20X1,50	10	11572.200.150	M45X1,50	5	11572.450.150	M75X1,50	1	11572.750.150
M22X1,50	10	11572.220.150	M48X1,50	5	11572.480.150	M80X2,00	1	11572.800.200
M24X1,50	5	11572.240.150	M50X1,50	5	11572.500.150	M85X2,00	1	11572.850.200
M26X1,50	5	11572.260.150	M55X1,50	5	11572.550.150	M90X2,00	1	11572.900.200
M28X1,50	5	11572.280.150	M58X1,50	5	11572.580.150	M95X2,00	1	11572.950.200
M30X1,50	5	11572.300.150	M60X1,50	1	11572.600.150	M100X2,00	1	11572.982.200

3

Nakrętki rowkowe okrągłe

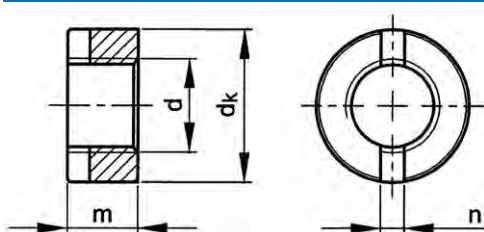
DIN 546

Informacje techniczne

d	d_k	m	n	P
M2	4.5	2	1	0.4
M2.5	5.5	2.2	1.2	0.45
M3	6	2.5	1.2	0.5
M4	8	3.5	1.4	0.7
M5	9	4.2	2	0.8
M6	11	5	2.5	1
M8	14	6.5	3	1.25
M10	18	8	3.5	1.5

• Okrągłe nakrętki rowkowe często używane są w przemyśle elektrotechnicznym i mechanicznym, łatwo je montować wkrętakiem zgodn. z DIN 3115. Fabory product group: P0044.

Grupy katalogowe

Gwint	Gniazdo	Materiał	Obróbka powierzchni	Kod	Strona
M	Szczelina	Stal automatowa	Ocynek.	11772	3-123
M	Szczelina	St.St. A1		51098	3-124
M	Szczelina	St.St. A4		55098	3-124

11772	Nakrętki rowkowe okrągłe	F01X
Gwint	Metryczny	
Materiał	Stal automatowa	
Obróbka powierzchni	Ocynkowane	

d	☒	Kod artykułu	d	☒	Kod artykułu	d	☒	Kod artykułu
M2	100	11772.020.001	M5	100	11772.050.001	M8	50	11772.080.001
M3	100	11772.030.001	M6	100	11772.060.001	M10	50	11772.100.001
M4	100	11772.040.001						

51098	Nakrętki rowkowe okrągłe	R09A
Gwint	Metryczny	
Materiał	Stal nierdzewna A1	

d	☒	Kod artykułu	d	☒	Kod artykułu	d	☒	Kod artykułu
M2*	200	51098.020.001	M4*	200	51098.040.001	M8*	100	51098.080.001
M2,5*	200	51098.025.001	M5*	200	51098.050.001	M10*	50	51098.100.001
M3*	200	51098.030.001	M6*	100	51098.060.001			

3

55098	Nakrętki rowkowe okrągłe	R49A
Gwint	Metryczny	
Materiał	Stal nierdzewna A4	

d	☒	Kod artykułu	d	☒	Kod artykułu	d	☒	Kod artykułu
M4*	200	55098.040.001	M6*	100	55098.060.001	M8*	100	55098.080.001
M5*	200	55098.050.001						

Nakrętki łączące okrągłe

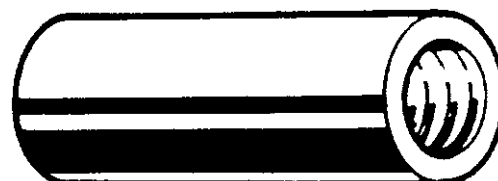
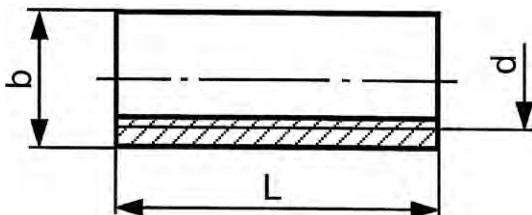

Informacje techniczne

d	b	P	d	b	P
M5	8	0.8	M12	15	1.75
M6	10	1	M16	25	2
M8	11	1.25	M20	28	2.5
M10	13	1.5			

- Te nakrętki łączące są stosowane między innymi do łączenia prętów gwintowanych.

Grupy katalogowe

Gwint	Materiał	Klasa	Obróbka powierzchni	Kod	Strona
M	Stal automatowa		Ocynk.	11401	3-124
M	St.St. A2	50		51113	3-125
M	St.St. A4	50		55113	3-125

11401	Nakrętki łączące okrągłe	F01C
Gwint	Metryczny	
Materiał	Stal automatowa	
Obróbka powierzchni	Ocynkowane	

d x L	☒	Kod artykułu	d x L	☒	Kod artykułu	d x L	☒	Kod artykułu
M5X20	100	11401.050.020	M8X30	100	11401.080.030	M10X40	100	11401.100.040
M6X20	100	11401.060.020	M8X40	100	11401.080.040	M12X20	50	11401.120.020
M6X30	100	11401.060.030	M10X20	100	11401.100.020	M12X30	50	11401.120.030
M8X20	100	11401.080.020	M10X30	100	11401.100.030	M12X40	50	11401.120.040

51113 Nakrętki łączące okrągłe		R09A
Gwint	Metryczny	
Materiał	Stal nierdzewna A2	
Klasa	50	

d x L	☒	Kod artykułu	d x L	☒	Kod artykułu	d x L	☒	Kod artykułu
M6X20*	100	51113.060.020	M8X40*	100	51113.080.040	M12X30*	50	51113.120.030
M6X25*	100	51113.060.025	M8X50*	100	51113.080.050	M12X40*	50	51113.120.040
M6X30*	100	51113.060.030	M10X20*	100	51113.100.020	M12X50*	50	51113.120.050
M8X20*	100	51113.080.020	M10X25*	100	51113.100.025	M16X40*	25	51113.160.040
M8X25*	100	51113.080.025	M10X30*	100	51113.100.030	M16X50*	25	51113.160.050
M8X30*	100	51113.080.030	M10X40*	100	51113.100.040	M20X50*	25	51113.200.050
M8X35*	100	51113.080.035						

3

55113 Nakrętki łączące okrągłe		R49A
Gwint	Metryczny	
Materiał	Stal nierdzewna A4	
Klasa	50	

d x L	☒	Kod artykułu	d x L	☒	Kod artykułu	d x L	☒	Kod artykułu
M6X25*	100	55113.060.025	M10X30*	100	55113.100.030	M16X40*	25	55113.160.040
M8X30*	100	55113.080.030	M12X30*	50	55113.120.030	M20X50*	25	55113.200.050

Nakrętki łożyskowe z niemetaliczną wkładką , typ GUK

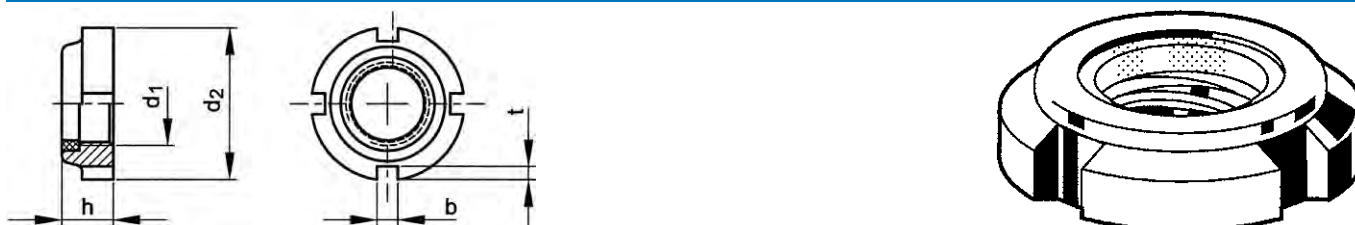

Informacje techniczne					
d ₁	b	d ₂	h	Liczba rowków	t
M10	3	18	7.4	4	2
M12	3	22	7.4	4	2
M15	4	25	8.4	4	2
M17	4	28	8.4	4	2
M20	4	32	9.4	4	2.5
M25	5	38	10.3	4	2.5
M30	5	44	10.9	4	3
M35	5	50	11.1	4	3
M40	6	56	12.1	4	3
M45	6	62	12.1	4	3.5
M50	6	68	12.7	4	3.5
M55	7	75	13.2	6	3.5
M60	7	80	13.2	6	3.5
M65	7	85	14.3	6	3.5
M70	8	92	14.3	6	4
M75	8	98	15.3	6	4
M80	10	105	16.3	8	4
M85	10	110	17.3	8	4
M90	10	120	17.5	8	5
M95	10	125	18.5	8	5
M100	10	130	19.5	8	5

11790	Nakrętki łożyskowe z niemetaliczną wkładką , typ GUK	F01X
Gwint	Metryczny drobnozwojny	
Materiał	Stal	
Obróbka powierzchni	Ocynkowane, po żółtej pasywacji	

$d_1 \times P$	☒	Kod artykułu	$d_1 \times P$	☒	Kod artykułu	$d_1 \times P$	☒	Kod artykułu
M10X0,75	10	11790.100.075	M35X1,50	5	11790.350.150	M70X2,00	1	11790.700.200
M12X1,00	10	11790.120.100	M40X1,50	5	11790.400.150	M75X2,00	1	11790.750.200
M15X1,00	10	11790.150.100	M45X1,50	2	11790.450.150	M80X2,00	1	11790.800.200
M17X1,00	10	11790.170.100	M50X1,50	2	11790.500.150	M85X2,00	1	11790.850.200
M20X1,00	10	11790.200.100	M55X2,00	1	11790.550.200	M90X2,00	1	11790.900.200
M25X1,50	5	11790.250.150	M60X2,00	1	11790.600.200	M95X2,00	1	11790.950.200
M30X1,50	5	11790.300.150	M65X2,00	1	11790.650.200	M100X2,00	1	11790.982.200

3

Nakrętki rowkowe, stożkowe płaskie

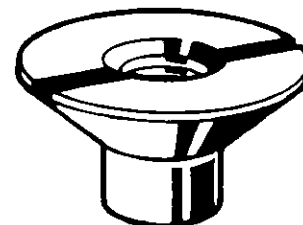
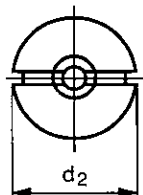
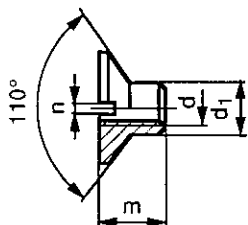

Informacje techniczne

d	d_1	d_2	m	n	P
M3	4	10	6	1	0.5
M4	5	12	6	1	0.7
M5	6	14	7	2	0.8
M6	7	16	8	2	1
M8	9	20	10	2	1.25
M10	12	24	12	2.5	1.5

• Nakrętki rowkowe, stożkowe płaskie są stosowane między innymi w połączeniach drewnianych, gdzie strona od nakrętki musi być płaska.

11560	Nakrętki rowkowe, stożkowe płaskie	F01X
Gwint	Metryczny	
Materiał	Stal automatowa	
Obróbka powierzchni	Ocynkowane	



d	☒	Kod artykułu	d	☒	Kod artykułu	d	☒	Kod artykułu
M3	250	11560.030.010	M5	250	11560.050.014	M8	250	11560.080.020
M4	250	11560.040.012	M6	250	11560.060.016	M10	250	11560.100.024

Strona informacyjna Fabory Nity zrywalne, nitonakrętki i nitośruby

Gama nitów zrywalnych, nitonakrętek i nitośrub Fabory stanowi fachowy asortyment ponad 14 różnych serii nitów, nitonakrętek i nitośrub w szerokim wyborze rozmiarów, materiałów, rodzajów łba i trzpienia, wszystkie dostępne z magazynu.



Rozmiary: M3 do M12

Materiały: aluminium, stal, stal nierdzewna (A2 i A4)

Kołnierz: cylindryczny, stożkowy, stożkowy zredukowany

Typ korpusu: okrągły, sześciokątny, otwarty, zamknięty

Średnice nitonakrętek zostały przystosowane do zastosowania standardowych średnic wiertel. Nitośruba umożliwia zewnętrzne połączenie gwintowane i jest dostępna w 4 wielkościach gwintu, każdy w 4 różnych długościach, w klasie wytrzymałości 8.8

Zalety

- Można z łatwością stosować do materiałów cienkich.
- Nie jest wymagane czasochłonne gwintowanie lub spawanie
- Nitonakrętki mają takie same właściwości jak gwint w materiale stałym ze względu na "spłaszczony kołnierz" jaki pozostaje po deformacji nitonakrętki
- Mogą być montowane z jednej strony w przypadku, gdy tył materiału i wewnątrz przedmiotu są niedostępne.
- Materiał nie ulegnie uszkodzeniu.
- Nie spowodują deformacji czy odbarwienia materiału.

Fabory narzędzia ręczne do nitonakrętek i nitośrub

Gama ręcznych narzędzi do nitonakrętek i nitośrub Fabory zapewnia ci jedną z najszerzych i najbardziej innowacyjnych ofert profesjonalnych narzędzi do nitowania dostępnych na rynku. Wszystkie nitownice ręczne Fabory są wyposażone w (opatentowany) trzpień szybkozłączny pozwalający na wymianę trzpieni gołymi rękoma bez korzystania z kluczy. Wszystkie narzędzia dostarczane są w reprezentatywnym opakowaniu w komplecie z pełnym zestawem trzpieni i dysz.

Narzędzia ręczne Fabory do nitośrub i nitonakrętek posiadają wiele wyróżniających je cech:

- Szeroki asortyment
- Wysoka, profesjonalna jakość
- Konkurencyjna cena
- Nieustanny rozwój produktu, innowacyjność
- Kompletnie narzędzia z pełnymi zestawami przeróbkowymi i urządzeniami do regulacji skoku
- System szybkiego zwalniania trzpienia

System szybkiego zwalniania do narzędzi do nitośrub i nitonakrętek

1. Odkręcić końcówkę i przeciwnakrętkę.
2. Przesunąć osłonę do przodu.
3. Przesunąć do tyłu, przytrzymać element zabezpieczający i odkręcić trzpień/złączkę.



Fabory oferuje także wysokiej jakości nitownice pneumatyczne. Szczegółowych informacji szukaj na www.fabory.com.

Nitonakrętki kołnierz walcowy, radełkowane, otwarte

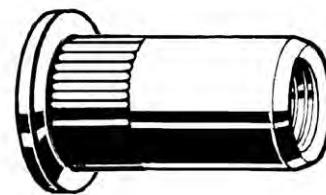
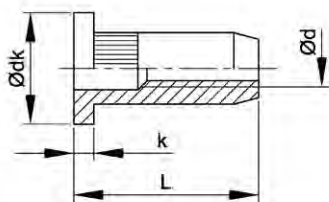

3

Informacje techniczne

Typ	k	L [+0,5/-0]	Wiertło \emptyset	Zakres	$\emptyset d$	$\emptyset d_k$
3 OCH 25	≤ 0.9	10.5	5.0	0.5-2.5	M3	7.0
3 OCH 35	≤ 0.9	11.5	5.0	2.5-3.5	M3	7.0
3 OCH 40	≤ 0.9	11.5	5.0	2.5-4.0	M3	7.0
4 OCH 30	≤ 1.1	11.0	6.0	0.5-3.0	M4	9.0
4 OCH 45	≤ 1.1	14.0	6.0	3.0-5.0	M4	9.0
4 OCH 55	≤ 1.1	14.0	6.0	3.0-5.5	M4	9.0
5 OCH 30	≤ 1.1	13.0	7.0	0.5-3.0	M5	10.0
5 OCH 55	≤ 1.1	16.0	7.0	3.0-5.5	M5	10.0
5 OCH 80	≤ 1.1	19.0	7.0	5.5-8.0	M5	10.0
6 OCH 30	≤ 1.6	16.0	9.0	0.5-3.0	M6	12.0
6 OCH 55	≤ 1.6	18.5	9.0	3.0-5.5	M6	12.0
6 OCH 80	≤ 1.6	21.0	9.0	5.5-8.0	M6	12.0
8 OCH 30	≤ 1.6	17.5	11.0	0.5-3.0	M8	15.0
8 OCH 55	≤ 1.6	20.0	11.0	3.0-5.5	M8	15.0
8 OCH 80	≤ 1.6	22.5	11.0	5.5-9.0	M8	15.0
8 OCH 105	≤ 1.6	25.0	11.0	8.0-10.5	M8	15.0
10 OCH 30	≤ 2.1	19.0	12.0	0.5-3.0	M10	16.0
10 OCH 60	≤ 2.1	24.0	12.0	3.0-6.0	M10	16.0
10 OCH 90	≤ 2.1	27.0	12.0	6.0-9.0	M10	16.0
10 OCH 120	≤ 2.1	30.0	12.0	9.0-12.0	M10	16.0
12 OCH 40	≤ 2.1	25.0	16.0	1.0-4.0	M12	22.0
12 OCH 70	≤ 2.1	28.0	16.0	4.0-7.0	M12	22.0
12 OCH 100	≤ 2.1	31.0	16.0	7.0-10.0	M12	22.0

Grupy katalogowe

Material	Obróbka powierzchni	Kod	Strona
St	Ocynk.	69135	3-128
St.St. A4		69526	3-129
Al		69315	3-129



69135 Nitonakrętki ocynkowane, kołnierz walcowy, radełkowane, otwarte

F07A

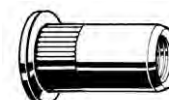

Material Stal
Obróbka powierzchni Ocynkowane

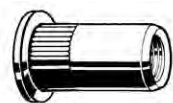

Typ	☒	Kod artykułu	Typ	☒	Kod artykułu	Typ	☒	Kod artykułu
3 OCH 25	250	69135.030.025	6 OCH 30	250	69135.060.030	10 OCH 30	250	69135.100.030
3 OCH 40	250	69135.030.040	6 OCH 55	250	69135.060.055	10 OCH 60	250	69135.100.060
4 OCH 30	250	69135.040.030	6 OCH 80	250	69135.060.080	10 OCH 90	100	69135.100.090
4 OCH 55	250	69135.040.055	8 OCH 30	250	69135.080.030	10 OCH 120	100	69135.100.120
5 OCH 30	250	69135.050.030	8 OCH 55	250	69135.080.055	12 OCH 40	100	69135.120.040
5 OCH 55	250	69135.050.055	8 OCH 80	250	69135.080.080	12 OCH 70	100	69135.120.070
5 OCH 80	250	69135.050.080	8 OCH 105	250	69135.080.105	12 OCH 100	100	69135.120.100

69526	Nitonakrętki nierdzewne A4, kołnierz walcowy, radełkowane, otwarte						F07A
Materiał	Stal nierdzewna A4						
							

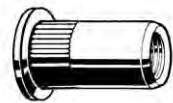
Typ	☒	Kod artykułu	Typ	☒	Kod artykułu	Typ	☒	Kod artykułu
5OCH30	250	69526.050.030	6OCH30	250	69526.060.030	8OCH30	250	69526.080.030



69315	Nitonakrętki aluminium, kołnierz walcowy, radełkowane, otwarte						F07A
Materiał	Aluminium						
							

Typ	☒	Kod artykułu	Typ	☒	Kod artykułu	Typ	☒	Kod artykułu
3 OCH 25	250	69315.030.025	6 OCH 30	250	69315.060.030	10 OCH 30	250	69315.100.030
3 OCH 35	250	69315.030.035	6 OCH 55	250	69315.060.055	10 OCH 60	250	69315.100.060
4 OCH 30	250	69315.040.030	6 OCH 80	250	69315.060.080	10 OCH 90	100	69315.100.090
4 OCH 45	250	69315.040.045	8 OCH 30	250	69315.080.030	10 OCH 120	100	69315.100.120
5 OCH 30	250	69315.050.030	8 OCH 55	250	69315.080.055	12 OCH 40	100	69315.120.040
5 OCH 55	250	69315.050.055	8 OCH 80	250	69315.080.080	12 OCH 70	100	69315.120.070
5 OCH 80	250	69315.050.080	8 OCH 105	250	69315.080.105	12 OCH 100	100	69315.120.100

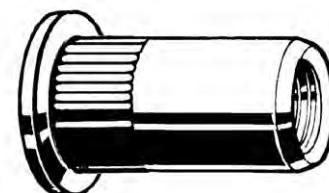
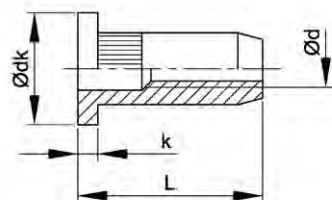
Nitonakrętki nierdzewne, kołnierz walcowy, radełkowane, otwarte

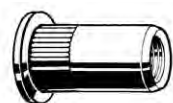

Informacje techniczne						
Typ	k	L [+0,5/-0]	Wiertło ø	Zakres	ø d	ø d _k
4 OCH 30	≤ 1.1	11.0	6.0	0.5-3.0	M4	9.0
4 OCH 45	≤ 1.1	14.0	6.0	3.0-4.5	M4	9.0
5 OCH 30	≤ 1.1	13.0	7.0	0.5-3.0	M5	10.0
5 OCH 55	≤ 1.1	16.0	7.0	3.0-5.5	M5	10.0
5 OCH 80	≤ 1.1	19.0	7.0	5.5-8.0	M5	10.0
6 OCH 30	≤ 1.6	16.0	9.0	0.5-3.0	M6	12.0
6 OCH 55	≤ 1.6	18.5	9.0	3.0-5.5	M6	12.0
8 OCH 30	≤ 1.6	17.5	11.0	0.5-3.0	M8	15.0
8 OCH 55	≤ 1.6	20.0	11.0	3.0-5.5	M8	15.0
10 OCH 30	≤ 2.1	19.0	13.0	0.5-3.0	M10	16.0
10 OCH 60	≤ 2.1	24.0	13.0	3.0-6.0	M10	16.0

69025	Nitonakrętki nierdzewne A2, kołnierz walcowy, radełkowane, otwarte						F07A
Materiał	Stal nierdzewna A2						
							

Typ	☒	Kod artykułu	Typ	☒	Kod artykułu	Typ	☒	Kod artykułu
4 OCH 30	250	69025.040.030	5 OCH 80	250	69025.050.080	8 OCH 55	250	69025.080.055
4 OCH 45	250	69025.040.045	6 OCH 30	250	69025.060.030	10 OCH 30	250	69025.100.030
5 OCH 30	250	69025.050.030	6 OCH 55	250	69025.060.055	10 OCH 60	250	69025.100.060
5 OCH 55	250	69025.050.055	8 OCH 30	250	69025.080.030			

Nitonakrętki, kołnierz walcowy, częściowo sześciokątne, otwarte

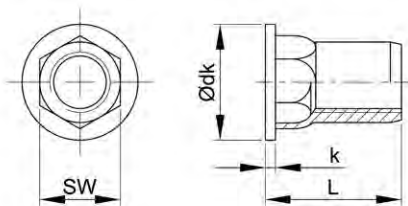

3

Informacje techniczne

Typ	dk \varnothing	k	l [+0,5/-0]	Otwór sześciokątny	Zakres	\varnothing d
4 OCH 30	9	1.1	11	6	0.5-3.0	M4
5 OCH 30	10	1.1	13	7	0.5-3.0	M5
6 OCH 30	12	1.6	16	9	0.5-3.0	M6
8 OCH 30	15	1.6	17.5	11	0.5-3.0	M8
10 OCH 30	16	2.1	19	12	0.5-3.0	M10

Grupy katalogowe

Materiał	Obróbka powierzchni	Kod	Strona
St	Ocynk.	69400	3-130
St.St. A2		69407	3-130

69400 Nitonakrętki ocynkowane, kołnierz walcowy, częściowo sześciokątne, otwarte

F07A

Materiał Stal
Obróbka powierzchni Ocynkowane



Typ	⊠	Kod artykułu	Typ	⊠	Kod artykułu	Typ	⊠	Kod artykułu
4OCH30	250	69400.040.030	6OCH30	250	69400.060.030	10OCH30	250	69400.100.030
5OCH30	250	69400.050.030	8OCH30	250	69400.080.030			

69407 Nitonakrętki nierdzewne, kołnierz walcowy, częściowo sześciokątne, otwarte

F07A

Materiał Stal nierdzewna A2



Typ	⊠	Kod artykułu	Typ	⊠	Kod artykułu	Typ	⊠	Kod artykułu
4OCH30	250	69407.040.030	6OCH30	250	69407.060.030	10OCH30	250	69407.100.030
5OCH30	250	69407.050.030	8OCH30	250	69407.080.030			

Nitonakrętki ocynkowane, kołnierz stożkowy, radełkowane, otwarte

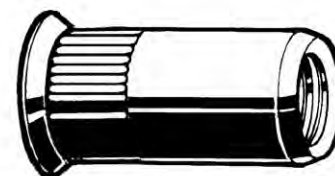
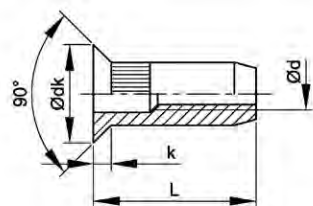

Informacje techniczne

Typ	k	L [+0,5/-0]	Wiertło ø	Zakres	ø d	ø d _k
3 OCSH 35	≤ 1.5	11.5	5.0	1.5-3.5	M3	7.5
3 OCSH 50	≤ 1.5	12.5	5.0	3.5-5.0	M3	7.5
4 OCSH 40	≤ 1.5	12.5	6.0	1.5-4.0	M4	8.5
4 OCSH 65	≤ 1.5	15.0	6.0	4.0-6.5	M4	8.5
5 OCSH 40	≤ 1.5	13.5	7.0	1.5-4.0	M5	9.5
5 OCSH 65	≤ 1.5	16.0	7.0	4.0-6.5	M5	9.5
5 OCSH 90	≤ 1.5	18.5	7.0	6.5-9.0	M5	9.5
6 OCSH 40	≤ 1.5	15.5	9.0	1.4-4.0	M6	11.5
6 OCSH 65	≤ 1.5	18.0	9.0	4.0-6.5	M6	11.5
6 OCSH 90	≤ 1.5	20.5	9.0	6.5-9.0	M6	11.5
8 OCSH 40	≤ 1.5	18.5	11.0	1.5-4.0	M8	13.5
8 OCSH 65	≤ 1.5	21.0	11.0	4.0-6.5	M8	13.5
8 OCSH 90	≤ 1.5	23.5	11.0	6.5-9.0	M8	13.5
10 OCSH 45	≤ 1.7	21.0	12.0	2.0-4.5	M10	14.5
10 OCSH 75	≤ 1.7	24.0	12.0	4.5-7.5	M10	14.5
10 OCSH 105	≤ 1.7	27.0	12.0	7.5-10.5	M10	14.5
12 OCSH 45	≤ 1.9	24.5	16.0	2.0-4.5	M12	19.0
12 OCSH 75	≤ 1.9	27.5	16.0	4.5-7.5	M12	19.0
12 OCSH 105	≤ 1.9	31.0	16.0	7.5-10.5	M12	19.0

69155 Nitonakrętki ocynkowane, kołnierz stożkowy, radełkowane, otwarte

F07A

Materiał Stal
Obróbka powierzchni Ocynkowane

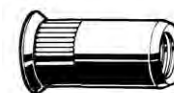

Typ	☒	Kod artykułu	Typ	☒	Kod artykułu	Typ	☒	Kod artykułu
3 OCSH 35	250	69155.030.035	6 OCSH 40	250	69155.060.040	10 OCSH 45	250	69155.100.045
3 OCSH 50	250	69155.030.050	6 OCSH 65	250	69155.060.065	10 OCSH 75	250	69155.100.075
4 OCSH 40	250	69155.040.040	6 OCSH 90	250	69155.060.090	10 OCSH 105	100	69155.100.105
4 OCSH 65	250	69155.040.065	8 OCSH 40	250	69155.080.040	12 OCSH 45	100	69155.120.045
5 OCSH 40	250	69155.050.040	8 OCSH 65	250	69155.080.065	12 OCSH 75	100	69155.120.075
5 OCSH 65	250	69155.050.065	8 OCSH 90	250	69155.080.090	12 OCSH 105	100	69155.120.105
5 OCSH 90	250	69155.050.090						

Nitonakrętki nierdzewne, kołnierz stożkowy, otwarte

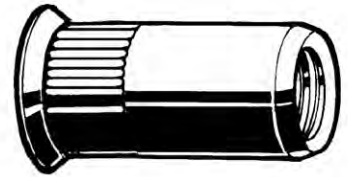
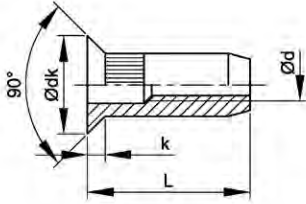

3

Informacje techniczne

Typ	k	L [+0,5/-0]	Wiertło \varnothing	Zakres	$\varnothing d$	$\varnothing d_k$
4 OCSH 40	≤ 1.5	12.5	6.0	1.5-4.0	M4	8.5
5 OCSH 40	≤ 1.5	13.5	7.0	1.5-4.0	M5	9.5
6 OCSH 40	≤ 1.5	15.5	9.0	1.5-4.0	M6	11.5
8 OCSH 40	≤ 1.5	18.5	11.0	1.5-4.0	M8	13.5
10 OCSH 45	≤ 1.8	21.0	13.0	2.0-4.5	M10	15.5

Grupy katalogowe

Materiał	Kod	Strona
St.St. A2	69045	3-132
St.St. A4	69525	3-132

69045 Nitonakrętki nierdzewne, kołnierz stożkowy, radełkowane, otwarte

F07A

Materiał Stal nierdzewna A2

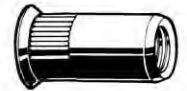

Typ	⊠	Kod artykułu	Typ	⊠	Kod artykułu	Typ	⊠	Kod artykułu
4 OCSH 40	250	69045.040.040	6 OCSH 40	250	69045.060.040	10 OCSH 45	250	69045.100.045
5 OCSH 40	250	69045.050.040	8 OCSH 40	250	69045.080.040			

69525 Nitonakrętki nierdzewne, kołnierz stożkowy, gładkie, otwarte

F07A

Materiał Stal nierdzewna A4



Typ	⊠	Kod artykułu	Typ	⊠	Kod artykułu	Typ	⊠	Kod artykułu
5OCSH40	250	69525.050.040	6OCSH40	250	69525.060.040	8OCSH40	250	69525.080.040

Nitonakrętki aluminium, kołnierz stożkowy, radełkowane, otwarte

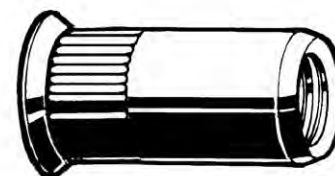
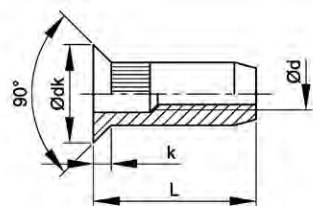

Informacje techniczne

Typ	k	L [+0,5/-0]	Wiercio \emptyset	Zakres	$\emptyset d$	$\emptyset d_k$
3 OCSH 35	≤ 1.5	11.5	5.0	1.5-3.5	M3	7.5
3 OCSH 45	≤ 1.5	12.5	5.0	3.5-4.5	M3	7.5
4 OCSH 40	≤ 1.5	12.5	6.0	1.5-4.0	M4	8.5
4 OCSH 55	≤ 1.5	15.0	6.0	4.0-5.5	M4	8.5
5 OCSH 40	≤ 1.5	13.5	7.0	1.5-4.0	M5	9.5
5 OCSH 65	≤ 1.5	16.0	7.0	4.0-6.5	M5	9.5
5 OCSH 90	≤ 1.5	18.5	7.0	6.5-9.0	M5	9.5
6 OCSH 40	≤ 1.5	15.5	9.0	1.5-4.0	M6	11.5
6 OCSH 65	≤ 1.5	18.0	9.0	4.0-6.5	M6	11.5
6 OCSH 90	≤ 1.5	20.5	9.0	6.5-9.0	M6	11.5
8 OCSH 40	≤ 1.5	18.5	11.0	1.5-4.0	M8	13.5
8 OCSH 65	≤ 1.5	21.0	11.0	4.0-6.5	M8	13.5
8 OCSH 90	≤ 1.5	23.5	11.0	6.5-9.0	M8	13.5
10 OCSH 45	≤ 1.7	21.0	12.0	2.0-4.5	M10	14.5
10 OCSH 75	≤ 1.7	24.0	12.0	4.5-7.5	M10	14.5
10 OCSH 105	≤ 1.7	27.0	12.0	7.5-10.5	M10	14.5
12 OCSH 45	≤ 1.9	24.5	16.0	2.0-4.5	M12	19.0
12 OCSH 75	≤ 1.9	27.5	16.0	4.5-7.5	M12	19.0
12 OCSH 105	≤ 1.9	31.0	16.0	7.5-10.5	M12	19.0

69335 Nitonakrętki aluminium, kołnierz stożkowy, radełkowane, otwarte

F07A

Materiał Aluminium

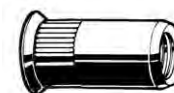

Typ	☒	Kod artykułu	Typ	☒	Kod artykułu	Typ	☒	Kod artykułu
3 OCSH 35	250	69335.030.035	6 OCSH 40	250	69335.060.040	10 OCSH 45	250	69335.100.045
3 OCSH 45	250	69335.030.045	6 OCSH 65	250	69335.060.065	10 OCSH 75	250	69335.100.075
4 OCSH 40	250	69335.040.040	6 OCSH 90	250	69335.060.090	10 OCSH 105	100	69335.100.105
4 OCSH 55	250	69335.040.055	8 OCSH 40	250	69335.080.040	12 OCSH 45	100	69335.120.045
5 OCSH 40	250	69335.050.040	8 OCSH 65	250	69335.080.065	12 OCSH 75	100	69335.120.075
5 OCSH 65	250	69335.050.065	8 OCSH 90	250	69335.080.090	12 OCSH 105	100	69335.120.105
5 OCSH 90	250	69335.050.090						

Nitonakrętki ocynkowane, mini kołnierz stożkowy, radełkowane, otwarte

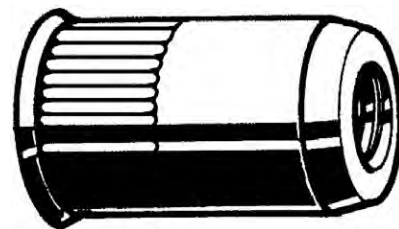
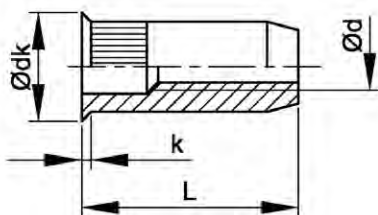

3

Informacje techniczne

Typ	k	L [+0,5/-0]	Wierćto ø	Zakres	ø d	ø d _k
3 ORCSH 25	≤ 0.7	9.5	5.0	0.5-2.5	M3	6.0
4 ORCSH 30	≤ 0.7	10.0	6.0	0.5-3.0	M4	7.0
5 ORCSH 30	≤ 0.7	11.5	7.0	0.5-3.0	M5	8.0
6 ORCSH 30	≤ 0.7	14.0	9.0	0.5-3.0	M6	10.0
8 ORCSH 30	≤ 0.7	15.0	11.0	0.5-3.0	M8	12.0
10 ORCSH 35	≤ 0.9	19.5	12.0	0.8-3.5	M10	13.5

69435 Nitonakrętki ocynkowane, mini kołnierz stożkowy, radełkowane, otwarte

F07A

Materiał Stal
Obróbka powierzchni Ocynkowane

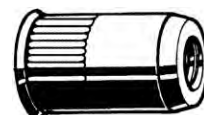

Typ	☒	Kod artykułu	Typ	☒	Kod artykułu	Typ	☒	Kod artykułu
3 ORCSH 25	250	69435.030.025	5 ORCSH 30	250	69435.050.030	8 ORCSH 30	250	69435.080.030
4 ORCSH 30	250	69435.040.030	6 ORCSH 30	250	69435.060.030	10 ORCSH 35	250	69435.100.035

Nitonakrętki nierdzewne, mini kołnierz stożkowy, radełkowane, otwarte

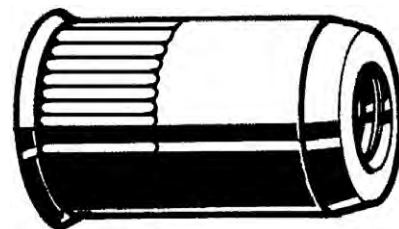
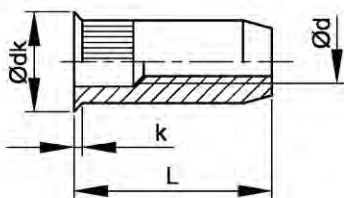

Informacje techniczne

Typ	dk ø	k	L [+0,5/-0]	Wierćto ø	Zakres	ø d
4 ORCSH 30	7	0.9	10	6	0.5-3.0	M4
5 ORCSH 30	8	0.9	11.5	7	0.5-3.0	M5
6 ORCSH 30	10	0.9	14	9	0.5-3.0	M6
8 ORCSH 30	12	0.9	15.5	11	0.5-3.0	M8
10 ORCSH 35	14.5	1.1	19.5	13	0.8-3.5	M10

69035 Nitonakrętki nierdzewne, mini kołnierz stożkowy, radełkowane, otwarte

F07A

Materiał Stal nierdzewna A2

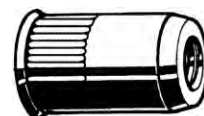

Typ	☒	Kod artykułu	Typ	☒	Kod artykułu	Typ	☒	Kod artykułu
4ORCSH30	250	69035.040.030	6ORCSH30	250	69035.060.030	10ORCSH35	250	69035.100.035
5ORCSH30	250	69035.050.030	8ORCSH30	250	69035.080.030			

Nitonakrętki aluminium, mini kołnierz stożkowy, radełkowane, otwarte

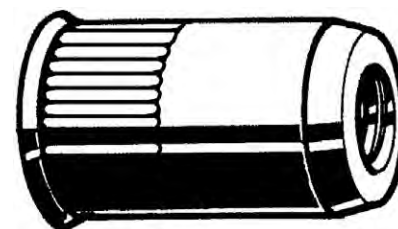
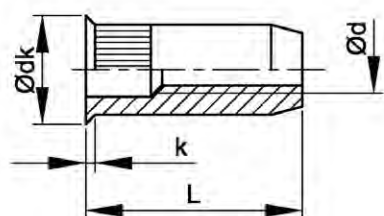

Informacje techniczne

Typ	dk \varnothing	k	L [+0,5/-0]	Wiertło \varnothing	Zakres	\varnothing d
3 ORCSH 25	6	0.7	9.5	5	0.5-2.5	M3
4 ORCSH 30	7	0.7	10	6	0.5-3.0	M4
5 ORCSH 30	8	0.7	11.5	7	0.5-3.0	M5
6 ORCSH 30	10	0.7	14	9	0.5-3.0	M6
8 ORCSH 30	12	0.7	15.5	11	0.5-3.0	M8

3

69445 Nitonakrętki aluminium, mini kołnierz stożkowy, radełkowane, otwarte

F07A

Materiał Aluminium

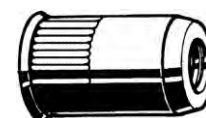

Typ	⊠	Kod artykułu	Typ	⊠	Kod artykułu	Typ	⊠	Kod artykułu
3ORCSH25	250	69445.030.025	5ORCSH30	250	69445.050.030	8ORCSH30	250	69445.080.030
4ORCSH30	250	69445.040.030	6ORCSH30	250	69445.060.030			

Nitonakrętki ocynkowane, mini kołnierz stożkowy, częściowo 6-kątne, otwarte

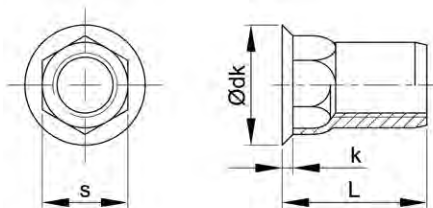

Informacje techniczne

Typ	k	l [+0,5/-0]	Otwór sześciokątny	W.p.k (s)	Zakres	\varnothing d	\varnothing d _k
3 ORCSH 25	≤ 0.8	10.5	5.1	5.0	0.5-2.5	M3	6.5
4 ORCSH 30	≤ 0.8	12.5	6.1	6.0	0.5-3.0	M4	7.0
5 ORCSH 30	≤ 0.8	14.0	7.1	7.0	0.5-3.0	M5	8.0
6 ORCSH 30	≤ 0.8	16.0	9.1	9.0	0.5-3.0	M6	10.0
8 ORCSH 30	≤ 0.8	17.0	11.1	11.0	0.5-3.0	M8	12.0
10 ORCSH 35	≤ 0.8	20.5	13.1	13.0	0.8-3.5	M10	14.5

69450 Nitonakrętki ocynkowane, mini kołnierz stożkowy, częściowo 6-kątne, otwarte

F07A

Materiał Stal
Obróbka powierzchni Ocynkowane



Typ	⊠	Kod artykułu	Typ	⊠	Kod artykułu	Typ	⊠	Kod artykułu
3 ORCSH 25	250	69450.030.025	5 ORCSH 30	250	69450.050.030	8 ORCSH 30	250	69450.080.030
4 ORCSH 30	250	69450.040.030	6 ORCSH 30	250	69450.060.030	10 ORCSH 35	250	69450.100.035

Nitonakrętki nierdzewne, mini kołnierz stożkowy, częściowo 6-kątne, otwarte

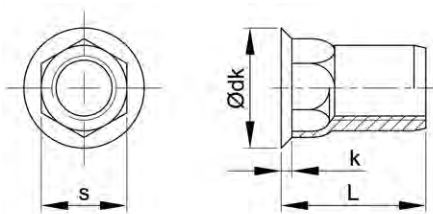

3

Informacje techniczne

Typ	k	l [+0,5/-0]	Otwór sześciokątny	W.p.k (s)	Zakres	Ø d	Ø d _k
4 ORCSH 30	≤ 0.9	12.5	6.1	6.0	0.5-3.0	M4	7.0
5 ORCSH 30	≤ 0.9	14.0	7.1	7.0	0.5-3.0	M5	8.0
6 ORCSH 30	≤ 0.9	16.0	9.1	9.0	0.5-3.0	M6	10.0
8 ORCSH 30	≤ 0.9	17.0	11.1	11.0	0.5-3.0	M8	12.0
10 ORCSH 35	≤ 1.1	20.5	13.1	13.0	0.8-6.5	M10	14.5

69440 Nitonakrętki nierdzewne, mini kołnierz stożkowy, częściowo 6-kątne, otwarte

F07A

Materiał Stal nierdzewna A2



Typ	⊠	Kod artykułu	Typ	⊠	Kod artykułu	Typ	⊠	Kod artykułu
4 ORCSH 30	250	69440.040.030	6 ORCSH30	250	69440.060.030	10 ORCSH 35	250	69440.100.035
5 ORCSH 30	250	69440.050.030	8 ORCSH 30	250	69440.080.030			

Nitonakrętki ocynkowane, kołnierz walcowy, radełkowane, zamknięte

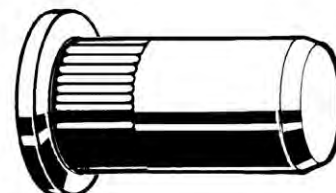
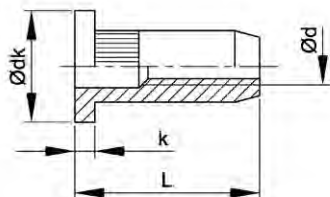

Informacje techniczne

Typ	k	L [+0,5/-0]	Wiertło Ø	Zakres	Ø d	Ø d _k
3 CCH 25	≤ 0.9	15.0	5.0	0.5-2.5	M3	7.0
3 CCH 40	≤ 0.9	16.0	5.0	2.0-4.0	M3	7.0
4 CCH 30	≤ 1.1	16.0	6.0	0.5-3.0	M4	9.0
4 CCH 55	≤ 1.1	19.0	6.0	3.0-5.5	M4	9.0
5 CCH 30	≤ 1.1	18.5	7.0	0.5-3.0	M5	10.0
5 CCH 55	≤ 1.1	21.5	7.0	3.0-5.5	m5	10.0
5 CCH 80	≤ 1.1	24.5	7.0	5.5-8.0	M5	10.0
6 CCH 30	≤ 1.6	21.5	9.0	0.5-3.0	M6	12.0
6 CCH 55	≤ 1.6	24.0	9.0	3.0-5.5	M6	12.0
6 CCH 80	≤ 1.6	26.5	9.0	5.5-8.0	M6	12.0
8 CCH 30	≤ 1.6	26.0	11.0	0.5-3.0	M8	15.0
8 CCH 55	≤ 1.6	28.5	11.0	3.0-5.5	M8	15.0
8 CCH 80	≤ 1.6	31.0	11.0	5.5-8.0	M8	15.0
8 CCH 105	≤ 1.6	33.5	11.0	8.0-10.5	M8	15.0
10 CCH 30	≤ 2.1	28.0	12.0	0.5-3.0	M10	16.0
10 CCH 60	≤ 2.1	33.0	12.0	3.0-6.0	M10	16.0
10 CCH 90	≤ 2.1	36.0	12.0	6.0-9.0	M10	16.0
10 CCH 120	≤ 2.1	39.0	12.0	9.0-12.0	M10	16.0

69190 Nitonakrętki ocynkowane, kołnierz walcowy, radełkowane, zamknięte F07A

Material: Stal
Obróbka powierzchni: Ocynkowane

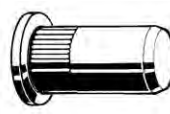
Typ	☒	Kod artykułu	Typ	☒	Kod artykułu	Typ	☒	Kod artykułu
3 CCH 25	250	69190.030.025	5 CCH 80	250	69190.050.080	8 CCH 80	250	69190.080.080
3 CCH 40	250	69190.030.040	6 CCH 30	250	69190.060.030	8 CCH 105	250	69190.080.105
4 CCH 30	250	69190.040.030	6 CCH 55	250	69190.060.055	10 CCH 30	250	69190.100.030
4 CCH 55	250	69190.040.055	6 CCH 80	250	69190.060.080	10 CCH 60	250	69190.100.060
5 CCH 30	250	69190.050.030	8 CCH 30	250	69190.080.030	10 CCH 90	100	69190.100.090
5 CCH 55	250	69190.050.055	8 CCH 55	250	69190.080.055	10 CCH 120	100	69190.100.120

3

Nitonakrętki aluminium, kołnierz walcowy, radełkowane, zamknięte

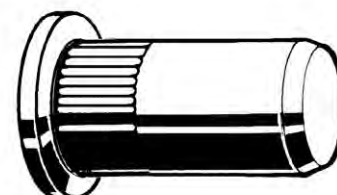
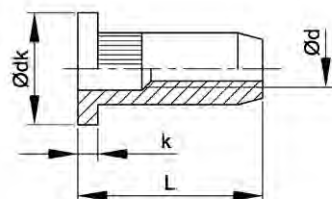

Informacje techniczne

Typ	k	L [+0,5/-0]	Wiertło ø	Zakres	ø d	ø d _k
3 CCH 25	≤ 0.9	15.0	5.0	0.5-2.5	M3	7.0
3 CCH 35	≤ 0.9	16.0	5.0	2.5-3.5	M3	7.0
4 CCH 30	≤ 1.1	16.0	6.0	0.5-3.0	M4	9.0
4 CCH 45	≤ 1.1	19.0	6.0	3.0-4.5	M4	9.0
5 CCH 30	≤ 1.1	18.5	7.0	0.5-3.0	M5	10.0
5 CCH 55	≤ 1.1	21.5	7.0	3.0-5.5	M5	10.0
5 CCH 80	≤ 1.1	24.5	7.0	5.5-8.0	M5	10.0
6 CCH 30	≤ 1.6	21.5	9.0	0.5-3.0	M6	12.0
6 CCH 55	≤ 1.6	24.0	9.0	3.0-5.5	M6	12.0
6 CCH 80	≤ 1.6	26.5	9.0	5.5-8.0	M6	12.0
8 CCH 30	≤ 1.6	26.0	11.0	0.5-3.0	M8	15.0
8 CCH 55	≤ 1.6	28.5	11.0	3.0-5.5	M8	15.0
8 CCH 80	≤ 1.6	31.0	11.0	5.5-8.0	M8	15.0
8 CCH 105	≤ 1.6	33.5	11.0	8.0-10.5	M8	15.0
10 CCH 30	≤ 2.1	28.0	12.0	0.5-3.0	M10	16.0
10 CCH 60	≤ 2.1	33.0	12.0	3.0-6.0	M10	16.0
10 CCH 90	≤ 2.1	36.0	12.0	6.0-9.0	M10	16.0
10 CCH 120	≤ 2.1	39.0	12.0	9.0-10.5	M10	16.0

69355 Nitonakrętki aluminium, kołnierz walcowy, radełkowane, zamknięte F07A

Material: Aluminium



Typ	☒	Kod artykułu	Typ	☒	Kod artykułu	Typ	☒	Kod artykułu
3 CCH 25	250	69355.030.025	5 CCH 80	250	69355.050.080	8 CCH 80	250	69355.080.080
3 CCH 35	250	69355.030.035	6 CCH 30	250	69355.060.030	8 CCH 105	250	69355.080.105
4 CCH 30	250	69355.040.030	6 CCH 55	250	69355.060.055	10 CCH 30	250	69355.100.030
4 CCH 45	250	69355.040.045	6 CCH 80	250	69355.060.080	10 CCH 60	250	69355.100.060
5 CCH 30	250	69355.050.030	8 CCH 30	250	69355.080.030	10 CCH 90	100	69355.100.090
5 CCH 55	250	69355.050.055	8 CCH 55	250	69355.080.055	10 CCH 120	100	69355.100.120

Nitonakrętki ocynkowane, kołnierz stożkowy, radełkowane, zamknięte

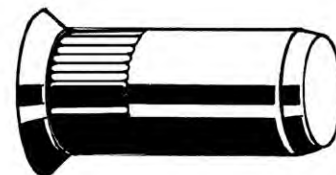
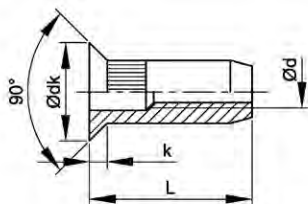

3

Informacje techniczne

Typ	k	L [+0,5/-0]	Wiertło \varnothing	Zakres	$\varnothing d$	$\varnothing d_k$
3 CESH 35	≤ 1.5	16.0	5.0	1.5-3.5	M3	7.5
3 CESH 50	≤ 1.5	17.0	5.0	3.5-5.0	M3	7.5
4 CESH 40	≤ 1.5	17.5	6.0	1.5-4.0	M4	8.5
4 CESH 65	≤ 1.5	20.0	6.0	4.0-6.5	M4	8.5
5 CESH 40	≤ 1.5	20.0	7.0	1.5-4.0	M5	9.5
5 CESH 65	≤ 1.5	22.5	7.0	4.0-6.5	M5	9.5
5 CESH 90	≤ 1.5	25.0	7.0	6.5-9.0	M5	9.5
6 CESH 40	≤ 1.5	23.0	8.0	1.5-4.0	M6	11.5
6 CESH 65	≤ 1.5	25.5	8.0	4.0-6.5	M6	11.5
6 CESH 90	≤ 1.5	28.0	8.0	6.5-9.0	M6	11.5
8 CESH 40	≤ 1.5	27.0	11.0	1.5-4.0	M8	13.5
8 CESH 65	≤ 1.5	29.5	11.0	4.0-6.5	M8	13.5
8 CESH 90	≤ 1.5	32.0	11.0	6.5-9.0	M8	13.5
10 CESH 45	≤ 1.7	30.0	12.0	2.0-4.5	M10	14.5
10 CESH 75	≤ 1.7	33.0	12.0	4.5-7.5	M10	14.5
10 CESH 105	≤ 1.7	36.0	12.0	7.5-10.5	M10	14.5
12 CESH 45	≤ 1.9	34.5	16.0	2.0-4.5	M12	19.0
12 CESH 75	≤ 1.9	37.5	16.0	4.5-7.5	M12	19.0
12 CESH 110	≤ 1.9	41.0	16.0	7.5-11.0	M12	19.0

69195 Nitonakrętki ocynkowane, kołnierz stożkowy, radełkowane, zamknięte

F07A

Materiał Stal
Obróbka powierzchni Ocynkowane

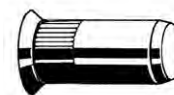

Typ	☒	Kod artykułu	Typ	☒	Kod artykułu	Typ	☒	Kod artykułu
3 CESH 35	250	69195.030.035	6 CESH 40	250	69195.060.040	10 CESH 45	250	69195.100.045
3 CESH 50	250	69195.030.050	6 CESH 65	250	69195.060.065	10 CESH 75	250	69195.100.075
4 CESH 40	250	69195.040.040	6 CESH 90	250	69195.060.090	10 CESH 105	100	69195.100.105
4 CESH 65	250	69195.040.065	8 CESH 40	250	69195.080.040	12 CESH 45	100	69195.120.045
5 CESH 40	250	69195.050.040	8 CESH 65	250	69195.080.065	12 CESH 75	100	69195.120.075
5 CESH 65	250	69195.050.065	8 CESH 90	250	69195.080.090	12 CESH 110	100	69195.120.110
5 CESH 90	250	69195.050.090						

Nitośruby kołnierz walcowy, stal ocynkowana

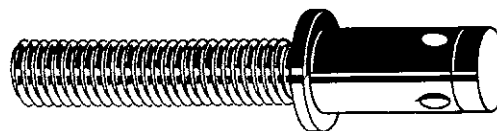
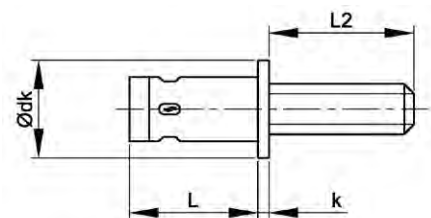

Informacje techniczne

Typ	k	L [+1/-0,5]	L ₂	Wiertło ø	Zakres	ø d _k
M4X2010	0.5	8.0	10	5.5	0.5-2.0	8.0
M4X2015	0.5	8.0	15	5.5	0.5-2.0	8.0
M4X3010	0.5	8.0	10	5.5	2.0-3.0	8.0
M4X3015	0.5	8.0	15	5.5	2.0-3.0	8.0
M5X2010	0.8	9.0	10	6.6	0.5-2.0	9.0
M5X2015	0.8	9.0	15	6.6	0.5-2.0	9.0
M5X3510	0.8	10.5	10	6.6	2.0-3.5	9.0
M5X3515	0.8	10.5	15	6.6	2.0-3.5	9.0
M6X2510	1.0	10.0	10	7.8	0.5-2.5	10.0
M6X2515	1.0	10.0	15	7.8	0.5-2.5	10.0
M6X4010	1.0	11.5	10	7.8	2.5-4.0	10.0
M6X4015	1.0	11.5	15	7.8	2.5-4.0	10.0
M8X3020	1.5	12.5	20	9.9	1.0-3.0	12.0
M8x3515	1.5	12.5	20	9.9	1.0-3.0	12.0
M8X5015	1.5	15.0	15	9.9	3.0-5.0	12.0
M8X5020	1.5	15.0	20	9.9	3.0-5.0	12.0

3

69975 Nitośruby kołnierz walcowy, stal ocynkowana

F09A

Materiał Stal
Obróbka powierzchni Ocynkowane



Typ	☒	Kod artykułu	Typ	☒	Kod artykułu	Typ	☒	Kod artykułu
M4X2010	250	69975.042.010	M5X3510	250	69975.053.510	M8X3020	250	69975.083.020
M4X2015	250	69975.042.015	M5X3515	250	69975.053.515	M8X3015	250	69975.083.515
M4X3010	250	69975.043.010	M6X2510	250	69975.062.510	M8X5015	250	69975.085.015
M4X3015	250	69975.043.015	M6X2515	250	69975.062.515	M8X5020	250	69975.085.020
M5X2010	250	69975.052.010	M6X4010	250	69975.064.010			
M5X2015	250	69975.052.015	M6X4015	250	69975.064.015			

FABORY Nitownica ręczna do nitonakrętek



3

		M3			M4			M5			M6			M8			M10			M12			
		Al	St	St.st.	Al	St	St.st.	Al	St	St.st.	Al	St	St.st.	Al	St	St.st.	Al	St	St.st.	Al	St	St.st.	
F 360																							
F 510																							
F 511																							
F 612																							
FEZ 12																							

opcje dodatkowe
 zalecana nośność



69685 FABORY Nitownica ręczna do nitonakrętek

T90A



Typ		Kod artykułu	
FEZ 12	1	69685.012.001	<ul style="list-style-type: none"> Unikalne narzędzie ręczne z wbudowaną przekładnią, umożliwiające łatwe stosowanie nitonakrętek o dużych rozmiarach. Wyposażone w mechanizm ustawiania skoku oraz system szybkiego zwalniania trzpienia. Capacity: M5 - M12. Weight: 2,5 kg. Dimensions: 555 mm. Body: Aluminium. Lever: Steel. Equipment: Conversion kit blind rivet nuts M5 - M12.
F 360	1	69685.360.001	<ul style="list-style-type: none"> Profesjonalne narzędzie ręczne do montowania nitonakrętek i nitosrub. Wyposażone w mechanizm ustawiania skoku oraz system szybkiego zwalniania trzpienia. Capacity: M3 - M6. Weight: 0,8 kg. Dimensions: 280 mm. Body: Aluminium. Lever: Staal. Equipment: Conversion kit blind rivet nuts M3 - M6. Equipment: Conversion kit blind rivet nuts M4 - M6.
F 510	1	69685.510.001	<ul style="list-style-type: none"> Wydajne narzędzie do montowania nitonakrętek i nitosrub, wyposażone w system szybkiego zwalniania trzpienia oraz w mechanizm ustawiania skoku zapewniający, że każda nakrętka oraz śruba nitowa jest montowana z taką samą siłą zacisku. Capacity: M5 - M10. Weight: 2,2 kg. Dimensions: 555 mm. Body: ABS plastic with steel parts. Lever: Steel. Equipment: Conversion kit blind rivet nuts M5 - M10. Equipment: Conversion kit blind rivet bolts M5 - M8.





69685 FABORY Nitownica ręczna do nitonakrętek		←	
Typ	☒	Kod artykułu	
F 511	1	69685.511.001	<ul style="list-style-type: none"> • Wydajne narzędzie do montowania nitonakrętek i nitośrub, wyposażone w system szybkiego zwalniania trzpienia oraz w mechanizm ustawiania skoku zapewniający, że każda nakrętka oraz śruba nitowa jest montowana z taką samą siłą zaciśnięcia. • Mechanizm szybkiego zwalniania zapewnia szybką instalację. • Capacity: M5 - M10. • Weight: 2,4 kg. • Dimensions: 555 mm. • Body: ABS plastic with steel parts. • Lever: Steel. • Equipment: Conversion kit blind rivet nuts M5 - M10. • Equipment: Conversion kit blind rivet bolts M5 - M8. 
F 612	1	69685.612.001	<ul style="list-style-type: none"> • Wydajne i kompaktowe narzędzie do montowania nitonakrętek z wbudowanym kluczem (mechanizmem) zapadkowym. • Szczególnie przydatne do montowania nitonakrętek w trudno dostępnych miejscach. • Wyposażone w mechanizm dokładnego ustawiania skoku oraz system szybkiego zwalniania trzpienia. • Capacity: M6 - M12. • Weight: 1,1 kg. • Dimensions: 210 mm. • Body: Steel. • Lever: Steel. • Equipment: Conversion kit blind rivet nuts M6 - M12. • Equipment: Conversion kit blind rivet bolts M5 - M8. 

3

Zestawy narzędzi do nitonakrętek



69670 Zestawy narzędzi do nitonakrętek		F90A	
			
Typ	☒	Kod artykułu	
F360	1	69670.360.001	<ul style="list-style-type: none"> • F360 zestaw w aluminiowej walizce. • Solidne narzędzie ręczne do nitonakrętek i śrub nitujących 6 - (x30 szt.), do nitonakrętek M4, M5, M6 w tym stożkowych. 

AMECOIL Wkładki gwintowe z drutu

Zastosowanie

Wkładki gwintowe z drutu AMECOIL, służą nie tylko ekonomicznej naprawie zużytych lub uszkodzonych gwintów, ale również uzyskiwaniu wysoko-obciążalnych gwintów wewnętrznych w metalach lub niemetalach. Wkładki gwintowe z drutu AMECOIL mogą być używane w zakresie temperatur od -40°C do +400°C.

Materiał

Wkładki gwintowe z drutu AMECOIL są produkowane z drutu ze stali nierdzewnej A2 o przekroju poprzecznym w kształcie rombu, zwiniętym w zwój jak sprężyna.

Gwinty

Gwint wewnętrzny nakrętkowej części wkładki gwintowej z drutu AMECOIL, odpowiada normalnemu polu tolerancji 6H. Szczegółowe informacje dotyczące gwintu zewnętrznego w materiale szukaj w DIN 8140-2.

Montaż

W celu montażu wkładek gwintowych AMECOIL, patrz również na kolejność montażu:

- wywiercić otwór (bez fazowania),
- nagwintować gwint przy pomocy specjalnego gwintownika AMECOIL, rozmiary gwintu specjalnych gwintowników AMECOIL są większe niż standardowych gwintowników!
- wkręcić wkładkę gwintową z drutu AMECOIL przy pomocy ręcznego narzędzia montażowego AMECOIL przez 1/4 do 1/2 skoku pod powierzchnię części,
- oderwać ogonek wkładki gwintowej z drutu AMECOIL, do \varnothing 18mm po zamontowaniu przy użyciu trzpienia do odłamywania ogonków wkładek gwintowych z drutu AMECOIL, dla rozmiarów większych niż M18, odpowiednio 5/8 UNC/UNF, konieczne jest zastosowanie spiczastych szczypiec,
- montaż gotowy,
- wymontowanie wkładki gwintowej z drutu AMECOIL jest możliwe przy pomocy specjalnego urządzenia wyciągającego.

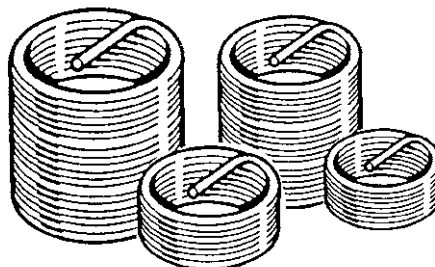

Wartości sugerowane dla określenia długości nominalnej L

Wytrzymałość na rozciąganie materiału Rm w N/mm ²		Klasa właściwości/granica plastyczności śruby w N/mm ²			
Powyżej	Do włącznie	5.8/400	8.8/640	10.9/900	12.9/1080
-	150	2 d	2,5 d	2,5 d	2,5 d
150	200	1,5 d	2 d	2 d	2,5 d
200	250	1,5 d	1,5 d	2 d	2,5 d
250	300	1 d	1,5 d	1,5 d	2 d
300	400	1 d	1 d	1,5 d	1,5 d



Odpowiadające obciążeniom próbnym DIN ISO 898-1.
d = wymiar nominalny wkładki gwintowej z drutu.

Gwintowniki maszynowe do wkładek gwintowych z drutu, nadwymiarowe, metryczne

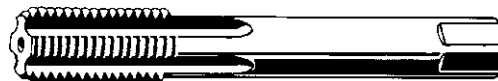

- UWAGA: rozmiary gwintu specjalnych gwintowników AMECOIL są większe niż w normalnym gwintowniku!

3

Grupy katalogowe

Material	Kod	Strona
St HSS	71310	3-143
St HSS do otworów zamkniętych	71410	3-143

71310 AMECOIL Gwintowniki maszynowe do wkładek gwintowych z drutu, nadwymiarowe, metryczne S91A

Material Stal HSS

AMECOIL



d	☒	Kod artykułu	d	☒	Kod artykułu	d	☒	Kod artykułu
M3	1	71310.030.001	M8	1	71310.080.001	M18	1	71310.180.001
M4	1	71310.040.001	M10	1	71310.100.001	M20	1	71310.200.001
M5	1	71310.050.001	M12	1	71310.120.001	M22	1	71310.220.001
M6	1	71310.060.001	M14	1	71310.140.001	M24	1	71310.240.001
M7	1	71310.070.001	M16	1	71310.160.001	M27	1	71310.270.001

71410 AMECOIL Gwintowniki maszynowe do wkładek gwintowych z drutu, nadwymiarowe, metryczne S91A

Material Stal HSS

AMECOIL



d	☒	Kod artykułu	d	☒	Kod artykułu	d	☒	Kod artykułu
M6	1	71410.060.001	M10	1	71410.100.001	M16	1	71410.160.001
M8	1	71410.080.001	M12	1	71410.120.001			

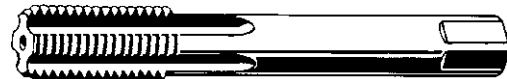

- Zalecane do otworów ślepych.
- Gwintownik maszynowy z ostrym końcem do M8 włącznie i z płaskim końcem powyżej M8.

Gwintowniki maszynowe do mocowania wkładek gwintowych, nadwymiarowe, metryczne drobnozwojne



3

- UWAGA: rozmiary gwintu specjalnych gwintowników AMECOIL są większe niż w normalnym gwintowniku!



71320	AMECOIL Gwintowniki maszynowe do mocowania wkładek gwintowych, nadwymiarowe, metryczne drobnozwojne	S91A
Materiał	Stal HSS	 

d x P	☒	Kod artykułu	d x P	☒	Kod artykułu	d x P	☒	Kod artykułu
M8X1,00	1	71320.080.100	M12X1,50	1	71320.120.150	M18X1,50	1	71320.180.150
M10X1,00	1	71320.100.100	M14X1,25	1	71320.140.125	M20X1,50	1	71320.200.150
M10X1,25	1	71320.100.125	M14X1,50	1	71320.140.150	M22X1,50	1	71320.220.150
M12X1,00	1	71320.120.100	M16X1,50	1	71320.160.150	M24X1,50	1	71320.240.150
M12X1,25	1	71320.120.125						

Gwintowniki do wkładek gwintowych z drutu do korpusu świec zapłonowych, metryczne drobnozwojne



- UWAGA: rozmiary gwintu specjalnych gwintowników AMECOIL są większe niż w normalnym gwintowniku!

71930	AMECOIL Gwintowniki do wkładek gwintowych do korpusu świec zapłonowych, metryczne drobnozwojne	S91A
Materiał	Stal HSS	 

d x P	☒	Kod artykułu	d x P	☒	Kod artykułu
M12X1,25	1	71930.120.125	M14X1,25	1	71930.140.125

Gwintowniki maszynowe do wkładek gwintowych z drutu, UNC

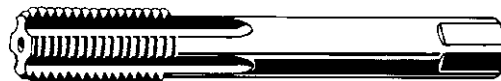

- UWAGA: rozmiary gwintu specjalnych gwintowników AMECOIL są większe niż w normalnym gwintowniku!

3

71340 AMECOIL Gwintowniki maszynowe do wkładek gwintowych z drutu, UNC				S91A				
Materiał		Stal HSS		AMECA				
d	☒	Kod artykułu	d	☒	Kod artykułu	d	☒	Kod artykułu
1/4	1	71340.063.001	1/2	1	71340.127.001	3/4	1	71340.191.001
5/16	1	71340.079.001	9/16	1	71340.142.001	7/8	1	71340.222.001
3/8	1	71340.096.001	5/8	1	71340.158.001	1 Inch	1	71340.254.001
7/16	1	71340.111.001						

Gwintowniki maszynowe do wkładek gwintowych z drutu, UNF

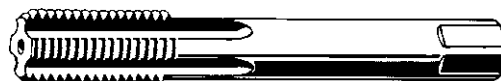

- UWAGA: rozmiary gwintu specjalnych gwintowników AMECOIL są większe niż w normalnym gwintowniku!

71330 AMECOIL Gwintowniki maszynowe do wkładek gwintowych z drutu, UNF				S91A				
Materiał		Stal HSS		AMECA				
d	☒	Kod artykułu	d	☒	Kod artykułu	d	☒	Kod artykułu
1/4	1	71330.063.001	1/2	1	71330.127.001	3/4	1	71330.191.001
5/16	1	71330.079.001	9/16	1	71330.142.001	7/8	1	71330.222.001
3/8	1	71330.096.001	5/8	1	71330.158.001	1 Inch	1	71330.255.001
7/16	1	71330.111.001						

Wkładki gwintowe z drutu, metryczne

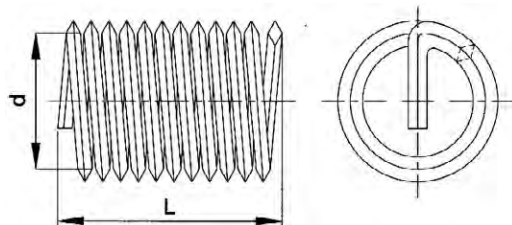

DIN 8140-1A

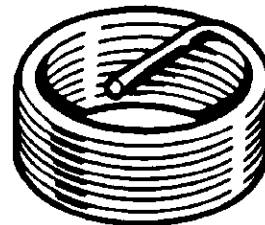

3

Informacje techniczne

d (nom.)	P	Wierćto ø	d (nom.)	P	Wierćto ø
M3	0.5	3.2	M14	2	14.5
M4	0.7	4.2	M16	2	16.5
M5	0.8	5.2	M18	2.5	18.75
M6	1	6.3	M20	2.5	20.75
M7	1	7.3	M22	2.5	22.75
M8	1.25	8.4	M24	3	24.75
M10	1.5	10.5	M27	3	27.75
M12	1.75	12.5			

- L - P = długość gwintu po montażu

Grupy katalogowe

Gwint	Material	Kolor	Kod	Strona
M	St.St. A2		71110	3-146
M	St.St. A2	typ samozabezpieczający	Czerwony	71210

71110 AMECOIL Wkładki gwintowe z drutu		S07A
Gwint	Metryczny	
Material	Stal nierdzewna A2	

d (nom.) x L	☒	Kod artykułu	d (nom.) x L	☒	Kod artykułu	d (nom.) x L	☒	Kod artykułu
M3X4,5	50	71110.030.004	M7X10,5	50	71110.070.010	M14X28	25	71110.140.028
M4X4	50	71110.040.004	M8X8	50	71110.080.008	M16X16	25	71110.160.016
M4X6	50	71110.040.006	M8X12	50	71110.080.012	M16X24	25	71110.160.024
M4X8	50	71110.040.008	M8X16	50	71110.080.016	M16X32	25	71110.160.032
M5X5	50	71110.050.005	M10X10	25	71110.100.010	M18X27	10	71110.180.027
M5X7,5	50	71110.050.007	M10X15	25	71110.100.015	M20X30	10	71110.200.030
M5X10	50	71110.050.010	M10X20	25	71110.100.020	M20X40	10	71110.200.040
M6X6	50	71110.060.006	M12X12	25	71110.120.012	M22X33	10	71110.220.033
M6X9	50	71110.060.009	M12X18	25	71110.120.018	M24X36	10	71110.240.036
M6X12	50	71110.060.012	M12X24	25	71110.120.024	M27X40,5	10	71110.270.040
M6X18	50	71110.060.018	M14X21	25	71110.140.021			

71210 AMECOIL Samozabezpieczające wkładki gwintowe z drutu		DIN 8140-1B	S07A
Gwint	Metryczny		
Material	Stal nierdzewna A2		
Kolor	Czerwony		

d (nom.) x L	☒	Kod artykułu	d (nom.) x L	☒	Kod artykułu	d (nom.) x L	☒	Kod artykułu
M6X9	50	71210.060.009	M10X15	25	71210.100.015	M16X24	25	71210.160.024
M8X12	50	71210.080.012	M12X18	25	71210.120.018			

Samozabezpieczająca wkładka gwintowa z drutu uzyskuje swój efekt blokowania, między śrubą a AMECOIL, przez wieloboczną deformację jednej lub kilku spiral drutu wkładki gwintowej. Są one pomalowane na czerwono, aby ułatwić identyfikację typu standardowego.

Wkładki gwintowe z drutu, metryczne drobnozwojne

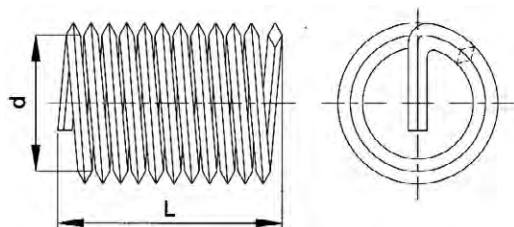

DIN 8140-1A

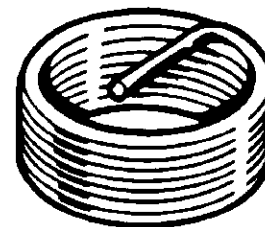

Informacje techniczne

d (nom.) x P	Wiertło ø	d (nom.) x P	Wiertło ø
M8x1	8.3	M14x1.5	14.5
M10x1.25	10.4	M16x1.5	16.5
M12x1.5	12.5		

- L - P = długość gwintu po montażu

71120 AMECOIL Wkładki gwintowe z drutu

S07A

Gwint Metryczny drobnozwojny
Materiał Stal nierdzewna A2

AMECA



d (nom.) x P x L	☒	Kod artykułu	d (nom.) x P x L	☒	Kod artykułu	d (nom.) x P x L	☒	Kod artykułu
M8X1,00X12	50	71120.080.012	M10X1,25X20	25	71120.100.020	M14X1,50X21	25	71120.140.021
M10X1,25X10	25	71120.100.010	M12X1,50X18	25	71120.120.018	M16X1,50X16	25	71120.160.016
M10X1,25X15	25	71120.100.015	M14X1,50X14	25	71120.140.014	M16X1,50X24	25	71120.160.024

Wkładki gwintowe z drutu, metryczne bardzo drobnozwojne

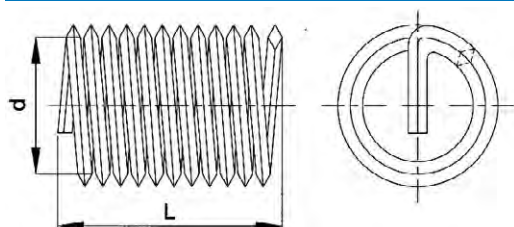

DIN 8140-1A

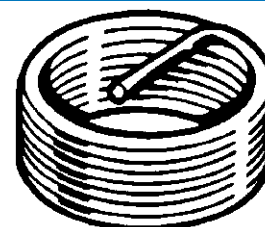

Informacje techniczne

d (nom.) x P	Wiertło ø	d (nom.) x P	Wiertło ø
M10x1	10.25	M18x1.5	18.5
M12x1	12.4	M20x1.5	20.5
M12x1.25	12.4	M22x1.5	22.5
M14x1.25	14.4	M24x1.5	24.5

- L - P = długość gwintu po montażu

Grupy katalogowe

Gwint	Materiał	Kod	Strona
M.b.drob.	St.St. A2	71121	3-147
M.b.drob.	St.St. A2	do świec zapłonowych	3-148

71121 AMECOIL Wkładki gwintowe z drutu

S07A

Gwint Metryczny bardzo drobnozwojny
Materiał Stal nierdzewna A2

AMECA



d (nom.) x P x L	☒	Kod artykułu	d (nom.) x P x L	☒	Kod artykułu	d (nom.) x P x L	☒	Kod artykułu
M10X1,00X15	25	71121.100.015	M14X1,25X14	25	71121.140.014	M18X1,50X27	10	71121.180.027
M12X1,25X18	25	71121.120.018	M18X1,50X12	10	71121.180.012	M20X1,50X20	10	71121.200.020
M12X1,00X18	25	71121.121.018	M18X1,50X18	10	71121.180.018	M20X1,50X30	10	71121.200.030

71121 AMECOIL Wkładki gwintowe z drutu

d (nom.) x P x L	☒	Kod artykułu	d (nom.) x P x L	☒	Kod artykułu
M22X1,50X22	10	71121.220.022	M24X1,50X24	10	71121.240.024

71920 AMECOIL Wkładki gwintowe z drutu do korpusu świec zapłonowych

Gwint Metryczny bardzo drobnozwojny
Materiał Stal nierdzewna A2

AMEGA

d (nom.) x P x L	☒	Kod artykułu	d (nom.) x P x L	☒	Kod artykułu	d (nom.) x P x L	☒	Kod artykułu
M12X1,25X10,5	25	71920.120.010	M14X1,25X10,5	25	71920.140.010	M14X1,25X18	25	71920.140.018
M14X1,25X7,5	25	71920.140.007						

3
Wkładki gwintowe z drutu, UNC

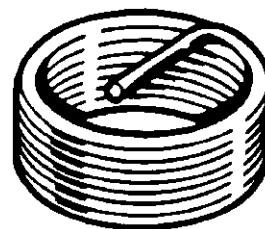
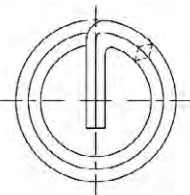
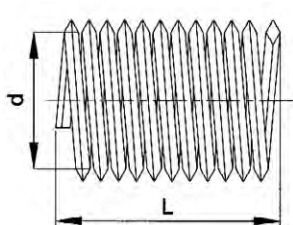
Informacje techniczne

d (nom.)	Wiertło ø	Zwoje gwintu na cal	d (nom.)	Wiertło ø	Zwoje gwintu na cal
1/4	6.7	20	9/16	14.9	12
5/16	8.4	18	5/8	16.5	11
3/8	10	16	3/4	19.8	10
7/16	11.6	14	7/8	23	9
1/2	13.2	13	1 Inch	26.4	8

• L - P = długość gwintu po montażu

71140 AMECOIL Wkładki gwintowe z drutu

Gwint Całowy, zunifikowany grubozwojny (UNC)
Materiał Stal nierdzewna A2

AMEGA

d (nom.) x L	☒	Kod artykułu	d (nom.) x L	☒	Kod artykułu	d (nom.) x L	☒	Kod artykułu
1/4X9,5	50	71140.063.009	1/2X19,1	25	71140.127.019	3/4X28,6	10	71140.191.028
5/16X11,9	50	71140.079.011	9/16X21,4	25	71140.142.021	7/8X33,3	10	71140.222.033
3/8X14,3	25	71140.096.014	5/8X23,8	25	71140.158.023	1 Inch X38,1	10	71140.254.038
7/16X16,7	25	71140.111.016						

Wkładki gwintowe z drutu, UNF

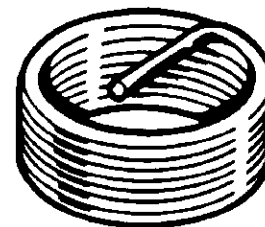
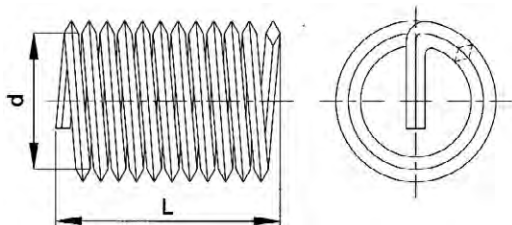

Informacje techniczne

d (nom.)	Wiertło \varnothing	Zwoje gwintu na cal	d (nom.)	Wiertło \varnothing	Zwoje gwintu na cal
1/4	6.7	28	9/16	14.7	18
5/16	8.3	24	5/8	16.3	18
3/8	9.9	24	3/4	19.5	16
7/16	11.5	20	7/8	22.7	14
1/2	13.1	20	1 Inch	26	12

- L - P = długość gwintu po montażu

71130 AMECOIL Wkładki gwintowe z drutu		S07A
Gwint	Całowy, zunifikowany drobnozwojny (UNF)	
Materiał	Stal nierdzewna A2	

d (nom.) x L	☒	Kod artykułu	d (nom.) x L	☒	Kod artykułu	d (nom.) x L	☒	Kod artykułu
1/4X9,5	50	71130.063.009	1/2X19,1	25	71130.127.019	3/4X19,1	10	71130.191.019
5/16X11,9	50	71130.079.011	9/16X14,3	25	71130.142.014	7/8X22,2	10	71130.222.022
3/8X14,3	25	71130.096.014	5/8X15,9	25	71130.158.015	1.IN.-12GX25,4	10	71130.255.025
7/16X16,7	25	71130.111.016						

Zestawy warsztatowe wkładek gwintowych z drutu, metryczne

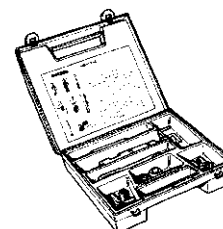

71010 AMECOIL Zestaw warsztatowy wkładek gwintowych z drutu, metryczne		S90A
Materiał	Stal nierdzewna A2	



d (nom.) x L	☒	Kod artykułu	d (nom.) x L	☒	Kod artykułu	d (nom.) x L	☒	Kod artykułu
M3X4,5 (25PC)	1	71010.030.004	M8X12 (25PC)	1	71010.080.012	M18X27 (10PC)	1	71010.180.027
M4X6 (25PC)	1	71010.040.006	M10X15 (25PC)	1	71010.100.015	M20X30 (10PC)	1	71010.200.030
M5X7,5 (25PC)	1	71010.050.007	M12X18 (15PC)	1	71010.120.018	M22X33 (10PC)	1	71010.220.033
M6X9 (25PC)	1	71010.060.009	M14X21 (15PC)	1	71010.140.021	M24X36 (10PC)	1	71010.240.036
M7X10,5 (25PC)	1	71010.070.010	M16X24 (15PC)	1	71010.160.024			

- Zawartość:
- Pełne jednowymiarowe ręczne narzędzie montażowe.
- Gwintownik maszynowy (\geq M18 z dodatkowym gwintownikiem startowym).
- Wkładki gwintowe z drutu ze stali nierdzewnej A2 zgodn. z DIN 8140 (ilości w nawiasach).

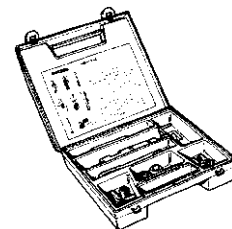
Zestawy warsztatowe wkładek gwintowych z drutu, metryczne drobnozwojne



3

71020	AMECOIL Zestaw warsztatowy wkładek gwintowych z drutu, metryczne drobnozwojne	S90A
Materiał	Stal nierdzewna A2	 

d (nom.) x P x L	☒	Kod artykułu	d (nom.) x P x L	☒	Kod artykułu	d (nom.) x P x L	☒	Kod artykułu
M8X1,00X12 (25PC)	1	71020.080.012	M12X1,50X18 (15PC)	1	71020.120.018	M16X1,50X16 (15PC)	1	71020.160.016
M10X1,25X15 (25PC)	1	71020.100.015	M14X1,50X14 (15PC)	1	71020.140.014			

- Zawartość:
- Pełne jednowymiarowe ręczne narzędzie montażowe.
- Gwintownik maszynowy.
- Wkładki gwintowe z drutu ze stali nierdzewnej A2 zgodn. z DIN 8140 (Ilości w nawiasach).

Zestawy warsztatowe wkładek gwintowych z drutu, metryczne bardzo drobnozwojne





Grupy katalogowe

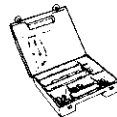

Materiał	Kod	Strona
St.St. A2	71021	3-150
St.St. A2	71910	3-151

71021	AMECOIL Zestaw warsztatowy wkładek gwintowych z drutu, metryczne bardzo drobnozwojne	S90A
Materiał	Stal nierdzewna A2	 

d (nom.) x P x L	☒	Kod artykułu	d (nom.) x P x L	☒	Kod artykułu	d (nom.) x P x L	☒	Kod artykułu
M10X1,00X15 (25PC)	1	71021.100.015	M18X1,50X18 (10PC)	1	71021.180.018	M22X1,50X22 (10PC)	1	71021.220.022
M12X1,25X18 (15PC)	1	71021.120.018	M20X1,50X20 (10PC)	1	71021.200.020	M24X1,50X24 (10PC)	1	71021.240.024
M14X1,25X14 (15PC)	1	71021.140.014						

- Te zestawy warsztatowe są wykonane z plastiku, zawierają wkładki gwintowe z drutu i akcesoria i są przeznaczone do częstego zastosowania jednego rozmiaru.
- Zawartość:
- Pełne jednowymiarowe ręczne narzędzie montażowe.
- Gwintownik maszynowy.
- Wkładki gwintowe z drutu ze stali nierdzewnej A2 zgodn. z DIN 8140-1A (Ilości w nawiasach).

71910	AMECOIL Zestaw warsztatowy wkładek gwintowych z drutu, metryczne bardzo drobnozwojne	S90A
Materiał	Stal nierdzewna A2	 



d (nom.) x P	☒	Kod artykułu	Zawartość:	
M12X1,25	1	71910.120.125	<ul style="list-style-type: none"> Narzędzie montażowe ręczne z końcówką wylotową Końcówka dostosowana do rozmiarów M12 x 1,25 x 10,5 / M12 x 1,25 x 18 Gwintownik stopniowy 10 stal nierdzewna A2 wkładki gwintowe z drutu M12 x 1,25 x 10,5 / M12 x 1,25 x 18 zgodn. z DIN 8140-1A 	
M14X1,25	1	71910.140.125	<ul style="list-style-type: none"> Narzędzie montażowe ręczne z końcówką wylotową Końcówka dostosowana do rozmiarów M14 x 1,25 x 7,5 / M14 x 1,25 x 10,5 / M14 x 1,25 x 18 Gwintownik stopniowy 10 stal nierdzewna A2 wkładki gwintowe z drutu M14 x 1,25 x 7,5 zgodn. z DIN 8140-1A 20 stal nierdzewna A2 wkładki gwintowe z drutu M14 x 1,25 x 10,5 zgodn. z DIN 8140-1A 10 stal nierdzewna A2 wkładki gwintowe z drutu M14 x 1,25 x 18 zgodn. z DIN 8140-1A 	

- Te komplety warsztatowe są zrobione z plastiku, zawierają wkładki gwintowe z drutu i akcesoria i są przeznaczone do zastosowania ogólnego.

3

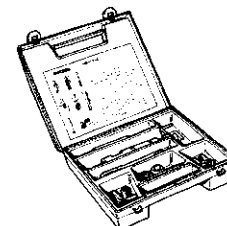
Zestawy warsztatowe wkładek gwintowych z drutu, UNC



71040	AMECOIL Zestawy warsztatowe wkładek gwintowych z drutu, UNC	S90A
Materiał	Stal nierdzewna A2	 

d (nom.) x L	☒	Kod artykułu	d (nom.) x L	☒	Kod artykułu	d (nom.) x L	☒	Kod artykułu
1/4X9,5 (25PC)	1	71040.063.009	1/2X19,1 (25PC)	1	71040.127.019	3/4X28,6 (10PC)	1	71040.191.028
5/16X11,9 (25PC)	1	71040.079.011	9/16X21,4 (15PC)	1	71040.142.021	7/8X33,3 (10PC)	1	71040.222.033
3/8X14,3 (25PC)	1	71040.096.014	5/8X23,8 (15PC)	1	71040.158.023	1.IN.X38,1 (10PC)	1	71040.254.038
7/16X16,7 (25PC)	1	71040.111.016						

- Zawartość:
- Pełne jednowymiarowe ręczne narzędzie montażowe.
- Gwintownik maszynowy (≥ 5/8 UNC z dodatkowym gwintownikiem startowym).
- Wkładki gwintowe z drutu ze stali nierdzewnej A2 (Ilości w nawiasach).

Zestawy warsztatowe wkładek gwintowych z drutu, UNF

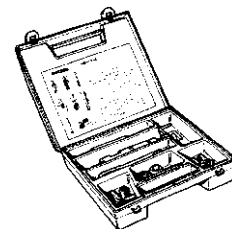

3

71030	AMECOIL Zestawy warsztatowe wkładek gwintowych z drutu, UNF	S90A
Materiał	Stal nierdzewna A2	 



d (nom.) x L	☒	Kod artykułu	d (nom.) x L	☒	Kod artykułu	d (nom.) x L	☒	Kod artykułu
1/4X9,5 (25PC)	1	71030.063.009	1/2X19,1 (25PC)	1	71030.127.019	3/4X19,1 (10PC)	1	71030.191.019
5/16X11,9 (25PC)	1	71030.079.011	9/16X14,3 (15PC)	1	71030.142.014	7/8X22,2 (10PC)	1	71030.222.022
3/8X14,3 (25PC)	1	71030.096.014	5/8X15,9 (15PC)	1	71030.158.015	1.IN.-12GX25,4 (10PC)	1	71030.255.025
7/16X16,7 (25PC)	1	71030.111.016						

- Zawartość:
- Pełne jednowymiarowe ręczne narzędzie montażowe.
- Gwintownik maszynowy.
- Wkładki gwintowe z drutu ze stali nierdzewnej A2 (Ilości w nawiasach).

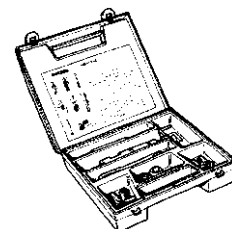
Zestawy warsztatowe wkładek gwintowych z drutu, BSW



- Gwint Whitworth'a (BSW/BSF) nie jest zalecany do międzynarodowego stosowania.
- Zaleca się stosowanie gwintu metrycznego (M/MF) lub zunifikowanego (UNC/UNF).

71050	AMECOIL Zestawy warsztatowe wkładek gwintowych z drutu, BSW	S90A
Materiał	Stal nierdzewna A2	 



d (nom.) x L	☒	Kod artykułu
1/2X19,1 (25PC)	1	71050.127.019





- Zawartość:
- Pełne jednowymiarowe ręczne narzędzie montażowe.
- Gwintownik maszynowy.
- Chwył odrywany.
- Wkładki gwintowe z drutu ze stali nierdzewnej A2 (Ilości w nawiasach).

Zestawy naprawcze z wkładkami gwintowymi z drutu, metryczne/niemetryczne



3

71090	AMECOIL Zestawy naprawcze z wkładkami gwintowymi z drutu	S90A
Materiał	Stal nierdzewna A2	 

Nr	☒	Kod artykułu		
NO.1-MM	1	71090.100.010	<ul style="list-style-type: none"> Zestaw naprawczy nr 1 z wkładkami gwintowymi z drutu, metrycznymi. Zawartość: Narzędzie montażowe ręczne nr 3. Końcówki wylotowe i trzpień do M6 / M8 / M10 i M12. Trzpień do odłamania ogonków wkładek gwintowych z drutu do każdego rozmiaru. Gwintownik maszynowy do każdego rozmiaru. 15 wkładek gwintowych z drutu ze stali nierdzewnej A2 - M6 x 9 / M8 x 12 / M10 x 15 / M12 x 18 zgodn. z DIN 8140. UWAGA: końcówki wylotowe i trzpień M6 i M8 są dostosowane specjalnie do narzędzia montażowego ręcznego nr 3 i wymienne tylko na końcówki wylotowe i trzpień z grupy artykułów 71711. Jeżeli chodzi o końcówki wylotowe i trzpień M10 / M12, patrz kod grupy 71710. 	
NO.2-MM	1	71090.100.020	<ul style="list-style-type: none"> Zestaw naprawczy nr 2 z wkładkami gwintowymi z drutu, metrycznymi. Zawartość: Narzędzie montażowe ręczne nr 4. Końcówki wylotowe i trzpień do M6 / M8 / M10 / M12 / M14 x 1,25. Trzpień do odłamania ogonków wkładek gwintowych z drutu do każdego rozmiaru. Gwintownik maszynowy do każdego rozmiaru (do M14 x 1,25 gwintownik stopniowy). 15 wkładek gwintowych z drutu ze stali nierdzewnej A2 - M6 x 9 / M8 x 12 / M10 x 15 / M12 x 18 / M14 x 1,25 x 14 zgodn. z DIN 8140. UWAGA: końcówki wylotowe i trzpień M6 / M8 / M10 / M12 / M14 x 1,25 są dostosowane specjalnie do narzędzia montażowego ręcznego nr 3 i wymienne tylko na końcówki wylotowe i trzpień z grup artykułów 71712 i 71722. 	
NO.1C-NC	1	71090.400.010	<ul style="list-style-type: none"> Zestaw naprawczy nr 1C z wkładkami gwintowymi z drutu, UNC. Zawartość: Narzędzie montażowe ręczne nr 3. Końcówki wylotowe i trzpień do 1/4 / 5/16 / 3/8 / 7/16 / 1/2 UNC. Trzpień do odłamania ogonków wkładek gwintowych z drutu do każdego rozmiaru. Gwintownik maszynowy do każdego rozmiaru. 15 wkładek gwintowych z drutu ze stali nierdzewnej A2 - 1/4 x 9,5 / 5/16 x 11,9 / 3/8 x 14,3 / 7/16 x 16,7 / 1/2 x 19,1 UNC. UWAGA: końcówki wylotowe i trzpień 1/4 UNC i 5/16 UNC są dostosowane specjalnie do narzędzia montażowego ręcznego nr 3 i wymienne tylko na końcówki wylotowe i trzpień z grupy artykułów 71741. Jeżeli chodzi o końcówki wylotowe i trzpień 3/8 / 7/16 / 1/2 UNC, patrz grupa artykułów 71740. 	
NO.1D-NF	1	71090.500.010	<ul style="list-style-type: none"> Zestaw naprawczy nr 1D z wkładkami gwintowymi z drutu UNF. Zawartość: Narzędzie montażowe ręczne nr 3. Końcówki wylotowe i trzpień do 1/4 / 5/16 / 3/8 / 7/16 / 1/2 UNF. Trzpień do odłamania ogonków wkładek gwintowych z drutu do każdego rozmiaru. Gwintownik maszynowy do każdego rozmiaru. 15 wkładek gwintowych z drutu ze stali nierdzewnej A2 - 1/4 x 9,5 / 5/16 x 11,9 / 3/8 x 14,3 / 7/16 x 16,7 / 1/2 x 19,1 UNF. UWAGA: końcówki wylotowe i trzpień 1/4 UNF i 5/16 UNF są dostosowane specjalnie do narzędzia montażowego ręcznego nr 3 i wymienne tylko na końcówki wylotowe i trzpień z grupy artykułów 71731. Jeżeli chodzi o końcówki wylotowe i trzpień 3/8 / 7/16 / 1/2 UNF, patrz grupa artykułów 71730. 	

Narzędzia montażowe ręczne, metryczne/niemetryczne

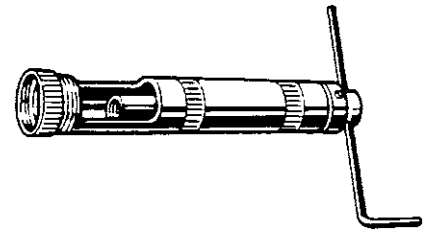

3

71510	AMECOIL Wielowymiarowe, ręczne narzędzia montażowe	S91A
AMECA		

Nr	☒	Kod artykułu		
NO.1	1	71510.000.001	<ul style="list-style-type: none"> • Odpowiednie dla wkładki gwintowej z drutu: M4 / M5 	
NO.2	1	71510.000.002	<ul style="list-style-type: none"> • Odpowiednie dla wkładki gwintowej z drutu: M6 / M7 / M8 / M8x1 / 1/4 UNC / 5/16 UNC / 1/4 UNF / 5/16 UNF 	
NO.3	1	71510.000.003	<ul style="list-style-type: none"> • Odpowiednie dla wkładki gwintowej z drutu: M10 / M12 / M10x1 / M10x1,25 / M12x1 / M12x1,25 / M12x1,5 / 3/8 UNC / 7/16 UNC / 1/2 UNC / 3/8 UNF / 7/16 UNF / 1/2 UNF 	
NO.4	1	71510.000.004	<ul style="list-style-type: none"> • Odpowiednie dla wkładki gwintowej z drutu: M14 / M16 / M14x1,25 / M14x1,5 / M16x1,5 / 9/16 UNC / 5/8 UNC / 9/16 UNF / 5/8 UNF / 1/2 BSW 	

- Przeznaczone do instalacji wkładek gwintowych z drutu.
- Nie zawierają końcówek wylotowej i trzpienia, muszą być zamawiane oddzielnie do odpowiedniej średnicy.
- Korpus aluminiowy ze stalowym wnętrzem.

Narzędzia montażowe ręczne, metryczne

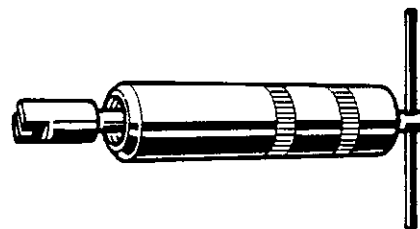

3

Grupy katalogowe

Kod	Strona
71610	3-155
71620	3-155
71940	3-155
71640	3-156

71610 AMECOIL Całkowicie ręczne narzędzia montażowe, metryczne S91A

AMECA

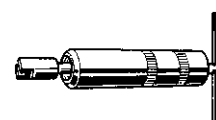

d	☒	Kod artykułu	d	☒	Kod artykułu	d	☒	Kod artykułu
M18	1	71610.180.001	M22	1	71610.220.001	M27	1	71610.270.001
M20	1	71610.200.001	M24	1	71610.240.001			

- Całkowicie ręczne narzędzie montażowe.
- Przeznaczone do montażu metrycznych wkładek gwintowych z drutu.
- Aluminium ze stalowym wnętrzem.

71620 AMECOIL Całkowicie ręczne narzędzia montażowe, metryczne drobnozwojne S91A

AMECA

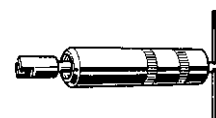

d x P	☒	Kod artykułu	d x P	☒	Kod artykułu	d x P	☒	Kod artykułu
M18X1,50	1	71620.180.150	M22X1,50	1	71620.220.150	M24X1,50	1	71620.240.150
M20X1,50	1	71620.200.150						

- Całkowicie ręczne narzędzie montażowe.
- Przeznaczone do montażu metrycznych wkładek gwintowych z drutu z bardzo drobnym gwintem.
- Aluminium ze stalowym wnętrzem.

71940 AMECOIL Narzędzia montażowe ręczne z końcówką wylotową S91A

AMECA

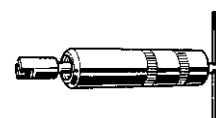

d x P	☒	Kod artykułu	d x P	☒	Kod artykułu
M12X1,25	1	71940.120.125	M14X1,25	1	71940.140.125

- Narzędzie montażowe ręczne z końcówką wylotową.
- Odpowiednie do montowania wkładek gwintowych z drutu do korpusów świec zapłonowych.
- Z wyjątkiem końcówki dopasowanej do rozmiaru, do zamówienia oddzielnie odpowiednio do średnicy i długości (d znam. x L) wkładek gwintowych z drutu.
- Korpus aluminiowy ze stalowym wnętrzem.

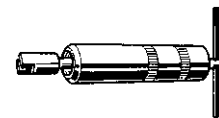

d	☒	Kod artykułu	d	☒	Kod artykułu	d	☒	Kod artykułu
3/4	1	71640.191.001	7/8	1	71640.222.001	1 Inch	1	71640.254.001

- Całkowicie ręczne narzędzie montażowe.
- Przeznaczone do montażu metrycznych wkładek gwintowych z drutu z gwintem UNC.
- Aluminium ze stalowym wnętrzem.

3

Końcówki wylotowe z trzpieniem, metryczne

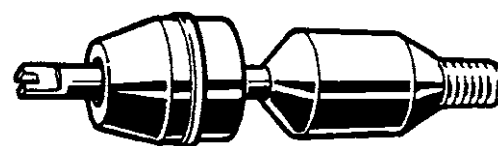

Grupy katalogowe

Kod	Strona
71710	3-156
71711	3-157
71720	3-157
71740	3-157
71730	3-158





d	☒	Kod artykułu		
M3	1	71710.030.001	<ul style="list-style-type: none"> • Końcówki wylotowe i trzpień do narzędzia montażowego ręcznego nr 1 • Odpowiednie dla wkładki gwintowej z drutu: M3 	
M4	1	71710.040.001	<ul style="list-style-type: none"> • Końcówki wylotowe i trzpień do narzędzia montażowego ręcznego nr 1 • Odpowiednie dla wkładki gwintowej z drutu: M4 	
M5	1	71710.050.001	<ul style="list-style-type: none"> • Końcówki wylotowe i trzpień do narzędzia montażowego ręcznego nr 1 • Odpowiednie dla wkładki gwintowej z drutu: M5 	
M6	1	71710.060.001	<ul style="list-style-type: none"> • Końcówki wylotowe i trzpień do narzędzia montażowego ręcznego nr 2 • Odpowiednie dla wkładki gwintowej z drutu: M5 	
M7	1	71710.070.001	<ul style="list-style-type: none"> • Końcówki wylotowe i trzpień do narzędzia montażowego ręcznego nr 2 • Odpowiednie dla wkładki gwintowej z drutu: M7 	
M8	1	71710.080.001	<ul style="list-style-type: none"> • Końcówki wylotowe i trzpień do narzędzia montażowego ręcznego nr 2 • Odpowiednie dla wkładki gwintowej z drutu: M8 	
M10	1	71710.100.001	<ul style="list-style-type: none"> • Końcówki wylotowe i trzpień do narzędzia montażowego ręcznego nr 3 • Odpowiednie dla wkładki gwintowej z drutu: M10 	
M12	1	71710.120.001	<ul style="list-style-type: none"> • Końcówki wylotowe i trzpień do narzędzia montażowego ręcznego nr 3 • Odpowiednie dla wkładki gwintowej z drutu: M12 	
M14	1	71710.140.001	<ul style="list-style-type: none"> • Końcówki wylotowe i trzpień do narzędzia montażowego ręcznego nr 4 • Odpowiednie dla wkładki gwintowej z drutu: M14 	
M16	1	71710.160.001	<ul style="list-style-type: none"> • Końcówki wylotowe i trzpień do narzędzia montażowego ręcznego nr 4 • Odpowiednie dla wkładki gwintowej z drutu: M16 	

71711 AMECOIL Końcówki wylotowe z trzpieniem do ręcznego montażu S91A

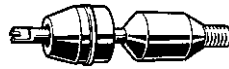
AMECA

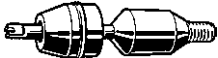

d	<input checked="" type="checkbox"/>	Kod artykułu		
M6-ASS1	1	71711.060.001	<ul style="list-style-type: none"> Końcówki wylotowe i trzpień do narzędzia montażowego ręcznego nr 3 (Zestaw naprawczy nr 1) Odpowiednie dla wkładki gwintowej z drutu: M6 	
M8-ASS1	1	71711.080.001	<ul style="list-style-type: none"> Końcówki wylotowe i trzpień do narzędzia montażowego ręcznego nr 3 (Zestaw naprawczy nr 1) Odpowiednie dla wkładki gwintowej z drutu: M8 	

3

71720 AMECOIL Końcówki wylotowe z trzpieniem do ręcznego montażu, metryczne drobnozwojne S91A

AMECA







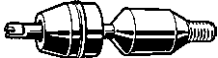

d x P	<input checked="" type="checkbox"/>	Kod artykułu		
M8X1,00	1	71720.080.100	<ul style="list-style-type: none"> Końcówki wylotowe i trzpień do narzędzia montażowego ręcznego nr 2 Odpowiednie dla wkładki gwintowej z drutu: M8x1 	
M10X1,00	1	71720.100.100	<ul style="list-style-type: none"> Końcówki wylotowe i trzpień do narzędzia montażowego ręcznego nr 3 Odpowiednie dla wkładki gwintowej z drutu: M10x1 	
M10X1,25	1	71720.100.125	<ul style="list-style-type: none"> Końcówki wylotowe i trzpień do narzędzia montażowego ręcznego nr 3 Odpowiednie dla wkładki gwintowej z drutu: M10x1,25 	
M12X1,00	1	71720.120.100	<ul style="list-style-type: none"> Końcówki wylotowe i trzpień do narzędzia montażowego ręcznego nr 3 Odpowiednie dla wkładki gwintowej z drutu: M12x1 	
M12X1,25	1	71720.120.125	<ul style="list-style-type: none"> Końcówki wylotowe i trzpień do narzędzia montażowego ręcznego nr 3 Odpowiednie dla wkładki gwintowej z drutu: M12x1,25 	
M12X1,50	1	71720.120.150	<ul style="list-style-type: none"> Końcówki wylotowe i trzpień do narzędzia montażowego ręcznego nr 3 Odpowiednie dla wkładki gwintowej z drutu: M12x1,5 	
M14X1,25	1	71720.140.125	<ul style="list-style-type: none"> Końcówki wylotowe i trzpień do narzędzia montażowego ręcznego nr 4 Odpowiednie dla wkładki gwintowej z drutu: M14x1,25 	
M14X1,50	1	71720.140.150	<ul style="list-style-type: none"> Końcówki wylotowe i trzpień do narzędzia montażowego ręcznego nr 4 Odpowiednie dla wkładki gwintowej z drutu: M14x1,5 	
M16X1,50	1	71720.160.150	<ul style="list-style-type: none"> Końcówki wylotowe i trzpień do narzędzia montażowego ręcznego nr 4 Odpowiednie dla wkładki gwintowej z drutu: M16x1,5 	

71740 AMECOIL Końcówki wylotowe z trzpieniem do ręcznego montażu, UNC S91A

AMECA



d	<input checked="" type="checkbox"/>	Kod artykułu		
1/4	1	71740.063.001	<ul style="list-style-type: none"> Końcówki wylotowe i trzpień do narzędzia montażowego ręcznego nr 2 Odpowiednie dla wkładki gwintowej z drutu: 1/4 UNC 	
5/16	1	71740.079.001	<ul style="list-style-type: none"> Końcówki wylotowe i trzpień do narzędzia montażowego ręcznego nr 2 Odpowiednie dla wkładki gwintowej z drutu: 5/16 UNC 	
3/8	1	71740.096.001	<ul style="list-style-type: none"> Końcówki wylotowe i trzpień do narzędzia montażowego ręcznego nr 3 Odpowiednie dla wkładki gwintowej z drutu: 3/8 UNC 	
7/16	1	71740.111.001	<ul style="list-style-type: none"> Końcówki wylotowe i trzpień do narzędzia montażowego ręcznego nr 3 Odpowiednie dla wkładki gwintowej z drutu: 7/16 UNC 	
1/2	1	71740.127.001	<ul style="list-style-type: none"> Końcówki wylotowe i trzpień do narzędzia montażowego ręcznego nr 3 Odpowiednie dla wkładki gwintowej z drutu: 1/2 UNC 	
9/16	1	71740.142.001	<ul style="list-style-type: none"> Końcówki wylotowe i trzpień do narzędzia montażowego ręcznego nr 4 Odpowiednie dla wkładki gwintowej z drutu: 9/16 UNC 	

71740 AMECOIL Końcówki wylotowe z trzpieniem do ręcznego montażu, UNC

d	☒	Kod artykułu	
5/8	1	71740.158.001	<ul style="list-style-type: none"> Końcówki wylotowe i trzpień do narzędzia montażowego ręcznego nr 4 Odpowiednie dla wkładki gwintowej z drutu: 5/8 UNC

71730 AMECOIL Końcówki wylotowe z trzpieniem do ręcznego montażu, UNF
S91A
AMECA

3

d	☒	Kod artykułu	
1/4	1	71730.063.001	<ul style="list-style-type: none"> Końcówki wylotowe i trzpień do narzędzia montażowego ręcznego nr 2 Odpowiednie dla wkładki gwintowej z drutu: 1/4 UNF
5/16	1	71730.079.001	<ul style="list-style-type: none"> Końcówki wylotowe i trzpień do narzędzia montażowego ręcznego nr 2 Odpowiednie dla wkładki gwintowej z drutu: 5/16 UNF
3/8	1	71730.096.001	<ul style="list-style-type: none"> Końcówki wylotowe i trzpień do narzędzia montażowego ręcznego nr 3 Odpowiednie dla wkładki gwintowej z drutu: 3/8 UNF
7/16	1	71730.111.001	<ul style="list-style-type: none"> Końcówki wylotowe i trzpień do narzędzia montażowego ręcznego nr 3 Odpowiednie dla wkładki gwintowej z drutu: 7/16 UNF
1/2	1	71730.127.001	<ul style="list-style-type: none"> Końcówki wylotowe i trzpień do narzędzia montażowego ręcznego nr 3 Odpowiednie dla wkładki gwintowej z drutu: 1/2 UNF
9/16	1	71730.142.001	<ul style="list-style-type: none"> Końcówki wylotowe i trzpień do narzędzia montażowego ręcznego nr 4 Odpowiednie dla wkładki gwintowej z drutu: 9/16 UNF
5/8	1	71730.158.001	<ul style="list-style-type: none"> Końcówki wylotowe i trzpień do narzędzia montażowego ręcznego nr 4 Odpowiednie dla wkładki gwintowej z drutu: 5/8 UNF

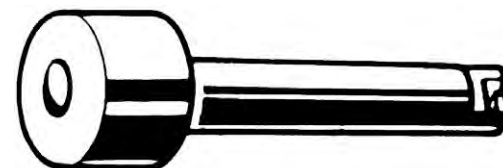
Łącznik

71950 AMECOIL Łącznik
S91A
AMECA

d x P x L	☒	Kod artykułu	d x P x L	☒	Kod artykułu	d x P x L	☒	Kod artykułu
M12X1,25X10,5	1	71950.120.010	M14X1,25X7,5	1	71950.140.007	M14X1,25X18	1	71950.140.018
M12X1,25X18	1	71950.120.018	M14X1,25X10,5	1	71950.140.010			

- Do narzędzia montażowego ręcznego z końcówką wylotową.

Trzpień do odłamywania ogonków wkładek gwintowych z drutu



3

71810 AMECOIL Trzpień do odłamywania ogonków wkładek gwintowych z drutu S91A

AMECA



W użyciu z	☒	Kod artykułu	W użyciu z	☒	Kod artykułu	W użyciu z	☒	Kod artykułu
M3	1	71810.030.001	M7	1	71810.070.001	M14 - 9/16	1	71810.140.001
M4	1	71810.040.001	M8 - 5/16	1	71810.080.001	M16 - 5/8	1	71810.160.001
M5	1	71810.050.001	M10 - 3/8 - 7/16	1	71810.100.001	M18	1	71810.180.001
M6 - 1/4	1	71810.060.001	M12 - 1/2	1	71810.120.001			

- Przeznaczone do odrywania trzonka wprowadzającego po zainstalowaniu metrycznej wkładki gwintowej.
- UWAGA: dla rozmiarów większych od M18 i 5/8 UNC/UNF należy zastosować odpowiednie szczypce.

Wyciągacz

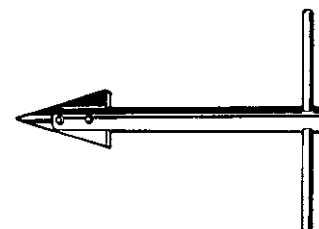

71860 AMECOIL Wyciągacz S91A

AMECA

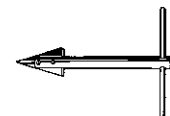

Nr	☒	Kod artykułu	
NO.1	1	71860.000.001	• Odpowiednie dla wkładki gwintowej z drutu: M3 / M4 / M5 / M6 / M7 / M8 / 1/4 / 5/16
NO.2	1	71860.000.002	• Odpowiednie dla wkładki gwintowej z drutu: M5 / M6 / M7 / M8 / M10 / M12 / 1/4 / 5/16 / 3/8 / 7/16
NO.3	1	71860.000.003	• Odpowiednie dla wkładki gwintowej z drutu: M10 / M12 / M14 / M16 / M18 / M20 / M22 / M24 / 3/8 / 7/16 / 1/2 / 9/16 / 5/8

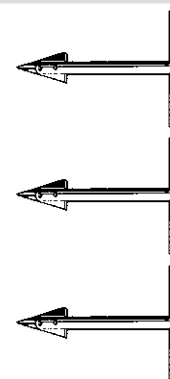

- Przeznaczone do zastosowania, gdy metryczna wkładka gwintowa została słabo umieszczona i musi zostać wyjęta (metryczny / metryczny drobny / UNC / UNF / BSW).
- UWAGA: jeżeli gwint nie został uszkodzony, to można zamontować nową wkładkę gwintową z drutu.

Zestaw naprawczy do gwintów metrycznych Rapid



3

71788	V-COIL Zestaw naprawczy do gwintów metrycznych Rapid	V01A
Materiał	Stal nierdzewna A2	



d (nom.) x P x L	☒	Kod artykułu	d (nom.) x P x L	☒	Kod artykułu	d (nom.) x P x L	☒	Kod artykułu
M2,5X0,45X3,75	1	71788.025.045	M5X0,8X7,5	1	71788.050.080	M10X1,5X15	1	71788.100.150
M3X0,5X4,5	1	71788.030.050	M6X1,0X9	1	71788.060.100	M12X1,75X18	1	71788.120.175
M4X0,7X6	1	71788.040.070	M8X1,25X12	1	71788.080.125			

- Zawartość:
- Narzędzie do wkręcania
- Trzpień do oderwania końcówki
- Gwintownik maszynowy
- Wiertła
- Uchwyt do końcówek
- Wkładki gwintowane ze stali nierdzewnej A2 wg DIN 8140: M2,5 - M10, 10 szt. / M12, 6 szt.

Zestaw naprawczy do gwintów metrycznych



71760	V-COIL Zestaw naprawczy do gwintów metrycznych	V01A
Materiał	Stal nierdzewna A2	



d (nom.) x P x L	☒	Kod artykułu	d (nom.) x P x L	☒	Kod artykułu	d (nom.) x P x L	☒	Kod artykułu
M2X0,4X3	1	71760.020.040	M10X1,5X15	1	71760.100.150	M18X1,5X24	1	71760.180.150
M2,5X0,45X3,75	1	71760.025.040	M11X1,5X16,5	1	71760.110.150	M18X2,0X24	1	71760.180.200
M3X0,5X4,5	1	71760.030.050	M12X1,0X18	1	71760.120.100	M18X2,5X24	1	71760.180.250
M3,5X0,6X5,25	1	71760.035.060	M12X1,25X18	1	71760.120.125	M20X1,5X30	1	71760.200.150
M4X0,7X6	1	71760.040.070	M12X1,5X18	1	71760.120.150	M20X2,0X30	1	71760.200.200
M5X0,8X7,5	1	71760.050.080	M12X1,75X18	1	71760.120.175	M20X2,5X30	1	71760.200.250
M6X1,0X9	1	71760.060.100	M14X1,0X21	1	71760.140.100	M22X1,5X33	1	71760.220.150
M7X1,0X10,5	1	71760.070.100	M14X1,25X21	1	71760.140.125	M22X2,0X33	1	71760.220.200
M8X1,0X12	1	71760.080.100	M14X1,5X21	1	71760.140.150	M22X2,5X33	1	71760.220.250
M8X1,25X12	1	71760.080.125	M14X2,0X21	1	71760.140.200	M24X1,5X36	1	71760.240.150
M9X1,25X13,5	1	71760.090.125	M16X1,5X24	1	71760.160.150	M24X2,0X36	1	71760.240.200
M10X1,0X15	1	71760.100.100	M16X2,0X24	1	71760.160.200	M24X3,0X36	1	71760.240.300
M10X1,25X15	1	71760.100.125						

- Zawartość:
- Narzędzie do wkręcania
- Trzpień do oderwania końcówki (aż do M12); dla > M12 użyj długich szczyptic.
- Gwintownik maszynowy
- Wiertła (aż do M12); dla > M12 wiertła zamawiane osobno.
- Wkładki gwintowane ze stali nierdzewnej A2 wg DIN 8140: M2 - M8, 20 szt. / M9 - M10, 15 szt. / M11 - M16, 10 szt. / M18 - M24, 5 szt.

Zestaw naprawczy do gwintów świec niemetrycznych



3

Grupy katalogowe

Material	Kod	Strona
St.St. A2	71766	3-161
St.St. A2	71768	3-161
St.St. A2	71770	3-161
St.St. A2	71772	3-162

71766 V-COIL Zestaw naprawczy do gwintów UNC V01A

Material Stal nierdzewna A2



d (nom.) x L	☒	Kod artykułu	d (nom.) x L	☒	Kod artykułu	d (nom.) x L	☒	Kod artykułu
NO.2X3,28	1	71766.021.001	NO.12X8,23	1	71766.054.001	9/16X21,4	1	71766.142.001
NO.4X4,27	1	71766.028.001	1/4X9,5	1	71766.063.001	5/8X23,8	1	71766.158.001
NO.5X4,76	1	71766.031.001	5/16X11,9	1	71766.079.001	3/4X28,6	1	71766.191.001
NO.6X5,26	1	71766.035.001	3/8X14,3	1	71766.096.001	7/8X33,3	1	71766.222.001
NO.8X6,25	1	71766.041.001	7/16X16,7	1	71766.111.001	1 Inch X38,1	1	71766.254.001
NO.10X7,24	1	71766.048.001	1/2X19,1	1	71766.127.001			

- Zawartość:
- Narzędzie do wkręcania
- Trzpień do oderwania końcówki (aż do 1/2x19,1); dla > 1/2x19,1 użyj długich szczypiec.
- Gwintownik maszynowy
- Wiertła (aż do 1/2x19,1); dla > 1/2x19,1 wiertła zamawiane osobno.
- Wkładki gwintowane ze stali nierdzewnej A2 wg DIN 8140: No.2 - 5/16, 20 szt. / 3/8 - 15 szt. / 7/16 - 5/8, 10 szt. / 3/4 - 7/8, 5 szt. / 1.IN., 4 szt.

71768 V-COIL Zestaw naprawczy do gwintów UNF V01A

Material Stal nierdzewna A2



d (nom.) x L	☒	Kod artykułu	d (nom.) x L	☒	Kod artykułu	d (nom.) x L	☒	Kod artykułu
NO.4X4,27	1	71768.028.001	5/16X11,9	1	71768.079.001	5/8X23,8	1	71768.158.001
NO.6X5,26	1	71768.035.001	3/8X14,3	1	71768.096.001	3/4X28,6	1	71768.191.001
NO.8X6,25	1	71768.041.001	7/16X16,7	1	71768.111.001	7/8X33,3	1	71768.222.001
NO.10X7,24	1	71768.048.001	1/2X19,1	1	71768.127.001	1 Inch X38,1	1	71768.254.001
1/4X9,5	1	71768.063.001	9/16X21,4	1	71768.142.001			

- Zawartość:
- Narzędzie do wkręcania
- Trzpień do oderwania końcówki (aż do 1/2x19,1); dla > 1/2x19,1 użyj długich szczypiec.
- Gwintownik maszynowy
- Wiertła (aż do 1/2x19,1); dla > 1/2x19,1 wiertła zamawiane osobno.
- Wkładki gwintowane ze stali nierdzewnej A2 wg DIN 8140: No.4 - 5/16, 20 szt. / 3/8 - 15 szt. / 7/16 - 5/8, 10 szt. / 3/4 - 7/8, 5 szt. / 1.IN., 4 szt.

71770 V-COIL Zestaw naprawczy do gwintów BSW V01A

Material Stal nierdzewna A2



d (nom.) x L	☒	Kod artykułu	d (nom.) x L	☒	Kod artykułu	d (nom.) x L	☒	Kod artykułu
1/8X4,75	1	71770.031.001	3/8X14,3	1	71770.096.001	5/8X23,8	1	71770.158.001
3/16X7,14	1	71770.047.001	7/16X16,7	1	71770.111.001	3/4X28,6	1	71770.191.001
1/4X9,5	1	71770.063.001	1/2X19,1	1	71770.127.001	7/8X33,3	1	71770.222.001
5/16X11,9	1	71770.079.001	9/16X21,4	1	71770.142.001	1 Inch X38,1	1	71770.254.001

71770 V-COIL Zestaw naprawczy do gwintów BSW

- Zawartość:
- Narzędzie do wkręcania
- Trzpień do oderwania końcówki (aż do 1/2x19,1); dla > 1/2x20 użyj długich szczypiec.
- Gwintownik maszynowy
- Wiertła (aż do 1/2x19,1); dla > 1/2x19,1 wiertła zamawiane osobno.
- Wkładki gwintowane ze stali nierdzewnej A2 wg DIN 8140: 1/8 - 5/16, 20 szt. / 3/8 - 15 szt. / 7/16 - 5/8, 10 szt. / 3/4 - 7/8, 5 szt. / 1.IN., 4 szt.

71772 V-COIL Zestaw naprawczy do gwintów BSF
V01A
Materiał Stal nierdzewna A2



d (nom.) x L	☒	Kod artykułu	d (nom.) x L	☒	Kod artykułu	d (nom.) x L	☒	Kod artykułu
3/16X7,14	1	71772.047.001	7/16X16,7	1	71772.111.001	3/4X28,6	1	71772.191.001
1/4X9,5	1	71772.063.001	1/2X19,1	1	71772.127.001	7/8X33,3	1	71772.222.001
5/16X11,9	1	71772.079.001	9/16X21,4	1	71772.142.001	1.INX38,1	1	71772.254.001
3/8X14,3	1	71772.096.001	5/8X23,8	1	71772.158.001			

- Zawartość:
- Narzędzie do wkręcania
- Trzpień do oderwania końcówki (aż do 1/2x19,1); dla > 1/2x19,1 użyj długich szczypiec.
- Gwintownik maszynowy
- Wiertła (aż do 1/2x19,1); dla > 1/2x19,1 wiertła zamawiane osobno.
- Wkładki gwintowane ze stali nierdzewnej A2 wg DIN 8140: 3/16 - 5/16, 20 szt. / 3/8 - 15 szt. / 7/16 - 5/8, 10 szt. / 3/4 - 7/8, 5 szt. / 1.IN., 4 szt.

Zestaw naprawczy do gwintów świec zapłonowych

71764 V-COIL Zestaw naprawczy do gwintów świec zapłonowych
V01A
Materiał Stal nierdzewna A2



d (nom.) x P x L	☒	Kod artykułu	d (nom.) x P x L	☒	Kod artykułu	d (nom.) x P x L	☒	Kod artykułu
M6X1,0X9	1	71764.060.100	M10X1,25X15	1	71764.100.125	M14X1,25X21	1	71764.140.125
M8X1,25X12	1	71764.080.125	M10X1,5X15	1	71764.100.150	M18X1,5X24	1	71764.180.150
M10X1,0X15	1	71764.100.100	M12X1,25X18	1	71764.120.125			





- Zawartość:
- Narzędzie do wkręcania
- Gwintownik maszynowy
- Wkładki gwintowane ze stali nierdzewnej A2 wg DIN 8140: M6 - M12, 10 szt. (L=1,5d) / M14, 3x5 szt. (L=8,4mm/12,4mm/16,4mm) / M18, 5 szt. (L=1,5d).

Zestawy naprawcze metryczne



3

71762	V-COIL Zestaw metryczne	V01A
Materiał	Stal nierdzewna A2	 

Wymiary	☒	Kod artykułu		
M5-M12	1	71762.000.001	Zestaw do metrycznych wkładek gwintowanych. Zawartość:	   
			<ul style="list-style-type: none"> Narzędzie do wkręcania dla każdego rozmiaru. Trzpień do oderwania końcówki dla każdego rozmiaru. Gwintownik maszynowy dla każdego rozmiaru. Wiertła dla każdego rozmiaru. M5-M6-M8-M10; dla każdego rozmiaru 25 wkładek gwintowanych ze stali nierdzewnej A2 wg DIN 8140. M12; 10 wkładek gwintowanych ze stali nierdzewnej A2 wg DIN 8140. 	
M6-M14X1,25	1	71762.000.002	Zestaw do metrycznych wkładek gwintowanych. Zawartość:	
			<ul style="list-style-type: none"> Narzędzie do wkręcania dla każdego rozmiaru. Trzpień do oderwania końcówki dla każdego rozmiaru za wyjątkiem M14 (użyj długich szczypiec). Gwintownik maszynowy dla każdego rozmiaru. Wiertła dla każdego rozmiaru za wyjątkiem M14 (zamów osobno). M6-M8-M10; dla każdego rozmiaru 25 wkładek gwintowanych ze stali nierdzewnej A2 wg DIN 8140. M12-M14; 10 wkładek gwintowanych ze stali nierdzewnej A2 wg DIN 8140. 	
M6-M14X1,25/PT	1	71762.000.003	Zestaw do metrycznych wkładek gwintowanych do świec zapłonowych. Zawartość:	
			<ul style="list-style-type: none"> Narzędzie do wkręcania dla każdego rozmiaru. Trzpień do oderwania końcówki dla każdego rozmiaru za wyjątkiem M14 (użyj długich szczypiec). Gwintownik maszynowy dla każdego rozmiaru. Wiertła dla każdego rozmiaru za wyjątkiem M14 (zamów osobno). M6-M8-M10; dla każdego rozmiaru 25 wkładek gwintowanych ze stali nierdzewnej A2 wg DIN 8140. M12-M14; 10 wkładek gwintowanych ze stali nierdzewnej A2 wg DIN 8140. 	
M6-M10	1	71762.000.004	Zestaw do metrycznych wkładek gwintowanych. Zawartość:	
			<ul style="list-style-type: none"> Narzędzie do wkręcania dla każdego rozmiaru. Trzpień do oderwania końcówki dla każdego rozmiaru. Gwintownik maszynowy dla każdego rozmiaru. Wiertła dla każdego rozmiaru. M6-M8-M10; dla każdego rozmiaru 25 wkładek gwintowanych ze stali nierdzewnej A2 wg DIN 8140. 	

Zestawy metryczne Rapid



3

71790	V-COIL Zestaw metryczne Rapid	V01A
Materiał	Stal nierdzewna A2	

Wymiary	✉	Kod artykułu	
M5-M12	1	71790.000.001	Zestaw do metrycznych wkładek gwintowanych Rapid. Zawartość: <ul style="list-style-type: none"> • Narzędzie do wkręcania dla każdego rozmiaru. • Trzpień do oderwania końcówki dla każdego rozmiaru. • Gwintownik maszynowy dla każdego rozmiaru. • Wiertła dla każdego rozmiaru. • Uchwyt do końcówek. • M5-M6-M8-M10-M12; dla każdego rozmiaru po 10 wkładek gwintowanych ze stali nierdzewnej A2 wg DIN 8140.
M6-M10	1	71790.000.002	Zestaw do metrycznych wkładek gwintowanych Rapid. Zawartość: <ul style="list-style-type: none"> • Narzędzie do wkręcania dla każdego rozmiaru. • Trzpień do oderwania końcówki dla każdego rozmiaru. • Gwintownik maszynowy dla każdego rozmiaru. • Wiertła dla każdego rozmiaru. • Uchwyt do końcówek. • M6-M8-M10; dla każdego rozmiaru po 10 wkładek gwintowanych ze stali nierdzewnej A2 wg DIN 8140.

Zestawy niemetryczne



Grupy katalogowe

Materiał	Kod	Strona
St.St. A2	71774	3-164
St.St. A2	71776	3-165
St.St. A2	71778	3-165
St.St. A2	71780	3-165

71774	V-COIL Zestaw UNC	V01A
Materiał	Stal nierdzewna A2	

Wymiary	✉	Kod artykułu	
1/4-1/2	1	71774.000.001	Zestaw do wkładek gwintowanych UNC. Zawartość: <ul style="list-style-type: none"> • Narzędzie do wkręcania dla każdego rozmiaru. • Trzpień do oderwania końcówki dla każdego rozmiaru. • Gwintownik maszynowy dla każdego rozmiaru. • Wiertła dla każdego rozmiaru. • Wkładki gwintowane ze stali nierdzewnej A2 wg DIN 8140: 1/4-5/16-3/8 - 25 szt. / 7/16-1/2 - 10 szt.

71776	V-COIL Zestaw UNF	V01A
Material	Stal nierdzewna A2	 

Wymiary	<input type="checkbox"/>	Kod artykułu		
1/4-1/2	1	71776.000.001	Zestaw do wkładek gwintowanych UNF. Zawartość: <ul style="list-style-type: none"> • Narzędzie do wkręcania dla każdego rozmiaru. • Trzpień do oderwania końcówki dla każdego rozmiaru. • Gwintownik maszynowy dla każdego rozmiaru. • Wiertła dla każdego rozmiaru. • Wkładki gwintowane ze stali nierdzewnej A2 wg DIN 8140: 1/4-5/16-3/8 - 25 szt. / 7/16-1/2 - 10 szt. 	

3

71778	V-COIL Zestaw BSW	V01A
Material	Stal nierdzewna A2	 

Wymiary	<input type="checkbox"/>	Kod artykułu		
1/4-1/2	1	71778.000.001	Zestaw do wkładek gwintowanych BSW. Zawartość: <ul style="list-style-type: none"> • Narzędzie do wkręcania dla każdego rozmiaru. • Trzpień do oderwania końcówki dla każdego rozmiaru. • Gwintownik maszynowy dla każdego rozmiaru. • Wiertła dla każdego rozmiaru. • Wkładki gwintowane ze stali nierdzewnej A2 wg DIN 8140: 1/4-5/16-3/8 - 25 szt. / 7/16-1/2 - 10 szt. 	

71780	V-COIL Zestaw BSF	V01A
Material	Stal nierdzewna A2	 

Wymiary	<input type="checkbox"/>	Kod artykułu		
1/4-1/2	1	71780.000.001	Zestaw do wkładek gwintowanych BSF. Zawartość: <ul style="list-style-type: none"> • Narzędzie do wkręcania dla każdego rozmiaru. • Trzpień do oderwania końcówki dla każdego rozmiaru. • Gwintownik maszynowy dla każdego rozmiaru. • Wiertła dla każdego rozmiaru. • Wkładki gwintowane ze stali nierdzewnej A2 wg DIN 8140: 1/4-5/16-3/8 - 25 szt. / 7/16-1/2 - 10 szt. 	

Narzędzia do wkładek gwintowanych V-COIL



3

Grupy katalogowe

Material	Kod	Strona
St	71782	3-166
St	71784	3-167
St	71786	3-168













71782 V-COIL Trzpień do oderwania końcówki

V01A

Material Stal

V-COIL
THREAD INSERT SYSTEM



Nr	☒	Kod artykułu		
NO.2	1	71782.020.001	<ul style="list-style-type: none"> • Odpowiednie dla wkładek gwintowanych: M2 / M2,2 / UNC No.2 	
NO.3	1	71782.030.001	<ul style="list-style-type: none"> • Odpowiednie dla wkładek gwintowanych: M2,5 	
NO.4	1	71782.040.001	<ul style="list-style-type: none"> • Odpowiednie dla wkładek gwintowanych: M3 / UNC-UNF No.4 	
NO.5	1	71782.050.001	<ul style="list-style-type: none"> • Odpowiednie dla wkładek gwintowanych: M3,5 / UNC-UNF No.6 	
NO.6	1	71782.060.001	<ul style="list-style-type: none"> • Odpowiednie dla wkładek gwintowanych: M4 / UNC-UNF No.8 / UNC No.10 / BSF 3/16 	
NO.8	1	71782.080.001	<ul style="list-style-type: none"> • Odpowiednie dla wkładek gwintowanych: M5 / UNF No.10 / UNC No.12 / BSW 3/16 	
NO.9	1	71782.090.001	<ul style="list-style-type: none"> • Odpowiednie dla wkładek gwintowanych: M6 / UNC-UNF-BSW-BSF 1/4 	
NO.11	1	71782.110.001	<ul style="list-style-type: none"> • Odpowiednie dla wkładek gwintowanych: M7 / M8 / UNC-UNF-BSW-BSF 5/16 	
NO.12	1	71782.120.001	<ul style="list-style-type: none"> • Odpowiednie dla wkładek gwintowanych: M9 / UNC-BSW-BSF 3/8 	
NO.13	1	71782.130.001	<ul style="list-style-type: none"> • Odpowiednie dla wkładek gwintowanych: M10 / UNF 3/8 	
NO.14	1	71782.140.001	<ul style="list-style-type: none"> • Odpowiednie dla wkładek gwintowanych: M11 / UNC-UNF-BSW-BSF 7/16 	
NO.15	1	71782.150.001	<ul style="list-style-type: none"> • Odpowiednie dla wkładek gwintowanych: M12 / UNC-UNF-BSW-BSF 1/2 	

71784 V-COIL Narzędzie do wkręcania				V01A
Material	Stal			
Nr	☒	Kod artykułu		
NO.2	1	71784.020.001	<ul style="list-style-type: none"> • Odpowiednie dla wkładek gwintowanych: M2 / M2,2 / UNC No.2 	
NO.3	1	71784.030.001	<ul style="list-style-type: none"> • Odpowiednie dla wkładek gwintowanych: M2,5 	
NO.4	1	71784.040.001	<ul style="list-style-type: none"> • Odpowiednie dla wkładek gwintowanych: M3 / UNC-UNF No.4 / UNC No.5 / BSW 1/8 	
NO.5	1	71784.050.001	<ul style="list-style-type: none"> • Odpowiednie dla wkładek gwintowanych: M3,5 / UNC-UNF No.6 	
NO.6	1	71784.060.001	<ul style="list-style-type: none"> • Odpowiednie dla wkładek gwintowanych: M4 / UNC-UNF No.8 	
NO.7	1	71784.070.001	<ul style="list-style-type: none"> • Odpowiednie dla wkładek gwintowanych: BSW 3/16 / UNC No.10 	
NO.8	1	71784.080.001	<ul style="list-style-type: none"> • Odpowiednie dla wkładek gwintowanych: M5 / UNF No.10 / UNC No.12 / BSW 3/16 	
NO.9	1	71784.090.001	<ul style="list-style-type: none"> • Odpowiednie dla wkładek gwintowanych: M6 / UNC-UNF-BSW-BSF 1/4 	
NO.10	1	71784.100.001	<ul style="list-style-type: none"> • Odpowiednie dla wkładek gwintowanych: M7 / UNC-BSW 5/16 	
NO.11	1	71784.110.001	<ul style="list-style-type: none"> • Odpowiednie dla wkładek gwintowanych: M8 / UNF-BSF 5/16 	
NO.12	1	71784.120.001	<ul style="list-style-type: none"> • Odpowiednie dla wkładek gwintowanych: M9 / UNC-BSW 3/8 	
NO.13	1	71784.130.001	<ul style="list-style-type: none"> • Odpowiednie dla wkładek gwintowanych: M10 / UNF-BSF 3/8 	
NO.14	1	71784.140.001	<ul style="list-style-type: none"> • Odpowiednie dla wkładek gwintowanych: M11 / UNC-UNF-BSW-BSF 7/16 	

71784		V-COIL Narzędzie do wkręcania				←
Nr	✉	Kod artykułu				
NO.15	1	71784.150.001	•	Odpowiednie dla wkładek gwintowanych:		
			•	M12 / UNC-UNF-BSW-BSF 1/2		
NO.16	1	71784.160.001	•	Odpowiednie dla wkładek gwintowanych:		
			•	M14 / UNC-UNF-BSW-BSF 9/16		
NO.17	1	71784.170.001	•	Odpowiednie dla wkładek gwintowanych:		
			•	M14		
NO.18	1	71784.180.001	•	Odpowiednie dla wkładek gwintowanych:		
			•	M16 / UNC-UNF-BSW-BSF 5/8		
NO.20	1	71784.200.001	•	Odpowiednie dla wkładek gwintowanych:		
			•	M18 / UNC- BSW-BSF 3/4		
NO.21	1	71784.210.001	•	Odpowiednie dla wkładek gwintowanych:		
			•	M11 / UNC-UNF-BSW-BSF 7/16		
NO.22	1	71784.220.001	•	Odpowiednie dla wkładek gwintowanych:		
			•	M22 / UNC-UNF-BSW-BSF 7/8		
NO.23	1	71784.230.001	•	Odpowiednie dla wkładek gwintowanych:		
			•	M24 / UNC-UNF-BSW-BSF 1.IN.		

71786		V-COIL Narzędzie do wykręcania				V01A
Materiał	Stal					

Nr	✉	Kod artykułu				
NO.2	1	71786.020.001	•	Odpowiednie dla wkładek gwintowanych:		
			•	M3 - M10 / 3/16 - 3/8		
NO.3	1	71786.030.001	•	Odpowiednie dla wkładek gwintowanych:		
			•	11 - M24 / 3/8 - 1.IN.		

Narzędzia do wkładek gwintowanych V-COIL Rapid

3



Grupy katalogowe

Material	Kod	Strona
St	71792	3-169
St	71794	3-169
St	71796	3-169
St	71798	3-170

71792 V-COIL Wiertła Rapid V01A

Material Stal



d = Dla wymiaru nominalnego	☒	Kod artykułu	d = Dla wymiaru nominalnego	☒	Kod artykułu	d = Dla wymiaru nominalnego	☒	Kod artykułu
2,6MM	1	71792.000.026	5,2MM	1	71792.000.052	10,4MM	1	71792.000.104
3,2MM	1	71792.000.032	6,3MM	1	71792.000.063	12,4MM	1	71792.000.124
4,2MM	1	71792.000.042	8,3MM	1	71792.000.083			

71794 V-COIL Gwintownik maszynowy Rapid V01A

Material Stal



d (nom.) x P	☒	Kod artykułu	d (nom.) x P	☒	Kod artykułu	d (nom.) x P	☒	Kod artykułu
M2,5X0,45	1	71794.025.045	M5X0,8	1	71794.050.080	M10X1,5	1	71794.100.150
M3X0,5	1	71794.030.050	M6X1,0	1	71794.060.100	M12X1,75	1	71794.120.175
M4X0,7	1	71794.040.070	M8X1,25	1	71794.080.125			

71796 V-COIL Trzpień do oderwania końcówki Rapid V01A

Material Stal



Nr	☒	Kod artykułu	
NO.3	1	71796.030.001	• Odpowiednie dla wkładek gwintowanych: M2,5
NO.4	1	71796.040.001	• Odpowiednie dla wkładek gwintowanych: M3
NO.6	1	71796.060.001	• Odpowiednie dla wkładek gwintowanych: M4
NO.8	1	71796.080.001	• Odpowiednie dla wkładek gwintowanych: M5



3

71796		V-COIL Trzpień do oderwania końcówki Rapid					
Nr	☒	Kod artykułu					
NO.9	1	71796.090.001	•	Odpowiednie dla wkładek gwintowanych:			
			•	M6			
NO.11	1	71796.110.001	•	Odpowiednie dla wkładek gwintowanych:			
			•	M8			
NO.13	1	71796.130.001	•	Odpowiednie dla wkładek gwintowanych:			
			•	M10			
NO.15	1	71796.150.001	•	Odpowiednie dla wkładek gwintowanych:			
			•	M12			

71798		V-COIL Narzędzie do wykręcania Rapid				V01A	
Materiał							
		Stal					

d = Dla wymiaru nominalnego	☒	Kod artykułu	d = Dla wymiaru nominalnego	☒	Kod artykułu	d = Dla wymiaru nominalnego	☒	Kod artykułu
M2,5	1	71798.025.001	M5	1	71798.050.001	M10	1	71798.100.001
M3	1	71798.030.001	M6	1	71798.060.001	M12	1	71798.120.001
M4	1	71798.040.001	M8	1	71798.080.001			

FABORY – wkładki gwintowe samonacinające

Informacje ogólne

Zasada działania wkładek gwintowych samonacinających FABORY jest prosta. Dzięki temu rozwiązaniu możliwe jest łatwe wprowadzenie solidnego gwintu metrycznego, bez konieczności wstępnego gwintowania, nie tylko do materiałów „miękkich”, takich jak aluminium, miedź, mosiądz, plastik czy drewno, ale także do materiałów metalowych o wytrzymałości na rozciąganie do 420 N/mm². Za pomocą wkładek gwintowych samonacinających FABORY można szybko i łatwo naprawić zużyte i uszkodzone gwinty.

Zasada działania

Wkładki gwintowe samonacinające FABORY wkręca się w przedmiot obrabiany za pomocą zewnętrznego gwintu, podczas gdy wewnętrzny gwint metryczny gwarantuje wyjątkowo trwałe mocowanie o wysokiej wytrzymałości na rozciąganie.

Mocowanie

Dostępne są trzy narzędzia ręczne do mocowania wkładek gwintowych samonacinających FABORY:

- narzędzie ręczne **typ 610**
- narzędzie ręczne/mechaniczne **typ 620**
- narzędzie ręczne/mechaniczne **typ 6102**
- pasują wyłącznie do wkładek gwintowych samonacinających FABORY z gniazdem sześciokątnym, **typy 302 2 i 308 2**

Do stosowania w materiałach o dużej wytrzymałości na rozciąganie polecamy:

- stosowanie odpowiedniego smaru i/lub;
- wstępne gwintowanie za pomocą ręcznego gwintownika nr 1 (gwintownik wstępny, oznaczony jednym pierścieniem).

Rodzaje wkładek gwintowych

- **Typ 302**, z dwoma rowkami oraz:
 - w wersji stalowej, do stosowania w bardziej miękkich materiałach o wytrzymałości na rozciąganie do 300 N/mm²
 - w wersji ze stali nierdzewnej, do stosowania w materiałach o wytrzymałości na rozciąganie do 320 N/mm²
- **Typ 307**, z trzema promienistymi otworami tnącymi, do stosowania w nieco twardszych materiałach o wytrzymałości na rozciąganie od 360 do 420 N/mm²
- **Typ 308**, charakterystyka taka jak typu 307; dłuższa wersja typu 307
- **Typ 302 2**, dwoma rowkami, z gniazdem sześciokątnym, do stosowania w bardziej miękkich materiałach o wytrzymałości na rozciąganie 300 N/mm²
- **Typ 308 2**, z trzema promienistymi otworami tnącymi, z gniazdem sześciokątnym, długa wersja, do stosowania w nieco twardszych materiałach o wytrzymałości na rozciąganie od 360 do 420 N/mm²

3

Średnice otworów		Zalecenia dotyczące typu 302				Zalecenia dotyczące typów 307 i 308			
obrabiany materiał	metal lekki o wytrzymałości na rozciąganie R _m (N/mm ²)	R _m < 250				R _m < 300			
		R _m < 300				R _m < 350			
		R _m < 350				R _m > 350			
	mosiądz, brąz, metal nieżelazny					R _m > 350			
	żeliwo	HB < 150				HB < 150			
	HB = twardość wg Brinella	HB < 200				HB < 200			
		HB > 200				HB > 200			
gwint wewnętrzny wkładu gwintowego	M3		4,6	4,7	4,8	4,6	4,7		4,8
	M4	5,9	6,0	6,1	6,2	6,0	6,1		6,2
	M5	7,2	7,3	7,5	7,6	7,4	7,5	7,6	7,7
	M6	8,8	9,0	9,2	9,4	9,3	9,4	9,5	9,6
	M8	10,8	11,0	11,2	11,4	11,1	11,2	11,3	11,5
	M10	12,8	13,0	13,2	13,4	13,1	13,2	13,3	13,5
	M12	14,8	15,0	15,2	15,4	15,0	15,1	15,2	15,4
	M14	16,8	17,0	17,2	17,4	17,0	17,1	17,2	17,4
	M16	18,8	19,0	19,2	19,4	19,0	19,1	19,2	19,4
	M20	24,8	25,0	25,2	25,4				
	M24	28,8	29,0	29,2	29,4				
M27	32,8	33,0	33,2	33,4					
M30	34,8	35,0	35,2	35,4					
Powierzchnia nośna gwintu ok.		60 %	50 %	40 %	30 %	80 %	70 %	60 %	50 %

Zalecane średnice otworów umożliwiające bezproblemowe wkręcanie.

W przypadku innej średnicy otworu może być konieczne smarowanie lub wstępne gwintowanie.

Kolejność montażu:

- 1) wywiercić otwór (patrz tabela powyżej),
- 2) pogłębić stożkowo otwór (zalecane),
- 3) wkręcić narzędzie umieszczające do wkładu gwintowego,
- 4) wkręcić wkład gwintowy na głębokość ok. 0,1 – 0,2 mm pod powierzchnię materiału obrabianego,
- 5) wyjąć narzędzie umieszczające,
- 6) można zamontować element złączny.

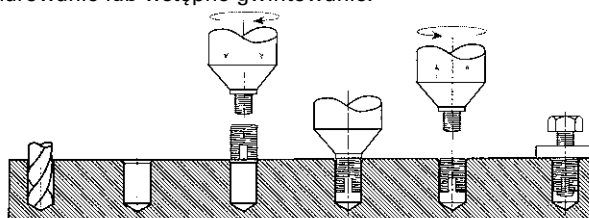

Wkładki gwintowe samonacinające, typ 302

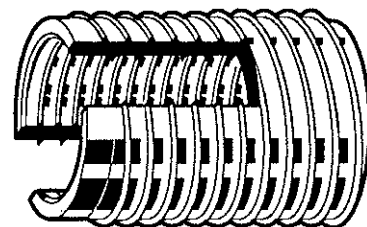
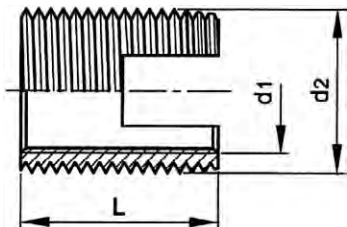

3

Informacje techniczne

$d_1 \times L$	d_2	Głębokość wiercenia (min.)	P (d_1)	P (d_2)
M3x6	5	8	0.5	0.5
M4x8	6.5	10	0.7	0.75
M5x10	8	13	0.8	1
M6x10	10	13	1	1.5
M6x12	10	15	1	1.5
M6x14	10	17	1	1.5
M8x12	12	15	1.25	1.5
M8x15	12	18	1.25	1.5
M10x15	14	18	1.5	1.5
M10x18	14	22	1.5	1.5
M12x22	16	26	1.75	1.5
M14x24	18	28	2	1.5
M16x22	20	27	2	1.5
M20x27	26	32	2.5	1.5
M24x30	30	36	3	1.5
M27x30	34	36	3.5	1.5
M30x40	36	46	3.5	1.5

- Głębokość wiercenia (min.) = Minimalna głębokość dla otworu nieprzelotowego.

Grupy katalogowe

Gwint	Materiał	Obróbka powierzchni	Kod	Strona
M	St Utwardzana powierzchniowo	Ocynek. żłt. pas.	71550	3-172
M	St.St. A1		71566	3-172
M	St.St. C4		71560	3-173

71550 Wkładki gwintowe samonacinające, typ 302

S93A

Gwint Metryczny
Materiał Stal Utwardzana powierzchniowo
Obróbka powierzchni Ocynkowane, po żółtej pasywacji

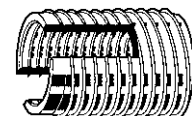

$d_1 \times L$	☒	Kod artykułu	$d_1 \times L$	☒	Kod artykułu	$d_1 \times L$	☒	Kod artykułu
M3X6	50	71550.030.001	M8X15	50	71550.080.001	M16X22	25	71550.160.001
M4X8	50	71550.040.001	M8X12	50	71550.080.012	M20X27	10	71550.200.001
M5X10	50	71550.050.001	M10X18	25	71550.100.001	M24X30	10	71550.240.001
M6X14	50	71550.060.001	M10X15	25	71550.100.015	M27X30	5	71550.270.001
M6X10	50	71550.060.010	M12X22	25	71550.120.001	M30X40	5	71550.300.001
M6X12	50	71550.060.012	M14X24	25	71550.140.001			

- Do użycia w materiałach o wytrzymałości na rozciąganie do 300N/mm².
- Lekkie stopy metali, żeliwo, mosiądz, brąz, metale nieżelazne, plastik i twarde drewno.

71566 Wkładki gwintowe samonacinające, typ 302

S93A

Gwint Metryczny
Materiał Stal nierdzewna A1

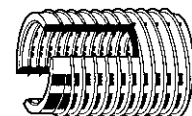

$d_1 \times L$	☒	Kod artykułu	$d_1 \times L$	☒	Kod artykułu	$d_1 \times L$	☒	Kod artykułu
M3X6	25	71566.030.001	M6X14	25	71566.060.001	M12X22	10	71566.120.001
M4X8	25	71566.040.001	M8X15	25	71566.080.001	M16X22	10	71566.160.001
M5X10	25	71566.050.001	M10X18	10	71566.100.001			

- Do użycia w materiałach o wytrzymałości na rozciąganie do 320N/mm²

71560	Wkładki gwintowe samonacinające, typ 302				S93A
Gwint	Metryczny				
Materiał	Stal nierdzewna C4				

$d_1 \times L$	☒	Kod artykułu	$d_1 \times L$	☒	Kod artykułu	$d_1 \times L$	☒	Kod artykułu
M3X6	25	71560.030.001	M6X14	25	71560.060.001	M12X22	10	71560.120.001
M4X8	25	71560.040.001	M8X15	25	71560.080.001	M16X22	10	71560.160.001
M5X10	25	71560.050.001	M10X18	10	71560.100.001			

- Do użycia w materiałach o wytrzymałości na rozciąganie do 320N/mm²

Wkładki gwintowe samonacinające, typ 307/308

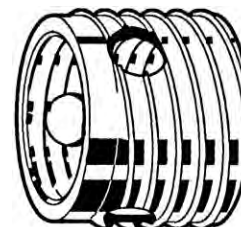
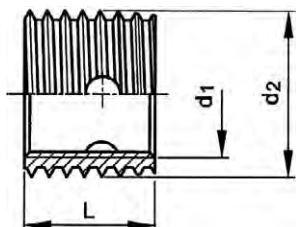

Informacje techniczne

$d_1 \times L$	d_2	Głębokość wiercenia (min.)	P (d_1)	P (d_2)
M3x4	5	6	0.5	0.6
M3x6	5	8	0.5	0.6
M4x6	6.5	8	0.7	0.8
M4x8	6.5	10	0.7	0.8
M5x7	8	9	0.8	1
M5x10	8	13	0.8	1
M6x8	10	10	1	1.25
M6x12	10	15	1	1.25
M8x9	12	11	1.25	1.5
M8x14	12	17	1.25	1.5
M10x10	14	13	1.5	1.5
M10x18	14	22	1.5	1.5
M12x12	16	15	1.75	1.75
M12x22	16	26	1.75	1.75
M16x14	20	17	2	2
M16x24	20	28	2	2

- Głębokość wiercenia (min.) = Minimalna głębokość dla otworu nieprzelotowego.

Grupy katalogowe

Gwint	Materiał	Obróbka powierzchni	Kod	Strona
M	St	Ocynk. żłt. pas.	307	71552 3-173
M	St	Ocynk. żłt. pas.	308	71554 3-174

71552	Wkładki gwintowe samonacinające, typ 307				S93A
Gwint	Metryczny				
Materiał	Stal				
Obróbka powierzchni	Ocynkowane, po żółtej pasywacji				

$d_1 \times L$	☒	Kod artykułu	$d_1 \times L$	☒	Kod artykułu	$d_1 \times L$	☒	Kod artykułu
M3X4	50	71552.030.001	M6X8	50	71552.060.001	M12X12	25	71552.120.001
M4X6	50	71552.040.001	M8X9	50	71552.080.001	M16X14	25	71552.160.001
M5X7	50	71552.050.001	M10X10	25	71552.100.001			

- Do użycia w materiałach o wytrzymałości na rozciąganie od 360 do 420N/mm².
- Aluminium i jego stopy, stopy magnezu, duroplastik i termoplastik.

71554 Wkładki gwintowe samonacinające, typ 308
S93A

Gwint Metryczny
Materiał Stal
Obróbka powierzchni Ocynkowane, po żółtej pasywacji

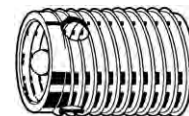

$d_1 \times L$	☒	Kod artykułu	$d_1 \times L$	☒	Kod artykułu	$d_1 \times L$	☒	Kod artykułu
M3X6	50	71554.030.001	M6X12	50	71554.060.001	M12X22	25	71554.120.001
M4X8	50	71554.040.001	M8X14	50	71554.080.001	M16X24	25	71554.160.001
M5X10	50	71554.050.001	M10X18	25	71554.100.001			

3

- Do użycia w materiałach o wytrzymałości na rozciąganie od 360 do 420N/mm².
- Aluminium i jego stopy, stopy magnezu, duroplastik i termoplastik.

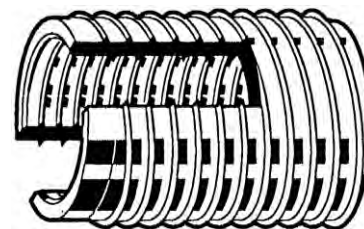
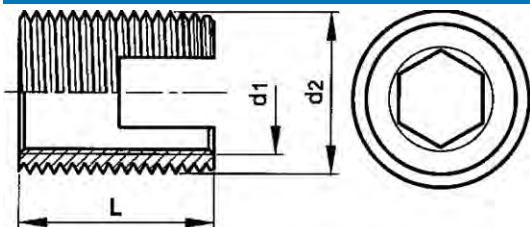
Wkładki gwintowe samonacinające z gniazdem sześciokątnym typ 302 2

Informacje techniczne

$d_1 \times L$	d_2	Grubość	Głębokość wiercenia (min.)	P (d_1)	P (d_2)	S (+0,1mm)
M4x8	6.5	8	10	0.7	0.75	3.2
M5x10	8	10	13	0.8	1	4.1
M6x14	10	14	17	1	1.5	4.9
M8x15	12	15	18	1.25	1.5	6.6
M10x18	14	18	22	1.5	1.5	8.3
M12x22	16	22	27	1.75	1.5	10.1

- Głębokość wiercenia (min.) = Minimalna głębokość dla otworu nieprzelotowego.
- Grubość - min. grubość materiału.
- S = rozmiar klucza do gniazda sześciokątnego.

71551 Wkładki gwintowe samonacinające z gniazdem sześciokątnym typ 302 2
S93A

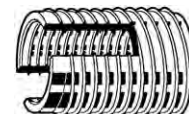
Gwint Metryczny
Materiał Stal Utwardzana powierzchniowo
Obróbka powierzchni Ocynkowane, po żółtej pasywacji



$d_1 \times L$	☒	Kod artykułu	$d_1 \times L$	☒	Kod artykułu	$d_1 \times L$	☒	Kod artykułu
M4X8	50	71551.040.008	M6X14	50	71551.060.014	M10X18	25	71551.100.018
M5X10	50	71551.050.010	M8X15	50	71551.080.015	M12X22	25	71551.120.022

- Do użycia w materiałach o wytrzymałości na rozciąganie do 300N/mm².
- Lekkie stopy metali, żeliwo, mosiądz, brąz, metale nieżelazne, plastik i twarde drewno.
- Zalety wkładek gwintowych z gniazdem sześciokąt.
- Wkładki nie trzeba wkręcać na narzędzie, to pozwala zaoszczędzić ok. 50% czasu montażu.
- Proste narzędzie montażowe 6102: za pomocą rączki-T lub opcjonalnie maszynowo.
- Narzędzie montażowe wymaga tylko obrotu zgodnie z ruchem wskazówek zegara.
- Prosty demontaż.

Wkładki gwintowe samonacinające z gniazdem sześciokątnym typ 308 2

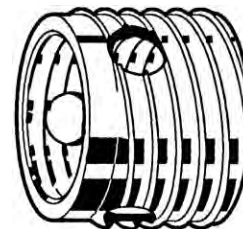
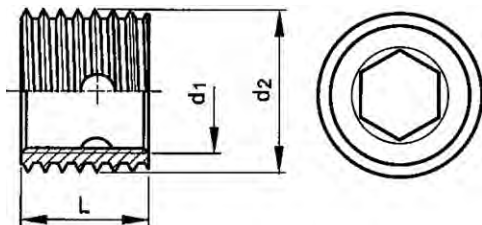

Informacje techniczne

d ₁ x L	d ₂	Grubość	Głębokość wiercenia (min.)	P (d ₁)	P (d ₂)	S (+0,1mm)
M4x8	6.5	8	10	0.7	0.8	3.2
M5x10	8	10	13	0.8	1	4.1
M6x12	10	12	15	1	1.25	4.9
M8x14	12	14	17	1.25	1.5	6.6
M10x18	14	18	22	1.5	1.5	8.3
M12x22	16	22	26	1.75	1.75	10.1

- Głębokość wiercenia (min.) = Minimalna średnica dla otworu nieprzelotowego.
- Grubość = min. Grubość materiału.
- S = rozmiar klucza do gniazda sześciokątnego.

71556 Wkładki gwintowe samonacinające z gniazdem sześciokątnym typ 308 2

S93A

Gwint Metryczny
Materiał Stal Utwardzana powierzchniowo
Obróbka powierzchni Ocynkowane, po żółtej pasywacji



d ₁ x L	☒	Kod artykułu	d ₁ x L	☒	Kod artykułu	d ₁ x L	☒	Kod artykułu
M4X8	50	71556.040.008	M6X12	50	71556.060.012	M10X18	25	71556.100.018
M5X10	50	71556.050.010	M8X14	50	71556.080.014	M12X22	25	71556.120.022

- Do użycia w materiałach o wytrzymałości na rozciąganie od 360 do 420N/mm².
- Aluminium i jego stopy, stopy magnezu, duroplastik i termoplastik.
- Zalety wkładek gwintowych z gniazdem sześciokąt.
- Wkładki nie trzeba wkręcać na narzędzie, to pozwala zaoszczędzić ok. 50% czasu montażu.
- Proste narzędzie montażowe 6102: za pomocą rączki-T lub opcjonalnie maszynowo.
- Narzędzie montażowe wymaga tylko obrotu zgodnie z ruchem wskazówek zegara.
- Prosty demontaż.

Narzędzie do wkładek gwintowych samonacinających, typ 610

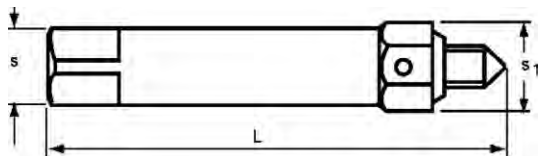

3

Informacje techniczne

d_1	L	S	S_1	d_1	L	S	S_1
M3	55	5	7	M8	75	8	13
M4	60	5	7	M10	95	12.5	19
M5	75	8	13	M12	95	12.5	19
M6	75	8	13				

- L = Długość całkowita.
- S = Kwadrat s.
- S_1 = Nakrętka kontrująca s.
- Do ręcznych aplikacji wkładek samogwintujących typy 302, 307 oraz 308 (z pomocą nklucza płaskiego).

71595 Narzędzie do wkładek gwintowych samonacinających, typ 610

S94A

Materiał Stal



Wymiar nominalny d_1	Kod artykułu	Wymiar nominalny d_1	Kod artykułu	Wymiar nominalny d_1	Kod artykułu
M3	71595.030.001	M6	71595.060.001	M10	71595.100.001
M4	71595.040.001	M8	71595.080.001	M12	71595.120.001
M5	71595.050.001				

- Uwaga: brak części zapasowych dostępnych dla tego narzędzia.

Narzędzia maszynowe do wkładek samonacinających, typ 620

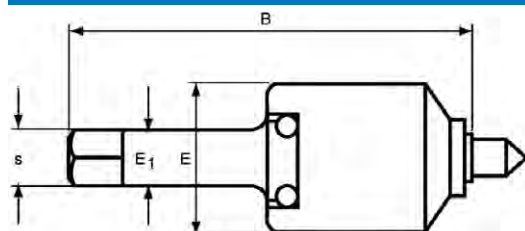

Informacje techniczne

d_1	B	E	E_1	S	d_1	B	E	E_1	S
M3	78	18	8	6.3	M14	145	50	25	20
M4	78	18	8	6.3	M16	145	50	25	20
M5	95	24	12.5	10	M20	169	58	25	20
M6	95	24	12.5	10	M24	198	70	30	25
M8	95	24	12.5	10	M27	198	70	30	25
M10	118	32	16	12.5	M30	198	70	30	25
M12	118	32	16	12.5					

- d_1 = Wymiar d_1 dla
- E = Średnica obudowy E
- E_1 = Średnica wału E_1
- S = Rozmiar kwadratu
- B = Długość
- Do narzędzia dostępne są zapasowe trzpienie gwintowane, grupa kodowa 71597.

71592		Narzędzia maszynowe do wkładek samonacinających, typ 620		S94A	
Material	Stal				

d ₁	☒	Kod artykułu	d ₁	☒	Kod artykułu	d ₁	☒	Kod artykułu
M3	1	71592.030.001	M10	1	71592.100.001	M20	1	71592.200.001
M4	1	71592.040.001	M12	1	71592.120.001	M24	1	71592.240.001
M5	1	71592.050.001	M14	1	71592.140.001	M27	1	71592.270.001
M6	1	71592.060.001	M16	1	71592.160.001	M30	1	71592.300.001
M8	1	71592.080.001						

3

Akcesoria narzędzi maszynowych

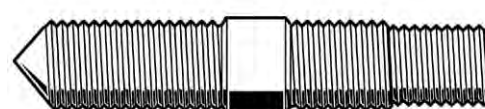

71597		Akcesoria narzędzi maszynowych		S94A	
					

d	☒	Kod artykułu	d	☒	Kod artykułu	d	☒	Kod artykułu
M3	1	71597.030.001	M10	1	71597.100.001	M20	1	71597.200.001
M4	1	71597.040.001	M12	1	71597.120.001	M22	1	71597.220.001
M5	1	71597.050.001	M14	1	71597.140.001	M24	1	71597.240.001
M6	1	71597.060.001	M16	1	71597.160.001	M30	1	71597.300.001
M8	1	71597.080.001						

Narzędzie do wkładek samonacinających, typ 6102

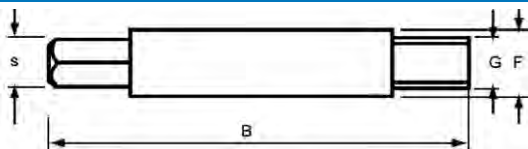

3

Informacje techniczne

Dla wymiaru nominalnego d_1	B	F	G	s	Dla wymiaru nominalnego d_1	B	F	G	s
M4	80	6	4.9	3.2	M8	100	10	8	6.6
M5	90	8	6.2	4.1	M10	110	12	9	8.3
M6	100	10	8	4.9	M12	125	14	11	10.1

- s = Sześciokąt s (nom.).
- F = Średnica wałka F.
- G = Rozmiar kwadratu G.
- B = Długość całkowita B.

71580 Narzędzie do wkładek samonacinających, typ 6102

S94A

Materiał Stal



Dla wymiaru nominalnego d_1	☒	Kod artykułu	Dla wymiaru nominalnego d_1	☒	Kod artykułu	Dla wymiaru nominalnego d_1	☒	Kod artykułu
M4	1	71580.040.001	M6	1	71580.060.001	M10	1	71580.100.001
M5	1	71580.050.001	M8	1	71580.080.001	M12	1	71580.120.001

- Narzędzie ręczne/maszynowe 6102 służy wyłącznie do montażu wkładek z gniazdem sześciokątnym typ 302 2 oraz 308 2.
- Zalety wkładek gwintowych z gniazdem sześciokątnym.
- Wkładki nie trzeba wkręcać na narzędzie, to pozwala zaoszczędzić ok. 50% czasu montażu.
- Proste narzędzie montażowe 6102: za pomocą rączki-T lub opcjonalnie maszynowo.
- Narzędzie montażowe wymaga tylko obrotu zgodnie z ruchem wskazówek zegara.
- Prosty demontaż.

FABORY – wkładki gwintowe samonacinające

Porada dotycząca montażu

Jak już wspomniano, dostępne są trzy narzędzia ręczne do mocowania wkładek gwintowych samonacinających FABORY:

- Wkładki gwintowe samonacinające FABORY z gniazdem sześciokątnym typu **302 2** i **308 2** można mocować za pomocą narzędzi ręcznych/mechanicznych typu **6102**;
- narzędzie ręczne **typ 610**;
- narzędzie ręczne/mechaniczne **typ 620**.

Oba pasują do wkładek gwintowych samonacinających FABORY BEZ gniazda sześciokątnego: typy 302, 307 i 308.

W przypadku mocowania awaryjnego lub szybkiego kilku typów wkładek gwintowych samonacinających FABORY można użyć także nakrętki i śruby odpowiedniego rozmiaru.

Wkładki gwintowe samonacinające FABORY typu 302 są także dostępne w pudełku zbiorczym (S572). W sumie 420 elementów, w rozmiarach od M3 do M16; stalowe, cynkowane po żółtej pasywacji, niektóre rozmiary ze stali nierdzewnej C4 (nr artykułu 41010.000.572).

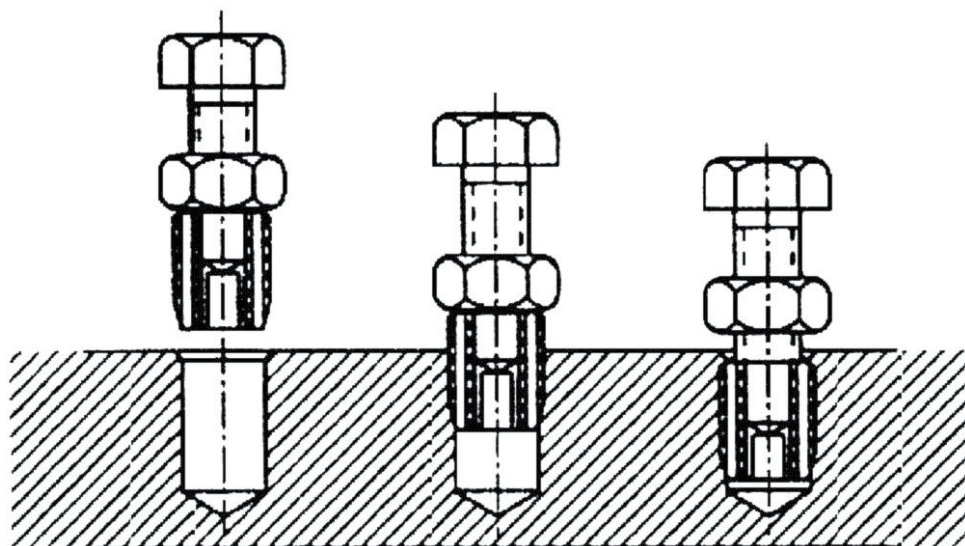

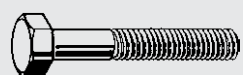

1 Śruby



2 Produkty z gniazdem sześciokątnym



3 Nakrętki, nitonakrętki & wkładki



4 Pręty gwintowane & śruby dwustronne



5 Haki & śruby oczkowe



6 Wkręty

I Index



7 Podkładki & pierścienie uszczelniające typu “O-ring”



8 Kotwy, kołki, dyble



9 Nity, kołki & wpusty



10 Elementy łączące systemowe, meblowe & zabezpieczające



11 Zestawy

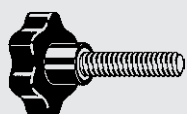



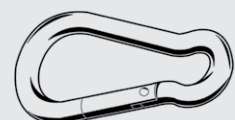

















12 Części konstrukcyjne & części maszynowe

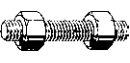
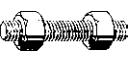

13 Przemysł morski

T Technologia łączenia

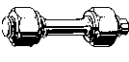
Pręty gwintowane & śruby dwustronne⁴

 Strona 4-2 DIN 976-1A Metryczny	 Strona 4-12 DIN ≈976-1 Metryczny drobny	 Strona 4-14 ASME B18.31.3 UNC	 Strona 4-17 ASME B18.31.3 UNF	 Strona 4-20 BSW
 Strona 4-21 PERMAGLAS, metryczny	 Strona 4-22 PERMAGLAS, metryczny	 Strona 4-23 PERMAGLAS	 Strona 4-24 Trapezowy Tr	 Strona 4-25 Z gwintem trapezowym Tr
 Strona 4-26 Z gwintem trapezowym Tr Brąz	 Strona 4-27 DIN 938 ≈ 1d metryczna	 Strona 4-29 DIN 939 ≈ 1,25d metryczna	 Strona 4-33 DIN ≈939 (1955) ≈ 1,25d BSW	 Strona 4-34 DIN 835 ≈ 2d metryczna
 Strona 4-35 ASTM, UNC	 Strona 4-38 ASTM, metryczny	 Strona 4-39 ASME B16.5 Śr. dwustronne z nakrętkami, UNC	 Strona 4-55 BS ≈4882 Śr. dwustronne z nakrętkami, metryczne	 Strona 4-57 ASME B18.2.2 ASTM UNC
 Strona 4-59 ASTM, metryczna	 Strona 4-61 DIN 2510 L/NF Śr. dwustronne z przewężeniem i nakrętkami	 Strona 4-62 DIN 2510 NF Do śrub dwustronnych, metryczna		

Pręty gwintowane, metryczne

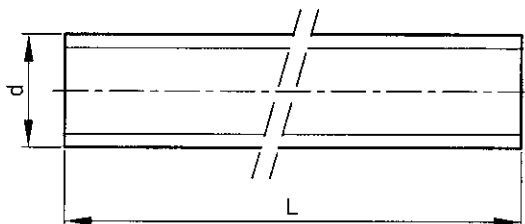

DIN 976-1A
NEN ≈2369
NF ≈25-136



Informacje techniczne

d	P	d	P
M2	0.4	M27	3
M2.5	0.45	M30	3.5
M3	0.5	M33	3.5
M4	0.7	M36	4
M5	0.8	M39	4
M6	1	M42	4.5
M7 (#DIN)	1	M45	4.5
M8	1.25	M48	5
M10	1.5	M52	5
M12	1.75	M56	5.5
M14	2	M60	5.5
M16	2	M64	6
M18	2.5	M68	6
M20	2.5	M72	6
M22	2.5	M76 (#DIN)	6
M24	3	M80 (#DIN)	6

Końcówka pręta gwintowanego jest kolorowana aby poprawić rozpoznanie jego wykonani

Oznaczenie kolorami prętów gwintowanych		
Klasa	Materiał	Kolor
4.8	Stal ocynkowana	kolor własny
4.8	ISO metryczne, gorący ocynk	jasnoniebieski
4.8	Pręty metryczne w gorącym ocynku nadwymiarowe	pomarańczowy
5.6	Stal	brązowy
5.8	Stal	gencjanowy niebieski
8.8	Stal, pasywacja biała i żółta	żółty
8.8	ISO metryczne, gorący ocynk	szary stalowy
8.8	Pręty metryczne w gorącym ocynku nadwymiarowe	fioletowy
10.9	Stal	biały
12.9	Stal	czarny
ASTM-B7	Stal (UNC & 8UN)	kolor własny
ASTM-B7	Stal (metryczne)	kolor własny
St.St.-A2	Stal nierdzewna A2 metryczne	zielony
St.St.-A4	Stal nierdzewna A4 metryczne	czerwony

Grupy katalogowe

Gwint	Materiał	Klasa	Obróbka powierzchni	Kolor	Kod	Strona
M	St	≥4.8	Ocynk. żłt. pas.		20108	4-3
M	St.St. A2	70			51068	4-3
M	St.St. A4	70			55068	4-4
M	St	≥4.8		1 metr	20200	4-4
M	St	≥4.8	Ocynk.	1 metr	20300	4-5
M	St	≥4.8	Ocynk.	1 metr, lewy gwint	20380	4-5
M	St	≥4.8	Ocynk. żłt. pas.	1 metr	20302	4-5
M	St	≥4.8	Ocynk. gor.	1 metr, nadwymiarowy	20140	4-5
M	St	≥4.8	Ocynk. gor.	1 metr ISO	20160	4-5
M	St	8.8		1 metr	20220	4-6
M	St	8.8	Ocynk.	1 metr	20230	4-6
M	St	8.8	Ocynk.	1 metr, lewy gwint	20376	4-6
M	St	8.8	Ocynk. żłt. pas.	1 metr	20232	4-6
M	St	8.8	Ocynk. gor.	1 metr, nadwymiarowy	20150	4-7
M	St	8.8	Ocynk. gor.	1 metr ISO	20170	4-7
M	St	10.9		1 metr	20130	4-7
M	St	12.9		1 metr	20132	4-7

Grupy katalogowe

Gwint	Materiał	Klasa	Obróbka powierzchni	Kolor	Kod	Strona
M	St.St. A2	70			51070	4-8
M	St.St. A2	70			51064	4-8
M	St.St. A4	70			55070	4-8
M	St.St. A2	70			51074	4-8
M	St.St. A4	70			55074	4-9
M	Al P40				45070	4-9
M	Al P60				45270	4-9
M	Ti	Gr.2			45940	4-9
M	Mosiądz Cu2/Cu3				46090	4-9
M	Plastik PA	PA 6.6		Biały	56170	4-9
M	St	≥4.8	Ocynk.		20330	4-10
M	St	≥4.8	Ocynk. gor.		20145	4-10
M	St	8.8	Ocynk.		20372	4-10
M	St	8.8	Ocynk. gor.		20155	4-10
M	St.St. A2	70			51071	4-10
M	St.St. A4	70			55071	4-11
M	St	≥4.8	Ocynk.		20410	4-11
M	St	≥4.8	Ocynk. gor.		20147	4-11
M	St	8.8	Ocynk.		20395	4-11
M	St	8.8	Ocynk. gor.		20157	4-11
M	St.St. A2	70			51072	4-12
M	St.St. A4	70			55072	4-12

4

20108 Śruby dwustronne z gwintem na całej długości

G05A

Gwint Metryczny
 Materiał Stal
 Klasa ≥4.8
 Obróbka powierzchni Ocynkowane, po żółtej pasywacji



d x L	☒	Kod artykułu	d x L	☒	Kod artykułu	d x L	☒	Kod artykułu
M3X20	200	20108.030.020	M5X120	100	20108.050.120	M8X150	50	20108.080.150
M3X30	200	20108.030.030				M8X160	50	20108.080.160
M3X40	200	20108.030.040	M6X20	200	20108.060.020			
M3X50	200	20108.030.050	M6X30	200	20108.060.030	M10X30	100	20108.100.030
M3X60	200	20108.030.060	M6X40	200	20108.060.040	M10X40	100	20108.100.040
M3X70	200	20108.030.070	M6X50	200	20108.060.050	M10X50	100	20108.100.050
M3X80	200	20108.030.080	M6X60	200	20108.060.060	M10X60	100	20108.100.060
M3X90	200	20108.030.090	M6X70	200	20108.060.070	M10X70	100	20108.100.070
M3X100	200	20108.030.100	M6X80	100	20108.060.080	M10X80	100	20108.100.080
			M6X90	100	20108.060.090	M10X90	100	20108.100.090
M4X20	200	20108.040.020	M6X100	100	20108.060.100	M10X100	100	20108.100.100
M4X30	200	20108.040.030	M6X120	100	20108.060.120	M10X120	50	20108.100.120
M4X40	200	20108.040.040	M6X130	100	20108.060.130	M10X130	50	20108.100.130
M4X50	200	20108.040.050	M6X140	100	20108.060.140	M10X140	50	20108.100.140
M4X60	200	20108.040.060	M6X150	100	20108.060.150	M10X150	50	20108.100.150
M4X70	200	20108.040.070	M6X160	100	20108.060.160	M10X160	50	20108.100.160
M4X80	200	20108.040.080						
M4X90	100	20108.040.090	M8X30	200	20108.080.030	M12X40	100	20108.120.040
M4X100	100	20108.040.100	M8X40	200	20108.080.040	M12X50	100	20108.120.050
			M8X50	200	20108.080.050	M12X60	100	20108.120.060
M5X20	200	20108.050.020	M8X60	100	20108.080.060	M12X70	50	20108.120.070
M5X30	200	20108.050.030	M8X70	100	20108.080.070	M12X80	50	20108.120.080
M5X40	200	20108.050.040	M8X75	100	20108.080.075	M12X90	50	20108.120.090
M5X50	200	20108.050.050	M8X80	100	20108.080.080	M12X100	50	20108.120.100
M5X60	200	20108.050.060	M8X90	100	20108.080.090	M12X120	50	20108.120.120
M5X70	200	20108.050.070	M8X100	100	20108.080.100	M12X130	50	20108.120.130
M5X80	100	20108.050.080	M8X120	100	20108.080.120	M12X140	50	20108.120.140
M5X90	100	20108.050.090	M8X130	100	20108.080.130	M12X150	50	20108.120.150
M5X100	100	20108.050.100	M8X140	50	20108.080.140	M12X160	25	20108.120.160

51068 Śruby dwustronne z gwintem na całej długości

R09A

Gwint Metryczny
 Materiał Stal nierdzewna A2
 Klasa 70



d x L	☒	Kod artykułu	d x L	☒	Kod artykułu	d x L	☒	Kod artykułu
M4X20	100	51068.040.020	M4X50	100	51068.040.050	M5X30	100	51068.050.030
M4X30	100	51068.040.030	M4X60	100	51068.040.060	M5X40	100	51068.050.040
M4X40	100	51068.040.040				M5X50	100	51068.050.050

51068 Śruby dwustronne z gwintem na całej długości ←

d x L	☒	Kod artykułu	d x L	☒	Kod artykułu	d x L	☒	Kod artykułu
M5X60	100	51068.050.060	M8X50	100	51068.080.050	M10X150	25	51068.100.150
M5X70	100	51068.050.070	M8X60	50	51068.080.060	M10X160	25	51068.100.160
M5X80	50	51068.050.080	M8X70	50	51068.080.070			
M5X90	50	51068.050.090	M8X80	50	51068.080.080	M12X40	50	51068.120.040
M5X100	50	51068.050.100	M8X90	50	51068.080.090	M12X50	50	51068.120.050
M5X120	50	51068.050.120	M8X100	50	51068.080.100	M12X60	50	51068.120.060
			M8X120	50	51068.080.120	M12X65	25	51068.120.065
M6X30	100	51068.060.030	M8X130	50	51068.080.130	M12X70	25	51068.120.070
M6X40	100	51068.060.040	M8X140	25	51068.080.140	M12X80	25	51068.120.080
M6X50	100	51068.060.050	M8X150	25	51068.080.150	M12X90	25	51068.120.090
M6X60	100	51068.060.060	M8X160	25	51068.080.160	M12X100	25	51068.120.100
M6X70	100	51068.060.070	M8X200	25	51068.080.200	M12X120	25	51068.120.120
M6X80	50	51068.060.080				M12X130	25	51068.120.130
M6X90	50	51068.060.090	M10X40	50	51068.100.040	M12X140	25	51068.120.140
M6X100	50	51068.060.100	M10X50	50	51068.100.050	M12X150	25	51068.120.150
M6X120	50	51068.060.120	M10X60	50	51068.100.060	M12X160	10	51068.120.160
M6X130	50	51068.060.130	M10X70	50	51068.100.070			
M6X140	50	51068.060.140	M10X80	50	51068.100.080	M16X65	10	51068.160.065
M6X150	50	51068.060.150	M10X90	50	51068.100.090	M16X80	10	51068.160.080
M6X160	50	51068.060.160	M10X100	50	51068.100.100			
			M10X120	25	51068.100.120	M20X100	10	51068.200.100
M8X30	100	51068.080.030	M10X130	25	51068.100.130	M20X150	10	51068.200.150
M8X40	100	51068.080.040	M10X140	25	51068.100.140			

• Rozmiary o średnicy > M24 mają minimalnie klasę właściwości 50.

55068 Śruby dwustronne z gwintem na całej długości R49A

Gwint Metryczny
Materiał Stal nierdzewna A4
Klasa 70



d x L	☒	Kod artykułu	d x L	☒	Kod artykułu	d x L	☒	Kod artykułu
M4X20	100	55068.040.020	M8X50	100	55068.080.050	M10X140	25	55068.100.140
			M8X60	50	55068.080.060	M10X150	25	55068.100.150
M5X30	100	55068.050.030	M8X70	50	55068.080.070			
M5X40	100	55068.050.040	M8X80	50	55068.080.080	M12X40	50	55068.120.040
M5X50	100	55068.050.050	M8X100	50	55068.080.100	M12X50	50	55068.120.050
M5X60	100	55068.050.060	M8X120	50	55068.080.120	M12X60	50	55068.120.060
M5X80	50	55068.050.080	M8X130	50	55068.080.130	M12X70	25	55068.120.070
			M8X160	25	55068.080.160	M12X80	25	55068.120.080
M6X30	100	55068.060.030				M12X100	25	55068.120.100
M6X40	100	55068.060.040	M10X40	50	55068.100.040	M12X120	25	55068.120.120
M6X50	100	55068.060.050	M10X50	50	55068.100.050	M12X130	25	55068.120.130
M6X60	100	55068.060.060	M10X60	50	55068.100.060	M12X150	25	55068.120.150
M6X70	100	55068.060.070	M10X70	50	55068.100.070	M12X160	10	55068.120.160
M6X80	50	55068.060.080	M10X80	50	55068.100.080			
M6X100	50	55068.060.100	M10X90	50	55068.100.090	M16X50	10	55068.160.050
			M10X100	50	55068.100.100	M16X60	50	55068.160.060
M8X30	100	55068.080.030	M10X120	25	55068.100.120			
M8X40	100	55068.080.040	M10X130	25	55068.100.130	M20X340	1	55068.200.340

• Rozmiary o średnicy > M24 mają minimalnie klasę właściwości 50.

20200 Pręty gwintowane, długość 1m G01A

Gwint Metryczny
Materiał Stal
Klasa ≥4.8



d	☒	Kod artykułu	d	☒	Kod artykułu	d	☒	Kod artykułu
M2	20	20200.020.001	M18	5	20200.180.001	M45	2	20200.450.001
M3	20	20200.030.001	M20	2	20200.200.001	M48	2	20200.480.001
M4	20	20200.040.001	M22	2	20200.220.001	M52	1	20200.520.001
M5	10	20200.050.001	M24	2	20200.240.001	M56	1	20200.560.001
M6	10	20200.060.001	M27	2	20200.270.001	M60	1	20200.600.001
M7	10	20200.070.001	M30	2	20200.300.001	M64	1	20200.640.001
M8	10	20200.080.001	M33	2	20200.330.001	M68	1	20200.680.001
M10	10	20200.100.001	M36	2	20200.360.001	M72	1	20200.720.001
M12	10	20200.120.001	M39	2	20200.390.001	M76	1	20200.760.001
M14	5	20200.140.001	M42	2	20200.420.001	M80	1	20200.800.001
M16	5	20200.160.001						

20300 Pręty gwintowane, długość 1m		G03A	
Gwint	Metryczny		
Materiał	Stal		
Klasa	≥4.8		
Obróbka powierzchni	Ocynkowane		

d	☒	Kod artykułu	d	☒	Kod artykułu	d	☒	Kod artykułu
M3	20	20300.030.001	M12	10	20300.120.001	M27	2	20300.270.001
M4	20	20300.040.001	M14	5	20300.140.001	M30	2	20300.300.001
M5	10	20300.050.001	M16	5	20300.160.001	M33	2	20300.330.001
M6	10	20300.060.001	M18	5	20300.180.001	M36	2	20300.360.001
M7	10	20300.070.001	M20	2	20300.200.001	M39	2	20300.390.001
M8	10	20300.080.001	M22	2	20300.220.001	M42	2	20300.420.001
M10	10	20300.100.001	M24	2	20300.240.001	M45	1	20300.450.001

20380 Pręty gwintowane, długość 1m, z lewym gwintem		G05A	
Gwint	Metryczny		
Materiał	Stal		
Klasa	≥4.8		
Obróbka powierzchni	Ocynkowane		

d	☒	Kod artykułu	d	☒	Kod artykułu	d	☒	Kod artykułu
M3	10	20380.030.001	M10	2	20380.100.001	M20	1	20380.200.001
M4	10	20380.040.001	M12	2	20380.120.001	M22	1	20380.220.001
M5	5	20380.050.001	M14	1	20380.140.001	M24	1	20380.240.001
M6	2	20380.060.001	M16	1	20380.160.001	M27	1	20380.270.001
M8	2	20380.080.001	M18	1	20380.180.001	M30	1	20380.300.001

20302 Pręty gwintowane, długość 1m		G03A	
Gwint	Metryczny		
Materiał	Stal		
Klasa	≥4.8		
Obróbka powierzchni	Ocynkowane, po żółtej pasywacji		

d	☒	Kod artykułu	d	☒	Kod artykułu	d	☒	Kod artykułu
M5	10	20302.050.001	M10	10	20302.100.001	M20	2	20302.200.001
M6	10	20302.060.001	M12	10	20302.120.001	M24	2	20302.240.001
M8	10	20302.080.001	M16	5	20302.160.001			

20140 Pręty gwintowane, długość 1m, gwint nadwymiarowy		A08C	
Gwint	Metryczny		
Materiał	Stal		
Klasa	≥4.8		
Obróbka powierzchni	Ocynkowane na gorąco		

d	☒	Kod artykułu	d	☒	Kod artykułu	d	☒	Kod artykułu
M10	5	20140.100.001	M20	3	20140.200.001	M30	2	20140.300.001
M12	5	20140.120.001	M24	3	20140.240.001	M33	2	20140.330.001
M16	5	20140.160.001	M27	2	20140.270.001	M36	2	20140.360.001

- Dla prętów gwintowanych cynkowanych na gorąco z gwintem NADWYMIAROWYM warstwa cynku jest nakładana na normalny gwint tak, że po cynkowaniu pręty gwintowane nie są już ISO-metryczne i pasujące, ale grubsze: tak zwane NADWYMIAROWE.
- Nie pasują do standardowych gwintów i nie mogą być stosowane w izometrycznie nagwintowanych otworach.
- Odpowiadające im nakrętki NADWYMIAROWE zostały nagwintowane o około 0,3 mm więcej, tak aby idealnie pasowały do śrub po cynkowaniu.

20160 Pręty gwintowane, długość 1m, gwint izometryczny dopasowany		A08C	
Gwint	Metryczny		
Materiał	Stal		
Klasa	≥4.8		
Obróbka powierzchni	Ocynkowane na gorąco		

d	☒	Kod artykułu	d	☒	Kod artykułu	d	☒	Kod artykułu
M10	5	20160.100.001	M20	3	20160.200.001	M30	2	20160.300.001
M12	5	20160.120.001	M24	3	20160.240.001	M36	2	20160.360.001
M16	5	20160.160.001	M27	2	20160.270.001			

20160 Pręty gwintowane, długość 1m, gwint izometryczny dopasowany

- Dla prętów gwintowanych cynkowanych na gorąco z gwintem IZOMETRYCZNYM DOPASOWANYM, gwint jest walcowany poniżej rozmiaru, tak aby odpowiadał sprawdzianowi przechodniemu o klasie tolerancji h po cynkowaniu.
- Zaletą tej metody produkcji jest to, że pręty gwintowane mogą być bez przeszkód stosowane w każdym nagwintowanym otworze.
- Odpowiadające im nakrętki IZOMETRYCZNE DOPASOWANE zostały nagwintowane zgodnie Gwint nadwymiarowy wg ISO 965-5, tak aby doskonale pasowały do śrub.

20220 Pręty gwintowane, długość 1m
G04A

Gwint Metryczny
 Materiał Stal
 Klasa 8.8



d	☒	Kod artykułu	d	☒	Kod artykułu	d	☒	Kod artykułu
M5	10	20220.050.001	M20	3	20220.200.001	M42	1	20220.420.001
M6	10	20220.060.001	M22	3	20220.220.001	M45	1	20220.450.001
M8	10	20220.080.001	M24	3	20220.240.001	M48	1	20220.480.001
M10	10	20220.100.001	M27	2	20220.270.001	M52	1	20220.520.001
M12	5	20220.120.001	M30	2	20220.300.001	M56	1	20220.560.001
M14	5	20220.140.001	M33	2	20220.330.001	M60	1	20220.600.001
M16	5	20220.160.001	M36	2	20220.360.001	M64	1	20220.640.001
M18	3	20220.180.001	M39	1	20220.390.001			

20230 Pręty gwintowane, długość 1m
G04A

Gwint Metryczny
 Materiał Stal
 Klasa 8.8
 Obróbka powierzchni Ocynkowane



d	☒	Kod artykułu	d	☒	Kod artykułu	d	☒	Kod artykułu
M4	10	20230.040.001	M18	3	20230.180.001	M39	1	20230.390.001
M5	10	20230.050.001	M20	3	20230.200.001	M42	1	20230.420.001
M6	10	20230.060.001	M22	3	20230.220.001	M45	1	20230.450.001
M8	10	20230.080.001	M24	3	20230.240.001	M48	1	20230.480.001
M10	10	20230.100.001	M27	2	20230.270.001	M52	1	20230.520.001
M12	5	20230.120.001	M30	2	20230.300.001	M56	1	20230.560.001
M14	5	20230.140.001	M33	2	20230.330.001	M60	1	20230.600.001
M16	5	20230.160.001	M36	2	20230.360.001	M64	1	20230.640.001

20376 Pręty gwintowane, długość 1m, z lewym gwintem
G05A

Gwint Metryczny
 Materiał Stal
 Klasa 8.8
 Obróbka powierzchni Ocynkowane



d	☒	Kod artykułu	d	☒	Kod artykułu	d	☒	Kod artykułu
M6	2	20376.060.001	M12	2	20376.120.001	M24	1	20376.240.001
M8	2	20376.080.001	M16	1	20376.160.001	M30	1	20376.300.001
M10	2	20376.100.001	M20	1	20376.200.001			

20232 Pręty gwintowane, długość 1m
G06A

Gwint Metryczny
 Materiał Stal
 Klasa 8.8
 Obróbka powierzchni Ocynkowane, po żółtej pasywacji



d	☒	Kod artykułu	d	☒	Kod artykułu	d	☒	Kod artykułu
M6	10	20232.060.001	M14	5	20232.140.001	M20	3	20232.200.001
M8	10	20232.080.001	M16	5	20232.160.001	M22	3	20232.220.001
M10	10	20232.100.001	M18	3	20232.180.001	M24	3	20232.240.001
M12	5	20232.120.001						

20150 Pręty gwintowane, długość 1m, gwint nadwymiarowy		A08C
Gwint	Metryczny	
Materiał	Stal	
Klasa	8.8	
Obróbka powierzchni	Ocynkowane na gorąco	

d	☒	Kod artykułu	d	☒	Kod artykułu	d	☒	Kod artykułu
M10	5	20150.100.001	M27	2	20150.270.001	M39	1	20150.390.001
M12	5	20150.120.001	M30	2	20150.300.001	M42	1	20150.420.001
M16	5	20150.160.001	M33	2	20150.330.001	M45	1	20150.450.001
M20	3	20150.200.001	M36	2	20150.360.001	M48	1	20150.480.001
M24	3	20150.240.001						

- Dla prętów gwintowanych cynkowanych na gorąco z gwintem NADWYMIAROWYM warstwa cynku jest nakładana na normalny gwint tak, że po cynkowaniu pręty gwintowane nie są już ISO-metryczne i pasujące, ale grubsze: tak zwane NADWYMIAROWE.
- Nie pasują do standardowych gwintów i nie mogą być stosowane w izometrycznie nagwintowanych otworach.
- Odpowiadające im nakrętki NADWYMIAROWE zostały nagwintowane o około 0,3 mm więcej, tak aby idealnie pasowały do śrub po cynkowaniu.

4

20170 Pręty gwintowane, długość 1m, gwint izometryczny dopasowany		A08C
Gwint	Metryczny	
Materiał	Stal	
Klasa	8.8	
Obróbka powierzchni	Ocynkowane na gorąco	

d	☒	Kod artykułu	d	☒	Kod artykułu	d	☒	Kod artykułu
M10	5	20170.100.001	M24	3	20170.240.001	M39	1	20170.390.001
M12	5	20170.120.001	M27	2	20170.270.001	M42	1	20170.420.001
M16	5	20170.160.001	M30	2	20170.300.001	M45	1	20170.450.001
M20	3	20170.200.001	M36	2	20170.360.001			

- Dla prętów gwintowanych cynkowanych na gorąco z gwintem IZOMETRYCZNYM DOPASOWANYM, gwint jest walcowany poniżej rozmiaru, tak aby odpowiadał sprawdzianowi przechodniemu o klasie tolerancji h po cynkowaniu.
- Zaletą tej metody produkcji jest to, że śruby mogą być bez przeszkód stosowane w każdym nagwintowanym otworze.
- Odpowiadające im nakrętki IZOMETRYCZNE DOPASOWANE zostały nagwintowane zgodnie z klasą tolerancji 6H po cynkowaniu, tak aby doskonale pasowały do śrub.

20130 Pręty gwintowane, długość 1m		G04A
Gwint	Metryczny	
Materiał	Stal	
Klasa	10.9	

d	☒	Kod artykułu	d	☒	Kod artykułu	d	☒	Kod artykułu
M5	5	20130.050.001	M16	3	20130.160.001	M30	2	20130.300.001
M6	5	20130.060.001	M18	3	20130.180.001	M33	2	20130.330.001
M8	5	20130.080.001	M20	3	20130.200.001	M36	2	20130.360.001
M10	5	20130.100.001	M22	3	20130.220.001	M39	2	20130.390.001
M12	5	20130.120.001	M24	3	20130.240.001	M42	1	20130.420.001
M14	5	20130.140.001	M27	2	20130.270.001	M45	1	20130.450.001

- Ostrzeżenie: cynkowanie elektrolityczne tych produktów może wywołać kruchość wodorową.

20132 Pręty gwintowane, długość 1m		G04A
Gwint	Metryczny	
Materiał	Stal	
Klasa	12.9	

d	☒	Kod artykułu	d	☒	Kod artykułu	d	☒	Kod artykułu
M8	5	20132.080.001	M16	3	20132.160.001	M27	2	20132.270.001
M10	5	20132.100.001	M20	3	20132.200.001	M30	2	20132.300.001
M12	5	20132.120.001	M24	3	20132.240.001			

- Ostrzeżenie: cynkowanie elektrolityczne tych produktów może wywołać kruchość wodorową.

51070		Pręty gwintowane, długość 1m		Q03A	
Gwint	Metryczny	Materiał	Stal nierdzewna A2		
Klasa	70				

d	☒	Kod artykułu	d	☒	Kod artykułu	d	☒	Kod artykułu
M2*	20	51070.020.001	M12	5	51070.120.001	M30	1	51070.300.001
M2,5*	20	51070.025.001	M14	5	51070.140.001	M33	1	51070.330.001
M3	10	51070.030.001	M16	5	51070.160.001	M36	1	51070.360.001
M4	10	51070.040.001	M18	3	51070.180.001	M39*	5	51070.390.001
M5	10	51070.050.001	M20	3	51070.200.001	M42*	5	51070.420.001
M6	10	51070.060.001	M22	2	51070.220.001	M45*	5	51070.450.001
M8	10	51070.080.001	M24	2	51070.240.001	M48*	5	51070.480.001
M10	10	51070.100.001	M27	1	51070.270.001	M52*	1	51070.520.001

• Rozmiary o średnicy > M24 mają minimalnie klasę właściwości 50.

4

51064		Pręty gwintowane, długość 1m		Q03A	
Gwint	Metryczny	Materiał	Stal nierdzewna A2		
Klasa	70				

d	☒	Kod artykułu	d	☒	Kod artykułu	d	☒	Kod artykułu
M6	50	51064.060.001	M10	25	51064.100.001	M16	15	51064.160.001
M8	25	51064.080.001	M12	25	51064.120.001			

• Rozmiary o średnicy > M24 mają minimalnie klasę właściwości 50.

55070		Pręty gwintowane, długość 1m		Q43A	
Gwint	Metryczny	Materiał	Stal nierdzewna A4		
Klasa	70				

d	☒	Kod artykułu	d	☒	Kod artykułu	d	☒	Kod artykułu
M2	10	55070.020.001	M12	5	55070.120.001	M30	1	55070.300.001
M2,5	10	55070.025.001	M14	5	55070.140.001	M33	1	55070.330.001
M3	10	55070.030.001	M16	5	55070.160.001	M36	1	55070.360.001
M4	10	55070.040.001	M18	3	55070.180.001	M39*	5	55070.390.001
M5	10	55070.050.001	M20	3	55070.200.001	M42*	5	55070.420.001
M6	10	55070.060.001	M22	2	55070.220.001	M45*	5	55070.450.001
M8	10	55070.080.001	M24	2	55070.240.001	M48*	5	55070.480.001
M10	10	55070.100.001	M27	1	55070.270.001	M52*	1	55070.520.001

• Rozmiary o średnicy > M24 mają minimalnie klasę właściwości 50.

51074		Pręty gwintowane, długość 1m, z lewym gwintem		R09A	
Gwint	Metryczny	Materiał	Stal nierdzewna A2		
Klasa	70				

d	☒	Kod artykułu	d	☒	Kod artykułu	d	☒	Kod artykułu
M5*	100	51074.050.001	M12	2	51074.120.001	M18*	10	51074.180.001
M6	2	51074.060.001	M14*	10	51074.140.001	M20	1	51074.200.001
M8	2	51074.080.001	M16	1	51074.160.001	M24	1	51074.240.001
M10	2	51074.100.001						

• Rozmiary o średnicy > M24 mają minimalnie klasę właściwości 50.

55074 Pręty gwintowane, długość 1m, z lewym gwintem R09A

Gwint Metryczny
 Materiał Stal nierdzewna A4
 Klasa 70



d	☒	Kod artykułu	d	☒	Kod artykułu	d	☒	Kod artykułu
M5*	100	55074.050.001	M10*	25	55074.100.001	M16*	10	55074.160.001
M6*	100	55074.060.001	M12*	20	55074.120.001	M18*	10	55074.180.001
M8*	50	55074.080.001	M14*	10	55074.140.001	M20*	5	55074.200.001

45070 Pręty gwintowane, długość 1m W01A

Gwint Metryczny
 Materiał Aluminium P40



d	☒	Kod artykułu	d	☒	Kod artykułu	d	☒	Kod artykułu
M4	1	45070.040.001	M6	10	45070.060.001	M10	5	45070.100.001
M5	10	45070.050.001	M8	5	45070.080.001			

45270 Pręty gwintowane, długość 1m W01A

Gwint Metryczny
 Materiał Aluminium P60



d	☒	Kod artykułu	d	☒	Kod artykułu	d	☒	Kod artykułu
M8	5	45270.080.001	M10	5	45270.100.001	M12	5	45270.120.001

45940 Pręty gwintowane, długość 1m W01A

Gwint Metryczny
 Materiał Tytan Grade 2
 Klasa Gr.2



d	☒	Kod artykułu	d	☒	Kod artykułu	d	☒	Kod artykułu
M6	1	45940.060.001	M8	1	45940.080.001	M10	1	45940.100.001

46090 Pręty gwintowane, długość 1m M01A

Gwint Metryczny
 Materiał Mosiądz Cu2/Cu3



d	☒	Kod artykułu	d	☒	Kod artykułu	d	☒	Kod artykułu
M3	10	46090.030.001	M8	10	46090.080.001	M16	2	46090.160.001
M4	10	46090.040.001	M10	5	46090.100.001	M18	2	46090.180.001
M5	10	46090.050.001	M12	5	46090.120.001	M20	2	46090.200.001
M6	10	46090.060.001	M14	2	46090.140.001	M22	2	46090.220.001

56170 Pręty gwintowane, długość 1m plastikowe W02A

Gwint Metryczny
 Materiał Plastik Poliamid (nylon)
 Klasa PA 6.6
 Kolor Biały



d	☒	Kod artykułu	d	☒	Kod artykułu	d	☒	Kod artykułu
M3	10	56170.030.001	M8	5	56170.080.001	M14	2	56170.140.001
M4	10	56170.040.001	M10	5	56170.100.001	M16	2	56170.160.001
M5	5	56170.050.001	M12	2	56170.120.001	M20	1	56170.200.001
M6	5	56170.060.001						

20330 Pręty gwintowane, długość 2m G06A

Gwint Metryczny
 Materiał Stal
 Klasa ≥ 4.8
 Obróbka powierzchni Ocynkowane



d	☒	Kod artykułu	d	☒	Kod artykułu	d	☒	Kod artykułu
M5	10	20330.050.001	M12	10	20330.120.001	M24	2	20330.240.001
M6	10	20330.060.001	M16	5	20330.160.001	M27	1	20330.270.001
M8	10	20330.080.001	M20	2	20330.200.001	M30	1	20330.300.001
M10	10	20330.100.001						

20145 Pręty gwintowane 2 metry gwint nadwymiarowy A08A

Gwint Metryczny
 Materiał Stal
 Klasa ≥ 4.8
 Obróbka powierzchni Ocynkowane na gorąco



d	☒	Kod artykułu	d	☒	Kod artykułu	d	☒	Kod artykułu
M10	1	20145.100.001	M16	1	20145.160.001	M24	1	20145.240.001
M12	1	20145.120.001	M20	1	20145.200.001	M27	1	20145.270.001

20372 Pręty gwintowane, długość 2m G05A

Gwint Metryczny
 Materiał Stal
 Klasa 8.8
 Obróbka powierzchni Ocynkowane



d	☒	Kod artykułu	d	☒	Kod artykułu	d	☒	Kod artykułu
M5	10	20372.050.001	M12	10	20372.120.001	M22	2	20372.220.001
M6	10	20372.060.001	M14	5	20372.140.001	M24	2	20372.240.001
M8	10	20372.080.001	M16	5	20372.160.001	M30	1	20372.300.001
M10	10	20372.100.001	M20	2	20372.200.001	M36	1	20372.360.001

20155 Pręt gwintowany 2 metry gwint nadwymiarowy A08A

Gwint Metryczny
 Materiał Stal
 Klasa 8.8
 Obróbka powierzchni Ocynkowane na gorąco



d	☒	Kod artykułu	d	☒	Kod artykułu	d	☒	Kod artykułu
M12	1	20155.120.001	M20	1	20155.200.001	M30	1	20155.300.001
M16	1	20155.160.001	M24	1	20155.240.001	M36	1	20155.360.001

- Dla prętów gwintowanych cynkowanych na gorąco z gwintem NADWYMIAROWYM warstwa cynku jest nakładana na normalny gwint tak, że po cynkowaniu pręty gwintowane nie są już ISO-metryczne i pasujące, ale grubsze: tak zwane NADWYMIAROWE.
- Nie pasują do standardowych gwintów i nie mogą być stosowane w izometrycznie nagwintowanych otworach.
- Odpowiadające im nakrętki NADWYMIAROWE zostały nagwintowane o około 0,3 mm więcej, tak aby idealnie pasowały do śrub po cynkowaniu.

51071 Pręty gwintowane, długość 2m R09A

Gwint Metryczny
 Materiał Stal nierdzewna A2
 Klasa 70



d	☒	Kod artykułu	d	☒	Kod artykułu	d	☒	Kod artykułu
M6	5	51071.060.001	M18*	5	51071.180.001	M33*	1	51071.330.001
M8	5	51071.080.001	M20	1	51071.200.001	M36*	1	51071.360.001
M10	2	51071.100.001	M22*	1	51071.220.001	M39*	1	51071.390.001
M12	2	51071.120.001	M24	1	51071.240.001	M42*	1	51071.420.001
M14*	10	51071.140.001	M27*	1	51071.270.001	M45*	1	51071.450.001
M16	2	51071.160.001	M30*	1	51071.300.001			

- Rozmiary o średnicy > M24 mają minimalnie klasę właściwości 50.

55071	Pręty gwintowane, długość 2m	R49A
Gwint	Metryczny	
Materiał	Stal nierdzewna A4	
Klasa	70	

d	☒	Kod artykułu	d	☒	Kod artykułu	d	☒	Kod artykułu
M6	5	55071.060.001	M18*	5	55071.180.001	M36*	1	55071.360.001
M8	5	55071.080.001	M20	1	55071.200.001	M39*	1	55071.390.001
M10	2	55071.100.001	M22*	1	55071.220.001	M42*	1	55071.420.001
M12	2	55071.120.001	M27*	1	55071.270.001	M45*	1	55071.450.001
M14*	10	55071.140.001	M30*	1	55071.300.001			
M16	2	55071.160.001	M33*	1	55071.330.001			

• Rozmiary o średnicy > M24 mają minimalnie klasę właściwości 50.

20410	Pręty gwintowane, długość 3m	G05A
Gwint	Metryczny	
Materiał	Stal	
Klasa	≥4.8	
Obróbka powierzchni	Ocynkowane	

d	☒	Kod artykułu	d	☒	Kod artykułu	d	☒	Kod artykułu
M6	10	20410.060.001	M12	5	20410.120.001	M24	2	20410.240.001
M8	10	20410.080.001	M16	2	20410.160.001	M30	1	20410.300.001
M10	5	20410.100.001	M20	2	20410.200.001			

20147	Pręty gwintowane 3 metry gwint nadwymiarowy	A08A
Gwint	Metryczny	
Materiał	Stal	
Klasa	≥4.8	
Obróbka powierzchni	Ocynkowane na gorąco	

d	☒	Kod artykułu	d	☒	Kod artykułu	d	☒	Kod artykułu
M12	1	20147.120.001	M24	1	20147.240.001	M30	1	20147.300.001
M16	1	20147.160.001	M27	1	20147.270.001	M36	1	20147.360.001
M20	1	20147.200.001						

- Dla prętów gwintowanych cynkowanych na gorąco z gwintem NADWYMIAROWYM warstwa cynku jest nakładana na normalny gwint tak, że po cynkowaniu pręty gwintowane nie są już ISO-metryczne i pasujące, ale grubsze: tak zwane NADWYMIAROWE.
- Nie pasują do standardowych gwintów i nie mogą być stosowane w izometrycznie nagwintowanych otworach.
- Odpowiadające im nakrętki NADWYMIAROWE zostały nagwintowane o około 0,3 mm więcej, tak aby idealnie pasowały do śrub po cynkowaniu.

20395	Pręty gwintowane, długość 3m	G05A
Gwint	Metryczny	
Materiał	Stal	
Klasa	8.8	
Obróbka powierzchni	Ocynkowane	

d	☒	Kod artykułu	d	☒	Kod artykułu	d	☒	Kod artykułu
M6	10	20395.060.001	M12	5	20395.120.001	M24	1	20395.240.001
M8	10	20395.080.001	M16	2	20395.160.001	M30	1	20395.300.001
M10	5	20395.100.001	M20	1	20395.200.001	M36	1	20395.360.001

20157	Pręty gwintowane 3 metry gwint nadwymiarowy	A08A
Gwint	Metryczny	
Materiał	Stal	
Klasa	8.8	
Obróbka powierzchni	Ocynkowane na gorąco	

d	☒	Kod artykułu	d	☒	Kod artykułu	d	☒	Kod artykułu
M12	1	20157.120.001	M24	1	20157.240.001	M30	1	20157.300.001
M16	1	20157.160.001	M27	1	20157.270.001	M36	1	20157.360.001
M20	1	20157.200.001						

- Dla prętów gwintowanych cynkowanych na gorąco z gwintem NADWYMIAROWYM warstwa cynku jest nakładana na normalny gwint tak, że po cynkowaniu pręty gwintowane nie są już ISO-metryczne i pasujące, ale grubsze: tak zwane NADWYMIAROWE.
- Nie pasują do standardowych gwintów i nie mogą być stosowane w izometrycznie nagwintowanych otworach.
- Odpowiadające im nakrętki NADWYMIAROWE zostały nagwintowane o około 0,3 mm więcej, tak aby idealnie pasowały do śrub po cynkowaniu.

51072	Pręty gwintowane, długość 3m	R09A
Gwint	Metryczny	
Materiał	Stal nierdzewna A2	
Klasa	70	

d	☒	Kod artykułu	d	☒	Kod artykułu	d	☒	Kod artykułu
M6	5	51072.060.001	M18*	5	51072.180.001	M33*	1	51072.330.001
M8	5	51072.080.001	M20	1	51072.200.001	M36*	1	51072.360.001
M10	2	51072.100.001	M22*	1	51072.220.001	M39*	1	51072.390.001
M12	2	51072.120.001	M24	1	51072.240.001	M42*	1	51072.420.001
M14*	10	51072.140.001	M27*	1	51072.270.001	M45*	1	51072.450.001
M16	2	51072.160.001	M30*	1	51072.300.001			

• Rozmiary o średnicy > M24 mają minimalnie klasę właściwości 50.

4

55072	Pręty gwintowane, długość 3m	R49A
Gwint	Metryczny	
Materiał	Stal nierdzewna A4	
Klasa	70	

d	☒	Kod artykułu	d	☒	Kod artykułu	d	☒	Kod artykułu
M6	5	55072.060.001	M18*	5	55072.180.001	M33*	1	55072.330.001
M8	5	55072.080.001	M20	1	55072.200.001	M36*	1	55072.360.001
M10	2	55072.100.001	M24	1	55072.240.001	M39*	1	55072.390.001
M12	2	55072.120.001	M27*	1	55072.270.001	M42*	1	55072.420.001
M16	2	55072.160.001	M30	1	55072.300.001	M45*	1	55072.450.001

• Rozmiary o średnicy > M24 mają minimalnie klasę właściwości 50.

Pręty gwintowane, metryczne drobnozwojne

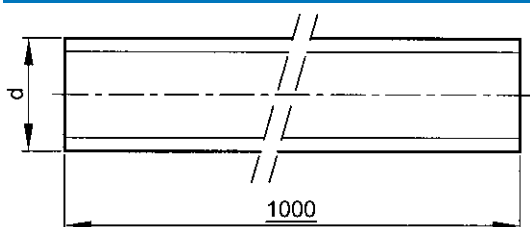

DIN ≈976-1
NEN ≈2369
NF ≈25-136



Końcówka pręta gwintowanego jest kolorowana aby poprawić rozpoznanie jego wykonani

Oznaczenie kolorami prętów gwintowanych

Klasa	Materiał	Kolor
4.8	Stal ocynkowana	kolor własny
4.8	ISO metryczne, gorący ocynk	jasnoniebieski
4.8	Pręty metryczne w gorącym ocynku nadwymiarowe	pomarańczowy
5.6	Stal	brązowy
5.8	Stal	gencjanowy niebieski
8.8	Stal, pasywacja biała i żółta	żółty
8.8	ISO metryczne, gorący ocynk	szary stalowy
8.8	Pręty metryczne w gorącym ocynku nadwymiarowe	fioletowy
10.9	Stal	biały
12.9	Stal	czarny
ASTM-B7	Stal (UNC & 8UN)	kolor własny
ASTM-B7	Stal (metryczne)	kolor własny
St.St.-A2	Stal nierdzewna A2 metryczne	zielony
St.St.-A4	Stal nierdzewna A4 metryczne	czerwony

Grupy katalogowe

Gwint	Materiał	Klasa	Obróbka powierzchni	Kod	Strona
M.drob.	St	≥4.8	Ocynk.	1 metr 20360	4-13
M.drob.	St	8.8	Ocynk.	1 metr 20235	4-13
M.drob.	St.St. A4	70		1 metr 55067	4-13

20360 Pręty gwintowane, długość 1m				G05A	
Gwint	Metryczny drobnoszwojny	DIN	976-1		
Materiał	Stal				
Klasa	≥4.8				
Obróbka powierzchni	Ocynkowane				

d x P	☒	Kod artykułu	d x P	☒	Kod artykułu	d x P	☒	Kod artykułu
M8X1,00	2	20360.080.100	M16X1,50	1	20360.160.150	M27X1,50 (#DIN)	1	20360.270.150
M10X1,00	2	20360.100.100	M18X1,50	1	20360.180.150	M27X2,00	1	20360.270.200
M10X1,25	2	20360.100.125	M20X1,50	1	20360.200.150	M30X1,50 (#DIN)	1	20360.300.150
M12X1,25	2	20360.120.125	M22X1,50	1	20360.220.150	M30X2,00	1	20360.300.200
M12X1,50	2	20360.120.150	M24X1,50 (#DIN)	1	20360.240.150			
M14X1,50	1	20360.140.150	M24X2,00	1	20360.240.200			

20235 Pręty gwintowane, długość 1m				G05A	
Gwint	Metryczny drobnoszwojny				
Materiał	Stal				
Klasa	8.8				
Obróbka powierzchni	Ocynkowane				

d x P	☒	Kod artykułu	d x P	☒	Kod artykułu	d x P	☒	Kod artykułu
M8X1,00	2	20235.080.100	M16X1,50	1	20235.160.150	M27X1,50	1	20235.270.150
M10X1,00	2	20235.100.100	M18X1,50	1	20235.180.150	M27X2,00	1	20235.270.200
M10X1,25	2	20235.100.125	M20X1,50	1	20235.200.150	M30X1,50	1	20235.300.150
M12X1,25	2	20235.120.125	M22X1,50	1	20235.220.150	M30X2,00	1	20235.300.200
M12X1,50	2	20235.120.150	M24X1,50	1	20235.240.150			
M14X1,50	1	20235.140.150	M24X2,00	1	20235.240.200			

55067 Pręty gwintowane, długość 1m				R49A	
Gwint	Metryczny drobnoszwojny				
Materiał	Stal nierdzewna A4				
Klasa	70				

d x P	☒	Kod artykułu	d x P	☒	Kod artykułu	d x P	☒	Kod artykułu
M8X1,00	2	55067.080.100	M12X1,50	2	55067.120.150	M22X1,50	1	55067.220.150
M10X1,00	2	55067.100.100	M14X1,50	1	55067.140.150	M24X1,50 (#DIN)	1	55067.240.150
M10X1,25	2	55067.100.125	M16X1,50	1	55067.160.150	M24X2,00	1	55067.240.200
M12X1,25	2	55067.120.125	M20X1,50	1	55067.200.150			

• Rozmiary o średnicy > M24 mają minimalnie klasę właściwości 50.

Pręty gwintowane, UNC

ASME B18.31.3

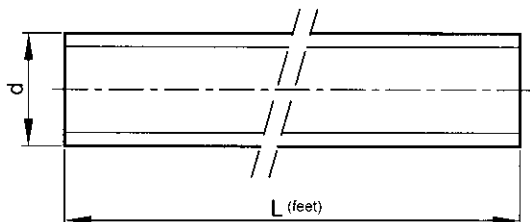

Informacje techniczne

d	Zwoje gwintu na cal	d	Zwoje gwintu na cal
No.2	56	9/16	12
No.3	48	5/8	11
No.4	40	3/4	10
No.5	40	7/8	9
No.6	32	1 inch	8
No.8	32	1.1/8	7
No.10	24	1.1/4	7
1/4	20	1.3/8	6
5/16	18	1.1/2	6
3/8	16	1.3/4	5
7/16	14	2 inch	4.5
1/2	13		

Grupy katalogowe

Gwint	Materiał	Klasa	Obróbka powierzchni	Kod	Strona
UNC	St	Gr.2		różne długości	U20200 4-14
UNC	St	Gr.2	Ocyнк.	różne długości	U20300 4-15
UNC	St	Gr.2	Ocyнк. gor.	różne długości	U20170 4-16
UNC	St.St. A2 (AISI304/18-8)	F593		różne długości	U51070 4-16
UNC	St.St. A4 (AISI316/18-10)	F593		różne długości	U55070 4-17

U20200 Pręty gwintowane

X09A

Gwint Calowy, zunifikowany grubozwojny (UNC)
Materiał Stal
Klasa Gr.2



d x L	⊠	Kod artykułu	d x L	⊠	Kod artykułu	d x L	⊠	Kod artykułu
NO.2-56X2*	1	U20200.008.2400	1/4-20X1*	1	U20200.025.1200	1/2-13X10*	1	U20200.050.8888
NO.2-56X3*	1	U20200.008.3600	1/4-20X2*	1	U20200.025.2400	1/2-13X12*	1	U20200.050.9999
NO.2-56X6*	1	U20200.008.7200	1/4-20X3*	1	U20200.025.3600			
			1/4-20X6*	1	U20200.025.7200	9/16-12X1*	1	U20200.056.1200
NO.3-48X3*	1	U20200.009.3600	1/4-20X10*	1	U20200.025.8888	9/16-12X2*	1	U20200.056.2400
			1/4-20X12*	1	U20200.025.9999	9/16-12X3*	1	U20200.056.3600
NO.4-40X2*	1	U20200.011.2400				9/16-12X6*	1	U20200.056.7200
NO.4-40X3*	1	U20200.011.3600	5/16-18X1*	1	U20200.031.1200	9/16-12X10*	1	U20200.056.8888
NO.4-40X6*	1	U20200.011.7200	5/16-18X2*	1	U20200.031.2400	9/16-12X12*	1	U20200.056.9999
			5/16-18X3*	1	U20200.031.3600			
NO.5-40X2*	1	U20200.012.2400	5/16-18X6*	1	U20200.031.7200	5/8-11X1*	1	U20200.062.1200
NO.5-40X3*	1	U20200.012.3600	5/16-18X10*	1	U20200.031.8888	5/8-11X2*	1	U20200.062.2400
NO.5-40X6*	1	U20200.012.7200	5/16-18X12*	1	U20200.031.9999	5/8-11X3*	1	U20200.062.3600
						5/8-11X6*	1	U20200.062.7200
NO.6-32X1*	1	U20200.013.1200	3/8-16X1*	1	U20200.037.1200	5/8-11X10*	1	U20200.062.8888
NO.6-32X2*	1	U20200.013.2400	3/8-16X2*	1	U20200.037.2400	5/8-11X12*	1	U20200.062.9999
NO.6-32X3*	1	U20200.013.3600	3/8-16X3*	1	U20200.037.3600			
NO.6-32X6*	1	U20200.013.7200	3/8-16X6*	1	U20200.037.7200	3/4-10X1*	1	U20200.075.1200
			3/8-16X10*	1	U20200.037.8888	3/4-10X2*	1	U20200.075.2400
NO.8-32X1*	1	U20200.016.1200	3/8-16X12*	1	U20200.037.9999	3/4-10X3*	1	U20200.075.3600
NO.8-32X2*	1	U20200.016.2400				3/4-10X6*	1	U20200.075.7200
NO.8-32X3*	1	U20200.016.3600	7/16-14X1*	1	U20200.043.1200	3/4-10X10*	1	U20200.075.8888
NO.8-32X6*	1	U20200.016.7200	7/16-14X2*	1	U20200.043.2400	3/4-10X12*	1	U20200.075.9999
			7/16-14X3*	1	U20200.043.3600			
NO.10-24X1*	1	U20200.019.1200	7/16-14X6*	1	U20200.043.7200	7/8-9X1*	1	U20200.087.1200
NO.10-24X2*	1	U20200.019.2400	7/16-14X10*	1	U20200.043.8888	7/8-9X2*	1	U20200.087.2400
NO.10-24X3*	1	U20200.019.3600				7/8-9X3*	1	U20200.087.3600
NO.10-24X6*	1	U20200.019.7200	1/2-13X1*	1	U20200.050.1200	7/8-9X6*	1	U20200.087.7200
NO.10-24X10*	1	U20200.019.8888	1/2-13X2*	1	U20200.050.2400	7/8-9X10*	1	U20200.087.8888
NO.10-24X12*	1	U20200.019.9999	1/2-13X3*	1	U20200.050.3600	7/8-9X12*	1	U20200.087.9999
			1/2-13X6*	1	U20200.050.7200			

U20200 Pręty gwintowane								
d x L	☒	Kod artykułu	d x L	☒	Kod artykułu	d x L	☒	Kod artykułu
1.-8X1*	1	U20200.100.1200	1.1/4-7X3*	1	U20200.125.3600	1.1/2-6X10*	1	U20200.150.8888
1.-8X2*	1	U20200.100.2400	1.1/4-7X6*	1	U20200.125.7200	1.1/2-6X12*	1	U20200.150.9999
1.-8X3*	1	U20200.100.3600	1.1/4-7X10*	1	U20200.125.8888			
1.-8X6*	1	U20200.100.7200	1.1/4-7X12*	1	U20200.125.9999	1.3/4-5X1*	1	U20200.175.1200
1.-8X10*	1	U20200.100.8888				1.3/4-5X2*	1	U20200.175.2400
1.-8X12*	1	U20200.100.9999	1.3/8-6X1*	1	U20200.137.1200	1.3/4-5X3*	1	U20200.175.3600
			1.3/8-6X2*	1	U20200.137.2400	1.3/4-5X6*	1	U20200.175.7200
1.1/8-7X1*	1	U20200.112.1200	1.3/8-6X3*	1	U20200.137.3600	1.3/4-5X10*	1	U20200.175.8888
1.1/8-7X2*	1	U20200.112.2400	1.3/8-6X6*	1	U20200.137.7200	1.3/4-5X12*	1	U20200.175.9999
1.1/8-7X3*	1	U20200.112.3600	1.3/8-6X10*	1	U20200.137.8888			
1.1/8-7X6*	1	U20200.112.7200	1.3/8-6X12*	1	U20200.137.9999	2.-4.5X1*	1	U20200.200.1200
1.1/8-7X10*	1	U20200.112.8888				2.-4.5X2*	1	U20200.200.2400
1.1/8-7X12*	1	U20200.112.9999	1.1/2-6X1*	1	U20200.150.1200	2.-4.5X3*	1	U20200.200.3600
			1.1/2-6X2*	1	U20200.150.2400	2.-4.5X6*	1	U20200.200.7200
1.1/4-7X1*	1	U20200.125.1200	1.1/2-6X3*	1	U20200.150.3600	2.-4.5X10*	1	U20200.200.8888
1.1/4-7X2*	1	U20200.125.2400	1.1/2-6X6*	1	U20200.150.7200	2.-4.5X12*	1	U20200.200.9999

U20300 Pręty gwintowane		X09A
Gwint	Całowy, zunifikowany grubozwojny (UNC)	
Material	Stal	
Klasa	Gr.2	
Obróbka powierzchni	Ocynkowane	

d x L	☒	Kod artykułu	d x L	☒	Kod artykułu	d x L	☒	Kod artykułu
NO.2-56X3*	1	U20300.008.3600	3/8-16X12*	1	U20300.037.9999	1.-8X6*	1	U20300.100.7200
NO.2-56X6*	1	U20300.008.7200				1.-8X10*	1	U20300.100.8888
			7/16-14X1*	1	U20300.043.1200	1.-8X12*	1	U20300.100.9999
NO.4-40X2*	1	U20300.011.2400	7/16-14X2*	1	U20300.043.2400			
NO.4-40X3*	1	U20300.011.3600	7/16-14X3*	1	U20300.043.3600	1.1/8-7X1*	1	U20300.112.1200
NO.4-40X6*	1	U20300.011.7200	7/16-14X6*	1	U20300.043.7200	1.1/8-7X2*	1	U20300.112.2400
			7/16-14X10*	1	U20300.043.8888	1.1/8-7X3*	1	U20300.112.3600
NO.5-40X2*	1	U20300.012.2400				1.1/8-7X6*	1	U20300.112.7200
NO.5-40X3*	1	U20300.012.3600	1/2-13X1*	1	U20300.050.1200	1.1/8-7X10*	1	U20300.112.8888
NO.5-40X6*	1	U20300.012.7200	1/2-13X2*	1	U20300.050.2400	1.1/8-7X12*	1	U20300.112.9999
			1/2-13X3*	1	U20300.050.3600			
NO.6-32X1*	1	U20300.013.1200	1/2-13X6*	1	U20300.050.7200	1.1/4-7X1*	1	U20300.125.1200
NO.6-32X2*	1	U20300.013.2400	1/2-13X10*	1	U20300.050.8888	1.1/4-7X2*	1	U20300.125.2400
NO.6-32X3*	1	U20300.013.3600	1/2-13X12*	1	U20300.050.9999	1.1/4-7X3*	1	U20300.125.3600
NO.6-32X6*	1	U20300.013.7200				1.1/4-7X6*	1	U20300.125.7200
			9/16-12X1*	1	U20300.056.1200	1.1/4-7X10*	1	U20300.125.8888
NO.8-32X1*	1	U20300.016.1200	9/16-12X2*	1	U20300.056.2400	1.1/4-7X12*	1	U20300.125.9999
NO.8-32X2*	1	U20300.016.2400	9/16-12X3*	1	U20300.056.3600			
NO.8-32X3*	1	U20300.016.3600	9/16-12X6*	1	U20300.056.7200	1.3/8-6X1*	1	U20300.137.1200
NO.8-32X6*	1	U20300.016.7200	9/16-12X10*	1	U20300.056.8888	1.3/8-6X2*	1	U20300.137.2400
			9/16-12X12*	1	U20300.056.9999	1.3/8-6X3*	1	U20300.137.3600
NO.10-24X1*	1	U20300.019.1200				1.3/8-6X6*	1	U20300.137.7200
NO.10-24X2*	1	U20300.019.2400	5/8-11X1*	1	U20300.062.1200	1.3/8-6X10*	1	U20300.137.8888
NO.10-24X3*	1	U20300.019.3600	5/8-11X2*	1	U20300.062.2400	1.3/8-6X12*	1	U20300.137.9999
NO.10-24X6*	1	U20300.019.7200	5/8-11X3*	1	U20300.062.3600			
NO.10-24X10*	1	U20300.019.8888	5/8-11X6*	1	U20300.062.7200	1.1/2-6X1*	1	U20300.150.1200
			5/8-11X10*	1	U20300.062.8888	1.1/2-6X2*	1	U20300.150.2400
1/4-20X1*	1	U20300.025.1200	5/8-11X12*	1	U20300.062.9999	1.1/2-6X3*	1	U20300.150.3600
1/4-20X2*	1	U20300.025.2400				1.1/2-6X6*	1	U20300.150.7200
1/4-20X3*	1	U20300.025.3600	3/4-10X1*	1	U20300.075.1200	1.1/2-6X10*	1	U20300.150.8888
1/4-20X6*	1	U20300.025.7200	3/4-10X2*	1	U20300.075.2400	1.1/2-6X12*	1	U20300.150.9999
1/4-20X10*	1	U20300.025.8888	3/4-10X3*	1	U20300.075.3600			
1/4-20X12*	1	U20300.025.9999	3/4-10X6*	1	U20300.075.7200	1.3/4-5X1*	1	U20300.175.1200
			3/4-10X10*	1	U20300.075.8888	1.3/4-5X2*	1	U20300.175.2400
5/16-18X1*	1	U20300.031.1200	3/4-10X12*	1	U20300.075.9999	1.3/4-5X3*	1	U20300.175.3600
5/16-18X2*	1	U20300.031.2400				1.3/4-5X6*	1	U20300.175.7200
5/16-18X3*	1	U20300.031.3600	7/8-9X1*	1	U20300.087.1200	1.3/4-5X10*	1	U20300.175.8888
5/16-18X6*	1	U20300.031.7200	7/8-9X2*	1	U20300.087.2400	1.3/4-5X12*	1	U20300.175.9999
5/16-18X10*	1	U20300.031.8888	7/8-9X3*	1	U20300.087.3600			
5/16-18X12*	1	U20300.031.9999	7/8-9X6*	1	U20300.087.7200	2.-4.5X1*	1	U20300.200.1200
			7/8-9X10*	1	U20300.087.8888	2.-4.5X2*	1	U20300.200.2400
3/8-16X1*	1	U20300.037.1200	7/8-9X12*	1	U20300.087.9999	2.-4.5X3*	1	U20300.200.3600
3/8-16X2*	1	U20300.037.2400				2.-4.5X6*	1	U20300.200.7200
3/8-16X3*	1	U20300.037.3600	1.-8X1*	1	U20300.100.1200	2.-4.5X10*	1	U20300.200.8888
3/8-16X6*	1	U20300.037.7200	1.-8X2*	1	U20300.100.2400	2.-4.5X12*	1	U20300.200.9999
3/8-16X10*	1	U20300.037.8888	1.-8X3*	1	U20300.100.3600			

U20170 Pręty gwintowane		X09A	
Gwint	Całowy, zunifikowany grubozwojny (UNC)		
Materiał	Stal		
Klasa	Gr.2		
Obróbka powierzchni	Ocynkowane na gorąco		

4

d x L	☒	Kod artykułu	d x L	☒	Kod artykułu	d x L	☒	Kod artykułu
3/8-16X2*	1	U20170.037.2400	5/8-11X10*	1	U20170.062.8888	1.1/8-7X2*	1	U20170.112.2400
3/8-16X3*	1	U20170.037.3600	5/8-11X12*	1	U20170.062.9999	1.1/8-7X3*	1	U20170.112.3600
3/8-16X6*	1	U20170.037.7200				1.1/8-7X12*	1	U20170.112.9999
3/8-16X10*	1	U20170.037.8888	3/4-10X2*	1	U20170.075.2400	1.1/4-7X2*	1	U20170.125.2400
3/8-16X12*	1	U20170.037.9999	3/4-10X3*	1	U20170.075.3600	1.1/4-7X3*	1	U20170.125.3600
			3/4-10X6*	1	U20170.075.7200	1.1/4-7X6*	1	U20170.125.7200
7/16-14X3*	1	U20170.043.3600	3/4-10X10*	1	U20170.075.8888	1.1/4-7X12*	1	U20170.125.9999
			3/4-10X12*	1	U20170.075.9999			
1/2-13X2*	1	U20170.050.2400	7/8-9X2*	1	U20170.087.2400	1.3/8-6X3*	1	U20170.137.3600
1/2-13X3*	1	U20170.050.3600	7/8-9X3*	1	U20170.087.3600			
1/2-13X6*	1	U20170.050.7200	7/8-9X6*	1	U20170.087.7200	1.1/2-6X2*	1	U20170.150.2400
1/2-13X10*	1	U20170.050.8888	7/8-9X12*	1	U20170.087.9999	1.1/2-6X3*	1	U20170.150.3600
1/2-13X12*	1	U20170.050.9999				1.1/2-6X6*	1	U20170.150.7200
			1.-8X2*	1	U20170.100.2400	1.1/2-6X12*	1	U20170.150.9999
9/16-12X3*	1	U20170.056.3600	1.-8X3*	1	U20170.100.3600			
			1.-8X6*	1	U20170.100.7200	1.3/4-5X3*	1	U20170.175.3600
5/8-11X2*	1	U20170.062.2400	1.-8X12*	1	U20170.100.9999			
5/8-11X3*	1	U20170.062.3600				2.-4,5X3*	1	U20170.200.3600
5/8-11X6*	1	U20170.062.7200						

- Dla prętów gwintowanych cynkowanych na gorąco z gwintem NADWYMIAROWYM warstwa cynku jest nakładana na normalny gwint tak, że po cynkowaniu pręty gwintowane nie są już ISO-metryczne i pasujące, ale grubsze: tak zwane NADWYMIAROWE.
- Nie pasują do standardowych gwintów i nie mogą być stosowane w izometrycznie nagwintowanych otworach.
- Odpowiadające im nakrętki NADWYMIAROWE zostały nagwintowane o około 0,3 mm więcej, tak aby idealnie pasowały do śrub po cynkowaniu.

U51070 Pręty gwintowane		X15A	
Gwint	Całowy, zunifikowany grubozwojny (UNC)		
Materiał	Stal nierdzewna A2 (AISI 304/18-8)		
Klasa	F593		

d x L	☒	Kod artykułu	d x L	☒	Kod artykułu	d x L	☒	Kod artykułu
NO.6-32X1*	1	U51070.013.1200	3/8-16X3*	1	U51070.037.3600	3/4-10X2*	1	U51070.075.2400
NO.6-32X2*	1	U51070.013.2400	3/8-16X6*	1	U51070.037.7200	3/4-10X3*	1	U51070.075.3600
NO.6-32X3*	1	U51070.013.3600	3/8-16X12*	1	U51070.037.9999	3/4-10X6*	1	U51070.075.7200
NO.6-32X6*	1	U51070.013.7200				3/4-10X12*	1	U51070.075.9999
			7/16-14X1*	1	U51070.043.1200			
NO.8-32X1*	1	U51070.016.1200	7/16-14X2*	1	U51070.043.2400	7/8-9X1*	1	U51070.087.1200
NO.8-32X2*	1	U51070.016.2400	7/16-14X3*	1	U51070.043.3600	7/8-9X2*	1	U51070.087.2400
NO.8-32X3*	1	U51070.016.3600	7/16-14X6*	1	U51070.043.7200	7/8-9X3*	1	U51070.087.3600
NO.8-32X6*	1	U51070.016.7200	7/16-14X12*	1	U51070.043.9999	7/8-9X6*	1	U51070.087.7200
						7/8-9X12*	1	U51070.087.9999
NO.10-24X1*	1	U51070.019.1200	1/2-13X1*	1	U51070.050.1200			
NO.10-24X2*	1	U51070.019.2400	1/2-13X2*	1	U51070.050.2400	1.-8X1*	1	U51070.100.1200
NO.10-24X3*	1	U51070.019.3600	1/2-13X3*	1	U51070.050.3600	1.-8X2*	1	U51070.100.2400
NO.10-24X6*	1	U51070.019.7200	1/2-13X6*	1	U51070.050.7200	1.-8X3*	1	U51070.100.3600
			1/2-13X12*	1	U51070.050.9999	1.-8X6*	1	U51070.100.7200
1/4-20X1*	1	U51070.025.1200				1.-8X12*	1	U51070.100.9999
1/4-20X2*	1	U51070.025.2400	9/16-12X1*	1	U51070.056.1200			
1/4-20X3*	1	U51070.025.3600	9/16-12X2*	1	U51070.056.2400	1.1/8-7X3*	1	U51070.112.3600
1/4-20X6*	1	U51070.025.7200	9/16-12X3*	1	U51070.056.3600			
1/4-20X12*	1	U51070.025.9999	9/16-12X6*	1	U51070.056.7200	1.1/4-7X1*	1	U51070.125.1200
			9/16-12X12*	1	U51070.056.9999	1.1/4-7X2*	1	U51070.125.2400
5/16-18X1*	1	U51070.031.1200				1.1/4-7X3*	1	U51070.125.3600
5/16-18X2*	1	U51070.031.2400	5/8-11X1*	1	U51070.062.1200	1.1/4-7X6*	1	U51070.125.7200
5/16-18X3*	1	U51070.031.3600	5/8-11X2*	1	U51070.062.2400			
5/16-18X6*	1	U51070.031.7200	5/8-11X3*	1	U51070.062.3600	1.1/2-6X1*	1	U51070.150.1200
5/16-18X12*	1	U51070.031.9999	5/8-11X6*	1	U51070.062.7200	1.1/2-6X2*	1	U51070.150.2400
			5/8-11X12*	1	U51070.062.9999	1.1/2-6X3*	1	U51070.150.3600
3/8-16X1*	1	U51070.037.1200				1.1/2-6X6*	1	U51070.150.7200
3/8-16X2*	1	U51070.037.2400	3/4-10X1*	1	U51070.075.1200			

U55070	Pręty gwintowane	X15A
Gwint	Całowy, zunifikowany grubozwojny (UNC)	
Materiał	Stal nierdzewna A4 (AISI 316/18-10)	
Klasa	F593	

d x L	☒	Kod artykułu	d x L	☒	Kod artykułu	d x L	☒	Kod artykułu
NO.6-32X1*	1	U55070.013.1200	5/16-18X6*	1	U55070.031.7200	7/8-9X2*	1	U55070.087.2400
NO.6-32X2*	1	U55070.013.2400				7/8-9X3*	1	U55070.087.3600
NO.6-32X3*	1	U55070.013.3600	3/8-16X1*	1	U55070.037.1200	7/8-9X6*	1	U55070.087.7200
NO.6-32X6*	1	U55070.013.7200	3/8-16X2*	1	U55070.037.2400			
			3/8-16X3*	1	U55070.037.3600	1.-8X1*	1	U55070.100.1200
NO.8-32X1*	1	U55070.016.1200	3/8-16X6*	1	U55070.037.7200	1.-8X2*	1	U55070.100.2400
NO.8-32X2*	1	U55070.016.2400				1.-8X3*	1	U55070.100.3600
NO.8-32X3*	1	U55070.016.3600	1/2-13X1*	1	U55070.050.1200	1.-8X6*	1	U55070.100.7200
NO.8-32X6*	1	U55070.016.7200	1/2-13X2*	1	U55070.050.2400			
			1/2-13X3*	1	U55070.050.3600	1.1/8-7X1*	1	U55070.112.1200
NO.10-24X1*	1	U55070.019.1200	1/2-13X6*	1	U55070.050.7200	1.1/8-7X2*	1	U55070.112.2400
NO.10-24X2*	1	U55070.019.2400				1.1/8-7X3*	1	U55070.112.3600
NO.10-24X3*	1	U55070.019.3600	5/8-11X1*	1	U55070.062.1200	1.1/8-7X6*	1	U55070.112.7200
NO.10-24X6*	1	U55070.019.7200	5/8-11X2*	1	U55070.062.2400			
			5/8-11X3*	1	U55070.062.3600	1.1/4-7X1*	1	U55070.125.1200
1/4-20X1*	1	U55070.025.1200	5/8-11X6*	1	U55070.062.7200	1.1/4-7X2*	1	U55070.125.2400
1/4-20X2*	1	U55070.025.2400				1.1/4-7X3*	1	U55070.125.3600
1/4-20X3*	1	U55070.025.3600	3/4-10X1*	1	U55070.075.1200	1.1/4-7X6*	1	U55070.125.7200
1/4-20X6*	1	U55070.025.7200	3/4-10X2*	1	U55070.075.2400			
			3/4-10X3*	1	U55070.075.3600	1.1/2-6X1*	1	U55070.150.1200
5/16-18X1*	1	U55070.031.1200	3/4-10X6*	1	U55070.075.7200	1.1/2-6X2*	1	U55070.150.2400
5/16-18X2*	1	U55070.031.2400				1.1/2-6X3*	1	U55070.150.3600
5/16-18X3*	1	U55070.031.3600	7/8-9X1*	1	U55070.087.1200	1.1/2-6X6*	1	U55070.150.7200

4

Pręty gwintowane, UNF

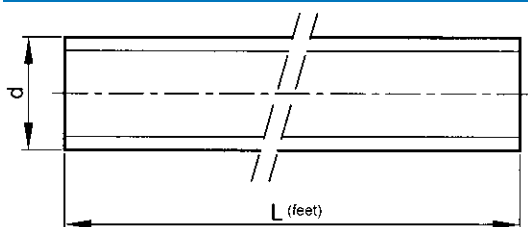

ASME B18.31.3



Informacje techniczne

d	Zwoje gwintu na cal	d	Zwoje gwintu na cal
No.10	32	7/8	14
1/4	28	1 Inch-12G	12
5/16	24	1 Inch	12
3/8	24	1.1/8	12
7/16	20	1.1/4	12
1/2	20	1.3/8	12
9/16	18	1.1/2	12
5/8	18	1.3/4	12
3/4	16	2 Inch	12

• Jeżeli podczas zamówienia nie określi się gwintu UNF z 12 zwojami na cal, to dostarczamy typ z 14 zwojami na cal (UNS).

Grupy katalogowe

Gwint	Materiał	Klasa	Obróbka powierzchni	Kod	Strona
UNF	St	Gr.2	różne długości	U20360	4-18
UNF	St	Gr.2	Ocynk.	U20365	4-18
UNF	St.St. A2 (AISI304/18-8)	F593	różne długości	U51067	4-19
UNF	St.St. A4 (AISI316/18-10)	F593	różne długości	U55067	4-19

U20360	Pręty gwintowane	X09A
Gwint	Całowy, zunifikowany drobnozwojny (UNF)	
Materiał	Stal	
Klasa	Gr.2	
		 

d x L	☒	Kod artykułu	d x L	☒	Kod artykułu	d x L	☒	Kod artykułu
NO.10-32X1*	1	U20360.019.1200	1/2-20X12*	1	U20360.050.9999	1.1/8-12X2*	1	U20360.112.2400
NO.10-32X2*	1	U20360.019.2400				1.1/8-12X3*	1	U20360.112.3600
NO.10-32X3*	1	U20360.019.3600	9/16-18X1*	1	U20360.056.1200	1.1/8-12X6*	1	U20360.112.7200
NO.10-32X6*	1	U20360.019.7200	9/16-18X2*	1	U20360.056.2400	1.1/8-12X12*	1	U20360.112.9999
			9/16-18X3*	1	U20360.056.3600			
1/4-28X1*	1	U20360.025.1200	9/16-18X6*	1	U20360.056.7200	1.1/4-12X1*	1	U20360.125.1200
1/4-28X2*	1	U20360.025.2400	9/16-18X10*	1	U20360.056.8888	1.1/4-12X2*	1	U20360.125.2400
1/4-28X3*	1	U20360.025.3600	9/16-18X12*	1	U20360.056.9999	1.1/4-12X3*	1	U20360.125.3600
1/4-28X6*	1	U20360.025.7200				1.1/4-12X6*	1	U20360.125.7200
1/4-28X12*	1	U20360.025.9999	5/8-18X1*	1	U20360.062.1200	1.1/4-12X12*	1	U20360.125.9999
			5/8-18X2*	1	U20360.062.2400			
5/16-24X1*	1	U20360.031.1200	5/8-18X3*	1	U20360.062.3600	1.3/8-12X1*	1	U20360.137.1200
5/16-24X2*	1	U20360.031.2400	5/8-18X6*	1	U20360.062.7200	1.3/8-12X2*	1	U20360.137.2400
5/16-24X3*	1	U20360.031.3600	5/8-18X12*	1	U20360.062.9999	1.3/8-12X3*	1	U20360.137.3600
5/16-24X6*	1	U20360.031.7200				1.3/8-12X6*	1	U20360.137.7200
5/16-24X12*	1	U20360.031.9999	3/4-16X1*	1	U20360.075.1200	1.3/8-12X12*	1	U20360.137.9999
			3/4-16X2*	1	U20360.075.2400			
3/8-24X1*	1	U20360.037.1200	3/4-16X3*	1	U20360.075.3600	1.1/2-12X1*	1	U20360.150.1200
3/8-24X2*	1	U20360.037.2400	3/4-16X6*	1	U20360.075.7200	1.1/2-12X2*	1	U20360.150.2400
3/8-24X3*	1	U20360.037.3600	3/4-16X12*	1	U20360.075.9999	1.1/2-12X3*	1	U20360.150.3600
3/8-24X6*	1	U20360.037.7200				1.1/2-12X6*	1	U20360.150.7200
3/8-24X12*	1	U20360.037.9999	7/8-14X1*	1	U20360.087.1200	1.1/2-12X12*	1	U20360.150.9999
			7/8-14X2*	1	U20360.087.2400			
7/16-20X1*	1	U20360.043.1200	7/8-14X3*	1	U20360.087.3600	1.3/4-12X1*	1	U20360.175.1200
7/16-20X2*	1	U20360.043.2400	7/8-14X6*	1	U20360.087.7200	1.3/4-12X2*	1	U20360.175.2400
7/16-20X3*	1	U20360.043.3600	7/8-14X12*	1	U20360.087.9999	1.3/4-12X3*	1	U20360.175.3600
7/16-20X6*	1	U20360.043.7200				1.3/4-12X6*	1	U20360.175.7200
7/16-20X12*	1	U20360.043.9999	1.-12X1*	1	U20360.100.1200	1.3/4-12X12*	1	U20360.175.9999
			1.-12X2*	1	U20360.100.2400			
1/2-20X1*	1	U20360.050.1200	1.-12X3*	1	U20360.100.3600	2.-12X1*	1	U20360.200.1200
1/2-20X2*	1	U20360.050.2400	1.-12X12*	1	U20360.100.9999	2.-12X2*	1	U20360.200.2400
1/2-20X3*	1	U20360.050.3600				2.-12X3*	1	U20360.200.3600
1/2-20X6*	1	U20360.050.7200	1.1/8-12X1*	1	U20360.112.1200	2.-12X6*	1	U20360.200.7200

U20365	Pręty gwintowane	X09A
Gwint	Całowy, zunifikowany drobnozwojny (UNF)	
Materiał	Stal	
Klasa	Gr.2	
Obróbka powierzchni	Ocynkowane	
		 

d x L	☒	Kod artykułu	d x L	☒	Kod artykułu	d x L	☒	Kod artykułu
NO.10-32X1*	1	U20365.019.1200	1/2-20X2*	1	U20365.050.2400	1.-12X1*	1	U20365.100.1200
NO.10-32X2*	1	U20365.019.2400	1/2-20X3*	1	U20365.050.3600	1.-12X2*	1	U20365.100.2400
NO.10-32X3*	1	U20365.019.3600	1/2-20X6*	1	U20365.050.7200	1.-12X3*	1	U20365.100.3600
NO.10-32X6*	1	U20365.019.7200	1/2-20X10*	1	U20365.050.8888	1.-12X12*	1	U20365.100.9999
			1/2-20X12*	1	U20365.050.9999			
1/4-28X1*	1	U20365.025.1200	9/16-18X1*	1	U20365.056.1200	1.1/8-12X1*	1	U20365.112.1200
1/4-28X2*	1	U20365.025.2400	9/16-18X2*	1	U20365.056.2400	1.1/8-12X2*	1	U20365.112.2400
1/4-28X3*	1	U20365.025.3600	9/16-18X3*	1	U20365.056.3600	1.1/8-12X3*	1	U20365.112.3600
1/4-28X6*	1	U20365.025.7200	9/16-18X6*	1	U20365.056.7200	1.1/8-12X6*	1	U20365.112.7200
1/4-28X10*	1	U20365.025.8888	9/16-18X10*	1	U20365.056.8888	1.1/8-12X12*	1	U20365.112.9999
			9/16-18X12*	1	U20365.056.9999			
5/16-24X1*	1	U20365.031.1200				1.1/4-12X1*	1	U20365.125.1200
5/16-24X2*	1	U20365.031.2400	5/8-18X1*	1	U20365.062.1200	1.1/4-12X2*	1	U20365.125.2400
5/16-24X3*	1	U20365.031.3600	5/8-18X2*	1	U20365.062.2400	1.1/4-12X3*	1	U20365.125.3600
5/16-24X6*	1	U20365.031.7200	5/8-18X3*	1	U20365.062.3600	1.1/4-12X6*	1	U20365.125.7200
5/16-24X12*	1	U20365.031.9999	5/8-18X6*	1	U20365.062.7200	1.1/4-12X12*	1	U20365.125.9999
			5/8-18X12*	1	U20365.062.9999			
3/8-24X1*	1	U20365.037.1200				1.3/8-12X1*	1	U20365.137.1200
3/8-24X2*	1	U20365.037.2400	3/4-16X1*	1	U20365.075.1200	1.3/8-12X3*	1	U20365.137.3600
3/8-24X3*	1	U20365.037.3600	3/4-16X2*	1	U20365.075.2400	1.3/8-12X6*	1	U20365.137.7200
3/8-24X6*	1	U20365.037.7200	3/4-16X3*	1	U20365.075.3600	1.3/8-12X12*	1	U20365.137.9999
3/8-24X12*	1	U20365.037.9999	3/4-16X6*	1	U20365.075.7200			
			3/4-16X12*	1	U20365.075.9999	1.1/2-12X1*	1	U20365.150.1200
7/16-20X1*	1	U20365.043.1200				1.1/2-12X2*	1	U20365.150.2400
7/16-20X2*	1	U20365.043.2400	7/8-14X1*	1	U20365.087.1200	1.1/2-12X3*	1	U20365.150.3600
7/16-20X3*	1	U20365.043.3600	7/8-14X2*	1	U20365.087.2400	1.1/2-12X6*	1	U20365.150.7200
7/16-20X6*	1	U20365.043.7200	7/8-14X3*	1	U20365.087.3600			
7/16-20X12*	1	U20365.043.9999	7/8-14X6*	1	U20365.087.7200	1.3/4-12X1*	1	U20365.175.1200
			7/8-14X12*	1	U20365.087.9999	1.3/4-12X6*	1	U20365.175.7200

U20365 Pręty gwintowane

d x L	Kod artykułu
1.3/4-12X12*	1 U20365.175.9999

U51067 Pręty gwintowane X15A

Gwint Calowy, zunifikowany drobnozwojny (UNF)
Materiał Stal nierdzewna A2 (AISI 304/18-8)
Klasa F593



d x L	Kod artykułu	d x L	Kod artykułu	d x L	Kod artykułu
NO.10-32X1*	1 U51067.019.1200	3/8-24X2*	1 U51067.037.2400	5/8-18X1*	1 U51067.062.1200
NO.10-32X2*	1 U51067.019.2400	3/8-24X3*	1 U51067.037.3600	5/8-18X2*	1 U51067.062.2400
NO.10-32X3*	1 U51067.019.3600	3/8-24X6*	1 U51067.037.7200	5/8-18X3*	1 U51067.062.3600
NO.10-32X6*	1 U51067.019.7200			5/8-18X6*	1 U51067.062.7200
1/4-28X1*	1 U51067.025.1200	7/16-20X1*	1 U51067.043.1200	3/4-16X1*	1 U51067.075.1200
1/4-28X2*	1 U51067.025.2400	7/16-20X2*	1 U51067.043.2400	3/4-16X2*	1 U51067.075.2400
1/4-28X3*	1 U51067.025.3600	7/16-20X3*	1 U51067.043.3600	3/4-16X3*	1 U51067.075.3600
1/4-28X6*	1 U51067.025.7200	7/16-20X6*	1 U51067.043.7200	3/4-16X6*	1 U51067.075.7200
5/16-24X1*	1 U51067.031.1200	1/2-20X1*	1 U51067.050.1200	7/8-14X1*	1 U51067.087.1200
5/16-24X2*	1 U51067.031.2400	1/2-20X2*	1 U51067.050.2400	7/8-14X2*	1 U51067.087.2400
5/16-24X3*	1 U51067.031.3600	1/2-20X3*	1 U51067.050.3600	7/8-14X3*	1 U51067.087.3600
5/16-24X6*	1 U51067.031.7200	1/2-20X6*	1 U51067.050.7200	7/8-14X6*	1 U51067.087.7200
3/8-24X1*	1 U51067.037.1200	9/16-18X3*	1 U51067.056.3600	1.1/8-12X3*	1 U51067.112.3600

4
U55067 Pręty gwintowane X15A

Gwint Calowy, zunifikowany drobnozwojny (UNF)
Materiał Stal nierdzewna A4 (AISI 316/18-10)
Klasa F593



d x L	Kod artykułu	d x L	Kod artykułu	d x L	Kod artykułu
NO.10-32X1*	1 U55067.019.1200	3/8-24X1*	1 U55067.037.1200	5/8-18X1*	1 U55067.062.1200
NO.10-32X2*	1 U55067.019.2400	3/8-24X2*	1 U55067.037.2400	5/8-18X2*	1 U55067.062.2400
NO.10-32X3*	1 U55067.019.3600	3/8-24X3*	1 U55067.037.3600	5/8-18X3*	1 U55067.062.3600
NO.10-32X6*	1 U55067.019.7200	3/8-24X6*	1 U55067.037.7200	5/8-18X6*	1 U55067.062.7200
1/4-28X1*	1 U55067.025.1200	7/16-20X3*	1 U55067.043.3600	3/4-16X1*	1 U55067.075.1200
1/4-28X2*	1 U55067.025.2400	1/2-20X1*	1 U55067.050.1200	3/4-16X2*	1 U55067.075.2400
1/4-28X3*	1 U55067.025.3600	1/2-20X2*	1 U55067.050.2400	3/4-16X3*	1 U55067.075.3600
1/4-28X6*	1 U55067.025.7200	1/2-20X3*	1 U55067.050.3600	3/4-16X6*	1 U55067.075.7200
5/16-24X1*	1 U55067.031.1200	1/2-20X6*	1 U55067.050.7200	7/8-14X3*	1 U55067.087.3600
5/16-24X2*	1 U55067.031.2400	9/16-18X3*	1 U55067.056.3600		
5/16-24X3*	1 U55067.031.3600				
5/16-24X6*	1 U55067.031.7200				

Pręty gwintowane, BSW

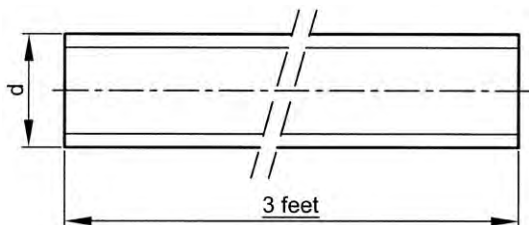

Informacje techniczne

d	Zwoje gwintu na cal	d	Zwoje gwintu na cal
1/8	40	5/8	11
5/32	32	3/4	10
3/16	24	7/8	9
1/4	20	1 Inch	8
5/16	18	1.1/8	7
3/8	16	1.1/4	7
7/16	14	1.1/2	6
1/2	12		

- Gwint Whitworth'a (BSW/BSF) nie jest zalecany do międzynarodowego stosowania.
- Zaleca się stosowanie gwintu metrycznego (M/MF) lub zunifikowanego (UNC/UNF).

Grupy katalogowe

Gwint	Materiał	Klasa	Obróbka powierzchni	Kod	Strona
BSW	St	≥4.8		1 metr	20240 4-20
BSW	St	≥4.8	Ocynk.	1 metr	20252 4-20
BSW	Mosiądz Cu2/Cu3			1 metr	46290 4-20

20240 Pręty gwintowane, BSW X08A



Gwint: Całowy, Whitworth'a (BSW)
 Materiał: Stal
 Klasa: ≥4.8



d	☒	Kod artykułu	d	☒	Kod artykułu	d	☒	Kod artykułu
1/8	20	20240.031.001	3/8	10	20240.096.001	7/8	2	20240.222.001
5/32	20	20240.039.001	7/16	10	20240.111.001	1 Inch	2	20240.254.001
3/16	10	20240.047.001	1/2	10	20240.127.001	1.1/8	2	20240.285.001
1/4	10	20240.063.001	5/8	5	20240.158.001	1.1/4	2	20240.317.001
5/16	10	20240.079.001	3/4	2	20240.191.001	1.1/2	1	20240.381.001

20252 Pręty gwintowane, BSW X08A



Gwint: Całowy, Whitworth'a (BSW)
 Materiał: Stal
 Klasa: ≥4.8
 Obróbka powierzchni: Ocynkowane

d	☒	Kod artykułu	d	☒	Kod artykułu	d	☒	Kod artykułu
1/4	10	20252.063.001	1/2	10	20252.127.001	7/8	2	20252.222.001
5/16	10	20252.079.001	5/8	5	20252.158.001	1 Inch	2	20252.254.001
3/8	10	20252.096.001	3/4	2	20252.191.001			

46290 Pręty gwintowane, BSW X08A

Gwint: Całowy, Whitworth'a (BSW)
 Materiał: Mosiądz Cu2/Cu3

d	☒	Kod artykułu	d	☒	Kod artykułu	d	☒	Kod artykułu
5/32	10	46290.039.001	5/16	10	46290.079.001	5/8	2	46290.158.001
3/16	10	46290.047.001	3/8	5	46290.096.001	3/4	1	46290.191.001
1/4	10	46290.063.001	1/2	2	46290.127.001	7/8	1	46290.222.001

Pręty gwintowane, Permaglas

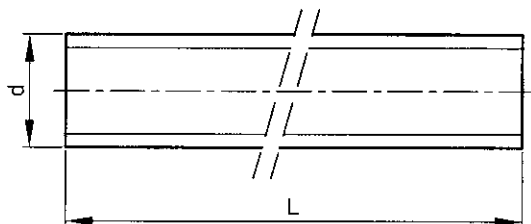

Informacje techniczne

d	P	d	P
M8	1.25	M16	2
M10	1.5	M20	2.5
M12	1.75	M24	3

- Cechy specjalne PERMAGLAS:
- Żywica epoksydowa wzmocniona włóknem szklanym
- Odporność na temperatury od -270°C do +155°C
- Lekka waga (gęstość 1,8)
- Odporna na korozję
- Odporna na agresywne środki chemiczne i gazy
- Izolacja elektryczna i cieplna
- Antymagnetyczność
- Lepsze właściwości mechaniczne od np. poliamidu

56050	Pręty gwintowane, Permaglas	W05G
Gwint	Metryczny	
Materiał	Tworzywo sztuczne wzmocnione włóknem szklanym Permaglas ME 771	
Kolor	Czerwony	

d x L	☒	Kod artykułu	d x L	☒	Kod artykułu	d x L	☒	Kod artykułu
M8X950	1	56050.080.950	M12X1900	1	56050.121.900	M20X1900	1	56050.201.900
M10X950	1	56050.100.950	M16X1900	1	56050.161.900	M24X1900	1	56050.241.900

Nakrętki sześciokątne metryczne, permaglas

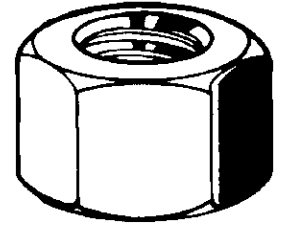
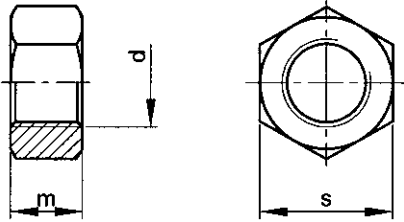

Informacje techniczne

d	m	P	s	d	m	P	s
M8	8	1.25	13	M16	16	2	24
M10	10	1.5	17	M20	20	2.5	30
M12	12	1.75	19	M24	24	3	36

- Cechy specjalne PERMAGLAS:
- Żywica epoksydowa wzmocniona włóknem szklanym
- Odporność na temperatury od -270°C do +155°C
- Lekka waga (gęstość 1,8)
- Odporna na korozję
- Odporna na agresywne środki chemiczne i gazy
- Izolacja elektryczna i cieplna
- Antymagnetyczność
- Lepsze właściwości mechaniczne od np. poliamidu

56052 Nakrętki sześciokątne metryczne, permaglas

W05G

Gwint	Metryczny
Material	Tworzywo sztuczne wzmocnione włóknem szklanym Permaglas ME 730
Kolor	Beż

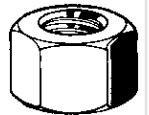

d	☒	Kod artykułu	d	☒	Kod artykułu	d	☒	Kod artykułu
M8	8	56052.080.001	M12	8	56052.120.001	M20	4	56052.200.001
M10	8	56052.100.001	M16	4	56052.160.001	M24	4	56052.240.001

Podkładki okrągłe bez fazy, Permaglas

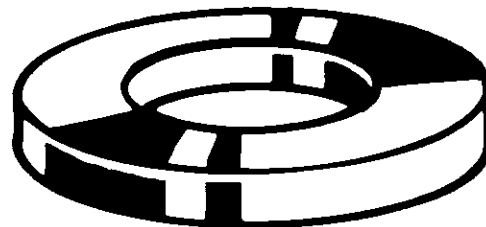
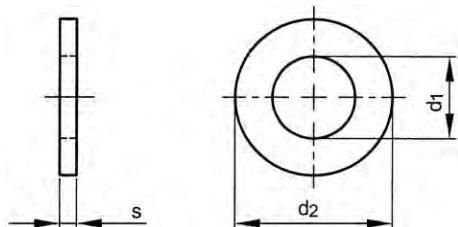

Informacje techniczne

d	d ₁	d ₂	s	d	d ₁	d ₂	s
M8	9	18	1.5	M16	18	32	3
M10	11	22	2	M20	22	40	3
M12	14	27	2.5	M24	27	50	4

- Cechy specjalne PERMAGLAS:
- Żywica epoksydowa wzmocniona włóknem szklanym
- Odporność na temperatury od -270°C do +155°C.
- Lekka waga (gęstość 1,8)
- Odporna na korozję
- Odporna na agresywne środki chemiczne i gazy
- Izolacja elektryczna i cieplna
- Antymagnetyczność
- Lepsze właściwości mechaniczne od np. poliamidu.

4

56054 Podkładki okrągłe bez fazy, Permaglas

W05G

Materiał Tworzywo sztuczne wzmocnione włóknem szklanym Permaglas
ME 730

Kolor Beż



d	☒	Kod artykułu	d	☒	Kod artykułu	d	☒	Kod artykułu
M8	8	56054.080.001	M12	8	56054.120.001	M20	4	56054.200.001
M10	8	56054.100.001	M16	4	56054.160.001	M24	4	56054.240.001

Pręty gwintowane z gwintem trapezowym

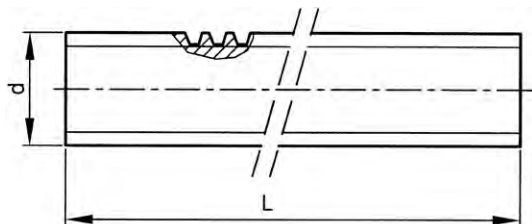

- Gwint trapezowy zgodny z DIN 103, kształt prosty prętów zgodny z DIN 7168-2, klasa tolerancji U.

Grupy katalogowe

Gwint	Materiał	Klasa		Kod	Strona
Tr	St	5.8	1 metr	20460	4-24
Tr	St	5.8	1 metr, lewy gwint	20466	4-24
Tr	St.St. A2		1 metr	51076	4-24
Tr	St	5.8	3 metry	20464	4-24
Tr	St.St. A2		3 metry	51077	4-25

20460 Pręty gwintowane, długość 1m G05A

Gwint	Trapezowy
Materiał	Stal
Klasa	5.8

d x P	☒	Kod artykułu	d x P	☒	Kod artykułu	d x P	☒	Kod artykułu
Tr10X3 (#DIN)	5	20460.100.003	Tr22X5	2	20460.220.005	Tr36X6	1	20460.360.006
Tr12X3	5	20460.120.003	Tr24X5	2	20460.240.005	Tr40X7	1	20460.400.007
Tr14X4	3	20460.140.004	Tr26X5	1	20460.260.005	Tr44X7	1	20460.440.007
Tr16X4	3	20460.160.004	Tr28X5	1	20460.280.005	Tr50X8	1	20460.500.008
Tr18X4	2	20460.180.004	Tr30X6	1	20460.300.006	Tr60X9	1	20460.600.009
Tr20X4	2	20460.200.004	Tr32X6	1	20460.320.006			

20466 Pręty gwintowane, długość 1m, z lewym gwintem G05A

Gwint	Trapezowy
Materiał	Stal
Klasa	5.8

d x P	☒	Kod artykułu	d x P	☒	Kod artykułu	d x P	☒	Kod artykułu
Tr12X3	3	20466.120.003	Tr24X5	1	20466.240.005	Tr36X6	1	20466.360.006
Tr16X4	2	20466.160.004	Tr30X6	1	20466.300.006	Tr40X7	1	20466.400.007
Tr20X4	1	20466.200.004						

51076 Pręty gwintowane, długość 1m R09A

Gwint	Trapezowy
Materiał	Stal nierdzewna A2

d x P	☒	Kod artykułu	d x P	☒	Kod artykułu	d x P	☒	Kod artykułu
Tr12X3	1	51076.120.003	Tr20X4	1	51076.200.004	Tr30X6	1	51076.300.006
Tr16X4	1	51076.160.004	Tr24X5	1	51076.240.005			

20464 Pręty gwintowane, długość 3m G05A

Gwint	Trapezowy
Materiał	Stal
Klasa	5.8

d x P	☒	Kod artykułu	d x P	☒	Kod artykułu	d x P	☒	Kod artykułu
Tr10X3 (#DIN)	1	20464.100.003	Tr20X4	1	20464.200.004	Tr36X6	1	20464.360.006
Tr12X3	1	20464.120.003	Tr24X5	1	20464.240.005	Tr40X7	1	20464.400.007
Tr16X4	1	20464.160.004	Tr30X6	1	20464.300.006			

51077	Pręty gwintowane, długość 1m	R09A
Gwint	Trapezowy	
Material	Stal nierdzewna A2	
		
		

d x P	☒	Kod artykułu	d x P	☒	Kod artykułu	d x P	☒	Kod artykułu
Tr12X3	1	51077.120.003	Tr20X4	1	51077.200.004	Tr30X6	1	51077.300.006
Tr16X4	1	51077.160.004	Tr24X5	1	51077.240.005	Tr36X6	1	51077.360.006

Nakrętki okrągłe z gwintem trapezowym Tr

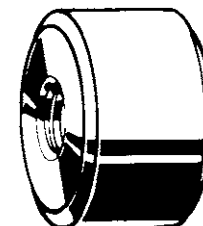
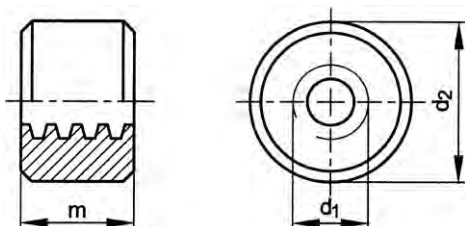

4

Informacje techniczne

d ₁	d ₂	m	d ₁	d ₂	m
Tr10 (#DIN)	22	15	Tr28	60	42
Tr12	26	18	Tr30	60	45
Tr14	30	21	Tr32	60	48
Tr16	36	24	Tr36	75	54
Tr18	40	27	Tr40	80	60
Tr20	45	30	Tr44	80	66
Tr22	45	33	Tr50	90	75
Tr24	50	36	Tr60	100	90
Tr26	50	39			



- Gwint trapezowy zgodny z DIN 103.

Grupy katalogowe

Gwint	Material	Kod	Strona
Tr	Stal automatowa	20470	4-25
Tr	Stal automatowa	20476	4-25
Tr	St.St. A1	51170	4-26

20470	Nakrętki okrągłe z gwintem trapezowym Tr	G05A
Gwint	Trapezowy	
Material	Stal automatowa	
		
		

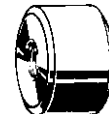
d ₁ x P	☒	Kod artykułu	d ₁ x P	☒	Kod artykułu	d ₁ x P	☒	Kod artykułu
Tr10X3 (#DIN)	10	20470.100.003	Tr22X5	4	20470.220.005	Tr36X6	2	20470.360.006
Tr12X3	10	20470.120.003	Tr24X5	4	20470.240.005	Tr40X7	2	20470.400.007
Tr14X4	6	20470.140.004	Tr26X5	2	20470.260.005	Tr44X7	2	20470.440.007
Tr16X4	6	20470.160.004	Tr28X5	2	20470.280.005	Tr50X8	2	20470.500.008
Tr18X4	4	20470.180.004	Tr30X6	2	20470.300.006	Tr60X9	2	20470.600.009
Tr20X4	4	20470.200.004	Tr32X6	2	20470.320.006			

20476	Nakrętki okrągłe TR z lewym gwintem	G05A
Gwint	Trapezowy	
Material	Stal automatowa	
		
		

d ₁ x P	☒	Kod artykułu	d ₁ x P	☒	Kod artykułu	d ₁ x P	☒	Kod artykułu
Tr12X3	6	20476.120.003	Tr24X5	2	20476.240.005	Tr36X6	2	20476.360.006
Tr16X4	4	20476.160.004	Tr30X6	2	20476.300.006	Tr40X7	2	20476.400.007
Tr20X4	2	20476.200.004	Tr32X6	2	20476.320.006			

51170	Nakrętki okrągłe z gwintem trapezowym Tr			R09A
Gwint	Trapezowy			
Materiał	Stal nierdzewna A1			

$d_1 \times P$	☒	Kod artykułu	$d_1 \times P$	☒	Kod artykułu	$d_1 \times P$	☒	Kod artykułu
Tr12X3	1	51170.120.003	Tr20X4	1	51170.200.004	Tr30X6	1	51170.300.006
Tr16X4	1	51170.160.004	Tr24X5	1	51170.240.005			

Nakrętki okrągłe z gwintem trapezowym

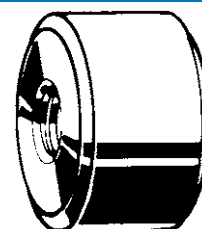
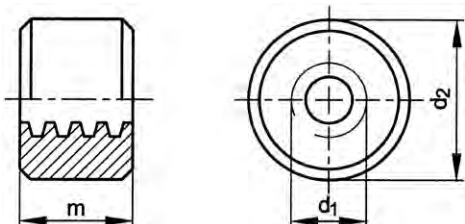

Informacje techniczne

d_1	d_2	m	d_1	d_2	m
Tr12	26	24	Tr30	60	60
Tr16	36	32	Tr36	75	72
Tr20	45	40	Tr40	80	80
Tr24	50	48			

- Gwint trapezowy zgodny z DIN 103.

Grupy katalogowe

Gwint	Materiał	Kod	Strona
Tr	Brąz Cu4	20474	4-26
Tr	Brąz Cu4	lewy gwint	4-26

20474	Nakrętki okrągłe z gwintem trapezowym			G05A
Gwint	Trapezowy			
Materiał	Brąz Cu4			

$d_1 \times P$	☒	Kod artykułu	$d_1 \times P$	☒	Kod artykułu	$d_1 \times P$	☒	Kod artykułu
Tr12X3	6	20474.120.003	Tr24X5	2	20474.240.005	Tr36X6	1	20474.360.006
Tr16X4	4	20474.160.004	Tr30X6	1	20474.300.006	Tr40X7	1	20474.400.007
Tr20X4	2	20474.200.004						

20478	Nakrętka trapezowa okrągła z lewym gwintem			G05A
Gwint	Trapezowy			
Materiał	Brąz Cu4			

$d \times P$	☒	Kod artykułu	$d \times P$	☒	Kod artykułu
TR20X4	2	20478.200.004	TR24X5	1	20478.240.005

Śruby dwustronne o długości części wkręcanej $\approx 1d$ metryczne

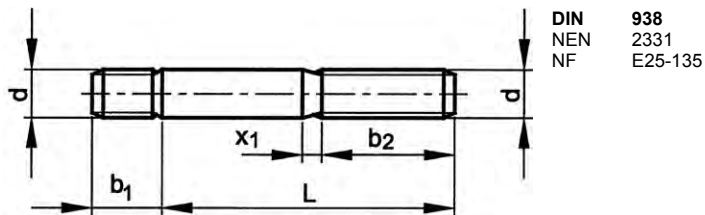

DIN 938
NEN 2331
NF E25-135

Informacje techniczne

d	$b_1 \approx 1d$	b_2	$b_2 = L - (x_1 + 3) \text{ t/m } L \leq$	P	x_1
M5	5	16	20	0.8	2.0
M6	6	18	22	1	2.5
M8	8	22	28	1.25	3.2
M10	10	26	30	1.5	3.8
M12	12	30	35	1.75	4.3
M14	14	34	40	2	5.0
M16	16	38	45	2	5.0
M20	20	46	55	2.5	6.3
M24	24	54	65	3	7.5
M30	30	66	80	3.5	9.0

- UWAGA: podczas zamawiania śrub dwustronnych zgodn. z DIN należy podać średnicę d x efektywną długość L, np. śruba dwustronna M10 x 70 - DIN 938, gdzie L = 70 mm to długość robocza a $b_1 = 10$ mm to metalowy koniec. Łączna długość to $70 + 10 = 80$ mm. Długość gwintu od strony nakrętki $b_2 = 26$ mm.
- Wkręcany koniec gwintowany wykonany z tolerancją Sk6 zgodnie z DIN 13-51, co oznacza "pasowanie mocne" i zapobiega luzowaniu się śrub dwustronnych.
- Śruby dwustronne wg DIN 938 z końcem metalowym $\approx 1d$ mają szereg zastosowań głównie w stali.

Grupy katalogowe

Gwint	Materiał	Klasa	Kod	Strona
M	St	8.8	21560	4-27
M	St.St. A2	70	51280	4-28
M	St.St. A4	70	55280	4-28

21560 Śruby dwustronne o długości części wkręcanej $\approx 1d$ metryczne

G07A

Gwint Metryczny
Materiał Stal
Klasa 8.8



d x L	☒	Kod artykułu	d x L	☒	Kod artykułu	d x L	☒	Kod artykułu
M6X20	200	21560.060.020	M10X50	100	21560.100.050	M16X50	50	21560.160.050
M6X25	200	21560.060.025	M10X55	100	21560.100.055	M16X60	50	21560.160.060
M6X30	200	21560.060.030	M10X60	100	21560.100.060	M16X70	25	21560.160.070
M6X40	200	21560.060.040	M10X70	100	21560.100.070	M16X80	25	21560.160.080
M6X50	200	21560.060.050				M16X90	25	21560.160.090
			M12X25	100	21560.120.025	M16X100	25	21560.160.100
M8X20	100	21560.080.020	M12X30	100	21560.120.030			
M8X25	100	21560.080.025	M12X35	100	21560.120.035	M20X40	25	21560.200.040
M8X30	100	21560.080.030	M12X40	100	21560.120.040	M20X45	25	21560.200.045
M8X35	100	21560.080.035	M12X45	100	21560.120.045	M20X50	25	21560.200.050
M8X40	100	21560.080.040	M12X50	50	21560.120.050	M20X55	25	21560.200.055
M8X50	100	21560.080.050	M12X60	50	21560.120.060	M20X60	25	21560.200.060
M8X60	100	21560.080.060	M12X70	50	21560.120.070	M20X70	25	21560.200.070
M8X70	100	21560.080.070	M12X80	50	21560.120.080	M20X80	25	21560.200.080
			M12X90	50	21560.120.090	M20X100	10	21560.200.100
M10X20	100	21560.100.020	M12X100	50	21560.120.100	M20X120	10	21560.200.120
M10X25	100	21560.100.025						
M10X30	100	21560.100.030	M16X35	50	21560.160.035	M24X60	10	21560.240.060
M10X35	100	21560.100.035	M16X40	50	21560.160.040	M24X70	10	21560.240.070
M10X40	100	21560.100.040	M16X45	50	21560.160.045	M24X80	10	21560.240.080
M10X45	100	21560.100.045						

51280 Śruby dwustronne o długości części wkręcanej ≈ 1d metryczne
R09A
Gwint Metryczny
Materiał Stal nierdzewna A2
Klasa 70

d x L	☒	Kod artykułu	d x L	☒	Kod artykułu	d x L	☒	Kod artykułu
M5X16*	200	51280.050.016	M10X65*	100	51280.100.065	M16X65	10	51280.160.065
M5X20*	200	51280.050.020	M10X70	25	51280.100.070	M16X70*	50	51280.160.070
M6X16*	200	51280.060.016	M10X80*	100	51280.100.080	M16X75*	50	51280.160.075
M6X20	100	51280.060.020	M10X90*	100	51280.100.090	M16X80	10	51280.160.080
M6X25	100	51280.060.025	M10X100*	100	51280.100.100	M16X85*	50	51280.160.085
M6X30	100	51280.060.030	M10X110*	100	51280.100.110	M16X90*	50	51280.160.090
M6X35	100	51280.060.035	M12X20*	100	51280.120.020	M16X100*	50	51280.160.100
M6X40	100	51280.060.040	M12X25*	100	51280.120.025	M16X110*	50	51280.160.110
M6X45*	200	51280.060.045	M12X30	10	51280.120.030	M20X35*	50	51280.200.035
M6X50*	200	51280.060.050	M12X35	10	51280.120.035	M20X40	5	51280.200.040
M6X55*	200	51280.060.055	M12X40	10	51280.120.040	M20X45	5	51280.200.045
M8X16*	200	51280.080.016	M12X45	10	51280.120.045	M20X50	5	51280.200.050
M8X20	50	51280.080.020	M12X50	10	51280.120.050	M20X55	5	51280.200.055
M8X25	50	51280.080.025	M12X55	10	51280.120.055	M20X60	5	51280.200.060
M8X30	50	51280.080.030	M12X60	10	51280.120.060	M20X65*	50	51280.200.065
M8X35	50	51280.080.035	M12X65*	100	51280.120.065	M20X70	5	51280.200.070
M8X40	50	51280.080.040	M12X70	10	51280.120.070	M20X75	5	51280.200.075
M8X45*	200	51280.080.045	M12X75*	100	51280.120.075	M20X80	5	51280.200.080
M8X50	50	51280.080.050	M12X80	10	51280.120.080	M20X85*	50	51280.200.085
M8X55*	200	51280.080.055	M12X90*	100	51280.120.090	M20X90*	50	51280.200.090
M8X60	50	51280.080.060	M12X100*	100	51280.120.100	M20X100*	50	51280.200.100
M8X70	50	51280.080.070	M12X110*	100	51280.120.110	M24X50*	50	51280.240.050
M10X16*	100	51280.100.016	M14X30*	50	51280.140.030	M24X60*	50	51280.240.060
M10X20	25	51280.100.020	M14X40*	50	51280.140.040	M24X65*	50	51280.240.065
M10X25	25	51280.100.025	M14X50*	50	51280.140.050	M24X70*	50	51280.240.070
M10X30	25	51280.100.030	M16X30*	50	51280.160.030	M24X75*	50	51280.240.075
M10X35	25	51280.100.035	M16X35	10	51280.160.035	M24X80*	50	51280.240.080
M10X40	25	51280.100.040	M16X40	10	51280.160.040	M27X85*	25	51280.270.085
M10X45*	100	51280.100.045	M16X45	10	51280.160.045	M30X80*	25	51280.300.080
M10X50	25	51280.100.050	M16X50	10	51280.160.050	M30X90*	25	51280.300.090
M10X55	25	51280.100.055	M16X55	10	51280.160.055			
M10X60	25	51280.100.060	M16X60	10	51280.160.060			

* Rozmiary o średnicy > M24 i rozmiary o długości > 8xd mają minimalną klasę właściwości 50.

55280 Śruby dwustronne o długości części wkręcanej ≈ 1d metryczne
R49A
Gwint Metryczny
Materiał Stal nierdzewna A4
Klasa 70

d x L	☒	Kod artykułu	d x L	☒	Kod artykułu	d x L	☒	Kod artykułu
M5X20*	200	55280.050.020	M8X75*	200	55280.080.075	M12X70*	100	55280.120.070
M6X16*	200	55280.060.016	M8X90*	200	55280.080.090	M12X75*	100	55280.120.075
M6X20*	200	55280.060.020	M8X95*	200	55280.080.095	M12X80*	100	55280.120.080
M6X25*	200	55280.060.025	M10X20*	100	55280.100.020	M12X85*	100	55280.120.085
M6X30*	200	55280.060.030	M10X25*	100	55280.100.025	M12X90*	100	55280.120.090
M6X35*	200	55280.060.035	M10X30*	100	55280.100.030	M12X95*	100	55280.120.095
M6X40*	200	55280.060.040	M10X35	100	55280.100.035	M14X80*	50	55280.140.080
M6X50*	200	55280.060.050	M10X40*	100	55280.100.040	M16X30	50	55280.160.030
M6X55*	200	55280.060.055	M10X45*	100	55280.100.045	M16X35*	50	55280.160.035
M6X60*	200	55280.060.060	M10X50*	100	55280.100.050	M16X40*	50	55280.160.040
M6X65*	200	55280.060.065	M10X55*	100	55280.100.055	M16X45*	50	55280.160.045
M6X70*	200	55280.060.070	M10X60*	100	55280.100.060	M16X50*	50	55280.160.050
M6X80*	200	55280.060.080	M10X70*	100	55280.100.070	M16X55*	50	55280.160.055
M6X90*	200	55280.060.090	M10X85*	100	55280.100.085	M16X60*	50	55280.160.060
M8X16*	200	55280.080.016	M10X90*	100	55280.100.090	M16X65*	50	55280.160.065
M8X20*	200	55280.080.020	M12X25*	100	55280.120.025	M16X70*	50	55280.160.070
M8X25*	200	55280.080.025	M12X30*	100	55280.120.030	M16X75*	50	55280.160.075
M8X30*	200	55280.080.030	M12X35*	100	55280.120.035	M16X80*	50	55280.160.080
M8X35*	200	55280.080.035	M12X40	100	55280.120.040	M16X85*	50	55280.160.085
M8X40*	200	55280.080.040	M12X45*	100	55280.120.045	M16X90*	50	55280.160.090
M8X45*	200	55280.080.045	M12X50*	100	55280.120.050	M16X100*	50	55280.160.100
M8X50*	200	55280.080.050	M12X55*	100	55280.120.055	M16X110*	50	55280.160.110
M8X55*	200	55280.080.055	M12X60*	100	55280.120.060			
M8X60*	200	55280.080.060	M12X65*	100	55280.120.065	M20X35*	50	55280.200.035

55280 Śruby dwustronne o długości części wkręcanej ≈ 1d metryczne								
d x L	☒	Kod artykułu	d x L	☒	Kod artykułu	d x L	☒	Kod artykułu
M20X40*	50	55280.200.040	M20X60*	50	55280.200.060	M20X80*	50	55280.200.080
M20X45*	50	55280.200.045	M20X65*	50	55280.200.065	M20X90*	50	55280.200.090
M20X50*	50	55280.200.050	M20X70*	50	55280.200.070	M20X100*	50	55280.200.100
M20X55*	50	55280.200.055	M20X75*	50	55280.200.075	M20X120*	50	55280.200.120

- Rozmiary o średnicy > M24 i rozmiary o długości > 8xd mają minimalną klasę właściwości 50.

Śruby dwustronne o długości części wkręcanej ≈ 1,25d metryczne

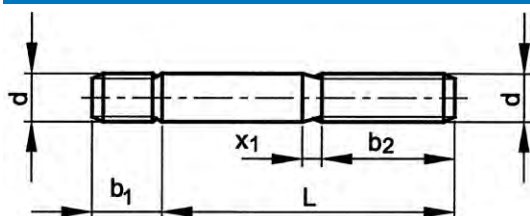

DIN 939
NEN 2332
NF E25-135



4

Informacje techniczne

d	$b_1 \approx 1,25d$	$b_2: L \leq 125mm$	$b_2: 125mm < L \leq 200mm$	$b_2 = L - (x_1 + 3) t/m L \leq$	P	x_1
M6	7.5	18	24	20	1	2.5
M8	10	22	28	25	1.25	3.2
M10	12	26	32	30	1.5	3.8
M12	15	30	36	35	1.75	4.3
M14	18	34	40	40	2	5.0
M16	20	38	44	45	2	5.0
M18	22	42	48	50	2.5	6.3
M20	25	46	52	55	2.5	6.3
M22	28	50	56	60	2.5	6.3
M24	30	54	60	65	3	7.5
M27	35	60	66	70	3	7.5

- UWAGA: przy zamawianiu śrub dwustronnych zgodn. z DIN należy podać średnicę d x efektywną długość L, np. śruba dwustronna M10 x 65 - DIN 939, gdzie L = 65 mm to długość robocza, a $b_1 = 12$ mm to metalowy koniec. Łączna długość to $65 + 12 = 77$ mm. Długość gwintu od strony nakrętki $b_2 = 26$ mm.
- Wkręcany koniec gwintowany wykonany z tolerancją Sk6 zgodnie z DIN 13-51, co oznacza "pasowanie mocne" i zapobiega luzowaniu się śrub dwustronnych.
- Śruby dwustronne zgodny z DIN 939 (5.6/5.8/8.8) . 1,25d mają wiele zastosowań, między innymi do żeliwa.

Grupy katalogowe

Gwint	Materiał	Klasa	Obróbka powierzchni	Kod	Strona
M	St	5.6/5.8		21500	4-29
M	St	5.6/5.8	O cynk.	21510	4-30
M	St	5.6/5.8	O cynk. żłt. pas.	21515	4-30
M	St	8.8		21520	4-30
M	St.St. A2	70		51270	4-31
M	St.St. A4	70		55270	4-32

21500 Śruby dwustronne o długości części wkręcanej ≈ 1,25d metryczne



G07A

Gwint Metryczny
Materiał Stal
Klasa 5.6/5.8



d x L	☒	Kod artykułu	d x L	☒	Kod artykułu	d x L	☒	Kod artykułu
M6X20	200	21500.060.020	M8X65	100	21500.080.065	M12X35	100	21500.120.035
M6X25	200	21500.060.025	M8X70	100	21500.080.070	M12X40	100	21500.120.040
M6X30	200	21500.060.030				M12X45	100	21500.120.045
M6X35	200	21500.060.035	M10X20	100	21500.100.020	M12X50	50	21500.120.050
M6X40	200	21500.060.040	M10X25	100	21500.100.025	M12X55	50	21500.120.055
M6X45	200	21500.060.045	M10X30	100	21500.100.030	M12X60	50	21500.120.060
M6X50	200	21500.060.050	M10X35	100	21500.100.035	M12X65	50	21500.120.065
M6X55	200	21500.060.055	M10X40	100	21500.100.040	M12X70	50	21500.120.070
			M10X45	100	21500.100.045	M12X75	50	21500.120.075
M8X20	100	21500.080.020	M10X50	100	21500.100.050	M12X80	50	21500.120.080
M8X25	100	21500.080.025	M10X55	100	21500.100.055	M12X90	50	21500.120.090
M8X30	100	21500.080.030	M10X60	100	21500.100.060	M12X100	50	21500.120.100
M8X35	100	21500.080.035	M10X65	100	21500.100.065			
M8X40	100	21500.080.040	M10X70	100	21500.100.070	M14X40	50	21500.140.040
M8X45	100	21500.080.045				M14X50	50	21500.140.050
M8X50	100	21500.080.050	M12X25	100	21500.120.025	M14X60	50	21500.140.060
M8X60	100	21500.080.060	M12X30	100	21500.120.030			



21500 Śruby dwustronne o długości części wkręcanej ≈ 1,25d metryczne								
d x L	☒	Kod artykułu	d x L	☒	Kod artykułu	d x L	☒	Kod artykułu
M16X30	50	21500.160.030	M20X50	25	21500.200.050	M22X80	10	21500.220.080
M16X35	50	21500.160.035	M20X55	25	21500.200.055	M22X90	10	21500.220.090
M16X40	50	21500.160.040	M20X60	25	21500.200.060	M22X100	10	21500.220.100
M16X45	50	21500.160.045	M20X65	25	21500.200.065	M22X110	10	21500.220.110
M16X50	50	21500.160.050	M20X70	25	21500.200.070	M22X120	10	21500.220.120
M16X55	50	21500.160.055	M20X75	25	21500.200.075	M22X140	10	21500.220.140
M16X60	50	21500.160.060	M20X80	25	21500.200.080			
M16X65	25	21500.160.065	M20X90	10	21500.200.090	M24X50	10	21500.240.050
M16X70	25	21500.160.070	M20X100	10	21500.200.100	M24X60	10	21500.240.060
M16X75	25	21500.160.075	M20X110	10	21500.200.110	M24X70	10	21500.240.070
M16X80	25	21500.160.080	M20X120	10	21500.200.120	M24X80	10	21500.240.080
M16X90	25	21500.160.090	M20X140	10	21500.200.140	M24X90	10	21500.240.090
M16X100	25	21500.160.100				M24X100	10	21500.240.100
			M22X50	10	21500.220.050	M24X110	10	21500.240.110
M20X40	25	21500.200.040	M22X60	10	21500.220.060	M24X120	10	21500.240.120
M20X45	25	21500.200.045	M22X70	10	21500.220.070	M24X140	10	21500.240.140

21510 Śruby dwustronne o długości części wkręcanej ≈ 1,25d metryczne			G07A	
Gwint	Metryczny			
Materiał	Stal			
Klasa	5.6/5.8			
Obróbka powierzchni	Ocynkowane			
				
				

d x L	☒	Kod artykułu	d x L	☒	Kod artykułu	d x L	☒	Kod artykułu
M6X20	200	21510.060.020	M8X50	100	21510.080.050	M12X30	100	21510.120.030
M6X25	200	21510.060.025	M8X60	100	21510.080.060	M12X35	100	21510.120.035
M6X30	200	21510.060.030				M12X40	100	21510.120.040
M6X35	200	21510.060.035	M10X20	100	21510.100.020	M12X50	50	21510.120.050
M6X40	200	21510.060.040	M10X25	100	21510.100.025	M12X60	50	21510.120.060
M6X45	200	21510.060.045	M10X30	100	21510.100.030			
M6X50	200	21510.060.050	M10X35	100	21510.100.035	M16X35	50	21510.160.035
			M10X40	100	21510.100.040	M16X40	50	21510.160.040
M8X20	100	21510.080.020	M10X50	100	21510.100.050	M16X45	50	21510.160.045
M8X25	100	21510.080.025	M10X60	100	21510.100.060	M16X50	50	21510.160.050
M8X30	100	21510.080.030				M16X55	50	21510.160.055
M8X35	100	21510.080.035	M12X25	100	21510.120.025	M16X60	50	21510.160.060
M8X40	100	21510.080.040						

21515 Śruby dwustronne o długości części wkręcanej ≈ 1,25d metryczne			G07A	
Gwint	Metryczny			
Materiał	Stal			
Klasa	5.6/5.8			
Obróbka powierzchni	Ocynkowane, po żółtej pasywacji			
				

d x L	☒	Kod artykułu	d x L	☒	Kod artykułu	d x L	☒	Kod artykułu
M6X20	200	21515.060.020	M8X50	100	21515.080.050	M12X30	100	21515.120.030
M6X25	200	21515.060.025	M8X60	100	21515.080.060	M12X35	100	21515.120.035
M6X30	200	21515.060.030				M12X40	100	21515.120.040
M6X35	200	21515.060.035	M10X20	100	21515.100.020	M12X50	50	21515.120.050
M6X40	200	21515.060.040	M10X25	100	21515.100.025	M12X60	50	21515.120.060
M6X45	200	21515.060.045	M10X30	100	21515.100.030			
M6X50	200	21515.060.050	M10X35	100	21515.100.035	M16X35	50	21515.160.035
			M10X40	100	21515.100.040	M16X40	50	21515.160.040
M8X20	100	21515.080.020	M10X50	100	21515.100.050	M16X45	50	21515.160.045
M8X25	100	21515.080.025	M10X60	100	21515.100.060	M16X50	50	21515.160.050
M8X30	100	21515.080.030				M16X55	50	21515.160.055
M8X35	100	21515.080.035	M12X25	100	21515.120.025	M16X60	50	21515.160.060
M8X40	100	21515.080.040						

21520 Śruby dwustronne o długości części wkręcanej ≈ 1,25d metryczne			G07A	
Gwint	Metryczny			
Materiał	Stal			
Klasa	8.8			
				
				

d x L	☒	Kod artykułu	d x L	☒	Kod artykułu	d x L	☒	Kod artykułu
M6X20	200	21520.060.020	M6X40	200	21520.060.040			
M6X25	200	21520.060.025	M6X45	200	21520.060.045	M8X20	100	21520.080.020
M6X30	200	21520.060.030	M6X50	200	21520.060.050	M8X25	100	21520.080.025
M6X35	200	21520.060.035	M6X55	200	21520.060.055	M8X30	100	21520.080.030

21520 Śruby dwustronne o długości części wkręcanej ≈ 1,25d metryczne								
d x L	☒	Kod artykułu	d x L	☒	Kod artykułu	d x L	☒	Kod artykułu
M8X35	100	21520.080.035	M12X65	50	21520.120.065	M20X50	25	21520.200.050
M8X40	100	21520.080.040	M12X70	50	21520.120.070	M20X55	25	21520.200.055
M8X45	100	21520.080.045	M12X75	50	21520.120.075	M20X60	25	21520.200.060
M8X50	100	21520.080.050	M12X80	50	21520.120.080	M20X65	25	21520.200.065
M8X60	100	21520.080.060	M12X90	50	21520.120.090	M20X70	25	21520.200.070
M8X65	100	21520.080.065	M12X100	50	21520.120.100	M20X75	25	21520.200.075
M8X70	100	21520.080.070				M20X80	25	21520.200.080
			M14X30	50	21520.140.030	M20X90	10	21520.200.090
M10X20	100	21520.100.020	M14X35	50	21520.140.035	M20X100	10	21520.200.100
M10X25	100	21520.100.025	M14X40	50	21520.140.040	M20X110	10	21520.200.110
M10X30	100	21520.100.030	M14X50	50	21520.140.050	M20X120	10	21520.200.120
M10X35	100	21520.100.035	M14X60	50	21520.140.060	M20X140	10	21520.200.140
M10X40	100	21520.100.040						
M10X45	100	21520.100.045	M16X35	50	21520.160.035	M22X60	10	21520.220.060
M10X50	100	21520.100.050	M16X40	50	21520.160.040	M22X70	10	21520.220.070
M10X55	100	21520.100.055	M16X45	50	21520.160.045	M22X80	10	21520.220.080
M10X60	100	21520.100.060	M16X50	50	21520.160.050			
M10X65	100	21520.100.065	M16X55	50	21520.160.055	M24X50	10	21520.240.050
M10X70	100	21520.100.070	M16X60	50	21520.160.060	M24X60	10	21520.240.060
			M16X65	25	21520.160.065	M24X70	10	21520.240.070
M12X25	100	21520.120.025	M16X70	25	21520.160.070	M24X75	10	21520.240.075
M12X30	100	21520.120.030	M16X75	25	21520.160.075	M24X80	10	21520.240.080
M12X35	100	21520.120.035	M16X80	25	21520.160.080	M24X90	10	21520.240.090
M12X40	100	21520.120.040	M16X90	25	21520.160.090	M24X100	10	21520.240.100
M12X45	100	21520.120.045	M16X100	25	21520.160.100	M24X110	10	21520.240.110
M12X50	50	21520.120.050				M24X120	10	21520.240.120
M12X55	50	21520.120.055	M20X40	25	21520.200.040			
M12X60	50	21520.120.060	M20X45	25	21520.200.045	M27X100	10	21520.270.100

4

51270 Śruby dwustronne o długości części wkręcanej ≈ 1,25d metryczne			R09A	
Gwint	Metryczny			
Material	Stal nierdzewna A2			
Klasa	70			

d x L	☒	Kod artykułu	d x L	☒	Kod artykułu	d x L	☒	Kod artykułu
M6X16*	200	51270.060.016	M10X40	25	51270.100.040	M16X40	10	51270.160.040
M6X20	100	51270.060.020	M10X45	25	51270.100.045	M16X45	10	51270.160.045
M6X25	100	51270.060.025	M10X50	25	51270.100.050	M16X50	10	51270.160.050
M6X30	100	51270.060.030	M10X55	25	51270.100.055	M16X55	10	51270.160.055
M6X35	100	51270.060.035	M10X60	25	51270.100.060	M16X60	10	51270.160.060
M6X40	100	51270.060.040	M10X65	25	51270.100.065	M16X65	10	51270.160.065
M6X45	100	51270.060.045	M10X70	25	51270.100.070	M16X70	10	51270.160.070
M6X50	100	51270.060.050	M10X75	25	51270.100.075	M16X75	10	51270.160.075
M6X55*	200	51270.060.055	M10X80	25	51270.100.080	M16X80	10	51270.160.080
M6X60	100	51270.060.060	M10X90	10	51270.100.090	M16X90	10	51270.160.090
M6X70	100	51270.060.070	M10X100	10	51270.100.100	M16X100	10	51270.160.100
M6X80	100	51270.060.080	M10X120*	100	51270.100.120	M16X110*	50	51270.160.110
M6X90	100	51270.060.090						
M6X100	100	51270.060.100	M12X20	10	51270.120.020	M20X35*	50	51270.200.035
			M12X25	10	51270.120.025	M20X40	5	51270.200.040
M8X16	200	51270.080.016	M12X30	10	51270.120.030	M20X45	5	51270.200.045
M8X20	50	51270.080.020	M12X35	10	51270.120.035	M20X50	5	51270.200.050
M8X25	50	51270.080.025	M12X40	10	51270.120.040	M20X55	5	51270.200.055
M8X30	50	51270.080.030	M12X45	10	51270.120.045	M20X60	5	51270.200.060
M8X35	50	51270.080.035	M12X50	10	51270.120.050	M20X65	5	51270.200.065
M8X40	50	51270.080.040	M12X55	10	51270.120.055	M20X70	5	51270.200.070
M8X45	50	51270.080.045	M12X60	10	51270.120.060	M20X75	5	51270.200.075
M8X50	50	51270.080.050	M12X65	10	51270.120.065	M20X80	5	51270.200.080
M8X55*	200	51270.080.055	M12X70	10	51270.120.070	M20X85*	50	51270.200.085
M8X60	50	51270.080.060	M12X75	10	51270.120.075	M20X90	5	51270.200.090
M8X70	50	51270.080.070	M12X80	10	51270.120.080	M20X100	5	51270.200.100
M8X75*	200	51270.080.075	M12X90	10	51270.120.090	M20X110*	50	51270.200.110
M8X80	50	51270.080.080	M12X100	10	51270.120.100	M20X120	5	51270.200.120
M8X90	25	51270.080.090	M12X110*	100	51270.120.110			
M8X100	25	51270.080.100	M12X120*	100	51270.120.120	M24X65*	50	51270.240.065
M8X110*	200	51270.080.110				M24X70*	50	51270.240.070
			M14X40*	50	51270.140.040	M24X80*	50	51270.240.080
M10X20	25	51270.100.020	M14X70*	50	51270.140.070	M24X90	50	51270.240.090
M10X22*	100	51270.100.022				M24X100*	50	51270.240.100
M10X25	25	51270.100.025	M16X25*	50	51270.160.025			
M10X30	25	51270.100.030	M16X30	10	51270.160.030	M27X75*	25	51270.270.075
M10X35	25	51270.100.035	M16X35	10	51270.160.035			

* Rozmiary o średnicy > M24 i rozmiary o długości > 8xd mają minimalną klasę właściwości 50.

Gwint Metryczny
Materiał Stal nierdzewna A4
Klasa 70

d x L	☒	Kod artykułu	d x L	☒	Kod artykułu	d x L	☒	Kod artykułu
M6X16*	200	55270.060.016	M10X50	25	55270.100.050	M16X55	10	55270.160.055
M6X20	100	55270.060.020	M10X55	25	55270.100.055	M16X60	10	55270.160.060
M6X25	100	55270.060.025	M10X60	25	55270.100.060	M16X65	10	55270.160.065
M6X30	100	55270.060.030	M10X65	25	55270.100.065	M16X70	10	55270.160.070
M6X35	100	55270.060.035	M10X70	25	55270.100.070	M16X75	10	55270.160.075
M6X40	100	55270.060.040	M10X75*	100	55270.100.075	M16X80	10	55270.160.080
M6X45	100	55270.060.045	M10X80	25	55270.100.080	M16X90*	50	55270.160.090
M6X50	100	55270.060.050	M10X90	10	55270.100.090	M16X100	10	55270.160.100
M6X60	100	55270.060.060	M10X100	10	55270.100.100	M16X120*	50	55270.160.120
M6X65*	200	55270.060.065						
M6X70	100	55270.060.070	M12X20	10	55270.120.020	M18X45*	50	55270.180.045
M6X80	100	55270.060.080	M12X25	10	55270.120.025			
M6X100	100	55270.060.100	M12X30	10	55270.120.030	M20X40	5	55270.200.040
			M12X35	10	55270.120.035	M20X45	5	55270.200.045
M8X16*	200	55270.080.016	M12X40	10	55270.120.040	M20X50	5	55270.200.050
M8X20	50	55270.080.020	M12X45	10	55270.120.045	M20X55	5	55270.200.055
M8X25	50	55270.080.025	M12X50	10	55270.120.050	M20X60	5	55270.200.060
M8X30	50	55270.080.030	M12X55	10	55270.120.055	M20X65	5	55270.200.065
M8X35	50	55270.080.035	M12X60*	100	55270.120.060	M20X70	5	55270.200.070
M8X40	50	55270.080.040	M12X65	10	55270.120.065	M20X75	5	55270.200.075
M8X45	50	55270.080.045	M12X70	10	55270.120.070	M20X80	5	55270.200.080
M8X50	50	55270.080.050	M12X75	10	55270.120.075	M20X85*	50	55270.200.085
M8X55*	200	55270.080.055	M12X80*	100	55270.120.080	M20X90	5	55270.200.090
M8X60	50	55270.080.060	M12X90	10	55270.120.090	M20X100	5	55270.200.100
M8X65*	200	55270.080.065	M12X100	10	55270.120.100	M20X110*	50	55270.200.110
M8X70	50	55270.080.070	M12X110*	100	55270.120.110	M20X120	5	55270.200.120
M8X80	50	55270.080.080	M12X120*	100	55270.120.120			
M8X100	25	55270.080.100				M24X50*	50	55270.240.050
			M14X35*	50	55270.140.035	M24X60	5	55270.240.060
M10X20	25	55270.100.020				M24X70	5	55270.240.070
M10X25	25	55270.100.025	M16X30	10	55270.160.030	M24X80	5	55270.240.080
M10X30	25	55270.100.030	M16X35	10	55270.160.035	M24X90	5	55270.240.090
M10X35	25	55270.100.035	M16X40	10	55270.160.040	M24X100	5	55270.240.100
M10X40	25	55270.100.040	M16X45	10	55270.160.045			
M10X45	25	55270.100.045	M16X50	10	55270.160.050			

• Rozmiary o średnicy > M24 i rozmiary o długości > 8xd mają minimalną klasę właściwości 50.

4

Śruby dwustronne, $\approx 1,25d$ BSW

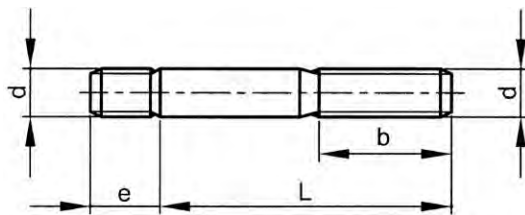

DIN ≈ 939 (1955)
NEN ≈ 2346 (1962)



Informacje techniczne

d	b	e $\approx 1,25d$	Zwoje gwintu na cal	d	b	e $\approx 1,25d$	Zwoje gwintu na cal
5/16	18	10	18	5/8	28	20	11
3/8	20	12	16	3/4	32	25	10
1/2	25-30	16	12	1 Inch	40-55	35	8

- Gwint Whitworth'a (BSW/BSF) nie jest zalecany do międzynarodowego stosowania.
- Zaleca się stosowanie gwintu metrycznego (M/MF) lub zunifikowanego (UNC/UNF).
- UWAGA: przy zamawianiu śrub dwustronnych zgodn. z DIN należy podać średnicę d x efektywną długość L, np. śruba dwustronna 5/16 x 25, gdzie L = 25 mm to długość robocza a e 10 mm to metalowy koniec.
- Łączna długość to 25 + 10 = 35 mm.
- Długość gwintu od strony nakrętki b = 18 mm.
- Śruby dwustronne zgodn. z . DIN 939 (1955) z końcem metalowym e . 1,25 d mają wiele zastosowań, między innymi do żeliwa.
- Wkręcany koniec gwintowany został wykonany z tolerancją Sk6, zgodn. z DIN 13 i 14, Beiblatt 14 (1944), co oznacza "pasowanie mocne" i co zapobiega luzowaniu się śrub dwustronnych podczas demontażu.

21540 Śruby dwustronne, $\approx 1,25d$ BSW		X08A
Gwint	Calowy, Whitworth'a (BSW)	
Materiał	Stal	
Klasa	5.6/5.8	

d x L	☒	Kod artykułu	d x L	☒	Kod artykułu	d x L	☒	Kod artykułu
5/16X25MM	100	21540.079.025	1/2X35MM	50	21540.127.035	5/8X70MM	25	21540.158.070
5/16X30MM	100	21540.079.030	1/2X40MM	50	21540.127.040	5/8X80MM	25	21540.158.080
5/16X35MM	100	21540.079.035	1/2X45MM	50	21540.127.045			
			1/2X50MM	50	21540.127.050	3/4X50MM	25	21540.191.050
3/8X25MM	100	21540.096.025	1/2X60MM	50	21540.127.060	3/4X60MM	25	21540.191.060
3/8X30MM	100	21540.096.030	1/2X70MM	50	21540.127.070	3/4X70MM	25	21540.191.070
3/8X35MM	100	21540.096.035	1/2X80MM	50	21540.127.080	3/4X80MM	10	21540.191.080
3/8X40MM	100	21540.096.040						
3/8X50MM	100	21540.096.050	5/8X45MM	25	21540.158.045	1.IN.X50MM	10	21540.254.050
			5/8X50MM	25	21540.158.050	1.IN.X60MM	10	21540.254.060
1/2X30MM	50	21540.127.030	5/8X60MM	25	21540.158.060	1.IN.X100MM	10	21540.254.100

- W zależności od dostępności może być dostarczona klasa 5.8.

D835 A2 śruby dwustronne ~2d

DIN 835

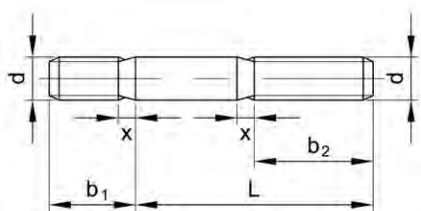

Informacje techniczne



d	b ₁	b ₂ = L - (x + 3mm) t/m L ≤	b ₂ : 125mm < L ≤ 200mm	b ₂ : L ≤ 125mm	b ₂ : L ≥ 200mm	P	x
M6	12	20	24	18	-	1	2.5
M8	16	25	28	22	-	1.25	3.2
M10	20	28	32	26	45	1.5	3.8
M12	24	35	36	30	49	1.75	4.3
M16	32	45	44	38	57	2	5

Grupy katalogowe

Gwint	Materiał	Kod	Strona
M	St.St. A2	51285	4-34
M	St.St. A4	55285	4-34

51285	D835 A2 śruby dwustronne ~2d	R09A
Gwint	Metryczny	
Materiał	Stal nierdzewna A2	
		
		

d x L	☒	Kod artykułu	d x L	☒	Kod artykułu	d x L	☒	Kod artykułu
M6X20*	200	51285.060.020	M8X50*	200	51285.080.050	M12X70*	100	51285.120.070
M6X50*	200	51285.060.050	M8X65*	200	51285.080.065	M12X80*	100	51285.120.080
M8X20*	200	51285.080.020	M8X90*	200	51285.080.090	M16X45*	50	51285.160.045
M8X25*	200	51285.080.025	M10X30*	100	51285.100.030	M16X60*	50	51285.160.060
M8X30*	200	51285.080.030	M10X35*	100	51285.100.035	M16X85*	50	51285.160.085
M8X35*	200	51285.080.035	M10X40*	100	51285.100.040			
M8X40*	200	51285.080.040	M10X45*	100	51285.100.045			
M8X45*	200	51285.080.045	M10X60*	100	51285.100.060			

55285	D835 A2 śruby dwustronne ~2d	R49A
Gwint	Metryczny	
Materiał	Stal nierdzewna A4	
		
		

d x L	☒	Kod artykułu	d x L	☒	Kod artykułu	d x L	☒	Kod artykułu
M10X35*	100	55285.100.035				M12X40*	100	55285.120.040

Pręty gwintowane, ASTM

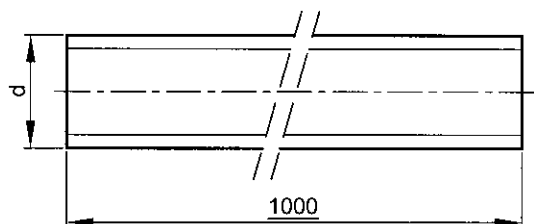

Informacje techniczne

d	Zwoje gwintu na cal	d	Zwoje gwintu na cal
1/4	20	1.1/4	8
5/16	18	1.3/8	8
3/8	16	1.1/2	8
7/16	14	1.5/8	8
1/2	13	1.3/4	8
9/16	12	1.7/8	8
5/8	11	2 Inch	8
3/4	10	2.1/4	8
7/8	9	2.1/2	8
1 Inch	8	2.3/4	8
1.1/8	8		

Grupy katalogowe

Gwint	Materiał	Klasa		Kod	Strona
UNC	St ASTM A193	Gr.B7	1 metr	22180	4-35
8 UN	St ASTM A193	Gr.B7	1 metr	22190	4-35

22180 Pręty gwintowane, ASTM, UNC					G09A
Gwint	Calowy, zunifikowany grubozwojny (UNC)				
Materiał	Stal ASTM A193				
Klasa	Gr.B7				

d	☒	Kod artykułu	d	☒	Kod artykułu	d	☒	Kod artykułu
1/4	1	22180.063.001	1/2	1	22180.127.001	7/8	1	22180.222.001
5/16	1	22180.079.001	5/8	1	22180.158.001	1 Inch	1	22180.254.001
3/8	1	22180.096.001	3/4	1	22180.191.001			

22190 Pręty gwintowane, ASTM, 8UN					G09A
Gwint	8 UN amerykański				
Materiał	Stal ASTM A193				
Klasa	Gr.B7				

d	☒	Kod artykułu	d	☒	Kod artykułu	d	☒	Kod artykułu
1.1/8	1	22190.285.001	1.5/8	1	22190.412.001	2.1/4	1	22190.571.001
1.1/4	1	22190.317.001	1.3/4	1	22190.444.001	2.1/2	1	22190.635.001
1.3/8	1	22190.349.001	1.7/8	1	22190.476.001	2.3/4	1	22190.698.001
1.1/2	1	22190.381.001	2 Inch	1	22190.508.001			

FABORY, GLOBALNY PARTNER W ŚRUBACH DWUSTRONNYCH

4

Fabory dostarcza szeroki i dobrze dobrany asortyment śrub dwustronnych niemal w każdej klasie, średnicy, długości czy typie gwintu (metryczne i niemetryczne)

- Wybór materiału od standardowych (np. stal / stal nierdzewna) do wysoce specjalistycznych (np. Hastelloy)
- Kilka rodzajów powłok
- Wszystkie wymagane normy i atesty
- Pełne wyposażenie produkcyjne pod indywidualne rozwiązania w śrubach dwustronnych
- Atestowane, z pełnym śledzeniem partii

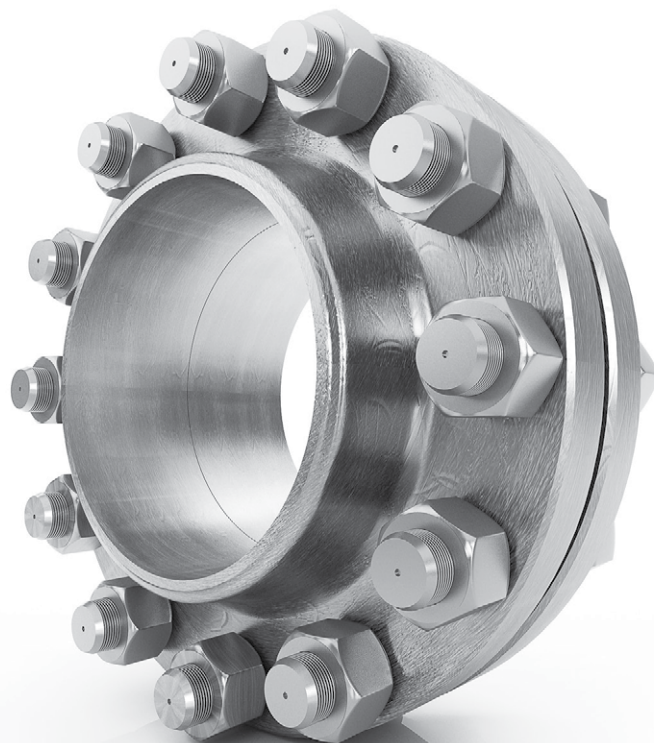

Wejdź na www.fabory.com i sprawdź najaktualniejszą ofertę śrub dwustronnych

Śruby dwustronne – pręty gwintowane - nakrętki sześciokątne o wymiarach powiększonych dla przemysłu petrochemicznego i morskiego

Gatunki

Dla śrub dwustronnych i prętów gwintowanych najpopularniejszym gatunkiem jest Gatunek B7 zgodnie z ASTM A193. Możliwe jest również dostarczenie Gatunku B16 ze stali ferrytycznej, zgodnie z ASTM A193 (dla wyższych temperatur), Gatunku L7 zgodnie z ASTM A320 (dla niższych temperatur) oraz Gatunku B8, B8M i B8T z austenitycznej stali nierdzewnej zgodnie z ASTM A193 (stosowane w bardzo szerokim zakresie temperatur). Dopasowany do nakrętek sześciokątnych o wymiarach powiększonych jest najpopularniejszy Gatunek 2H zgodnie z ASTM A194. Z magazynu może być również dostarczona stal ferrytyczna Gatunek 4 i Gatunek 7 zgodnie z ASTM A194 i austenityczna stal nierdzewna Gatunek B8, B8M i B8T zgodnie z ASTM A194.

Wycofanie Gatunku 4 spodziewane jest w najbliższej przyszłości. Gatunek 7 jest zalecanym zamiennikiem Gatunku 4.

Właściwości mechaniczne

Gatunki B8, B8M i B8T zgodnie z ASTM A193 odpowiadają Klasie 1. Klasa 2 może być dostarczona za żądanie. Podane poniżej właściwości mechaniczne dla ASTM A193 Gatunków B7 i B16, jak również ASTM A320 Gatunek L7, odnoszą się do średnic 2 1/2 cala lub 65 mm.

Zakres temperatury

Zalecana maksymalna temperatura pracy zgodnie z BS 4882: Gatunków B7 i L7 = 400°C / Gatunek B16 = 525°C / Gatunek B8, B8M i B8T = 575°C. Odporna na niskie temperatury stal A320 Gatunek L7 odpowiada minimalnej odporności na uderzenia (udarność) = 20J w temperaturze 101°C (średnio min. 27J).

Certyfikaty

Często przy dostarczaniu śrub dwustronnych i nakrętek sześciokątnych o wymiarach powiększonych wymagany jest certyfikat 3.1 zgodn. z EN 10204 (DIN 50049).

Specjalne

Na żądanie mogą być dostarczone śruby dwustronne i nakrętki sześciokątne o wymiarach powiększonych z obróbką powierzchniową jak cynkowanie, cynkowanie na gorąco, Xylan 1070 (powłoka PTFE), Geomet 500 itd. Na żądanie możliwe jest dostarczenie nawet rzadziej spotykanych materiałów, jak Duplex ASTM A453 Gatunek 660, Monel itd.

4

Śruby dwustronne, pręty gwintowane

Najważniejsze pierwiastki chemiczne									Odpowiadające materiały			
Norma	Gatunek	C	Mn	Cr	Ni	Mo	V	Ti	AISI	AFNOR	DIN	BS
Stal ferrytyczna												
ASTM A193	B7	0,37-0,49	0,65-1,10	0,75-1,20	-	0,15-0,25	-	-	4140/4142/4145	42CD4	42CrMo4	1506-621 Gr A
ASTM A193	B16	0,36-0,47	0,45-0,70	0,80-1,15	-	0,50-0,65	0,25-0,35	-	-	40CDV4-06	24CrMoV55	1506-661
ASTM A320	L7	0,38-0,48	0,75-1,00	0,80-1,10	-	0,15-0,25	-	-	4142/4145	42CD4	42CrMo4	1506-621 Gr A
Austenityczna stal nierdzewna												
ASTM A193	B8	max. 0,08	max. 2,00	18,0-20,0	8,0-10,5	-	-	-	304	Z6CN18-09	X5CrNi18-09	1506-801 Gr B
ASTM A193	B8M	max. 0,08	max. 2,00	16,0-18,0	10,0-14,0	2,0-3,0	-	-	316	Z6CND17-11	X5CrNiMo18-10	1506-845
ASTM A193	B8T	max. 0,08	max. 2,00	17,0-19,0	9,0-12,0	-	-	min. 5 x C%	321	Z6CNT18-11	X10CrNiTi18-09	1506-821 Gr Ti
Właściwości mechaniczne												
Norma	Gatunek	Wytrzymałość na rozciąganie N/mm ²			Granica plastyczności N/mm ²		Min. wydłużenie %		Min. przewężenie %		Twardość HB	
Stal ferrytyczna												
ASTM A193	B7	860			720		16		50		max. 321	
ASTM A193	B16	860			725		18		50		max. 321	
ASTM A320	L7	860			725		16		50		-	
Austenityczna stal nierdzewna												
ASTM A193	B8	515			205		30		50		max. 223	
ASTM A193	B8M	515			205		30		50		max. 223	
ASTM A193	B8T	515			205		30		50		max. 223	

Nakrętki sześciokątne

Najważniejsze pierwiastki chemiczne									Odpowiadające materiały			
Norma	Gatunek	C	Mn	Cr	Ni	Mo	Ti	Twardość HB	AISI	AFNOR	DIN	BS
Stal ferrytyczna												
ASTM A194	2H 4	min. 0,40	max. 1,00	-	-	-	-	248-352	-	C45d	C45	1506-162
ASTM A194	7	0,40-0,50	0,70-0,90	-	-	0,20-0,30	-	248-352	-	-	24CrMo5	1506-240
ASTM A194	-	0,37-0,49	0,65-1,10	0,75-1,20	-	0,15-0,25	-	248-352	4140/4142/4145	42CD4	42CrMo4	1506-621 Gr A
Austenityczna stal nierdzewna												
ASTM A194	8	max. 0,08	max. 2,00	18,0-20,0	8,0-10,5	-	-	126-300	304	Z6CN18-09	X5CrNi18-09	1506-801 Gr B
ASTM A194	8M	max. 0,08	max. 2,00	16,0-18,0	10,0-14,0	2,0-3,0	-	max. 223	316	Z6CND17-11	X5CrNiMo18-10	1506-845
ASTM A194	8T	max. 0,08	max. 2,00	17,0-19,0	9,0-12,0	-	min. 5x C%	126-300	321	Z6CNT18-11	X10CrNiTi18-09	1506-821 Gr Ti

Pręty gwintowane, ASTM metryczna

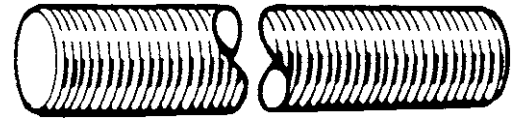
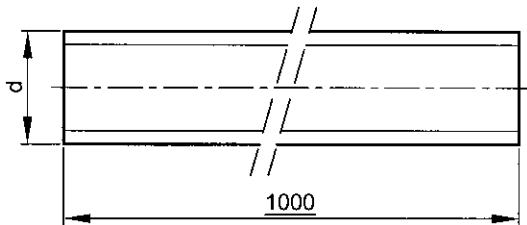

Informacje techniczne

d	P	d	P
M10	1.5	M30	3.5
M12	1.75	M33	3.5
M14	2	M36	4
M16	2	M39	4
M18	2.5	M42	4.5
M20	2.5	M45	4.5
M22	2.5	M48	5
M24	3	M52	5
M27	3		

4

22100 Pręty gwintowane, ASTM metryczna

G09A

Gwint: Metryczny
 Materiał: Stal ASTM A193
 Klasa: Gr.B7



d	☒	Kod artykułu	d	☒	Kod artykułu	d	☒	Kod artykułu
M10	1	22100.100.001	M22	1	22100.220.001	M39	1	22100.390.001
M12	1	22100.120.001	M24	1	22100.240.001	M42	1	22100.420.001
M14	1	22100.140.001	M27	1	22100.270.001	M45	1	22100.450.001
M16	1	22100.160.001	M30	1	22100.300.001	M48	1	22100.480.001
M18	1	22100.180.001	M33	1	22100.330.001	M52	1	22100.520.001
M20	1	22100.200.001	M36	1	22100.360.001			

Śruby dwustronne z dwiema sześciokątnymi nakrętkami, niemetryczne

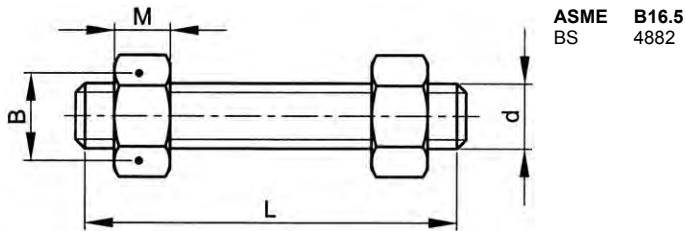

ASME B16.5
BS 4882

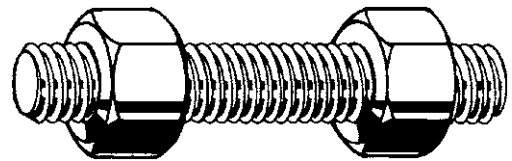

Informacje techniczne

d	B	M	Zwoje gwintu na cal	d	B	M	Zwoje gwintu na cal
3/8	11/16	9	16	1.1/2	2.3/8	37.3	8
1/2	7/8	12.3	13	1.5/8	2.9/16	40.5	8
5/8	1.1/16	15.5	11	1.3/4	2.3/4	43.6	8
3/4	1.1/4	18.7	10	1.7/8	2.15/16	46.8	8
7/8	1.7/16	21.8	9	2 Inch	3.1/8	50.0	8
1 Inch	1.5/8	25.0	8	2.1/4	3.1/2	56.0	8
1.1/8	1.13/16	28.2	8	2.1/2	3.7/8	62.3	8
1.1/4	2.IN.	31.0	8	2.3/4	4.1/4	68.7	8
1.3/8	2.3/16	34.1	8	3 Inch	4.5/8	75.0	8

- Tolerancje całkowitej długości śrub dwustronnych zgodnie z ASTM A 193 paragraf 11.
- L to nominalna długość śruby od pierwszego do ostatniego pełnego gwintu bez faz na obu końcach.

Grupy katalogowe

Gwint	Gniazdo	Materiał	Klasa	Obróbka powierzchni	Kod	Strona
UNC	Sześciokąt	St ASTM A193 - ASTM A194	Gr.B7 - Gr.2H		22080	4-39
UNC	Sześciokąt	St ASTM A193 - ASTM A194	Gr.B7 - Gr.2H	Ocynk.	22082	4-41
8 UN	Sześciokąt	St ASTM A193 - ASTM A194	Gr.B7 - Gr.2H		22090	4-42
UNC	Sześciokąt	St ASTM A320 - ASTM A194	Gr.L7 - Gr.4		22320	4-45
8 UN	Sześciokąt	St ASTM A320 - ASTM A194	Gr.L7 - Gr.4		22330	4-47
UNC	Sześciokąt	St.St. ASTM A193 - ASTM A194	Gr.B8 Cl.1 - Gr.8		22534	4-50
UNC	Sześciokąt	St.St. ASTM A193 - ASTM A194	Gr.B8M Cl.2 - Gr.8M		22538	4-51
UNC	Sześciokąt	St ASTM A193 - ASTM A194	Gr.B16 - Gr.2H		22551	4-53
UNC	Sześciokąt	St ASTM A193 - ASTM A194	Gr.B16 - Gr.4		22554	4-53

22080 Śruby dwustronne z dwiema sześciokątnymi nakrętkami, UNC

G09A

Gwint Calowy, zunifikowany grubozwojny (UNC)
Materiał Stal ASTM A193 - ASTM A194
Klasa Gr.B7 - Gr.2H

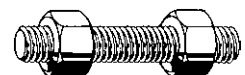

d x L mm (L Inch)	☒	Kod artykułu	d x L mm (L Inch)	☒	Kod artykułu	d x L mm (L Inch)	☒	Kod artykułu
3/8X25 (1)	1	22080.096.025	1/2X140 (5.1/2)	1	22080.127.139	5/8X80 (3.1/4)	1	22080.158.082
3/8X40 (1.1/2)	1	22080.096.038	1/2X145 (5.3/4)	1	22080.127.146	5/8X85 (3.3/8)	1	22080.158.085
3/8X45 (1.3/4)	1	22080.096.044	1/2X150 (6)	1	22080.127.152	5/8X90 (3.1/2)	1	22080.158.088
3/8X60 (2.3/8)	1	22080.096.060	1/2X155 (6.1/8)	1	22080.127.155	5/8X95 (3.3/4)	1	22080.158.095
3/8X95 (3.3/4)	1	22080.096.095	1/2X160 (6.1/4)	1	22080.127.158	5/8X100 (4)	1	22080.158.101
3/8X175 (6.7/8)	1	22080.096.175	1/2X165 (6.1/2)	1	22080.127.165	5/8X105 (4.1/8)	1	22080.158.105
3/8X185 (7.1/4)	1	22080.096.184	1/2X170 (6.3/4)	1	22080.127.171	5/8X110 (4.1/4)	1	22080.158.107
			1/2X175 (6.7/8)	1	22080.127.175	5/8X115 (4.1/2)	1	22080.158.114
1/2X40 (1.1/2)	1	22080.127.038	1/2X180 (7)	1	22080.127.177	5/8X120 (4.3/4)	1	22080.158.120
1/2X45 (1.3/4)	1	22080.127.044	1/2X185 (7.1/4)	1	22080.127.184	5/8X125 (5)	1	22080.158.127
1/2X50 (2)	1	22080.127.050	1/2X190 (7.1/2)	1	22080.127.190	5/8X130 (5.1/8)	1	22080.158.130
1/2X55 (2.1/4)	1	22080.127.057	1/2X195 (7.3/4)	1	22080.127.196	5/8X135 (5.1/4)	1	22080.158.133
1/2X60 (2.3/8)	1	22080.127.060	1/2X200 (8)	1	22080.127.203	5/8X140 (5.1/2)	1	22080.158.139
1/2X65 (2.1/2)	1	22080.127.063	1/2X205 (8.1/8)	1	22080.127.205	5/8X145 (5.3/4)	1	22080.158.146
1/2X70 (2.3/4)	1	22080.127.069	1/2X210 (8.1/4)	1	22080.127.209	5/8X150 (6)	1	22080.158.152
1/2X75 (3)	1	22080.127.076	1/2X225 (8.7/8)	1	22080.127.225	5/8X155 (6.1/8)	1	22080.158.155
1/2X80 (3.1/4)	1	22080.127.082	1/2X250 (9.3/4)	1	22080.127.247	5/8X160 (6.1/4)	1	22080.158.158
1/2X85 (3.3/8)	1	22080.127.085	1/2X280 (11)	1	22080.127.279	5/8X165 (6.1/2)	1	22080.158.165
1/2X90 (3.1/2)	1	22080.127.088				5/8X170 (6.3/4)	1	22080.158.171
1/2X95 (3.3/4)	1	22080.127.095	5/8X40 (1.1/2)	1	22080.158.038	5/8X175 (6.7/8)	1	22080.158.175
1/2X100 (4)	1	22080.127.101	5/8X45 (1.3/4)	1	22080.158.044	5/8X180 (7)	1	22080.158.177
1/2X105 (4.1/8)	1	22080.127.105	5/8X50 (2)	1	22080.158.050	5/8X185 (7.1/4)	1	22080.158.184
1/2X110 (4.1/4)	1	22080.127.107	5/8X55 (2.1/4)	1	22080.158.057	5/8X190 (7.1/2)	1	22080.158.190
1/2X115 (4.1/2)	1	22080.127.114	5/8X60 (2.3/8)	1	22080.158.060	5/8X195 (7.3/4)	1	22080.158.196
1/2X120 (4.3/4)	1	22080.127.120	5/8X65 (2.1/2)	1	22080.158.063	5/8X200 (8)	1	22080.158.203
1/2X125 (5)	1	22080.127.127	5/8X70 (2.3/4)	1	22080.158.069	5/8X205 (8.1/8)	1	22080.158.205
1/2X130 (5.1/8)	1	22080.127.130	5/8X75 (3)	1	22080.158.076	5/8X210 (8.1/4)	1	22080.158.209
1/2X135 (5.1/4)	1	22080.127.133						

22080 Śruby dwustronne z dwiema sześciokątными nakrętkami, UNC

4

d x L mm (L Inch)	☒	Kod artykułu	d x L mm (L Inch)	☒	Kod artykułu	d x L mm (L Inch)	☒	Kod artykułu
5/8X215 (8.1/2)	1	22080.158.215	3/4X310 (12.1/4)	1	22080.191.311	7/8X315 (12.1/2)	1	22080.222.317
5/8X220 (8.3/4)	1	22080.158.222	3/4X315 (12.1/2)	1	22080.191.317	7/8X320 (12.5/8)	1	22080.222.320
5/8X225 (8.7/8)	1	22080.158.225	3/4X320 (12.5/8)	1	22080.191.320	7/8X325 (12.3/4)	1	22080.222.323
5/8X230 (9)	1	22080.158.228	3/4X325 (12.3/4)	1	22080.191.323	7/8X330 (13)	1	22080.222.330
5/8X235 (9.1/4)	1	22080.158.234	3/4X330 (13)	1	22080.191.330	7/8X335 (13.1/4)	1	22080.222.337
5/8X240 (9.1/2)	1	22080.158.241	3/4X335 (13.1/4)	1	22080.191.337	7/8X340 (13.3/8)	1	22080.222.340
5/8X245 (9.5/8)	1	22080.158.245	3/4X340 (13.3/8)	1	22080.191.340	7/8X345 (13.1/2)	1	22080.222.342
5/8X250 (9.3/4)	1	22080.158.247	3/4X345 (13.1/2)	1	22080.191.342	7/8X350 (13.3/4)	1	22080.222.349
5/8X255 (10)	1	22080.158.254	3/4X350 (13.3/4)	1	22080.191.349	7/8X355 (14)	1	22080.222.355
5/8X260 (10.1/4)	1	22080.158.260	3/4X355 (14)	1	22080.191.355	7/8X360 (14.1/4)	1	22080.222.361
5/8X265 (10.1/2)	1	22080.158.266	3/4X360 (14.1/4)	1	22080.191.361	7/8X365 (14.3/8)	1	22080.222.365
5/8X270 (10.5/8)	1	22080.158.270	3/4X365 (14.3/8)	1	22080.191.365	7/8X370 (14.1/2)	1	22080.222.368
5/8X275 (10.3/4)	1	22080.158.273	3/4X370 (14.1/2)	1	22080.191.368	7/8X375 (14.3/4)	1	22080.222.374
5/8X280 (11)	1	22080.158.279	3/4X375 (14.3/4)	1	22080.191.374	7/8X380 (15)	1	22080.222.381
5/8X285 (11.1/4)	1	22080.158.285	3/4X380 (15)	1	22080.191.381	7/8X385 (15.1/4)	1	22080.222.387
5/8X290 (11.3/8)	1	22080.158.290	3/4X385 (15.1/4)	1	22080.191.387	7/8X390 (15.3/8)	1	22080.222.390
5/8X295 (11.1/2)	1	22080.158.292	3/4X390 (15.3/8)	1	22080.191.390	7/8X395 (15.1/2)	1	22080.222.393
5/8X300 (11.3/4)	1	22080.158.298	3/4X395 (15.1/2)	1	22080.191.393	7/8X400 (15.3/4)	1	22080.222.400
5/8X305 (12)	1	22080.158.304	3/4X400 (15.3/4)	1	22080.191.400	7/8X405 (16)	1	22080.222.406
5/8X310 (12.1/4)	1	22080.158.311	3/4X405 (16)	1	22080.191.406	7/8X410 (16.1/8)	1	22080.222.410
5/8X315 (12.1/2)	1	22080.158.317	3/4X410 (16.1/8)	1	22080.191.410	7/8X415 (16.1/4)	1	22080.222.412
5/8X320 (12.5/8)	1	22080.158.320	3/4X415 (16.1/4)	1	22080.191.412	7/8X420 (16.1/2)	1	22080.222.419
5/8X325 (12.3/4)	1	22080.158.323	3/4X420 (16.1/2)	1	22080.191.419	7/8X425 (16.3/4)	1	22080.222.425
5/8X330 (13)	1	22080.158.330	3/4X430 (17)	1	22080.191.431	7/8X430 (17)	1	22080.222.431
5/8X335 (13.1/4)	1	22080.158.336	3/4X440 (17.1/4)	1	22080.191.438	7/8X440 (17.1/4)	1	22080.222.438
5/8X340 (13.3/8)	1	22080.158.340	3/4X450 (17.3/4)	1	22080.191.450	7/8X450 (17.3/4)	1	22080.222.450
5/8X370 (14.1/2)	1	22080.158.368	3/4X455 (18)	1	22080.191.457	7/8X455 (18)	1	22080.222.457
5/8X375 (14.3/4)	1	22080.158.374	3/4X470 (18.1/2)	1	22080.191.469	7/8X470 (18.1/2)	1	22080.222.469
5/8X385 (15.1/4)	1	22080.158.387	3/4X480 (18.7/8)	1	22080.191.480	7/8X485 (19)	1	22080.222.482
			3/4X485 (19)	1	22080.191.482	7/8X495 (19.1/2)	1	22080.222.495
3/4X50 (2)	1	22080.191.050	3/4X580 (22.7/8)	1	22080.191.580	7/8X510 (20)	1	22080.222.508
3/4X55 (2.1/4)	1	22080.191.057	3/4X625 (24.5/8)	1	22080.191.625	7/8X515 (20.1/4)	1	22080.222.514
3/4X60 (2.3/8)	1	22080.191.060				7/8X525 (20.3/4)	1	22080.222.527
3/4X65 (2.1/2)	1	22080.191.063	7/8X70 (2.3/4)	1	22080.222.069			
3/4X70 (2.3/4)	1	22080.191.069	7/8X75 (3)	1	22080.222.076	1.IN.X80 (3.1/4)	1	22080.254.082
3/4X75 (3)	1	22080.191.076	7/8X85 (3.1/4)	1	22080.222.082	1.IN.X85 (3.3/8)	1	22080.254.085
3/4X80 (3.1/4)	1	22080.191.082	7/8X85 (3.3/8)	1	22080.222.085	1.IN.X90 (3.1/2)	1	22080.254.088
3/4X85 (3.3/8)	1	22080.191.085	7/8X90 (3.1/2)	1	22080.222.088	1.IN.X95 (3.3/4)	1	22080.254.095
3/4X90 (3.1/2)	1	22080.191.088	7/8X95 (3.3/4)	1	22080.222.095	1.IN.X100 (4)	1	22080.254.101
3/4X95 (3.3/4)	1	22080.191.095	7/8X100 (4)	1	22080.222.101	1.IN.X105 (4.1/8)	1	22080.254.105
3/4X100 (4)	1	22080.191.101	7/8X105 (4.1/8)	1	22080.222.105	1.IN.X110 (4.1/4)	1	22080.254.107
3/4X105 (4.1/8)	1	22080.191.105	7/8X110 (4.1/4)	1	22080.222.107	1.IN.X115 (4.1/2)	1	22080.254.114
3/4X110 (4.1/4)	1	22080.191.107	7/8X115 (4.1/2)	1	22080.222.114	1.IN.X120 (4.3/4)	1	22080.254.120
3/4X115 (4.1/2)	1	22080.191.114	7/8X120 (4.3/4)	1	22080.222.120	1.IN.X125 (5)	1	22080.254.127
3/4X120 (4.3/4)	1	22080.191.120	7/8X125 (5)	1	22080.222.127	1.IN.X130 (5.1/8)	1	22080.254.130
3/4X125 (5)	1	22080.191.127	7/8X130 (5.1/8)	1	22080.222.130	1.IN.X135 (5.1/4)	1	22080.254.133
3/4X130 (5.1/8)	1	22080.191.130	7/8X135 (5.1/4)	1	22080.222.133	1.IN.X140 (5.1/2)	1	22080.254.139
3/4X135 (5.1/4)	1	22080.191.133	7/8X140 (5.1/2)	1	22080.222.139	1.IN.X145 (5.3/4)	1	22080.254.146
3/4X140 (5.1/2)	1	22080.191.139	7/8X145 (5.3/4)	1	22080.222.146	1.IN.X150 (6)	1	22080.254.152
3/4X145 (5.3/4)	1	22080.191.146	7/8X150 (6)	1	22080.222.152	1.IN.X155 (6.1/8)	1	22080.254.155
3/4X150 (6)	1	22080.191.152	7/8X155 (6.1/8)	1	22080.222.155	1.IN.X160 (6.1/4)	1	22080.254.158
3/4X155 (6.1/8)	1	22080.191.155	7/8X160 (6.1/4)	1	22080.222.158	1.IN.X165 (6.1/2)	1	22080.254.165
3/4X160 (6.1/4)	1	22080.191.158	7/8X165 (6.1/2)	1	22080.222.165	1.IN.X170 (6.3/4)	1	22080.254.171
3/4X165 (6.1/2)	1	22080.191.165	7/8X170 (6.3/4)	1	22080.222.171	1.IN.X175 (6.7/8)	1	22080.254.175
3/4X170 (6.3/4)	1	22080.191.171	7/8X175 (6.7/8)	1	22080.222.175	1.IN.X180 (7)	1	22080.254.177
3/4X175 (6.7/8)	1	22080.191.175	7/8X180 (7)	1	22080.222.177	1.IN.X185 (7.1/4)	1	22080.254.184
3/4X180 (7)	1	22080.191.177	7/8X185 (7.1/4)	1	22080.222.184	1.IN.X190 (7.1/2)	1	22080.254.190
3/4X185 (7.1/4)	1	22080.191.184	7/8X190 (7.1/2)	1	22080.222.190	1.IN.X195 (7.3/4)	1	22080.254.196
3/4X190 (7.1/2)	1	22080.191.190	7/8X195 (7.3/4)	1	22080.222.196	1.IN.X200 (8)	1	22080.254.203
3/4X195 (7.3/4)	1	22080.191.196	7/8X200 (8)	1	22080.222.203	1.IN.X205 (8.1/8)	1	22080.254.205
3/4X200 (8)	1	22080.191.203	7/8X205 (8.1/8)	1	22080.222.205	1.IN.X210 (8.1/4)	1	22080.254.209
3/4X205 (8.1/8)	1	22080.191.205	7/8X210 (8.1/4)	1	22080.222.209	1.IN.X215 (8.1/2)	1	22080.254.215
3/4X210 (8.1/4)	1	22080.191.209	7/8X215 (8.1/2)	1	22080.222.215	1.IN.X220 (8.3/4)	1	22080.254.222
3/4X215 (8.1/2)	1	22080.191.215	7/8X220 (8.3/4)	1	22080.222.222	1.IN.X225 (8.7/8)	1	22080.254.225
3/4X220 (8.3/4)	1	22080.191.222	7/8X225 (8.7/8)	1	22080.222.225	1.IN.X230 (9)	1	22080.254.228
3/4X225 (8.7/8)	1	22080.191.225	7/8X230 (9)	1	22080.222.228	1.IN.X235 (9.1/4)	1	22080.254.234
3/4X230 (9)	1	22080.191.228	7/8X235 (9.1/4)	1	22080.222.234	1.IN.X240 (9.1/2)	1	22080.254.241
3/4X235 (9.1/4)	1	22080.191.234	7/8X240 (9.1/2)	1	22080.222.241	1.IN.X245 (9.5/8)	1	22080.254.245
3/4X240 (9.1/2)	1	22080.191.241	7/8X245 (9.5/8)	1	22080.222.245	1.IN.X250 (9.3/4)	1	22080.254.247
3/4X245 (9.5/8)	1	22080.191.245	7/8X250 (9.3/4)	1	22080.222.247	1.IN.X255 (10)	1	22080.254.254
3/4X250 (9.3/4)	1	22080.191.247	7/8X255 (10)	1	22080.222.254	1.IN.X260 (10.1/4)	1	22080.254.260
3/4X255 (10)	1	22080.191.254	7/8X260 (10.1/4)	1	22080.222.260	1.IN.X265 (10.1/2)	1	22080.254.266
3/4X260 (10.1/4)	1	22080.191.260	7/8X265 (10.1/2)	1	22080.222.266	1.IN.X270 (10.5/8)	1	22080.254.270
3/4X265 (10.1/2)	1	22080.191.266	7/8X270 (10.5/8)	1	22080.222.270	1.IN.X275 (10.3/4)	1	22080.254.273
3/4X270 (10.5/8)	1	22080.191.270	7/8X275 (10.3/4)	1	22080.222.273	1.IN.X280 (11)	1	22080.254.279
3/4X275 (10.3/4)	1	22080.191.273	7/8X280 (11)	1	22080.222.279	1.IN.X285 (11.1/4)	1	22080.254.285
3/4X280 (11)	1	22080.191.279	7/8X285 (11.1/4)	1	22080.222.285	1.IN.X290 (11.3/8)	1	22080.254.290
3/4X285 (11.1/4)	1	22080.191.285	7/8X290 (11.3/8)	1	22080.222.290	1.IN.X295 (11.1/2)	1	22080.254.292
3/4X290 (11.3/8)	1	22080.191.290	7/8X295 (11.1/2)	1	22080.222.292	1.IN.X300 (11.3/4)	1	22080.254.298
3/4X295 (11.1/2)	1	22080.191.292	7/8X300 (11.3/4)	1	22080.222.298	1.IN.X305 (12)	1	22080.254.304
3/4X300 (11.3/4)	1	22080.191.298	7/8X305 (12)	1	22080.222.304	1.IN.X310 (12.1/4)	1	22080.254.311
3/4X305 (12)	1	22080.191.304	7/8X310 (12.1/4)	1	22080.222.311	1.IN.X315 (12.1/2)	1	22080.254.317

22080 Śruby dwustronne z dwiema sześciokątnymi nakrętkami, UNC								
d x L mm (L Inch)	☒	Kod artykułu	d x L mm (L Inch)	☒	Kod artykułu	d x L mm (L Inch)	☒	Kod artykułu
1.IN.X320 (12.5/8)	1	22080.254.320	1.IN.X380 (15)	1	22080.254.381	1.IN.X445 (17.1/2)	1	22080.254.444
1.IN.X325 (12.3/4)	1	22080.254.323	1.IN.X385 (15.1/4)	1	22080.254.387	1.IN.X450 (17.3/4)	1	22080.254.450
1.IN.X330 (13)	1	22080.254.330	1.IN.X390 (15.3/8)	1	22080.254.390	1.IN.X455 (18)	1	22080.254.457
1.IN.X335 (13.1/4)	1	22080.254.337	1.IN.X395 (15.1/2)	1	22080.254.393	1.IN.X460 (18.1/8)	1	22080.254.460
1.IN.X340 (13.3/8)	1	22080.254.340	1.IN.X400 (15.3/4)	1	22080.254.400	1.IN.X470 (18.1/2)	1	22080.254.469
1.IN.X345 (13.1/2)	1	22080.254.342	1.IN.X410 (16.1/8)	1	22080.254.410	1.IN.X485 (19)	1	22080.254.482
1.IN.X350 (13.3/4)	1	22080.254.349	1.IN.X415 (16.1/4)	1	22080.254.412	1.IN.X505 (19.7/8)	1	22080.254.505
1.IN.X355 (14)	1	22080.254.355	1.IN.X420 (16.1/2)	1	22080.254.419	1.IN.X515 (20.1/4)	1	22080.254.514
1.IN.X360 (14.1/4)	1	22080.254.361	1.IN.X425 (16.3/4)	1	22080.254.425	1.IN.X520 (20.1/2)	1	22080.254.520
1.IN.X365 (14.3/8)	1	22080.254.365	1.IN.X430 (17)	1	22080.254.431	1.IN.X595 (23.1/2)	1	22080.254.596
1.IN.X370 (14.1/2)	1	22080.254.368	1.IN.X435 (17.1/8)	1	22080.254.435	1.IN.X730 (28.3/4)	1	22080.254.730
1.IN.X375 (14.3/4)	1	22080.254.374	1.IN.X440 (17.1/4)	1	22080.254.438			

22082 Śruby dwustronne z dwiema sześciokątnymi nakrętkami, niemetryczne		G09A
Gwint	Całowy, zunifikowany grubozwojny (UNC)	
Materiał	Stal ASTM A193 - ASTM A194	
Klasa	Gr.B7 - Gr.2H	
Obrobka powierzchni	Ocynkowane	

d x L mm (L Inch)	☒	Kod artykułu	d x L mm (L Inch)	☒	Kod artykułu	d x L mm (L Inch)	☒	Kod artykułu
3/8X25 (1)	1	22082.096.025	5/8X70 (2.3/4)	1	22082.158.069	3/4X50 (2)	1	22082.191.050
3/8X40 (1.1/2)	1	22082.096.038	5/8X75 (3)	1	22082.158.076	3/4X55 (2.1/4)	1	22082.191.057
3/8X45 (1.3/4)	1	22082.096.044	5/8X80 (3.1/4)	1	22082.158.082	3/4X60 (2.3/8)	1	22082.191.060
3/8X60 (2.3/8)	1	22082.096.060	5/8X85 (3.3/8)	1	22082.158.085	3/4X65 (2.1/2)	1	22082.191.063
3/8X65 (2.1/2)	1	22082.096.063	5/8X90 (3.1/2)	1	22082.158.088	3/4X70 (2.3/4)	1	22082.191.069
3/8X70 (2.3/4)	1	22082.096.069	5/8X95 (3.3/4)	1	22082.158.095	3/4X75 (3)	1	22082.191.076
3/8X80 (3.1/4)	1	22082.096.082	5/8X100 (4)	1	22082.158.101	3/4X80 (3.1/4)	1	22082.191.082
3/8X95 (3.3/4)	1	22082.096.095	5/8X105 (4.1/8)	1	22082.158.105	3/4X85 (3.3/8)	1	22082.191.085
3/8X100 (4)	1	22082.096.101	5/8X110 (4.1/4)	1	22082.158.107	3/4X90 (3.1/2)	1	22082.191.088
3/8X175 (6.7/8)	1	22082.096.175	5/8X115 (4.1/2)	1	22082.158.114	3/4X95 (3.3/4)	1	22082.191.095
3/8X185 (7.1/4)	1	22082.096.184	5/8X120 (4.3/4)	1	22082.158.120	3/4X100 (4)	1	22082.191.101
			5/8X125 (5)	1	22082.158.127	3/4X105 (4.1/8)	1	22082.191.105
1/2X30 (1.1/4)	1	22082.127.031	5/8X130 (5.1/8)	1	22082.158.130	3/4X110 (4.1/4)	1	22082.191.107
1/2X40 (1.1/2)	1	22082.127.038	5/8X135 (5.1/4)	1	22082.158.133	3/4X115 (4.1/2)	1	22082.191.114
1/2X45 (1.3/4)	1	22082.127.044	5/8X140 (5.1/2)	1	22082.158.139	3/4X120 (4.3/4)	1	22082.191.120
1/2X50 (2)	1	22082.127.050	5/8X145 (5.3/4)	1	22082.158.146	3/4X125 (5)	1	22082.191.127
1/2X55 (2.1/4)	1	22082.127.057	5/8X150 (6)	1	22082.158.152	3/4X130 (5.1/8)	1	22082.191.130
1/2X60 (2.3/8)	1	22082.127.060	5/8X155 (6.1/8)	1	22082.158.155	3/4X135 (5.1/4)	1	22082.191.133
1/2X65 (2.1/2)	1	22082.127.063	5/8X160 (6.1/4)	1	22082.158.158	3/4X140 (5.1/2)	1	22082.191.139
1/2X70 (2.3/4)	1	22082.127.069	5/8X165 (6.1/2)	1	22082.158.165	3/4X145 (5.3/4)	1	22082.191.146
1/2X75 (3)	1	22082.127.076	5/8X170 (6.3/4)	1	22082.158.171	3/4X150 (6)	1	22082.191.152
1/2X80 (3.1/4)	1	22082.127.082	5/8X175 (6.7/8)	1	22082.158.175	3/4X155 (6.1/8)	1	22082.191.155
1/2X85 (3.3/8)	1	22082.127.085	5/8X180 (7)	1	22082.158.177	3/4X160 (6.1/4)	1	22082.191.158
1/2X90 (3.1/2)	1	22082.127.088	5/8X185 (7.1/4)	1	22082.158.184	3/4X165 (6.1/2)	1	22082.191.165
1/2X95 (3.3/4)	1	22082.127.095	5/8X190 (7.1/2)	1	22082.158.190	3/4X170 (6.3/4)	1	22082.191.171
1/2X100 (4)	1	22082.127.101	5/8X195 (7.3/4)	1	22082.158.196	3/4X175 (6.7/8)	1	22082.191.175
1/2X105 (4.1/8)	1	22082.127.105	5/8X200 (8)	1	22082.158.203	3/4X180 (7)	1	22082.191.177
1/2X110 (4.1/4)	1	22082.127.107	5/8X205 (8.1/8)	1	22082.158.205	3/4X185 (7.1/4)	1	22082.191.184
1/2X115 (4.1/2)	1	22082.127.114	5/8X210 (8.1/4)	1	22082.158.209	3/4X190 (7.1/2)	1	22082.191.190
1/2X120 (4.3/4)	1	22082.127.120	5/8X215 (8.1/2)	1	22082.158.215	3/4X195 (7.3/4)	1	22082.191.196
1/2X125 (5)	1	22082.127.127	5/8X220 (8.3/4)	1	22082.158.222	3/4X200 (8)	1	22082.191.203
1/2X130 (5.1/8)	1	22082.127.130	5/8X225 (8.7/8)	1	22082.158.225	3/4X205 (8.1/8)	1	22082.191.205
1/2X135 (5.1/4)	1	22082.127.133	5/8X230 (9)	1	22082.158.228	3/4X210 (8.1/4)	1	22082.191.209
1/2X140 (5.1/2)	1	22082.127.139	5/8X235 (9.1/4)	1	22082.158.234	3/4X215 (8.1/2)	1	22082.191.215
1/2X145 (5.3/4)	1	22082.127.146	5/8X240 (9.1/2)	1	22082.158.241	3/4X220 (8.3/4)	1	22082.191.222
1/2X150 (6)	1	22082.127.152	5/8X245 (9.5/8)	1	22082.158.245	3/4X225 (8.7/8)	1	22082.191.225
1/2X155 (6.1/8)	1	22082.127.155	5/8X250 (9.3/4)	1	22082.158.247	3/4X230 (9)	1	22082.191.228
1/2X160 (6.1/4)	1	22082.127.158	5/8X255 (10)	1	22082.158.254	3/4X235 (9.1/4)	1	22082.191.234
1/2X165 (6.1/2)	1	22082.127.165	5/8X260 (10.1/4)	1	22082.158.260	3/4X240 (9.1/2)	1	22082.191.241
1/2X170 (6.3/4)	1	22082.127.171	5/8X265 (10.1/2)	1	22082.158.266	3/4X245 (9.5/8)	1	22082.191.245
1/2X175 (6.7/8)	1	22082.127.175	5/8X270 (10.5/8)	1	22082.158.270	3/4X250 (9.3/4)	1	22082.191.247
1/2X180 (7)	1	22082.127.177	5/8X275 (10.3/4)	1	22082.158.273	3/4X255 (10)	1	22082.191.254
1/2X185 (7.1/4)	1	22082.127.184	5/8X280 (11)	1	22082.158.279	3/4X260 (10.1/4)	1	22082.191.260
1/2X190 (7.1/2)	1	22082.127.190	5/8X285 (11.1/4)	1	22082.158.285	3/4X265 (10.1/2)	1	22082.191.266
1/2X195 (7.3/4)	1	22082.127.196	5/8X290 (11.3/8)	1	22082.158.290	3/4X270 (10.5/8)	1	22082.191.270
1/2X200 (8)	1	22082.127.203	5/8X295 (11.1/2)	1	22082.158.292	3/4X275 (10.3/4)	1	22082.191.273
1/2X205 (8.1/8)	1	22082.127.205	5/8X300 (11.3/4)	1	22082.158.298	3/4X280 (11)	1	22082.191.279
1/2X210 (8.1/4)	1	22082.127.209	5/8X305 (12)	1	22082.158.304	3/4X285 (11.1/4)	1	22082.191.285
1/2X225 (8.7/8)	1	22082.127.225	5/8X310 (12.1/4)	1	22082.158.311	3/4X290 (11.3/8)	1	22082.191.290
1/2X250 (9.3/4)	1	22082.127.247	5/8X315 (12.1/2)	1	22082.158.317	3/4X295 (11.1/2)	1	22082.191.292
1/2X280 (11)	1	22082.127.279	5/8X320 (12.5/8)	1	22082.158.320	3/4X300 (11.3/4)	1	22082.191.298
			5/8X325 (12.3/4)	1	22082.158.323	3/4X305 (12)	1	22082.191.304
5/8X40 (1.1/2)	1	22082.158.038	5/8X330 (13)	1	22082.158.330	3/4X310 (12.1/4)	1	22082.191.311
5/8X45 (1.3/4)	1	22082.158.044	5/8X335 (13.1/4)	1	22082.158.337	3/4X315 (12.1/2)	1	22082.191.317
5/8X50 (2)	1	22082.158.050	5/8X340 (13.3/8)	1	22082.158.340	3/4X320 (12.3/8)	1	22082.191.320
5/8X55 (2.1/4)	1	22082.158.057	5/8X370 (14.1/2)	1	22082.158.368	3/4X325 (12.3/4)	1	22082.191.323
5/8X60 (2.3/8)	1	22082.158.060	5/8X375 (14.3/4)	1	22082.158.374	3/4X330 (13)	1	22082.191.330
5/8X65 (2.1/2)	1	22082.158.063						

22082 Śruby dwustronne z dwiema sześciokątnymi nakrętkami, niemetryczne

d x L mm (L Inch)	☒	Kod artykułu	d x L mm (L Inch)	☒	Kod artykułu	d x L mm (L Inch)	☒	Kod artykułu
3/4X335 (13.1/4)	1	22082.191.337	7/8X255 (10)	1	22082.222.254	1.IN.X180 (7)	1	22082.254.177
3/4X340 (13.3/8)	1	22082.191.340	7/8X260 (10.1/4)	1	22082.222.260	1.IN.X185 (7.1/4)	1	22082.254.184
3/4X345 (13.1/2)	1	22082.191.342	7/8X265 (10.1/2)	1	22082.222.266	1.IN.X190 (7.1/2)	1	22082.254.190
3/4X350 (13.3/4)	1	22082.191.349	7/8X270 (10.5/8)	1	22082.222.270	1.IN.X195 (7.3/4)	1	22082.254.196
3/4X355 (14)	1	22082.191.355	7/8X275 (10.3/4)	1	22082.222.273	1.IN.X200 (8)	1	22082.254.203
3/4X360 (14.1/4)	1	22082.191.361	7/8X280 (11)	1	22082.222.279	1.IN.X205 (8.1/8)	1	22082.254.205
3/4X365 (14.3/8)	1	22082.191.365	7/8X285 (11.1/4)	1	22082.222.285	1.IN.X210 (8.1/4)	1	22082.254.209
3/4X370 (14.1/2)	1	22082.191.368	7/8X290 (11.3/8)	1	22082.222.290	1.IN.X215 (8.1/2)	1	22082.254.215
3/4X375 (14.3/4)	1	22082.191.374	7/8X295 (11.1/2)	1	22082.222.292	1.IN.X220 (8.3/4)	1	22082.254.222
3/4X380 (15)	1	22082.191.381	7/8X300 (11.3/4)	1	22082.222.298	1.IN.X225 (8.7/8)	1	22082.254.225
3/4X385 (15.1/4)	1	22082.191.387	7/8X305 (12)	1	22082.222.304	1.IN.X230 (9)	1	22082.254.228
3/4X390 (15.3/8)	1	22082.191.390	7/8X310 (12.1/4)	1	22082.222.311	1.IN.X235 (9.1/4)	1	22082.254.234
3/4X395 (15.1/2)	1	22082.191.393	7/8X315 (12.1/2)	1	22082.222.317	1.IN.X240 (9.1/2)	1	22082.254.241
3/4X400 (15.3/4)	1	22082.191.400	7/8X320 (12.5/8)	1	22082.222.320	1.IN.X245 (9.5/8)	1	22082.254.245
3/4X405 (16)	1	22082.191.406	7/8X325 (12.3/4)	1	22082.222.323	1.IN.X250 (9.3/4)	1	22082.254.247
3/4X410 (16.1/8)	1	22082.191.410	7/8X330 (13)	1	22082.222.330	1.IN.X255 (10)	1	22082.254.254
3/4X415 (16.1/4)	1	22082.191.412	7/8X335 (13.1/4)	1	22082.222.337	1.IN.X260 (10.1/4)	1	22082.254.260
3/4X420 (16.1/2)	1	22082.191.419	7/8X340 (13.3/8)	1	22082.222.340	1.IN.X265 (10.1/2)	1	22082.254.266
3/4X430 (17)	1	22082.191.431	7/8X345 (13.1/2)	1	22082.222.342	1.IN.X270 (10.5/8)	1	22082.254.270
3/4X440 (17.1/4)	1	22082.191.438	7/8X350 (13.3/4)	1	22082.222.349	1.IN.X275 (10.3/4)	1	22082.254.273
3/4X450 (17.3/4)	1	22082.191.450	7/8X355 (14)	1	22082.222.355	1.IN.X280 (11)	1	22082.254.279
3/4X455 (18)	1	22082.191.457	7/8X360 (14.1/4)	1	22082.222.361	1.IN.X285 (11.1/4)	1	22082.254.285
3/4X470 (18.1/2)	1	22082.191.469	7/8X365 (14.3/8)	1	22082.222.365	1.IN.X290 (11.3/8)	1	22082.254.290
3/4X480 (18.7/8)	1	22082.191.480	7/8X370 (14.1/2)	1	22082.222.368	1.IN.X295 (11.1/2)	1	22082.254.292
3/4X485 (19)	1	22082.191.482	7/8X375 (14.3/4)	1	22082.222.375	1.IN.X300 (11.3/4)	1	22082.254.298
3/4X580 (22.7/8)	1	22082.191.580	7/8X380 (15)	1	22082.222.381	1.IN.X305 (12)	1	22082.254.304
3/4X625 (24.5/8)	1	22082.191.625	7/8X385 (15.1/4)	1	22082.222.382	1.IN.X310 (12.1/4)	1	22082.254.311
7/8X70 (2.3/4)	1	22082.222.069	7/8X390 (15.3/8)	1	22082.222.390	1.IN.X315 (12.1/2)	1	22082.254.317
7/8X75 (3)	1	22082.222.076	7/8X395 (15.1/2)	1	22082.222.393	1.IN.X320 (12.5/8)	1	22082.254.320
7/8X80 (3.1/4)	1	22082.222.082	7/8X400 (15.3/4)	1	22082.222.400	1.IN.X325 (12.3/4)	1	22082.254.323
7/8X85 (3.3/8)	1	22082.222.085	7/8X405 (16)	1	22082.222.406	1.IN.X330 (13)	1	22082.254.330
7/8X90 (3.1/2)	1	22082.222.088	7/8X410 (16.1/8)	1	22082.222.410	1.IN.X335 (13.1/4)	1	22082.254.337
7/8X95 (3.3/4)	1	22082.222.095	7/8X415 (16.1/4)	1	22082.222.412	1.IN.X340 (13.3/8)	1	22082.254.340
7/8X100 (4)	1	22082.222.101	7/8X420 (16.1/2)	1	22082.222.419	1.IN.X345 (13.1/2)	1	22082.254.342
7/8X105 (4.1/8)	1	22082.222.105	7/8X425 (16.3/4)	1	22082.222.425	1.IN.X350 (13.3/4)	1	22082.254.349
7/8X110 (4.1/4)	1	22082.222.107	7/8X430 (17)	1	22082.222.431	1.IN.X355 (14)	1	22082.254.355
7/8X115 (4.1/2)	1	22082.222.114	7/8X440 (17.1/4)	1	22082.222.438	1.IN.X360 (14.1/4)	1	22082.254.361
7/8X120 (4.3/4)	1	22082.222.120	7/8X450 (17.3/4)	1	22082.222.450	1.IN.X365 (14.3/8)	1	22082.254.365
7/8X125 (5)	1	22082.222.127	7/8X455 (18)	1	22082.222.457	1.IN.X370 (14.1/2)	1	22082.254.368
7/8X130 (5.1/8)	1	22082.222.130	7/8X470 (18.1/2)	1	22082.222.469	1.IN.X375 (14.3/4)	1	22082.254.374
7/8X135 (5.1/4)	1	22082.222.133	7/8X485 (19)	1	22082.222.482	1.IN.X380 (15)	1	22082.254.381
7/8X140 (5.1/2)	1	22082.222.139	7/8X495 (19.1/2)	1	22082.222.495	1.IN.X385 (15.1/4)	1	22082.254.387
7/8X145 (5.3/4)	1	22082.222.146	7/8X510 (20)	1	22082.222.508	1.IN.X390 (15.3/8)	1	22082.254.390
7/8X150 (6)	1	22082.222.152	7/8X515 (20.1/4)	1	22082.222.514	1.IN.X395 (15.1/2)	1	22082.254.393
7/8X155 (6.1/8)	1	22082.222.155	7/8X525 (20.3/4)	1	22082.222.527	1.IN.X400 (15.3/4)	1	22082.254.400
7/8X160 (6.1/4)	1	22082.222.158	1.IN.X80 (3.1/4)	1	22082.254.082	1.IN.X405 (16)	1	22082.254.406
7/8X165 (6.1/2)	1	22082.222.165	1.IN.X85 (3.3/8)	1	22082.254.085	1.IN.X410 (16.1/8)	1	22082.254.410
7/8X170 (6.3/4)	1	22082.222.171	1.IN.X90 (3.1/2)	1	22082.254.088	1.IN.X415 (16.1/4)	1	22082.254.412
7/8X175 (6.7/8)	1	22082.222.175	1.IN.X95 (3.3/4)	1	22082.254.095	1.IN.X420 (16.1/2)	1	22082.254.419
7/8X180 (7)	1	22082.222.177	1.IN.X100 (4)	1	22082.254.101	1.IN.X425 (16.3/4)	1	22082.254.425
7/8X185 (7.1/4)	1	22082.222.184	1.IN.X105 (4.1/8)	1	22082.254.105	1.IN.X430 (17)	1	22082.254.431
7/8X190 (7.1/2)	1	22082.222.190	1.IN.X110 (4.1/4)	1	22082.254.107	1.IN.X435 (17.1/8)	1	22082.254.435
7/8X195 (7.3/4)	1	22082.222.196	1.IN.X115 (4.1/2)	1	22082.254.114	1.IN.X440 (17.1/4)	1	22082.254.438
7/8X200 (8)	1	22082.222.203	1.IN.X120 (4.3/4)	1	22082.254.120	1.IN.X445 (17.1/2)	1	22082.254.444
7/8X205 (8.1/8)	1	22082.222.205	1.IN.X125 (5)	1	22082.254.127	1.IN.X450 (17.3/4)	1	22082.254.450
7/8X210 (8.1/4)	1	22082.222.209	1.IN.X130 (5.1/8)	1	22082.254.130	1.IN.X455 (18)	1	22082.254.457
7/8X215 (8.1/2)	1	22082.222.215	1.IN.X135 (5.1/4)	1	22082.254.133	1.IN.X460 (18.1/8)	1	22082.254.460
7/8X220 (8.3/4)	1	22082.222.222	1.IN.X140 (5.1/2)	1	22082.254.139	1.IN.X470 (18.1/2)	1	22082.254.469
7/8X225 (8.7/8)	1	22082.222.225	1.IN.X145 (5.3/4)	1	22082.254.146	1.IN.X485 (19)	1	22082.254.482
7/8X230 (9)	1	22082.222.228	1.IN.X150 (6)	1	22082.254.152	1.IN.X505 (19.7/8)	1	22082.254.505
7/8X235 (9.1/4)	1	22082.222.234	1.IN.X155 (6.1/8)	1	22082.254.155	1.IN.X515 (20.1/4)	1	22082.254.514
7/8X240 (9.1/2)	1	22082.222.241	1.IN.X160 (6.1/4)	1	22082.254.158	1.IN.X520 (20.1/2)	1	22082.254.520
7/8X245 (9.5/8)	1	22082.222.245	1.IN.X165 (6.1/2)	1	22082.254.165	1.IN.X595 (23.1/2)	1	22082.254.596
7/8X250 (9.3/4)	1	22082.222.247	1.IN.X175 (6.7/8)	1	22082.254.175	1.IN.X730 (28.3/4)	1	22082.254.730

22090 Śruby dwustronne z dwiema sześciokątnymi nakrętkami, 8UN
G09A

Gwint 8 UN amerykański
Materiał Stal ASTM A193 - ASTM A194
Klasa Gr.B7 - Gr.2H

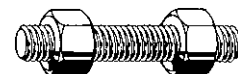

d x L mm (L Inch)	☒	Kod artykułu	d x L mm (L Inch)	☒	Kod artykułu	d x L mm (L Inch)	☒	Kod artykułu
1.1/8X100 (4)	1	22090.285.101	1.1/8X125 (5)	1	22090.285.127	1.1/8X150 (6)	1	22090.285.152
1.1/8X105 (4.1/8)	1	22090.285.105	1.1/8X130 (5.1/8)	1	22090.285.130	1.1/8X155 (6.1/8)	1	22090.285.155
1.1/8X110 (4.1/4)	1	22090.285.107	1.1/8X135 (5.1/4)	1	22090.285.133	1.1/8X160 (6.1/4)	1	22090.285.158
1.1/8X115 (4.1/2)	1	22090.285.114	1.1/8X140 (5.1/2)	1	22090.285.139	1.1/8X165 (6.1/2)	1	22090.285.165
1.1/8X120 (4.3/4)	1	22090.285.120	1.1/8X145 (5.3/4)	1	22090.285.146	1.1/8X170 (6.3/4)	1	22090.285.171

22090 Śruby dwustronne z dwiema sześciokątnymi nakrętkami, 8UN

d x L mm (L Inch)	Kod artykułu	d x L mm (L Inch)	Kod artykułu	d x L mm (L Inch)	Kod artykułu
1.1/8X175 (6.7/8)	22090.285.175	1.1/4X100 (4)	22090.317.101	1.1/4X520 (20.1/2)	22090.317.520
1.1/8X180 (7)	22090.285.177	1.1/4X105 (4.1/8)	22090.317.105	1.1/4X530 (20.7/8)	22090.317.530
1.1/8X185 (7.1/4)	22090.285.184	1.1/4X110 (4.1/4)	22090.317.107	1.1/4X540 (21.1/4)	22090.317.539
1.1/8X190 (7.1/2)	22090.285.190	1.1/4X115 (4.1/2)	22090.317.114	1.1/4X550 (21.5/8)	22090.317.550
1.1/8X195 (7.3/4)	22090.285.196	1.1/4X120 (4.3/4)	22090.317.120	1.1/4X560 (22)	22090.317.558
1.1/8X200 (8)	22090.285.203	1.1/4X125 (5)	22090.317.127	1.1/4X600 (23.5/8)	22090.317.600
1.1/8X205 (8.1/8)	22090.285.205	1.1/4X130 (5.1/8)	22090.317.130	1.1/4X610 (24)	22090.317.609
1.1/8X210 (8.1/4)	22090.285.209	1.1/4X135 (5.1/4)	22090.317.133	1.1/4X630 (24.3/4)	22090.317.628
1.1/8X215 (8.1/2)	22090.285.215	1.1/4X140 (5.1/2)	22090.317.139	1.1/4X650 (25.5/8)	22090.317.650
1.1/8X220 (8.3/4)	22090.285.222	1.1/4X145 (5.3/4)	22090.317.146	1.1/4X665 (26.1/4)	22090.317.666
1.1/8X225 (8.7/8)	22090.285.225	1.1/4X150 (6)	22090.317.152	1.1/4X690 (27.1/8)	22090.317.690
1.1/8X230 (9)	22090.285.228	1.1/4X155 (6.1/8)	22090.317.155	1.1/4X700 (27.1/2)	22090.317.698
1.1/8X235 (9.1/4)	22090.285.234	1.1/4X160 (6.1/4)	22090.317.158		
1.1/8X240 (9.1/2)	22090.285.241	1.1/4X165 (6.1/2)	22090.317.165	1.3/8X150 (6)	22090.349.152
1.1/8X245 (9.5/8)	22090.285.245	1.1/4X170 (6.3/4)	22090.317.171	1.3/8X155 (6.1/8)	22090.349.155
1.1/8X250 (9.3/4)	22090.285.247	1.1/4X175 (6.7/8)	22090.317.175	1.3/8X160 (6.1/4)	22090.349.158
1.1/8X255 (10)	22090.285.254	1.1/4X180 (7)	22090.317.177	1.3/8X165 (6.1/2)	22090.349.165
1.1/8X260 (10.1/4)	22090.285.260	1.1/4X185 (7.1/4)	22090.317.184	1.3/8X170 (6.3/4)	22090.349.171
1.1/8X265 (10.1/2)	22090.285.266	1.1/4X190 (7.1/2)	22090.317.190	1.3/8X175 (6.7/8)	22090.349.175
1.1/8X270 (10.5/8)	22090.285.270	1.1/4X195 (7.3/4)	22090.317.196	1.3/8X180 (7)	22090.349.177
1.1/8X275 (10.3/4)	22090.285.273	1.1/4X200 (8)	22090.317.203	1.3/8X185 (7.1/4)	22090.349.184
1.1/8X280 (11)	22090.285.279	1.1/4X205 (8.1/8)	22090.317.205	1.3/8X190 (7.1/2)	22090.349.190
1.1/8X285 (11.1/4)	22090.285.285	1.1/4X210 (8.1/4)	22090.317.209	1.3/8X195 (7.3/4)	22090.349.196
1.1/8X290 (11.3/8)	22090.285.290	1.1/4X215 (8.1/2)	22090.317.215	1.3/8X200 (8)	22090.349.203
1.1/8X295 (11.1/2)	22090.285.292	1.1/4X220 (8.3/4)	22090.317.222	1.3/8X205 (8.1/8)	22090.349.205
1.1/8X300 (11.3/4)	22090.285.298	1.1/4X225 (8.7/8)	22090.317.225	1.3/8X210 (8.1/4)	22090.349.209
1.1/8X305 (12)	22090.285.304	1.1/4X230 (9)	22090.317.228	1.3/8X215 (8.1/2)	22090.349.215
1.1/8X310 (12.1/4)	22090.285.311	1.1/4X235 (9.1/4)	22090.317.234	1.3/8X220 (8.3/4)	22090.349.222
1.1/8X315 (12.1/2)	22090.285.317	1.1/4X240 (9.1/2)	22090.317.241	1.3/8X225 (8.7/8)	22090.349.225
1.1/8X320 (12.5/8)	22090.285.320	1.1/4X245 (9.5/8)	22090.317.245	1.3/8X230 (9)	22090.349.228
1.1/8X325 (12.3/4)	22090.285.323	1.1/4X250 (9.3/4)	22090.317.247	1.3/8X235 (9.1/4)	22090.349.234
1.1/8X325 (12.3/4)	22090.285.326	1.1/4X255 (10)	22090.317.254	1.3/8X240 (9.1/2)	22090.349.241
1.1/8X330 (13)	22090.285.330	1.1/4X260 (10.1/4)	22090.317.260	1.3/8X245 (9.5/8)	22090.349.245
1.1/8X335 (13.1/4)	22090.285.337	1.1/4X265 (10.1/2)	22090.317.266	1.3/8X250 (9.3/4)	22090.349.247
1.1/8X340 (13.3/8)	22090.285.340	1.1/4X270 (10.5/8)	22090.317.270	1.3/8X255 (10)	22090.349.254
1.1/8X345 (13.1/2)	22090.285.342	1.1/4X275 (10.3/4)	22090.317.273	1.3/8X260 (10.1/4)	22090.349.260
1.1/8X350 (13.3/4)	22090.285.349	1.1/4X280 (11)	22090.317.279	1.3/8X265 (10.1/2)	22090.349.266
1.1/8X355 (14)	22090.285.355	1.1/4X285 (11.1/4)	22090.317.285	1.3/8X270 (10.5/8)	22090.349.270
1.1/8X360 (14.1/4)	22090.285.361	1.1/4X290 (11.3/8)	22090.317.290	1.3/8X275 (10.3/4)	22090.349.273
1.1/8X365 (14.3/8)	22090.285.365	1.1/4X295 (11.1/2)	22090.317.292	1.3/8X280 (11)	22090.349.279
1.1/8X370 (14.1/2)	22090.285.368	1.1/4X300 (11.3/4)	22090.317.298	1.3/8X285 (11.1/4)	22090.349.285
1.1/8X375 (14.3/4)	22090.285.374	1.1/4X305 (12)	22090.317.304	1.3/8X290 (11.3/8)	22090.349.290
1.1/8X380 (15)	22090.285.381	1.1/4X310 (12.1/4)	22090.317.311	1.3/8X295 (11.1/2)	22090.349.292
1.1/8X385 (15.1/4)	22090.285.387	1.1/4X315 (12.1/2)	22090.317.317	1.3/8X300 (11.3/4)	22090.349.298
1.1/8X390 (15.3/8)	22090.285.390	1.1/4X320 (12.5/8)	22090.317.320	1.3/8X305 (12)	22090.349.304
1.1/8X395 (15.1/2)	22090.285.393	1.1/4X325 (12.3/4)	22090.317.323	1.3/8X310 (12.1/4)	22090.349.311
1.1/8X400 (15.3/4)	22090.285.400	1.1/4X330 (13)	22090.317.330	1.3/8X315 (12.1/2)	22090.349.317
1.1/8X405 (16)	22090.285.406	1.1/4X335 (13.1/4)	22090.317.337	1.3/8X320 (12.5/8)	22090.349.320
1.1/8X410 (16.1/8)	22090.285.410	1.1/4X340 (13.3/8)	22090.317.340	1.3/8X325 (12.3/4)	22090.349.323
1.1/8X415 (16.1/4)	22090.285.412	1.1/4X345 (13.1/2)	22090.317.342	1.3/8X330 (13)	22090.349.330
1.1/8X420 (16.1/2)	22090.285.419	1.1/4X350 (13.3/4)	22090.317.349	1.3/8X335 (13.1/4)	22090.349.337
1.1/8X425 (16.3/4)	22090.285.425	1.1/4X355 (14)	22090.317.355	1.3/8X340 (13.3/8)	22090.349.340
1.1/8X430 (17)	22090.285.431	1.1/4X360 (14.1/4)	22090.317.361	1.3/8X345 (13.1/2)	22090.349.342
1.1/8X435 (17.1/8)	22090.285.435	1.1/4X365 (14.3/8)	22090.317.365	1.3/8X350 (13.3/4)	22090.349.349
1.1/8X440 (17.1/4)	22090.285.438	1.1/4X370 (14.1/2)	22090.317.368	1.3/8X355 (14)	22090.349.355
1.1/8X445 (17.1/2)	22090.285.444	1.1/4X375 (14.3/4)	22090.317.374	1.3/8X360 (14.1/4)	22090.349.361
1.1/8X450 (17.3/4)	22090.285.450	1.1/4X380 (15)	22090.317.381	1.3/8X365 (14.3/8)	22090.349.365
1.1/8X455 (18)	22090.285.457	1.1/4X385 (15.1/4)	22090.317.387	1.3/8X370 (14.1/2)	22090.349.368
1.1/8X460 (18.1/8)	22090.285.460	1.1/4X390 (15.3/8)	22090.317.390	1.3/8X375 (14.3/4)	22090.349.374
1.1/8X465 (18.1/4)	22090.285.463	1.1/4X395 (15.1/2)	22090.317.393	1.3/8X380 (15)	22090.349.381
1.1/8X470 (18.1/2)	22090.285.469	1.1/4X400 (15.3/4)	22090.317.400	1.3/8X385 (15.1/4)	22090.349.387
1.1/8X475 (18.3/4)	22090.285.476	1.1/4X405 (16)	22090.317.406	1.3/8X390 (15.3/8)	22090.349.390
1.1/8X480 (18.7/8)	22090.285.480	1.1/4X410 (16.1/8)	22090.317.410	1.3/8X395 (15.1/2)	22090.349.393
1.1/8X485 (19)	22090.285.482	1.1/4X415 (16.1/4)	22090.317.412	1.3/8X400 (15.3/4)	22090.349.400
1.1/8X490 (19.1/4)	22090.285.488	1.1/4X420 (16.1/2)	22090.317.419	1.3/8X405 (16)	22090.349.406
1.1/8X495 (19.1/2)	22090.285.495	1.1/4X425 (16.3/4)	22090.317.425	1.3/8X410 (16.1/8)	22090.349.410
1.1/8X500 (19.3/4)	22090.285.501	1.1/4X430 (17)	22090.317.431	1.3/8X415 (16.1/4)	22090.349.412
1.1/8X505 (19.7/8)	22090.285.505	1.1/4X435 (17.1/8)	22090.317.435	1.3/8X420 (16.1/2)	22090.349.419
1.1/8X510 (20)	22090.285.508	1.1/4X440 (17.1/4)	22090.317.438	1.3/8X425 (16.3/4)	22090.349.425
1.1/8X515 (20.1/4)	22090.285.514	1.1/4X445 (17.1/2)	22090.317.444	1.3/8X430 (17)	22090.349.431
1.1/8X520 (20.1/2)	22090.285.520	1.1/4X450 (17.3/4)	22090.317.450	1.3/8X435 (17.1/8)	22090.349.435
1.1/8X525 (20.3/4)	22090.285.527	1.1/4X455 (18.1/4)	22090.317.457	1.3/8X440 (17.1/4)	22090.349.438
1.1/8X530 (20.7/8)	22090.285.530	1.1/4X460 (18.1/8)	22090.317.460	1.3/8X445 (17.1/2)	22090.349.444
1.1/8X540 (21.1/4)	22090.285.539	1.1/4X470 (18.1/4)	22090.317.463	1.3/8X450 (17.3/4)	22090.349.450
1.1/8X560 (22)	22090.285.558	1.1/4X475 (18.1/2)	22090.317.469	1.3/8X455 (18)	22090.349.457
1.1/8X570 (22.1/2)	22090.285.571	1.1/4X480 (18.3/4)	22090.317.476	1.3/8X460 (18.1/8)	22090.349.460
1.1/8X585 (23)	22090.285.584	1.1/4X485 (18.7/8)	22090.317.480	1.3/8X465 (18.1/4)	22090.349.463
1.1/8X590 (23.1/4)	22090.285.590	1.1/4X490 (19)	22090.317.482	1.3/8X470 (18.1/2)	22090.349.469
1.1/8X610 (24)	22090.285.609	1.1/4X495 (19.1/4)	22090.317.488	1.3/8X475 (18.3/4)	22090.349.476
1.1/8X620 (24.1/2)	22090.285.622	1.1/4X500 (19.1/2)	22090.317.495	1.3/8X480 (18.7/8)	22090.349.480
1.1/8X800 (31.1/2)	22090.285.800	1.1/4X500 (19.3/4)	22090.317.501	1.3/8X485 (19)	22090.349.482
		1.1/4X510 (20)	22090.317.508	1.3/8X490 (19.1/4)	22090.349.488

4

22090 Śruby dwustronne z dwiema sześciokątnymi nakrętkami, 8UN



d x L mm (L Inch)	☒	Kod artykułu	d x L mm (L Inch)	☒	Kod artykułu	d x L mm (L Inch)	☒	Kod artykułu
1.3/8X495 (19.1/2)	1	22090.349.495	1.1/2X600 (23.5/8)	1	22090.381.600	1.3/4X340 (13.3/8)	1	22090.444.340
1.3/8X500 (19.3/4)	1	22090.349.501	1.1/2X700 (27.1/2)	1	22090.381.698	1.3/4X345 (13.1/2)	1	22090.444.342
1.3/8X520 (20.1/2)	1	22090.349.520	1.1/2X810 (32)	1	22090.381.812	1.3/4X350 (13.3/4)	1	22090.444.349
1.3/8X530 (20.7/8)	1	22090.349.530				1.3/4X355 (14)	1	22090.444.355
1.3/8X535 (21)	1	22090.349.533	1.5/8X180 (7)	1	22090.412.177	1.3/4X360 (14.1/4)	1	22090.444.361
1.3/8X545 (21.1/2)	1	22090.349.546	1.5/8X180 (7.1/2)	1	22090.412.190	1.3/4X365 (14.3/8)	1	22090.444.365
1.3/8X550 (21.3/4)	1	22090.349.552	1.5/8X255 (10)	1	22090.412.254	1.3/4X370 (14.1/2)	1	22090.444.368
1.3/8X555 (21.7/8)	1	22090.349.555	1.5/8X260 (10.1/4)	1	22090.412.260	1.3/4X375 (14.3/4)	1	22090.444.374
1.3/8X575 (22.3/4)	1	22090.349.577	1.5/8X265 (10.1/2)	1	22090.412.266	1.3/4X380 (15)	1	22090.444.381
1.3/8X610 (24)	1	22090.349.609	1.5/8X270 (10.5/8)	1	22090.412.270	1.3/4X385 (15.1/4)	1	22090.444.387
1.3/8X670 (26.3/8)	1	22090.349.670	1.5/8X275 (10.3/4)	1	22090.412.273	1.3/4X390 (15.3/8)	1	22090.444.390
1.3/8X685 (27)	1	22090.349.685	1.5/8X280 (11)	1	22090.412.279	1.3/4X395 (15.1/2)	1	22090.444.393
			1.5/8X285 (11.1/4)	1	22090.412.285	1.3/4X400 (15.3/4)	1	22090.444.400
1.1/2X140 (5.1/2)	1	22090.381.139	1.5/8X290 (11.3/8)	1	22090.412.290	1.3/4X405 (16)	1	22090.444.406
1.1/2X145 (5.3/4)	1	22090.381.146	1.5/8X295 (11.1/2)	1	22090.412.292	1.3/4X410 (16.1/8)	1	22090.444.410
1.1/2X150 (6)	1	22090.381.152	1.5/8X300 (11.3/4)	1	22090.412.298	1.3/4X415 (16.1/4)	1	22090.444.412
1.1/2X165 (6.1/2)	1	22090.381.165	1.5/8X305 (12)	1	22090.412.304	1.3/4X420 (16.1/2)	1	22090.444.419
1.1/2X170 (6.3/4)	1	22090.381.171	1.5/8X310 (12.1/4)	1	22090.412.311	1.3/4X425 (16.3/4)	1	22090.444.425
1.1/2X180 (7)	1	22090.381.177	1.5/8X315 (12.1/2)	1	22090.412.317	1.3/4X430 (17)	1	22090.444.431
1.1/2X185 (7.1/4)	1	22090.381.184	1.5/8X320 (12.5/8)	1	22090.412.320	1.3/4X435 (17.1/8)	1	22090.444.435
1.1/2X190 (7.1/2)	1	22090.381.190	1.5/8X325 (12.3/4)	1	22090.412.323	1.3/4X440 (17.1/4)	1	22090.444.438
1.1/2X195 (7.3/4)	1	22090.381.196	1.5/8X330 (13)	1	22090.412.330	1.3/4X445 (17.1/2)	1	22090.444.444
1.1/2X200 (8)	1	22090.381.203	1.5/8X335 (13.1/4)	1	22090.412.337	1.3/4X450 (17.3/4)	1	22090.444.450
1.1/2X205 (8.1/8)	1	22090.381.205	1.5/8X340 (13.3/8)	1	22090.412.340	1.3/4X455 (18)	1	22090.444.457
1.1/2X210 (8.1/4)	1	22090.381.209	1.5/8X345 (13.1/2)	1	22090.412.342	1.3/4X460 (18.1/8)	1	22090.444.460
1.1/2X215 (8.1/2)	1	22090.381.215	1.5/8X350 (13.3/4)	1	22090.412.349	1.3/4X470 (18.1/2)	1	22090.444.469
1.1/2X220 (8.3/4)	1	22090.381.222	1.5/8X355 (14)	1	22090.412.355	1.3/4X480 (18.7/8)	1	22090.444.480
1.1/2X225 (8.7/8)	1	22090.381.225	1.5/8X360 (14.1/4)	1	22090.412.361	1.3/4X485 (19)	1	22090.444.482
1.1/2X230 (9)	1	22090.381.228	1.5/8X365 (14.3/8)	1	22090.412.365	1.3/4X490 (19.1/4)	1	22090.444.488
1.1/2X235 (9.1/4)	1	22090.381.234	1.5/8X370 (14.1/2)	1	22090.412.368	1.3/4X495 (19.1/2)	1	22090.444.495
1.1/2X240 (9.1/2)	1	22090.381.241	1.5/8X375 (14.3/4)	1	22090.412.374	1.3/4X500 (19.3/4)	1	22090.444.501
1.1/2X245 (9.5/8)	1	22090.381.245	1.5/8X380 (15)	1	22090.412.381	1.3/4X520 (20.1/2)	1	22090.444.520
1.1/2X250 (9.3/4)	1	22090.381.247	1.5/8X385 (15.1/4)	1	22090.412.387	1.3/4X570 (22.1/2)	1	22090.444.571
1.1/2X255 (10)	1	22090.381.254	1.5/8X390 (15.3/8)	1	22090.412.390	1.3/4X580 (22.7/8)	1	22090.444.580
1.1/2X260 (10.1/4)	1	22090.381.260	1.5/8X395 (15.1/2)	1	22090.412.393	1.3/4X595 (23.1/2)	1	22090.444.596
1.1/2X265 (10.1/2)	1	22090.381.266	1.5/8X400 (15.3/4)	1	22090.412.400	1.3/4X600 (23.5/8)	1	22090.444.600
1.1/2X270 (10.5/8)	1	22090.381.270	1.5/8X405 (16)	1	22090.412.406	1.3/4X610 (24)	1	22090.444.609
1.1/2X275 (10.3/4)	1	22090.381.273	1.5/8X410 (16.1/8)	1	22090.412.410	1.3/4X650 (25.5/8)	1	22090.444.650
1.1/2X280 (11)	1	22090.381.279	1.5/8X415 (16.1/4)	1	22090.412.412	1.3/4X685 (27)	1	22090.444.685
1.1/2X285 (11.1/4)	1	22090.381.285	1.5/8X420 (16.1/2)	1	22090.412.419	1.3/4X710 (28)	1	22090.444.711
1.1/2X290 (11.3/8)	1	22090.381.290	1.5/8X425 (16.3/4)	1	22090.412.425			
1.1/2X295 (11.1/2)	1	22090.381.292	1.5/8X430 (17)	1	22090.412.431	1.7/8X255 (10)	1	22090.476.254
1.1/2X300 (11.3/4)	1	22090.381.298	1.5/8X435 (17.1/8)	1	22090.412.435	1.7/8X280 (11)	1	22090.476.279
1.1/2X305 (12)	1	22090.381.304	1.5/8X440 (17.1/4)	1	22090.412.438	1.7/8X305 (12)	1	22090.476.304
1.1/2X310 (12.1/4)	1	22090.381.311	1.5/8X445 (17.1/2)	1	22090.412.444	1.7/8X310 (12.1/4)	1	22090.476.311
1.1/2X315 (12.1/2)	1	22090.381.317	1.5/8X450 (17.3/4)	1	22090.412.450	1.7/8X315 (12.1/2)	1	22090.476.317
1.1/2X320 (12.5/8)	1	22090.381.320	1.5/8X495 (19.1/2)	1	22090.412.495	1.7/8X320 (12.5/8)	1	22090.476.320
1.1/2X325 (12.3/4)	1	22090.381.323	1.5/8X500 (19.3/4)	1	22090.412.501	1.7/8X325 (12.3/4)	1	22090.476.323
1.1/2X330 (13)	1	22090.381.330	1.5/8X530 (20.7/8)	1	22090.412.530	1.7/8X330 (13)	1	22090.476.330
1.1/2X335 (13.1/4)	1	22090.381.337	1.5/8X545 (21.1/2)	1	22090.412.546	1.7/8X335 (13.1/4)	1	22090.476.337
1.1/2X340 (13.3/8)	1	22090.381.340	1.5/8X685 (27)	1	22090.412.685	1.7/8X340 (13.3/8)	1	22090.476.340
1.1/2X345 (13.1/2)	1	22090.381.342				1.7/8X345 (13.1/2)	1	22090.476.342
1.1/2X350 (13.3/4)	1	22090.381.349	1.3/4X155 (6.1/8)	1	22090.444.155	1.7/8X350 (13.3/4)	1	22090.476.349
1.1/2X355 (14)	1	22090.381.355	1.3/4X180 (7)	1	22090.444.177	1.7/8X355 (14)	1	22090.476.355
1.1/2X360 (14.1/4)	1	22090.381.361	1.3/4X200 (8)	1	22090.444.203	1.7/8X360 (14.1/4)	1	22090.476.361
1.1/2X365 (14.3/8)	1	22090.381.365	1.3/4X205 (8.1/8)	1	22090.444.205	1.7/8X365 (14.3/8)	1	22090.476.365
1.1/2X370 (14.1/2)	1	22090.381.368	1.3/4X210 (8.1/4)	1	22090.444.209	1.7/8X370 (14.1/2)	1	22090.476.368
1.1/2X375 (14.3/4)	1	22090.381.374	1.3/4X215 (8.1/2)	1	22090.444.215	1.7/8X375 (14.3/4)	1	22090.476.374
1.1/2X380 (15)	1	22090.381.381	1.3/4X220 (8.3/4)	1	22090.444.222	1.7/8X380 (15)	1	22090.476.381
1.1/2X385 (15.1/4)	1	22090.381.387	1.3/4X225 (8.7/8)	1	22090.444.225	1.7/8X385 (15.1/4)	1	22090.476.387
1.1/2X390 (15.3/8)	1	22090.381.390	1.3/4X230 (9)	1	22090.444.228	1.7/8X390 (15.3/8)	1	22090.476.390
1.1/2X395 (15.1/2)	1	22090.381.393	1.3/4X235 (9.1/4)	1	22090.444.234	1.7/8X395 (15.1/2)	1	22090.476.393
1.1/2X400 (15.3/4)	1	22090.381.400	1.3/4X240 (9.1/2)	1	22090.444.241	1.7/8X400 (15.3/4)	1	22090.476.400
1.1/2X405 (16)	1	22090.381.406	1.3/4X245 (9.5/8)	1	22090.444.245	1.7/8X405 (16)	1	22090.476.406
1.1/2X410 (16.1/8)	1	22090.381.410	1.3/4X250 (9.3/4)	1	22090.444.247	1.7/8X410 (16.1/8)	1	22090.476.410
1.1/2X415 (16.1/4)	1	22090.381.412	1.3/4X255 (10)	1	22090.444.254	1.7/8X415 (16.1/4)	1	22090.476.412
1.1/2X420 (16.1/2)	1	22090.381.419	1.3/4X260 (10.1/4)	1	22090.444.260	1.7/8X420 (16.1/2)	1	22090.476.419
1.1/2X430 (17)	1	22090.381.431	1.3/4X265 (10.1/2)	1	22090.444.266	1.7/8X425 (16.3/4)	1	22090.476.425
1.1/2X440 (17.1/4)	1	22090.381.438	1.3/4X270 (10.5/8)	1	22090.444.270	1.7/8X430 (17)	1	22090.476.431
1.1/2X450 (17.3/4)	1	22090.381.450	1.3/4X275 (10.3/4)	1	22090.444.273	1.7/8X435 (17.1/8)	1	22090.476.435
1.1/2X455 (18)	1	22090.381.457	1.3/4X280 (11)	1	22090.444.279	1.7/8X440 (17.1/4)	1	22090.476.438
1.1/2X460 (18.1/8)	1	22090.381.460	1.3/4X285 (11.1/4)	1	22090.444.285	1.7/8X445 (17.1/2)	1	22090.476.444
1.1/2X480 (18.7/8)	1	22090.381.480	1.3/4X290 (11.3/8)	1	22090.444.290	1.7/8X450 (17.3/4)	1	22090.476.450
1.1/2X490 (19.1/4)	1	22090.381.488	1.3/4X295 (11.1/2)	1	22090.444.292	1.7/8X455 (18)	1	22090.476.457
1.1/2X500 (19.3/4)	1	22090.381.501	1.3/4X300 (11.3/4)	1	22090.444.298	1.7/8X460 (18.1/8)	1	22090.476.460
1.1/2X510 (20)	1	22090.381.508	1.3/4X305 (12)	1	22090.444.304	1.7/8X465 (18.1/4)	1	22090.476.463
1.1/2X525 (20.3/4)	1	22090.381.527	1.3/4X310 (12.1/4)	1	22090.444.311	1.7/8X470 (18.1/2)	1	22090.476.469
1.1/2X530 (20.7/8)	1	22090.381.530	1.3/4X315 (12.1/2)	1	22090.444.317	1.7/8X475 (18.3/4)	1	22090.476.476
1.1/2X545 (21.1/2)	1	22090.381.546	1.3/4X320 (12.5/8)	1	22090.444.320	1.7/8X480 (18.7/8)	1	22090.476.480
1.1/2X550 (21.3/4)	1	22090.381.552	1.3/4X325 (12.3/4)	1	22090.444.323	1.7/8X485 (19)	1	22090.476.482
1.1/2X560 (22)	1	22090.381.558	1.3/4X330 (13)					

22090 Śruby dwustronne z dwiema sześciokątnymi nakrętkami, 8UN

d x L mm (L Inch)	☒	Kod artykułu	d x L mm (L Inch)	☒	Kod artykułu	d x L mm (L Inch)	☒	Kod artykułu
1.7/8X500 (19.3/4)	1	22090.476.501	2.IN.X475 (18.3/4)	1	22090.508.476	2.1/2X490 (19.1/4)	1	22090.635.488
1.7/8X510 (20)	1	22090.476.508	2.IN.X480 (18.7/8)	1	22090.508.480	2.1/2X495 (19.1/2)	1	22090.635.495
1.7/8X555 (21.7/8)	1	22090.476.555	2.IN.X485 (19)	1	22090.508.482	2.1/2X510 (20)	1	22090.635.508
1.7/8X560 (22)	1	22090.476.558	2.IN.X490 (19.1/4)	1	22090.508.488	2.1/2X520 (20.1/2)	1	22090.635.520
1.7/8X565 (22.1/4)	1	22090.476.565	2.IN.X495 (19.1/2)	1	22090.508.495	2.1/2X530 (20.7/8)	1	22090.635.530
1.7/8X600 (23.5/8)	1	22090.476.600	2.IN.X500 (19.3/4)	1	22090.508.501	2.1/2X535 (21)	1	22090.635.533
1.7/8X620 (24.1/2)	1	22090.476.622	2.IN.X510 (20)	1	22090.508.508	2.1/2X545 (21.1/2)	1	22090.635.546
1.7/8X675 (26.1/2)	1	22090.476.673	2.IN.X550 (21.3/4)	1	22090.508.552	2.1/2X560 (22)	1	22090.635.558
1.7/8X685 (27)	1	22090.476.685	2.IN.X565 (22.1/4)	1	22090.508.565	2.1/2X570 (22.1/2)	1	22090.635.571
2.IN.X205 (8.1/8)	1	22090.508.205	2.IN.X600 (23.5/8)	1	22090.508.600	2.1/2X585 (23)	1	22090.635.584
2.IN.X255 (10)	1	22090.508.254	2.IN.X650 (25.5/8)	1	22090.508.650	2.1/2X590 (23.1/4)	1	22090.635.590
2.IN.X305 (12)	1	22090.508.304	2.IN.X655 (25.3/4)	1	22090.508.654	2.1/2X600 (23.5/8)	1	22090.635.600
2.IN.X310 (12.1/4)	1	22090.508.311	2.IN.X660 (26)	1	22090.508.660	2.1/2X630 (24.3/4)	1	22090.635.628
2.IN.X315 (12.1/2)	1	22090.508.317	2.IN.X670 (26.3/8)	1	22090.508.670	2.1/2X650 (25.5/8)	1	22090.635.650
2.IN.X320 (12.5/8)	1	22090.508.320	2.IN.X680 (26.3/4)	1	22090.508.679	2.1/2X730 (28.3/4)	1	22090.635.730
2.IN.X325 (12.3/4)	1	22090.508.323	2.IN.X690 (27.1/4)	1	22090.508.692	2.1/2X780 (30.3/4)	1	22090.635.781
2.IN.X330 (13)	1	22090.508.330	2.IN.X700 (27.1/2)	1	22090.508.698	2.1/2X805 (31.3/4)	1	22090.635.806
2.IN.X335 (13.1/4)	1	22090.508.337	2.IN.X740 (29.1/4)	1	22090.508.742	2.1/2X845 (33.1/4)	1	22090.635.844
2.IN.X340 (13.3/8)	1	22090.508.340	2.IN.X750 (29.1/2)	1	22090.508.749	2.1/2X890 (35)	1	22090.635.889
2.IN.X345 (13.1/2)	1	22090.508.342	2.IN.X755 (29.3/4)	1	22090.508.755	2.1/2X950 (37.3/8)	1	22090.635.950
2.IN.X350 (13.3/4)	1	22090.508.349	2.1/4X280 (11)	1	22090.571.279	2.3/4X450 (17.3/4)	1	22090.698.450
2.IN.X355 (14)	1	22090.508.355	2.1/4X375 (14.3/4)	1	22090.571.374	2.3/4X500 (19.3/4)	1	22090.698.501
2.IN.X360 (14.1/4)	1	22090.508.361	2.1/4X390 (15.3/8)	1	22090.571.390	2.3/4X520 (20.1/2)	1	22090.698.520
2.IN.X365 (14.3/8)	1	22090.508.365	2.1/4X405 (16)	1	22090.571.406	2.3/4X535 (21)	1	22090.698.533
2.IN.X370 (14.1/2)	1	22090.508.368	2.1/4X425 (16.3/4)	1	22090.571.425	2.3/4X600 (23.5/8)	1	22090.698.600
2.IN.X375 (14.3/4)	1	22090.508.374	2.1/4X430 (17)	1	22090.571.431	2.3/4X630 (24.3/4)	1	22090.698.628
2.IN.X380 (15)	1	22090.508.381	2.1/4X470 (18.1/2)	1	22090.571.469	2.3/4X660 (26)	1	22090.698.660
2.IN.X385 (15.1/4)	1	22090.508.387	2.1/4X485 (19)	1	22090.571.482	2.3/4X690 (27.1/4)	1	22090.698.692
2.IN.X390 (15.3/8)	1	22090.508.390	2.1/4X510 (20)	1	22090.571.508	2.3/4X710 (28)	1	22090.698.711
2.IN.X395 (15.1/2)	1	22090.508.393	2.1/4X520 (20.1/2)	1	22090.571.520	2.3/4X720 (28.3/8)	1	22090.698.720
2.IN.X400 (15.3/4)	1	22090.508.400	2.1/4X550 (21.3/4)	1	22090.571.552	2.3/4X730 (28.3/4)	1	22090.698.730
2.IN.X405 (16)	1	22090.508.406	2.1/4X585 (23)	1	22090.571.584	3.IN.X355 (14)	1	22090.762.355
2.IN.X410 (16.1/8)	1	22090.508.410	2.1/4X590 (23.1/4)	1	22090.571.590	3.IN.X475 (18.3/4)	1	22090.762.476
2.IN.X415 (16.1/4)	1	22090.508.412	2.1/4X600 (23.5/8)	1	22090.571.600	3.IN.X585 (23)	1	22090.762.584
2.IN.X420 (16.1/2)	1	22090.508.419	2.1/4X695 (27.3/8)	1	22090.571.695	3.IN.X590 (23.1/4)	1	22090.762.590
2.IN.X425 (16.3/4)	1	22090.508.425	2.1/4X700 (27.1/2)	1	22090.571.698	3.IN.X650 (25.5/8)	1	22090.762.650
2.IN.X430 (17)	1	22090.508.431	2.1/4X870 (34.1/4)	1	22090.571.869	3.IN.X660 (26)	1	22090.762.660
2.IN.X435 (17.1/8)	1	22090.508.435	2.1/2X380 (15)	1	22090.635.381	3.IN.X700 (27.1/2)	1	22090.762.698
2.IN.X440 (17.1/4)	1	22090.508.438	2.1/2X405 (16)	1	22090.635.406	3.IN.X710 (28)	1	22090.762.711
2.IN.X445 (17.1/2)	1	22090.508.444	2.1/2X435 (17.1/8)	1	22090.635.435	3.IN.X735 (29)	1	22090.762.736
2.IN.X450 (17.3/4)	1	22090.508.450	2.1/2X440 (17.1/4)	1	22090.635.438	3.IN.X800 (31.1/2)	1	22090.762.800
2.IN.X455 (18)	1	22090.508.457	2.1/2X445 (17.1/2)	1	22090.635.444	3.IN.X850 (33.1/2)	1	22090.762.850
2.IN.X460 (18.1/8)	1	22090.508.460	2.1/2X470 (18.1/2)	1	22090.635.469			
2.IN.X465 (18.1/4)	1	22090.508.463	2.1/2X485 (19)	1	22090.635.482			
2.IN.X470 (18.1/2)	1	22090.508.469						

4
22320 Śruby dwustronne z dwiema sześciokątnymi nakrętkami, UNC
G10A

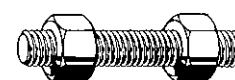
Gwint Calowy, zunifikowany grubozwojny (UNC)
Materiał Stal ASTM A320 - ASTM A194
Klasa Gr.L7 - Gr.4



d x L mm (L Inch)	☒	Kod artykułu	d x L mm (L Inch)	☒	Kod artykułu	d x L mm (L Inch)	☒	Kod artykułu
3/8X25 (1)	1	22320.096.025	1/2X100 (4)	1	22320.127.101	5/8X40 (1.1/2)	1	22320.158.038
3/8X40 (1.1/2)	1	22320.096.038	1/2X105 (4.1/8)	1	22320.127.105	5/8X45 (1.3/4)	1	22320.158.044
3/8X45 (1.3/4)	1	22320.096.044	1/2X110 (4.1/4)	1	22320.127.107	5/8X50 (2)	1	22320.158.050
3/8X60 (2.3/8)	1	22320.096.060	1/2X115 (4.1/2)	1	22320.127.114	5/8X55 (2.1/4)	1	22320.158.057
3/8X65 (2.1/2)	1	22320.096.063	1/2X120 (4.3/4)	1	22320.127.120	5/8X60 (2.3/8)	1	22320.158.060
3/8X70 (2.3/4)	1	22320.096.069	1/2X130 (5.1/8)	1	22320.127.130	5/8X65 (2.1/2)	1	22320.158.063
3/8X80 (3.1/4)	1	22320.096.082	1/2X135 (5.1/4)	1	22320.127.133	5/8X70 (2.3/4)	1	22320.158.069
3/8X95 (3.3/4)	1	22320.096.095	1/2X140 (5.1/2)	1	22320.127.139	5/8X75 (3)	1	22320.158.076
3/8X100 (4)	1	22320.096.101	1/2X150 (6)	1	22320.127.152	5/8X80 (3.1/4)	1	22320.158.082
3/8X175 (6.7/8)	1	22320.096.175	1/2X155 (6.1/8)	1	22320.127.155	5/8X85 (3.3/8)	1	22320.158.085
3/8X185 (7.1/4)	1	22320.096.184	1/2X165 (6.1/2)	1	22320.127.165	5/8X90 (3.1/2)	1	22320.158.088
1/2X40 (1.1/2)	1	22320.127.038	1/2X170 (6.3/4)	1	22320.127.171	5/8X95 (3.3/4)	1	22320.158.095
1/2X45 (1.3/4)	1	22320.127.044	1/2X175 (6.7/8)	1	22320.127.175	5/8X100 (4)	1	22320.158.101
1/2X50 (2)	1	22320.127.050	1/2X180 (7)	1	22320.127.177	5/8X105 (4.1/8)	1	22320.158.105
1/2X55 (2.1/4)	1	22320.127.057	1/2X190 (7.1/2)	1	22320.127.190	5/8X110 (4.1/4)	1	22320.158.107
1/2X60 (2.3/8)	1	22320.127.060	1/2X195 (7.3/4)	1	22320.127.196	5/8X115 (4.1/2)	1	22320.158.114
1/2X65 (2.1/2)	1	22320.127.063	1/2X200 (8)	1	22320.127.203	5/8X120 (4.3/4)	1	22320.158.120
1/2X70 (2.3/4)	1	22320.127.069	1/2X205 (8.1/8)	1	22320.127.205	5/8X125 (5)	1	22320.158.127
1/2X75 (3)	1	22320.127.076	1/2X210 (8.1/4)	1	22320.127.209	5/8X130 (5.1/8)	1	22320.158.130
1/2X80 (3.1/4)	1	22320.127.082	1/2X220 (8.3/4)	1	22320.127.222	5/8X135 (5.1/4)	1	22320.158.133
1/2X85 (3.3/8)	1	22320.127.085	1/2X225 (8.7/8)	1	22320.127.225	5/8X140 (5.1/2)	1	22320.158.139
1/2X90 (3.1/2)	1	22320.127.088	1/2X250 (9.3/4)	1	22320.127.247	5/8X145 (5.3/4)	1	22320.158.146
1/2X95 (3.3/4)	1	22320.127.095	1/2X280 (11)	1	22320.127.279	5/8X150 (6)	1	22320.158.152
			1/2X300 (11.3/4)	1	22320.127.298			

22320 Śruby dwustronne z dwiema sześciokątnymi nakrętkami, UNC

d x L mm (L Inch)	☒	Kod artykułu	d x L mm (L Inch)	☒	Kod artykułu	d x L mm (L Inch)	☒	Kod artykułu
5/8X155 (6.1/8)	1	22320.158.155	3/4X245 (9.5/8)	1	22320.191.245	7/8X260 (10.1/4)	1	22320.222.260
5/8X160 (6.1/4)	1	22320.158.158	3/4X250 (9.3/4)	1	22320.191.247	7/8X265 (10.1/2)	1	22320.222.266
5/8X165 (6.1/2)	1	22320.158.165	3/4X255 (9)	1	22320.191.254	7/8X270 (10.5/8)	1	22320.222.270
5/8X170 (6.3/4)	1	22320.158.171	3/4X260 (10.1/4)	1	22320.191.260	7/8X275 (10.3/4)	1	22320.222.273
5/8X175 (6.7/8)	1	22320.158.175	3/4X265 (10.1/2)	1	22320.191.266	7/8X280 (11)	1	22320.222.279
5/8X180 (7)	1	22320.158.177	3/4X270 (10.5/8)	1	22320.191.270	7/8X285 (11.1/4)	1	22320.222.285
5/8X185 (7.1/4)	1	22320.158.184	3/4X275 (10.3/4)	1	22320.191.273	7/8X290 (11.3/8)	1	22320.222.290
5/8X190 (7.1/2)	1	22320.158.190	3/4X280 (11)	1	22320.191.279	7/8X295 (11.1/2)	1	22320.222.292
5/8X195 (7.3/4)	1	22320.158.196	3/4X285 (11.1/4)	1	22320.191.285	7/8X300 (11.3/4)	1	22320.222.298
5/8X200 (8)	1	22320.158.203	3/4X290 (11.3/8)	1	22320.191.290	7/8X305 (12)	1	22320.222.304
5/8X205 (8.1/8)	1	22320.158.205	3/4X295 (11.1/2)	1	22320.191.292	7/8X310 (12.1/4)	1	22320.222.311
5/8X210 (8.1/4)	1	22320.158.209	3/4X300 (11.3/4)	1	22320.191.298	7/8X315 (12.1/2)	1	22320.222.317
5/8X215 (8.1/2)	1	22320.158.215	3/4X305 (12)	1	22320.191.304	7/8X320 (12.5/8)	1	22320.222.320
5/8X220 (8.3/4)	1	22320.158.222	3/4X310 (12.1/4)	1	22320.191.311	7/8X325 (12.3/4)	1	22320.222.323
5/8X225 (8.7/8)	1	22320.158.225	3/4X315 (12.1/2)	1	22320.191.317	7/8X330 (13)	1	22320.222.330
5/8X230 (9)	1	22320.158.228	3/4X320 (12.3/8)	1	22320.191.320	7/8X335 (13.1/4)	1	22320.222.336
5/8X240 (9.1/2)	1	22320.158.241	3/4X325 (12.3/4)	1	22320.191.323	7/8X340 (13.3/8)	1	22320.222.340
5/8X245 (9.5/8)	1	22320.158.245	3/4X330 (13)	1	22320.191.330	7/8X345 (13.1/2)	1	22320.222.342
5/8X250 (9.3/4)	1	22320.158.247	3/4X335 (13.1/4)	1	22320.191.336	7/8X350 (13.3/4)	1	22320.222.349
5/8X255 (10)	1	22320.158.254	3/4X340 (13.3/8)	1	22320.191.340	7/8X355 (14)	1	22320.222.355
5/8X260 (10.1/4)	1	22320.158.260	3/4X345 (13.1/2)	1	22320.191.342	7/8X360 (14.1/4)	1	22320.222.361
5/8X265 (10.1/2)	1	22320.158.266	3/4X350 (13.3/4)	1	22320.191.349	7/8X365 (14.3/8)	1	22320.222.365
5/8X270 (10.5/8)	1	22320.158.270	3/4X355 (14)	1	22320.191.355	7/8X370 (14.1/2)	1	22320.222.368
5/8X275 (10.3/4)	1	22320.158.273	3/4X360 (14.1/4)	1	22320.191.361	7/8X375 (14.3/4)	1	22320.222.375
5/8X280 (11)	1	22320.158.279	3/4X365 (14.3/8)	1	22320.191.365	7/8X380 (15)	1	22320.222.381
5/8X285 (11.1/4)	1	22320.158.285	3/4X370 (14.1/2)	1	22320.191.368	7/8X385 (15.1/4)	1	22320.222.382
5/8X290 (11.3/8)	1	22320.158.290	3/4X375 (14.3/4)	1	22320.191.374	7/8X390 (15.3/8)	1	22320.222.390
5/8X295 (11.1/2)	1	22320.158.292	3/4X380 (15)	1	22320.191.381	7/8X395 (15.1/2)	1	22320.222.393
5/8X300 (11.3/4)	1	22320.158.298	3/4X385 (15.1/4)	1	22320.191.387	7/8X400 (15.3/4)	1	22320.222.400
5/8X305 (12)	1	22320.158.304	3/4X390 (15.3/8)	1	22320.191.390	7/8X405 (16)	1	22320.222.406
5/8X310 (12.1/4)	1	22320.158.311	3/4X395 (15.1/2)	1	22320.191.393	7/8X410 (16.1/8)	1	22320.222.410
5/8X315 (12.1/2)	1	22320.158.317	3/4X400 (15.3/4)	1	22320.191.400	7/8X415 (16.1/4)	1	22320.222.412
5/8X320 (12.5/8)	1	22320.158.320	3/4X405 (16)	1	22320.191.406	7/8X420 (16.1/2)	1	22320.222.419
5/8X325 (12.3/4)	1	22320.158.323	3/4X410 (16.1/8)	1	22320.191.410	7/8X425 (16.3/4)	1	22320.222.425
5/8X330 (13)	1	22320.158.330	3/4X415 (16.1/4)	1	22320.191.412	7/8X430 (17)	1	22320.222.431
5/8X335 (13.1/4)	1	22320.158.336	3/4X420 (16.1/2)	1	22320.191.419	7/8X440 (17.1/4)	1	22320.222.438
5/8X340 (13.3/8)	1	22320.158.340	3/4X430 (17)	1	22320.191.431	7/8X450 (17.3/4)	1	22320.222.450
5/8X345 (13.1/2)	1	22320.158.342	3/4X440 (17.1/4)	1	22320.191.438	7/8X455 (18)	1	22320.222.457
5/8X370 (14.1/2)	1	22320.158.368	3/4X450 (17.3/4)	1	22320.191.450	7/8X470 (18.1/2)	1	22320.222.469
5/8X375 (14.3/4)	1	22320.158.374	3/4X455 (18)	1	22320.191.457	7/8X485 (19)	1	22320.222.482
5/8X385 (15.1/4)	1	22320.158.387	3/4X470 (18.1/2)	1	22320.191.469	7/8X495 (19.1/2)	1	22320.222.495
5/8X420 (16.1/2)	1	22320.158.419	3/4X480 (18.7/8)	1	22320.191.480	7/8X510 (20)	1	22320.222.508
3/4X50 (2)	1	22320.191.050	3/4X485 (19)	1	22320.191.482	7/8X515 (20.1/4)	1	22320.222.514
3/4X55 (2.1/4)	1	22320.191.057	3/4X580 (22.7/8)	1	22320.191.580	7/8X525 (20.3/4)	1	22320.222.527
3/4X60 (2.3/8)	1	22320.191.060	3/4X625 (25.5/8)	1	22320.191.625			
3/4X65 (2.1/2)	1	22320.191.063	7/8X70 (2.3/4)	1	22320.222.069	1.IN.X85 (3.3/8)	1	22320.254.085
3/4X70 (2.3/4)	1	22320.191.069	7/8X75 (3)	1	22320.222.076	1.IN.X100 (4)	1	22320.254.101
3/4X75 (3)	1	22320.191.076	7/8X80 (3.1/4)	1	22320.222.082	1.IN.X105 (4.1/8)	1	22320.254.105
3/4X80 (3.1/4)	1	22320.191.082	7/8X90 (3.1/2)	1	22320.222.088	1.IN.X110 (4.1/4)	1	22320.254.107
3/4X85 (3.3/8)	1	22320.191.085	7/8X100 (4)	1	22320.222.101	1.IN.X115 (4.1/2)	1	22320.254.114
3/4X90 (3.1/2)	1	22320.191.088	7/8X105 (4.1/8)	1	22320.222.105	1.IN.X120 (4.3/4)	1	22320.254.120
3/4X95 (3.3/4)	1	22320.191.095	7/8X105 (4.1/4)	1	22320.222.107	1.IN.X125 (5)	1	22320.254.127
3/4X100 (4)	1	22320.191.101	7/8X115 (4.1/2)	1	22320.222.114	1.IN.X130 (5.1/8)	1	22320.254.130
3/4X105 (4.1/8)	1	22320.191.105	7/8X120 (4.3/4)	1	22320.222.120	1.IN.X135 (5.1/4)	1	22320.254.133
3/4X110 (4.1/4)	1	22320.191.107	7/8X125 (5)	1	22320.222.127	1.IN.X140 (5.1/2)	1	22320.254.139
3/4X115 (4.1/2)	1	22320.191.114	7/8X130 (5.1/8)	1	22320.222.130	1.IN.X145 (5.3/4)	1	22320.254.146
3/4X120 (4.3/4)	1	22320.191.120	7/8X135 (5.1/4)	1	22320.222.133	1.IN.X150 (6)	1	22320.254.152
3/4X125 (5)	1	22320.191.127	7/8X140 (5.1/2)	1	22320.222.139	1.IN.X155 (6.1/8)	1	22320.254.155
3/4X130 (5.1/8)	1	22320.191.130	7/8X145 (5.3/4)	1	22320.222.146	1.IN.X160 (6.1/4)	1	22320.254.158
3/4X135 (5.1/4)	1	22320.191.133	7/8X150 (6)	1	22320.222.152	1.IN.X165 (6.1/2)	1	22320.254.165
3/4X140 (5.1/2)	1	22320.191.139	7/8X155 (6.1/8)	1	22320.222.155	1.IN.X170 (6.3/4)	1	22320.254.171
3/4X145 (5.3/4)	1	22320.191.146	7/8X160 (6.1/4)	1	22320.222.158	1.IN.X175 (6.7/8)	1	22320.254.175
3/4X150 (6)	1	22320.191.152	7/8X165 (6.1/2)	1	22320.222.165	1.IN.X180 (7)	1	22320.254.177
3/4X155 (6.1/8)	1	22320.191.155	7/8X170 (6.3/4)	1	22320.222.171	1.IN.X185 (7.1/4)	1	22320.254.184
3/4X160 (6.1/4)	1	22320.191.158	7/8X175 (6.7/8)	1	22320.222.175	1.IN.X190 (7)	1	22320.254.190
3/4X165 (6.1/2)	1	22320.191.165	7/8X180 (7)	1	22320.222.177	1.IN.X195 (7.3/4)	1	22320.254.196
3/4X170 (6.3/4)	1	22320.191.171	7/8X185 (7.1/4)	1	22320.222.184	1.IN.X200 (8)	1	22320.254.203
3/4X175 (6.7/8)	1	22320.191.175	7/8X190 (7.1/2)	1	22320.222.190	1.IN.X205 (8.1/8)	1	22320.254.205
3/4X180 (7)	1	22320.191.177	7/8X195 (7.3/4)	1	22320.222.196	1.IN.X210 (8.1/4)	1	22320.254.209
3/4X185 (7.1/4)	1	22320.191.184	7/8X200 (8)	1	22320.222.203	1.IN.X215 (8.1/2)	1	22320.254.215
3/4X190 (7.1/2)	1	22320.191.190	7/8X205 (8.1/8)	1	22320.222.205	1.IN.X220 (8.3/4)	1	22320.254.222
3/4X195 (7.3/4)	1	22320.191.196	7/8X210 (8.1/4)	1	22320.222.209	1.IN.X225 (8.7/8)	1	22320.254.225
3/4X200 (8)	1	22320.191.203	7/8X215 (8.1/2)	1	22320.222.215	1.IN.X230 (9)	1	22320.254.228
3/4X205 (8.1/8)	1	22320.191.205	7/8X220 (8.3/4)	1	22320.222.222	1.IN.X235 (9.1/4)	1	22320.254.234
3/4X210 (8.1/4)	1	22320.191.209	7/8X225 (8.7/8)	1	22320.222.225	1.IN.X240 (9.1/2)	1	22320.254.241
3/4X215 (8.1/2)	1	22320.191.215	7/8X230 (9)	1	22320.222.228	1.IN.X245 (9.5/8)	1	22320.254.245
3/4X220 (8.3/4)	1	22320.191.222	7/8X235 (9.1/4)	1	22320.222.234	1.IN.X250 (9.3/4)	1	22320.254.247
3/4X225 (8.7/8)	1	22320.191.225	7/8X240 (9.1/2)	1	22320.222.241	1.IN.X255 (10)	1	22320.254.254
3/4X230 (9)	1	22320.191.228	7/8X245 (9.5/8)	1	22320.222.245	1.IN.X260 (10.1/4)	1	22320.254.260
3/4X235 (9.1/4)	1	22320.191.234	7/8X250 (9.3/4)	1	22320.222.247	1.IN.X265 (10.1/2)	1	22320.254.266
3/4X240 (9.1/2)	1	22320.191.241	7/8X255 (10)	1	22320.222.254	1.IN.X270 (10.5/8)	1	22320.254.270
						1.IN.X275 (10.3/4)	1	22320.254.273

4

22320 Śruby dwustronne z dwiema sześciokątnymi nakrętkami, UNC								
d x L mm (L Inch)	☒	Kod artykułu	d x L mm (L Inch)	☒	Kod artykułu	d x L mm (L Inch)	☒	Kod artykułu
1.IN.X280 (11)	1	22320.254.279	1.IN.X355 (14)	1	22320.254.355	1.IN.X430 (17)	1	22320.254.431
1.IN.X285 (11.1/4)	1	22320.254.285	1.IN.X360 (14.1/4)	1	22320.254.361	1.IN.X435 (17.1/8)	1	22320.254.435
1.IN.X290 (11.3/8)	1	22320.254.290	1.IN.X365 (14.3/8)	1	22320.254.365	1.IN.X440 (17.1/4)	1	22320.254.438
1.IN.X295 (11.1/2)	1	22320.254.292	1.IN.X370 (14.1/2)	1	22320.254.368	1.IN.X445 (17.1/2)	1	22320.254.444
1.IN.X300 (11.3/4)	1	22320.254.298	1.IN.X375 (14.3/4)	1	22320.254.374	1.IN.X450 (17.3/4)	1	22320.254.450
1.IN.X305 (12)	1	22320.254.304	1.IN.X380 (15)	1	22320.254.381	1.IN.X455 (18)	1	22320.254.457
1.IN.X310 (12.1/4)	1	22320.254.311	1.IN.X385 (15.1/4)	1	22320.254.387	1.IN.X460 (18.1/8)	1	22320.254.460
1.IN.X315 (12.1/2)	1	22320.254.317	1.IN.X390 (15.3/8)	1	22320.254.390	1.IN.X470 (18.1/2)	1	22320.254.469
1.IN.X320 (12.5/8)	1	22320.254.320	1.IN.X395 (15.1/2)	1	22320.254.393	1.IN.X485 (19)	1	22320.254.482
1.IN.X325 (12.3/4)	1	22320.254.323	1.IN.X405 (16)	1	22320.254.406	1.IN.X505 (19.7/8)	1	22320.254.505
1.IN.X330 (13)	1	22320.254.330	1.IN.X410 (16.1/8)	1	22320.254.410	1.IN.X515 (20.1/4)	1	22320.254.514
1.IN.X335 (13.1/4)	1	22320.254.336	1.IN.X415 (16.1/4)	1	22320.254.412	1.IN.X520 (20.1/2)	1	22320.254.520
1.IN.X340 (13.3/8)	1	22320.254.340	1.IN.X420 (16.1/2)	1	22320.254.419	1.IN.X595 (23.1/2)	1	22320.254.596
1.IN.X345 (13.1/2)	1	22320.254.342	1.IN.X425 (16.3/4)	1	22320.254.425			

22330 Śruby dwustronne z dwiema sześciokątnymi nakrętkami, 8UN		G10A
Gwint	8 UN amerykański	
Materiał	Stal ASTM A320 - ASTM A194	
Klasa	Gr.L7 - Gr.4	



d x L mm (L Inch)	☒	Kod artykułu	d x L mm (L Inch)	☒	Kod artykułu	d x L mm (L Inch)	☒	Kod artykułu
1.1/8X100 (4)	1	22330.285.101	1.1/8X435 (17.1/8)	1	22330.285.435	1.1/4X250 (9.3/4)	1	22330.317.247
1.1/8X105 (4.1/8)	1	22330.285.105	1.1/8X440 (17.1/4)	1	22330.285.438	1.1/4X255 (10)	1	22330.317.254
1.1/8X110 (4.1/4)	1	22330.285.107	1.1/8X445 (17.1/2)	1	22330.285.444	1.1/4X260 (10.1/4)	1	22330.317.260
1.1/8X115 (4.1/2)	1	22330.285.114	1.1/8X450 (17.3/4)	1	22330.285.450	1.1/4X270 (10.5/8)	1	22330.317.270
1.1/8X120 (4.3/4)	1	22330.285.120	1.1/8X455 (18)	1	22330.285.457	1.1/4X280 (11)	1	22330.317.279
1.1/8X125 (5)	1	22330.285.127	1.1/8X460 (18.1/8)	1	22330.285.460	1.1/4X285 (11.1/4)	1	22330.317.285
1.1/8X130 (5.1/8)	1	22330.285.130	1.1/8X465 (18.1/4)	1	22330.285.463	1.1/4X290 (11.3/8)	1	22330.317.290
1.1/8X135 (5.1/4)	1	22330.285.133	1.1/8X470 (18.1/2)	1	22330.285.469	1.1/4X295 (11.1/2)	1	22330.317.292
1.1/8X140 (5.1/2)	1	22330.285.139	1.1/8X475 (18.3/4)	1	22330.285.476	1.1/4X300 (11.3/4)	1	22330.317.298
1.1/8X145 (5.3/4)	1	22330.285.146	1.1/8X480 (18.7/8)	1	22330.285.480	1.1/4X310 (12.1/4)	1	22330.317.311
1.1/8X150 (6)	1	22330.285.152	1.1/8X485 (19)	1	22330.285.482	1.1/4X315 (12.1/2)	1	22330.317.317
1.1/8X155 (6.1/8)	1	22330.285.155	1.1/8X490 (19.1/4)	1	22330.285.488	1.1/4X325 (12.3/4)	1	22330.317.323
1.1/8X160 (6.1/4)	1	22330.285.158	1.1/8X495 (19.1/2)	1	22330.285.495	1.1/4X335 (13.1/4)	1	22330.317.336
1.1/8X165 (6.1/2)	1	22330.285.165	1.1/8X500 (19.3/4)	1	22330.285.501	1.1/4X335 (13.1/4)	1	22330.317.337
1.1/8X170 (6.3/4)	1	22330.285.171	1.1/8X505 (19.7/8)	1	22330.285.505	1.1/4X340 (13.3/8)	1	22330.317.340
1.1/8X175 (6.7/8)	1	22330.285.175	1.1/8X510 (20)	1	22330.285.508	1.1/4X345 (13.1/2)	1	22330.317.342
1.1/8X180 (7)	1	22330.285.177	1.1/8X515 (20.1/4)	1	22330.285.514	1.1/4X350 (13.3/4)	1	22330.317.349
1.1/8X185 (7.1/4)	1	22330.285.184	1.1/8X520 (20.1/2)	1	22330.285.520	1.1/4X355 (14)	1	22330.317.355
1.1/8X190 (7.1/2)	1	22330.285.190	1.1/8X525 (20.3/4)	1	22330.285.527	1.1/4X360 (14.1/4)	1	22330.317.361
1.1/8X195 (7.3/4)	1	22330.285.196	1.1/8X530 (20.7/8)	1	22330.285.530	1.1/4X365 (14.3/8)	1	22330.317.365
1.1/8X200 (8)	1	22330.285.203	1.1/8X540 (21.1/4)	1	22330.285.539	1.1/4X370 (14.1/2)	1	22330.317.368
1.1/8X205 (8.1/8)	1	22330.285.205	1.1/8X550 (21.3/4)	1	22330.285.550	1.1/4X375 (14.3/4)	1	22330.317.374
1.1/8X210 (8.1/4)	1	22330.285.209	1.1/8X560 (22)	1	22330.285.558	1.1/4X380 (15)	1	22330.317.381
1.1/8X215 (8.1/2)	1	22330.285.215	1.1/8X570 (22.1/2)	1	22330.285.571	1.1/4X385 (15.1/4)	1	22330.317.387
1.1/8X220 (8.3/4)	1	22330.285.222	1.1/8X585 (23)	1	22330.285.584	1.1/4X390 (15.3/8)	1	22330.317.390
1.1/8X230 (9)	1	22330.285.228	1.1/8X590 (23.1/4)	1	22330.285.590	1.1/4X395 (15.1/2)	1	22330.317.393
1.1/8X235 (9.1/4)	1	22330.285.234	1.1/8X610 (24)	1	22330.285.609	1.1/4X400 (15.3/4)	1	22330.317.400
1.1/8X240 (9.1/2)	1	22330.285.241	1.1/8X620 (24.1/2)	1	22330.285.622	1.1/4X405 (16)	1	22330.317.406
1.1/8X245 (9.5/8)	1	22330.285.245	1.1/8X800 (31.1/2)	1	22330.285.800	1.1/4X410 (16.1/8)	1	22330.317.410
1.1/8X250 (9.3/4)	1	22330.285.247				1.1/4X415 (16.1/4)	1	22330.317.412
1.1/8X285 (11.1/4)	1	22330.285.285	1.1/4X105 (4.1/8)	1	22330.317.105	1.1/4X420 (16.1/2)	1	22330.317.419
1.1/8X300 (11.3/4)	1	22330.285.298	1.1/4X125 (5)	1	22330.317.127	1.1/4X425 (16.3/4)	1	22330.317.425
1.1/8X305 (12)	1	22330.285.304	1.1/4X130 (5.1/8)	1	22330.317.130	1.1/4X430 (17)	1	22330.317.431
1.1/8X310 (12.1/4)	1	22330.285.311	1.1/4X135 (5.1/4)	1	22330.317.133	1.1/4X435 (17.1/8)	1	22330.317.435
1.1/8X320 (12.5/8)	1	22330.285.320	1.1/4X140 (5.1/2)	1	22330.317.139	1.1/4X440 (17.1/4)	1	22330.317.438
1.1/8X325 (12.3/4)	1	22330.285.323	1.1/4X145 (5.3/4)	1	22330.317.146	1.1/4X445 (17.1/2)	1	22330.317.444
1.1/8X330 (13)	1	22330.285.330	1.1/4X150 (6)	1	22330.317.152	1.1/4X450 (17.3/4)	1	22330.317.450
1.1/8X335 (13.1/4)	1	22330.285.336	1.1/4X155 (6.1/8)	1	22330.317.155	1.1/4X450 (18)	1	22330.317.457
1.1/8X340 (13.3/8)	1	22330.285.340	1.1/4X160 (6.1/4)	1	22330.317.158	1.1/4X460 (18.1/4)	1	22330.317.460
1.1/8X350 (13.3/4)	1	22330.285.349	1.1/4X165 (6.1/2)	1	22330.317.165	1.1/4X470 (18.1/4)	1	22330.317.463
1.1/8X355 (14)	1	22330.285.355	1.1/4X170 (6.3/4)	1	22330.317.171	1.1/4X470 (18.1/2)	1	22330.317.469
1.1/8X360 (14.1/4)	1	22330.285.361	1.1/4X175 (6.7/8)	1	22330.317.175	1.1/4X475 (18.3/4)	1	22330.317.476
1.1/8X365 (14.3/8)	1	22330.285.365	1.1/4X180 (7)	1	22330.317.177	1.1/4X480 (18.7/8)	1	22330.317.480
1.1/8X370 (14.1/2)	1	22330.285.368	1.1/4X185 (7.1/4)	1	22330.317.184	1.1/4X485 (19)	1	22330.317.482
1.1/8X375 (14.3/4)	1	22330.285.374	1.1/4X190 (7.1/2)	1	22330.317.190	1.1/4X490 (19.1/4)	1	22330.317.488
1.1/8X380 (15)	1	22330.285.381	1.1/4X195 (7.3/4)	1	22330.317.196	1.1/4X495 (19.1/2)	1	22330.317.495
1.1/8X385 (15.1/4)	1	22330.285.387	1.1/4X200 (8)	1	22330.317.203	1.1/4X500 (19.3/4)	1	22330.317.501
1.1/8X390 (15.3/8)	1	22330.285.390	1.1/4X205 (8.1/8)	1	22330.317.205	1.1/4X510 (20)	1	22330.317.508
1.1/8X395 (15.1/2)	1	22330.285.393	1.1/4X210 (8.1/4)	1	22330.317.209	1.1/4X520 (20.1/2)	1	22330.317.520
1.1/8X400 (15.3/4)	1	22330.285.400	1.1/4X215 (8.1/2)	1	22330.317.215	1.1/4X530 (20.7/8)	1	22330.317.530
1.1/8X405 (16)	1	22330.285.406	1.1/4X220 (8.3/4)	1	22330.317.222	1.1/4X540 (21.1/4)	1	22330.317.539
1.1/8X410 (16.1/8)	1	22330.285.410	1.1/4X225 (8.7/8)	1	22330.317.225	1.1/4X550 (21.3/4)	1	22330.317.550
1.1/8X415 (16.1/4)	1	22330.285.412	1.1/4X230 (9)	1	22330.317.228	1.1/4X560 (22)	1	22330.317.558
1.1/8X420 (16.1/2)	1	22330.285.419	1.1/4X235 (9.1/4)	1	22330.317.234	1.1/4X600 (23.5/8)	1	22330.317.600
1.1/8X425 (16.3/4)	1	22330.285.425	1.1/4X240 (9.1/2)	1	22330.317.241	1.1/4X610 (24)	1	22330.317.609
1.1/8X430 (17)	1	22330.285.431	1.1/4X245 (9.5/8)	1	22330.317.245	1.1/4X630 (24.3/4)	1	22330.317.628

22330 Śruby dwustronne z dwiema sześciokątnymi nakrętkami, 8UN

d x L mm (L Inch)	☒	Kod artykułu	d x L mm (L Inch)	☒	Kod artykułu	d x L mm (L Inch)	☒	Kod artykułu
1.1/4X650 (25.5/8)	1	22330.317.650	1.3/8X610 (24)	1	22330.349.609	1.5/8X275 (10.3/4)	1	22330.412.273
1.1/4X665 (26.1/4)	1	22330.317.666	1.3/8X670 (26.3/8)	1	22330.349.670	1.5/8X280 (11)	1	22330.412.279
1.1/4X690 (27.1/8)	1	22330.317.690	1.3/8X685 (27)	1	22330.349.685	1.5/8X285 (11.1/4)	1	22330.412.285
1.1/4X700 (27.1/2)	1	22330.317.698				1.5/8X290 (11.3/8)	1	22330.412.290
			1.1/2X140 (5.1/2)	1	22330.381.139	1.5/8X295 (11.1/2)	1	22330.412.292
1.3/8X150 (6)	1	22330.349.152	1.1/2X145 (5.3/4)	1	22330.381.146	1.5/8X300 (11.3/4)	1	22330.412.298
1.3/8X155 (6.1/8)	1	22330.349.155	1.1/2X150 (6)	1	22330.381.152	1.5/8X305 (12)	1	22330.412.304
1.3/8X160 (6.1/4)	1	22330.349.158	1.1/2X165 (6.1/2)	1	22330.381.165	1.5/8X310 (12.1/4)	1	22330.412.311
1.3/8X165 (6.1/2)	1	22330.349.165	1.1/2X170 (6.3/4)	1	22330.381.171	1.5/8X315 (12.1/2)	1	22330.412.317
1.3/8X170 (6.3/4)	1	22330.349.171	1.1/2X180 (7)	1	22330.381.177	1.5/8X320 (12.5/8)	1	22330.412.320
1.3/8X175 (6.7/8)	1	22330.349.175	1.1/2X185 (7.1/4)	1	22330.381.184	1.5/8X325 (12.3/4)	1	22330.412.323
1.3/8X180 (7)	1	22330.349.177	1.1/2X190 (7.1/2)	1	22330.381.190	1.5/8X330 (13)	1	22330.412.330
1.3/8X185 (7.1/4)	1	22330.349.184	1.1/2X195 (7.3/4)	1	22330.381.196	1.5/8X335 (13.1/4)	1	22330.412.336
1.3/8X195 (7.3/4)	1	22330.349.196	1.1/2X200 (8)	1	22330.381.203	1.5/8X340 (13.3/8)	1	22330.412.340
1.3/8X200 (8)	1	22330.349.203	1.1/2X205 (8.1/8)	1	22330.381.205	1.5/8X345 (13.1/2)	1	22330.412.342
1.3/8X205 (8.1/8)	1	22330.349.205	1.1/2X215 (8.1/2)	1	22330.381.215	1.5/8X350 (13.3/4)	1	22330.412.349
1.3/8X210 (8.1/4)	1	22330.349.209	1.1/2X220 (8.3/4)	1	22330.381.222	1.5/8X355 (14)	1	22330.412.355
1.3/8X215 (8.1/2)	1	22330.349.215	1.1/2X225 (8.7/8)	1	22330.381.225	1.5/8X360 (14.1/4)	1	22330.412.361
1.3/8X220 (8.3/4)	1	22330.349.222	1.1/2X230 (9)	1	22330.381.228	1.5/8X365 (14.3/8)	1	22330.412.365
1.3/8X225 (8.7/8)	1	22330.349.225	1.1/2X235 (9.1/4)	1	22330.381.234	1.5/8X370 (14.1/2)	1	22330.412.368
1.3/8X230 (9)	1	22330.349.228	1.1/2X240 (9.1/2)	1	22330.381.241	1.5/8X375 (14.3/4)	1	22330.412.374
1.3/8X235 (9.1/4)	1	22330.349.234	1.1/2X245 (9.5/8)	1	22330.381.245	1.5/8X380 (15)	1	22330.412.381
1.3/8X240 (9.1/2)	1	22330.349.241	1.1/2X250 (9.3/4)	1	22330.381.247	1.5/8X385 (15.1/4)	1	22330.412.387
1.3/8X245 (9.5/8)	1	22330.349.245	1.1/2X255 (10)	1	22330.381.254	1.5/8X390 (15.3/8)	1	22330.412.390
1.3/8X250 (9.3/4)	1	22330.349.247	1.1/2X260 (10.1/4)	1	22330.381.260	1.5/8X395 (15.1/2)	1	22330.412.393
1.3/8X255 (10)	1	22330.349.254	1.1/2X265 (10.1/2)	1	22330.381.266	1.5/8X400 (15.3/4)	1	22330.412.400
1.3/8X260 (10.1/4)	1	22330.349.260	1.1/2X270 (10.5/8)	1	22330.381.270	1.5/8X405 (16)	1	22330.412.406
1.3/8X265 (10.1/2)	1	22330.349.266	1.1/2X275 (10.3/4)	1	22330.381.273	1.5/8X410 (16.1/8)	1	22330.412.410
1.3/8X270 (10.5/8)	1	22330.349.270	1.1/2X280 (11)	1	22330.381.279	1.5/8X415 (16.1/4)	1	22330.412.412
1.3/8X275 (10.3/4)	1	22330.349.273	1.1/2X285 (11.1/4)	1	22330.381.285	1.5/8X420 (16.1/2)	1	22330.412.419
1.3/8X280 (11)	1	22330.349.279	1.1/2X290 (11.3/8)	1	22330.381.290	1.5/8X425 (16.3/4)	1	22330.412.425
1.3/8X285 (11.1/4)	1	22330.349.285	1.1/2X295 (11.1/2)	1	22330.381.292	1.5/8X430 (17)	1	22330.412.431
1.3/8X290 (11.3/8)	1	22330.349.290	1.1/2X300 (11.3/4)	1	22330.381.298	1.5/8X435 (17.1/8)	1	22330.412.435
1.3/8X295 (11.1/2)	1	22330.349.292	1.1/2X305 (12)	1	22330.381.304	1.5/8X440 (17.1/4)	1	22330.412.438
1.3/8X300 (11.3/4)	1	22330.349.298	1.1/2X310 (12.1/4)	1	22330.381.311	1.5/8X445 (17.1/2)	1	22330.412.444
1.3/8X305 (12)	1	22330.349.304	1.1/2X315 (12.1/2)	1	22330.381.317	1.5/8X450 (17.3/4)	1	22330.412.450
1.3/8X310 (12.1/4)	1	22330.349.311	1.1/2X320 (12.5/8)	1	22330.381.320	1.5/8X490 (19.1/4)	1	22330.412.488
1.3/8X315 (12.1/2)	1	22330.349.317	1.1/2X325 (12.3/4)	1	22330.381.323	1.5/8X495 (19.1/2)	1	22330.412.495
1.3/8X320 (12.5/8)	1	22330.349.320	1.1/2X330 (13)	1	22330.381.330	1.5/8X500 (19.3/4)	1	22330.412.501
1.3/8X325 (12.3/4)	1	22330.349.323	1.1/2X335 (13.1/4)	1	22330.381.336	1.5/8X530 (20.7/8)	1	22330.412.530
1.3/8X330 (13)	1	22330.349.330	1.1/2X340 (13.3/8)	1	22330.381.340	1.5/8X545 (21.1/2)	1	22330.412.546
1.3/8X335 (13.1/4)	1	22330.349.336	1.1/2X345 (13.1/2)	1	22330.381.342	1.5/8X685 (27)	1	22330.412.685
1.3/8X340 (13.3/8)	1	22330.349.340	1.1/2X350 (13.3/4)	1	22330.381.349			
1.3/8X345 (13.1/2)	1	22330.349.342	1.1/2X355 (14)	1	22330.381.355	1.3/4X155 (6.1/8)	1	22330.444.155
1.3/8X350 (13.3/4)	1	22330.349.349	1.1/2X360 (14.1/4)	1	22330.381.361	1.3/4X180 (7)	1	22330.444.177
1.3/8X355 (14)	1	22330.349.355	1.1/2X365 (14.3/8)	1	22330.381.365	1.3/4X200 (8)	1	22330.444.203
1.3/8X360 (14.1/4)	1	22330.349.361	1.1/2X370 (14.1/2)	1	22330.381.368	1.3/4X205 (8.1/8)	1	22330.444.205
1.3/8X365 (14.3/8)	1	22330.349.365	1.1/2X375 (14.3/4)	1	22330.381.374	1.3/4X210 (8.1/4)	1	22330.444.209
1.3/8X370 (14.1/2)	1	22330.349.368	1.1/2X380 (15)	1	22330.381.381	1.3/4X215 (8.1/2)	1	22330.444.215
1.3/8X375 (14.3/4)	1	22330.349.374	1.1/2X385 (15.1/4)	1	22330.381.387	1.3/4X220 (8.3/4)	1	22330.444.222
1.3/8X380 (15)	1	22330.349.381	1.1/2X390 (15.3/8)	1	22330.381.390	1.3/4X225 (8.7/8)	1	22330.444.225
1.3/8X385 (15.1/4)	1	22330.349.387	1.1/2X395 (15.1/2)	1	22330.381.393	1.3/4X230 (9)	1	22330.444.228
1.3/8X390 (15.3/8)	1	22330.349.390	1.1/2X400 (15.3/4)	1	22330.381.400	1.3/4X235 (9.1/4)	1	22330.444.234
1.3/8X395 (15.1/2)	1	22330.349.393	1.1/2X405 (16)	1	22330.381.406	1.3/4X240 (9.1/2)	1	22330.444.241
1.3/8X400 (15.3/4)	1	22330.349.400	1.1/2X410 (16.1/8)	1	22330.381.410	1.3/4X245 (9.5/8)	1	22330.444.245
1.3/8X405 (16)	1	22330.349.406	1.1/2X415 (16.1/4)	1	22330.381.412	1.3/4X250 (9.3/4)	1	22330.444.247
1.3/8X410 (16.1/8)	1	22330.349.410	1.1/2X420 (16.1/2)	1	22330.381.419	1.3/4X255 (10)	1	22330.444.254
1.3/8X415 (16.1/4)	1	22330.349.412	1.1/2X430 (17)	1	22330.381.431	1.3/4X260 (10.1/4)	1	22330.444.260
1.3/8X420 (16.1/2)	1	22330.349.419	1.1/2X440 (17.1/4)	1	22330.381.438	1.3/4X265 (10.1/2)	1	22330.444.266
1.3/8X425 (16.3/4)	1	22330.349.425	1.1/2X450 (17.3/4)	1	22330.381.450	1.3/4X270 (10.5/8)	1	22330.444.270
1.3/8X430 (17)	1	22330.349.431	1.1/2X455 (18)	1	22330.381.457	1.3/4X275 (10.3/4)	1	22330.444.273
1.3/8X435 (17.1/8)	1	22330.349.435	1.1/2X460 (18.1/8)	1	22330.381.460	1.3/4X280 (11)	1	22330.444.279
1.3/8X440 (17.1/4)	1	22330.349.438	1.1/2X480 (18.7/8)	1	22330.381.480	1.3/4X285 (11.1/4)	1	22330.444.285
1.3/8X445 (17.1/2)	1	22330.349.444	1.1/2X490 (19.1/4)	1	22330.381.488	1.3/4X290 (11.3/8)	1	22330.444.290
1.3/8X450 (17.3/4)	1	22330.349.450	1.1/2X500 (19.3/4)	1	22330.381.501	1.3/4X295 (11.1/2)	1	22330.444.292
1.3/8X455 (18)	1	22330.349.457	1.1/2X510 (20)	1	22330.381.508	1.3/4X300 (11.3/4)	1	22330.444.298
1.3/8X460 (18.1/8)	1	22330.349.460	1.1/2X525 (20.3/4)	1	22330.381.527	1.3/4X305 (12)	1	22330.444.304
1.3/8X465 (18.1/4)	1	22330.349.463	1.1/2X530 (20.7/8)	1	22330.381.530	1.3/4X310 (12.1/4)	1	22330.444.311
1.3/8X470 (18.1/2)	1	22330.349.469	1.1/2X545 (21.1/2)	1	22330.381.546	1.3/4X315 (12.1/2)	1	22330.444.317
1.3/8X475 (18.3/4)	1	22330.349.476	1.1/2X550 (21.3/4)	1	22330.381.552	1.3/4X320 (12.5/8)	1	22330.444.320
1.3/8X480 (18.7/8)	1	22330.349.480	1.1/2X560 (22)	1	22330.381.558	1.3/4X325 (12.3/4)	1	22330.444.323
1.3/8X485 (19)	1	22330.349.482	1.1/2X565 (22.1/4)	1	22330.381.565	1.3/4X330 (13)	1	22330.444.330
1.3/8X490 (19.1/4)	1	22330.349.488	1.1/2X600 (23.5/8)	1	22330.381.600	1.3/4X335 (13.1/4)	1	22330.444.336
1.3/8X495 (19.1/2)	1	22330.349.495	1.1/2X700 (27.1/2)	1	22330.381.698	1.3/4X340 (13.3/8)	1	22330.444.340
1.3/8X500 (19.3/4)	1	22330.349.501	1.1/2X810 (32)	1	22330.381.812	1.3/4X345 (13.1/2)	1	22330.444.342
1.3/8X520 (20.1/2)	1	22330.349.520				1.3/4X350 (13.3/4)	1	22330.444.349
1.3/8X530 (20.7/8)	1	22330.349.530	1.5/8X180 (7)	1	22330.412.177	1.3/4X355 (14)	1	22330.444.355
1.3/8X535 (21)	1	22330.349.533	1.5/8X190 (7.1/2)	1	22330.412.190	1.3/4X360 (14.1/4)	1	22330.444.361
1.3/8X545 (21.1/2)	1	22330.349.546	1.5/8X255 (10)	1	22330.412.254	1.3/4X365 (14.3/8)	1	22330.444.365
1.3/8X550 (21.3/4)	1	22330.349.552	1.5/8X260 (10.1/4)	1	22330.412.260	1.3/4X370 (14.1/2)	1	22330.444.368
1.3/8X555 (21.7/8)	1	22330.349.555	1.5/8X265 (10.1/2)	1	22330.412.26			

22330 Śruby dwustronne z dwiema sześciokątnymi nakrętkami, 8UN

d x L mm (L Inch)	☒	Kod artykułu	d x L mm (L Inch)	☒	Kod artykułu	d x L mm (L Inch)	☒	Kod artykułu
1.3/4X385 (15.1/4)	1	22330.444.387	1.7/8X485 (19)	1	22330.476.482	2.IN.X755 (29.3/4)	1	22330.508.755
1.3/4X390 (15.3/8)	1	22330.444.390	1.7/8X490 (19.1/4)	1	22330.476.488			
1.3/4X395 (15.1/2)	1	22330.444.393	1.7/8X495 (19.1/2)	1	22330.476.495	2.1/4X280 (11)	1	22330.571.279
1.3/4X400 (15.3/4)	1	22330.444.400	1.7/8X500 (19.3/4)	1	22330.476.501	2.1/4X375 (14.3/4)	1	22330.571.374
1.3/4X405 (16)	1	22330.444.406	1.7/8X510 (20)	1	22330.476.508	2.1/4X390 (15.3/8)	1	22330.571.390
1.3/4X410 (16.1/8)	1	22330.444.410	1.7/8X555 (21.7/8)	1	22330.476.555	2.1/4X405 (16)	1	22330.571.406
1.3/4X415 (16.1/4)	1	22330.444.412	1.7/8X560 (22)	1	22330.476.558	2.1/4X425 (16.3/4)	1	22330.571.425
1.3/4X420 (16.1/2)	1	22330.444.419	1.7/8X565 (22.1/4)	1	22330.476.565	2.1/4X430 (17)	1	22330.571.431
1.3/4X425 (16.3/4)	1	22330.444.425	1.7/8X600 (23.5/8)	1	22330.476.600	2.1/4X470 (18.1/2)	1	22330.571.469
1.3/4X430 (17)	1	22330.444.431	1.7/8X620 (24.1/2)	1	22330.476.622	2.1/4X485 (19)	1	22330.571.482
1.3/4X435 (17.1/8)	1	22330.444.435	1.7/8X675 (26.1/2)	1	22330.476.673	2.1/4X510 (20)	1	22330.571.508
1.3/4X440 (17.1/4)	1	22330.444.438	1.7/8X685 (27)	1	22330.476.685	2.1/4X520 (20.1/2)	1	22330.571.520
1.3/4X445 (17.1/2)	1	22330.444.444				2.1/4X550 (21.3/4)	1	22330.571.552
1.3/4X450 (17.3/4)	1	22330.444.450	2.IN.X205 (8.1/8)	1	22330.508.205	2.1/4X585 (23)	1	22330.571.584
1.3/4X455 (18)	1	22330.444.457	2.IN.X255 (10)	1	22330.508.254	2.1/4X590 (23.1/4)	1	22330.571.590
1.3/4X460 (18.1/8)	1	22330.444.460	2.IN.X305 (12)	1	22330.508.304	2.1/4X600 (23.5/8)	1	22330.571.600
1.3/4X470 (18.1/2)	1	22330.444.469	2.IN.X310 (12.1/4)	1	22330.508.311	2.1/4X695 (27.3/8)	1	22330.571.695
1.3/4X480 (18.7/8)	1	22330.444.480	2.IN.X315 (12.1/2)	1	22330.508.317	2.1/4X700 (27.1/2)	1	22330.571.698
1.3/4X485 (19)	1	22330.444.482	2.IN.X320 (12.5/8)	1	22330.508.320	2.1/4X870 (34.1/4)	1	22330.571.869
1.3/4X490 (19.1/4)	1	22330.444.488	2.IN.X325 (12.3/4)	1	22330.508.323			
1.3/4X495 (19.1/2)	1	22330.444.495	2.IN.X330 (13)	1	22330.508.330	2.1/2X380 (15)	1	22330.635.381
1.3/4X500 (19.3/4)	1	22330.444.501	2.IN.X335 (13.1/4)	1	22330.508.336	2.1/2X405 (16)	1	22330.635.406
1.3/4X510 (20)	1	22330.444.508	2.IN.X340 (13.3/8)	1	22330.508.340	2.1/2X435 (17.1/8)	1	22330.635.435
1.3/4X520 (20.1/2)	1	22330.444.520	2.IN.X345 (13.1/2)	1	22330.508.342	2.1/2X440 (17.1/4)	1	22330.635.438
1.3/4X570 (22.1/2)	1	22330.444.571	2.IN.X350 (13.3/4)	1	22330.508.349	2.1/2X445 (17.1/2)	1	22330.635.444
1.3/4X580 (22.7/8)	1	22330.444.580	2.IN.X355 (14)	1	22330.508.355	2.1/2X470 (18.1/2)	1	22330.635.469
1.3/4X595 (23.1/2)	1	22330.444.596	2.IN.X360 (14.1/4)	1	22330.508.361	2.1/2X485 (19)	1	22330.635.482
1.3/4X600 (23.5/8)	1	22330.444.600	2.IN.X365 (14.3/8)	1	22330.508.365	2.1/2X490 (19.1/4)	1	22330.635.488
1.3/4X610 (24)	1	22330.444.609	2.IN.X370 (14.1/2)	1	22330.508.368	2.1/2X495 (19.1/2)	1	22330.635.495
1.3/4X625 (24.5/8)	1	22330.444.625	2.IN.X375 (14.3/4)	1	22330.508.374	2.1/2X510 (20)	1	22330.635.508
1.3/4X650 (25.5/8)	1	22330.444.650	2.IN.X380 (15)	1	22330.508.381	2.1/2X520 (20.1/2)	1	22330.635.520
1.3/4X685 (27)	1	22330.444.685	2.IN.X385 (15.1/4)	1	22330.508.387	2.1/2X530 (20.7/8)	1	22330.635.530
1.3/4X710 (28)	1	22330.444.711	2.IN.X390 (15.3/8)	1	22330.508.390	2.1/2X535 (21)	1	22330.635.533
			2.IN.X395 (15.1/2)	1	22330.508.393	2.1/2X545 (21.1/2)	1	22330.635.546
1.7/8X255 (10)	1	22330.476.254	2.IN.X400 (15.3/4)	1	22330.508.400	2.1/2X560 (22)	1	22330.635.558
1.7/8X280 (11)	1	22330.476.279	2.IN.X405 (16)	1	22330.508.406	2.1/2X570 (22.1/2)	1	22330.635.571
1.7/8X305 (12)	1	22330.476.304	2.IN.X410 (16.1/8)	1	22330.508.410	2.1/2X585 (23)	1	22330.635.584
1.7/8X310 (12.1/4)	1	22330.476.311	2.IN.X415 (16.1/4)	1	22330.508.412	2.1/2X590 (23.1/4)	1	22330.635.590
1.7/8X315 (12.1/2)	1	22330.476.317	2.IN.X420 (16.1/2)	1	22330.508.419	2.1/2X600 (23.5/8)	1	22330.635.600
1.7/8X320 (12.5/8)	1	22330.476.320	2.IN.X425 (16.3/4)	1	22330.508.425	2.1/2X630 (24.3/4)	1	22330.635.628
1.7/8X325 (12.3/4)	1	22330.476.323	2.IN.X430 (17)	1	22330.508.431	2.1/2X650 (25.5/8)	1	22330.635.650
1.7/8X330 (13)	1	22330.476.330	2.IN.X435 (17.1/8)	1	22330.508.435	2.1/2X730 (28.3/4)	1	22330.635.730
1.7/8X335 (13.1/4)	1	22330.476.336	2.IN.X440 (17.1/4)	1	22330.508.438	2.1/2X780 (30.3/4)	1	22330.635.781
1.7/8X340 (13.3/8)	1	22330.476.340	2.IN.X445 (17.1/2)	1	22330.508.444	2.1/2X805 (31.3/4)	1	22330.635.806
1.7/8X345 (13.1/2)	1	22330.476.342	2.IN.X450 (17.3/4)	1	22330.508.450	2.1/2X845 (33.1/4)	1	22330.635.844
1.7/8X350 (13.3/4)	1	22330.476.349	2.IN.X455 (18)	1	22330.508.457	2.1/2X890 (35)	1	22330.635.889
1.7/8X355 (14)	1	22330.476.355	2.IN.X460 (18.1/8)	1	22330.508.460	2.1/2X950 (37.3/8)	1	22330.635.950
1.7/8X360 (14.1/4)	1	22330.476.361	2.IN.X465 (18.1/4)	1	22330.508.463			
1.7/8X365 (14.3/8)	1	22330.476.365	2.IN.X470 (18.1/2)	1	22330.508.469	2.3/4X450 (17.3/4)	1	22330.698.450
1.7/8X370 (14.1/2)	1	22330.476.368	2.IN.X475 (18.3/4)	1	22330.508.476	2.3/4X500 (19.3/4)	1	22330.698.501
1.7/8X375 (14.3/4)	1	22330.476.374	2.IN.X480 (18.7/8)	1	22330.508.480	2.3/4X520 (20.1/2)	1	22330.698.520
1.7/8X380 (15)	1	22330.476.381	2.IN.X485 (19)	1	22330.508.482	2.3/4X535 (21)	1	22330.698.533
1.7/8X385 (15.1/4)	1	22330.476.387	2.IN.X490 (19.1/4)	1	22330.508.488	2.3/4X600 (23.5/8)	1	22330.698.600
1.7/8X390 (15.3/8)	1	22330.476.390	2.IN.X495 (19.1/2)	1	22330.508.495	2.3/4X620 (24.1/2)	1	22330.698.622
1.7/8X395 (15.1/2)	1	22330.476.393	2.IN.X500 (19.3/4)	1	22330.508.501	2.3/4X630 (24.3/4)	1	22330.698.628
1.7/8X400 (15.3/4)	1	22330.476.400	2.IN.X510 (20)	1	22330.508.508	2.3/4X660 (26)	1	22330.698.660
1.7/8X405 (16)	1	22330.476.406	2.IN.X550 (21.3/4)	1	22330.508.552	2.3/4X690 (27.1/4)	1	22330.698.692
1.7/8X410 (16.1/8)	1	22330.476.410	2.IN.X565 (22.1/4)	1	22330.508.565	2.3/4X710 (28)	1	22330.698.711
1.7/8X415 (16.1/4)	1	22330.476.412	2.IN.X570 (22.1/2)	1	22330.508.571	2.3/4X720 (28.3/8)	1	22330.698.720
1.7/8X420 (16.1/2)	1	22330.476.419	2.IN.X595 (23.1/2)	1	22330.508.596	2.3/4X730 (28.3/4)	1	22330.698.730
1.7/8X425 (16.3/4)	1	22330.476.425	2.IN.X600 (23.5/8)	1	22330.508.600			
1.7/8X430 (17)	1	22330.476.431	2.IN.X645 (18.1/2)	1	22330.508.647	3.IN.X355 (14)	1	22330.762.355
1.7/8X435 (17.1/8)	1	22330.476.435	2.IN.X650 (25.5/8)	1	22330.508.650	3.IN.X475 (18.3/4)	1	22330.762.476
1.7/8X440 (17.1/4)	1	22330.476.438	2.IN.X655 (25.3/4)	1	22330.508.654	3.IN.X585 (23)	1	22330.762.584
1.7/8X445 (17.1/2)	1	22330.476.444	2.IN.X660 (26)	1	22330.508.660	3.IN.X590 (23.1/4)	1	22330.762.590
1.7/8X450 (17.3/4)	1	22330.476.450	2.IN.X670 (26.3/8)	1	22330.508.670	3.IN.X650 (25.5/8)	1	22330.762.650
1.7/8X455 (18)	1	22330.476.457	2.IN.X680 (26.3/4)	1	22330.508.679	3.IN.X660 (26)	1	22330.762.660
1.7/8X460 (18.1/8)	1	22330.476.460	2.IN.X690 (27.1/4)	1	22330.508.692	3.IN.X700 (27.1/2)	1	22330.762.698
1.7/8X465 (18.1/4)	1	22330.476.463	2.IN.X700 (27.1/2)	1	22330.508.698	3.IN.X710 (28)	1	22330.762.711
1.7/8X470 (18.1/2)	1	22330.476.469	2.IN.X710 (28)	1	22330.508.711	3.IN.X735 (29)	1	22330.762.736
1.7/8X475 (18.3/4)	1	22330.476.476	2.IN.X740 (29.1/4)	1	22330.508.742	3.IN.X800 (31.1/2)	1	22330.762.800
1.7/8X480 (18.7/8)	1	22330.476.480	2.IN.X750 (29.1/2)	1	22330.508.749	3.IN.X850 (33.1/2)	1	22330.762.850

Gwint Calowy, zunifikowany grubozwojny (UNC)
Materiał Stal nierdzewna ASTM A193 - ASTM A194
Klasa Gr.B8 Cl.1 - Gr.8

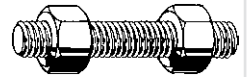
4

d x L mm (L Inch)	☒	Kod artykułu	d x L mm (L Inch)	☒	Kod artykułu	d x L mm (L Inch)	☒	Kod artykułu
3/8X25 (1)	1	22534.096.025	5/8X140 (5.1/2)	1	22534.158.139	3/4X200 (8)	1	22534.191.203
3/8X30 (1.1/4)	1	22534.096.031	5/8X145 (5.3/4)	1	22534.158.146	3/4X205 (8.1/8)	1	22534.191.205
3/8X40 (1.1/2)	1	22534.096.038	5/8X150 (6)	1	22534.158.152	3/4X210 (8.1/4)	1	22534.191.209
3/8X45 (1.3/4)	1	22534.096.044	5/8X155 (6.1/8)	1	22534.158.155	3/4X215 (8.1/2)	1	22534.191.215
3/8X60 (2.3/8)	1	22534.096.060	5/8X160 (6.1/4)	1	22534.158.158	3/4X220 (8.3/4)	1	22534.191.222
3/8X65 (2.1/2)	1	22534.096.063	5/8X165 (6.1/2)	1	22534.158.165	3/4X225 (8.7/8)	1	22534.191.225
3/8X70 (2.3/4)	1	22534.096.069	5/8X170 (6.3/4)	1	22534.158.171	3/4X230 (9)	1	22534.191.228
3/8X80 (3.1/4)	1	22534.096.082	5/8X175 (6.7/8)	1	22534.158.175	3/4X235 (9.1/4)	1	22534.191.234
3/8X95 (3.3/4)	1	22534.096.095	5/8X180 (7)	1	22534.158.177	3/4X240 (9.1/2)	1	22534.191.241
3/8X100 (4)	1	22534.096.101	5/8X185 (7.1/4)	1	22534.158.184	3/4X245 (9.5/8)	1	22534.191.245
3/8X150 (6)	1	22534.096.152	5/8X190 (7.1/2)	1	22534.158.190	3/4X250 (9.3/4)	1	22534.191.247
3/8X175 (6.7/8)	1	22534.096.175	5/8X195 (7.3/4)	1	22534.158.196	3/4X255 (10)	1	22534.191.254
3/8X185 (7.1/4)	1	22534.096.184	5/8X200 (8)	1	22534.158.203	3/4X260 (10.1/4)	1	22534.191.260
3/8X215 (8.1/2)	1	22534.096.215	5/8X205 (8.1/8)	1	22534.158.205	3/4X265 (10.1/2)	1	22534.191.266
			5/8X210 (8.1/4)	1	22534.158.209	3/4X270 (10.5/8)	1	22534.191.270
1/2X40 (1.1/2)	1	22534.127.038	5/8X215 (8.1/2)	1	22534.158.215	3/4X275 (10.3/4)	1	22534.191.273
1/2X45 (1.3/4)	1	22534.127.044	5/8X220 (8.3/4)	1	22534.158.222	3/4X280 (11)	1	22534.191.279
1/2X50 (2)	1	22534.127.050	5/8X225 (8.7/8)	1	22534.158.225	3/4X285 (11.1/4)	1	22534.191.285
1/2X55 (2.1/4)	1	22534.127.057	5/8X230 (9)	1	22534.158.228	3/4X290 (11.3/8)	1	22534.191.290
1/2X60 (2.3/8)	1	22534.127.060	5/8X235 (9.1/4)	1	22534.158.234	3/4X295 (11.1/2)	1	22534.191.292
1/2X65 (2.1/2)	1	22534.127.063	5/8X240 (9.1/2)	1	22534.158.241	3/4X300 (11.3/4)	1	22534.191.298
1/2X70 (2.3/4)	1	22534.127.069	5/8X245 (9.5/8)	1	22534.158.245	3/4X305 (12)	1	22534.191.304
1/2X75 (3)	1	22534.127.076	5/8X250 (9.3/4)	1	22534.158.247	3/4X310 (12.1/4)	1	22534.191.311
1/2X80 (3.1/4)	1	22534.127.082	5/8X255 (10)	1	22534.158.254	3/4X315 (12.1/2)	1	22534.191.317
1/2X85 (3.3/8)	1	22534.127.085	5/8X260 (10.1/4)	1	22534.158.260	3/4X320 (12.3/8)	1	22534.191.320
1/2X90 (3.1/2)	1	22534.127.088	5/8X265 (10.1/2)	1	22534.158.266	3/4X325 (12.3/4)	1	22534.191.323
1/2X95 (3.3/4)	1	22534.127.095	5/8X270 (10.5/8)	1	22534.158.270	3/4X330 (13)	1	22534.191.330
1/2X100 (4)	1	22534.127.101	5/8X275 (10.3/4)	1	22534.158.273	3/4X335 (13.1/4)	1	22534.191.336
1/2X105 (4.1/8)	1	22534.127.105	5/8X280 (11)	1	22534.158.279	3/4X340 (13.3/8)	1	22534.191.340
1/2X110 (4.1/4)	1	22534.127.107	5/8X285 (11.1/4)	1	22534.158.285	3/4X345 (13.1/2)	1	22534.191.342
1/2X115 (4.1/2)	1	22534.127.114	5/8X290 (11.3/8)	1	22534.158.290	3/4X350 (13.3/4)	1	22534.191.349
1/2X120 (4.3/4)	1	22534.127.120	5/8X295 (11.1/2)	1	22534.158.292	3/4X355 (14)	1	22534.191.355
1/2X125 (5)	1	22534.127.127	5/8X300 (11.3/4)	1	22534.158.298	3/4X360 (14.1/4)	1	22534.191.361
1/2X130 (5.1/8)	1	22534.127.130	5/8X305 (12)	1	22534.158.304	3/4X365 (14.3/8)	1	22534.191.365
1/2X135 (5.1/4)	1	22534.127.133	5/8X310 (12.1/4)	1	22534.158.311	3/4X370 (14.1/2)	1	22534.191.368
1/2X140 (5.1/2)	1	22534.127.139	5/8X315 (12.1/2)	1	22534.158.317	3/4X375 (14.3/4)	1	22534.191.374
1/2X145 (5.3/4)	1	22534.127.146	5/8X320 (12.5/8)	1	22534.158.320	3/4X380 (15)	1	22534.191.381
1/2X150 (6)	1	22534.127.152	5/8X325 (12.3/4)	1	22534.158.323	3/4X385 (15.1/4)	1	22534.191.387
1/2X155 (6.1/8)	1	22534.127.155	5/8X330 (13)	1	22534.158.330	3/4X390 (15.3/8)	1	22534.191.390
1/2X160 (6.1/4)	1	22534.127.158	5/8X335 (13.1/4)	1	22534.158.336	3/4X395 (15.1/2)	1	22534.191.393
1/2X165 (6.1/2)	1	22534.127.165	5/8X340 (13.3/8)	1	22534.158.340	3/4X400 (15.3/4)	1	22534.191.400
1/2X170 (6.3/4)	1	22534.127.171	5/8X370 (14.1/2)	1	22534.158.368	3/4X405 (16)	1	22534.191.406
1/2X175 (6.7/8)	1	22534.127.175	5/8X375 (14.3/4)	1	22534.158.374	3/4X410 (16.1/8)	1	22534.191.410
1/2X180 (7)	1	22534.127.177	5/8X385 (15.1/4)	1	22534.158.387	3/4X415 (16.1/4)	1	22534.191.412
1/2X185 (7.1/4)	1	22534.127.184				3/4X420 (16.1/2)	1	22534.191.419
1/2X190 (7.1/2)	1	22534.127.190	3/4X50 (2)	1	22534.191.050	3/4X430 (17)	1	22534.191.431
1/2X195 (7.3/4)	1	22534.127.196	3/4X55 (2.1/4)	1	22534.191.057	3/4X440 (17.1/4)	1	22534.191.438
1/2X200 (8)	1	22534.127.203	3/4X60 (2.3/8)	1	22534.191.060	3/4X450 (17.3/4)	1	22534.191.450
1/2X205 (8.1/8)	1	22534.127.205	3/4X65 (2.1/2)	1	22534.191.063	3/4X455 (18)	1	22534.191.457
1/2X210 (8.1/4)	1	22534.127.209	3/4X70 (2.3/4)	1	22534.191.069	3/4X470 (18.1/2)	1	22534.191.469
1/2X225 (8.7/8)	1	22534.127.225	3/4X75 (3)	1	22534.191.076	3/4X480 (18.7/8)	1	22534.191.480
1/2X230 (9)	1	22534.127.228	3/4X80 (3.1/4)	1	22534.191.082	3/4X485 (19)	1	22534.191.482
1/2X250 (9.3/4)	1	22534.127.247	3/4X85 (3.3/8)	1	22534.191.085	3/4X580 (22.7/8)	1	22534.191.580
1/2X280 (11)	1	22534.127.279	3/4X90 (3.1/2)	1	22534.191.088	3/4X625 (24.5/8)	1	22534.191.625
			3/4X95 (3.3/4)	1	22534.191.095			
5/8X40 (1.1/2)	1	22534.158.038	3/4X100 (4)	1	22534.191.101	7/8X70 (2.3/4)	1	22534.222.069
5/8X45 (1.3/4)	1	22534.158.044	3/4X105 (4.1/8)	1	22534.191.105	7/8X75 (3)	1	22534.222.076
5/8X50 (2)	1	22534.158.050	3/4X110 (4.1/4)	1	22534.191.107	7/8X80 (3.1/4)	1	22534.222.082
5/8X55 (2.1/4)	1	22534.158.057	3/4X115 (4.1/2)	1	22534.191.114	7/8X85 (3.3/8)	1	22534.222.085
5/8X60 (2.3/8)	1	22534.158.060	3/4X120 (4.3/4)	1	22534.191.120	7/8X90 (3.1/2)	1	22534.222.088
5/8X65 (2.1/2)	1	22534.158.063	3/4X125 (5)	1	22534.191.127	7/8X95 (3.3/4)	1	22534.222.095
5/8X70 (2.3/4)	1	22534.158.069	3/4X130 (5.1/8)	1	22534.191.130	7/8X100 (4)	1	22534.222.101
5/8X75 (3)	1	22534.158.076	3/4X135 (5.1/4)	1	22534.191.133	7/8X105 (4.1/8)	1	22534.222.105
5/8X80 (3.1/4)	1	22534.158.082	3/4X140 (5.1/2)	1	22534.191.139	7/8X110 (4.1/4)	1	22534.222.107
5/8X85 (3.3/8)	1	22534.158.085	3/4X145 (5.3/4)	1	22534.191.146	7/8X115 (4.1/2)	1	22534.222.114
5/8X90 (3.1/2)	1	22534.158.088	3/4X150 (6.IN.)	1	22534.191.152	7/8X120 (4.3/4)	1	22534.222.120
5/8X95 (3.3/4)	1	22534.158.095	3/4X155 (6.1/8)	1	22534.191.155	7/8X125 (5)	1	22534.222.127
5/8X100 (4)	1	22534.158.101	3/4X160 (6.1/4)	1	22534.191.158	7/8X130 (5.1/8)	1	22534.222.130
5/8X105 (4.1/8)	1	22534.158.105	3/4X165 (6.1/2)	1	22534.191.165	7/8X135 (5.1/4)	1	22534.222.133
5/8X110 (4.1/4)	1	22534.158.107	3/4X170 (6.3/4)	1	22534.191.171	7/8X140 (5.1/2)	1	22534.222.139
5/8X115 (4.1/2)	1	22534.158.114	3/4X175 (6.7/8)	1	22534.191.175	7/8X145 (5.3/4)	1	22534.222.146
5/8X120 (4.3/4)	1	22534.158.120	3/4X180 (7)	1	22534.191.177	7/8X150 (6)	1	22534.222.152
5/8X125 (5)	1	22534.158.127	3/4X185 (7.1/4)	1	22534.191.184	7/8X155 (6.1/8)	1	22534.222.155
5/8X130 (5.1/8)	1	22534.158.130	3/4X190 (7.1/2)	1	22534.191.190	7/8X160 (6.1/4)	1	22534.222.158
5/8X135 (5.1/4)	1	22534.158.133	3/4X195 (7.3/4)	1	22534.191.196	7/8X165 (6.1/2)	1	22534.222.165

22534 Śruby dwustronne z dwiema sześciokątnymi nakrętkami, UNC								
d x L mm (L Inch)	☒	Kod artykułu	d x L mm (L Inch)	☒	Kod artykułu	d x L mm (L Inch)	☒	Kod artykułu
7/8X170 (6.3/4)	1	22534.222.171	7/8X415 (16.1/4)	1	22534.222.412	1.IN.X255 (10)	1	22534.254.254
7/8X175 (6.7/8)	1	22534.222.175	7/8X420 (16.1/2)	1	22534.222.419	1.IN.X260 (10.1/4)	1	22534.254.260
7/8X180 (7)	1	22534.222.177	7/8X425 (16.3/4)	1	22534.222.425	1.IN.X265 (10.1/2)	1	22534.254.266
7/8X185 (7.1/4)	1	22534.222.184	7/8X430 (17)	1	22534.222.431	1.IN.X270 (10.5/8)	1	22534.254.270
7/8X190 (7.1/2)	1	22534.222.190	7/8X440 (17.1/4)	1	22534.222.438	1.IN.X275 (10.3/4)	1	22534.254.273
7/8X195 (7.3/4)	1	22534.222.196	7/8X450 (17.3/4)	1	22534.222.450	1.IN.X280 (11)	1	22534.254.279
7/8X200 (8)	1	22534.222.203	7/8X455 (18)	1	22534.222.457	1.IN.X285 (11.1/4)	1	22534.254.285
7/8X205 (8.1/8)	1	22534.222.205	7/8X470 (18.1/2)	1	22534.222.469	1.IN.X290 (11.3/8)	1	22534.254.290
7/8X210 (8.1/4)	1	22534.222.209	7/8X485 (19)	1	22534.222.482	1.IN.X295 (11.1/2)	1	22534.254.292
7/8X215 (8.1/2)	1	22534.222.215	7/8X495 (19.1/2)	1	22534.222.495	1.IN.X300 (11.3/4)	1	22534.254.298
7/8X220 (8.3/4)	1	22534.222.222	7/8X510 (20)	1	22534.222.508	1.IN.X305 (12)	1	22534.254.304
7/8X225 (8.7/8)	1	22534.222.225	7/8X515 (20.1/4)	1	22534.222.514	1.IN.X310 (12.1/4)	1	22534.254.311
7/8X230 (9)	1	22534.222.228	7/8X525 (20.3/4)	1	22534.222.527	1.IN.X315 (12.1/2)	1	22534.254.317
7/8X235 (9.1/4)	1	22534.222.234	1.IN.X80 (3.1/4)	1	22534.254.082	1.IN.X320 (12.5/8)	1	22534.254.320
7/8X240 (9.1/2)	1	22534.222.241	1.IN.X85 (3.3/8)	1	22534.254.085	1.IN.X325 (12.3/4)	1	22534.254.323
7/8X245 (9.5/8)	1	22534.222.245	1.IN.X90 (3.1/2)	1	22534.254.088	1.IN.X330 (13)	1	22534.254.330
7/8X250 (9.3/4)	1	22534.222.247	1.IN.X95 (3.3/4)	1	22534.254.095	1.IN.X335 (13.1/4)	1	22534.254.336
7/8X255 (10)	1	22534.222.254	1.IN.X100 (4)	1	22534.254.101	1.IN.X340 (13.3/8)	1	22534.254.340
7/8X260 (10.1/4)	1	22534.222.260	1.IN.X105 (4.1/8)	1	22534.254.105	1.IN.X345 (13.1/2)	1	22534.254.342
7/8X265 (10.1/2)	1	22534.222.266	1.IN.X110 (4.1/4)	1	22534.254.107	1.IN.X350 (13.3/4)	1	22534.254.349
7/8X270 (10.5/8)	1	22534.222.270	1.IN.X115 (4.1/2)	1	22534.254.114	1.IN.X355 (14)	1	22534.254.355
7/8X275 (10.3/4)	1	22534.222.273	1.IN.X120 (4.3/4)	1	22534.254.114	1.IN.X360 (14.1/4)	1	22534.254.361
7/8X280 (11)	1	22534.222.279	1.IN.X125 (5)	1	22534.254.127	1.IN.X365 (14.3/8)	1	22534.254.365
7/8X285 (11.1/4)	1	22534.222.285	1.IN.X130 (5.1/8)	1	22534.254.130	1.IN.X370 (14.1/2)	1	22534.254.368
7/8X290 (11.3/8)	1	22534.222.290	1.IN.X135 (5.1/4)	1	22534.254.133	1.IN.X375 (14.3/4)	1	22534.254.374
7/8X295 (11.1/2)	1	22534.222.292	1.IN.X140 (5.1/2)	1	22534.254.139	1.IN.X380 (15)	1	22534.254.381
7/8X300 (11.3/4)	1	22534.222.298	1.IN.X145 (5.3/4)	1	22534.254.146	1.IN.X385 (15.1/4)	1	22534.254.387
7/8X305 (12)	1	22534.222.304	1.IN.X150 (6)	1	22534.254.152	1.IN.X390 (15.3/8)	1	22534.254.390
7/8X310 (12.1/4)	1	22534.222.311	1.IN.X155 (6.1/8)	1	22534.254.155	1.IN.X395 (15.1/2)	1	22534.254.393
7/8X315 (12.1/2)	1	22534.222.317	1.IN.X160 (6.1/4)	1	22534.254.158	1.IN.X400 (15.3/4)	1	22534.254.400
7/8X320 (12.5/8)	1	22534.222.320	1.IN.X165 (6.1/2)	1	22534.254.165	1.IN.X405 (16)	1	22534.254.406
7/8X325 (12.3/4)	1	22534.222.323	1.IN.X170 (6.3/4)	1	22534.254.171	1.IN.X410 (16.1/8)	1	22534.254.410
7/8X330 (13)	1	22534.222.330	1.IN.X175 (6.7/8)	1	22534.254.175	1.IN.X415 (16.1/4)	1	22534.254.412
7/8X335 (13.1/4)	1	22534.222.336	1.IN.X180 (7)	1	22534.254.177	1.IN.X420 (16.1/2)	1	22534.254.419
7/8X340 (13.3/8)	1	22534.222.340	1.IN.X185 (7.1/4)	1	22534.254.184	1.IN.X425 (16.3/4)	1	22534.254.425
7/8X345 (13.1/2)	1	22534.222.342	1.IN.X190 (7.1/2)	1	22534.254.190	1.IN.X430 (17)	1	22534.254.431
7/8X350 (13.3/4)	1	22534.222.349	1.IN.X195 (7.3/4)	1	22534.254.196	1.IN.X435 (17.1/8)	1	22534.254.435
7/8X355 (14)	1	22534.222.355	1.IN.X200 (8)	1	22534.254.203	1.IN.X440 (17.1/4)	1	22534.254.438
7/8X360 (14.1/4)	1	22534.222.361	1.IN.X205 (8.1/8)	1	22534.254.205	1.IN.X445 (17.1/2)	1	22534.254.444
7/8X365 (14.3/8)	1	22534.222.365	1.IN.X210 (8.1/4)	1	22534.254.209	1.IN.X450 (17.3/4)	1	22534.254.450
7/8X370 (14.1/2)	1	22534.222.368	1.IN.X215 (8.1/2)	1	22534.254.215	1.IN.X455 (18)	1	22534.254.457
7/8X375 (14.3/4)	1	22534.222.375	1.IN.X220 (8.3/4)	1	22534.254.222	1.IN.X460 (18.1/8)	1	22534.254.460
7/8X380 (15)	1	22534.222.381	1.IN.X225 (8.7/8)	1	22534.254.225	1.IN.X470 (18.1/2)	1	22534.254.469
7/8X385 (15.1/4)	1	22534.222.382	1.IN.X230 (9)	1	22534.254.228	1.IN.X485 (19)	1	22534.254.482
7/8X390 (15.3/8)	1	22534.222.390	1.IN.X235 (9.1/4)	1	22534.254.234	1.IN.X505 (19.7/8)	1	22534.254.505
7/8X395 (15.1/2)	1	22534.222.393	1.IN.X240 (9.1/2)	1	22534.254.241	1.IN.X515 (20.1/4)	1	22534.254.514
7/8X400 (15.3/4)	1	22534.222.400	1.IN.X245 (9.5/8)	1	22534.254.245	1.IN.X520 (20.1/2)	1	22534.254.520
7/8X405 (16)	1	22534.222.406	1.IN.X250 (9.3/4)	1	22534.254.247	1.IN.X595 (23.1/2)	1	22534.254.596
7/8X410 (16.1/8)	1	22534.222.410				1.IN.X730 (28.3/4)	1	22534.254.730

4

22538 Śruby dwustronne z dwiema sześciokątnymi nakrętkami, niemetyczne G12A

Gwint	Całowy, zunifikowany gruboźwojny (UNC)
Materiał	Stal nierdzewna ASTM A193 - ASTM A194
Klasa	Gr.8/8M Cl.2 - Gr.8M

d x L mm (L Inch)	☒	Kod artykułu	d x L mm (L Inch)	☒	Kod artykułu	d x L mm (L Inch)	☒	Kod artykułu
3/8X25 (1)	1	22538.096.025	1/2X70 (2.3/4)	1	22538.127.069	1/2X175 (6.7/8)	1	22538.127.175
3/8X40 (1.1/2)	1	22538.096.038	1/2X75 (3)	1	22538.127.076	1/2X180 (7)	1	22538.127.177
3/8X45 (1.3/4)	1	22538.096.044	1/2X80 (3.1/4)	1	22538.127.082	1/2X185 (7.1/4)	1	22538.127.184
3/8X55 (2.1/4)	1	22538.096.057	1/2X85 (3.3/8)	1	22538.127.085	1/2X190 (7.1/2)	1	22538.127.190
3/8X60 (2.3/8)	1	22538.096.060	1/2X90 (3.1/2)	1	22538.127.088	1/2X195 (7.3/4)	1	22538.127.196
3/8X65 (2.1/2)	1	22538.096.063	1/2X95 (3.3/4)	1	22538.127.095	1/2X200 (8)	1	22538.127.203
3/8X70 (2.3/4)	1	22538.096.069	1/2X100 (4)	1	22538.127.101	1/2X205 (8.1/8)	1	22538.127.205
3/8X75 (3)	1	22538.096.076	1/2X105 (4.1/8)	1	22538.127.105	1/2X210 (8.1/4)	1	22538.127.209
3/8X80 (3.1/4)	1	22538.096.082	1/2X110 (4.1/4)	1	22538.127.107	1/2X215 (8.1/2)	1	22538.127.215
3/8X95 (3.3/4)	1	22538.096.095	1/2X115 (4.1/2)	1	22538.127.114	1/2X220 (8.3/4)	1	22538.127.222
3/8X100 (4)	1	22538.096.101	1/2X120 (4.3/4)	1	22538.127.120	1/2X225 (8.7/8)	1	22538.127.225
3/8X175 (6.7/8)	1	22538.096.175	1/2X125 (5)	1	22538.127.127	1/2X230 (9)	1	22538.127.228
3/8X185 (7.1/4)	1	22538.096.184	1/2X130 (5.1/8)	1	22538.127.130	1/2X235 (9.1/4)	1	22538.127.234
1/2X30 (1.1/4)	1	22538.127.031	1/2X135 (5.1/4)	1	22538.127.133	1/2X240 (9.1/2)	1	22538.127.241
1/2X40 (1.1/2)	1	22538.127.038	1/2X140 (5.1/2)	1	22538.127.139	1/2X245 (9.5/8)	1	22538.127.245
1/2X45 (1.3/4)	1	22538.127.044	1/2X145 (5.3/4)	1	22538.127.146	1/2X250 (9.3/4)	1	22538.127.247
1/2X50 (2)	1	22538.127.050	1/2X150 (6)	1	22538.127.152	1/2X255 (10)	1	22538.127.254
1/2X55 (2.1/4)	1	22538.127.057	1/2X155 (6.1/8)	1	22538.127.155	1/2X260 (10.1/4)	1	22538.127.260
1/2X60 (2.3/8)	1	22538.127.060	1/2X160 (6.1/4)	1	22538.127.158	1/2X265 (10.1/2)	1	22538.127.266
1/2X65 (2.1/2)	1	22538.127.063	1/2X165 (6.1/2)	1	22538.127.165	1/2X270 (10.5/8)	1	22538.127.270
			1/2X170 (6.3/4)	1	22538.127.171	1/2X275 (10.3/4)	1	22538.127.273

22538 Śruby dwustronne z dwiema sześciokątnymi nakrętkami, niemetryczne

d x L mm (L Inch)	☒	Kod artykułu	d x L mm (L Inch)	☒	Kod artykułu	d x L mm (L Inch)	☒	Kod artykułu
1/2X280 (11)	1	22538.127.279	5/8X320 (12.5/8)	1	22538.158.320	3/4X350 (13.3/4)	1	22538.191.349
1/2X285 (11.1/4)	1	22538.127.285	5/8X325 (12.3/4)	1	22538.158.323	3/4X355 (14)	1	22538.191.355
1/2X290 (11.3/8)	1	22538.127.290	5/8X325 (12.3/4)	1	22538.158.326	3/4X360 (14.1/4)	1	22538.191.361
1/2X295 (11.1/2)	1	22538.127.292	5/8X330 (13)	1	22538.158.330	3/4X365 (14.3/8)	1	22538.191.365
1/2X300 (11.3/4)	1	22538.127.298	5/8X335 (13.1/4)	1	22538.158.336	3/4X370 (14.1/2)	1	22538.191.368
1/2X305 (12)	1	22538.127.304	5/8X335 (13.1/4)	1	22538.158.337	3/4X375 (14.3/4)	1	22538.191.374
1/2X310 (12.1/4)	1	22538.127.311	5/8X340 (13.3/8)	1	22538.158.340	3/4X380 (15)	1	22538.191.381
1/2X315 (12.1/2)	1	22538.127.317	5/8X345 (13.1/2)	1	22538.158.342	3/4X385 (15.1/4)	1	22538.191.387
1/2X320 (12.5/8)	1	22538.127.320	5/8X350 (13.3/4)	1	22538.158.349	3/4X390 (15.3/8)	1	22538.191.390
1/2X325 (12.3/4)	1	22538.127.326	5/8X355 (14)	1	22538.158.355	3/4X395 (15.1/2)	1	22538.191.393
1/2X330 (13)	1	22538.127.330	5/8X360 (14.1/4)	1	22538.158.361	3/4X400 (15.3/4)	1	22538.191.400
1/2X335 (13.1/4)	1	22538.127.336	5/8X365 (14.3/8)	1	22538.158.365	3/4X405 (16)	1	22538.191.406
1/2X340 (13.3/8)	1	22538.127.340	5/8X370 (14.1/2)	1	22538.158.368	3/4X410 (16.1/8)	1	22538.191.410
1/2X345 (13.1/2)	1	22538.127.342	5/8X375 (14.3/4)	1	22538.158.374	3/4X415 (16.1/4)	1	22538.191.412
1/2X350 (13.3/4)	1	22538.127.349	5/8X380 (15)	1	22538.158.381	3/4X420 (16.1/2)	1	22538.191.419
1/2X355 (14)	1	22538.127.355	5/8X385 (15.1/4)	1	22538.158.387	3/4X430 (17)	1	22538.191.431
1/2X360 (14.1/4)	1	22538.127.361	5/8X390 (15.3/8)	1	22538.158.390	3/4X440 (17.1/4)	1	22538.191.438
1/2X365 (14.3/8)	1	22538.127.365	5/8X395 (15.1/2)	1	22538.158.393	3/4X450 (17.3/4)	1	22538.191.450
1/2X370 (14.1/2)	1	22538.127.368	5/8X400 (15.3/4)	1	22538.158.400	3/4X455 (18)	1	22538.191.457
1/2X375 (14.3/4)	1	22538.127.374				3/4X470 (18.1/2)	1	22538.191.469
1/2X380 (15)	1	22538.127.381	3/4X50 (2)	1	22538.191.050	3/4X480 (18.7/8)	1	22538.191.480
1/2X385 (15.1/4)	1	22538.127.387	3/4X55 (2.1/4)	1	22538.191.057	3/4X485 (19)	1	22538.191.482
1/2X390 (15.3/8)	1	22538.127.390	3/4X60 (2.3/8)	1	22538.191.060	3/4X580 (22.7/8)	1	22538.191.580
1/2X395 (15.1/2)	1	22538.127.393	3/4X65 (2.1/2)	1	22538.191.063	3/4X625 (24.5/8)	1	22538.191.625
1/2X400 (15.3/4)	1	22538.127.400	3/4X70 (2.3/4)	1	22538.191.069			
			3/4X75 (3)	1	22538.191.076	7/8X70 (2.3/4)	1	22538.222.069
5/8X40 (1.1/2)	1	22538.158.038	3/4X80 (3.1/4)	1	22538.191.082	7/8X75 (3)	1	22538.222.076
5/8X45 (1.3/4)	1	22538.158.044	3/4X85 (3.3/8)	1	22538.191.085	7/8X80 (3.1/4)	1	22538.222.082
5/8X50 (2)	1	22538.158.050	3/4X90 (3.1/2)	1	22538.191.088	7/8X85 (3.3/8)	1	22538.222.085
5/8X55 (2.1/4)	1	22538.158.057	3/4X95 (3.3/4)	1	22538.191.095	7/8X90 (3.1/2)	1	22538.222.088
5/8X60 (2.3/8)	1	22538.158.060	3/4X100 (4)	1	22538.191.101	7/8X95 (3.3/4)	1	22538.222.095
5/8X65 (2.1/2)	1	22538.158.063	3/4X105 (4.1/8)	1	22538.191.105	7/8X100 (4)	1	22538.222.101
5/8X70 (2.3/4)	1	22538.158.069	3/4X110 (4.1/4)	1	22538.191.107	7/8X105 (4.1/8)	1	22538.222.105
5/8X75 (3)	1	22538.158.076	3/4X115 (4.1/2)	1	22538.191.114	7/8X110 (4.1/4)	1	22538.222.107
5/8X80 (3.1/4)	1	22538.158.082	3/4X120 (4.3/4)	1	22538.191.120	7/8X115 (4.1/2)	1	22538.222.114
5/8X85 (3.3/8)	1	22538.158.085	3/4X125 (5)	1	22538.191.127	7/8X120 (4.3/4)	1	22538.222.120
5/8X90 (3.1/2)	1	22538.158.088	3/4X130 (5.1/8)	1	22538.191.130	7/8X125 (5)	1	22538.222.127
5/8X95 (3.3/4)	1	22538.158.095	3/4X135 (5.1/4)	1	22538.191.133	7/8X130 (5.1/8)	1	22538.222.130
5/8X100 (4)	1	22538.158.101	3/4X140 (5.1/2)	1	22538.191.139	7/8X135 (5.1/4)	1	22538.222.133
5/8X105 (4.1/8)	1	22538.158.105	3/4X145 (5.3/4)	1	22538.191.146	7/8X140 (5.1/2)	1	22538.222.139
5/8X110 (4.1/4)	1	22538.158.107	3/4X150 (6)	1	22538.191.152	7/8X145 (5.3/4)	1	22538.222.146
5/8X115 (4.1/2)	1	22538.158.114	3/4X155 (6.1/8)	1	22538.191.155	7/8X150 (6)	1	22538.222.152
5/8X120 (4.3/4)	1	22538.158.120	3/4X160 (6.1/4)	1	22538.191.158	7/8X155 (6.1/8)	1	22538.222.155
5/8X125 (5)	1	22538.158.127	3/4X165 (6.1/2)	1	22538.191.165	7/8X160 (6.1/4)	1	22538.222.158
5/8X130 (5.1/8)	1	22538.158.130	3/4X170 (6.3/4)	1	22538.191.171	7/8X165 (6.1/2)	1	22538.222.165
5/8X135 (5.1/4)	1	22538.158.133	3/4X175 (6.7/8)	1	22538.191.175	7/8X170 (6.3/4)	1	22538.222.171
5/8X140 (5.1/2)	1	22538.158.139	3/4X180 (7)	1	22538.191.177	7/8X175 (6.7/8)	1	22538.222.175
5/8X145 (5.3/4)	1	22538.158.146	3/4X185 (7.1/4)	1	22538.191.184	7/8X180 (7)	1	22538.222.177
5/8X150 (6)	1	22538.158.152	3/4X190 (7.1/2)	1	22538.191.190	7/8X185 (7.1/4)	1	22538.222.184
5/8X155 (6.1/8)	1	22538.158.155	3/4X195 (7.3/4)	1	22538.191.196	7/8X190 (7.1/2)	1	22538.222.190
5/8X160 (6.1/4)	1	22538.158.158	3/4X200 (8)	1	22538.191.203	7/8X195 (7.3/4)	1	22538.222.196
5/8X165 (6.1/2)	1	22538.158.165	3/4X205 (8.1/8)	1	22538.191.205	7/8X200 (8)	1	22538.222.203
5/8X170 (6.3/4)	1	22538.158.171	3/4X210 (8.1/4)	1	22538.191.209	7/8X205 (8.1/8)	1	22538.222.205
5/8X175 (6.7/8)	1	22538.158.175	3/4X215 (8.1/2)	1	22538.191.215	7/8X210 (8.1/4)	1	22538.222.209
5/8X180 (7)	1	22538.158.177	3/4X220 (8.3/4)	1	22538.191.222	7/8X215 (8.1/2)	1	22538.222.215
5/8X185 (7.1/4)	1	22538.158.184	3/4X225 (8.7/8)	1	22538.191.225	7/8X220 (8.3/4)	1	22538.222.222
5/8X190 (7.1/2)	1	22538.158.190	3/4X230 (9)	1	22538.191.228	7/8X225 (8.7/8)	1	22538.222.225
5/8X195 (7.3/4)	1	22538.158.196	3/4X235 (9.1/4)	1	22538.191.234	7/8X230 (9)	1	22538.222.228
5/8X200 (8)	1	22538.158.203	3/4X240 (9.1/2)	1	22538.191.241	7/8X235 (9.1/4)	1	22538.222.234
5/8X205 (8.1/8)	1	22538.158.205	3/4X245 (9.5/8)	1	22538.191.245	7/8X240 (9.1/2)	1	22538.222.241
5/8X210 (8.1/4)	1	22538.158.209	3/4X250 (9.3/4)	1	22538.191.247	7/8X245 (9.5/8)	1	22538.222.245
5/8X215 (8.1/2)	1	22538.158.215	3/4X255 (10)	1	22538.191.254	7/8X250 (9.3/4)	1	22538.222.247
5/8X220 (8.3/4)	1	22538.158.222	3/4X260 (10.1/4)	1	22538.191.260	7/8X255 (10)	1	22538.222.254
5/8X225 (8.7/8)	1	22538.158.225	3/4X265 (10.1/2)	1	22538.191.266	7/8X260 (10.1/4)	1	22538.222.260
5/8X230 (9)	1	22538.158.228	3/4X270 (10.5/8)	1	22538.191.270	7/8X265 (10.1/2)	1	22538.222.266
5/8X235 (9.1/4)	1	22538.158.234	3/4X275 (10.3/4)	1	22538.191.273	7/8X270 (10.5/8)	1	22538.222.270
5/8X240 (9.1/2)	1	22538.158.241	3/4X280 (11)	1	22538.191.279	7/8X275 (10.3/4)	1	22538.222.273
5/8X245 (9.5/8)	1	22538.158.245	3/4X285 (11.1/4)	1	22538.191.285	7/8X280 (11)	1	22538.222.279
5/8X250 (9.3/4)	1	22538.158.247	3/4X290 (11.3/8)	1	22538.191.290	7/8X285 (11.1/4)	1	22538.222.285
5/8X255 (10)	1	22538.158.254	3/4X295 (11.1/2)	1	22538.191.292	7/8X290 (11.3/8)	1	22538.222.290
5/8X260 (10.1/4)	1	22538.158.260	3/4X300 (11.3/4)	1	22538.191.298	7/8X295 (11.1/2)	1	22538.222.292
5/8X265 (10.1/2)	1	22538.158.266	3/4X305 (12)	1	22538.191.304	7/8X300 (11.3/4)	1	22538.222.298
5/8X270 (10.5/8)	1	22538.158.270	3/4X310 (12.1/4)	1	22538.191.311	7/8X305 (12)	1	22538.222.304
5/8X275 (10.3/4)	1	22538.158.273	3/4X315 (12.1/2)	1	22538.191.317	7/8X310 (12.1/4)	1	22538.222.311
5/8X280 (11)	1	22538.158.279	3/4X320 (12.3/8)	1	22538.191.320	7/8X315 (12.1/2)	1	22538.222.317
5/8X285 (11.1/4)	1	22538.158.285	3/4X325 (12.3/4)	1	22538.191.323	7/8X320 (12.5/8)	1	22538.222.320
5/8X290 (11.3/8)	1	22538.158.290	3/4X325 (12.3/4)	1	22538.191.326	7/8X325 (12.3/4)	1	22538.222.323
5/8X295 (11.1/2)	1	22538.158.292	3/4X330 (13)	1	22538.191.330	7/8X325 (12.3/4)	1	22538.222.326
5/8X300 (11.3/4)	1	22538.158.298	3/4X335 (13.1/4)	1	22538.191.336	7/8X330 (13)	1	22538.222.330
5/8X305 (12)	1	22538.158.304	3/4X335 (13.1/4)	1	22538.191.337	7/8X335 (13.1/4)	1	22538.222.336
5/8X310 (12.1/4)	1	22538.158.311	3/4X340 (13.3/8)	1	22538.191.340	7/8X335 (13.1/4)	1	22538.222.337
5/8X315 (12.1/2)	1	22538.158.317	3/4X345 (13.1/2)	1	22538.191.342	7/8X340 (13.3/8)	1	22538.222.340

4

22538 Śruby dwustronne z dwiema sześciokątnymi nakrętkami, niemetryczne								
d x L mm (L Inch)	☒	Kod artykułu	d x L mm (L Inch)	☒	Kod artykułu	d x L mm (L Inch)	☒	Kod artykułu
7/8X345 (13.1/2)	1	22538.222.342	1.IN.X115 (4.1/2)	1	22538.254.114	1.IN.X325 (12.3/4)	1	22538.254.326
7/8X350 (13.3/4)	1	22538.222.349	1.IN.X120 (4.3/4)	1	22538.254.120	1.IN.X330 (13)	1	22538.254.330
7/8X355 (14)	1	22538.222.355	1.IN.X125 (5)	1	22538.254.127	1.IN.X335 (13.1/4)	1	22538.254.336
7/8X360 (14.1/4)	1	22538.222.361	1.IN.X130 (5.1/8)	1	22538.254.130	1.IN.X335 (13.1/4)	1	22538.254.337
7/8X365 (14.3/8)	1	22538.222.365	1.IN.X135 (5.1/4)	1	22538.254.133	1.IN.X340 (13.3/8)	1	22538.254.340
7/8X370 (14.1/2)	1	22538.222.368	1.IN.X140 (5.1/2)	1	22538.254.139	1.IN.X345 (13.1/2)	1	22538.254.342
7/8X375 (14.3/4)	1	22538.222.374	1.IN.X145 (5.3/4)	1	22538.254.146	1.IN.X350 (13.3/4)	1	22538.254.349
7/8X380 (15)	1	22538.222.381	1.IN.X150 (6)	1	22538.254.152	1.IN.X355 (14)	1	22538.254.355
7/8X385 (15.1/4)	1	22538.222.387	1.IN.X155 (6.1/8)	1	22538.254.155	1.IN.X360 (14.1/4)	1	22538.254.361
7/8X390 (15.3/8)	1	22538.222.390	1.IN.X160 (6.1/4)	1	22538.254.158	1.IN.X365 (14.3/8)	1	22538.254.365
7/8X395 (15.1/2)	1	22538.222.393	1.IN.X165 (6.1/2)	1	22538.254.165	1.IN.X370 (14.1/2)	1	22538.254.368
7/8X400 (15.3/4)	1	22538.222.400	1.IN.X170 (6.3/4)	1	22538.254.171	1.IN.X375 (14.3/4)	1	22538.254.374
7/8X405 (16)	1	22538.222.406	1.IN.X175 (6.7/8)	1	22538.254.175	1.IN.X380 (15)	1	22538.254.381
7/8X410 (16.1/8)	1	22538.222.410	1.IN.X180 (7)	1	22538.254.177	1.IN.X385 (15.1/4)	1	22538.254.387
7/8X415 (16.1/4)	1	22538.222.412	1.IN.X185 (7.1/4)	1	22538.254.184	1.IN.X390 (15.3/8)	1	22538.254.390
7/8X420 (16.1/2)	1	22538.222.419	1.IN.X190 (7.1/2)	1	22538.254.190	1.IN.X395 (15.1/2)	1	22538.254.393
7/8X425 (16.3/4)	1	22538.222.425	1.IN.X195 (7.3/4)	1	22538.254.196	1.IN.X400 (15.3/4)	1	22538.254.400
7/8X430 (17)	1	22538.222.431	1.IN.X200 (8)	1	22538.254.203	1.IN.X405 (16)	1	22538.254.406
7/8X435 (17.1/8)	1	22538.222.435	1.IN.X205 (8.1/8)	1	22538.254.205	1.IN.X410 (16.1/8)	1	22538.254.410
7/8X440 (17.1/4)	1	22538.222.438	1.IN.X210 (8.1/4)	1	22538.254.209	1.IN.X415 (16.1/4)	1	22538.254.412
7/8X445 (17.1/2)	1	22538.222.444	1.IN.X215 (8.1/2)	1	22538.254.215	1.IN.X420 (16.1/2)	1	22538.254.419
7/8X450 (17.3/4)	1	22538.222.450	1.IN.X220 (8.3/4)	1	22538.254.222	1.IN.X425 (16.3/4)	1	22538.254.425
7/8X455 (18)	1	22538.222.457	1.IN.X225 (8.7/8)	1	22538.254.225	1.IN.X430 (17)	1	22538.254.431
7/8X460 (18.1/8)	1	22538.222.460	1.IN.X230 (9)	1	22538.254.228	1.IN.X435 (17.1/8)	1	22538.254.435
7/8X465 (18.1/4)	1	22538.222.463	1.IN.X235 (9.1/4)	1	22538.254.234	1.IN.X440 (17.1/4)	1	22538.254.438
7/8X470 (18.1/2)	1	22538.222.469	1.IN.X240 (9.1/2)	1	22538.254.241	1.IN.X445 (17.1/2)	1	22538.254.444
7/8X475 (18.3/4)	1	22538.222.476	1.IN.X245 (9.5/8)	1	22538.254.245	1.IN.X450 (17.3/4)	1	22538.254.450
7/8X480 (18.7/8)	1	22538.222.480	1.IN.X250 (9.3/4)	1	22538.254.247	1.IN.X455 (18)	1	22538.254.457
7/8X485 (19)	1	22538.222.482	1.IN.X255 (10)	1	22538.254.254	1.IN.X460 (18.1/8)	1	22538.254.460
7/8X490 (19.1/4)	1	22538.222.488	1.IN.X260 (10.1/4)	1	22538.254.260	1.IN.X465 (18.1/4)	1	22538.254.463
7/8X495 (19.1/2)	1	22538.222.495	1.IN.X265 (10.1/2)	1	22538.254.266	1.IN.X470 (18.1/2)	1	22538.254.469
7/8X500 (19.3/4)	1	22538.222.501	1.IN.X270 (10.5/8)	1	22538.254.270	1.IN.X475 (18.3/4)	1	22538.254.476
7/8X510 (20)	1	22538.222.508	1.IN.X275 (10.3/4)	1	22538.254.273	1.IN.X480 (18.7/8)	1	22538.254.480
7/8X515 (20.1/4)	1	22538.222.514	1.IN.X280 (11)	1	22538.254.279	1.IN.X485 (19)	1	22538.254.482
7/8X525 (20.3/4)	1	22538.222.527	1.IN.X285 (11.1/4)	1	22538.254.285	1.IN.X490 (19.1/4)	1	22538.254.488
1.IN.X80 (3.1/4)	1	22538.254.082	1.IN.X290 (11.3/8)	1	22538.254.290	1.IN.X495 (19.1/2)	1	22538.254.495
1.IN.X85 (3.3/8)	1	22538.254.085	1.IN.X295 (11.1/2)	1	22538.254.292	1.IN.X500 (19.3/4)	1	22538.254.501
1.IN.X90 (3.1/2)	1	22538.254.088	1.IN.X300 (11.3/4)	1	22538.254.298	1.IN.X505 (19.7/8)	1	22538.254.505
1.IN.X95 (3.3/4)	1	22538.254.095	1.IN.X305 (12)	1	22538.254.304	1.IN.X515 (20.1/4)	1	22538.254.514
1.IN.X100 (4)	1	22538.254.101	1.IN.X310 (12.1/4)	1	22538.254.311	1.IN.X520 (20.1/2)	1	22538.254.520
1.IN.X105 (4.1/8)	1	22538.254.105	1.IN.X315 (12.1/2)	1	22538.254.317	1.IN.X595 (23.1/2)	1	22538.254.596
1.IN.X110 (4.1/4)	1	22538.254.107	1.IN.X320 (12.5/8)	1	22538.254.320	1.IN.X730 (28.3/4)	1	22538.254.730
			1.IN.X325 (12.3/4)	1	22538.254.323			

4

22551 Śruby dwustronne z dwiema sześciokątnymi nakrętkami, UNC		G11A
Gwint	Całowy, zunifikowany grubozwojny (UNC)	
Materiał	Stal ASTM A193 - ASTM A194	
Klasa	Gr.B16 - Gr.2H	

d x L mm (L Inch)	☒	Kod artykułu	d x L mm (L Inch)	☒	Kod artykułu	d x L mm (L Inch)	☒	Kod artykułu
1/2X65 (2.1/2)	1	22551.127.063	5/8X90 (3.1/2)	1	22551.158.088	3/4X120 (4.3/4)	1	22551.191.120
1/2X70 (2.3/4)	1	22551.127.069	5/8X95 (3.3/4)	1	22551.158.095	3/4X125 (5)	1	22551.191.127
1/2X75 (3)	1	22551.127.076	5/8X100 (4)	1	22551.158.101			
1/2X80 (3.1/4)	1	22551.127.082	5/8X110 (4.1/4)	1	22551.158.107	7/8X115 (4.1/2)	1	22551.222.114
1/2X90 (3.1/2)	1	22551.127.088	5/8X115 (4.1/2)	1	22551.158.114	7/8X120 (4.3/4)	1	22551.222.120
1/2X95 (3.3/4)	1	22551.127.095	5/8X120 (4.3/4)	1	22551.158.120	7/8X125 (5)	1	22551.222.127
1/2X100 (4)	1	22551.127.101	5/8X125 (5)	1	22551.158.127	7/8X135 (5.1/4)	1	22551.222.133
5/8X65 (2.1/2)	1	22551.158.063				7/8X140 (5.1/2)	1	22551.222.139
5/8X70 (2.3/4)	1	22551.158.069	3/4X95 (3.3/4)	1	22551.191.095	7/8X145 (5.3/4)	1	22551.222.146
5/8X75 (3)	1	22551.158.076	3/4X100 (4)	1	22551.191.101	7/8X150 (6)	1	22551.222.152
5/8X80 (3.1/4)	1	22551.158.082	3/4X110 (4.1/4)	1	22551.191.107			
			3/4X115 (4.1/2)	1	22551.191.114	1X165 (6.1/2)	1	22551.254.165

22554 Śruby dwustronne z dwiema sześciokątnymi nakrętkami, UNC		G11A
Gwint	Całowy, zunifikowany grubozwojny (UNC)	
Materiał	Stal ASTM A193 - ASTM A194	
Klasa	Gr.B16 - Gr.4	

d x L mm (L Inch)	☒	Kod artykułu	d x L mm (L Inch)	☒	Kod artykułu	d x L mm (L Inch)	☒	Kod artykułu
3/8X25 (1)	1	22554.096.025	3/8X60 (2.3/8)	1	22554.096.060	3/8X80 (3.1/4)	1	22554.096.082
3/8X40 (1.1/2)	1	22554.096.038	3/8X65 (2.1/2)	1	22554.096.063	3/8X95 (3.3/4)	1	22554.096.095
3/8X45 (1.3/4)	1	22554.096.044	3/8X70 (2.3/4)	1	22554.096.069	3/8X100 (4)	1	22554.096.101

22554 Śruby dwustronne z dwiema sześciokątnymi nakrętkami, UNC



d x L mm (L Inch)	☒	Kod artykułu	d x L mm (L Inch)	☒	Kod artykułu	d x L mm (L Inch)	☒	Kod artykułu
3/8X175 (6.7/8)	1	22554.096.175	5/8X240 (9.1/2)	1	22554.158.241	3/4X335 (13.1/4)	1	22554.191.336
3/8X185 (7.1/4)	1	22554.096.184	5/8X245 (9.5/8)	1	22554.158.245	3/4X340 (13.3/8)	1	22554.191.340
1/2X40 (1.1/2)	1	22554.127.038	5/8X250 (9.3/4)	1	22554.158.247	3/4X345 (13.1/2)	1	22554.191.342
1/2X45 (1.3/4)	1	22554.127.044	5/8X255 (10)	1	22554.158.254	3/4X350 (13.3/4)	1	22554.191.349
1/2X50 (2)	1	22554.127.050	5/8X260 (10.1/4)	1	22554.158.260	3/4X355 (14)	1	22554.191.355
1/2X55 (2.1/4)	1	22554.127.057	5/8X265 (10.1/2)	1	22554.158.266	3/4X360 (14.1/4)	1	22554.191.361
1/2X60 (2.3/8)	1	22554.127.060	5/8X270 (10.5/8)	1	22554.158.270	3/4X365 (14.3/8)	1	22554.191.365
1/2X65 (2.1/2)	1	22554.127.063	5/8X275 (10.3/4)	1	22554.158.273	3/4X370 (14.1/2)	1	22554.191.368
1/2X70 (2.3/4)	1	22554.127.069	5/8X280 (11)	1	22554.158.279	3/4X375 (14.3/4)	1	22554.191.374
1/2X75 (3)	1	22554.127.076	5/8X285 (11.1/4)	1	22554.158.285	3/4X380 (15)	1	22554.191.381
1/2X80 (3.1/4)	1	22554.127.082	5/8X290 (11.3/8)	1	22554.158.290	3/4X385 (15.1/4)	1	22554.191.387
1/2X85 (3.3/8)	1	22554.127.085	5/8X295 (11.1/2)	1	22554.158.292	3/4X390 (15.3/8)	1	22554.191.390
1/2X90 (3.1/2)	1	22554.127.088	5/8X300 (11.3/4)	1	22554.158.298	3/4X395 (15.1/2)	1	22554.191.393
1/2X95 (3.3/4)	1	22554.127.095	5/8X305 (12)	1	22554.158.304	3/4X400 (15.3/4)	1	22554.191.400
1/2X100 (4)	1	22554.127.101	5/8X310 (12.1/4)	1	22554.158.311	3/4X405 (16)	1	22554.191.406
1/2X105 (4.1/8)	1	22554.127.105	5/8X315 (12.1/2)	1	22554.158.317	3/4X410 (16.1/8)	1	22554.191.410
1/2X110 (4.1/4)	1	22554.127.107	5/8X320 (12.5/8)	1	22554.158.320	3/4X415 (16.1/4)	1	22554.191.412
1/2X115 (4.1/2)	1	22554.127.114	5/8X325 (12.3/4)	1	22554.158.323	3/4X420 (16.1/2)	1	22554.191.419
1/2X120 (4.3/4)	1	22554.127.120	5/8X330 (13)	1	22554.158.330	3/4X425 (16.3/4)	1	22554.191.425
1/2X125 (5)	1	22554.127.127	5/8X335 (13.1/4)	1	22554.158.336	3/4X430 (17)	1	22554.191.431
1/2X130 (5.1/8)	1	22554.127.130	5/8X340 (13.3/8)	1	22554.158.340	3/4X440 (17.1/4)	1	22554.191.438
1/2X135 (5.1/4)	1	22554.127.133	5/8X370 (14.1/2)	1	22554.158.368	3/4X450 (17.3/4)	1	22554.191.450
1/2X140 (5.1/2)	1	22554.127.139	5/8X375 (14.3/4)	1	22554.158.374	3/4X455 (18)	1	22554.191.457
1/2X145 (5.3/4)	1	22554.127.146	5/8X385 (15.1/4)	1	22554.158.387	3/4X470 (18.1/2)	1	22554.191.469
1/2X150 (6)	1	22554.127.152	3/4X50 (2)	1	22554.191.050	3/4X480 (18.7/8)	1	22554.191.480
1/2X155 (6.1/8)	1	22554.127.155	3/4X55 (2.1/4)	1	22554.191.057	3/4X485 (19)	1	22554.191.482
1/2X160 (6.1/4)	1	22554.127.158	3/4X60 (2.3/8)	1	22554.191.060	3/4X580 (22.7/8)	1	22554.191.580
1/2X165 (6.1/2)	1	22554.127.165	3/4X65 (2.1/2)	1	22554.191.063	3/4X625 (24.5/8)	1	22554.191.625
1/2X170 (6.3/4)	1	22554.127.171	3/4X70 (2.3/4)	1	22554.191.069	7/8X70 (2.3/4)	1	22554.222.069
1/2X175 (6.7/8)	1	22554.127.175	3/4X75 (3)	1	22554.191.076	7/8X75 (3)	1	22554.222.076
1/2X180 (7)	1	22554.127.177	3/4X80 (3.1/4)	1	22554.191.082	7/8X80 (3.1/4)	1	22554.222.082
1/2X185 (7.1/4)	1	22554.127.184	3/4X85 (3.3/8)	1	22554.191.085	7/8X85 (3.3/8)	1	22554.222.085
1/2X190 (7.1/2)	1	22554.127.190	3/4X90 (3.1/2)	1	22554.191.088	7/8X90 (3.1/2)	1	22554.222.088
1/2X195 (7.3/4)	1	22554.127.196	3/4X95 (3.3/4)	1	22554.191.095	7/8X95 (3.3/4)	1	22554.222.095
1/2X200 (8)	1	22554.127.203	3/4X100 (4)	1	22554.191.101	7/8X100 (4)	1	22554.222.101
1/2X205 (8.1/8)	1	22554.127.205	3/4X105 (4.1/8)	1	22554.191.105	7/8X105 (4.1/8)	1	22554.222.105
1/2X210 (8.1/4)	1	22554.127.209	3/4X110 (4.1/4)	1	22554.191.107	7/8X110 (4.1/4)	1	22554.222.107
1/2X225 (8.7/8)	1	22554.127.225	3/4X115 (4.1/2)	1	22554.191.114	7/8X115 (4.1/2)	1	22554.222.114
1/2X250 (9.3/4)	1	22554.127.247	3/4X120 (4.3/4)	1	22554.191.120	7/8X120 (4.3/4)	1	22554.222.120
1/2X280 (11)	1	22554.127.279	3/4X125 (5)	1	22554.191.127	7/8X125 (5)	1	22554.222.127
5/8X40 (1.1/2)	1	22554.158.038	3/4X130 (5.1/8)	1	22554.191.130	7/8X130 (5.1/8)	1	22554.222.130
5/8X45 (1.3/4)	1	22554.158.044	3/4X135 (5.1/4)	1	22554.191.133	7/8X135 (5.1/4)	1	22554.222.133
5/8X50 (2)	1	22554.158.050	3/4X140 (5.1/2)	1	22554.191.139	7/8X140 (5.1/2)	1	22554.222.139
5/8X55 (2.1/4)	1	22554.158.057	3/4X145 (5.3/4)	1	22554.191.146	7/8X145 (5.3/4)	1	22554.222.146
5/8X60 (2.3/8)	1	22554.158.060	3/4X150 (6)	1	22554.191.152	7/8X150 (6)	1	22554.222.152
5/8X65 (2.1/2)	1	22554.158.063	3/4X155 (6.1/8)	1	22554.191.155	7/8X155 (6.1/8)	1	22554.222.155
5/8X70 (2.3/4)	1	22554.158.069	3/4X160 (6.1/4)	1	22554.191.158	7/8X160 (6.1/4)	1	22554.222.158
5/8X75 (3)	1	22554.158.076	3/4X165 (6.1/2)	1	22554.191.165	7/8X165 (6.1/2)	1	22554.222.165
5/8X80 (3.1/4)	1	22554.158.082	3/4X170 (6.3/4)	1	22554.191.171	7/8X170 (6.3/4)	1	22554.222.171
5/8X85 (3.3/8)	1	22554.158.085	3/4X175 (6.7/8)	1	22554.191.175	7/8X175 (6.7/8)	1	22554.222.175
5/8X90 (3.1/2)	1	22554.158.088	3/4X180 (7)	1	22554.191.177	7/8X180 (7)	1	22554.222.177
5/8X95 (3.3/4)	1	22554.158.095	3/4X185 (7.1/4)	1	22554.191.184	7/8X185 (7.1/4)	1	22554.222.184
5/8X100 (4)	1	22554.158.101	3/4X190 (7.1/2)	1	22554.191.190	7/8X190 (7.1/2)	1	22554.222.190
5/8X105 (4.1/8)	1	22554.158.105	3/4X195 (7.3/4)	1	22554.191.196	7/8X195 (7.3/4)	1	22554.222.196
5/8X110 (4.1/4)	1	22554.158.107	3/4X200 (8)	1	22554.191.203	7/8X200 (8)	1	22554.222.203
5/8X115 (4.1/2)	1	22554.158.114	3/4X205 (8.1/8)	1	22554.191.205	7/8X205 (8.1/8)	1	22554.222.205
5/8X120 (4.3/4)	1	22554.158.120	3/4X210 (8.1/4)	1	22554.191.209	7/8X210 (8.1/4)	1	22554.222.209
5/8X125 (5)	1	22554.158.127	3/4X215 (8.1/2)	1	22554.191.215	7/8X215 (8.1/2)	1	22554.222.215
5/8X130 (5.1/8)	1	22554.158.130	3/4X220 (8.3/4)	1	22554.191.222	7/8X220 (8.3/4)	1	22554.222.222
5/8X135 (5.1/4)	1	22554.158.133	3/4X225 (8.7/8)	1	22554.191.225	7/8X225 (8.7/8)	1	22554.222.225
5/8X140 (5.1/2)	1	22554.158.139	3/4X230 (9)	1	22554.191.228	7/8X230 (9)	1	22554.222.228
5/8X145 (5.3/4)	1	22554.158.146	3/4X235 (9.1/4)	1	22554.191.234	7/8X235 (9.1/4)	1	22554.222.234
5/8X150 (6)	1	22554.158.152	3/4X240 (9.1/2)	1	22554.191.241	7/8X240 (9.1/2)	1	22554.222.241
5/8X155 (6.1/8)	1	22554.158.155	3/4X245 (9.5/8)	1	22554.191.245	7/8X245 (9.5/8)	1	22554.222.245
5/8X160 (6.1/4)	1	22554.158.158	3/4X250 (9.3/4)	1	22554.191.247	7/8X250 (9.3/4)	1	22554.222.247
5/8X165 (6.1/2)	1	22554.158.165	3/4X255 (10)	1	22554.191.254	7/8X255 (10)	1	22554.222.254
5/8X170 (6.3/4)	1	22554.158.171	3/4X260 (10.1/4)	1	22554.191.260	7/8X260 (10.1/4)	1	22554.222.260
5/8X175 (6.7/8)	1	22554.158.175	3/4X265 (10.1/2)	1	22554.191.266	7/8X265 (10.1/2)	1	22554.222.266
5/8X180 (7)	1	22554.158.177	3/4X270 (10.5/8)	1	22554.191.270	7/8X270 (10.5/8)	1	22554.222.270
5/8X185 (7.1/4)	1	22554.158.184	3/4X275 (10.3/4)	1	22554.191.273	7/8X275 (10.3/4)	1	22554.222.273
5/8X190 (7.1/2)	1	22554.158.190	3/4X280 (11)	1	22554.191.279	7/8X280 (11)	1	22554.222.279
5/8X195 (7.3/4)	1	22554.158.196	3/4X285 (11.1/4)	1	22554.191.285	7/8X285 (11.1/4)	1	22554.222.285
5/8X200 (8)	1	22554.158.203	3/4X290 (11.3/8)	1	22554.191.290	7/8X290 (11.3/8)	1	22554.222.290
5/8X205 (8.1/8)	1	22554.158.205	3/4X295 (11.1/2)	1	22554.191.292	7/8X295 (11.1/2)	1	22554.222.292
5/8X210 (8.1/4)	1	22554.158.209	3/4X300 (11.3/4)	1	22554.191.298	7/8X300 (11.3/4)	1	22554.222.298
5/8X215 (8.1/2)	1	22554.158.215	3/4X305 (12)	1	22554.191.304	7/8X305 (12)	1	22554.222.304
5/8X220 (8.3/4)	1	22554.158.222	3/4X310 (12.1/4)	1	22554.191.311	7/8X310 (12.1/4)	1	22554.222.311
5/8X225 (8.7/8)	1	22554.158.225	3/4X315 (12.1/2)	1	22554.191.317	7/8X315 (12.1/2)	1	22554.222.317
5/8X230 (9)	1	22554.158.228	3/4X320 (12.5/8)	1	22554.191.320	7/8X320 (12.5/8)	1	22554.222.320
5/8X235 (9.1/4)	1	22554.158.234	3/4X325 (12.3/4)	1	22554.191.323	7/8X325 (12.3/4)	1	22554.222.323
			3/4X330 (13)	1	22554.191.330	7/8X330 (13)	1	22554.222.330

4

22554 Śruby dwustronne z dwiema sześciokątnymi nakrętkami, UNC								
d x L mm (L Inch)	☒	Kod artykułu	d x L mm (L Inch)	☒	Kod artykułu	d x L mm (L Inch)	☒	Kod artykułu
7/8X335 (13.1/4)	1	22554.222.336	1.IN.X125 (5)	1	22554.254.127	1.IN.X315 (12.1/2)	1	22554.254.317
7/8X340 (13.3/8)	1	22554.222.340	1.IN.X130 (5.1/8)	1	22554.254.130	1.IN.X320 (12.5/8)	1	22554.254.320
7/8X345 (13.1/2)	1	22554.222.342	1.IN.X135 (5.1/4)	1	22554.254.133	1.IN.X325 (12.3/4)	1	22554.254.323
7/8X350 (13.3/4)	1	22554.222.349	1.IN.X140 (5.1/2)	1	22554.254.139	1.IN.X330 (13)	1	22554.254.330
7/8X355 (14)	1	22554.222.355	1.IN.X145 (5.3/4)	1	22554.254.146	1.IN.X335 (13.1/4)	1	22554.254.336
7/8X360 (14.1/4)	1	22554.222.361	1.IN.X150 (6)	1	22554.254.152	1.IN.X340 (13.3/8)	1	22554.254.340
7/8X365 (14.3/8)	1	22554.222.365	1.IN.X155 (6.1/8)	1	22554.254.155	1.IN.X345 (13.1/2)	1	22554.254.342
7/8X370 (14.1/2)	1	22554.222.368	1.IN.X160 (6.1/4)	1	22554.254.158	1.IN.X350 (13.3/4)	1	22554.254.349
7/8X375 (14.3/4)	1	22554.222.375	1.IN.X165 (6.1/2)	1	22554.254.165	1.IN.X355 (14)	1	22554.254.355
7/8X380 (15)	1	22554.222.381	1.IN.X170 (6.3/4)	1	22554.254.171	1.IN.X360 (14.1/4)	1	22554.254.361
7/8X385 (15.1/4)	1	22554.222.382	1.IN.X175 (6.7/8)	1	22554.254.175	1.IN.X365 (14.3/8)	1	22554.254.365
7/8X390 (15.3/8)	1	22554.222.390	1.IN.X180 (7)	1	22554.254.177	1.IN.X370 (14.1/2)	1	22554.254.368
7/8X395 (15.1/2)	1	22554.222.393	1.IN.X185 (7.1/4)	1	22554.254.184	1.IN.X375 (14.3/4)	1	22554.254.374
7/8X400 (15.3/4)	1	22554.222.400	1.IN.X190 (7.1/2)	1	22554.254.190	1.IN.X380 (15)	1	22554.254.381
7/8X405 (16)	1	22554.222.406	1.IN.X195 (7.3/4)	1	22554.254.196	1.IN.X385 (15.1/4)	1	22554.254.387
7/8X410 (16.1/8)	1	22554.222.410	1.IN.X200 (8)	1	22554.254.203	1.IN.X390 (15.3/8)	1	22554.254.390
7/8X415 (16.1/4)	1	22554.222.412	1.IN.X205 (8.1/8)	1	22554.254.205	1.IN.X395 (15.1/2)	1	22554.254.393
7/8X420 (16.1/2)	1	22554.222.419	1.IN.X210 (8.1/4)	1	22554.254.209	1.IN.X400 (15.3/4)	1	22554.254.400
7/8X425 (16.3/4)	1	22554.222.425	1.IN.X215 (8.1/2)	1	22554.254.215	1.IN.X405 (16)	1	22554.254.406
7/8X430 (17)	1	22554.222.431	1.IN.X220 (8.3/4)	1	22554.254.222	1.IN.X410 (16.1/8)	1	22554.254.410
7/8X440 (17.1/4)	1	22554.222.438	1.IN.X225 (8.7/8)	1	22554.254.225	1.IN.X415 (16.1/4)	1	22554.254.412
7/8X450 (17.3/4)	1	22554.222.450	1.IN.X230 (9)	1	22554.254.228	1.IN.X420 (16.1/2)	1	22554.254.419
7/8X455 (18)	1	22554.222.457	1.IN.X235 (9.1/4)	1	22554.254.234	1.IN.X425 (16.3/4)	1	22554.254.425
7/8X470 (18.1/2)	1	22554.222.469	1.IN.X240 (9.1/2)	1	22554.254.241	1.IN.X430 (17)	1	22554.254.431
7/8X485 (19)	1	22554.222.482	1.IN.X245 (9.5/8)	1	22554.254.245	1.IN.X435 (17.1/8)	1	22554.254.435
7/8X495 (19.1/2)	1	22554.222.495	1.IN.X250 (9.3/4)	1	22554.254.247	1.IN.X440 (17.1/4)	1	22554.254.438
7/8X510 (20)	1	22554.222.508	1.IN.X255 (10)	1	22554.254.254	1.IN.X445 (17.1/2)	1	22554.254.444
7/8X515 (20.1/4)	1	22554.222.514	1.IN.X260 (10.1/4)	1	22554.254.260	1.IN.X450 (17.3/4)	1	22554.254.450
7/8X525 (20.3/4)	1	22554.222.527	1.IN.X265 (10.1/2)	1	22554.254.266	1.IN.X455 (18)	1	22554.254.457
1.IN.X80 (3.1/4)	1	22554.254.082	1.IN.X270 (10.5/8)	1	22554.254.270	1.IN.X460 (18.1/8)	1	22554.254.460
1.IN.X85 (3.3/8)	1	22554.254.085	1.IN.X275 (10.3/4)	1	22554.254.273	1.IN.X470 (18.1/2)	1	22554.254.469
1.IN.X90 (3.1/2)	1	22554.254.088	1.IN.X280 (11)	1	22554.254.279	1.IN.X485 (19)	1	22554.254.482
1.IN.X95 (3.3/4)	1	22554.254.095	1.IN.X285 (11.1/4)	1	22554.254.285	1.IN.X505 (19.7/8)	1	22554.254.505
1.IN.X100 (4)	1	22554.254.101	1.IN.X290 (11.3/8)	1	22554.254.290	1.IN.X515 (20.1/4)	1	22554.254.514
1.IN.X105 (4.1/8)	1	22554.254.105	1.IN.X295 (11.1/2)	1	22554.254.292	1.IN.X520 (20.1/2)	1	22554.254.520
1.IN.X110 (4.1/4)	1	22554.254.107	1.IN.X300 (11.3/4)	1	22554.254.298	1.IN.X595 (23.1/2)	1	22554.254.596
1.IN.X115 (4.1/2)	1	22554.254.114	1.IN.X305 (12)	1	22554.254.304	1.IN.X615 (24.1/4)	1	22554.254.615
			1.IN.X310 (12.1/4)	1	22554.254.311	1.IN.X730 (28.3/4)	1	22554.254.730

4

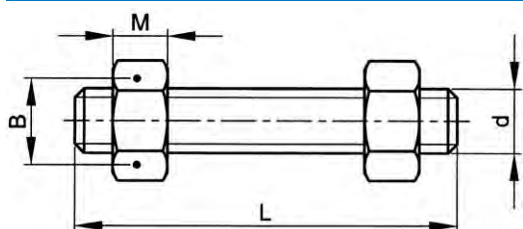
Śruby dwustronne z dwiema sześciokątnymi nakrętkami, metryczne



BS ≈4882

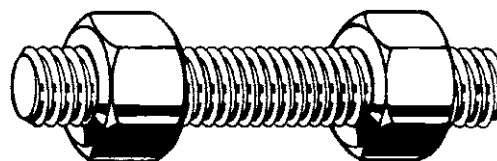

Informacje techniczne

d	B	M	P	d	B	M	P
M12	19	12	1.75	M24	36	24	3
M14	22	14	2	M27	41	27	3
M16	24	16	2	M30	46	30	3.5
M18	27	18	2.5	M33	50	33	3.5
M20	30	20	2.5	M36	55	36	4
M22	32	22	2.5				

- Wysokość nakrętki 'M' nie jest zgodna z BS 4882.
- L to znamionowa długość śruby dwustronnej, w tym końców szfowanych.

22060 Śruby dwustronne z dwiema sześciokątnymi nakrętkami

G09A

Gwint Metryczny
Materiał Stal ASTM A193M - ASTM A194M
Klasa Gr.B7 - Gr.2H

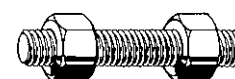

d x L	☒	Kod artykułu	d x L	☒	Kod artykułu	d x L	☒	Kod artykułu
M12X55	1	22060.120.055	M12X75	1	22060.120.075	M12X95	1	22060.120.095
M12X60	1	22060.120.060	M12X80	1	22060.120.080	M12X100	1	22060.120.100
M12X65	1	22060.120.065	M12X85	1	22060.120.085	M12X120	1	22060.120.120
M12X70	1	22060.120.070	M12X90	1	22060.120.090	M12X125	1	22060.120.125

22060 Śruby dwustronne z dwiema sześciokątnymi nakrętkami

d x L	☒	Kod artykułu	d x L	☒	Kod artykułu	d x L	☒	Kod artykułu
M12X140	1	22060.120.140	M20X145	1	22060.200.145	M24X365	1	22060.240.365
M14X55	1	22060.140.055	M20X150	1	22060.200.150	M27X125	1	22060.270.125
M14X65	1	22060.140.065	M20X160	1	22060.200.160	M27X130	1	22060.270.130
M14X70	1	22060.140.070	M20X165	1	22060.200.165	M27X135	1	22060.270.135
M14X75	1	22060.140.075	M20X170	1	22060.200.170	M27X140	1	22060.270.140
M14X80	1	22060.140.080	M20X180	1	22060.200.180	M27X150	1	22060.270.150
M14X85	1	22060.140.085	M20X190	1	22060.200.190	M27X165	1	22060.270.165
M14X90	1	22060.140.090	M20X195	1	22060.200.195	M27X175	1	22060.270.175
M14X100	1	22060.140.100	M20X200	1	22060.200.200	M27X190	1	22060.270.190
M14X120	1	22060.140.120	M20X210	1	22060.200.210	M27X215	1	22060.270.215
M16X55	1	22060.160.055	M20X230	1	22060.200.230	M27X230	1	22060.270.230
M16X60	1	22060.160.060	M20X240	1	22060.200.240	M27X240	1	22060.270.240
M16X65	1	22060.160.065	M20X245	1	22060.200.245	M27X250	1	22060.270.250
M16X70	1	22060.160.070	M20X250	1	22060.200.250	M27X275	1	22060.270.275
M16X75	1	22060.160.075	M20X320	1	22060.200.320	M30X135	1	22060.300.135
M16X80	1	22060.160.080	M20X340	1	22060.200.340	M30X140	1	22060.300.140
M16X85	1	22060.160.085	M20X400	1	22060.200.400	M30X150	1	22060.300.150
M16X90	1	22060.160.090	M22X95	1	22060.220.095	M30X155	1	22060.300.155
M16X95	1	22060.160.095	M22X100	1	22060.220.100	M30X170	1	22060.300.170
M16X100	1	22060.160.100	M22X110	1	22060.220.110	M30X175	1	22060.300.175
M16X110	1	22060.160.110	M22X120	1	22060.220.120	M30X180	1	22060.300.180
M16X120	1	22060.160.120	M22X130	1	22060.220.130	M30X185	1	22060.300.185
M16X125	1	22060.160.125	M22X140	1	22060.220.140	M30X215	1	22060.300.215
M16X130	1	22060.160.130	M22X150	1	22060.220.150	M30X220	1	22060.300.220
M16X140	1	22060.160.140	M22X160	1	22060.220.160	M30X230	1	22060.300.230
M16X150	1	22060.160.150	M22X170	1	22060.220.170	M30X240	1	22060.300.240
M16X160	1	22060.160.160	M22X190	1	22060.220.190	M30X250	1	22060.300.250
M16X165	1	22060.160.165	M22X200	1	22060.220.200	M30X500	1	22060.300.500
M16X175	1	22060.160.175	M22X210	1	22060.220.210	M30X590	1	22060.300.590
M16X190	1	22060.160.190	M24X80	1	22060.240.080	M33X150	1	22060.330.150
M16X220	1	22060.160.220	M24X110	1	22060.240.110	M33X170	1	22060.330.170
M16X240	1	22060.160.240	M24X115	1	22060.240.115	M33X175	1	22060.330.175
M16X300	1	22060.160.300	M24X120	1	22060.240.120	M33X185	1	22060.330.185
M18X100	1	22060.180.100	M24X125	1	22060.240.125	M33X190	1	22060.330.190
M18X120	1	22060.180.120	M24X130	1	22060.240.130	M33X200	1	22060.330.200
M20X75	1	22060.200.075	M24X140	1	22060.240.140	M33X210	1	22060.330.210
M20X80	1	22060.200.080	M24X145	1	22060.240.145	M33X220	1	22060.330.220
M20X85	1	22060.200.085	M24X150	1	22060.240.150	M33X230	1	22060.330.230
M20X90	1	22060.200.090	M24X160	1	22060.240.160	M33X330	1	22060.330.330
M20X95	1	22060.200.095	M24X165	1	22060.240.165	M36X175	1	22060.360.175
M20X100	1	22060.200.100	M24X170	1	22060.240.170	M36X190	1	22060.360.190
M20X105	1	22060.200.105	M24X180	1	22060.240.180	M36X200	1	22060.360.200
M20X110	1	22060.200.110	M24X185	1	22060.240.185	M36X210	1	22060.360.210
M20X115	1	22060.200.115	M24X190	1	22060.240.190	M36X220	1	22060.360.220
M20X120	1	22060.200.120	M24X200	1	22060.240.200	M36X230	1	22060.360.230
M20X125	1	22060.200.125	M24X220	1	22060.240.220	M36X240	1	22060.360.240
M20X130	1	22060.200.130	M24X230	1	22060.240.230	M36X250	1	22060.360.250
M20X135	1	22060.200.135	M24X240	1	22060.240.240	M36X260	1	22060.360.260
M20X140	1	22060.200.140	M24X250	1	22060.240.250			
			M24X275	1	22060.240.275			
			M24X320	1	22060.240.320			

4

Nakrętki sześciokątne ASTM A194, klasa 2H, niemetryczne

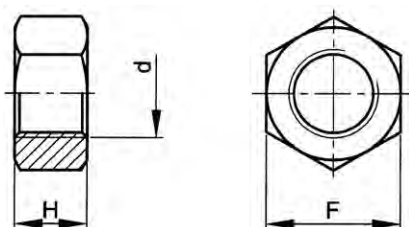

ASME B18.2.2
BS 1769

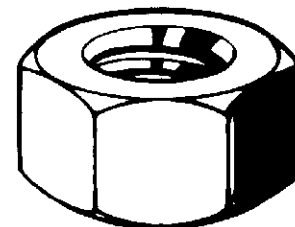

Informacje techniczne

d	F	H	Zwoje gwintu na cal	d	F	H	Zwoje gwintu na cal
3/8	11/16	9	16	1.1/2	2.3/8	37.3	8
1/2	7/8	12.3	13	1.5/8	2.9/16	40.5	8
5/8	1.1/16	15.5	11	1.3/4	2.3/4	43.65	8
3/4	1.1/4	18.65	10	1.7/8	2.15/16	46.85	8
7/8	1.7/16	21.85	9	2 Inch	3.1/8	50	8
1 Inch	1.5/8	25	8	2.1/4	3.1/2	55.95	8
1.1/8	1.13/16	28.2	8	2.1/2	3.7/8	62.3	8
1.1/4	2 Inch	30.95	8	2.3/4	4.1/4	68.25	8
1.3/8	2.3/16	34.15	8	3 Inch	4.5/8	75	8

Grupy katalogowe

Gwint	Gniazdo	Materiał	Klasa	Kod	Strona
UNC	Sześciokąt	St ASTM A194	Gr.2H	22280	4-57
8 UN	Sześciokąt	St ASTM A194	Gr.2H	22290	4-57
UNC	Sześciokąt	St ASTM A194	Gr.4	22380	4-58
8 UN	Sześciokąt	St ASTM A194	Gr.4	22390	4-58
UNC	Sześciokąt	St ASTM A194	Gr.7	22382	4-58
UNC	Sześciokąt	St.St. ASTM A194	Gr.8	22383	4-58
8 UN	Sześciokąt	St.St. ASTM A194	Gr.8	22393	4-58
UNC	Sześciokąt	St.St. ASTM A194	Gr.8M	22384	4-58
UNC	Sześciokąt	St.St. ASTM A194	Gr.8T	22386	4-59

22280 Nakrętki sześciokątne ASTM A194, klasa 2H, UNC

G09A

Gwint Calowy, zunifikowany grubozwojny (UNC)
Materiał Stal ASTM A194
Klasa Gr.2H

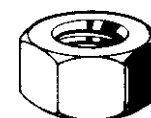

d	☒	Kod artykułu	d	☒	Kod artykułu	d	☒	Kod artykułu
1/2	1	22280.127.001	3/4	1	22280.191.001	1 Inch	1	22280.254.001
5/8	1	22280.158.001	7/8	1	22280.222.001			

22290 Nakrętki sześciokątne ASTM A194, klasa 2H, 8UN

G09A

Gwint 8 UN amerykański
Materiał Stal ASTM A194
Klasa Gr.2H

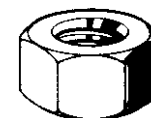

d	☒	Kod artykułu	d	☒	Kod artykułu	d	☒	Kod artykułu
1.1/8	1	22290.285.001	1.5/8	1	22290.412.001	2.1/4	1	22290.571.001
1.1/4	1	22290.317.001	1.3/4	1	22290.444.001	2.1/2	1	22290.635.001
1.3/8	1	22290.349.001	1.7/8	1	22290.476.001	2.3/4	1	22290.698.001
1.1/2	1	22290.381.001	2 Inch	1	22290.508.001	3 Inch	1	22290.762.001

22380	Nakrętki sześciokątne ASTM A194, klasa 2H, UNC						G10A	
Gwint	Celowy, zunifikowany grubozwojny (UNC)							
Materiał	Stal ASTM A194							
Klasa	Gr.4							
d	<input type="checkbox"/>	Kod artykułu	d	<input type="checkbox"/>	Kod artykułu	d	<input type="checkbox"/>	Kod artykułu
3/8	1	22380.096.001	5/8	1	22380.158.001	7/8	1	22380.222.001
1/2	1	22380.127.001	3/4	1	22380.191.001	1 Inch	1	22380.254.001
22390	Nakrętki sześciokątne ASTM A194, klasa 2H, 8UN						G10A	
Gwint	8 UN amerykański							
Materiał	Stal ASTM A194							
Klasa	Gr.4							
d	<input type="checkbox"/>	Kod artykułu	d	<input type="checkbox"/>	Kod artykułu	d	<input type="checkbox"/>	Kod artykułu
1.1/8	1	22390.285.001	1.1/2	1	22390.381.001	1.7/8	1	22390.476.001
1.1/4	1	22390.317.001	1.5/8	1	22390.412.001	2 Inch	1	22390.508.001
1.3/8	1	22390.349.001	1.3/4	1	22390.444.001			
22382	Nakrętki sześciokątne ASTM A194, klasa 2H, UNC						G10A	
Gwint	Celowy, zunifikowany grubozwojny (UNC)							
Materiał	Stal ASTM A194							
Klasa	Gr.7							
d	<input type="checkbox"/>	Kod artykułu	d	<input type="checkbox"/>	Kod artykułu	d	<input type="checkbox"/>	Kod artykułu
1/2	1	22382.127.001	3/4	1	22382.191.001	1 Inch	1	22382.254.001
5/8	1	22382.158.001	7/8	1	22382.222.001			
22383	Nakrętki sześciokątne ASTM A194, klasa 2H, UNC						G12A	
Gwint	Celowy, zunifikowany grubozwojny (UNC)							
Materiał	Stal nierdzewna ASTM A194							
Klasa	Gr.8							
d	<input type="checkbox"/>	Kod artykułu	d	<input type="checkbox"/>	Kod artykułu	d	<input type="checkbox"/>	Kod artykułu
1/2	1	22383.127.001	3/4	1	22383.191.001	1 Inch	1	22383.254.001
5/8	1	22383.158.001	7/8	1	22383.222.001			
22393	Nakrętki sześciokątne ASTM A194, klasa 2H, niemetryczne						G12A	
Gwint	8 UN amerykański							
Materiał	Stal nierdzewna ASTM A194							
Klasa	Gr.8							
d	<input type="checkbox"/>	Kod artykułu	d	<input type="checkbox"/>	Kod artykułu	d	<input type="checkbox"/>	Kod artykułu
1.1/8	1	22393.285.001	1.3/8	1	22393.349.001	1.1/2	1	22393.381.001
1.1/4	1	22393.317.001						
22384	Nakrętki sześciokątne ASTM A194, klasa 2H, UNC						G12A	
Gwint	Celowy, zunifikowany grubozwojny (UNC)							
Materiał	Stal nierdzewna ASTM A194							
Klasa	Gr.8M							
d	<input type="checkbox"/>	Kod artykułu	d	<input type="checkbox"/>	Kod artykułu	d	<input type="checkbox"/>	Kod artykułu
1/2	1	22384.127.001	3/4	1	22384.191.001	1 Inch	1	22384.254.001
5/8	1	22384.158.001	7/8	1	22384.222.001			

22386	Nakrętki sześciokątne ASTM A194, klasa 2H, UNC		G12A
Gwint	Calowy, zunifikowany grubozwojny (UNC)		
Materiał	Stal nierdzewna ASTM A194		
Klasa	Gr.8T		
			

d	☒	Kod artykułu	d	☒	Kod artykułu	d	☒	Kod artykułu
3/8	1	22386.096.001	5/8	1	22386.158.001	7/8	1	22386.222.001
1/2	1	22386.127.001	3/4	1	22386.191.001	1 Inch	1	22386.254.001

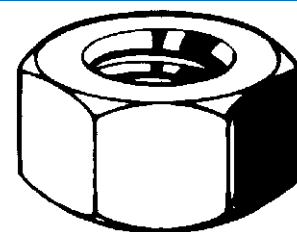
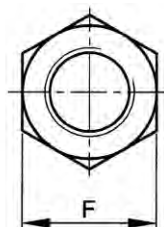
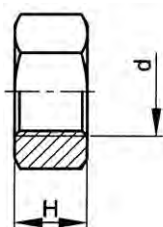

Nakrętki sześciokątne, ASTM A194, klasa 2H, metryczne



4

Informacje techniczne

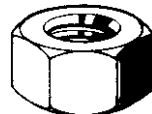
d	F	H	P	d	F	H	P
M10	17	10	1.5	M30	46	30	3.5
M12	19	12	1.75	M33	50	33	3.5
M14	22	14	2	M36	55	36	4
M16	24	16	2	M39	60	39	4
M18	27	18	2.5	M42	65	42	4.5
M20	30	20	2.5	M45	70	45	4.5
M22	32	22	2.5	M48	75	48	5
M24	36	24	3	M52	80	52	5
M27	41	27	3	M64	95	64	6

22200	Nakrętki sześciokątne, ASTM A194, klasa 2H, metryczne		G09A
Gwint	Metryczny		
Materiał	Stal ASTM A194M		
Klasa	Gr.2H		
			

d	☒	Kod artykułu	d	☒	Kod artykułu	d	☒	Kod artykułu
M10	1	22200.100.001	M22	1	22200.220.001	M39	1	22200.390.001
M12	1	22200.120.001	M24	1	22200.240.001	M42	1	22200.420.001
M14	1	22200.140.001	M27	1	22200.270.001	M45	1	22200.450.001
M16	1	22200.160.001	M30	1	22200.300.001	M48	1	22200.480.001
M18	1	22200.180.001	M33	1	22200.330.001	M52	1	22200.520.001
M20	1	22200.200.001	M36	1	22200.360.001	M64	1	22200.640.001

Śruby dwustronne

Ze zredukowanym trzpieniem i dwoma nakrętkami sześciokątnymi

Połączenia śrubowe ze zredukowanym trzpieniem są szczególnie efektywne w konstrukcjach obciążonych dynamicznie i wahaniami temperatury by zapewnić wysoki poziom odporności zmęczeniowej. Połączenia śrubowe ze zredukowanym trzpieniem mają znacznie większy poziom wydłużenia w porównaniu do tych z pełnym trzpieniem i przy tym samym obciążeniu.

Do zastosowań i kalkulacji śrub dwustronnych w zbiornikach ciśnieniowych odnosimy się do normy AD 2000 – Merkblatt B7, W7 oraz W10, opublikowanej przez VdTÜV w Berlinie.

To daje kilka zalet:

- Większa odporność zmęczeniowa, jako efekt zmiennego obciążenia i temperatury również moment skręcający jest obniżony.
- Obniżenie obciążenia wstępnego, spowodowane pełzaniem łączonych materiałów i osadzaniem powierzchni łączy, jest obniżone
- Montaż do określonego ścisłu połączenia jest łatwiejszy do kontroli

Zakresy temperatury pracy i kombinacje śrub/nakrętek

SPECYFIKACJE	STANDARDOWA WARTOŚĆ	NUMER I OZNACZENIE MATERIAŁU			
		ŚRUBY		NAKRĘTKI	
DIN 267-13/ DIN EN 10269 AD 2000 W7	+ 700° C	2.4952	SB	2.4952	SB
	+ 650° C	1.4986	S	1.4986	S
		1.4980	SD	1.4980	SD
	+ 580° C	1.4923	V	1.4923	V
	+ 540° C	1.4913	VW	1.4923	V
		1.7709	GA	1.7709	GA
	+ 500° C	1.7709	GA	1.7218	KG
		1.7711	GB	1.7709	GA
	+ 400° C	1.7218	KG	1.7218	KG
		1.7218	KG	1.1181	YK
	+ 350° C	1.1181	YK	1.1181	YK
		1.1181	YK	1.0501	Y
DIN 267-13/ISO 898-1	+ 350° C	8.8			
	- 10° C	5.6			
DIN 267-13/ DIN EN 10269 AD2000 W10	- 60° C	1.7218	KG	1.7218	KG
	- 120° C	1.5680	KB	1.5680	KB
	- 196° C	1.6906	-	1.6906	-

Właściwości materiałowe wg EN 10269

Oznaczenie materiału			Warunki obróbki cieplnej (1)	Zakres temperaturowy			Średnica mm	Wytr. pod obciążeniem próbnym MPa (min)	Wytrzymałość na rociąganie MPa	Wydłużenie po pęknięciu % min.	Zmniejszenie pola pow po pęknięciu % min.	Energia uderzenia KVJ min.
Znak produkcyjny	Nazwa materiału	Numer materiału		Min.	Krótko Max. (2)	Długo Max. (2)						
YK	C35E	1.1181	+QT	-	400°C	500°C	d ≤ 60	300	500-650	22	45	55
							60 < d ≤ 150	300	500-650	22	45	39
KG	25CrMo4	1.7218	+QT	-60°C	500°C	550°C	d ≤ 100	440	600-750	18	60	60
							100 < d ≤ 150	420	600-750	18	60	45
GA	21CrMoV5-7	1.7709	+QT	-	500°C	550°C	d ≤ 160	550	700-850	16	60	63

(1) +QT = quenched and tempered / hartowane i odpuszczane

(2) Short = short time service (serwis krótki); Long = long time service (serwis długi). Norma EN 10269 podaje bardziej szczegółowe informacje nt. wytrzymałości w podwyższonych temperaturach i ramach czasowych.

Właściwości materiałowe są podane dla temperatury pokojowej, szukając właściwości w innych temperaturach skonsultuj normę EN 10269

Śruby dwustronne ze zredukowanym trzpieniem i dwiema nakrętkami sześciokątnymi

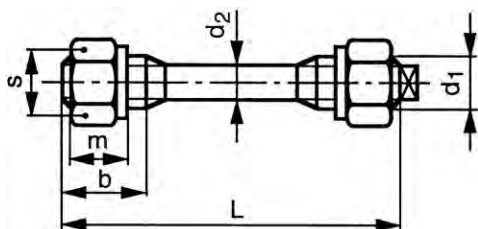

DIN 2510 L/NF

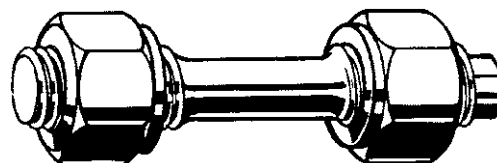

Informacje techniczne

d ₁	b	d ₂	m	P	s
M12	20	8.5	12	1.75	22
M16	23	12	16	2	27
M20	28	15	20	2.5	32
M24	32	18	24	3	36
M27	35	20.5	27	3	41
M30	39	23	30	3.5	46

- Dane techniczne, właściwości materiałowe i wytłumaczenie oznaczeń, patrz strona INFO.
- Gwint zewnętrzny zgodny z DIN 2510-2.

Grupy katalogowe

Gwint	Materiał	Klasa	Kod	Strona
M	St	KG/YK	23510	4-61
M	St	GA/KG	23530	4-61
M	St	YK/YK	23550	4-62

23510 Śruby dwustronne ze zredukowanym trzpieniem i dwiema nakrętkami sześciokątnymi

G90A

Gwint: Metryczny
Materiał: Stal 25CrMo4+QT/C35E+QT
Klasa: KG/YK

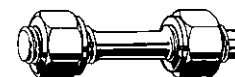

d ₁ x L	☒	Kod artykułu	d ₁ x L	☒	Kod artykułu	d ₁ x L	☒	Kod artykułu
M12X65	10	23510.120.065	M16X95	10	23510.160.095	M24X110	5	23510.240.110
M12X75	10	23510.120.075	M16X110	10	23510.160.110	M24X115	5	23510.240.115
M12X80	10	23510.120.080				M24X120	5	23510.240.120
			M20X100	5	23510.200.100	M24X130	5	23510.240.130
M16X75	10	23510.160.075	M20X105	5	23510.200.105	M24X150	5	23510.240.150
M16X80	10	23510.160.080	M20X110	5	23510.200.110			
M16X85	10	23510.160.085				M27X140	2	23510.270.140
M16X90	10	23510.160.090						

23530 Śruby dwustronne ze zredukowanym trzpieniem i dwiema nakrętkami sześciokątnymi

G90A

Gwint: Metryczny
Materiał: Stal 21CrMoV5-7+QT/25CrMo4+QT
Klasa: GA/KG

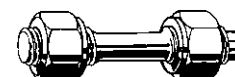

d ₁ x L	☒	Kod artykułu	d ₁ x L	☒	Kod artykułu	d ₁ x L	☒	Kod artykułu
M12X65	10	23530.120.065	M20X110	5	23530.200.110	M24X150	5	23530.240.150
M12X75	10	23530.120.075	M20X120	5	23530.200.120			
			M20X140	5	23530.200.140	M27X130	2	23530.270.130
M16X75	10	23530.160.075				M27X140	2	23530.270.140
M16X85	10	23530.160.085	M24X110	5	23530.240.110			
M16X90	10	23530.160.090	M24X120	5	23530.240.120	M30X160	2	23530.300.160
M16X100	10	23530.160.100	M24X125	5	23530.240.125	M30X180	2	23530.300.180
			M24X130	5	23530.240.130			
M20X100	5	23530.200.100	M24X140	5	23530.240.140			

23550	Śruby dwustronne ze zredukowanym trzpieniem i dwiema nakrętkami sześciokątnymi				G90A
Gwint	Metryczny				
Materiał	Steel C35E+QT				
Klasa	YK/YK				

$d_1 \times L$	☒	Kod artykułu	$d_1 \times L$	☒	Kod artykułu	$d_1 \times L$	☒	Kod artykułu
M12X65	10	23550.120.065	M16X100	10	23550.160.100	M24X110	5	23550.240.110
M12X70	10	23550.120.070	M16X105	10	23550.160.105	M24X115	5	23550.240.115
M12X75	10	23550.120.075				M24X125	5	23550.240.125
M12X80	10	23550.120.080	M20X95	5	23550.200.095	M24X130	5	23550.240.130
M16X75	10	23550.160.075	M20X100	5	23550.200.100	M24X140	5	23550.240.140
M16X80	10	23550.160.080	M20X105	5	23550.200.105	M24X150	5	23550.240.150
M16X85	10	23550.160.085	M20X110	5	23550.200.110			
M16X90	10	23550.160.090	M20X120	5	23550.200.120	M30X140	2	23550.300.140

4

Nakrętki sześciokątne do śrub dwustronnych ze zmniejszonym trzpieniem

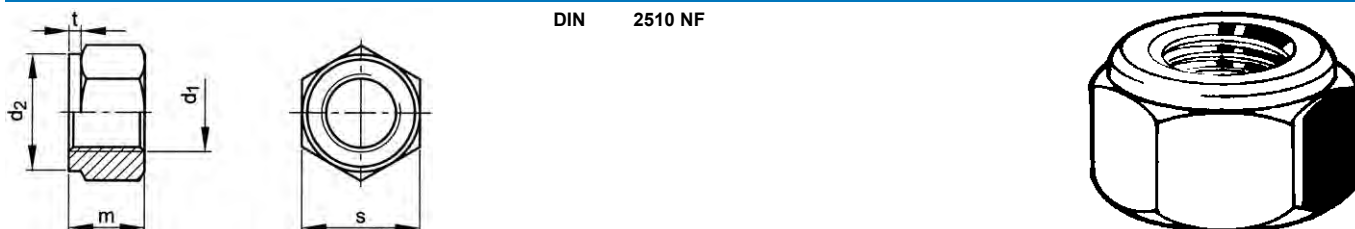

Informacje techniczne

d_1	d_2	m	P	s	t
M12	21	12	1.75	22	2
M16	26	16	2	27	2
M20	31	20	2.5	32	2
M24	35	24	3	36	3
M27	40	27	3	41	3
M30	45	30	3.5	46	3
M33	49	33	3.5	50	3
M36	53.5	36	4	55	3

- Dane techniczne, właściwości materiałowe i wy tłumaczenie oznaczeń, patrz strona INFO.
- Gwint zewnętrzny zgodny z DIN 2510-2.

Grupy katalogowe

Gwint	Gniazdo	Materiał	Klasa	Kod	Strona
M	Sześciokąt	St	KG	23620	4-62
M	Sześciokąt	St	YK	23660	4-62

23620	Nakrętki sześciokątne do śrub dwustronnych ze zmniejszonym trzpieniem				G90A
Gwint	Metryczny				
Materiał	Steel 25CrMo4+QT				
Klasa	KG				

d_1	☒	Kod artykułu	d_1	☒	Kod artykułu	d_1	☒	Kod artykułu
M12	50	23620.120.001	M24	25	23620.240.001	M33	5	23620.330.001
M16	50	23620.160.001	M27	10	23620.270.001	M36	5	23620.360.001
M20	25	23620.200.001	M30	10	23620.300.001			

23660	Nakrętki sześciokątne do śrub dwustronnych ze zmniejszonym trzpieniem				G90A
Gwint	Metryczny				
Materiał	Steel C35E+QT				
Klasa	YK				

d_1	☒	Kod artykułu	d_1	☒	Kod artykułu	d_1	☒	Kod artykułu
M12	50	23660.120.001	M20	25	23660.200.001	M27	10	23660.270.001
M16	50	23660.160.001	M24	25	23660.240.001	M30	10	23660.300.001

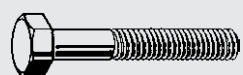

1 Śruby

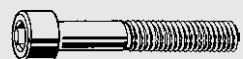

2 Produkty z gniazdem sześciokątnym



3 Nakrętki, nitonakrętki & wkładki



4 Pręty gwintowane & śruby dwustronne



5 Haki & śruby oczkowe



6 Wkręty

I Index



7 Podkładki & pierścienie uszczelniające typu “O-ring”



8 Kotwy, kołki, dyble

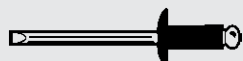

9 Nity, kołki & wpusty



10 Elementy łączące systemowe, meblowe & zabezpieczające



11 Zestawy

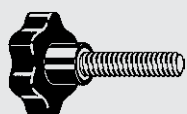



















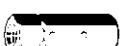

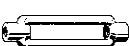

























12 Części konstrukcyjne & części maszynowe



13 Przemysł morski

T Technologia łączenia

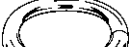
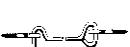
Haki & śruby oczkowe⁵

 Strona 5-2 DIN 186 B Młotczkowe	 Strona 5-3 Młotczkowe 28/15	 Strona 5-4 DIN 444 B Oczkowe	 Strona 5-6 DIN 444 LB Oczkowe z pełnym gwintem	 Strona 5-7 DIN 580 Śruby z uchem, CE
 Strona 5-9 DIN ≈580 (1957) Śruby z uchem BSW	 Strona 5-10 DIN 582 Nakrętki z uchem, CE	 Strona 5-12 DIN ≈582 (1957) Nakrętki z uchem, BSW	 Strona 5-13 DIN 1478 Nakrętki napinające rurowe	 Strona 5-13 DIN ≈1479 Nakrętki napinające sześciokątne
 Strona 5-14 DIN 1480 Z 2 końcami do przyspawania, metryczna	 Strona 5-15 DIN 1480 Nakrętki napinające otwarte	 Strona 5-15 DIN ≈1480 Z hakiem i uchem	 Strona 5-16 DIN ≈1480 Z hakiem i uchem, stal nierdzewna	 Strona 5-16 DIN ≈1480 Napinające z 2 uchami
 Strona 5-17 DIN ≈1480 Napinająca z 2 uchami, stal nierdzewna	 Strona 5-18 DIN ≈1480 Napinająca z 2 hakami	 Strona 5-18 DIN ≈1480 Napinająca z 2 hakami, stal nierdzewna	 Strona 5-19 DIN ≈1480 Z dwoma płaskimi uchami	 Strona 5-19 DIN ≈82101 A Szekle stalowe
 Strona 5-20 Szekle nierdzewne	 Strona 5-21 Szekle stalowe	 Strona 5-22 Szekle omega stalowe	 Strona 5-23 Szekle omega, nierdzewne	 Strona 5-24 DIN 741/555 (1987) Zaciski linowe kabłąkowe
 Strona 5-25 Zaciski linowe kabłąkowe nierdzewne	 Strona 5-26 Karabińczyki stalowe i nierdzewne	 Strona 5-27 Kausze, stal	 Strona 5-28 Haki oczkowe, metryczne	 Strona 5-29 Haki otwarte, metryczne
 Strona 5-29 Haki proste, metryczne	 Strona 5-30 Haki oczkowe, niemetryczne	 Strona 5-31 Haki oczkowe, typ mocny	 Strona 5-32 Haki oczkowe typ długi	 Strona 5-32 Haki sufitowe niemetryczne
 Strona 5-33 Haki niemetryczne, małe oczko	 Strona 5-34 Haki proste, niemetryczne	 Strona 5-35 Typ mocny, z gniazdem krzyżowym, niemetryczne	 Strona 5-35 Haki proste z końcówką zastrzoną	 Strona 5-36 Dwugwinty, stal
 Strona 5-37 Dwugwinty, nierdzewne	 Strona 5-37 Dwugwinty z częścią sześciokątną	 Strona 5-38 Dwugwinty z częścią sześciokątną, nierdzewne	 Strona 5-39 Dwugwinty z częścią sześciokątną i gniazdem TX	 Strona 5-40 Wkręty huśtawkowo-gimnastyczne, niemetryczne
 Strona 5-41 Wkręty huśtawkowo-gimnastyczne, metryczne	 Strona 5-41 Do wkrętów huśtawkowo-gimnastycznych	 Strona 5-42 Haki do bram	 Strona 5-42 Haki w kształcie litery S	

Śruby z łbem młoteczkowym z podsadzeniem

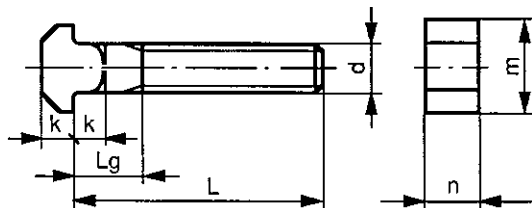

DIN 186 B
NEN 2309

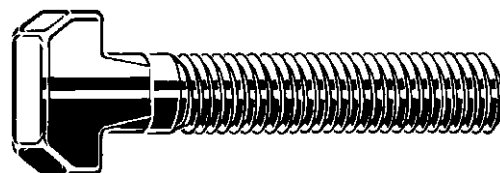

Informacje techniczne

d	k	Lg (maks.)	m	n	P
M8	5.5	13	18	8	1.25
M10	7	16	21	10	1.5
M12	8	19	26	12	1.75
M16	10.5	25	30	16	2
M20	13	31	36	20	2.5
M24	15	37	43	24	3
M27 (#DIN)	18	40	48	27	3
M30	19	43	54	30	3.5

- Rozmiary rowków teowych, patrz DIN 649.

Grupy katalogowe

Gwint	Materiał	Klasa	Kod	Strona
M	St	≥3.6	16190	5-2
M	St.St. A4		55782	5-2

16190 Śruby z łbem młoteczkowym z podsadzeniem

F11D

Gwint Metryczny
Materiał Stal
Klasa ≥3.6



d x L	☒	Kod artykułu	d x L	☒	Kod artykułu	d x L	☒	Kod artykułu
M8X30	25	16190.080.030	M16X40	10	16190.160.040	M20X180	5	16190.200.180
M8X40	25	16190.080.040	M16X50	10	16190.160.050	M20X200	5	16190.200.200
M8X50	25	16190.080.050	M16X60	10	16190.160.060			
M8X60	25	16190.080.060	M16X70	10	16190.160.070	M24X60	5	16190.240.060
			M16X80	10	16190.160.080	M24X70	5	16190.240.070
M10X30	25	16190.100.030	M16X90	10	16190.160.090	M24X80	5	16190.240.080
M10X40	25	16190.100.040	M16X100	10	16190.160.100	M24X90	5	16190.240.090
M10X50	25	16190.100.050	M16X110	10	16190.160.110	M24X100	5	16190.240.100
M10X60	25	16190.100.060	M16X120	10	16190.160.120	M24X110	5	16190.240.110
M10X70	25	16190.100.070	M16X140	10	16190.160.140	M24X120	5	16190.240.120
			M16X160	10	16190.160.160	M24X140	5	16190.240.140
M12X30	10	16190.120.030	M16X180	10	16190.160.180	M24X160	5	16190.240.160
M12X40	10	16190.120.040	M16X200	10	16190.160.200	M24X180	5	16190.240.180
M12X50	10	16190.120.050				M24X200	5	16190.240.200
M12X60	10	16190.120.060	M20X50	5	16190.200.050			
M12X70	10	16190.120.070	M20X60	5	16190.200.060	M30X90	3	16190.300.090
M12X80	10	16190.120.080	M20X70	5	16190.200.070	M30X100	3	16190.300.100
M12X90	10	16190.120.090	M20X80	5	16190.200.080	M30X110	3	16190.300.110
M12X100	10	16190.120.100	M20X90	5	16190.200.090	M30X120	3	16190.300.120
M12X110	10	16190.120.110	M20X100	5	16190.200.100	M30X130	3	16190.300.130
M12X120	10	16190.120.120	M20X110	5	16190.200.110	M30X140	3	16190.300.140
M12X140	10	16190.120.140	M20X120	5	16190.200.120	M30X160	3	16190.300.160
M12X160	10	16190.120.160	M20X140	5	16190.200.140	M30X200	3	16190.300.200
			M20X160	5	16190.200.160	M30X260	3	16190.300.260

55782 Śruby z łbem młoteczkowym z podsadzeniem

R49A

Gwint Metryczny
Materiał Stal nierdzewna A4



d x L	☒	Kod artykułu	d x L	☒	Kod artykułu	d x L	☒	Kod artykułu
M8X30	10	55782.080.030	M10X70	10	55782.100.070	M16X50	5	55782.160.050
M8X40	10	55782.080.040				M16X70	5	55782.160.070
M8X50	10	55782.080.050	M12X40	5	55782.120.040	M16X80	5	55782.160.080
M8X60	10	55782.080.060	M12X60	5	55782.120.060	M16X100	5	55782.160.100
M10X30	10	55782.100.030	M12X70	5	55782.120.070			
M10X40	10	55782.100.040	M12X90	5	55782.120.090	M20X70	3	55782.200.070
M10X50	10	55782.100.050	M12X100	5	55782.120.100	M20X100	3	55782.200.100

Śruby młotczkowe 28/15

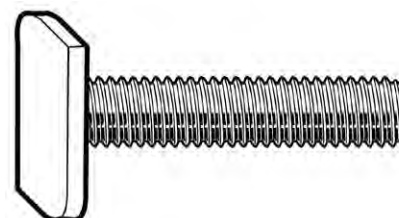
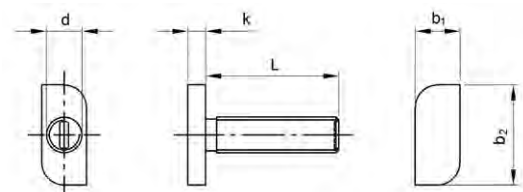

Informacje techniczne

Typ	b ₁	b ₂	k
M8	10	22.5	4
M10	10	22.5	4.5

Grupy katalogowe

Gwint	Materiał	Kod	Strona
M	St.St. A2	51740	5-3
M	St.St. A4	55740	5-3

51740 Śruby młotczkowe 28/15

R09A

Gwint Metryczny
Materiał Stal nierdzewna A2

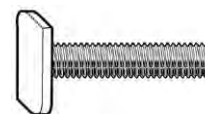

d x L	☒	Kod artykułu	d x L	☒	Kod artykułu	d x L	☒	Kod artykułu
M8X16*	100	51740.080.016	M8X53*	100	51740.080.053	M10X35*	100	51740.100.035
M8X20*	100	51740.080.020	M8X60*	100	51740.080.060	M10X40*	100	51740.100.040
M8X25*	100	51740.080.025	M8X65*	100	51740.080.065	M10X50*	100	51740.100.050
M8X30*	100	51740.080.030	M8X70*	100	51740.080.070	M10X60*	100	51740.100.060
M8X35*	100	51740.080.035	M10X20*	100	51740.100.020	M10X70*	100	51740.100.070
M8X40*	100	51740.080.040	M10X25*	100	51740.100.025	M10X80*	100	51740.100.080
M8X45*	100	51740.080.045	M10X30*	100	51740.100.030	M10X50*	100	51740.100.100
M8X50*	100	51740.080.050						

55740 Śruby młotczkowe 28/15

R09A

Gwint Metryczny
Materiał Stal nierdzewna A4

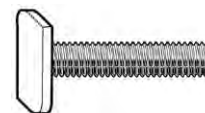

d x L	☒	Kod artykułu	d x L	☒	Kod artykułu	d x L	☒	Kod artykułu
M8X30*	100	55740.080.030	M10X25*	100	55740.100.025	M10X30*	100	55740.100.030
M10X20*	100	55740.100.020						

Śruby oczkowe

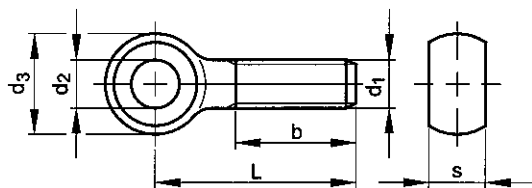

DIN 444 B
NEN 2310 B

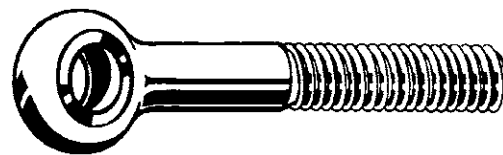

Informacje techniczne

d ₁	b (min.): L≤125mm	b (min.): 125mm<L≤200mm	b (min.): L>200mm	d ₂ (H9)	d ₃ (maks.)	P	s (maks.)
M6	18	-	-	6	14	1	7
M8	22	28	-	8	18	1.25	9
M10	26	32	-	10	20	1.5	12
M12	30	36	49	12	25	1.75	14
M16	38	44	57	16	32	2	17
M20	46	52	65	18	40	2.5	22
M24	54	60	73	22	45	3	25
M27	60	66	79	25	50	3	27
M30	66	72	85	28	55	3.5	30

Grupy katalogowe

Gwint	Materiał	Klasa	Kod	Strona
M	St	4.6	16180	5-4
M	St.St. A2	50	51790	5-5
M	St.St. A4	50	55790	5-5

16180 Śruby oczkowe

F11D

Gwint Metryczny
Materiał Stal
Klasa 4.6

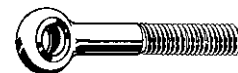

d ₁ x L	☒	Kod artykułu	d ₁ x L	☒	Kod artykułu	d ₁ x L	☒	Kod artykułu
M6X30	25	16180.060.030	M12X60	10	16180.120.060	M20X140	5	16180.200.140
M6X40	25	16180.060.040	M12X70	10	16180.120.070	M20X150	5	16180.200.150
M6X50	25	16180.060.050	M12X80	10	16180.120.080	M20X160	5	16180.200.160
M6X60	25	16180.060.060	M12X90	10	16180.120.090	M20X180	5	16180.200.180
M6X70	25	16180.060.070	M12X100	10	16180.120.100	M20X200	5	16180.200.200
M6X80	25	16180.060.080	M12X110	10	16180.120.110	M20X260	5	16180.200.260
M8X40	25	16180.080.040	M12X120	10	16180.120.120	M24X80	5	16180.240.080
M8X45	25	16180.080.045	M12X130	10	16180.120.130	M24X100	5	16180.240.100
M8X50	25	16180.080.050	M12X140	10	16180.120.140	M24X110	5	16180.240.110
M8X60	25	16180.080.060	M12X150	10	16180.120.150	M24X120	5	16180.240.120
M8X70	25	16180.080.070	M16X60	10	16180.160.060	M24X130	5	16180.240.130
M8X80	25	16180.080.080	M16X70	10	16180.160.070	M24X140	5	16180.240.140
M8X90	25	16180.080.090	M16X80	10	16180.160.080	M24X150	5	16180.240.150
M8X100	25	16180.080.100	M16X90	10	16180.160.090	M24X160	5	16180.240.160
M8X110	25	16180.080.110	M16X100	10	16180.160.100	M24X180	5	16180.240.180
M8X120	25	16180.080.120	M16X110	10	16180.160.110	M24X200	5	16180.240.200
M8X130	25	16180.080.130	M16X120	10	16180.160.120	M24X220	5	16180.240.220
M8X140	25	16180.080.140	M16X130	10	16180.160.130	M27X120	5	16180.270.120
M10X40	25	16180.100.040	M16X140	10	16180.160.140	M27X140	5	16180.270.140
M10X50	25	16180.100.050	M16X150	10	16180.160.150	M27X160	5	16180.270.160
M10X60	25	16180.100.060	M16X160	10	16180.160.160	M27X180	5	16180.270.180
M10X65	25	16180.100.065	M16X180	10	16180.160.180	M27X200	5	16180.270.200
M10X70	25	16180.100.070	M16X200	10	16180.160.200	M30X120	3	16180.300.120
M10X80	25	16180.100.080	M20X60	5	16180.200.060	M30X140	3	16180.300.140
M10X90	25	16180.100.090	M20X80	5	16180.200.080	M30X160	3	16180.300.160
M10X100	25	16180.100.100	M20X100	5	16180.200.100	M30X180	3	16180.300.180
M10X110	25	16180.100.110	M20X110	5	16180.200.110	M30X200	3	16180.300.200
M10X120	25	16180.100.120	M20X120	5	16180.200.120			
M10X130	25	16180.100.130	M20X130	5	16180.200.130			

51790	Śruby oczkowe	R09A
Gwint	Metryczny	
Material	Stal nierdzewna A2	
Klasa	50	

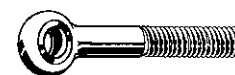

d ₁ x L	☒	Kod artykułu	d ₁ x L	☒	Kod artykułu	d ₁ x L	☒	Kod artykułu
M6X30	10	51790.060.030	M10X80	10	51790.100.080	M16X160	3	51790.160.160
M6X35	10	51790.060.035	M10X90	10	51790.100.090	M16X180	3	51790.160.180
M6X40	10	51790.060.040	M10X100	10	51790.100.100	M16X200	3	51790.160.200
M6X45	10	51790.060.045	M10X110	5	51790.100.110			
M6X50	10	51790.060.050	M10X120	5	51790.100.120	M20X70*	10	51790.200.070
M6X55	10	51790.060.055	M10X130	5	51790.100.130	M20X75	2	51790.200.075
M6X60	10	51790.060.060	M10X140	5	51790.100.140	M20X80	2	51790.200.080
M6X70	10	51790.060.070				M20X90	2	51790.200.090
M6X80	10	51790.060.080	M12X50	5	51790.120.050	M20X100	2	51790.200.100
			M12X55	5	51790.120.055	M20X110	2	51790.200.110
M8X30	10	51790.080.030	M12X60	5	51790.120.060	M20X120	2	51790.200.120
M8X35	10	51790.080.035	M12X65	5	51790.120.065	M20X130	2	51790.200.130
M8X40	10	51790.080.040	M12X70	5	51790.120.070	M20X140	2	51790.200.140
M8X45	10	51790.080.045	M12X75	5	51790.120.075	M20X150	1	51790.200.150
M8X50	10	51790.080.050	M12X80	5	51790.120.080	M20X160	1	51790.200.160
M8X55	10	51790.080.055	M12X90	5	51790.120.090	M20X180	1	51790.200.180
M8X60	10	51790.080.060	M12X100	5	51790.120.100	M20X200	1	51790.200.200
M8X65*	50	51790.080.065	M12X110	3	51790.120.110			
M8X70	10	51790.080.070	M12X120	3	51790.120.120	M24X80	3	51790.240.080
M8X75	10	51790.080.075	M12X130	3	51790.120.130	M24X90	3	51790.240.090
M8X80	10	51790.080.080	M12X140	3	51790.120.140	M24X100*	10	51790.240.100
M8X90	10	51790.080.090	M12X150	3	51790.120.150	M24X110	3	51790.240.110
M8X100	10	51790.080.100				M24X120	3	51790.240.120
M8X110	5	51790.080.110	M16X60	5	51790.160.060	M24X130	3	51790.240.130
M8X120	5	51790.080.120	M16X65	5	51790.160.065	M24X140	3	51790.240.140
M8X140	5	51790.080.140	M16X70	5	51790.160.070	M24X150	3	51790.240.150
			M16X75*	25	51790.160.075	M24X180	3	51790.240.180
M10X40	10	51790.100.040	M16X80	5	51790.160.080	M24X200	3	51790.240.200
M10X45	10	51790.100.045	M16X90	5	51790.160.090	M24X220	3	51790.240.220
M10X50	10	51790.100.050	M16X100	5	51790.160.100			
M10X55	10	51790.100.055	M16X110	5	51790.160.110	M27X120	3	51790.270.120
M10X60	10	51790.100.060	M16X120	3	51790.160.120	M27X160	3	51790.270.160
M10X65	10	51790.100.065	M16X130	3	51790.160.130	M27X180	3	51790.270.180
M10X70	10	51790.100.070	M16X140	3	51790.160.140	M27X200	3	51790.270.200
M10X75	10	51790.100.075	M16X150	3	51790.160.150			

5

55790	Śruby oczkowe	R49A
Gwint	Metryczny	
Material	Stal nierdzewna A4	
Klasa	50	

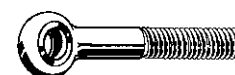

d ₁ x L	☒	Kod artykułu	d ₁ x L	☒	Kod artykułu	d ₁ x L	☒	Kod artykułu
M6X30	10	55790.060.030	M10X70	10	55790.100.070	M16X90	5	55790.160.090
M6X35*	50	55790.060.035	M10X75*	25	55790.100.075	M16X100	5	55790.160.100
M6X40	10	55790.060.040	M10X80	10	55790.100.080	M16X110*	25	55790.160.110
M6X45*	50	55790.060.045	M10X90	10	55790.100.090	M16X120	3	55790.160.120
M6X50	10	55790.060.050	M10X100	10	55790.100.100	M16X130	3	55790.160.130
M6X55*	50	55790.060.055	M10X110*	25	55790.100.110	M16X140*	10	55790.160.140
M6X60*	50	55790.060.060	M10X120*	25	55790.100.120	M16X150*	10	55790.160.150
M8X30	10	55790.080.030	M12X50	5	55790.120.050	M20X70*	10	55790.200.070
M8X35*	50	55790.080.035	M12X55*	25	55790.120.055	M20X75*	10	55790.200.075
M8X40	10	55790.080.040	M12X60	5	55790.120.060	M20X80	2	55790.200.080
M8X45*	50	55790.080.045	M12X65*	25	55790.120.065	M20X90	2	55790.200.090
M8X50	10	55790.080.050	M12X70	5	55790.120.070	M20X100	2	55790.200.100
M8X55*	50	55790.080.055	M12X75*	25	55790.120.075	M20X110*	10	55790.200.110
M8X60	10	55790.080.060	M12X80	5	55790.120.080	M20X120	2	55790.200.120
M8X65*	50	55790.080.065	M12X90	5	55790.120.090	M20X130*	10	55790.200.130
M8X70	10	55790.080.070	M12X100	5	55790.120.100	M20X140*	10	55790.200.140
M8X75*	50	55790.080.075	M12X110*	25	55790.120.110	M20X150*	10	55790.200.150
M8X80	10	55790.080.080	M12X120	3	55790.120.120	M20X180	1	55790.200.180
M8X90	10	55790.080.090	M12X130*	25	55790.120.130			
M8X100	10	55790.080.100	M12X140*	10	55790.120.140	M24X80*	10	55790.240.080
			M12X150*	10	55790.120.150	M24X90*	10	55790.240.090
M10X40	10	55790.100.040				M24X100	3	55790.240.100
M10X45*	25	55790.100.045	M16X60*	25	55790.160.060	M24X110*	10	55790.240.110
M10X50	10	55790.100.050	M16X65*	25	55790.160.065	M24X120	3	55790.240.120
M10X55*	25	55790.100.055	M16X70	5	55790.160.070	M24X130*	10	55790.240.130
M10X60	10	55790.100.060	M16X75*	25	55790.160.075	M24X140	3	55790.240.140
M10X65*	25	55790.100.065	M16X80	5	55790.160.080	M24X150*	10	55790.240.150

d₁ x L	☒	Kod artykułu
M24X220	10	55790.240.220

Śruby oczkowe z gwintem na całej długości

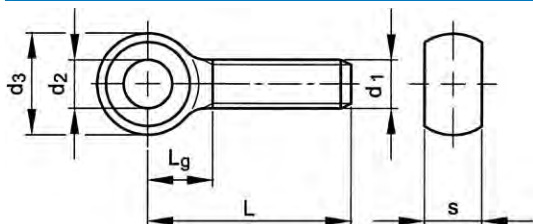

DIN 444 LB
NEN 2310 B

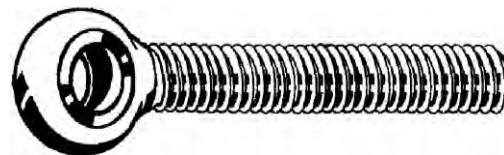

Informacje techniczne

d ₁	d ₂ (H9)	d ₃ (maks.)	Lg (maks.)	P	s (maks.)
M5	5	12	11	0.8	6
M6	6	14	14	1	7
M8	8	18	16	1.25	9
M10	10	20	18	1.5	12
M12	12	25	23	1.75	14
M16	16	32	27	2	17
M20	18	40	32	2.5	22

16182 Śruby oczkowe z gwintem na całej długości

F11D

Gwint Metryczny
Materiał Stal
Klasa 4.6
Obróbka powierzchni O cynkowane



d ₁ x L	☒	Kod artykułu	d ₁ x L	☒	Kod artykułu	d ₁ x L	☒	Kod artykułu
M5X25	50	16182.050.025	M10X75	25	16182.100.075	M16X90	10	16182.160.090
M5X35	50	16182.050.035	M10X80	25	16182.100.080	M16X100	10	16182.160.100
M6X30	25	16182.060.030	M10X100	25	16182.100.100	M16X110	10	16182.160.110
M6X40	25	16182.060.040	M10X120	25	16182.100.120	M16X120	10	16182.160.120
M6X50	25	16182.060.050	M10X140	25	16182.100.140	M16X140	10	16182.160.140
M8X40	25	16182.080.040	M12X60	10	16182.120.060	M16X160	10	16182.160.160
M8X50	25	16182.080.050	M12X70	10	16182.120.070	M16X180	10	16182.160.180
M8X60	25	16182.080.060	M12X80	10	16182.120.080	M16X200	10	16182.160.200
M8X80	25	16182.080.080	M12X100	10	16182.120.100	M20X100	5	16182.200.100
M10X40	25	16182.100.040	M12X110	10	16182.120.110	M20X120	5	16182.200.120
M10X50	25	16182.100.050	M12X120	10	16182.120.120	M20X140	5	16182.200.140
M10X60	25	16182.100.060	M12X140	10	16182.120.140	M20X150	5	16182.200.150
M10X70	25	16182.100.070	M16X70	10	16182.160.070	M20X160	5	16182.200.160
			M16X80	10	16182.160.080	M20X180	5	16182.200.180
						M20X200	5	16182.200.200

Śruby z uchem z oznaczeniem CE, metryczne

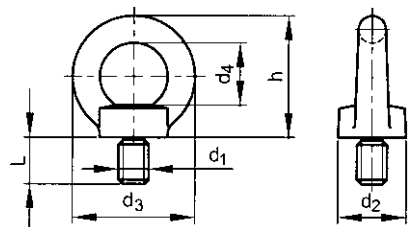

DIN 580
ISO 3266
NEN 1927
BS 4278

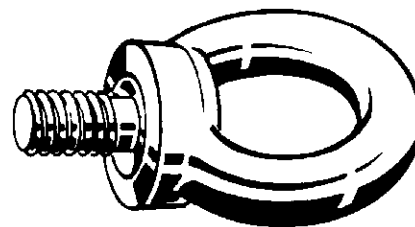

Informacje techniczne

d ₁	d ₂	d ₃	d ₄	h	L	P
M6 (#DIN)	20	36	20	36	13	1
M8	20	36	20	36	13	1.25
M10	25	45	25	45	17	1.5
M12	30	54	30	53	20.5	1.75
M14 (#DIN)	30	54	30	53	20.5	2
M16	35	63	35	62	27	2
M18 (#DIN)	35	63	35	62	27	2.5
M20	40	72	40	71	30	2.5
M22 (#DIN)	40	72	40	71	30	2.5
M24	50	90	50	90	36	3
M27 (#DIN)	50	90	50	90	36	3
M30	65	108	60	109	45	3.5
M33 (#DIN)	65	108	60	109	45	3.5
M36	75	126	70	128	54	4
M39 (#DIN)	75	126	70	128	54	4
M42	85	144	80	147	63	4.5
M45 (#DIN)	85	144	80	147	63	4.5
M48	100	166	90	168	68	5
M52 (#DIN)	110	184	100	187	78	5
M56	110	184	100	187	78	5.5
M64	120	206	110	208	90	6
M72x6	150	260	140	260	100	6

- Jeżeli śruba z uchem do podnoszenia stanowi część wyposażenia do podnoszenia, niezbędne jest oznakowanie CE.
- Śruba z uchem nie wymaga oznaczenia CE, jeżeli nie jest używana do podnoszenia (na przykład jako śruba do holowania) lub jest użyta do podnoszenia tylko raz (na przykład do przemieszczania maszyn).

Maksymalne obciążenie L (N)

		M6	M8	M10	M12	M14	M16	M18	M20	M22	M24	M27
1 x śruba		900	1400	2300	3400	5000	7000	9300	12000	15000	18000	25000
2 x śruba		600	1000	1700	2400	3500	5000	6500	8600	10500	12900	18300

		M30	M33	M36	M39	M42	M45	M48	M52	M56	M64	M72x6
1 x śruba		32000	42000	46000	60000	63000	78000	86000	99000	115000	160000	200000
2 x śruba		23000	30500	33000	44000	45000	55000	61000	71000	82000	110000	140000

Grupy katalogowe

Gwint	Material	Klasa	Obróbka powierzchni	Kod	Strona
M	St C15E			16000	5-8
M	St C15E		Ocynk.	16010	5-8
M	St.St. A2		cast	51940	5-8
M	St.St. A2	50	kute	51941	5-8
M	St.St. A4		cast	55940	5-8
M	St.St. A4	50	kute	55941	5-9

16000 Śruby z uchem F11E
Gwint Metryczny
Materiał Stal C15E

CE

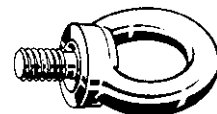

d ₁	☒	Kod artykułu	d ₁	☒	Kod artykułu	d ₁	☒	Kod artykułu
M6	25	16000.060.001	M20	10	16000.200.001	M39	1	16000.390.001
M8	25	16000.080.001	M22	5	16000.220.001	M42	1	16000.420.001
M10	25	16000.100.001	M24	5	16000.240.001	M48	1	16000.480.001
M12	25	16000.120.001	M27	5	16000.270.001	M56	1	16000.560.001
M14	10	16000.140.001	M30	1	16000.300.001	M64	1	16000.640.001
M16	10	16000.160.001	M33	1	16000.330.001			
M18	10	16000.180.001	M36	1	16000.360.001	M72X6,00	1	16000.720.001

16010 Śruby z uchem F11E
Gwint Metryczny
Materiał Stal C15E
Obróbka powierzchni Ocynkowane

CE

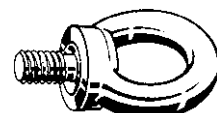

d ₁	☒	Kod artykułu	d ₁	☒	Kod artykułu	d ₁	☒	Kod artykułu
M6	25	16010.060.001	M20	10	16010.200.001	M39	1	16010.390.001
M8	25	16010.080.001	M22	5	16010.220.001	M42	1	16010.420.001
M10	25	16010.100.001	M24	5	16010.240.001	M45	1	16010.450.001
M12	25	16010.120.001	M27	5	16010.270.001	M48	1	16010.480.001
M14	10	16010.140.001	M30	1	16010.300.001	M52	1	16010.520.001
M16	10	16010.160.001	M33	1	16010.330.001	M56	1	16010.560.001
M18	10	16010.180.001	M36	1	16010.360.001	M64	1	16010.640.001

51940 Śruby z uchem, cast R09A
Gwint Metryczny
Materiał Stal nierdzewna A2
DIN #580

CE

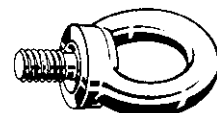

d ₁	☒	Kod artykułu	d ₁	☒	Kod artykułu	d ₁	☒	Kod artykułu
M6	10	51940.060.001	M16	5	51940.160.001	M27	3	51940.270.001
M8	10	51940.080.001	M20	5	51940.200.001	M30	1	51940.300.001
M10	10	51940.100.001	M24	3	51940.240.001	M36*	1	51940.360.001
M12	10	51940.120.001						

51941 Śruby z uchem, kute R09A
Gwint Metryczny
Materiał Stal nierdzewna A2
Klasa 50

CE

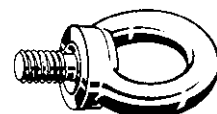

d ₁	☒	Kod artykułu	d ₁	☒	Kod artykułu	d ₁	☒	Kod artykułu
M6*	25	51941.060.001	M16*	10	51941.160.001	M27*	5	51941.270.001
M8*	25	51941.080.001	M20*	10	51941.200.001	M30*	5	51941.300.001
M10*	25	51941.100.001	M24*	5	51941.240.001	M36*	1	51941.360.001
M12*	10	51941.120.001						

55940 Śruby z uchem, cast R49A
Gwint Metryczny
Materiał Stal nierdzewna A4
DIN #580

CE

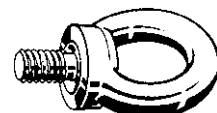

d ₁	☒	Kod artykułu	d ₁	☒	Kod artykułu	d ₁	☒	Kod artykułu
M6	10	55940.060.001	M16	5	55940.160.001	M27	3	55940.270.001
M8	10	55940.080.001	M20	5	55940.200.001	M30	1	55940.300.001
M10	10	55940.100.001	M24	3	55940.240.001	M36*	1	55940.360.001
M12	10	55940.120.001						

55941	Śruby z uchem, kute						R49A
Gwint	Metryczny						
Materiał	Stal nierdzewna A4						
Klasa	50						

d_1	☒	Kod artykułu	d_1	☒	Kod artykułu	d_1	☒	Kod artykułu
M6*	25	55941.060.001	M16*	10	55941.160.001	M27*	5	55941.270.001
M8*	25	55941.080.001	M20*	10	55941.200.001	M30*	5	55941.300.001
M10*	25	55941.100.001	M24*	5	55941.240.001	M36*	1	55941.360.001
M12*	10	55941.120.001						

Śruby z uchem, BSW

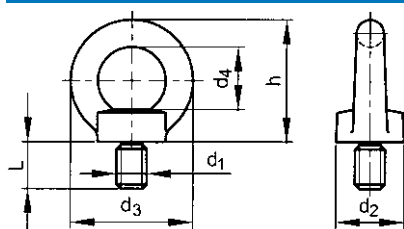

DIN ≈580 (1957)
NEN ≈2347 (1960)

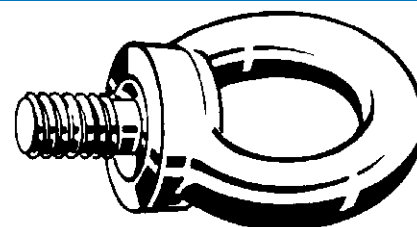

5

Informacje techniczne

d_1	d_2	d_3	d_4	h	L	Zwoje gwintu na cal
5/16	20	36	20	36	13	18
3/8	25	45	25	45	17	16
1/2	30	54	30	53	22	12
5/8	35	63	35	62	27	11
3/4	40	72	40	71	30	10
7/8	45	81	45	81	35	9
1 Inch	50	90	50	90	36	8
1.1/4	65	108	60	109	45	7
1.1/2	75	126	70	128	55	6
1.3/4	100	166	90	168	70	5
2 Inch	100	166	90	168	70	4.5

- Gwint Whitworth'a (BSW/BSF) nie jest zalecany do międzynarodowego stosowania. Zaleca się stosowanie gwintu metrycznego (M/MF) lub zunifikowanego (UNC/UNF).
- Materiał C15 został znormalizowany z minimalną odpornością na uderzenia 80 Jouli (próbka do badań ISO) odpowiadająca 90 Joulom (próbka do badań DIN).

Maksymalne obciążenie L (N)

		5/16	3/8	1/2	5/8	3/4	7/8	1.IN.	1.1/4	1.1/2	1.3/4	2.IN.
1 x śruba		1400	2300	3400	7000	12000	18000	18000	46000	63000	86000	115000
2 x śruba		1000	1700	2400	5000	8600	12900	12900	33000	45000	61000	82000

16040	Śruby z uchem, BSW						X08A
Gwint	Calowy, Whitworth'a (BSW)						
Materiał	Stal C15						

d_1	☒	Kod artykułu	d_1	☒	Kod artykułu	d_1	☒	Kod artykułu
5/16	25	16040.079.001	3/4	10	16040.191.001	1.1/2	1	16040.381.001
3/8	25	16040.096.001	7/8	5	16040.222.001	1.3/4	1	16040.444.001
1/2	25	16040.127.001	1 Inch	5	16040.254.001	2 Inch	1	16040.508.001
5/8	10	16040.158.001	1.1/4	1	16040.317.001			

Nakrętki z uchem z oznaczeniem CE

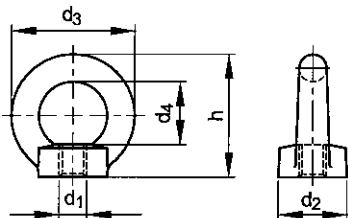

DIN 582
NEN 1928

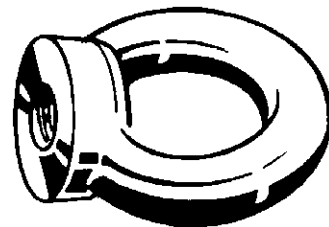

Informacje techniczne

d ₁	d ₂	d ₃	d ₄	h	P
M6 (#DIN)	20	36	20	36	1
M8	20	36	20	36	1.25
M10	25	45	25	45	1.5
M12	30	54	30	53	1.75
M14 (#DIN)	30	54	30	53	2
M16	35	63	35	62	2
M18 (#DIN)	35	63	35	62	2.5
M20	40	72	40	71	2.5
M22 (#DIN)	40	72	40	71	2.5
M24	50	90	50	90	3
M27 (#DIN)	65	108	60	109	3
M30	65	108	60	109	3.5
M33 (#DIN)	65	108	60	109	3.5
M36	75	126	70	128	4
M39 (#DIN)	75	126	70	128	4
M42	85	144	80	147	4.5
M48	100	166	90	168	5
M56	110	184	100	187	5.5
M64	120	206	110	208	6
M72x6	150	260	140	260	6

- Jeżeli śruba z nakrętką do podnoszenia stanowi część wyposażenia do podnoszenia, niezbędne jest oznakowanie CE.
- Nakrętka z uchem nie wymaga oznaczenia CE, jeżeli nie jest używana do podnoszenia (na przykład jako śruba do holowania).

Maksymalne obciążenie L (N)

		M6	M8	M10	M12	M14	M16	M18	M20	M22	M24	M27
1 x nakrętka		900	1400	2300	3400	5000	7000	9300	12000	15000	18000	25000
2 x nakrętka		600	1000	1700	2400	3500	5000	6500	8600	10500	12900	18300

		M30	M33	M36	M39	M42	M45	M48	M52	M56	M64	M72x6
1 x nakrętka		32000	42000	46000	60000	63000	78000	86000	99000	115000	160000	200000
2 x nakrętka		23000	30500	33000	44000	45000	55000	61000	71000	82000	110000	140000

Grupy katalogowe

Gwint	Materiał	Klasa	Obróbka powierzchni	Kod	Strona
M	St C15E			16100	5-11
M	St C15E		Ocynk.	16110	5-11
M	St.St. A2	50		kute 51950	5-11
M	St.St. A2			cast 51951	5-11
M	St.St. A4	50		kute 55950	5-11
M	St.St. A4			cast 55951	5-12

16100 Nakrętki z uchem z oznaczeniem CE						F11E		
Gwint	Metryczny							
Materiał	Stal C15E							
CE								
d_1	☒	Kod artykułu	d_1	☒	Kod artykułu	d_1	☒	Kod artykułu
M6	25	16100.060.001	M20	10	16100.200.001	M39	1	16100.390.001
M8	25	16100.080.001	M22	5	16100.220.001	M42	1	16100.420.001
M10	25	16100.100.001	M24	5	16100.240.001	M48	1	16100.480.001
M12	25	16100.120.001	M27	5	16100.270.001	M56	1	16100.560.001
M14	10	16100.140.001	M30	1	16100.300.001	M64	1	16100.640.001
M16	10	16100.160.001	M33	1	16100.330.001			
M18	10	16100.180.001	M36	1	16100.360.001	M72X6,00	1	16100.720.001

16110 Nakrętki z uchem z oznaczeniem CE						F11E		
Gwint	Metryczny							
Materiał	Stal C15E							
Obróbka powierzchni	O cynkowane							
CE								
d_1	☒	Kod artykułu	d_1	☒	Kod artykułu	d_1	☒	Kod artykułu
M6	25	16110.060.001	M20	10	16110.200.001	M36	1	16110.360.001
M8	25	16110.080.001	M22	5	16110.220.001	M39	1	16110.390.001
M10	25	16110.100.001	M24	5	16110.240.001	M42	1	16110.420.001
M12	25	16110.120.001	M27	5	16110.270.001	M48	1	16110.480.001
M14	10	16110.140.001	M30	1	16110.300.001	M56	1	16110.560.001
M16	10	16110.160.001	M33	1	16110.330.001	M64	1	16110.640.001
M18	10	16110.180.001						

51950 Nakrętka z uchem, kute						R09A		
Gwint	Metryczny							
Materiał	Stal nierdzewna A2							
Klasa	50							
CE								
d_1	☒	Kod artykułu	d_1	☒	Kod artykułu	d_1	☒	Kod artykułu
M6	10	51950.060.001	M16	5	51950.160.001	M27*	5	51950.270.001
M8	10	51950.080.001	M20	5	51950.200.001	M30*	5	51950.300.001
M10	10	51950.100.001	M24	3	51950.240.001	M36*	1	51950.360.001
M12	10	51950.120.001						

51951 Nakrętka z uchem, cast						R09A		
Gwint	Metryczny							
Materiał	Stal nierdzewna A2							
	DIN #582							
CE								
d_1	☒	Kod artykułu	d_1	☒	Kod artykułu	d_1	☒	Kod artykułu
M6*	25	51951.060.001	M16*	10	51951.160.001	M27*	5	51951.270.001
M8*	25	51951.080.001	M20*	10	51951.200.001	M30*	5	51951.300.001
M10*	25	51951.100.001	M24*	5	51951.240.001	M36*	1	51951.360.001
M12*	10	51951.120.001						

55950 Nakrętka z uchem, kute						R49A		
Gwint	Metryczny							
Materiał	Stal nierdzewna A4							
Klasa	50							
CE								
d_1	☒	Kod artykułu	d_1	☒	Kod artykułu	d_1	☒	Kod artykułu
M6*	25	55950.060.001	M12	10	55950.120.001	M24	3	55950.240.001
M8	10	55950.080.001	M16	5	55950.160.001	M27*	5	55950.270.001
M10	10	55950.100.001	M20	5	55950.200.001	M36*	1	55950.360.001

55951	Nakrętka z uchem, cast	R49A
Gwint	Metryczny	DIN #582
Materiał	Stal nierdzewna A4	

d_1	☒	Kod artykułu	d_1	☒	Kod artykułu	d_1	☒	Kod artykułu
M6*	25	55951.060.001	M16*	10	55951.160.001	M27*	5	55951.270.001
M8*	25	55951.080.001	M20*	10	55951.200.001	M30*	5	55951.300.001
M10*	25	55951.100.001	M24*	5	55951.240.001	M36*	1	55951.360.001
M12*	10	55951.120.001						

Nakrętki z uchem, BSW

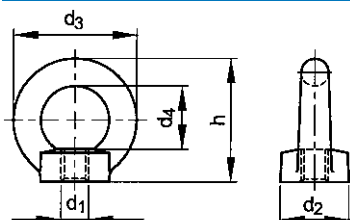

DIN ≈582 (1957)
NEN ≈2348 (1960)

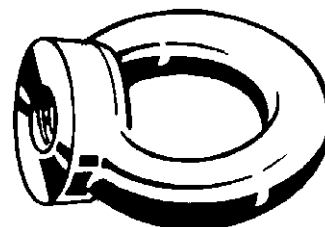

5

Informacje techniczne

d_1	d_2	d_3	d_4	h	Zwoje gwintu na cal
5/16	20	36	20	36	18
3/8	25	45	25	45	16
1/2	30	54	30	53	12
5/8	35	63	35	62	11
3/4	40	72	40	71	10
7/8	45	81	45	81	9
1 Inch	50	90	50	90	8
1.1/4	65	108	60	109	7
1.1/2	75	126	70	128	6
1.3/4	85	144	80	147	5
2 Inch	100	166	90	168	4.5

- Gwint Whitworth'a (BSW/BSF) nie jest zalecany do międzynarodowego stosowania.
- Zaleca się stosowanie gwintu metrycznego (M/MF) lub zunifikowanego (UNC/UNF).

Maksymalne obciążenie L (N)

		5/16	3/8	1/2	5/8	3/4	7/8	1.IN.	1.1/4	1.1/2	1.3/4	2.IN.
1 x nakrętka		1400	2300	3400	7000	12000	18000	18000	46000	63000	86000	115000
2 x nakrętka		1000	1700	2400	5000	8600	12900	12900	33000	45000	61000	82000

16140	Nakrętki z uchem, BSW	X08A
Gwint	Calowy, Whitworth'a (BSW)	
Materiał	Stal C15	

d_1	☒	Kod artykułu	d_1	☒	Kod artykułu	d_1	☒	Kod artykułu
5/16	25	16140.079.001	5/8	10	16140.158.001	1 Inch	5	16140.254.001
3/8	25	16140.096.001	3/4	10	16140.191.001	1.1/4	1	16140.317.001
1/2	25	16140.127.001	7/8	5	16140.222.001	1.1/2	1	16140.381.001

Nakrętki napinające rurowe

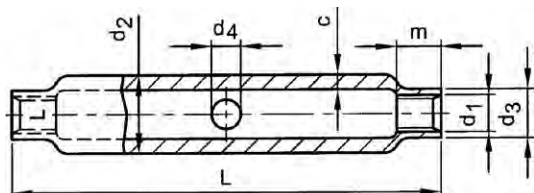

DIN 1478



Informacje techniczne

d ₁	c	d ₂ (min.)	d ₃	d ₄	L	m	P	Regulowane
M6	2.9	17.2	9	6	110	7.5	1	90
M8	3.6	17.2	12	8	110	10	1.25	85
M10	4	21.3	15	8	125	12	1.5	95
M12	4	25	18	10	125	15	1.75	90
M16	4.5	30	24	10	170	20	2	120
M20	5	33.7	30	12	200	24	2.5	140
M24	5.6	42.4	33	12	255	29	3	180

16151 Nakrętki napinające rurowe

F11F

Gwint Metryczny
 Materiał Stal
 Obróbka powierzchni Ocynkowane



d ₁	☒	Kod artykułu	d ₁	☒	Kod artykułu	d ₁	☒	Kod artykułu
M6	10	16151.060.001	M12	5	16151.120.001	M20	2	16151.200.001
M8	10	16151.080.001	M16	5	16151.160.001	M24	2	16151.240.001
M10	5	16151.100.001						

Nakrętki napinające sześciokątne

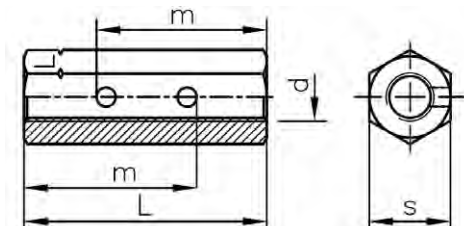

DIN ≈1479

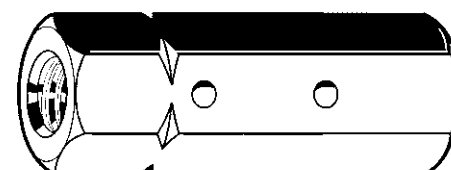

Informacje techniczne

d	L	m	P	Regulowane	s
M6	30	22.5	1	15	10
M8	35	25	1.25	15	13
M10	45	33	1.5	21	16
M12	55	40	1.75	25	18
M16	75	55	2	35	24
M20	95	24	2.5	47	30
M24	115	29	3	57	36

16153 Nakrętki napinające sześciokątne

F11F

Gwint Metryczny
 Materiał Stal Min.330N/mm²
 Obróbka powierzchni Ocynkowane

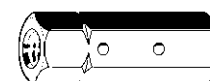

d	☒	Kod artykułu	d	☒	Kod artykułu	d	☒	Kod artykułu
M6	10	16153.060.001	M12	5	16153.120.001	M20	2	16153.200.001
M8	10	16153.080.001	M16	5	16153.160.001	M24	2	16153.240.001
M10	5	16153.100.001						

Nakrętki napinające otwarte

DIN 1480

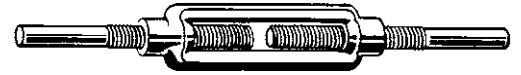
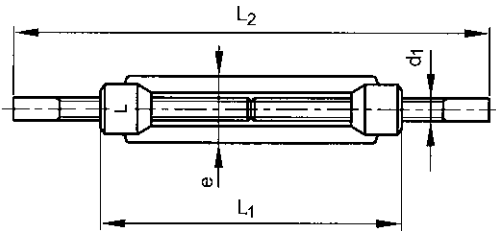

Informacje techniczne

d_1	e	L_1	L_2 (min.)	L_2 (maks.)	P	Dopuszczalne obciążenie w N
M6	19	110	240	338	1	2250
M8	23	110	240	338	1.25	4100
M10	30	125	300	407	1.5	6500
M12	34	125	300	407	1.75	9300
M16	42	170	400	543	2	17700
M20	52	200	440	606	2.5	27000
M24	60	255	520	736	3	39200
M30	74	255	520	736	3.5	62500
M36	86	295	600	840	4	91000
M42	104	330	700	967	4.5	125000
M48	135	355	760	1 037	5	165000
M56	135	355	820	1 097	5.5	230000

16160 Nakrętki napinające otwarte z dwoma końcówkami do spawania ze stali spawalnej klasy 3.6

F11F

Gwint Metryczny
 Materiał Stal Min.330N/mm²



d_1	☒	Kod artykułu	d_1	☒	Kod artykułu	d_1	☒	Kod artykułu
M6	10	16160.060.001	M16	5	16160.160.001	M36	1	16160.360.001
M8	10	16160.080.001	M20	2	16160.200.001	M42	1	16160.420.001
M10	5	16160.100.001	M24	2	16160.240.001	M48	1	16160.480.001
M12	5	16160.120.001	M30	2	16160.300.001	M56	1	16160.560.001

Nakrętki napinające otwarte

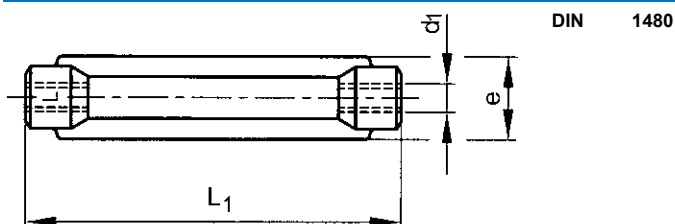

Informacje techniczne

d ₁	e	L ₁	P	d ₁	e	L ₁	P
M6	19	110	1	M16	42	170	2
M8	23	110	1.25	M20	52	200	2.5
M10	30	125	1.5	M24	60	255	3
M12	34	125	1.75	M30	74	255	3.5

- Stalowe nakrętki napinające otwarte (minimalna wytrzymałość na rozciąganie 330 N/mm²) są cynkowane lub cynkowane na gorąco, z gwintem ISO-metrycznym dopasowanym; w zależności od dostępności może się to zmieniać.
- Haki i uszy są klasy 3.6 i zawsze cynkowane.

16150 Nakrętki napinające otwarte

F11F

Gwint Metryczny
Materiał Stal Min.330N/mm²
Obróbka powierzchni Ocynkowane/Ocynkowane na gorąco

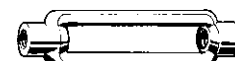

d ₁	☒	Kod artykułu	d ₁	☒	Kod artykułu	d ₁	☒	Kod artykułu
M6 Cynk.	10	16150.060.001	M12 Cynk.	5	16150.120.001	M24 Cynk. gor.	2	16150.240.001
M8 Cynk.	10	16150.080.001	M16 Cynk. gor.	5	16150.160.001	M30 Cynk. gor.	2	16150.300.001
M10 Cynk.	5	16150.100.001	M20 Cynk. gor.	2	16150.200.001			

Nakrętki napinające otwarte zakończone hakiem i uchem

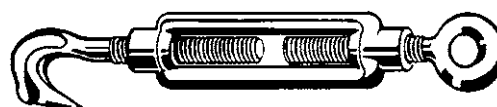
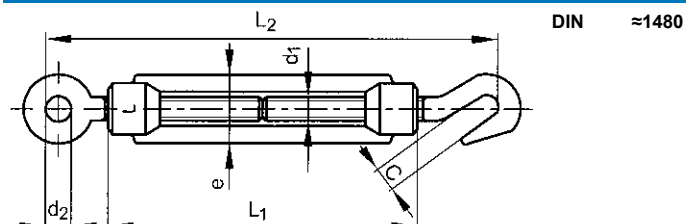

Informacje techniczne

d ₁	c	d ₂	e	L ₁	L ₂ (min.)	L ₂ (maks.)	P	Dopuszczalne obciążenie w N
M6	8	10	19	110	150	234	1	750
M8	10	11	23	110	161	245	1.25	1650
M10	13	14	30	125	188	285	1.5	2350
M12	17	17	34	125	208	305	1.75	3200
M16	16.5	23	42	170	299	433	2	5300
M20	17	25	52	200	341	495	2.5	7300
M24	23	34	60	255	394	594	3	15500
M30	29	38	74	255	441	635	3.5	22400

16170 Nakrętki napinające otwarte zakończone hakiem i uchem

F11F

Gwint Metryczny
Materiał Stal Min.330N/mm²
Obróbka powierzchni Ocynkowane/Ocynkowane na gorąco



d ₁	☒	Kod artykułu	d ₁	☒	Kod artykułu	d ₁	☒	Kod artykułu
M6 Cynk.	10	16170.060.001	M12 Cynk.	5	16170.120.001	M24 Cynk. gor.	2	16170.240.001
M8 Cynk.	10	16170.080.001	M16 Cynk. gor.	5	16170.160.001	M30 Cynk. gor.	2	16170.300.001
M10 Cynk.	5	16170.100.001	M20 Cynk. gor.	2	16170.200.001			

- Stalowe nakrętki napinające otwarte (minimalna wytrzymałość na rozciąganie 330 N/mm²) są cynkowane lub cynkowane na gorąco, z gwintem ISO-metrycznym dopasowanym; w zależności od dostępności może się to zmieniać.
- Haki i uszy są klasy 3.6 i zawsze cynkowane.

Nakrętki napinające otwarte zakończone hakiem i uchem

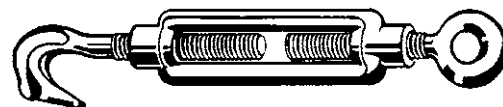
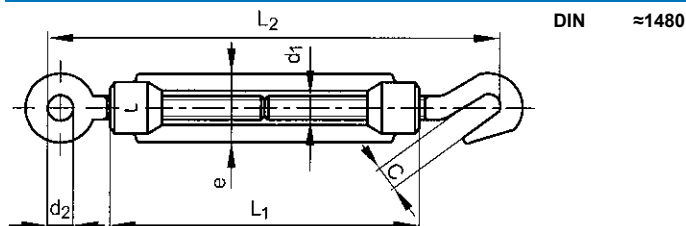

Informacje techniczne

d ₁	c	d ₂	e	L ₁	L ₂ (min.)	L ₂ (maks.)	P	Dopuszczalne obciążenie w N
M6	10	10	18	90	140	220	1	750
M8	11	14	21	120	180	280	1.25	1650
M10	12	16	25	150	230	360	1.5	2350
M12	14	18	31	200	280	460	1.75	3200
M16	16	26	40	250	370	590	2	5300
M20	18	30	49	300	420	650	2.5	7300

5

51742 Nakrętki napinające otwarte zakończone hakiem i uchem

R09A

Gwint Metryczny
 Materiał Stal nierdzewna A4



d ₁	☒	Kod artykułu	d ₁	☒	Kod artykułu	d ₁	☒	Kod artykułu
M6	10	51742.060.001	M10	5	51742.100.001	M16	5	51742.160.001
M8	10	51742.080.001	M12	5	51742.120.001	M20	2	51742.200.001

Nakrętki napinające otwarte zakończone dwoma uchami

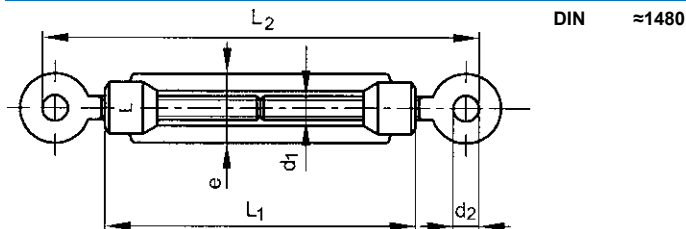

Informacje techniczne

d ₁	d ₂	e	L ₁	L ₂ (min.)	L ₂ (maks.)	P	Dopuszczalne obciążenie w N
M5 (#DIN)	8	16.6	78.5	119	179	0.8	1400
M6	10	19	110	150	234	1	2250
M8	10	23	110	156	240	1.25	4100
M10	14	30	125	186	282	1.5	6500
M12	17	34	125	196	293	1.75	9300
M14 (#DIN)	17.6	38	140	234	344	2	13200
M16	23	42	170	294	428	2	17700
M20	25	52	200	352	506	2.5	27000
M24	34	60	235	391	589	3	39200
M30	38	74	255	441	636	3.5	62500

16177 Nakrętki napinające otwarte zakończone dwoma uchami

F11F

Gwint Metryczny
 Materiał Stal Min.330N/mm²
 Obróbka powierzchni Ocynkowane/Ocynkowane na gorąco



d ₁	☒	Kod artykułu	d ₁	☒	Kod artykułu	d ₁	☒	Kod artykułu
M5 = 3/16 Cynk.	10	16177.050.001	M12 Cynk.	5	16177.120.001	M20 Cynk. gor.	2	16177.200.001
M6 Cynk.	10	16177.060.001	M14 = 9/16 Cynk.	5	16177.140.001	M24 Cynk. gor.	2	16177.240.001
M8 Cynk.	10	16177.080.001	M16 Cynk. gor.	5	16177.160.001	M30 Cynk. gor.	2	16177.300.001
M10 Cynk.	5	16177.100.001						

16177 Nakrętki napinające otwarte zakończone dwoma uchami

- Stalowe nakrętki napinające otwarte (minimalna wytrzymałość na rozciąganie 330 N/mm²) są cynkowane lub cynkowane na gorąco, z gwintem ISO-metrycznym dopasowanym; w zależności od dostępności może się to zmieniać.
- Haki i uszy są klasy 3.6 i zawsze cynkowane.

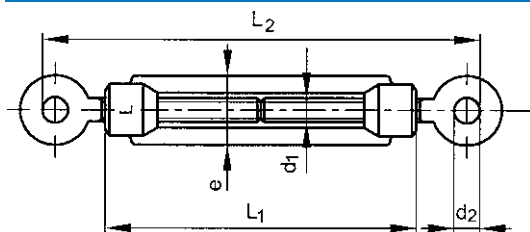
Nakrętki napinające otwarte zakończone dwoma uchami

DIN ≈1480

Informacje techniczne

d ₁	d ₂	e	L ₁	L ₂ (min.)	L ₂ (maks.)	P	Dopuszczalne obciążenie w N
M6	10	18	90	140	220	1	2250
M8	14	21	120	180	280	1.25	4100
M10	16	25	150	230	360	1.5	6500
M12	18	31	200	280	460	1.75	9300
M16	26	40	250	370	590	2	17700
M20	30	49	300	420	650	2.5	27000

5

51744 Nakrętki napinające otwarte zakończone dwoma uchami

R09A

Gwint Metryczny
 Materiał Stal nierdzewna A4



d ₁	☒	Kod artykułu	d ₁	☒	Kod artykułu	d ₁	☒	Kod artykułu
M6	10	51744.060.001	M10	5	51744.100.001	M16	5	51744.160.001
M8	10	51744.080.001	M12	5	51744.120.001	M20	2	51744.200.001

Nakrętki napinające otwarte zakończone dwoma hakami

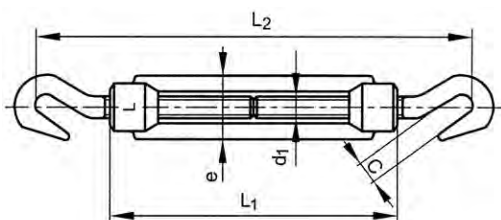

DIN ≈1480

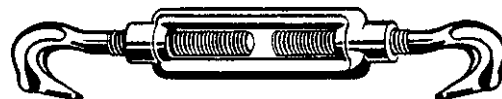

Informacje techniczne

d_1	c	e	L_1	L_2 (min.)	L_2 (maks.)	P	Dopuszczalne obciążenie w N
M5 (#DIN)	7	16.5	70	107	157	0.8	500
M6	8	19	110	150	234	1	750
M8	10	23	110	166	250	1.25	1650
M10	13	30	125	189	289	1.5	2350
M12	17	34	125	220	317	1.75	3200
M16	16.5	42	170	304	438	2	5300

5

16178 Nakrętki napinające otwarte zakończone dwoma hakami

F11F

Gwint Metryczny
 Materiał Stal Min.330N/mm²
 Obróbka powierzchni Ocynkowane



d_1	☒	Kod artykułu	d_1	☒	Kod artykułu	d_1	☒	Kod artykułu
M5 = 3/16	10	16178.050.001	M8	10	16178.080.001	M12	5	16178.120.001
M6	10	16178.060.001	M10	5	16178.100.001	M16 = 5/8	5	16178.160.001

- Stalowe nakrętki napinające otwarte (minimalna wytrzymałość na rozciąganie 330 N/mm²) są cynkowane lub cynkowane na gorąco, z gwintem ISO-metrycznym dopasowanym; w zależności od dostępności może się to zmieniać.
- Haki i uszy są klasy 3.6 i zawsze cynkowane.

Nakrętki napinające otwarte zakończone dwoma hakami

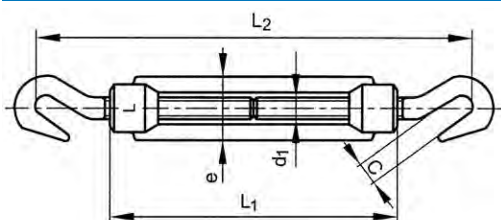

DIN ≈1480

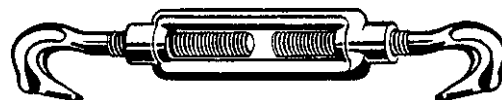

Informacje techniczne

d_1	c	e	L_1	L_2 (min.)	L_2 (maks.)	P	Dopuszczalne obciążenie w N
M6	10	18	90	140	220	1	750
M8	11	21	120	180	280	1.25	1650
M10	12	25	150	230	360	1.5	2350
M12	14	31	200	280	460	1.75	3200
M16	16	40	250	370	590	2	5300
M20	18	49	300	420	650	2.5	7300

51743 Nakrętki napinające otwarte zakończone dwoma hakami

R09A

Gwint Metryczny
 Materiał Stal nierdzewna A4



d_1	☒	Kod artykułu	d_1	☒	Kod artykułu	d_1	☒	Kod artykułu
M6	10	51743.060.001	M10	5	51743.100.001	M16	5	51743.160.001
M8	10	51743.080.001	M12	5	51743.120.001	M20	2	51743.200.001

Nakrętki napinające otwarte zakończone dwoma płaskimi uchami

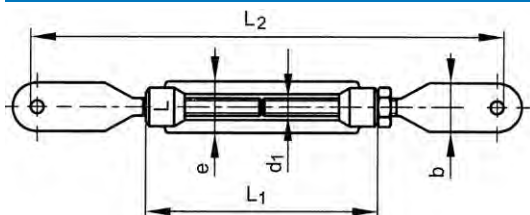

DIN ≈1480

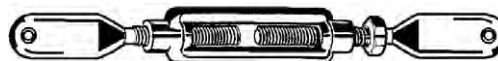

Informacje techniczne

d ₁	b	e	L ₁	L ₂ (min.)	L ₂ (maks.)	P	Grubość płaskiego ucha	Dopuszczalne obciążenie w N
M12	30	34	125	325	430	1.5	4	9300
M16	40	42	170	472	615	1.75	4	17700
M20	50	52	200	463	630	2	5	27000

16172 Nakrętki napinające otwarte zakończone dwoma płaskimi uchami

F11F

Gwint Metryczny
 Materiał Stal Min.330N/mm²
 Obróbka powierzchni Ocynkowane



d ₁	Kod artykułu	d ₁	Kod artykułu	d ₁	Kod artykułu
M12	5 16172.120.001	M16	5 16172.160.001	M20	2 16172.200.001

- Stalowe nakrętki napinające otwarte (minimalna wytrzymałość na rozciąganie 330 N/mm²) są cynkowane lub cynkowane na gorąco, z gwintem ISO-metrycznym dopasowanym; w zależności od dostępności może się to zmieniać.
- Uszy są klasy 3.6 i zawsze cynkowane.

Szekle

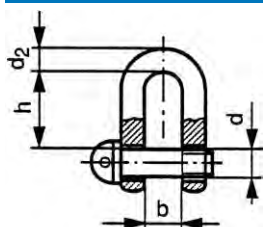

DIN ≈82101 A
 NEN ≈964

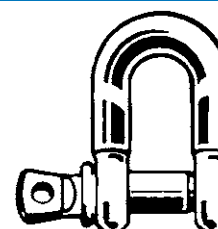

Informacje techniczne

d	b	d ₂	Dopuszczalne obciążenie w kN	h
5	7	4/5	1	15.5
6	8	5/6	1.6	18
8	11	7/8	2.5	24
10	14	9/10	4	30
11 (≠DIN)	22	11	-	44
12	17	10/12	6.3	36
14 (≠DIN)	28	14	-	53
16	21	13/15	10	49
19 (≠DIN)	38	19	-	74
20	27	17/19	16	61
22	30	19/21	20	67
24	33	21/23	25	73
25 (≠DIN)	51	25	-	100
28 (≠DIN)	57	28	-	115
32 (≠DIN)	64	32	-	127
38 (≠DIN)	76	37	-	152

- Szekle są cynkowane lub cynkowane na gorąco, w zależności od dostępności mogą się różnić.
- Wymiary mogą się różnić.
- Nie stosować do podnoszenia.

16813	Szekle	F11H
Materiał	Stal	
Obróbka powierzchni	Ocynkowane/Ocynkowane na gorąco	

d	☒	Kod artykułu	d	☒	Kod artykułu	d	☒	Kod artykułu
5 MM Cynk.	25	16813.050.001	14 MM= 9/16 Cynk.	25	16813.140.001	25 MM= 1.IN. Cynk. gor.	3	16813.250.001
6 MM Cynk.	25	16813.060.001	16 MM Cynk. gor.	10	16813.160.001	28 MM= 1.1/8 Cynk. gor.	1	16813.280.001
8 MM Cynk.	25	16813.080.001	19 MM= 3/4 Cynk. gor.	10	16813.190.001	32 MM= 1.1/4 Cynk. gor.	1	16813.320.001
10 MM Cynk.	25	16813.100.001	20 MM Cynk. gor.	5	16813.200.001	38 MM= 1.1/2 Cynk. gor.	1	16813.380.001
11 MM Cynk.	25	16813.110.001	22 MM Cynk. gor.	5	16813.220.001			
12 MM Cynk.	25	16813.120.001	24 MM Cynk. gor.	5	16813.240.001			

Szekle, stal nierdzewna

5

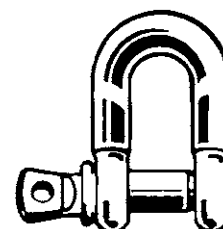
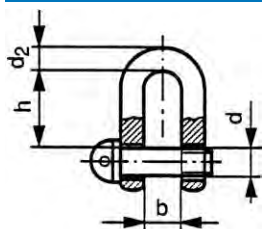

Informacje techniczne

d	b	d ₂	h	d	b	d ₂	h
4	8	4	16	12	24	12	48
5	10	5	20	16	32	16	64/56
6	12	6	24	19	38	19	76
8	16	8	32	24	32	18	80
10	20	10	40				

- Wymiary mogą się różnić.
- Nie stosować do podnoszenia.

Grupy katalogowe

Materiał	Kod	Strona
St.St. A2	16711	5-20
St.St. A4	16713	5-20

16711	Szekle, stal nierdzewna	R09A
Materiał	Stal nierdzewna A2	

d	☒	Kod artykułu	d	☒	Kod artykułu	d	☒	Kod artykułu
5MM	10	16711.050.001	10MM	10	16711.100.001	16MM	5	16711.160.001
6MM	10	16711.060.001	12MM	10	16711.120.001	19MM	2	16711.190.001
8MM	10	16711.080.001						

16713	Szekle, stal nierdzewna	R49A
Materiał	Stal nierdzewna A4	

d	☒	Kod artykułu	d	☒	Kod artykułu	d	☒	Kod artykułu
4MM	10	16713.040.001	8MM	10	16713.080.001	16MM	5	16713.160.001
5MM	10	16713.050.001	10MM	10	16713.100.001	19MM	2	16713.190.001
6MM	10	16713.060.001	12MM	10	16713.120.001			

Szekle, Stal

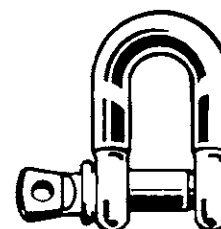
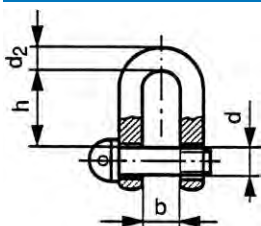

Informacje techniczne

d	b	d ₂	h	d	b	d ₂	h
5	10	5	20	16	32	16	64
6	12	6	24	19	38	19	74
8	16	8	32	22	44	19/21	88
10	20	10	40	25	51	25	100
11	22	11	44	28	57	28	115
12	25	12	50	32	64	32	127
14	28	14	53	38	76	38	152

- Szekle są cynkowane lub cynkowane na gorąco, w zależności od dostępności mogą się różnić.
- Wymiary mogą się różnić.
- Nie stosować do podnoszenia.

5

16812 Szekle, Stal

F11H

Materiał Stal
Obróbka powierzchni Ocynkowane

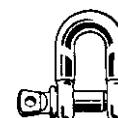

d	☒	Kod artykułu	d	☒	Kod artykułu	d	☒	Kod artykułu
5MM	25	16812.050.001	12MM	25	16812.120.001	25MM	3	16812.250.001
6MM	25	16812.060.001	14MM	25	16812.140.001	28MM	1	16812.280.001
8MM	25	16812.080.001	16MM	10	16812.160.001	32MM	1	16812.320.001
10MM	25	16812.100.001	19MM	10	16812.190.001	38MM	1	16812.380.001
11MM	25	16812.110.001	22MM	5	16812.220.001			

Szkle Omega

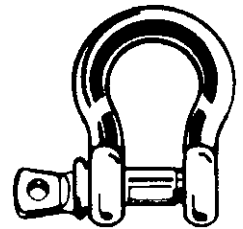
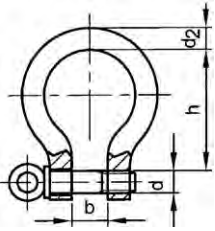

Informacje techniczne

d	b	d ₂	h	d	b	d ₂	h
5	10	5	19	16	32	16	64
6	13	6	25	19	38	19	76
8	16	8	32	22	44	22	89
10	19	10	38	25	51	25	100
11	22	11	46	28	57	28	115
12	25	12	51	32	64	32	127
14	28	14	58	38	76	38	152

5

- Szkle są cynkowane lub cynkowane na gorąco, w zależności od dostępności mogą się różnić.
- Wymiary mogą się różnić.
- Nie stosować do podnoszenia.

16817 Szkle Omega

F11H

Materiał Stal
Obróbka powierzchni Ocynkowane



d	☒	Kod artykułu	d	☒	Kod artykułu	d	☒	Kod artykułu
5MM	25	16817.050.001	12MM	25	16817.120.001	25MM	5	16817.250.001
6MM	25	16817.060.001	14MM	10	16817.140.001	28MM = 1.1/8	3	16817.280.001
8MM	25	16817.080.001	16MM	10	16817.160.001	32MM = 1.1/4	1	16817.320.001
10MM	25	16817.100.001	19MM	5	16817.190.001	38MM = 1.1/2	1	16817.380.001
11MM	25	16817.110.001	22MM	5	16817.220.001			

Szkiele Omega, stal nierdzewna

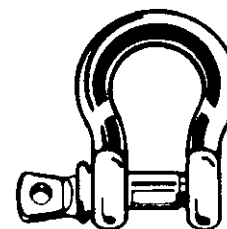
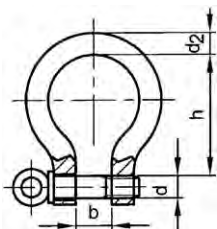

Informacje techniczne

d	b	d ₂	h	d	b	d ₂	h
4	8	4	16	10	20	10	40
5	10	5	20	12	24	12	48
6	12	6	24	16	32	16	64
8	16	8	32				

- Szkiele są cynkowane lub cynkowane na gorąco, w zależności od dostępności mogą się różnić.
- Wymiary mogą się różnić.
- Nie stosować do podnoszenia.

Grupy katalogowe

Material	Kod	Strona
St.St. A2	16715	5-23
St.St. A4	16717	5-23

16715 Szkiele Omega, stal nierdzewna R09A

Material	Stal nierdzewna A2		
	 		

d	☒	Kod artykułu	d	☒	Kod artykułu	d	☒	Kod artykułu
5MM	10	16715.050.001	8MM	10	16715.080.001	12MM	10	16715.120.001
6MM	10	16715.060.001	10MM	10	16715.100.001	16MM	5	16715.160.001

16717 Szkiele Omega, stal nierdzewna R49A

Material	Stal nierdzewna A4		
	 		

d	☒	Kod artykułu	d	☒	Kod artykułu	d	☒	Kod artykułu
4MM	10	16717.040.001	8MM	10	16717.080.001	12MM	10	16717.120.001
5MM	10	16717.050.001	10MM	10	16717.100.001	16MM	5	16717.160.001
6MM	10	16717.060.001						

Zaciski kabłąkowe do lin stalowych

DIN 741/555 (1987)

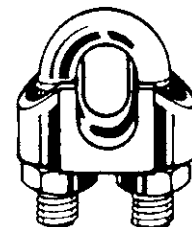
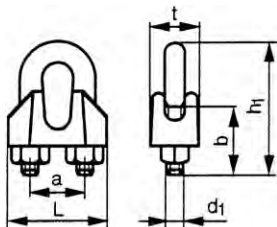

Informacje techniczne

Średnica liny	a	b	d ₁	h ₁	L	Min. ilość zacisków	t
3	9	12	M4	20	21	3	10
5	11	13	M5	24	23	3	11
6.5	13	15	M5	28	26	3	12
8	16	19	M6	34	30	5	14
10	19	22	M8	42	34	5	18
11	20	22	M8	44	36	5	19
12 (#DIN)	24	26	M10	56	42	5	23
13	24	30	M10	55	42	5	23
14	25	30	M10	57	44	5	23
16	29	33	M12	63	50	6	26
19	32	38	M12	75	54	6	29
22	37	44	M14	85	61	7	33
25 (#DIN)	39	48	M14	95	65	7	34
26	41	45	M14	95	65	8	35
30	48	50	M16	110	74	8	37
34	52	55	M16	120	80	8	42
40	58	60	M16	140	88	8	45

- Odpowiadające nakrętki sześciokątne mają klasę właściwości \geq I4I.

Dane montażowe

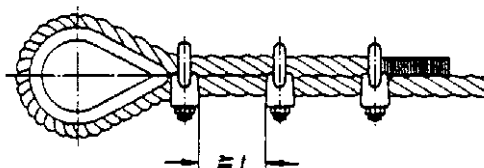

Odległość pomiędzy zaciskami do lin stalowych \geq t, patrz rysunek złożeniowy

16829 Zaciski kabłąkowe do lin stalowych

F11M

Materiał Stal
Obróbka powierzchni O cynkowane

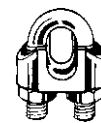

Dla średnica liny	☒	Kod artykułu	Dla średnica liny	☒	Kod artykułu	Dla średnica liny	☒	Kod artykułu
3MM	100	16829.030.001	12MM = 1/2	25	16829.120.001	26MM	10	16829.260.001
5MM	100	16829.050.001	13MM	25	16829.130.001	30MM	5	16829.300.001
6.5MM	100	16829.065.001	14MM	25	16829.140.001	34MM	5	16829.340.001
8MM	100	16829.080.001	16MM	25	16829.160.001	40MM	5	16829.400.001
10MM	50	16829.100.001	19MM	10	16829.190.001			
11MM	50	16829.110.001	22MM	10	16829.220.001			

Zaciski kabłąkowe do lin, stal nierdzewna

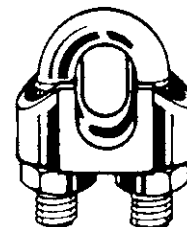
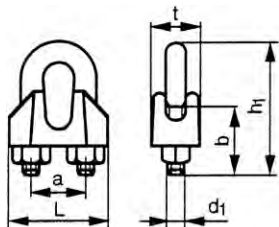

Informacje techniczne

Średnica liny	a	b	d ₁	h ₁	L	Min. ilość zacisków	t
3	9	12	M3	22	22	3	14
4	9	12	M4	22	22	3	14
5	11	15	M5	24	24	3	16
6	14	18	M6	33	30	3	18
8	16	20	M6	35	33	5	20
10	18	22	M8	43	37	5	22
12	23	30	M10	54	45	5	25
16	28	30	M10	65	53	5	30

- W zależności od dostępności wymiary mogą się różnić.

Dane montażowe

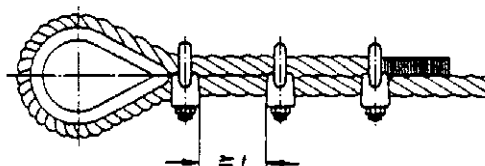

Odległość pomiędzy zaciskami do lin stalowych $\geq t$, patrz rysunek złożeniowy

16728 Zaciski kabłąkowe do lin, stal nierdzewna

R49A

Gwint Metryczny
Materiał Stal nierdzewna A4

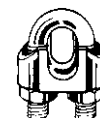

Dł. średnica liny	☒	Kod artykułu	Dł. średnica liny	☒	Kod artykułu	Dł. średnica liny	☒	Kod artykułu
3MM	10	16728.030.001	6MM	5	16728.060.001	12MM	5	16728.120.001
4MM	10	16728.040.001	8MM	5	16728.080.001	16MM	5	16728.160.001
5MM	10	16728.050.001	10MM	5	16728.100.001			

Haki zatrzaskowe (Karabińczyki do lin)

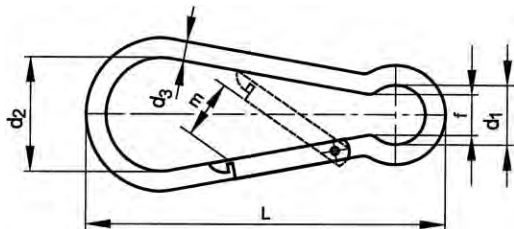

Informacje techniczne

$d_3 \times L \times f$	d_1	d_2 (min.)	f	m	Min. breaking load (kN)
5x50x7	7	15	5	6	1.0
6x60x7	8	17	6	7	1.2
7x70x9	10	20	7	8	1.8
8x80x11	12	24	9	10	2.3
10x100x12	15	30	11	11	3.5
11x120x14	16	39	12	17	4.5

- Nie stosować do podnoszenia.

5

Grupy katalogowe

Materiał	Obróbka powierzchni	Kod	Strona
St	Ocynk.	16833	5-26
St.St. A4		16733	5-26

16833 Haki zatrzaskowe (Karabińczyki do lin) F11N

Materiał Stal
Obróbka powierzchni Ocynkowane



$d_3 \times L$	☒	Kod artykułu	$d_3 \times L$	☒	Kod artykułu	$d_3 \times L$	☒	Kod artykułu
5X50MM	10	16833.050.050	8X80MM	10	16833.080.080	10X100MM	10	16833.100.100
6X60MM	10	16833.060.060						

16733 Haki zatrzaskowe (Karabińczyki do lin) R49A

Materiał Stal nierdzewna A4



$d_3 \times L$	☒	Kod artykułu	$d_3 \times L$	☒	Kod artykułu	$d_3 \times L$	☒	Kod artykułu
5X50MM	10	16733.050.050	7X70MM	10	16733.070.070	10X100MM	10	16733.100.100
6X60MM	10	16733.060.060	8X80MM	10	16733.080.080	11X120MM	10	16733.110.120

Kausze

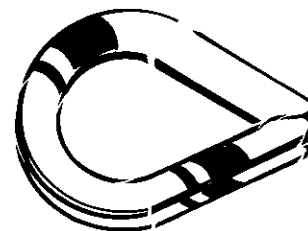
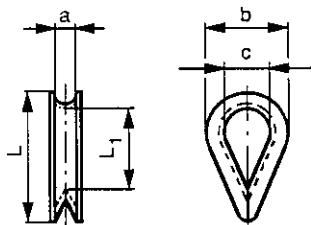

Informacje techniczne

Średnica liny	a	b	c	L	L ₁
3	3	20	12	28	19
4	4	19	11	25	16
5	5	22	16	31	22
6	6	29	19	37	26
8	8	38	24	51	34
10	10	44	32	64	42
12	12	57	38	76	51
14	14	60	40	82	57
16	16	64	42	89	60
18	18	69	45	102	67
20	20	79	51	115	76
22	22	89	54	127	83
24	24	102	64	140	88

5

16831 Kausze

F11M

Materiał Stal
Obróbka powierzchni Ocynkowane



Dł. średnica liny	☒	Kod artykułu	Dł. średnica liny	☒	Kod artykułu	Dł. średnica liny	☒	Kod artykułu
3MM	100	16831.030.001	10MM	50	16831.100.001	18MM	10	16831.180.001
4MM	100	16831.040.001	12MM	50	16831.120.001	20MM	5	16831.200.001
5MM	100	16831.050.001	14MM	10	16831.140.001	22MM	2	16831.220.001
6MM	100	16831.060.001	16MM	10	16831.160.001	24MM	2	16831.240.001
8MM	100	16831.080.001						

Haki oczkowe zamknięte, metryczne

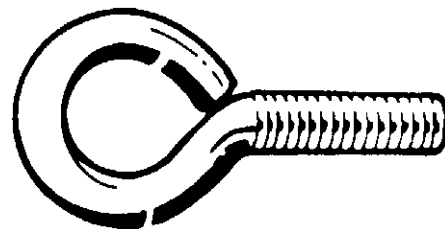
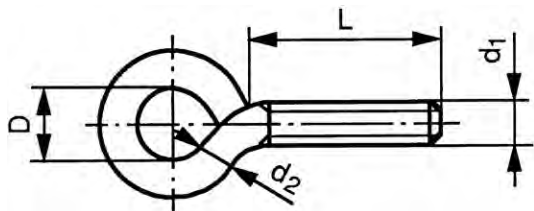

Informacje techniczne

d ₁	d ₂	P	d ₁	d ₂	P
M3	2.6	0.5	M6	5.25	1
M4	3.45	0.7	M8	7.0	1.25
M5	4.4	0.8	M10	8.85	1.5

Grupy katalogowe

Gwint	Materiał	Obróbka powierzchni	Kod	Strona
M	St	Ocynk.	17420	5-28
M	St.St. A2		17690	5-28

5

17420 Haki oczkowe zamknięte, metryczne, artykuł 111G F11B

Gwint Metryczny
 Materiał Stal
 Obróbka powierzchni Ocynkowane

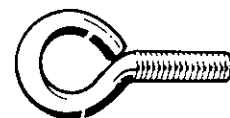

d ₁ x L x D	☒	Kod artykułu	d ₁ x L x D	☒	Kod artykułu	d ₁ x L x D	☒	Kod artykułu
M3X10X6	100	17420.031.006	M5X50X8	100	17420.055.008	M8X40X10	100	17420.084.010
M3X20X5	100	17420.032.006	M5X60X8	100	17420.056.008	M8X50X10	100	17420.085.010
M4X15X6	100	17420.041.506	M6X20X10	100	17420.062.010	M8X60X10	100	17420.086.010
M4X20X6	100	17420.042.006	M6X25X10	100	17420.062.510	M8X80X10	50	17420.088.010
M4X25X6	100	17420.042.506	M6X30X10	100	17420.063.010	M8X100X10	50	17420.089.610
M4X30X6	100	17420.043.006	M6X40X10	100	17420.064.010	M10X40X15	50	17420.104.014
M4X40X6	100	17420.044.006	M6X50X10	100	17420.065.010	M10X50X15	50	17420.105.014
M5X15X8	100	17420.051.508	M6X60X10	100	17420.066.010	M10X60X15	50	17420.106.014
M5X20X8	100	17420.052.008	M6X80X10	100	17420.068.010	M10X80X15	50	17420.108.014
M5X25X8	100	17420.052.508	M6X100X10	100	17420.069.610	M10X90X18	50	17420.109.017
M5X30X8	100	17420.053.008	M8X20X10	100	17420.082.010	M10X100X15	50	17420.109.417
M5X40X8	100	17420.054.008	M8X30X10	100	17420.083.010	M10X120X15	50	17420.109.515

17690 Haki oczkowe zamknięte, metryczne, artykuł 111R F11C

Gwint Metryczny
 Materiał Stal nierdzewna A2

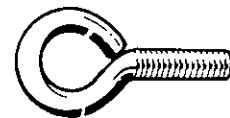

d ₁ x L x D	☒	Kod artykułu	d ₁ x L x D	☒	Kod artykułu	d ₁ x L x D	☒	Kod artykułu
M5X15X8	100	17690.051.508	M6X30X10	100	17690.063.010	M8X60X10	100	17690.086.010
M5X30X8	100	17690.053.008	M6X40X10	100	17690.064.010	M8X80X10	50	17690.088.010
M5X50X8	100	17690.055.008	M6X60X10	100	17690.066.010	M10X70X15	50	17690.107.014
M6X20X10	100	17690.062.010						

Haki sufitowe, metryczne

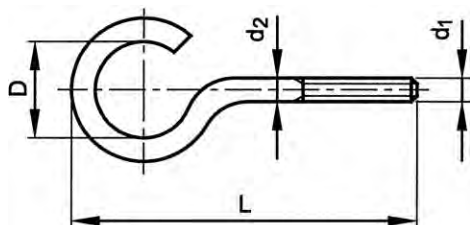

Informacje techniczne

d ₁	D	d ₂	P	d ₁	D	d ₂	P
M4	12	3.45	0.7	M6	16	5.25	1
M5	16	4.4	0.8	M8	15	7.0	1.25

17203 Haki sufitowe metryczne, artykuł 26

F11A

Gwint Metryczny
 Materiał Stal
 Obróbka powierzchni Ocynkowane



d ₁ x L	☒	Kod artykułu	d ₁ x L	☒	Kod artykułu	d ₁ x L	☒	Kod artykułu
M4X50	100	17203.040.050	M6X60	100	17203.060.060	M8X60	100	17203.080.060
M5X50	100	17203.050.050						

Haki proste, metryczne

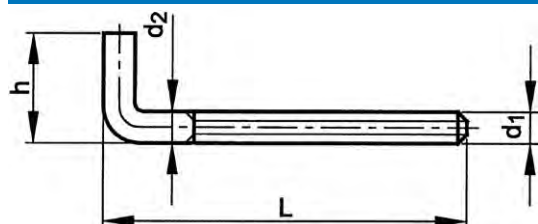

Informacje techniczne

d ₁	d ₂	h	P	d ₁	d ₂	h	P
M4	3.45	15	0.7	M6	5.25	20	1
M5	4.4	20	0.8	M8	7.0	25	1.25

17123 Haki proste metryczne, artykuł 27

F11A

Gwint Metryczny
 Materiał Stal
 Obróbka powierzchni Ocynkowane



d ₁ x L	☒	Kod artykułu	d ₁ x L	☒	Kod artykułu	d ₁ x L	☒	Kod artykułu
M4X40	100	17123.040.040	M6X60	100	17123.060.060	M8X60	100	17123.080.060
M5X50	100	17123.050.050						

Haki oczkowe, niemetryczne

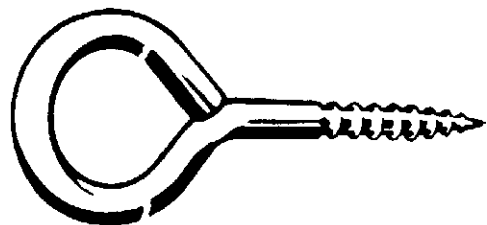
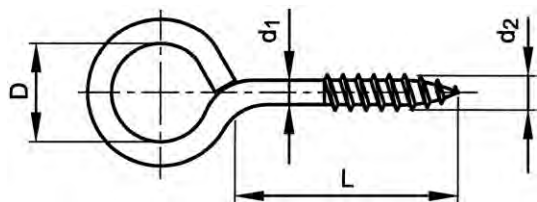

Informacje techniczne

d ₁	d ₂	d ₁	d ₂
1.9	2.4	4.0 (d2=5.1)	5.1
2.2	2.8	4.4	5.5
2.5	3.2	4.5	5.5
2.65	3.4	4.85 (d2=5.8)	5.8
3.0	3.8	4.85 (d2=6.1)	6.1
3.3	4.1	5.25	6.5
3.45	4.3	6.0	7.6
4.0 (d2=4.9)	4.9		

Grupy katalogowe

Materiał	Obróbka powierzchni	Kod	Strona
St	Ocynk.	17020	5-30
St.St. A2		17545	5-30
Mosiądz		17620	5-31

17020 Haki oczkowe, niemetryczne, artykuł 1G

F11B

Materiał Stal
Obróbka powierzchni Ocynkowane



d ₁ x L x D	⊗	Kod artykułu	d ₁ x L x D	⊗	Kod artykułu	d ₁ x L x D	⊗	Kod artykułu
1,9X6X3MM	100	17020.060.003	4,0X20X12MM (d2=5,1)	100	17020.200.012	4,4X40X16MM	100	17020.400.016
2,2X8X4MM	100	17020.080.004	3,45X25X10MM	100	17020.250.010	4,85X40X18MM (d2=6,1)	100	17020.400.018
2,2X10X4MM	100	17020.100.004	4,0X25X12MM (d2=5,1)	100	17020.250.012	5,25X40X20MM	100	17020.400.020
2,5X10X5MM	100	17020.100.005	3,0X20X8MM	100	17020.300.008	4,85X50X15MM (d2=6,1)	100	17020.500.015
2,5X10X6MM	100	17020.100.006	3,45X30X10MM	100	17020.300.010	4,85X50X18MM (d2=6,1)	100	17020.500.018
2,2X12X4MM	100	17020.120.004	4,0X30X12MM (d2=5,1)	100	17020.300.012	4,85X50X18MM (d2=6,1)	100	17020.500.018
2,65X12X6MM	100	17020.120.006	4,0X30X14MM (d2=5,1)	100	17020.300.014	5,25X50X20MM	100	17020.500.020
3,3X12X8MM	100	17020.120.008	4,4X30X16MM	100	17020.300.016	6,0X50X25MM	100	17020.500.025
2,65X16X6MM	100	17020.160.006	4,85X30X18MM (d2=6,1)	100	17020.300.018	5,25X60X20MM	100	17020.600.020
3,0X16X8MM	100	17020.160.008	4,0X40X14MM (d2=5,1)	100	17020.400.014	6,0X60X25MM	100	17020.600.025
3,45X16X10MM	100	17020.160.010	4,85X40X15MM (d2=6,1)	100	17020.400.015			
3,0X20X8MM	100	17020.200.008						
3,45X20X10MM	100	17020.200.010						

17545 Haki oczkowe, niemetryczne, artykuł 1R

F11C

Materiał Stal nierdzewna A2



d ₁ x L x D	⊗	Kod artykułu	d ₁ x L x D	⊗	Kod artykułu	d ₁ x L x D	⊗	Kod artykułu
3,45X20X10MM	100	17545.200.010	4,0X30X8MM (d2=5,1)	100	17545.300.008	4,85X30X8MM (d2=5,8)	100	17545.301.008
4,0X25X12MM (d2=5,1)	100	17545.250.012	5,25X30X10MM	100	17545.300.010	4,4X40X16MM	100	17545.400.016

17620	Haki oczkowe, niemetryczne, artykuł 1M	F11B
Materiał	Mosiądz	
		 

$d_1 \times L \times D$	☒	Kod artykułu	$d_1 \times L \times D$	☒	Kod artykułu	$d_1 \times L \times D$	☒	Kod artykułu
2,65X12X6MM	100	17620.120.006	3,45X20X10MM	100	17620.200.010	4,0X30X14MM (d2=5,1)	100	17620.300.014
2,65X16X6MM	100	17620.160.006	4,0X25X12MM (d2=4,9)	100	17620.250.012	4,5X40X16MM	100	17620.400.016
3,0X20X8MM	100	17620.200.008						

Haki oczkowe, typ mocny, niemetryczne

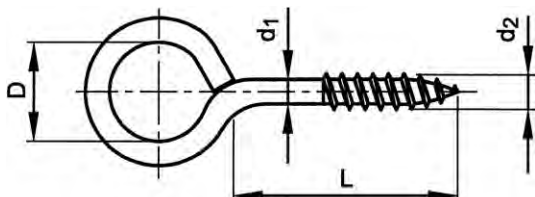

5

Informacje techniczne				
Nr	D	d_1	d_2	L
8	8	4	5.1	20
10	8	4.40	5.5	25
15	10	5.25	6.7	35
Nr	D	d_1	d_2	L
17	10	7	8.8	40
18	14	7.80	9.5	45

17023	Haki oczkowe, typ mocny, niemetryczne, artykuł 3	F11A
Materiał	Stal	
Obróbka powierzchni	Ocynkowane	
		 

Nr	☒	Kod artykułu	Nr	☒	Kod artykułu	Nr	☒	Kod artykułu
No.8	100	17023.000.008	No.15	100	17023.000.015	No.18	100	17023.000.018
No.10	100	17023.000.010	No.17	100	17023.000.017			

Haki oczkowe, typ długi, niemetryczne

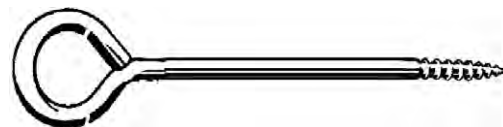
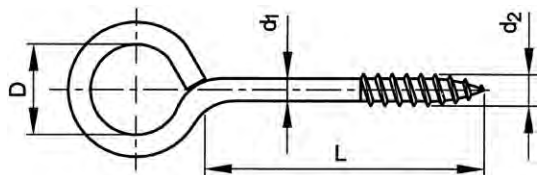

17022 Haki oczkowe, typ długi, niemetryczne, artykuł 2

F11A

Materiał Stal
Obróbka powierzchni Ocynkowane



$d_1 \times d_2 \times L \times D$	☒	Kod artykułu	$d_1 \times d_2 \times L \times D$	☒	Kod artykułu	$d_1 \times d_2 \times L \times D$	☒	Kod artykułu
7,0X9,0X60X20MM	100	17022.000.060	7,0X9,0X100X20MM	100	17022.000.100	7,0X9,0X140X20MM	100	17022.000.140

5

Haki sufitowe, niemetryczne

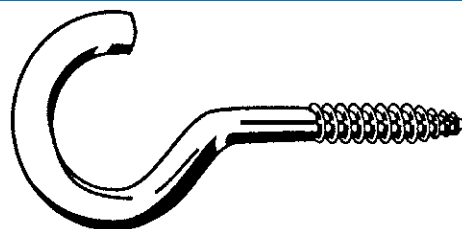
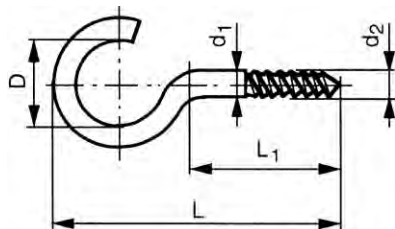

Informacje techniczne

$d_1 \times L_1/L$	D	d_2	$d_1 \times L_1/L$	D	d_2
2.0x10/20	7	2.6	4.4x32/60	18	5.5
2.0x11/23	7	2.6	4.4x50/80	20	5.5
2.4x12/25	9	3	4.75x32/60	18	6.1
2.4x15/30	9	3	5.0x47/85	25	6.3
3.2x20/40	12	4.1	5.25x82/120	25	6.5
3.3x13/30	9	4.1	6.0x45/80	25	7.6
3.3x20/40	12	4.1	6.0x62/100	25	7.6
3.45x30/50	14	4.3	6.0x82/120	25	7.6
4.0x27/55	18	5.1	7.0x100/140	25	9.0
4.4x25/50	16	5.5	7.0x120/160	25	9.0

Grupy katalogowe

Materiał	Obróbka powierzchni	Kod	Strona	
St	Ocynk.	11	17200	5-32
St	Epoks. b.	11W	17199	5-33
St	Ocynk.	15	17220	5-33

17200 Haki sufitowe, niemetryczne, artykuł 11

F11B

Materiał Stal
Obróbka powierzchni Ocynkowane

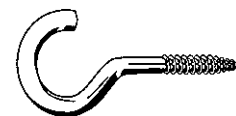

$d_1 \times L_1/L$	☒	Kod artykułu	$d_1 \times L_1/L$	☒	Kod artykułu	$d_1 \times L_1/L$	☒	Kod artykułu
2,0X10/20MM	100	17200.000.020	3,45X30/50MM	100	17200.000.050	2,4X12/25MM	100	17200.025.025
2,0X11/25MM	100	17200.000.025	4,4X32/60MM	100	17200.000.060	3,3X13/30MM	100	17200.030.030
2,4X15/30MM	100	17200.000.030	4,4X50/80MM	100	17200.000.080	4,0X27/55MM	100	17200.040.055
3,3X20/40MM	100	17200.000.040	5,25X82/120MM	100	17200.000.120	5,0X47/85MM	100	17200.050.085

17199	Haki sufitowe, niemetryczne, artykuł 11W	F11B
Materiał	Stal	
Obróbka powierzchni	Epoksydowane białe	

$d_1 \times L_1/L$	☒	Kod artykułu	$d_1 \times L_1/L$	☒	Kod artykułu	$d_1 \times L_1/L$	☒	Kod artykułu
2,0X10/20MM	100	17199.000.020	2,4X15/30MM	100	17199.000.030	3,45X30/50MM	100	17199.000.050
2,0X11/23MM	100	17199.000.025	3,2X20/40MM	100	17199.000.040	4,4X32/60MM	100	17199.000.060

• Stal cynkowana z białą powłoką epoksydową zapewniającą dodatkową ochronę powierzchni (60-80 µm), estetyczny wygląd.

17220	Haki sufitowe, typ mocny, niemetryczne, artykuł 15	F11A
Materiał	Stal	
Obróbka powierzchni	Ocynkowane	



$d_1 \times L_1/L$	☒	Kod artykułu	$d_1 \times L_1/L$	☒	Kod artykułu	$d_1 \times L_1/L$	☒	Kod artykułu
4,4X25/50MM	100	17220.044.050	6,0X62/100MM	100	17220.060.100	7,0X100/140MM	100	17220.069.140
4,75X32/60MM	100	17220.047.060	6,0X82/120MM	100	17220.062.120	7,0X120/160MM	100	17220.069.160
6,0X45/80MM	100	17220.060.080						

5

Haki niemetryczne (mały hak)

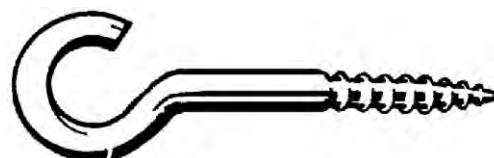
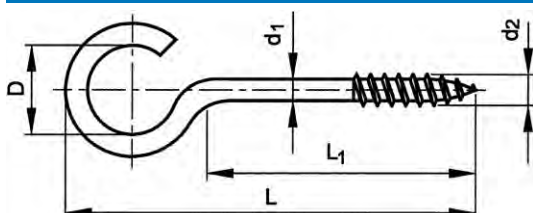

Informacje techniczne

d_1	D	d_2
3.3	8	4.1
4.0	14	5.1
4.4	16	5.6

17210	Haki niemetryczne (mały hak), artykuł 13	F11A
Materiał	Stal	
Obróbka powierzchni	Ocynkowane	



$d_1 \times L_1/L$	☒	Kod artykułu	$d_1 \times L_1/L$	☒	Kod artykułu	$d_1 \times L_1/L$	☒	Kod artykułu
3,3X26/40MM	100	17210.000.040	4,0X58/80MM	100	17210.000.080	4,4X95/120MM	100	17210.000.120
4,0X37/60MM	100	17210.000.060	4,4X75/100MM	100	17210.000.100			

Haki proste, niemetryczne

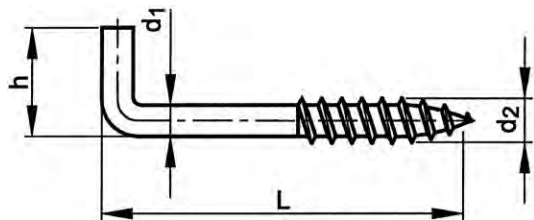

Informacje techniczne

d ₁ x L	d ₂	h	d ₁ x L	d ₂	h
2.0x20	2.8	10	4.0x60	5.1	20
2.5x25	3.2	11	4.4x60	5.5	20
2.65x30	4	14	4.4x80	5.5	22
3.3x40	4	16	5.0x50	6.3	22
3.45x50	4.3	18	5.0x60	6.3	22
3.5x40	4.3	16	5.0x70	6.3	22
4.0x40	5.1	18	5.25x100	6.5	24
4.0x50	5.1	18			

Grupy katalogowe

Materiał	Obróbka powierzchni	Kod	Strona
St	Ocynk.	17120	5-34
St	Epoks. b.	17119	5-34

17120 Haki proste, niemetryczne, artykuł 7

F11B

Materiał Stal
Obróbka powierzchni Ocynkowane



d ₁ x L	☒	Kod artykułu	d ₁ x L	☒	Kod artykułu	d ₁ x L	☒	Kod artykułu
2,2X20MM	100	17120.000.020	4,0X60MM	100	17120.000.060	4,0X50MM	100	17120.040.050
2,5X25MM	100	17120.000.025	4,4X80MM	100	17120.000.080	4,4X60MM	100	17120.045.060
2,65X30MM	100	17120.000.030	5,25X100MM	100	17120.000.100	5,0X50MM	100	17120.050.050
3,3X40MM	100	17120.000.040	3,45X40MM	100	17120.035.040	5,0X60MM	100	17120.050.060
3,45X50MM	100	17120.000.050	4,0X40MM	100	17120.040.040	5,0X70MM	100	17120.050.070

17119 Haki proste, niemetryczne, artykuł 7W

F11B

Materiał Stal
Obróbka powierzchni Epoksydowane białe



d ₁ x L	☒	Kod artykułu	d ₁ x L	☒	Kod artykułu	d ₁ x L	☒	Kod artykułu
2,5X25MM	100	17119.000.025	3,3X40MM	100	17119.000.040	4,0X60MM	100	17119.000.060
2,65X30MM	100	17119.000.030	3,45X50MM	100	17119.000.050			

- Stal cynkowana z białą powłoką epoksydową zapewniającą dodatkową ochronę powierzchni (60-80 µm), estetyczny wygląd.

Haki proste z wgłębieniem krzyżowym, niemetryczne

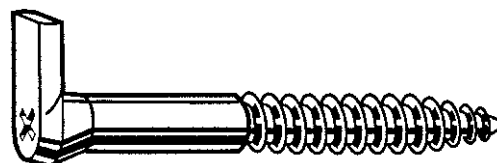
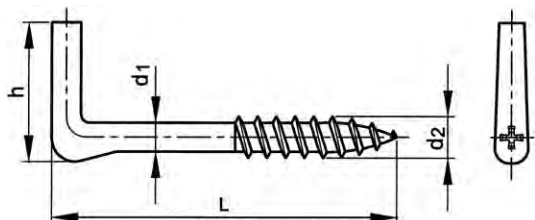

Informacje techniczne

d_1	d_2	h
5.25	5.3	16
5.8	5.8	18

17140 Haki proste z wgłębieniem krzyżowym, niemetryczne, artykuł 9G

F11B

Materiał Stal
Obróbka powierzchni O cynkowane

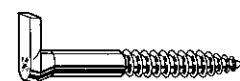

5

$d_1 \times L$	☒	Kod artykułu	$d_1 \times L$	☒	Kod artykułu	$d_1 \times L$	☒	Kod artykułu
5,25X40MM	100	17140.052.040	5,8X65MM	100	17140.060.065	5,8X80MM	100	17140.060.080
5,25X50MM	100	17140.052.050						

Haki proste zastrzone, niemetryczne

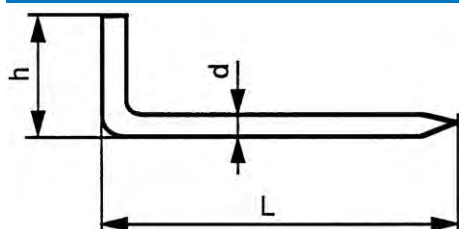

Informacje techniczne

$d \times L$	h	$d \times L$	h
2.5x20	10	4.0x50	19
2.5x25	12	4.0x60	20
3.0x30	13	5.0x80	21
3.5x40	16		

17080 Haki proste zastrzone, niemetryczne, artykuł 4

F11B

Materiał Stal
Obróbka powierzchni O cynkowane



$d \times L$	☒	Kod artykułu	$d \times L$	☒	Kod artykułu	$d \times L$	☒	Kod artykułu
2,5X20MM	100	17080.000.020	3,5X40MM	100	17080.000.040	4,0X60MM	100	17080.000.060
2,5X25MM	100	17080.000.025	4,0X50MM	100	17080.000.050	5,0X80MM	100	17080.000.080
3,0X30MM	100	17080.000.030						

Wkręty dwugwintowe

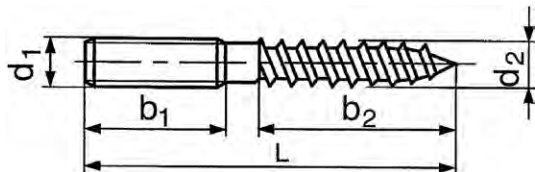

Informacje techniczne

$d_1 \times L$	b_1	b_2	d_2	Nasadka	P
M4x20	10	10	4.2	-	0.7
M4x25	10	10	4.2	-	0.7
M4x30	10	15	4.2	-	0.7
M4x35	15	15	4.2	-	0.7
M4x40	17	20	4.2	-	0.7
M5x25	10	15	5.35	-	0.8
M5x40	15	20	5.35	-	0.8
M5x50	20	20	5.35	-	0.8
M6x40	17	23	6	T15	1
M6x50	20	25	6	T15	1
M6x60	20	30	6	T15	1
M6x70	30	30	6	T15	1
M6x80	20	30	6	T15	1
M6x90	30	30	6	T15	1
M6x120	30	30	6	T15	1
M6x150	30	30	6	T15	1

5

17320 Wkręty dwugwintowe, artykuł 73

F11B

Gwint Metryczny
 Materiał Stal
 Obróbka powierzchni Ocynkowane



$d_1 \times L$	☒	Kod artykułu	$d_1 \times L$	☒	Kod artykułu	$d_1 \times L$	☒	Kod artykułu
M4X20	100	17320.040.020	M5X25	100	17320.050.025	M6X60	100	17320.060.060
M4X25	100	17320.040.025	M5X40	100	17320.050.040	M6X70	100	17320.060.070
M4X30	100	17320.040.030	M5X50	100	17320.050.050	M6X80	100	17320.060.080
M4X35	100	17320.040.035				M6X90	100	17320.060.090
M4X40	100	17320.040.040	M6X40	100	17320.060.040	M6X120	100	17320.060.120
			M6X50	100	17320.060.050	M6X150	100	17320.060.150

- Jedynie M6 z gniazdem torx T15.

Wkręty dwugwintowe, nierdzewne

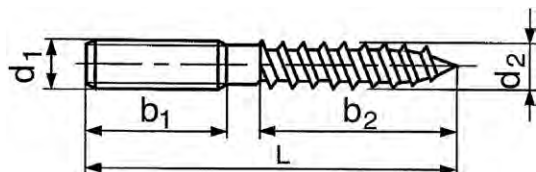

Informacje techniczne

d ₁	b ₁	b ₂	d ₂	P
M6	50	47	6.3	1
M8	50	62	7.3	1.25
M12	205	100	10.7	1.75

51287 Wkręty dwugwintowe, nierdzewne

F11A

Gwint: Metryczny
 Materiał: Stal nierdzewna A2
 Klasa: 50



5

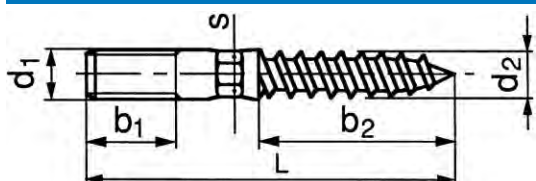

d ₁ x L	☒	Kod artykułu	d ₁ x L	☒	Kod artykułu	d ₁ x L	☒	Kod artykułu
6X50MM*	100	51287.060.050	6X140MM*	100	51287.060.140	8X150MM*	100	51287.080.150
6X60MM*	100	51287.060.060	6X150MM*	100	51287.060.150	8X160MM*	100	51287.080.160
6X70MM*	100	51287.060.070	6X160MM*	100	51287.060.160	8X180MM*	50	51287.080.180
6X80MM*	100	51287.060.080	6X180MM*	100	51287.060.180	8X200MM*	50	51287.080.200
6X90MM*	100	51287.060.090				8X220MM*	50	51287.080.220
6X100MM*	100	51287.060.100	8X50MM*	100	51287.080.050			
6X120MM*	100	51287.060.120	8X60MM*	100	51287.080.060	12X80MM*	50	51287.120.080
6X130MM*	100	51287.060.130	8X70MM*	100	51287.080.070	12X300MM*	50	51287.120.300

Wkręty dwugwintowe z częścią sześciokątną



Informacje techniczne

d ₁ x L	b ₁	b ₂	d ₂	P	s
M6x60	20	30	6	1	6
M8x60	20	30	7.3	1.25	6
M8x80	30	40	7.3	1.25	6
M8x90	30	40	7.3	1.25	6
M8x100	40	40	7.3	1.25	6
M8x120	50	50	7.3	1.25	6
M8x110	40	47	7.3	1.25	6
M8x130	50	47	7.3	1.25	6
M8x140	50	47	7.3	1.25	6
M8x150	50	50	7.3	1.25	6
M10x60	20	37	9.0	1.50	-
M10x80	30	40	9.0	1.50	8
M10x90	30	50	9.0	1.50	8
M10x100	30	60	9.0	1.50	8
M10x120	50	60	9.0	1.50	8
M10x140	50	60	9.0	1.50	8
M10x150	50	57	9.0	1.50	8
M10x160	80	57	9.0	1.50	8
M10x180	100	57	9.0	1.50	8
M10x200	100	57	9.0	1.50	8
M10x220	100	57	9.0	1.50	8
M10x250	100	57	9.0	1.50	8

17576	Wkręty dwugwintowe z częścią sześciokątną, artykuł 71	F11C
Gwint	Metryczny	
Materiał	Stal nierdzewna A2	
		 

$d_1 \times L$	☒	Kod artykułu	$d_1 \times L$	☒	Kod artykułu	$d_1 \times L$	☒	Kod artykułu
M6X60	100	17576.060.060	M8X130*	100	17576.080.130	M10X140	50	17576.100.140
M8X60	100	17576.080.060	M8X140*	100	17576.080.140	M10X150*	50	17576.100.150
M8X80	100	17576.080.080				M10X160*	50	17576.100.160
M8X100	50	17576.080.100	M10X60*	100	17576.100.060	M10X180*	50	17576.100.180
M8X110*	100	17576.080.110	M10X80	100	17576.100.080	M10X200*	50	17576.100.200
M8X120	50	17576.080.120	M10X100	50	17576.100.100	M10X220*	50	17576.100.220
			M10X120	50	17576.100.120	M10X250*	50	17576.100.250

Wkręty dwugwintowe z częścią sześciokątną, nierdzewne

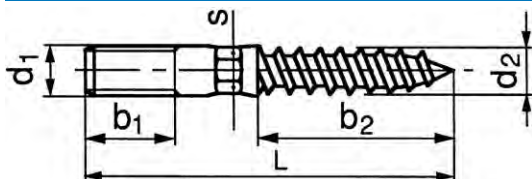

Informacje techniczne

d_1	b_1	b_2	d_2	P	s
M8	50	47	7.3	1.25	6
M10	50	57	9	1.5	8
M12	150	100	10.7	1.75	10

Grupy katalogowe

Gwint	Gniazdo	Materiał	Klasa	Kod	Strona
M	Sześciokąt	St.St. A2	50	51281	5-38
M	Sześciokąt	St.St. A4	50	55282	5-38

51281	Wkręty dwugwintowe z częścią sześciokątną, nierdzewne	F11A
Gwint	Metryczny	
Materiał	Stal nierdzewna A2	
Klasa	50	
		 

$d_1 \times L$	☒	Kod artykułu	$d_1 \times L$	☒	Kod artykułu	$d_1 \times L$	☒	Kod artykułu
M12X100*	50	51281.120.100	M12X160*	50	51281.120.160	M12X250*	50	51281.120.250
M12X120*	50	51281.120.120	M12X180*	50	51281.120.180	M12X300*	50	51281.120.300
M12X140*	50	51281.120.140	M12X200*	50	51281.120.200			

55282	Wkręty dwugwintowe z częścią sześciokątną, nierdzewne	R43A
Gwint	Metryczny	
Materiał	Stal nierdzewna A4	
Klasa	50	
		 

$d_1 \times L$	☒	Kod artykułu	$d_1 \times L$	☒	Kod artykułu	$d_1 \times L$	☒	Kod artykułu
M8X50*	100	55282.080.050	M8X120*	100	55282.080.120	M10X90*	100	55282.100.090
M8X60*	100	55282.080.060				M10X100*	100	55282.100.100
M8X80*	100	55282.080.080	M10X60*	100	55282.100.060	M10X120*	100	55282.100.120
M8X90*	100	55282.080.090	M10X80*	100	55282.100.080	M10X140*	50	55282.100.140
M8X100*	100	55282.080.100						

Wkręty dwugwintowe z częścią sześciokątną i gniazdem torx

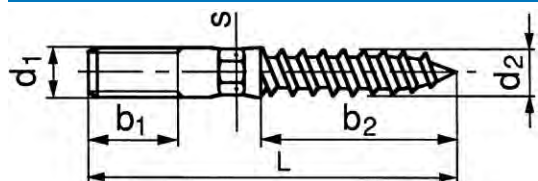

Informacje techniczne

d ₁ x L	b ₁	b ₂	d ₂	Nasadka	P	s
M8x50	15	30	7.3	T25	1.25	6
M8x60	20	30	7.3	T25	1.25	6
M8x70	25	30	7.3	T25	1.25	6
M8x80	30	40	7.3	T25	1.25	6
M8x90	30	40	7.3	T25	1.25	6
M8x100	40	40	7.3	T25	1.25	6
M8x120	50	50	7.3	T25	1.25	6
M8x140	50	50	7.3	T25	1.25	6
M8x150	50	50	7.3	T25	1.25	6
M8x160	50	50	7.3	T25	1.25	6
M10x60	20	40	9	T25	1.5	8
M10x70	30	30	9	T25	1.5	8
M10x80	30	40	9	T25	1.5	8
M10x90	30	50	9	T25	1.5	8
M10x100	30	60	9	T25	1.5	8
M10x110	40	60	9	T25	1.5	8
M10x120	50	60	9	T25	1.5	8
M10x130	50	60	9	T25	1.5	8
M10x140	50	60	9	T25	1.5	8
M12x100	30	55	10.7	T30	1.75	10
M12x120	30	55	10.7	T30	1.75	10
M12x145	40	55	10.7	T30	1.75	10
M12x165	40	55	10.7	T30	1.75	10

5

Grupy katalogowe

Gwint	Materiał	Obróbka powierzchni	Kod	Strona
M	St	Ocyнк.	69G	17310
M	St	Ocyнк.	69	17315

17310 Wkręty dwugwintowe z częścią sześciokątną i gniazdem torx, artykuł 69G

F11B

Gwint	Metryczny
Materiał	Stal
Obróbka powierzchni	Ocyńkowane



d ₁ x L	Kod artykułu	d ₁ x L	Kod artykułu	d ₁ x L	Kod artykułu
M8X50	100 17310.080.050	M8X140	100 17310.080.140	M10X90	50 17310.100.090
M8X60	100 17310.080.060	M8X150	100 17310.080.150	M10X100	50 17310.100.100
M8X70	100 17310.080.070	M8X160	100 17310.080.160	M10X110	50 17310.100.110
M8X80	100 17310.080.080			M10X120	50 17310.100.120
M8X90	100 17310.080.090	M10X60	100 17310.100.060	M10X130	50 17310.100.130
M8X100	100 17310.080.100	M10X70	100 17310.100.070	M10X140	50 17310.100.140
M8X120	100 17310.080.120	M10X80	100 17310.100.080		

17315 Wkręty dwugwintowe z częścią sześciokątną i gniazdem torx, artykuł 69

F11B

Gwint	Metryczny
Materiał	Stal
Obróbka powierzchni	Ocyńkowane



d ₁ x L	Kod artykułu	d ₁ x L	Kod artykułu	d ₁ x L	Kod artykułu
M12X100	50 17315.120.100	M12X140	50 17315.120.145	M12X160	50 17315.120.165
M12X120	50 17315.120.120				

Wkręty huśtawkowo-gimnastyczne, niemetryczne

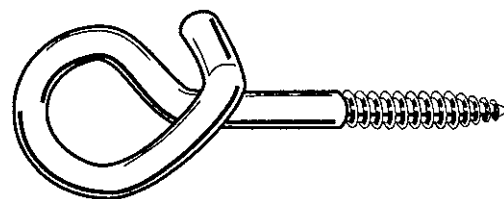
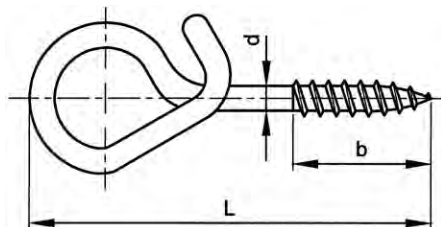

Informacje techniczne

d	b	d ₂
10	45	9.5
11.8	55	11.5

Dane montażowe

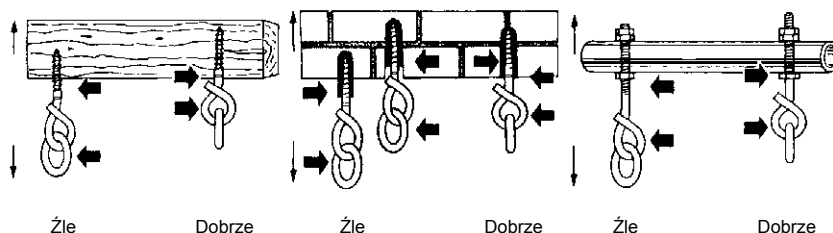

- wkręt huśtawkowo-gimnastyczny musi być wkręcony wystarczająco, tzn. tak aby nagwintowany trzon był całkowicie niewidoczny
- wkręt huśtawkowo-gimnastyczny musi być zamontowany **poprzecznie** do kierunku kołysania się (to powoduje, że pierścień obraca się i nie ześliznie się, co w konsekwencji zmniejsza niebezpieczeństwo do minimum)
- wkręt huśtawkowo-gimnastyczny i pierścień muszą być regularnie smarowane!
- obszerne dane montażowe znajdują się w każdym opakowaniu wkrętów huśtawkowo-gimnastycznych

17443 Wkręty huśtawkowo-gimnastyczne, niemetryczne, artykuł 117G

F11B

Materiał Stal
Obróbka powierzchni Ocynkowane



d x L	☒	Kod artykułu	d x L	☒	Kod artykułu	d x L	☒	Kod artykułu
10X125MM	10	17443.100.125	10X160MM	10	17443.100.160	11,8X140MM	10	17443.120.140
10X140MM	10	17443.100.140				11,8X160MM	10	17443.120.160

Wkręty huśtawkowo-gimnastyczne, metryczne

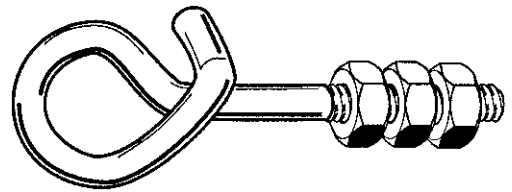
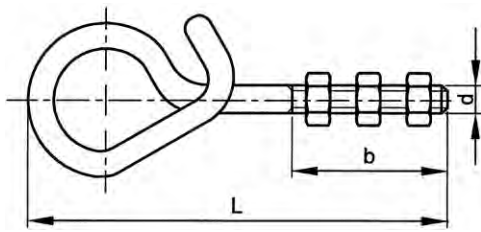

Informacje techniczne

d	P
M12	1.75

17445 Wkręty huśtawkowo-gimnastyczne, metryczne, artykuł 118G

F11B

Gwint Metryczny
 Materiał Stal
 Obróbka powierzchni Ocynkowane

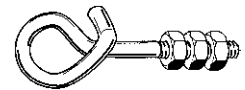

d x L/b	☒	Kod artykułu	d x L/b	☒	Kod artykułu	d x L/b	☒	Kod artykułu
M12X140X65	10	17445.120.140	M12X180X80	10	17445.120.180	M12X250X160	10	17445.120.250
M12X160X80	10	17445.120.160						

Pierścienie do wkrętów huśtawkowo-gimnastycznych zgrzewane

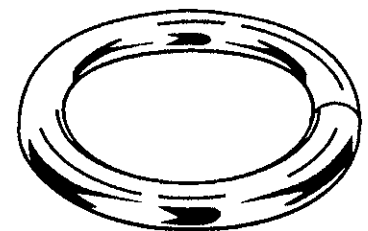
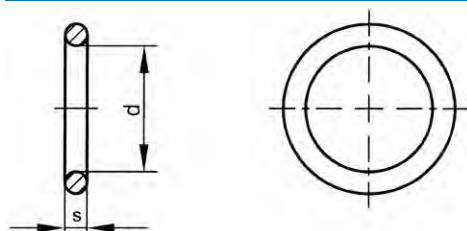

17447 Pierścienie do wkrętów huśtawkowo-gimnastycznych, zgrzewane, artykuł 119G

F11B

Materiał Stal
 Obróbka powierzchni Ocynkowane



s x d	☒	Kod artykułu
9X45MM	10	17447.090.045

Haki do bram z 2 hakami oczkowymi, niemetryczne

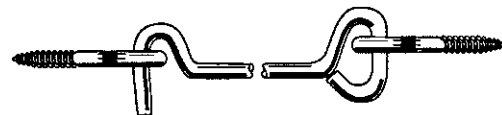
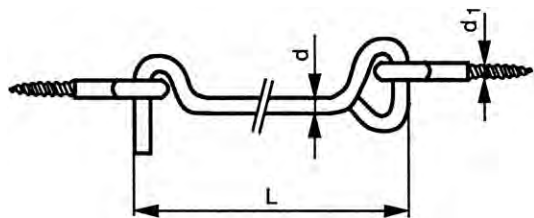

Informacje techniczne

L	d	d ₁	L	d	d ₁
100	4.4	4.0	200	5.25	4.75
160	5.25	4.75	250	6.0	5.25

17571 Haki do bram z 2 hakami oczkowymi, niemetryczne, artykuł 63R

F11C

Materiał Stal nierdzewna A2



5

L	☒	Kod artykułu	L	☒	Kod artykułu	L	☒	Kod artykułu
100MM	50	17571.040.100	200MM	25	17571.052.200	250MM	25	17571.060.250
160MM	25	17571.052.160						

Haki w kształcie litery S

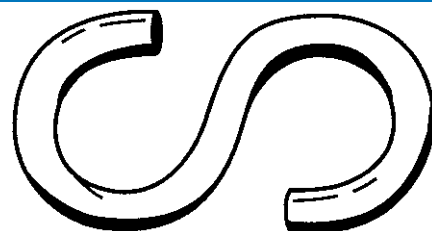
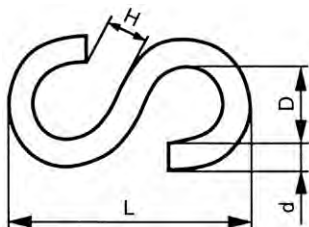

Informacje techniczne

Nr	d	D	H	Nr	d	D	H
30	3	7	3.5	55	6	15	6
35	3.45	9	4	60	6	16	7
40	4	11	5	70	7	20	7.5
45	4	12	5	80	8.4	23	8.5
50	5	14	5.5				

17380 Haki w kształcie litery S, artykuł 105G

F11B

Materiał Stal
Obróbka powierzchni O cynkowane



Nr (L)	☒	Kod artykułu	Nr (L)	☒	Kod artykułu	Nr (L)	☒	Kod artykułu
NO.30 (25MM)	100	17380.000.030	NO.45 (40MM)	100	17380.000.045	NO.60 (55MM)	100	17380.000.060
NO.35 (30MM)	100	17380.000.035	NO.50 (45MM)	100	17380.000.050	NO.70 (65MM)	50	17380.000.070
NO.40 (35MM)	100	17380.000.040	NO.55 (50MM)	100	17380.000.055	NO.80 (75MM)	50	17380.000.080

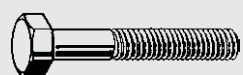

1 Śruby

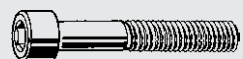

2 Produkty z gniazdem sześciokątnym



3 Nakrętki, nitonakrętki & wkładki



4 Pręty gwintowane & śruby dwustronne



5 Haki & śruby oczkowe



6 Wkręty

I Index



7 Podkładki & pierścienie uszczelniające typu “O-ring”



8 Kotwy, kołki, dyble

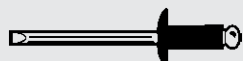

9 Nity, kołki & wpusty



10 Elementy łączące systemowe, meblowe & zabezpieczające



11 Zestawy

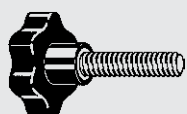

12 Części konstrukcyjne & części maszynowe













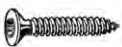







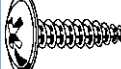

















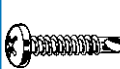





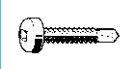



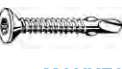

13 Przemysł morski

T Technologia łączenia



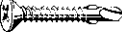















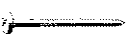





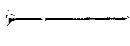











Wkręty 6

 <p>Strona 6-4 DIN 551</p> <p>Wkręt dociskowy z końcem płaskim</p>	 <p>Strona 6-6 DIN 553</p> <p>Wkręt dociskowy z końcem stożkowym</p>	 <p>Strona 6-7 DIN 438</p> <p>Wkręt dociskowy z końcem wgłębionym</p>	 <p>Strona 6-8 DIN 427</p> <p>Wkręt dociskowy z końcem płaskim</p>	 <p>Strona 6-9 DIN 417</p> <p>Wkręt dociskowy z czopem walcowym</p>
 <p>Strona 6-10 DIN 84</p> <p>Metryczny z łbem walcowym</p>	 <p>Strona 6-16 DIN 85</p> <p>Metryczny z łbem walcowym płaskim</p>	 <p>Strona 6-19 DIN 920</p> <p>Metryczny z łbem walcowym pomniejszonym</p>	 <p>Strona 6-20 DIN 921</p> <p>Metryczny z łbem płaskim powiększonym</p>	 <p>Strona 6-21 DIN 963</p> <p>Metryczny z łbem stożkowym płaskim</p>
 <p>Strona 6-27 BS ≈450 (1958)</p> <p>BSW z łbem stożkowym płaskim</p>	 <p>Strona 6-28 DIN 964</p> <p>Metryczny z łbem stożkowo-soczewkowym</p>	 <p>Strona 6-31 BS ≈450 (1958)</p> <p>BSW z łbem kulistym</p>	 <p>Strona 6-32 NF ≈E25-129</p> <p>Metryczny z łbem grzybkowym powiększonym</p>	 <p>Strona 6-33 DIN 404</p> <p>Metryczny z łbem walcowym z otworami</p>
 <p>Strona 6-34 DIN 923</p> <p>Metryczny z kołnierzem walcowym</p>	 <p>Strona 6-35 DIN ≈6900</p> <p>Metryczny z dużą podkładką</p>	 <p>Strona 6-35 DIN 7985</p> <p>Metryczny z gniazdem krzyżowym</p>	 <p>Strona 6-41 ISO 14583</p> <p>Metryczny z gniazdem sześciokąrnym</p>	 <p>Strona 6-43 ISO 14580</p> <p>Metryczny z gniazdem sześciokąrnym</p>
 <p>Strona 6-44 DIN 965</p> <p>Metryczny z gniazdem krzyżowym</p>	 <p>Strona 6-49 DIN ≈965</p> <p>Metryczny z gniazdem sześciokąrnym</p>	 <p>Strona 6-51 DIN 966</p> <p>Metryczny z gniazdem krzyżowym</p>	 <p>Strona 6-54 DIN ≈966</p> <p>Metryczny z gniazdem sześciokąrnym</p>	 <p>Strona 6-55 NF ≈E25-129</p> <p>Metryczny z łbem grzybkowym powiększonym</p>
 <p>Strona 6-56 NF E25-129</p> <p>Metryczny z łbem grzybkowym powiększonym</p>	 <p>Strona 6-57 DIN 7516 AE-H</p> <p>Metryczny samogwintujący</p>	 <p>Strona 6-58 DIN 7516 EE-H</p> <p>Metryczny samogwintujący</p>	 <p>Strona 6-59 DIN 7516 DE-H</p> <p>Metryczny samogwintujący</p>	 <p>Strona 6-60 DIN 7513 A</p> <p>Metryczny samogwintujący</p>
 <p>Strona 6-61</p> <p>UNC samogwintujący</p>	 <p>Strona 6-63 DIN ≈7500</p> <p>TAPTITE 2000® Metryczny</p>	 <p>Strona 6-64 DIN ≈7500-1</p> <p>TAPTITE 2000® Metryczny</p>	 <p>Strona 6-65 DIN ≈7500-1</p> <p>TAPTITE 2000® Metryczny</p>	 <p>Strona 6-66</p> <p>Metryczny samogwintujący</p>
 <p>Strona 6-67</p> <p>Metryczny samogwintujący z gniazdem sześciokąrnym</p>	 <p>Strona 6-68</p> <p>Metryczny samogwintujący z łbem stożkowym</p>	 <p>Strona 6-68</p> <p>Metryczny samogwintujący z gniazdem sześciokąrnym</p>	 <p>Strona 6-70</p> <p>REMFORD®</p>	 <p>Strona 6-71</p> <p>REMFORD® Torx®</p>
 <p>Strona 6-71</p> <p>REMFORD® samoformujący do tworzyw</p>	 <p>Strona 6-72</p> <p>Wkręty samoformujące do tworzyw</p>	 <p>Strona 6-72</p> <p>Wkręt samoformujący do tworzyw</p>	 <p>Strona 6-73 DIN 7971</p> <p>Wkręt do metalu</p>	 <p>Strona 6-75 DIN 7972 C</p> <p>Wkręt do metalu</p>
 <p>Strona 6-76 DIN 7973 C</p> <p>Wkręt do metalu</p>	 <p>Strona 6-78 DIN 7981</p> <p>Wkręt do metalu</p>	 <p>Strona 6-84 ISO 14585 C</p> <p>Sześciokąrnym</p>	 <p>Strona 6-86 DIN ≈7981 C</p> <p>Łeb walcowo-wypukły z gniazdem kwadratowym</p>	 <p>Strona 6-87 DIN 7982</p> <p>Wkręt do metalu</p>

Wkręty 6

 Strona 6-91 ISO 14586 C Sześciokarbowy	 Strona 6-93 DIN =7982 C Samogwintujący z gniazdem kwadratowym	 Strona 6-94 DIN 7983 Wkręt do metalu	 Strona 6-98 DIN 7976 Wkręt do metalu	 Strona 6-100 DIN =6928 C Wkręt do metalu
 Strona 6-100 Z zakończeniem stożkowym z dużą podk.	 Strona 6-101 Wkręt z gniazdem imbusowym	 Strona 6-102 ISO 14587 C Wkręt z gniazdem sześciokarbowym	 Strona 6-103 Wkręt z łbem podkładowym	 Strona 6-104 Wkręt do okien z podkładką
 Strona 6-105 Wkręt do okien sześciokarbowy z podkładką	 Strona 6-106 Wkręt do okien sześciokarbowy z podkładką gruboźwojny	 Strona 6-107 Wkręt do metalu	 Strona 6-107 Wkręt do tablic rejestracyjnych	 Strona 6-108 Wkręt do tablic rejestracyjnych philips
 Strona 6-109 Wkręt do tablic rejestracyjnych sześciokarbowy	 Strona 6-109 Wkręt do tablic rejestracyjnych z nakrętką	 Strona 6-110 Nasadki na wkręty do tablic rejestracyjnych	 Strona 6-111 Wkręt do pokryć dachowych z uszczelką	 Strona 6-112 Wkręt do elewacji z uszczelką 16mm
 Strona 6-113 Wkręt do elewacji z uszczelką 19mm	 Strona 6-114 Wkręt do elewacji z uszczelką 22mm	 Strona 6-115 Wkręt do elewacji z gwintem żebrowanym	 Strona 6-115 Wkręt do pokryć dachowych samowierący	 Strona 6-116 Podkładki uszczelniające z Elastomeru
 Strona 6-117 Podkładki uszczelniające, szare EPDM	 Strona 6-119 DIN =7504 M-H Wkręt samowierący MAXXFAST	 Strona 6-120 DIN =7504 M-H Wkręt samowierący MaxxFast z A2	 Strona 6-122 DIN 7504 M-H Wkręt samowierący SPEDEC	 Strona 6-126 DIN =7504 M MAXXFAST Wkręt samowierący z gniazdem ttap®
 Strona 6-127 DIN =7504 M MAXXFAST Wkręt samowierący z gniazdem ttap® z A2	 Strona 6-128 DIN =7504 M MAXXFAST Wkręt samowierący z gniazdem kwadratowym	 Strona 6-129 DIN =7504 M Wkręt samowierący z gniazdem kwadratowo-krzyżowym	 Strona 6-130 DIN =7504 M Wkręt samowierący z gniazdem kwadratowym	 Strona 6-130 DIN =7504 O-H MAXXFAST Wkręt samowierący do metalu, łeb stożkowy
 Strona 6-132 DIN 7504 O-H Wkręt samowierący do metalu, łeb stożkowy	 Strona 6-134 DIN =7504 O MAXXFAST Wkręt samowierący z gniazdem ttap®, łeb stożkowy	 Strona 6-135 DIN =7504 K MAXXFAST Wkręty z łbem sześciokątym MaxxFast	 Strona 6-137 DIN 7504 K Wkręty z łbem sześciokątym SPEDEC	 Strona 6-139 Wkręt samowierący z łbem powiększonym
 Strona 6-140 Wkręt samowierący z gniazdem kwadratowo-krzyżowym	 Strona 6-141 MAXXFAST Wkręt samowierący ttap® ze skrzydełkami	 Strona 6-142 Wkręt do metalu Torx®	 Strona 6-143 Wkręt do metalu Torx®	 Strona 6-144 Wkręt do metalu, Torx®, UNC
 Strona 6-145 Wkręt do metalu	 Strona 6-146 Narzędzia do wkrętów samowierących	 Strona 6-149 MAXXFAST Wkręt do drewna z łbem stożkowym	 Strona 6-151 MAXXFAST Wkręt do drewna z łbem stożkowy z ttap®	 Strona 6-154 Wkręt do płyt wiórowych

Wkręty 6

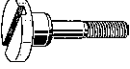
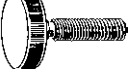
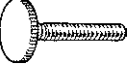
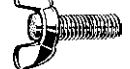
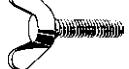
<p>Strona 6-158</p>  <p>Wkręt do płyt wiórowych z małym łbem</p>	<p>Strona 6-159</p>  <p>Wkręt do płyt wiórowych z gniazdem krzyżowym</p>	<p>Strona 6-159</p>  <p>Wkręt do płyt wiórowych z gniazdem sześciokątnym</p>	<p>Strona 6-162</p>  <p>Wkręt z gniazdem sześciokątnym, nierdzewny</p>	<p>Strona 6-163</p>  <p>Wkręt z gniazdem sześciokątnym z A4</p>
<p>Strona 6-164</p>  <p>MAXXFAST Wkręt do drewna z łbem stożkowym z ttap®</p>	<p>Strona 6-164</p>  <p>Wkręt do drewna z łbem stożkowym sześciokątnym</p>	<p>Strona 6-165</p>  <p>Wkręt tarasowy</p>	<p>Strona 6-165</p>  <p>MAXXFAST Wkręt do drewna uniwersalny</p>	<p>Strona 6-167</p>  <p>MAXXFAST Wkręt do drewna uniwersalny z gniazdem ttap®</p>
<p>Strona 6-168</p>  <p>HECO-FIX, wkręt do płyt wiórowych</p>	<p>Strona 6-170</p>  <p>Wkręt do drewna z łbem sześciokątnym</p>	<p>Strona 6-171</p>  <p>Wkręt do drewna z łbem sześciokątnym nierdzewny</p>	<p>Strona 6-171</p>  <p>Wkręt do płyt wiórowych</p>	<p>Strona 6-173 DIN 571</p>  <p>Wkręt do drewna z łbem sześciokątnym</p>
<p>Strona 6-176</p>  <p>MAXXFAST Wkręt konstrukcyjny z gniazdem ttap®</p>	<p>Strona 6-177</p>  <p>MAXXFAST Wkręt konstrukcyjny z kołnierzem z gniazdem ttap®</p>	<p>Strona 6-178</p>  <p>Wkręt do drewna z gniazdem sześciokątnym</p>	<p>Strona 6-179 DIN 97</p>  <p>Wkręt do drewna z nacięciem prostym</p>	<p>Strona 6-182 DIN 96</p>  <p>Wkręt do drewna z łbem kulistym</p>
<p>Strona 6-185 DIN 95</p>  <p>Wkręt do drewna z łbem soczewkowym</p>	<p>Strona 6-187 DIN 7997-Z</p>  <p>Wkręt do płyt wiórowych</p>	<p>Strona 6-188</p>  <p>Wkręt konstrukcyjny z łbem stożkowym</p>	<p>Strona 6-189 DIN 7996</p>  <p>Wkręt do drewna z łbem kulistym i gniazdem krzyżowym</p>	<p>Strona 6-190 DIN 7995-Z</p>  <p>Wkręt do płyt wiórowych</p>
<p>Strona 6-191</p>  <p>Wkręt do drewna z podkładką 3TG PZ</p>	<p>Strona 6-193</p>  <p>Wkręt do drewna z podkładką 2TG PZ</p>	<p>Strona 6-195</p>  <p>Wkręt do drewna z podkładką 3TG TX</p>	<p>Strona 6-196</p>  <p>Wkręt do drewna z podkładką 2TG TX</p>	<p>Strona 6-198</p>  <p>Wkręt do płyt kartonowo-gipsowych</p>
<p>Strona 6-199</p>  <p>Wkręt do płyt kartonowo-gipsowych</p>	<p>Strona 6-200</p>  <p>Zaślepka plastikowa</p>	<p>Strona 6-201</p>  <p>Zaślepka plastikowa</p>	<p>Strona 6-201</p>  <p>Zaślepka plastikowa</p>	<p>Strona 6-202</p>  <p>Zaślepka plastikowa</p>
<p>Strona 6-203</p>  <p>Wkręt z łbem płytkowym (kciukowy)</p>	<p>Strona 6-204 DIN 464</p>  <p>Wkręt z łbem radełkowym wysokim</p>	<p>Strona 6-205 DIN 464 Sz</p>  <p>Wkręt z łbem radełkowym wysokim z nacięciem</p>	<p>Strona 6-206 DIN 653</p>  <p>Metryczny z łbem radełkowym niskim</p>	<p>Strona 6-207</p>  <p>Wkręt z łbem radełkowym z tworzywa</p>
<p>Strona 6-208</p>  <p>Wkręt skrzydełkowy typ amerykański</p>	<p>Strona 6-209 DIN 316</p>  <p>Wkręt skrzydełkowy zaokrąglony</p>			

Wkręty dociskowe bez łba z gwintem na całej długości z końcem płaskim z nacięciem prostym

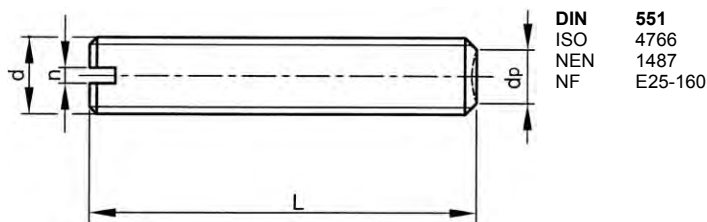

DIN 551
ISO 4766
NEN 1487
NF E25-160

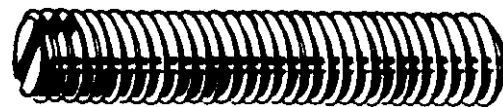

Informacje techniczne

d	d _p	n	P	d	d _p	n	P
M1.6	0.8	0.25	0.35	M6	4	1	1
M2	1	0.25	0.4	M8	5.5	1.2	1.25
M2.5	1.5	0.4	0.45	M10	7	1.6	1.5
M3	2	0.4	0.5	M12	8.5	2	1.75
M4	2.5	0.6	0.7	M16	11.5	2.5	2
M5	3.5	0.8	0.8				

Grupy katalogowe

Gwint	Gniazdo	Materiał	Klasa	Kod	Strona
M	Szczelina	St	14H	20010	6-4
M	Szczelina	St.St. A1/A2		51292	6-4
M	Szczelina	St.St. A4		55292	6-5

6

20010 Wkręty dociskowe bez łba z gwintem na całej długości z końcem płaskim z nacięciem prostym G07A

Gwint
Materiał
Klasa

Metryczny
Stal
14H



d x L	☒	Kod artykułu	d x L	☒	Kod artykułu	d x L	☒	Kod artykułu
M3X4	500	20010.030.004	M4X25	250	20010.040.025	M6X10	500	20010.060.010
M3X5	500	20010.030.005	M4X30	250	20010.040.030	M6X12	250	20010.060.012
M3X6	500	20010.030.006	M4X35	250	20010.040.035	M6X16	250	20010.060.016
M3X8	500	20010.030.008				M6X20	250	20010.060.020
M3X10	500	20010.030.010	M5X5	500	20010.050.005	M6X25	250	20010.060.025
M3X16	500	20010.030.016	M5X6	500	20010.050.006			
M3X20	500	20010.030.020	M5X8	500	20010.050.008	M8X10	250	20010.080.010
			M5X10	500	20010.050.010	M8X20	250	20010.080.020
M4X4	500	20010.040.004	M5X12	500	20010.050.012	M8X30	100	20010.080.030
M4X5	500	20010.040.005	M5X16	250	20010.050.016			
M4X6	500	20010.040.006	M5X20	250	20010.050.020	M10X10	250	20010.100.010
M4X8	500	20010.040.008	M5X25	250	20010.050.025	M10X20	100	20010.100.020
M4X10	500	20010.040.010				M10X30	100	20010.100.030
M4X12	500	20010.040.012	M6X6	500	20010.060.006	M10X40	100	20010.100.040
M4X16	500	20010.040.016	M6X8	500	20010.060.008	M10X50	100	20010.100.050
M4X20	250	20010.040.020						

51292 Wkręty dociskowe bez łba z gwintem na całej długości z końcem płaskim z nacięciem prostym R03A

Gwint
Materiał



Metryczny
Stal nierdzewna A1/A2



d x L	☒	Kod artykułu	d x L	☒	Kod artykułu	d x L	☒	Kod artykułu
M1,6X2*	200	51292.016.002	M2,5X3*	200	51292.025.003	M3X10	200	51292.030.010
M1,6X3*	200	51292.016.003	M2,5X4*	200	51292.025.004	M3X12*	200	51292.030.012
M1,6X4*	200	51292.016.004	M2,5X5*	200	51292.025.005	M3X16	200	51292.030.016
M1,6X5*	200	51292.016.005	M2,5X6*	200	51292.025.006	M3X20	200	51292.030.020
			M2,5X8*	200	51292.025.008			
M2X2*	200	51292.020.002	M2,5X10*	200	51292.025.010	M4X4	200	51292.040.004
M2X3*	200	51292.020.003				M4X5	200	51292.040.005
M2X4*	200	51292.020.004	M3X3*	200	51292.030.003	M4X6	200	51292.040.006
M2X5*	200	51292.020.005	M3X4*	200	51292.030.004	M4X8	200	51292.040.008
M2X6*	200	51292.020.006	M3X5*	200	51292.030.005	M4X10	200	51292.040.010
M2X8*	200	51292.020.008	M3X6	200	51292.030.006	M4X12	200	51292.040.012
M2X10*	200	51292.020.010	M3X8	200	51292.030.008	M4X16	200	51292.040.016
M2X12*	200	51292.020.012				M4X18*	200	51292.040.018

51292 Wkręty dociskowe bez łba z gwintem na całej długości z końcem płaskim z nacięciem prostym ←								
d x L	☒	Kod artykułu	d x L	☒	Kod artykułu	d x L	☒	Kod artykułu
M4X20	200	51292.040.020	M6X12*	200	51292.060.012	M8X40*	100	51292.080.040
M4X25*	200	51292.040.025	M6X16	200	51292.060.016	M8X45*	100	51292.080.045
M4X30	200	51292.040.030	M6X20	200	51292.060.020	M8X50*	100	51292.080.050
			M6X25	200	51292.060.025	M8X60*	100	51292.080.060
M5X5*	200	51292.050.005	M6X30*	200	51292.060.030			
M5X6	200	51292.050.006	M6X35*	200	51292.060.035	M10X10	100	51292.100.010
M5X8	200	51292.050.008	M6X40*	200	51292.060.040	M10X12*	50	51292.100.012
M5X10	200	51292.050.010	M6X45*	200	51292.060.045	M10X16*	50	51292.100.016
M5X12	200	51292.050.012	M6X60*	200	51292.060.060	M10X20	100	51292.100.020
M5X16	200	51292.050.016				M10X25*	50	51292.100.025
M5X20	200	51292.050.020	M8X8*	100	51292.080.008	M10X30	100	51292.100.030
M5X25*	200	51292.050.025	M8X10	200	51292.080.010	M10X35*	50	51292.100.035
M5X30*	200	51292.050.030	M8X12*	100	51292.080.012	M10X40	100	51292.100.040
M5X40*	200	51292.050.040	M8X16*	100	51292.080.016	M10X45*	50	51292.100.045
			M8X20	200	51292.080.020	M10X50*	50	51292.100.050
M6X6*	200	51292.060.006	M8X25*	100	51292.080.025	M10X55*	50	51292.100.055
M6X8	200	51292.060.008	M8X30	100	51292.080.030	M10X60*	50	51292.100.060
M6X10	200	51292.060.010	M8X35*	100	51292.080.035			

* W zależności od dostępności stali A1, może zostać dostarczona również stal A2.

55292 Wkręty dociskowe bez łba z gwintem na całej długości z końcem płaskim z nacięciem prostym		R43A
Gwint	Metryczny	
Materiał	Stal nierdzewna A4	
		
		

d x L	☒	Kod artykułu	d x L	☒	Kod artykułu	d x L	☒	Kod artykułu
M3X6*	200	55292.030.006	M6X6*	200	55292.060.006	M8X50*	100	55292.080.050
M3X10	200	55292.030.010	M6X8	200	55292.060.008	M8X60*	100	55292.080.060
			M6X10	200	55292.060.010			
M4X4*	200	55292.040.004	M6X12	200	55292.060.012	M10X10	100	55292.100.010
M4X5*	200	55292.040.005	M6X16	200	55292.060.016	M10X12*	50	55292.100.012
M4X6*	200	55292.040.006	M6X20	200	55292.060.020	M10X16*	50	55292.100.016
M4X8	200	55292.040.008	M6X25	200	55292.060.025	M10X20	100	55292.100.020
M4X10	200	55292.040.010	M6X30*	200	55292.060.030	M10X25*	50	55292.100.025
M4X12	200	55292.040.012	M6X35*	200	55292.060.035	M10X30	100	55292.100.030
			M6X40*	200	55292.060.040	M10X35*	50	55292.100.035
M5X5*	200	55292.050.005				M10X40	100	55292.100.040
M5X6	200	55292.050.006	M8X10	200	55292.080.010	M10X45*	50	55292.100.045
M5X8	200	55292.050.008	M8X12*	100	55292.080.012	M10X50*	50	55292.100.050
M5X10	200	55292.050.010	M8X16*	100	55292.080.016	M10X60*	50	55292.100.060
M5X12	200	55292.050.012	M8X20	200	55292.080.020			
M5X16	200	55292.050.016	M8X25*	100	55292.080.025	M12X20*	50	55292.120.020
M5X18*	200	55292.050.018	M8X30	100	55292.080.030	M12X25*	50	55292.120.025
M5X20	200	55292.050.020	M8X35*	100	55292.080.035	M12X30*	50	55292.120.030
M5X25*	200	55292.050.025	M8X40*	100	55292.080.040			
M5X30*	200	55292.050.030	M8X45*	100	55292.080.045	M16X35*	50	55292.160.035

Wkręty dociskowe bez łba z gwintem na całej długości z końcem stożkowym z nacięciem prostym

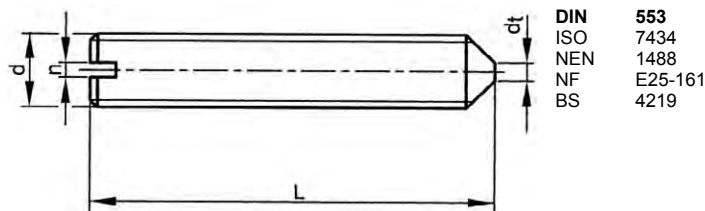

DIN 553
ISO 7434
NEN 1488
NF E25-161
BS 4219



Informacje techniczne



d	d _t (maks.)	n	P	d	d _t (maks.)	n	P
M1.6	0.16	0.25	0.35	M5	0.5	0.8	0.8
M2	0.2	0.25	0.4	M6	1.5	1	1
M2.5	0.25	0.4	0.45	M8	2	1.2	1.25
M3	0.3	0.4	0.5	M10	2.5	1.6	1.5
M4	0.4	0.6	0.7	M12	3	2	1.75

Grupy katalogowe

Gwint	Gniazdo	Materiał	Klasa	Kod	Strona
M	Szczelina	St	14H	20030	6-6
M	Szczelina	St.St. A1/A2		51293	6-6
M	Szczelina	St.St. A4		55293	6-7



6

20030		Wkręty dociskowe bez łba z gwintem na całej długości z końcem stożkowym z nacięciem prostym				G07A
Gwint	Metryczny					
Materiał	Stal					
Klasa	14H					

d x L	☒	Kod artykułu	d x L	☒	Kod artykułu	d x L	☒	Kod artykułu
M3X4	500	20030.030.004	M4X30	250	20030.040.030	M6X16	250	20030.060.016
M3X5	500	20030.030.005	M4X35	250	20030.040.035	M6X20	250	20030.060.020
M3X6	500	20030.030.006				M6X25	250	20030.060.025
M3X10	500	20030.030.010	M5X6	500	20030.050.006			
M3X12	500	20030.030.012	M5X8	500	20030.050.008	M8X10	250	20030.080.010
			M5X10	500	20030.050.010	M8X20	250	20030.080.020
M4X5	500	20030.040.005	M5X12	500	20030.050.012	M8X30	100	20030.080.030
M4X6	500	20030.040.006	M5X16	250	20030.050.016			
M4X8	500	20030.040.008	M5X20	250	20030.050.020	M10X10	250	20030.100.010
M4X10	500	20030.040.010	M5X25	250	20030.050.025	M10X16	100	20030.100.016
M4X12	500	20030.040.012				M10X20	100	20030.100.020
M4X16	500	20030.040.016	M6X8	500	20030.060.008	M10X30	100	20030.100.030
M4X20	250	20030.040.020	M6X10	500	20030.060.010	M10X40	100	20030.100.040
M4X25	250	20030.040.025	M6X12	250	20030.060.012	M10X50	100	20030.100.050



51293		Wkręty dociskowe bez łba z gwintem na całej długości z końcem stożkowym z nacięciem prostym				R03A
Gwint	Metryczny					
Materiał	Stal nierdzewna A1/A2					

d x L	☒	Kod artykułu	d x L	☒	Kod artykułu	d x L	☒	Kod artykułu
M1,6X2*	200	51293.016.002	M2,5X8*	200	51293.025.008	M4X12	200	51293.040.012
M1,6X3*	200	51293.016.003				M4X16	200	51293.040.016
M1,6X4*	200	51293.016.004	M3X3*	200	51293.030.003	M4X20*	200	51293.040.020
			M3X4	200	51293.030.004	M4X25	200	51293.040.025
M2X2*	200	51293.020.002	M3X5	200	51293.030.005	M4X30	200	51293.040.030
M2X3*	200	51293.020.003	M3X6	200	51293.030.006	M4X35	200	51293.040.035
M2X4*	200	51293.020.004	M3X8	200	51293.030.008			
M2X5*	200	51293.020.005	M3X10	200	51293.030.010	M5X5*	200	51293.050.005
M2X6*	200	51293.020.006	M3X16*	200	51293.030.016	M5X6	200	51293.050.006
M2X8*	200	51293.020.008	M3X20*	200	51293.030.020	M5X8	200	51293.050.008
M2X10*	200	51293.020.010				M5X10	200	51293.050.010
M2X12*	200	51293.020.012	M4X4*	200	51293.040.004	M5X12	200	51293.050.012
			M4X5	200	51293.040.005	M5X16	200	51293.050.016
M2,5X3*	200	51293.025.003	M4X6	200	51293.040.006	M5X20	200	51293.050.020
M2,5X5*	200	51293.025.005	M4X8	200	51293.040.008	M5X25	200	51293.050.025
M2,5X6*	200	51293.025.006	M4X10	200	51293.040.010	M5X30*	200	51293.050.030

51293 Wkręty dociskowe bez łba z gwintem na całą długości z końcem stożkowym z nacięciem prostym								
d x L	☒	Kod artykułu	d x L	☒	Kod artykułu	d x L	☒	Kod artykułu
M6X6*	200	51293.060.006	M8X8*	100	51293.080.008	M8X50*	100	51293.080.050
M6X8	200	51293.060.008	M8X10	200	51293.080.010	M10X12*	50	51293.100.012
M6X10	200	51293.060.010	M8X12*	100	51293.080.012	M10X16*	50	51293.100.016
M6X12*	200	51293.060.012	M8X16*	100	51293.080.016	M10X20	100	51293.100.020
M6X16	200	51293.060.016	M8X20	200	51293.080.020	M10X25*	50	51293.100.025
M6X20*	200	51293.060.020	M8X25*	100	51293.080.025	M10X30	100	51293.100.030
M6X25	200	51293.060.025	M8X30	200	51293.080.030	M10X35*	50	51293.100.035
M6X30*	200	51293.060.030	M8X35*	100	51293.080.035	M10X50	100	51293.100.050
M6X35*	200	51293.060.035	M8X40*	100	51293.080.040			
M6X40*	200	51293.060.040	M8X45*	100	51293.080.045			

• W zależności od dostępności stali A1, może zostać dostarczona również stal A2.

55293 Wkręty dociskowe bez łba z gwintem na całą długości z końcem stożkowym z nacięciem prostym		R43A
Gwint	Metryczny	
Materiał	Stal nierdzewna A4	
		
		

d x L	☒	Kod artykułu	d x L	☒	Kod artykułu	d x L	☒	Kod artykułu
M3X5	200	55293.030.005	M5X12	200	55293.050.012	M8X12*	100	55293.080.012
M3X8	200	55293.030.008	M5X16	200	55293.050.016	M8X16*	100	55293.080.016
M3X10	200	55293.030.010	M5X25	200	55293.050.025			
M4X5	200	55293.040.005	M6X6*	200	55293.060.006	M10X12*	50	55293.100.012
M4X8	200	55293.040.008	M6X10	200	55293.060.010	M10X16*	50	55293.100.016
M4X10	200	55293.040.010	M6X12	200	55293.060.012	M10X20	100	55293.100.020
M4X12	200	55293.040.012	M6X16	200	55293.060.016	M10X30	100	55293.100.030
M4X16	200	55293.040.016	M6X20	200	55293.060.020	M10X35*	50	55293.100.035
			M6X25	200	55293.060.025	M10X50	100	55293.100.050
M5X6	200	55293.050.006				M12X25*	50	55293.120.025
M5X8	200	55293.050.008	M8X10	200	55293.080.010	M12X30*	50	55293.120.030
M5X10	200	55293.050.010						

6

Wkręty dociskowe bez łba z gwintem na całą długości z końcem wgłębionym z nacięciem prostym

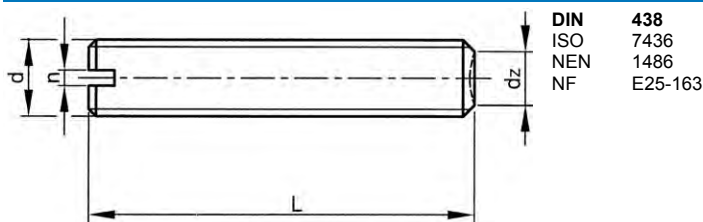



DIN 438
ISO 7436
NEN 1486
NF E25-163



Informacje techniczne							
d	d _z	n	P	d	d _z	n	P
M3	1.4	0.4	0.5	M6	3	1	1
M4	2	0.6	0.7	M8	5	1.2	1.25
M5	2.5	0.8	0.8	M10	6	1.6	1.5

Grupy katalogowe					
Gwint	Gniazdo	Materiał	Klasa	Kod	Strona
M	Szczelina	St	14H	20000	6-7
M	Szczelina	St.St. A1/A2		51291	6-8

20000 Wkręty dociskowe bez łba z gwintem na całą długości z końcem wgłębionym z nacięciem prostym		G07A						
Gwint	Metryczny							
Materiał	Stal							
Klasa	14H							
								
								
d x L	☒	Kod artykułu	d x L	☒	Kod artykułu	d x L	☒	Kod artykułu
M3X4	500	20000.030.004	M3X10	500	20000.030.010	M4X6	500	20000.040.006
M3X6	500	20000.030.006				M4X8	500	20000.040.008
M3X8	500	20000.030.008	M4X5	500	20000.040.005	M4X10	500	20000.040.010

20000 Wkręty dociskowe bez łba z gwintem na całej długości z końcem wgłębionym z nacięciem prostym								
d x L	☒	Kod artykułu	d x L	☒	Kod artykułu	d x L	☒	Kod artykułu
M4X12	500	20000.040.012	M5X6	500	20000.050.006	M6X8	500	20000.060.008
M4X16	500	20000.040.016	M5X8	500	20000.050.008	M6X10	500	20000.060.010
M4X25	250	20000.040.025	M5X10	500	20000.050.010	M6X12	250	20000.060.012
M4X30	250	20000.040.030	M5X16	250	20000.050.016	M6X16	250	20000.060.016
M4X35	250	20000.040.035	M5X20	250	20000.050.020	M6X20	250	20000.060.020

51291 Wkręty dociskowe bez łba z gwintem na całej długości z końcem wgłębionym z nacięciem prostym								R03A
Gwint	Metryczny							
Materiał	Stal nierdzewna A1/A2							

d x L	☒	Kod artykułu	d x L	☒	Kod artykułu	d x L	☒	Kod artykułu
M3X4	200	51291.030.004	M4X25	200	51291.040.025	M6X16	200	51291.060.016
M3X5	200	51291.030.005	M5X10	200	51291.050.010	M6X20	200	51291.060.020
M3X6	200	51291.030.006	M5X12	200	51291.050.012	M8X10*	100	51291.080.010
M3X8	200	51291.030.008	M5X16	200	51291.050.016	M8X12*	100	51291.080.012
M4X5*	200	51291.040.005	M5X20	200	51291.050.020	M8X16*	100	51291.080.016
M4X6	200	51291.040.006	M5X25*	200	51291.050.025	M8X20*	100	51291.080.020
M4X8	200	51291.040.008	M6X6*	100	51291.060.006	M8X25*	100	51291.080.025
M4X10	200	51291.040.010	M6X8	200	51291.060.008	M8X35*	100	51291.080.035
M4X12	200	51291.040.012	M6X12	200	51291.060.012	M10X35*	100	51291.100.035
M4X16	200	51291.040.016						
M4X20	200	51291.040.020						

* W zależności od dostępności stali A1, może zostać dostarczona również stal A2.

6

Wkręty dociskowe z końcem płaskim z nacięciem prostym

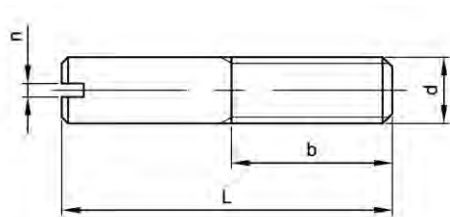

DIN 427
ISO 2342

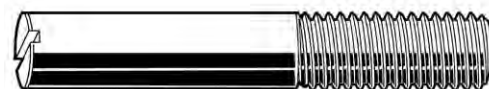

Informacje techniczne

d	b	n	P
M3	3.6	0.4	0.5
M4	4.8	0.6	0.7
M5	6.0	0.8	0.8
M6	7.2	1.0	1
M8	9.6	1.2	1.25
M10	12.0	1.6	1.5

51296 Wkręty dociskowe z końcem płaskim z nacięciem prostym								R03A
Gwint	Metryczny							
Materiał	Stal nierdzewna A2							

d x L	☒	Kod artykułu	d x L	☒	Kod artykułu	d x L	☒	Kod artykułu
M3X6*	200	51296.030.006	M4X30*	200	51296.040.030	M6X12*	100	51296.060.012
M3X8*	200	51296.030.008	M4X35*	200	51296.040.035	M6X16*	100	51296.060.016
M3X10*	200	51296.030.010	M5X10*	200	51296.050.010	M6X20*	100	51296.060.020
M3X12*	200	51296.030.012	M5X12*	200	51296.050.012	M6X25*	100	51296.060.025
M3X16*	200	51296.030.016	M5X16*	200	51296.050.016	M6X30*	100	51296.060.030
M4X8*	200	51296.040.008	M5X20*	200	51296.050.020	M6X35*	100	51296.060.035
M4X10*	200	51296.040.010	M5X25*	200	51296.050.025	M6X40*	100	51296.060.040
M4X12*	200	51296.040.012	M5X30*	200	51296.050.030	M8X16*	100	51296.080.016
M4X16*	200	51296.040.016	M5X35*	200	51296.050.035	M8X20*	100	51296.080.020
M4X20*	200	51296.040.020	M5X40*	200	51296.050.040	M8X25*	100	51296.080.025
M4X25*	200	51296.040.025				M8X30*	100	51296.080.030

51296 Wkręty dociskowe z końcem płaskim z nacięciem prostym								
d x L	☒	Kod artykułu	d x L	☒	Kod artykułu	d x L	☒	Kod artykułu
M8X35*	100	51296.080.035	M10X20*	50	51296.100.020	M10X35*	50	51296.100.035
M8X40*	100	51296.080.040	M10X25*	50	51296.100.025	M10X40*	50	51296.100.040
			M10X30*	50	51296.100.030			

Wkręty dociskowe z czopem walcowym z nacięciem prostym

DIN 417

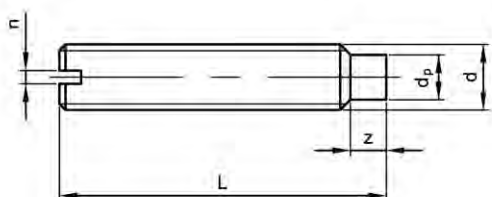

Informacje techniczne

d	d _p (maks.)	n	P	z (min.)
M3	2	0.4	0.5	1.5
M4	2.5	0.6	0.7	2
M5	3.5	0.8	0.8	2.5
M6	4	1	1	3
M8	5.5	1.2	1.25	4
M10	7	1.6	1.5	5
M12	8.5	2	1.75	6

6

51290 Wkręty dociskowe z czopem walcowym z nacięciem prostym		R09A
Gwint	Metryczny	
Materiał	Stal nierdzewna A2	

d x L	☒	Kod artykułu	d x L	☒	Kod artykułu	d x L	☒	Kod artykułu
M3X4*	200	51290.030.004	M5X8*	200	51290.050.008	M8X10*	100	51290.080.010
M3X5*	200	51290.030.005	M5X10*	200	51290.050.010	M8X12*	100	51290.080.012
M3X6*	200	51290.030.006	M5X12*	200	51290.050.012	M8X16*	100	51290.080.016
M3X8*	200	51290.030.008	M5X16*	200	51290.050.016	M8X20*	100	51290.080.020
M3X10*	200	51290.030.010	M5X20*	200	51290.050.020	M8X25*	100	51290.080.025
M3X12*	200	51290.030.012	M5X25*	200	51290.050.025	M8X30*	100	51290.080.030
M3X16*	200	51290.030.016				M8X40*	100	51290.080.040
M3X20*	200	51290.030.020	M6X6*	100	51290.060.006			
			M6X8*	100	51290.060.008	M10X12*	100	51290.100.012
M4X8*	200	51290.040.008	M6X10*	100	51290.060.010	M10X16*	100	51290.100.016
M4X10*	200	51290.040.010	M6X12*	100	51290.060.012	M10X20*	100	51290.100.020
M4X12*	200	51290.040.012	M6X16*	100	51290.060.016	M10X25*	100	51290.100.025
M4X16*	200	51290.040.016	M6X20*	100	51290.060.020	M10X30*	100	51290.100.030
M4X20*	200	51290.040.020						
			M8X8*	100	51290.080.008	M12X20*	50	51290.120.020

Wkręty z łbem walcowym płaskim z nacięciem prostym

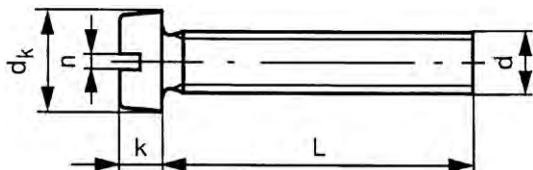

DIN	84
ISO	1207
NEN	1602
ASME	B18.6.7M
NF	E25-127
BS	4183

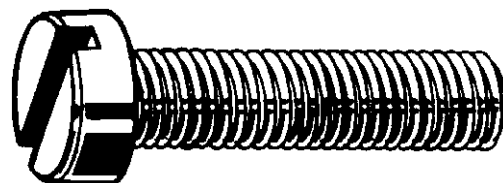

Informacje techniczne

d	dk	k	n	P	Pelen gwint L ≤
M1	2	0.7	0.25	0.25	30
M1.2	2.3	0.8	0.3	0.25	30
M1.4	2.6	0.9	0.3	0.3	30
M1.6	3	1	0.4	0.35	30
M1.7 (#DIN)	3.4	1.2	0.4	0.35	30
M2	3.8	1.3	0.5	0.4	30
M2.3 (#DIN)	4.4	1.5	0.6	0.45	30
M2.5	4.5	1.6	0.6	0.45	30
M2.6 (#DIN)	5	1.7	0.6	0.45	30
M3	5.5	2	0.8	0.5	30
M3.5	6	2.4	1	0.6	40
M4	7	2.6	1.2	0.7	40
M5	8.5	3.3	1.2	0.8	40
M6	10	3.9	1.6	1	40
M8	13	5	2	1.25	40
M10	16	6	2.5	1.5	40
M12 (#DIN)	18	7	3	1.75	40

Grupy katalogowe

Gwint	Gniazdo	Materiał	Klasa	Obróbka powierzchni	Kolor	Kod	Strona
M	Szczelina	St	4.8	Ocynk.		24520	6-10
M	Szczelina	St	4.8	Ocynk. żłt. pas.		24510	6-11
M	Szczelina	St	4.8	Ocynk. czrn. pas.		24515	6-11
M	Szczelina	St	8.8	Ocynk.		24402	6-12
M	Szczelina	St.St. A2				51121	6-12
M	Szczelina	St.St. A2			Duże Opakowanie	51120	6-12
M	Szczelina	St.St. A4				55120	6-13
M	Szczelina	Mosiądz Cu2/Cu3				48020	6-14
M	Szczelina	Mosiądz Cu2/Cu3		Nikl.		48520	6-15
M	Szczelina	Plastik PA	PA 6.6		Biały	56410	6-15

24520 Wkręty z łbem walcowym płaskim z nacięciem prostym

H01A

Gwint	Metryczny
Materiał	Stal
Klasa	4.8
Obróbka powierzchni	Ocynkowane



d x L	☒	Kod artykułu	d x L	☒	Kod artykułu	d x L	☒	Kod artykułu
M2X4	200	24520.020.004				M3,5X10	200	24520.035.010
M2X5	200	24520.020.005	M3X4	200	24520.030.004	M3,5X12	200	24520.035.012
M2X6	200	24520.020.006	M3X5	200	24520.030.005	M3,5X16	200	24520.035.016
M2X8	200	24520.020.008	M3X6	200	24520.030.006	M3,5X20	200	24520.035.020
M2X10	200	24520.020.010	M3X8	200	24520.030.008	M3,5X25	200	24520.035.025
M2X12	200	24520.020.012	M3X10	200	24520.030.010	M3,5X30	200	24520.035.030
M2X16	200	24520.020.016	M3X12	200	24520.030.012	M3,5X35	200	24520.035.035
M2X20	200	24520.020.020	M3X16	200	24520.030.016	M3,5X40	200	24520.035.040
M2X30	200	24520.020.030	M3X20	200	24520.030.020	M3,5X50	200	24520.035.050
			M3X25	200	24520.030.025			
M2,5X4	200	24520.025.004	M3X30	200	24520.030.030	M4X5	200	24520.040.005
M2,5X5	200	24520.025.005	M3X35	200	24520.030.035	M4X6	200	24520.040.006
M2,5X6	200	24520.025.006	M3X40	200	24520.030.040	M4X8	200	24520.040.008
M2,5X8	200	24520.025.008	M3X45	200	24520.030.045	M4X10	200	24520.040.010
M2,5X10	200	24520.025.010	M3X50	200	24520.030.050	M4X12	200	24520.040.012
M2,5X12	200	24520.025.012	M3X60	200	24520.030.060	M4X14	200	24520.040.014
M2,5X16	200	24520.025.016	M3X70	200	24520.030.070	M4X16	200	24520.040.016
M2,5X20	200	24520.025.020				M4X18	200	24520.040.018
M2,5X25	200	24520.025.025	M3,5X6	200	24520.035.006	M4X20	200	24520.040.020
M2,5X30	200	24520.025.030	M3,5X8	200	24520.035.008	M4X25	200	24520.040.025

24520 Wkręty z łbem walcowym płaskim z nacięciem prostym								
d x L	☒	Kod artykułu	d x L	☒	Kod artykułu	d x L	☒	Kod artykułu
M4X30	200	24520.040.030	M5X100	100	24520.050.100	M8X60	100	24520.080.060
M4X35	200	24520.040.035				M8X70	100	24520.080.070
M4X40	200	24520.040.040	M6X8	200	24520.060.008	M8X80	100	24520.080.080
M4X45	200	24520.040.045	M6X10	200	24520.060.010	M8X100	100	24520.080.100
M4X50	200	24520.040.050	M6X12	200	24520.060.012			
M4X55	200	24520.040.055	M6X16	200	24520.060.016	M10X16	100	24520.100.016
M4X60	200	24520.040.060	M6X20	200	24520.060.020	M10X20	100	24520.100.020
M4X65	200	24520.040.065	M6X25	200	24520.060.025	M10X25	100	24520.100.025
M4X70	200	24520.040.070	M6X30	200	24520.060.030	M10X30	100	24520.100.030
M4X80	200	24520.040.080	M6X35	200	24520.060.035	M10X35	100	24520.100.035
			M6X40	200	24520.060.040	M10X40	100	24520.100.040
M5X6	200	24520.050.006	M6X45	200	24520.060.045	M10X45	100	24520.100.045
M5X8	200	24520.050.008	M6X50	200	24520.060.050	M10X50	100	24520.100.050
M5X10	200	24520.050.010	M6X60	200	24520.060.060	M10X60	100	24520.100.060
M5X12	200	24520.050.012	M6X70	200	24520.060.070	M10X70	100	24520.100.070
M5X16	200	24520.050.016	M6X80	100	24520.060.080	M10X80	100	24520.100.080
M5X18	200	24520.050.018	M6X90	100	24520.060.090	M10X100	100	24520.100.100
M5X20	200	24520.050.020	M6X100	100	24520.060.100			
M5X25	200	24520.050.025				M12X20	100	24520.120.020
M5X30	200	24520.050.030	M8X10	200	24520.080.010	M12X25	100	24520.120.025
M5X35	200	24520.050.035	M8X12	200	24520.080.012	M12X30	100	24520.120.030
M5X40	200	24520.050.040	M8X16	200	24520.080.016	M12X35	100	24520.120.035
M5X45	200	24520.050.045	M8X20	200	24520.080.020	M12X40	100	24520.120.040
M5X50	200	24520.050.050	M8X25	200	24520.080.025	M12X50	100	24520.120.050
M5X55	100	24520.050.055	M8X30	200	24520.080.030	M12X60	50	24520.120.060
M5X60	200	24520.050.060	M8X35	200	24520.080.035	M12X70	50	24520.120.070
M5X70	200	24520.050.070	M8X40	200	24520.080.040	M12X80	50	24520.120.080
M5X80	100	24520.050.080	M8X45	200	24520.080.045			
M5X90	100	24520.050.090	M8X50	200	24520.080.050			

6

24510 Wkręty z łbem walcowym płaskim z nacięciem prostym			H01A
Gwint	Metryczny		
Materiał	Stal		
Klasa	4.8		
Obróbka powierzchni	Ocynkowane, po żółtej pasywacji		

d x L	☒	Kod artykułu	d x L	☒	Kod artykułu	d x L	☒	Kod artykułu
M2X6	500	24510.020.006	M4X6	500	24510.040.006	M5X60	200	24510.050.060
M2X8	500	24510.020.008	M4X8	500	24510.040.008	M5X70	200	24510.050.070
M2X10	500	24510.020.010	M4X10	500	24510.040.010	M5X80	200	24510.050.080
M2X12	500	24510.020.012	M4X12	500	24510.040.012			
M2X16	500	24510.020.016	M4X16	500	24510.040.016	M6X8	200	24510.060.008
			M4X20	500	24510.040.020	M6X10	200	24510.060.010
M2,5X6	500	24510.025.006	M4X25	500	24510.040.025	M6X12	200	24510.060.012
M2,5X8	500	24510.025.008	M4X30	500	24510.040.030	M6X16	200	24510.060.016
M2,5X10	500	24510.025.010	M4X35	500	24510.040.035	M6X20	200	24510.060.020
M2,5X12	500	24510.025.012	M4X40	500	24510.040.040	M6X25	200	24510.060.025
M2,5X16	500	24510.025.016	M4X45	500	24510.040.045	M6X30	200	24510.060.030
M2,5X20	500	24510.025.020	M4X50	500	24510.040.050	M6X35	200	24510.060.035
M2,5X25	500	24510.025.025	M4X60	200	24510.040.060	M6X40	200	24510.060.040
			M4X70	200	24510.040.070	M6X45	200	24510.060.045
M3X6	500	24510.030.006	M4X80	200	24510.040.080	M6X50	200	24510.060.050
M3X8	500	24510.030.008				M6X60	200	24510.060.060
M3X10	500	24510.030.010	M5X8	500	24510.050.008	M6X70	200	24510.060.070
M3X12	500	24510.030.012	M5X10	500	24510.050.010	M6X80	200	24510.060.080
M3X16	500	24510.030.016	M5X12	500	24510.050.012			
M3X20	500	24510.030.020	M5X16	500	24510.050.016	M8X16	200	24510.080.016
M3X25	500	24510.030.025	M5X20	500	24510.050.020	M8X20	200	24510.080.020
M3X30	500	24510.030.030	M5X25	500	24510.050.025	M8X25	200	24510.080.025
M3X35	500	24510.030.035	M5X30	500	24510.050.030	M8X30	200	24510.080.030
M3X40	500	24510.030.040	M5X35	500	24510.050.035	M8X35	200	24510.080.035
M3X50	500	24510.030.050	M5X40	500	24510.050.040	M8X40	200	24510.080.040
M3X60	500	24510.030.060	M5X45	200	24510.050.045	M8X50	200	24510.080.050
			M5X50	200	24510.050.050	M8X80	200	24510.080.080

24515 Wkręty z łbem walcowym płaskim z nacięciem prostym			H01A
Gwint	Metryczny		
Materiał	Stal		
Klasa	4.8		
Obróbka powierzchni	Ocynkowane, po czarnej pasywacji		

d x L	☒	Kod artykułu	d x L	☒	Kod artykułu	d x L	☒	Kod artykułu
M2X6	200	24515.020.006	M3X20	200	24515.030.020	M5X6	200	24515.050.006
M2X8	200	24515.020.008	M3X25	200	24515.030.025	M5X8	200	24515.050.008
M2X10	200	24515.020.010	M3X30	200	24515.030.030	M5X10	200	24515.050.010
M2X12	200	24515.020.012				M5X12	200	24515.050.012
M2X16	200	24515.020.016	M4X6	200	24515.040.006	M5X16	200	24515.050.016
M2X20	200	24515.020.020	M4X8	200	24515.040.008	M5X20	200	24515.050.020
			M4X10	200	24515.040.010			
M3X4	200	24515.030.004	M4X12	200	24515.040.012	M6X8	200	24515.060.008
M3X6	200	24515.030.006	M4X16	200	24515.040.016	M6X10	200	24515.060.010
M3X8	200	24515.030.008	M4X20	200	24515.040.020	M6X16	200	24515.060.016
M3X10	200	24515.030.010	M4X25	200	24515.040.025	M6X20	200	24515.060.020
M3X12	200	24515.030.012	M4X30	200	24515.040.030			
M3X16	200	24515.030.016						

24402 Wkręty z łbem walcowym płaskim z nacięciem prostym H07A

Gwint	Metryczny
Materiał	Stal
Klasa	8.8
Obróbka powierzchni	Ocynkowane



d x L	☒	Kod artykułu	d x L	☒	Kod artykułu	d x L	☒	Kod artykułu
M2X5	200	24402.020.005	M3X16	200	24402.030.016	M5X10	200	24402.050.010
M2X6	200	24402.020.006	M3X20	200	24402.030.020	M5X12	200	24402.050.012
M2X8	200	24402.020.008	M3X25	200	24402.030.025	M5X16	200	24402.050.016
M2X10	200	24402.020.010	M3X30	200	24402.030.030	M5X20	200	24402.050.020
M2X12	200	24402.020.012	M3X40	200	24402.030.040	M5X25	200	24402.050.025
M2X16	200	24402.020.016				M5X30	200	24402.050.030
M2X20	200	24402.020.020	M4X6	200	24402.040.006	M5X40	200	24402.050.040
			M4X8	200	24402.040.008	M5X50	200	24402.050.050
M2,5X5	200	24402.025.005	M4X10	200	24402.040.010			
M2,5X6	200	24402.025.006	M4X12	200	24402.040.012	M6X8	200	24402.060.008
M2,5X8	200	24402.025.008	M4X16	200	24402.040.016	M6X10	200	24402.060.010
M2,5X10	200	24402.025.010	M4X20	200	24402.040.020	M6X12	200	24402.060.012
			M4X25	200	24402.040.025	M6X16	200	24402.060.016
M3X5	200	24402.030.005	M4X30	200	24402.040.030	M6X20	200	24402.060.020
M3X6	200	24402.030.006	M4X40	200	24402.040.040	M6X25	200	24402.060.025
M3X8	200	24402.030.008	M4X50	200	24402.040.050	M6X30	200	24402.060.030
M3X10	200	24402.030.010				M6X40	200	24402.060.040
M3X12	200	24402.030.012	M5X8	200	24402.050.008			

51121 Wkręty z łbem walcowym płaskim z nacięciem prostym R02A

Gwint	Metryczny
Materiał	Stal nierdzewna A2



d x L	☒	Kod artykułu	d x L	☒	Kod artykułu	d x L	☒	Kod artykułu
M2X4	200	51121.020.004	M3X4	200	51121.030.004	M3X50	200	51121.030.050
M2X10	200	51121.020.010	M3X5	200	51121.030.005			
M2X20	200	51121.020.020	M3X6	200	51121.030.006	M4X6	200	51121.040.006
			M3X10	200	51121.030.010	M4X8	200	51121.040.008
M2,5X4	200	51121.025.004	M3X16	200	51121.030.016	M4X10	200	51121.040.010
M2,5X8	200	51121.025.008	M3X20	200	51121.030.020	M4X12	200	51121.040.012
M2,5X10	200	51121.025.010	M3X25	200	51121.030.025	M4X16	200	51121.040.016
M2,5X12	200	51121.025.012	M3X30	200	51121.030.030	M4X20	200	51121.040.020
			M3X40	200	51121.030.040			

51120 Wkręty z łbem walcowym płaskim z nacięciem prostym R02A

Gwint	Metryczny
Materiał	Stal nierdzewna A2



d x L	☒	Kod artykułu	d x L	☒	Kod artykułu	d x L	☒	Kod artykułu
M1X2*	1000	51120.010.002	M1X10	100	51120.010.010	M1,2X6	100	51120.012.006
M1X3	100	51120.010.003				M1,2X8	100	51120.012.008
M1X4	100	51120.010.004	M1,2X2*	1000	51120.012.002	M1,2X10	100	51120.012.010
M1X5	100	51120.010.005	M1,2X3	100	51120.012.003			
M1X6	100	51120.010.006	M1,2X4	100	51120.012.004	M1,4X3*	1000	51120.014.003
M1X8	100	51120.010.008	M1,2X5	100	51120.012.005	M1,4X4*	1000	51120.014.004

51120 Wkręty z łbem walcowym płaskim z nacięciem prostym								
d x L	☒	Kod artykułu	d x L	☒	Kod artykułu	d x L	☒	Kod artykułu
M1,4X5*	1000	51120.014.005	M3X6	500	51120.030.006	M5X30	200	51120.050.030
M1,4X6*	1000	51120.014.006	M3X8	500	51120.030.008	M5X35	200	51120.050.035
M1,4X8*	1000	51120.014.008	M3X10	500	51120.030.010	M5X40	200	51120.050.040
M1,4X10*	1000	51120.014.010	M3X12	500	51120.030.012	M5X45	200	51120.050.045
M1,4X12*	1000	51120.014.012	M3X14	500	51120.030.014	M5X50	200	51120.050.050
			M3X16	500	51120.030.016	M5X55*	200	51120.050.055
M1,6X2*	1000	51120.016.002	M3X18*	500	51120.030.018	M5X60	200	51120.050.060
M1,6X3	100	51120.016.003	M3X20	500	51120.030.020	M5X65*	200	51120.050.065
M1,6X4	100	51120.016.004	M3X22*	500	51120.030.022	M5X70	200	51120.050.070
M1,6X5	100	51120.016.005	M3X25	500	51120.030.025	M5X80	200	51120.050.080
M1,6X6	100	51120.016.006	M3X28*	500	51120.030.028	M5X90	200	51120.050.090
M1,6X8	100	51120.016.008	M3X30	500	51120.030.030	M5X100	200	51120.050.100
M1,6X10	100	51120.016.010	M3X35	500	51120.030.035			
M1,6X12	100	51120.016.012	M3X40	500	51120.030.040	M6X6*	500	51120.060.006
M1,6X14*	1000	51120.016.014	M3X45*	200	51120.030.045	M6X8	200	51120.060.008
M1,6X16*	1000	51120.016.016	M3X50	500	51120.030.050	M6X10	200	51120.060.010
M1,6X18*	1000	51120.016.018	M3X55*	200	51120.030.055	M6X12	200	51120.060.012
M1,6X20*	1000	51120.016.020	M3X60	500	51120.030.060	M6X14*	500	51120.060.014
						M6X16	200	51120.060.016
M1,7X3*	1000	51120.017.003	M3,5X5*	500	51120.035.005	M6X18*	500	51120.060.018
M1,7X5*	1000	51120.017.005	M3,5X6*	500	51120.035.006	M6X20	200	51120.060.020
M1,7X10*	1000	51120.017.010	M3,5X8*	500	51120.035.008	M6X22*	200	51120.060.022
			M3,5X10	500	51120.035.010	M6X25	200	51120.060.025
M2X3	500	51120.020.003	M3,5X12*	500	51120.035.012	M6X30	200	51120.060.030
M2X4	500	51120.020.004	M3,5X16*	500	51120.035.016	M6X35	100	51120.060.035
M2X5	500	51120.020.005	M3,5X20	500	51120.035.020	M6X40	100	51120.060.040
M2X6	500	51120.020.006	M3,5X25	500	51120.035.025	M6X45	100	51120.060.045
M2X8	500	51120.020.008	M3,5X30	500	51120.035.030	M6X50	100	51120.060.050
M2X10	500	51120.020.010	M3,5X35*	500	51120.035.035	M6X55*	200	51120.060.055
M2X12	500	51120.020.012	M3,5X40*	500	51120.035.040	M6X60	100	51120.060.060
M2X14*	1000	51120.020.014	M3,5X50*	200	51120.035.050	M6X65*	200	51120.060.065
M2X16	500	51120.020.016				M6X70	100	51120.060.070
M2X18*	1000	51120.020.018	M4X4*	500	51120.040.004	M6X75*	200	51120.060.075
M2X20	500	51120.020.020	M4X5*	500	51120.040.005	M6X80	100	51120.060.080
M2X22*	500	51120.020.022	M4X6	500	51120.040.006	M6X90	100	51120.060.090
M2X25	500	51120.020.025	M4X8	500	51120.040.008	M6X100	100	51120.060.100
M2X30*	500	51120.020.030	M4X10	500	51120.040.010			
M2X40*	500	51120.020.040	M4X12	500	51120.040.012	M8X10*	200	51120.080.010
			M4X14*	500	51120.040.014	M8X12	100	51120.080.012
M2,3X3*	1000	51120.023.003	M4X16	500	51120.040.016	M8X16	100	51120.080.016
M2,3X4*	1000	51120.023.004	M4X18	500	51120.040.018	M8X20	100	51120.080.020
M2,3X10*	1000	51120.023.010	M4X20	500	51120.040.020	M8X25	100	51120.080.025
M2,3X20*	1000	51120.023.020	M4X22	200	51120.040.022	M8X30	100	51120.080.030
			M4X25	200	51120.040.025	M8X35	100	51120.080.035
M2,5X3*	1000	51120.025.003	M4X30	200	51120.040.030	M8X40	100	51120.080.040
M2,5X4	500	51120.025.004	M4X35	200	51120.040.035	M8X45	100	51120.080.045
M2,5X5	500	51120.025.005	M4X40	200	51120.040.040	M8X50	100	51120.080.050
M2,5X6	500	51120.025.006	M4X45	200	51120.040.045	M8X60	100	51120.080.060
M2,5X8	500	51120.025.008	M4X50	200	51120.040.050	M8X70	50	51120.080.070
M2,5X10	500	51120.025.010	M4X55*	500	51120.040.055	M8X80	50	51120.080.080
M2,5X12	500	51120.025.012	M4X60	200	51120.040.060	M8X90	50	51120.080.090
M2,5X14*	1000	51120.025.014	M4X70	200	51120.040.070	M8X100	50	51120.080.100
M2,5X16	500	51120.025.016	M4X75*	200	51120.040.075			
M2,5X18*	1000	51120.025.018	M4X80	200	51120.040.080	M10X16*	100	51120.100.016
M2,5X20	500	51120.025.020	M4X90	200	51120.040.090	M10X20	50	51120.100.020
M2,5X22*	500	51120.025.022	M4X100	200	51120.040.100	M10X25	50	51120.100.025
M2,5X25	500	51120.025.025				M10X30	50	51120.100.030
M2,5X30*	500	51120.025.030	M5X6	200	51120.050.006	M10X35*	100	51120.100.035
M2,5X35*	500	51120.025.035	M5X8	200	51120.050.008	M10X40	50	51120.100.040
			M5X10	200	51120.050.010	M10X45	50	51120.100.045
M2,6X5*	1000	51120.026.005	M5X12	200	51120.050.012	M10X50	50	51120.100.050
M2,6X6*	1000	51120.026.006	M5X14*	500	51120.050.014	M10X60	50	51120.100.060
M2,6X8*	1000	51120.026.008	M5X16	200	51120.050.016	M10X70	50	51120.100.070
M2,6X10*	1000	51120.026.010	M5X18*	500	51120.050.018	M10X80	50	51120.100.080
			M5X20	200	51120.050.020	M10X90	50	51120.100.090
M3X3*	500	51120.030.003	M5X22*	500	51120.050.022	M10X100	50	51120.100.100
M3X4	500	51120.030.004	M5X25	200	51120.050.025			
M3X5	500	51120.030.005	M5X28*	500	51120.050.028			

6

55120 Wkręty z łbem walcowym płaskim z nacięciem prostym R42A

Gwint Metryczny
 Materiał Stal nierdzewna A4



d x L	☒	Kod artykułu	d x L	☒	Kod artykułu	d x L	☒	Kod artykułu
M1X3*	1000	55120.010.003	M1X5*	1000	55120.010.005	M1,6X4*	1000	55120.016.004
M1X4*	1000	55120.010.004				M1,6X5*	1000	55120.016.005



55120 Wkręty z łbem walcowym płaskim z nacięciem prostym

d x L	☒	Kod artykułu	d x L	☒	Kod artykułu	d x L	☒	Kod artykułu
M1,6X6*	1000	55120.016.006	M3,5X5*	500	55120.035.005	M5X90	200	55120.050.090
M1,6X8*	1000	55120.016.008	M3,5X6*	500	55120.035.006	M5X100	200	55120.050.100
M1,6X10*	1000	55120.016.010	M3,5X8*	500	55120.035.008	M6X8	200	55120.060.008
M2X3*	1000	55120.020.003	M3,5X10*	500	55120.035.010	M6X10	200	55120.060.010
M2X4*	1000	55120.020.004	M3,5X12*	500	55120.035.012	M6X12	200	55120.060.012
M2X5	500	55120.020.005	M3,5X20*	500	55120.035.020	M6X14*	500	55120.060.014
M2X6	500	55120.020.006	M3,5X35*	500	55120.035.035	M6X16	200	55120.060.016
M2X8	500	55120.020.008	M3,5X40*	500	55120.035.040	M6X18*	500	55120.060.018
M2X10	500	55120.020.010	M4X4*	500	55120.040.004	M6X20	200	55120.060.020
M2X12	500	55120.020.012	M4X5*	500	55120.040.005	M6X22*	200	55120.060.022
M2X14*	1000	55120.020.014	M4X6	500	55120.040.006	M6X25	200	55120.060.025
M2X16	500	55120.020.016	M4X8	500	55120.040.008	M6X30	200	55120.060.030
M2X20	500	55120.020.020	M4X10	500	55120.040.010	M6X35	100	55120.060.035
M2X25	500	55120.020.025	M4X12	500	55120.040.012	M6X40	100	55120.060.040
M2,3X6*	1000	55120.023.006	M4X14*	500	55120.040.014	M6X45	100	55120.060.045
M2,3X10*	1000	55120.023.010	M4X16	500	55120.040.016	M6X50	100	55120.060.050
M2,5X3*	1000	55120.025.003	M4X18*	500	55120.040.018	M6X55*	200	55120.060.055
M2,5X4*	1000	55120.025.004	M4X20	500	55120.040.020	M6X60	100	55120.060.060
M2,5X5	500	55120.025.005	M4X22*	500	55120.040.022	M6X70	100	55120.060.070
M2,5X6	500	55120.025.006	M4X25	200	55120.040.025	M6X80	100	55120.060.080
M2,5X8	500	55120.025.008	M4X28*	500	55120.040.028	M6X90	100	55120.060.090
M2,5X10	500	55120.025.010	M4X30	200	55120.040.030	M6X100	100	55120.060.100
M2,5X12	500	55120.025.012	M4X35	200	55120.040.035	M8X10*	200	55120.080.010
M2,5X14*	1000	55120.025.014	M4X40	200	55120.040.040	M8X12*	200	55120.080.012
M2,5X16	500	55120.025.016	M4X45	200	55120.040.045	M8X16	100	55120.080.016
M2,5X18*	1000	55120.025.018	M4X50	200	55120.040.050	M8X20	100	55120.080.020
M2,5X20	500	55120.025.020	M4X60	200	55120.040.060	M8X25	100	55120.080.025
M2,5X25	500	55120.025.025	M4X70	200	55120.040.070	M8X30	100	55120.080.030
M2,5X30*	500	55120.025.030	M4X80	200	55120.040.080	M8X35	100	55120.080.035
M3X3*	500	55120.030.003	M4X90	200	55120.040.090	M8X40	100	55120.080.040
M3X4	500	55120.030.004	M4X100	200	55120.040.100	M8X45	100	55120.080.045
M3X5	500	55120.030.005	M5X6*	500	55120.050.006	M8X50	100	55120.080.050
M3X6	500	55120.030.006	M5X8	200	55120.050.008	M8X60	100	55120.080.060
M3X8	500	55120.030.008	M5X10	200	55120.050.010	M8X70	50	55120.080.070
M3X10	500	55120.030.010	M5X12	200	55120.050.012	M8X80	50	55120.080.080
M3X12	500	55120.030.012	M5X14*	500	55120.050.014	M8X90	50	55120.080.090
M3X14	500	55120.030.014	M5X16	200	55120.050.016	M8X100	50	55120.080.100
M3X16	500	55120.030.016	M5X18	200	55120.050.018	M10X16*	100	55120.100.016
M3X18	500	55120.030.018	M5X20	200	55120.050.020	M10X20	50	55120.100.020
M3X20	500	55120.030.020	M5X22*	500	55120.050.022	M10X25	50	55120.100.025
M3X22*	500	55120.030.022	M5X25	200	55120.050.025	M10X30	50	55120.100.030
M3X25	500	55120.030.025	M5X30	200	55120.050.030	M10X35	50	55120.100.035
M3X30	500	55120.030.030	M5X35	200	55120.050.035	M10X40	50	55120.100.040
M3X35	500	55120.030.035	M5X40	200	55120.050.040	M10X45	50	55120.100.045
M3X40	500	55120.030.040	M5X45	200	55120.050.045	M10X50	50	55120.100.050
M3X45*	200	55120.030.045	M5X50	200	55120.050.050	M10X60	50	55120.100.060
M3X50	500	55120.030.050	M5X55*	200	55120.050.055	M10X70	50	55120.100.070
M3X60	500	55120.030.060	M5X60	200	55120.050.060	M10X80	50	55120.100.080
			M5X70	200	55120.050.070	M10X90	50	55120.100.090
			M5X80	200	55120.050.080	M10X100	50	55120.100.100

6
48020 Wkręty z łbem walcowym płaskim z nacięciem prostym
M05A
Gwint Metryczny
Materiał Mosiądz Cu2/Cu3

d x L	☒	Kod artykułu	d x L	☒	Kod artykułu	d x L	☒	Kod artykułu
M2X4	200	48020.020.004	M3X4	200	48020.030.004	M4X8	200	48020.040.008
M2X5	200	48020.020.005	M3X5	200	48020.030.005	M4X10	200	48020.040.010
M2X6	200	48020.020.006	M3X6	200	48020.030.006	M4X12	200	48020.040.012
M2X8	200	48020.020.008	M3X8	200	48020.030.008	M4X16	200	48020.040.016
M2X10	200	48020.020.010	M3X10	200	48020.030.010	M4X18	200	48020.040.018
M2X12	200	48020.020.012	M3X12	200	48020.030.012	M4X20	200	48020.040.020
M2X16	200	48020.020.016	M3X16	200	48020.030.016	M4X25	200	48020.040.025
M2X20	200	48020.020.020	M3X20	200	48020.030.020	M4X30	200	48020.040.030
M2,5X5	200	48020.025.005	M3X25	200	48020.030.025	M4X35	200	48020.040.035
M2,5X6	200	48020.025.006	M3X30	200	48020.030.030	M4X40	200	48020.040.040
M2,5X8	200	48020.025.008	M3X35	200	48020.030.035	M4X50	200	48020.040.050
M2,5X10	200	48020.025.010	M3X40	200	48020.030.040	M4X60	200	48020.040.060
M2,5X12	200	48020.025.012	M3X50	200	48020.030.050	M5X6	200	48020.050.006
M2,5X16	200	48020.025.016	M4X5	200	48020.040.005	M5X8	200	48020.050.008
M2,5X20	200	48020.025.020	M4X6	200	48020.040.006	M5X10	200	48020.050.010
M2,5X25	200	48020.025.025				M5X12	200	48020.050.012

48020 Wkręty z łbem walcowym płaskim z nacięciem prostym								
d x L	☒	Kod artykułu	d x L	☒	Kod artykułu	d x L	☒	Kod artykułu
M5X16	200	48020.050.016	M6X16	200	48020.060.016	M8X25	100	48020.080.025
M5X20	200	48020.050.020	M6X20	200	48020.060.020	M8X30	100	48020.080.030
M5X25	200	48020.050.025	M6X25	200	48020.060.025	M8X40	100	48020.080.040
M5X30	200	48020.050.030	M6X30	200	48020.060.030	M8X50	100	48020.080.050
M5X35	200	48020.050.035	M6X35	200	48020.060.035	M8X60	100	48020.080.060
M5X40	200	48020.050.040	M6X40	200	48020.060.040			
M5X45	200	48020.050.045	M6X45	200	48020.060.045	M10X20	100	48020.100.020
M5X50	200	48020.050.050	M6X50	200	48020.060.050	M10X25	100	48020.100.025
M5X60	200	48020.050.060	M6X60	100	48020.060.060	M10X30	100	48020.100.030
			M6X70	100	48020.060.070	M10X40	100	48020.100.040
M6X8	200	48020.060.008				M10X50	100	48020.100.050
M6X10	200	48020.060.010	M8X16	100	48020.080.016			
M6X12	200	48020.060.012	M8X20	100	48020.080.020			

48520 Wkręty z łbem walcowym płaskim z nacięciem prostym			M05A
Gwint	Metryczny		
Materiał	Mosiądz Cu2/Cu3		
Obróbka powierzchni	Niklowane		
			

d x L	☒	Kod artykułu	d x L	☒	Kod artykułu	d x L	☒	Kod artykułu
M2,5X5	200	48520.025.005	M4X5	200	48520.040.005	M5X30	200	48520.050.030
M2,5X6	200	48520.025.006	M4X6	200	48520.040.006	M5X35	200	48520.050.035
M2,5X8	200	48520.025.008	M4X8	200	48520.040.008	M5X40	200	48520.050.040
M2,5X10	200	48520.025.010	M4X10	200	48520.040.010	M5X50	200	48520.050.050
M2,5X16	200	48520.025.016	M4X12	200	48520.040.012	M5X60	200	48520.050.060
M2,5X20	200	48520.025.020	M4X16	200	48520.040.016			
M2,5X25	200	48520.025.025	M4X20	200	48520.040.020	M6X8	200	48520.060.008
			M4X25	200	48520.040.025	M6X10	200	48520.060.010
M3X4	200	48520.030.004	M4X30	200	48520.040.030	M6X12	200	48520.060.012
M3X5	200	48520.030.005	M4X35	200	48520.040.035	M6X16	200	48520.060.016
M3X6	200	48520.030.006	M4X40	200	48520.040.040	M6X20	200	48520.060.020
M3X8	200	48520.030.008	M4X50	200	48520.040.050	M6X25	200	48520.060.025
M3X10	200	48520.030.010	M4X60	200	48520.040.060	M6X30	200	48520.060.030
M3X12	200	48520.030.012				M6X35	200	48520.060.035
M3X16	200	48520.030.016	M5X8	200	48520.050.008	M6X50	200	48520.060.050
M3X20	200	48520.030.020	M5X10	200	48520.050.010	M6X60	100	48520.060.060
M3X25	200	48520.030.025	M5X12	200	48520.050.012			
M3X30	200	48520.030.030	M5X16	200	48520.050.016	M8X20	100	48520.080.020
M3X35	200	48520.030.035	M5X20	200	48520.050.020	M8X35	100	48520.080.035
M3X50	200	48520.030.050	M5X25	200	48520.050.025	M8X60	100	48520.080.060

56410 Wkręty z łbem walcowym płaskim z nacięciem prostym				W02A	
Gwint	Metryczny		DIN	≈84	
Materiał	Plastik Poliamid (nylon)		ISO	≈1207	
Klasa	PA 6.6		NEN	≈1602	
Kolor	Biały		ASME	≈B18.6.7M	
			NF	≈E25-127	
			BS	≈4183	

d x L	☒	Kod artykułu	d x L	☒	Kod artykułu	d x L	☒	Kod artykułu
M3X4	200	56410.030.004				M6X40	50	56410.060.040
M3X6	200	56410.030.006	M5X6	100	56410.050.006	M6X50	50	56410.060.050
M3X8	200	56410.030.008	M5X8	100	56410.050.008	M6X60	50	56410.060.060
M3X10	200	56410.030.010	M5X10	100	56410.050.010	M6X80	50	56410.060.080
M3X12	200	56410.030.012	M5X12	100	56410.050.012			
M3X16	200	56410.030.016	M5X16	100	56410.050.016	M8X10	25	56410.080.010
M3X20	200	56410.030.020	M5X20	100	56410.050.020	M8X16	25	56410.080.016
M3X25	200	56410.030.025	M5X25	100	56410.050.025	M8X20	25	56410.080.020
M3X30	200	56410.030.030	M5X30	100	56410.050.030	M8X25	25	56410.080.025
			M5X40	100	56410.050.040	M8X30	25	56410.080.030
M4X6	200	56410.040.006	M5X50	100	56410.050.050	M8X40	25	56410.080.040
M4X8	200	56410.040.008				M8X50	25	56410.080.050
M4X10	200	56410.040.010	M6X10	50	56410.060.010	M8X60	25	56410.080.060
M4X12	200	56410.040.012	M6X12	50	56410.060.012	M8X80	25	56410.080.080
M4X16	200	56410.040.016	M6X16	50	56410.060.016			
M4X20	200	56410.040.020	M6X20	50	56410.060.020	M10X20	25	56410.100.020
M4X25	200	56410.040.025	M6X25	50	56410.060.025	M10X30	25	56410.100.030
M4X30	200	56410.040.030	M6X30	50	56410.060.030	M10X40	25	56410.100.040
M4X40	200	56410.040.040						

Wkręty z łbem walcowym płaskim z nacięciem prostym

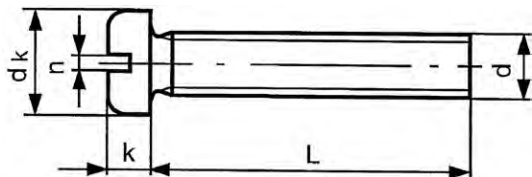

DIN	85
ISO	1580
NEN	1603
ASME	B18.6.7M
NF	E25-128
BS	4183

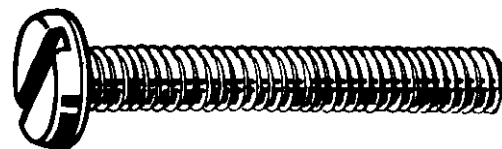

Informacje techniczne

d	dk	k	n	P	Peten gwint L ≤
M1.6	3.2	1	0.5	0.35	16
M2 (#DIN)	4	1.3	0.5	0.4	16
M2.5 (#DIN)	5	1.5	0.6	0.45	16
M3	6	1.8	0.8	0.5	30
M3.5	7	2.1	1	0.6	38
M4	8	2.4	1.2	0.7	40
M5	10	3	1.2	0.8	40
M6	12	3.6	1.6	1	40
M8	16	4.8	2	1.25	40
M10	20	6	2.5	1.5	40

Grupy katalogowe

Gwint	Gniazdo	Materiał	Klasa	Obróbka powierzchni	Kolor	Kod	Strona
M	Szczelina	St	4.8	Ocynk.		24640	6-16
M	Szczelina	St.St. A2				51140	6-16
M	Szczelina	St.St. A4				55140	6-17
M	Szczelina	Mosiądz Cu2/Cu3				48040	6-18
M	Szczelina	Mosiądz Cu2/Cu3		Nikl.		48530	6-18
M	Szczelina	Plastik PA	PA 6.6		Biały	56420	6-18

24640 Wkręty z łbem walcowym płaskim z nacięciem prostym

H01A

Gwint	Metryczny
Materiał	Stal
Klasa	4.8
Obróbka powierzchni	Ocynkowane



d x L	☒	Kod artykułu	d x L	☒	Kod artykułu	d x L	☒	Kod artykułu
M3X6	500	24640.030.006	M4X20	500	24640.040.020	M5X60	200	24640.050.060
M3X8	500	24640.030.008	M4X25	500	24640.040.025	M6X8	200	24640.060.008
M3X10	500	24640.030.010	M4X30	500	24640.040.030	M6X10	200	24640.060.010
M3X12	500	24640.030.012	M4X40	500	24640.040.040	M6X12	200	24640.060.012
M3X16	500	24640.030.016	M5X6	500	24640.050.006	M6X16	200	24640.060.016
M3X20	500	24640.030.020	M5X8	500	24640.050.008	M6X20	200	24640.060.020
M3X25	500	24640.030.025	M5X10	500	24640.050.010	M6X25	200	24640.060.025
M3X30	500	24640.030.030	M5X12	500	24640.050.012	M6X30	200	24640.060.030
M3X40	500	24640.030.040	M5X16	500	24640.050.016	M6X40	200	24640.060.040
M4X5	500	24640.040.005	M5X20	500	24640.050.020	M6X50	200	24640.060.050
M4X6	500	24640.040.006	M5X25	500	24640.050.025	M8X16	200	24640.080.016
M4X8	500	24640.040.008	M5X30	500	24640.050.030	M8X20	200	24640.080.020
M4X10	500	24640.040.010	M5X40	500	24640.050.040	M8X25	200	24640.080.025
M4X12	500	24640.040.012	M5X50	200	24640.050.050			
M4X16	500	24640.040.016						

51140 Wkręty z łbem walcowym płaskim z nacięciem prostym

R02A

Gwint	Metryczny
Materiał	Stal nierdzewna A2



d x L	☒	Kod artykułu	d x L	☒	Kod artykułu	d x L	☒	Kod artykułu
M1.6X5*	1000	51140.016.005	M2X4*	1000	51140.020.004	M2X12*	1000	51140.020.012
M1.6X6*	1000	51140.016.006	M2X5*	1000	51140.020.005	M2X14*	1000	51140.020.014
M1.6X8*	1000	51140.016.008	M2X6	500	51140.020.006	M2X16*	1000	51140.020.016
			M2X8*	1000	51140.020.008	M2X18*	1000	51140.020.018
M2X3*	1000	51140.020.003	M2X10*	1000	51140.020.010	M2X20*	1000	51140.020.020

51140 Wkręty z łbem walcowym płaskim z nacięciem prostym ←								
d x L	✉	Kod artykułu	d x L	✉	Kod artykułu	d x L	✉	Kod artykułu
M2,5X3*	1000	51140.025.003	M4X5*	500	51140.040.005	M5X100	200	51140.050.100
M2,5X4*	1000	51140.025.004	M4X6	500	51140.040.006	M6X8*	500	51140.060.008
M2,5X5	500	51140.025.005	M4X8	500	51140.040.008	M6X10	200	51140.060.010
M2,5X6*	1000	51140.025.006	M4X10	500	51140.040.010	M6X12	200	51140.060.012
M2,5X8	500	51140.025.008	M4X12	500	51140.040.012	M6X16	200	51140.060.016
M2,5X10*	1000	51140.025.010	M4X14*	500	51140.040.014	M6X20	200	51140.060.020
M2,5X12*	1000	51140.025.012	M4X16	500	51140.040.016	M6X25	200	51140.060.025
M2,5X14*	1000	51140.025.014	M4X20	500	51140.040.020	M6X30	200	51140.060.030
M2,5X16*	1000	51140.025.016	M4X22*	500	51140.040.022	M6X35	200	51140.060.035
M2,5X20*	1000	51140.025.020	M4X25	200	51140.040.025	M6X40	100	51140.060.040
M2,5X25*	1000	51140.025.025	M4X30	200	51140.040.030	M6X45	100	51140.060.045
M3X4*	500	51140.030.004	M4X35	200	51140.040.035	M6X50	100	51140.060.050
M3X5	500	51140.030.005	M4X40	200	51140.040.040	M6X60	100	51140.060.060
M3X6	500	51140.030.006	M4X45*	500	51140.040.045	M6X70	100	51140.060.070
M3X8	500	51140.030.008	M4X50	200	51140.040.050	M6X80	100	51140.060.080
M3X10	500	51140.030.010	M4X60	200	51140.040.060	M6X90	100	51140.060.090
M3X12	500	51140.030.012	M5X6*	500	51140.050.006	M8X10	100	51140.080.010
M3X14*	500	51140.030.014	M5X8	200	51140.050.008	M8X12	100	51140.080.012
M3X16	500	51140.030.016	M5X10	200	51140.050.010	M8X16*	200	51140.080.016
M3X20	500	51140.030.020	M5X12	200	51140.050.012	M8X20	100	51140.080.020
M3X25	500	51140.030.025	M5X16	200	51140.050.016	M8X25	100	51140.080.025
M3X30	500	51140.030.030	M5X18*	500	51140.050.018	M8X30*	200	51140.080.030
M3X35*	500	51140.030.035	M5X20	200	51140.050.020	M8X35	100	51140.080.035
M3X40	500	51140.030.040	M5X25	200	51140.050.025	M8X40	100	51140.080.040
M3X45*	500	51140.030.045	M5X30	200	51140.050.030	M8X50	100	51140.080.050
M3X50*	500	51140.030.050	M5X35	200	51140.050.035	M8X55*	100	51140.080.055
M3,5X6*	500	51140.035.006	M5X40	200	51140.050.040	M8X60	50	51140.080.060
M3,5X8*	500	51140.035.008	M5X45	200	51140.050.045	M8X90	50	51140.080.090
M3,5X16*	500	51140.035.016	M5X50	200	51140.050.050	M8X100	50	51140.080.100
			M5X60	200	51140.050.060			
			M5X70	200	51140.050.070			
			M5X80	200	51140.050.080			

51140 Wkręty z łbem walcowym płaskim z nacięciem prostym				R42A			
Gwint	Metryczny						
Material	Stal nierdzewna A4						

d x L	✉	Kod artykułu	d x L	✉	Kod artykułu	d x L	✉	Kod artykułu
M2X3*	1000	55140.020.003	M4X8	500	55140.040.008	M5X80*	200	55140.050.080
M2X4*	1000	55140.020.004	M4X10	500	55140.040.010	M5X90*	200	55140.050.090
M2X5*	1000	55140.020.005	M4X12*	500	55140.040.012	M6X8*	500	55140.060.008
M2X6*	1000	55140.020.006	M4X16	500	55140.040.016	M6X10	200	55140.060.010
M2X8*	1000	55140.020.008	M4X20	500	55140.040.020	M6X12	200	55140.060.012
M2X10*	1000	55140.020.010	M4X25	200	55140.040.025	M6X16	200	55140.060.016
M2X20*	1000	55140.020.020	M4X30	200	55140.040.030	M6X20	200	55140.060.020
M2,5X6*	1000	55140.025.006	M4X35	200	55140.040.035	M6X25	200	55140.060.025
M2,5X8*	1000	55140.025.008	M4X40	200	55140.040.040	M6X30	200	55140.060.030
M2,5X10*	1000	55140.025.010	M4X45*	500	55140.040.045	M6X35	200	55140.060.035
M2,5X12*	1000	55140.025.012	M4X50*	500	55140.040.050	M6X40	100	55140.060.040
M3X4*	500	55140.030.004	M5X6*	500	55140.050.006	M6X45*	200	55140.060.045
M3X5	500	55140.030.005	M5X8	200	55140.050.008	M6X50	100	55140.060.050
M3X6	500	55140.030.006	M5X10	200	55140.050.010	M6X60	100	55140.060.060
M3X8	500	55140.030.008	M5X12	200	55140.050.012	M6X70*	200	55140.060.070
M3X10	500	55140.030.010	M5X16	200	55140.050.016	M8X10*	200	55140.080.010
M3X12	500	55140.030.012	M5X20	200	55140.050.020	M8X12	100	55140.080.012
M3X16	500	55140.030.016	M5X25	200	55140.050.025	M8X16	100	55140.080.016
M3X20	500	55140.030.020	M5X30	200	55140.050.030	M8X20	100	55140.080.020
M3X25	500	55140.030.025	M5X35*	500	55140.050.035	M8X25	100	55140.080.025
M3X30	500	55140.030.030	M5X40	200	55140.050.040	M8X30*	200	55140.080.030
M3X40*	500	55140.030.040	M5X45*	200	55140.050.045	M8X35	100	55140.080.035
M3X50*	500	55140.030.050	M5X50	200	55140.050.050	M8X40*	200	55140.080.040
M4X6	500	55140.040.006	M5X60	200	55140.050.060	M8X50	100	55140.080.050
			M5X70*	200	55140.050.070			

48040		Wkręty z łbem walcowym płaskim z nacięciem prostym				M05A	
Gwint	Metryczny						
Materiał	Mosiądz Cu2/Cu3						

d x L	☒	Kod artykułu	d x L	☒	Kod artykułu	d x L	☒	Kod artykułu
M3X5	200	48040.030.005	M4X8	200	48040.040.008	M5X12	200	48040.050.012
M3X6	200	48040.030.006	M4X10	200	48040.040.010	M5X16	200	48040.050.016
M3X8	200	48040.030.008	M4X12	200	48040.040.012	M5X20	200	48040.050.020
M3X10	200	48040.030.010	M4X16	200	48040.040.016	M5X25	200	48040.050.025
M3X12	200	48040.030.012	M4X20	200	48040.040.020	M5X40	200	48040.050.040
M3X16	200	48040.030.016	M4X25	200	48040.040.025	M6X10	200	48040.060.010
M3X20	200	48040.030.020	M4X40	200	48040.040.040	M6X12	200	48040.060.012
M3X25	200	48040.030.025	M5X6	200	48040.050.006	M6X16	200	48040.060.016
M4X5	200	48040.040.005	M5X8	200	48040.050.008	M6X20	200	48040.060.020
M4X6	200	48040.040.006	M5X10	200	48040.050.010	M6X25	200	48040.060.025

48530		Wkręty z łbem walcowym płaskim z nacięciem prostym				M05A	
Gwint	Metryczny						
Materiał	Mosiądz Cu2/Cu3						
Obróbka powierzchni	Niklowane						

d x L	☒	Kod artykułu	d x L	☒	Kod artykułu	d x L	☒	Kod artykułu
M2.5X10	200	48530.025.010	M3X25	200	48530.030.025	M5X8	200	48530.050.008
M2.5X20	200	48530.025.020	M3X30	200	48530.030.030	M5X10	200	48530.050.010
M2.5X25	200	48530.025.025	M4X6	200	48530.040.006	M5X12	200	48530.050.012
M3X5	200	48530.030.005	M4X8	200	48530.040.008	M5X25	200	48530.050.025
M3X6	200	48530.030.006	M4X10	200	48530.040.010	M6X10	200	48530.060.010
M3X8	200	48530.030.008	M4X12	200	48530.040.012	M6X12	200	48530.060.012
M3X10	200	48530.030.010	M4X16	200	48530.040.016	M6X16	200	48530.060.016
M3X12	200	48530.030.012	M4X20	200	48530.040.020	M6X20	200	48530.060.020
M3X16	200	48530.030.016	M4X25	200	48530.040.025			

56420		Wkręty z łbem walcowym płaskim z nacięciem prostym				W02A	
Gwint	Metryczny	DIN	≈85				
Materiał	Plastik Poliamid (nylon)	ISO	≈1580				
Klasa	PA 6.6	NEN	≈1603				
Kolor	Biały	ASME	≈B18.6.7M				
		NF	≈E25-128				
		BS	≈4183				

d x L	☒	Kod artykułu	d x L	☒	Kod artykułu	d x L	☒	Kod artykułu
M3X4	200	56420.030.004	M4X10	200	56420.040.010	M6X10	50	56420.060.010
M3X6	200	56420.030.006	M4X12	200	56420.040.012	M6X12	50	56420.060.012
M3X8	200	56420.030.008	M4X16	200	56420.040.016	M6X16	50	56420.060.016
M3X10	200	56420.030.010	M4X20	200	56420.040.020	M6X20	50	56420.060.020
M3X12	200	56420.030.012				M6X25	50	56420.060.025
M3X16	200	56420.030.016	M5X10	100	56420.050.010	M6X30	50	56420.060.030
M3X20	200	56420.030.020	M5X12	100	56420.050.012			
M3X25	200	56420.030.025	M5X16	100	56420.050.016	M8X10	25	56420.080.010
M4X6	200	56420.040.006	M5X20	100	56420.050.020	M8X16	25	56420.080.016
M4X8	200	56420.040.008				M8X20	25	56420.080.020

6

Wkręty z łbem walcowym pomniejszonym z nacięciem prostym

DIN 920

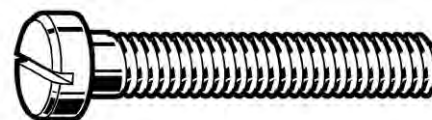
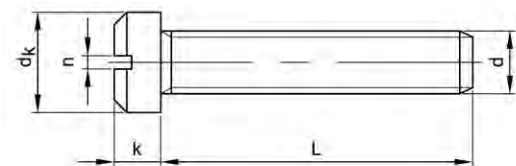

Informacje techniczne

d	d _k (maks.)	k (maks.)	n	P
M2	2.8	1.2	0.3	0.4
M3	4	1.8	0.5	0.5
M4	5.5	2.4	0.6	0.7
M5	6.5	2.7	0.8	0.8
M6	8	3.1	1	1

51207 Wkręty z łbem walcowym pomniejszonym z nacięciem prostym

R09A

Gwint Metryczny
Material Stal nierdzewna A2



d x L	☒	Kod artykułu	d x L	☒	Kod artykułu	d x L	☒	Kod artykułu
M2X4*	500	51207.020.004	M3X12*	500	51207.030.012	M5X5*	200	51207.050.005
M2X6*	500	51207.020.006	M3X16*	500	51207.030.016	M5X6*	200	51207.050.006
M2X8*	500	51207.020.008				M5X8*	200	51207.050.008
M2X10*	500	51207.020.010	M4X4*	500	51207.040.004	M5X10*	200	51207.050.010
			M4X6*	500	51207.040.006	M5X12*	200	51207.050.012
M3X4*	500	51207.030.004	M4X8*	500	51207.040.008	M5X16*	200	51207.050.016
M3X5*	500	51207.030.005	M4X10*	500	51207.040.010	M5X20*	200	51207.050.020
M3X6*	500	51207.030.006	M4X12*	500	51207.040.012			
M3X8*	500	51207.030.008	M4X16*	500	51207.040.016	M6X8*	200	51207.060.008
M3X10*	500	51207.030.010				M6X10*	200	51207.060.010

6

Wkręty z łbem płaskim powiększonym z nacięciem prostym

DIN 921

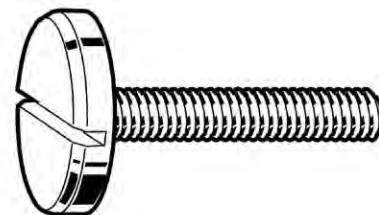
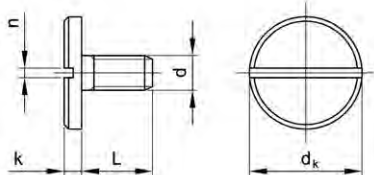

Informacje techniczne

d	d _k (maks.)	k (maks.)	n	P
M2	6	1.2	0.5	0.4
M3	8	1.8	0.8	0.5
M4	12	2.4	1	0.7
M5	16	2.7	1.2	0.8
M6	20	3.1	1.6	1

51208 Wkręty z łbem płaskim powiększonym z nacięciem prostym

R09A

Gwint: Metryczny
 Materiał: Stal nierdzewna A2



6

d x L	☒	Kod artykułu	d x L	☒	Kod artykułu	d x L	☒	Kod artykułu
M2X2*	100	51208.020.002	M4X5*	100	51208.040.005	M5X12*	100	51208.050.012
M2X3*	100	51208.020.003	M4X6*	100	51208.040.006	M5X16*	100	51208.050.016
M2X4*	100	51208.020.004	M4X8*	100	51208.040.008	M5X20*	100	51208.050.020
M2X5*	100	51208.020.005	M4X10*	100	51208.040.010	M6X8*	50	51208.060.008
M3X4*	100	51208.030.004	M4X12*	100	51208.040.012	M6X10*	50	51208.060.010
M3X5*	100	51208.030.005	M4X16*	100	51208.040.016	M6X12*	50	51208.060.012
M3X6*	100	51208.030.006	M5X6*	100	51208.050.006	M6X16*	50	51208.060.016
M3X8*	100	51208.030.008	M5X8*	100	51208.050.008	M6X20*	50	51208.060.020
M3X10*	100	51208.030.010	M5X10*	100	51208.050.010	M6X25*	50	51208.060.025
M3X12*	100	51208.030.012						

Wkręty z łbem stożkowym płaskim z nacięciem prostym

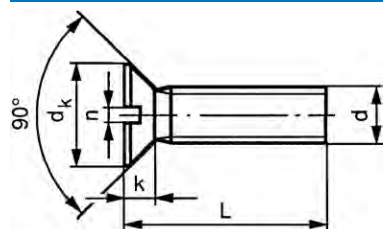

DIN 963
 ISO 2009
 NEN 2370
 ASME B18.6.7M
 NF E25-123
 BS 4183

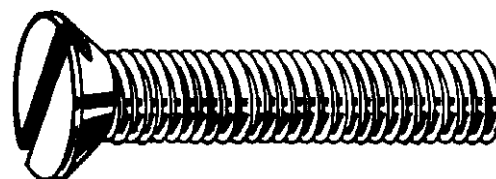

Informacje techniczne

d	d _k	k (maks.)	n	P	Pelen gwint L ≤
M1	1.9	0.6	0.25	0.25	5
M1.2	2.4	0.72	0.3	0.25	5
M1.4	2.6	0.84	0.3	0.3	16
M1.6	3	0.96	0.4	0.35	16
M2	3.8	1.2	0.5	0.4	18
M2.5	4.7	1.5	0.6	0.45	20
M3	5.6	1.65	0.8	0.5	22
M3.5	6.5	1.93	0.8	0.6	25
M4	7.5	2.2	1	0.7	25
M5	9.2	2.5	1.2	0.8	30
M6	11	3	1.6	1	35
M8	14.5	4	2	1.25	40
M10	18	5	2.5	1.5	50
M12	22	6	3	1.75	60
M14	25	7	3	2	60
M16	29	8	4	2	70
M18	33	9	4	2.5	80
M20	36	10	5	2.5	80

Grupy katalogowe

Gwint	Gniazdo	Materiał	Klasa	Obróbka powierzchni	Kolor	Kod	Strona
M	Szczelina	St	4.8	Ocynk.		24540	6-21
M	Szczelina	St	4.8	Ocynk. żłt. pas.		24560	6-22
M	Szczelina	St	4.8	Ocynk. czrn. pas.		24565	6-22
M	Szczelina	St	8.8	Ocynk.		24412	6-23
M	Szczelina	St.St. A2				51111	6-23
M	Szczelina	St.St. A2			Duże Opakowanie	51110	6-23
M	Szczelina	St.St. A4				55110	6-25
M	Szczelina	Mosiądz Cu2/Cu3				48170	6-25
M	Szczelina	Mosiądz Cu2/Cu3		Nikl.		48550	6-26
M	Szczelina	Plastik PA	PA 6.6		Biały	56440	6-26

24540 Wkręty z łbem stożkowym płaskim z nacięciem prostym

H01A

Gwint Metryczny
 Materiał Stal
 Klasa 4.8
 Obróbka powierzchni Ocynkowane

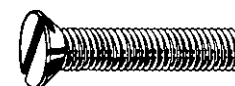

d x L	☒	Kod artykułu	d x L	☒	Kod artykułu	d x L	☒	Kod artykułu
M2X4	200	24540.020.004	M2,5X16	200	24540.025.016	M3X50	200	24540.030.050
M2X5	200	24540.020.005	M2,5X20	200	24540.025.020	M3X60	200	24540.030.060
M2X6	200	24540.020.006	M2,5X25	200	24540.025.025	M3X70	200	24540.030.070
M2X8	200	24540.020.008	M2,5X30	200	24540.025.030	M3X100	200	24540.030.100
M2X10	200	24540.020.010						
M2X12	200	24540.020.012	M3X4	200	24540.030.004	M3,5X6	200	24540.035.006
M2X16	200	24540.020.016	M3X5	200	24540.030.005	M3,5X8	200	24540.035.008
M2X20	200	24540.020.020	M3X6	200	24540.030.006	M3,5X10	200	24540.035.010
M2X25	200	24540.020.025	M3X8	200	24540.030.008	M3,5X12	200	24540.035.012
M2X30	200	24540.020.030	M3X10	200	24540.030.010	M3,5X16	200	24540.035.016
			M3X12	200	24540.030.012	M3,5X20	200	24540.035.020
M2,5X4	200	24540.025.004	M3X16	200	24540.030.016	M3,5X25	200	24540.035.025
M2,5X5	200	24540.025.005	M3X20	200	24540.030.020	M3,5X30	200	24540.035.030
M2,5X6	200	24540.025.006	M3X25	200	24540.030.025	M3,5X40	200	24540.035.040
M2,5X8	200	24540.025.008	M3X30	200	24540.030.030			
M2,5X10	200	24540.025.010	M3X35	200	24540.030.035	M4X6	200	24540.040.006
M2,5X12	200	24540.025.012	M3X40	200	24540.030.040	M4X8	200	24540.040.008
M2,5X14	200	24540.025.014	M3X45	200	24540.030.045	M4X10	200	24540.040.010

24540 Wkręty z łbem stożkowym płaskim z nacięciem prostym

d x L	☒	Kod artykułu	d x L	☒	Kod artykułu	d x L	☒	Kod artykułu
M4X12	200	24540.040.012	M6X16	200	24540.060.016	M10X35	100	24540.100.035
M4X16	200	24540.040.016	M6X18	200	24540.060.018	M10X40	100	24540.100.040
M4X20	200	24540.040.020	M6X20	200	24540.060.020	M10X45	100	24540.100.045
M4X25	200	24540.040.025	M6X25	200	24540.060.025	M10X50	100	24540.100.050
M4X30	200	24540.040.030	M6X30	200	24540.060.030	M10X60	100	24540.100.060
M4X35	200	24540.040.035	M6X35	200	24540.060.035	M10X70	100	24540.100.070
M4X40	200	24540.040.040	M6X40	200	24540.060.040	M10X80	100	24540.100.080
M4X45	200	24540.040.045	M6X45	200	24540.060.045	M10X100	100	24540.100.100
M4X50	200	24540.040.050	M6X50	200	24540.060.050			
M4X55	500	24540.040.055	M6X55	200	24540.060.055	M12X20	100	24540.120.020
M4X60	200	24540.040.060	M6X60	200	24540.060.060	M12X25	100	24540.120.025
M4X70	200	24540.040.070	M6X70	200	24540.060.070	M12X30	100	24540.120.030
M4X80	200	24540.040.080	M6X75	100	24540.060.075	M12X35	100	24540.120.035
M4X100	200	24540.040.100	M6X80	100	24540.060.080	M12X40	100	24540.120.040
			M6X90	100	24540.060.090	M12X50	100	24540.120.050
M5X6	200	24540.050.006	M6X100	100	24540.060.100	M12X60	100	24540.120.060
M5X8	200	24540.050.008				M12X70	100	24540.120.070
M5X10	200	24540.050.010	M8X10	200	24540.080.010	M12X80	100	24540.120.080
M5X12	200	24540.050.012	M8X12	200	24540.080.012	M12X100	100	24540.120.100
M5X16	200	24540.050.016	M8X16	200	24540.080.016			
M5X20	200	24540.050.020	M8X20	200	24540.080.020	M16X30	50	24540.160.030
M5X25	200	24540.050.025	M8X25	200	24540.080.025	M16X35	50	24540.160.035
M5X30	200	24540.050.030	M8X30	200	24540.080.030	M16X40	50	24540.160.040
M5X35	200	24540.050.035	M8X35	200	24540.080.035	M16X45	50	24540.160.045
M5X40	200	24540.050.040	M8X40	200	24540.080.040	M16X50	50	24540.160.050
M5X45	200	24540.050.045	M8X45	200	24540.080.045	M16X60	50	24540.160.060
M5X50	200	24540.050.050	M8X50	200	24540.080.050	M16X70	50	24540.160.070
M5X55	200	24540.050.055	M8X60	100	24540.080.060	M16X80	50	24540.160.080
M5X60	200	24540.050.060	M8X70	100	24540.080.070	M16X90	50	24540.160.090
M5X70	200	24540.050.070	M8X80	100	24540.080.080	M16X100	50	24540.160.100
M5X80	100	24540.050.080	M8X90	100	24540.080.090			
M5X90	100	24540.050.090	M8X100	100	24540.080.100	M20X40	50	24540.200.040
M5X100	100	24540.050.100				M20X50	50	24540.200.050
			M10X16	200	24540.100.016	M20X60	25	24540.200.060
M6X8	200	24540.060.008	M10X20	200	24540.100.020	M20X70	25	24540.200.070
M6X10	200	24540.060.010	M10X25	200	24540.100.025			
M6X12	200	24540.060.012	M10X30	200	24540.100.030			

6

24560 Wkręty z łbem stożkowym płaskim z nacięciem prostym

H01A

Gwint Metryczny
Materiał Stal
Klasa 4.8
Obróbka powierzchni Ocynkowane, po żółtej pasywacji



d x L	☒	Kod artykułu	d x L	☒	Kod artykułu	d x L	☒	Kod artykułu
M3X5	500	24560.030.005	M4X20	500	24560.040.020	M6X10	200	24560.060.010
M3X6	500	24560.030.006	M4X25	500	24560.040.025	M6X12	200	24560.060.012
M3X8	500	24560.030.008	M4X30	500	24560.040.030	M6X16	200	24560.060.016
M3X10	500	24560.030.010	M4X40	500	24560.040.040	M6X20	200	24560.060.020
M3X12	500	24560.030.012	M4X50	500	24560.040.050	M6X25	200	24560.060.025
M3X16	500	24560.030.016	M4X60	500	24560.040.060	M6X30	200	24560.060.030
M3X20	500	24560.030.020				M6X40	200	24560.060.040
M3X25	500	24560.030.025	M5X8	500	24560.050.008	M6X50	200	24560.060.050
M3X30	500	24560.030.030	M5X10	500	24560.050.010	M6X60	200	24560.060.060
M3X40	500	24560.030.040	M5X12	500	24560.050.012	M6X70	200	24560.060.070
M3X50	500	24560.030.050	M5X16	500	24560.050.016	M6X80	200	24560.060.080
M3X60	500	24560.030.060	M5X20	500	24560.050.020			
			M5X25	500	24560.050.025	M8X16	200	24560.080.016
M4X6	500	24560.040.006	M5X30	500	24560.050.030	M8X20	200	24560.080.020
M4X8	500	24560.040.008	M5X40	500	24560.050.040	M8X25	200	24560.080.025
M4X10	500	24560.040.010	M5X50	500	24560.050.050	M8X30	200	24560.080.030
M4X12	500	24560.040.012	M5X60	500	24560.050.060	M8X40	200	24560.080.040
M4X16	500	24560.040.016				M8X50	200	24560.080.050

24565 Wkręty z łbem stożkowym płaskim z nacięciem prostym



H01A

Gwint Metryczny
Materiał Stal
Klasa 4.8
Obróbka powierzchni Ocynkowane, po czarnej pasywacji



d x L	☒	Kod artykułu	d x L	☒	Kod artykułu	d x L	☒	Kod artykułu
M2X6	200	24565.020.006	M3X8	200	24565.030.008	M3X16	200	24565.030.016
			M3X10	200	24565.030.010	M3X20	200	24565.030.020
M3X6	200	24565.030.006	M3X12	200	24565.030.012			

24565 Wkręty z łbem stożkowym płaskim z nacięciem prostym								
d x L	☒	Kod artykułu	d x L	☒	Kod artykułu	d x L	☒	Kod artykułu
M4X6	200	24565.040.006	M5X20	200	24565.050.020	M8X20	200	24565.080.020
M4X8	200	24565.040.008	M5X25	200	24565.050.025	M8X25	200	24565.080.025
M4X10	200	24565.040.010	M5X35	200	24565.050.035	M8X30	200	24565.080.030
M4X12	200	24565.040.012				M8X35	200	24565.080.035
M4X16	200	24565.040.016	M6X20	200	24565.060.020	M8X40	200	24565.080.040
M4X20	200	24565.040.020	M6X25	200	24565.060.025	M8X50	200	24565.080.050
M4X25	200	24565.040.025	M6X30	200	24565.060.030			
M4X30	200	24565.040.030	M6X40	200	24565.060.040	M10X20	200	24565.100.020
			M6X50	200	24565.060.050	M10X30	200	24565.100.030
M5X10	200	24565.050.010				M10X40	100	24565.100.040
M5X12	200	24565.050.012	M8X12	200	24565.080.012	M10X50	100	24565.100.050
M5X16	200	24565.050.016	M8X16	200	24565.080.016			

24412 Wkręty z łbem stożkowym płaskim z nacięciem prostym		H07A
Gwint	Metryczny	
Materiał	Stal	
Klasa	8.8	
Obróbka powierzchni	Ocynkowane	
		
		

d x L	☒	Kod artykułu	d x L	☒	Kod artykułu	d x L	☒	Kod artykułu
M2,5X6	200	24412.025.006	M3X30	200	24412.030.030	M5X20	200	24412.050.020
M2,5X8	200	24412.025.008				M5X25	200	24412.050.025
M2,5X10	200	24412.025.010	M4X6	200	24412.040.006	M5X30	200	24412.050.030
M2,5X12	200	24412.025.012	M4X8	200	24412.040.008	M5X40	200	24412.050.040
M2,5X16	200	24412.025.016	M4X10	200	24412.040.010			
			M4X12	200	24412.040.012	M6X10	200	24412.060.010
M3X5	200	24412.030.005	M4X16	200	24412.040.016	M6X12	200	24412.060.012
M3X6	200	24412.030.006	M4X20	200	24412.040.020	M6X16	200	24412.060.016
M3X8	200	24412.030.008	M4X30	200	24412.040.030	M6X20	200	24412.060.020
M3X10	200	24412.030.010				M6X25	200	24412.060.025
M3X12	200	24412.030.012	M5X8	200	24412.050.008	M6X30	200	24412.060.030
M3X16	200	24412.030.016	M5X10	200	24412.050.010	M6X40	200	24412.060.040
M3X20	200	24412.030.020	M5X12	200	24412.050.012			
M3X25	200	24412.030.025	M5X16	200	24412.050.016			

6

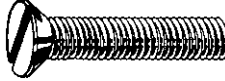
51111 Wkręty z łbem stożkowym płaskim z nacięciem prostym		R02A
Gwint	Metryczny	
Materiał	Stal nierdzewna A2	
		
		

d x L	☒	Kod artykułu	d x L	☒	Kod artykułu	d x L	☒	Kod artykułu
M2X10	200	51111.020.010	M3X6	200	51111.030.006			
M2X16	200	51111.020.016	M3X8	200	51111.030.008	M4X6	200	51111.040.006
			M3X10	200	51111.030.010	M4X8	200	51111.040.008
M2,5X4	200	51111.025.004	M3X12	200	51111.030.012	M4X10	200	51111.040.010
M2,5X5	200	51111.025.005	M3X16	200	51111.030.016	M4X12	200	51111.040.012
M2,5X16	200	51111.025.016	M3X20	200	51111.030.020	M4X16	200	51111.040.016
M2,5X20	200	51111.025.020	M3X25	200	51111.030.025	M4X20	200	51111.040.020
			M3X30	200	51111.030.030			
M3X4	200	51111.030.004	M3X40	200	51111.030.040			

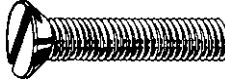

51110 Wkręty z łbem stożkowym płaskim z nacięciem prostym		R02A
Gwint	Metryczny	
Materiał	Stal nierdzewna A2	
		
		

d x L	☒	Kod artykułu	d x L	☒	Kod artykułu	d x L	☒	Kod artykułu
M1X2*	1000	51110.010.002	M1,2X5*	1000	51110.012.005			
M1X3*	1000	51110.010.003	M1,2X6*	1000	51110.012.006	M1,6X2*	1000	51110.016.002
M1X4*	1000	51110.010.004	M1,2X8*	1000	51110.012.008	M1,6X3*	1000	51110.016.003
M1X5*	1000	51110.010.005				M1,6X4	100	51110.016.004
M1X6*	1000	51110.010.006	M1,4X3*	1000	51110.014.003	M1,6X5	100	51110.016.005
M1X8*	1000	51110.010.008	M1,4X4*	1000	51110.014.004	M1,6X6	100	51110.016.006
M1X10*	1000	51110.010.010	M1,4X5*	1000	51110.014.005	M1,6X8	100	51110.016.008
			M1,4X6*	1000	51110.014.006	M1,6X10	100	51110.016.010
M1,2X2*	1000	51110.012.002	M1,4X8*	1000	51110.014.008	M1,6X12	100	51110.016.012
M1,2X3*	1000	51110.012.003	M1,4X10*	1000	51110.014.010	M1,6X14*	1000	51110.016.014
M1,2X4*	1000	51110.012.004	M1,4X12*	1000	51110.014.012	M1,6X16*	1000	51110.016.016

51110 Wkręty z łbem stożkowym płaskim z nacięciem prostym



d x L	☒	Kod artykułu	d x L	☒	Kod artykułu	d x L	☒	Kod artykułu
M2X3*	1000	51110.020.003	M4X30	200	51110.040.030	M8X25	100	51110.080.025
M2X4	500	51110.020.004	M4X35	200	51110.040.035	M8X30	100	51110.080.030
M2X5	500	51110.020.005	M4X40	200	51110.040.040	M8X35	100	51110.080.035
M2X6	500	51110.020.006	M4X45	200	51110.040.045	M8X40	100	51110.080.040
M2X8	500	51110.020.008	M4X50	200	51110.040.050	M8X45	100	51110.080.045
M2X10	500	51110.020.010	M4X55*	500	51110.040.055	M8X50	100	51110.080.050
M2X12	500	51110.020.012	M4X60	200	51110.040.060	M8X55*	100	51110.080.055
M2X14*	1000	51110.020.014	M4X70	200	51110.040.070	M8X60	100	51110.080.060
M2X16	500	51110.020.016	M4X80	200	51110.040.080	M8X70	100	51110.080.070
M2X18*	1000	51110.020.018	M4X100*	200	51110.040.100	M8X80	100	51110.080.080
M2X20	500	51110.020.020	M5X6*	500	51110.050.006	M8X90	100	51110.080.090
M2X22*	500	51110.020.022	M5X8	200	51110.050.008	M8X100	100	51110.080.100
M2X25	500	51110.020.025	M5X10	200	51110.050.010	M8X110*	100	51110.080.110
M2X28*	500	51110.020.028	M5X12	200	51110.050.012	M8X120*	100	51110.080.120
M2X30*	500	51110.020.030	M5X14*	500	51110.050.014	M8X130*	100	51110.080.130
M2X35*	500	51110.020.035	M5X16	200	51110.050.016	M8X140*	100	51110.080.140
M2X40*	500	51110.020.040	M5X18*	500	51110.050.018	M10X16*	100	51110.100.016
M2,5X4	500	51110.025.004	M5X20	200	51110.050.020	M10X20	50	51110.100.020
M2,5X5	500	51110.025.005	M5X22*	500	51110.050.022	M10X25	50	51110.100.025
M2,5X6	500	51110.025.006	M5X25	200	51110.050.025	M10X30	50	51110.100.030
M2,5X8	500	51110.025.008	M5X28*	500	51110.050.028	M10X35	50	51110.100.035
M2,5X10	500	51110.025.010	M5X30	200	51110.050.030	M10X40	50	51110.100.040
M2,5X12	500	51110.025.012	M5X35	200	51110.050.035	M10X45	50	51110.100.045
M2,5X14*	1000	51110.025.014	M5X40	200	51110.050.040	M10X50	50	51110.100.050
M2,5X16	500	51110.025.016	M5X45	200	51110.050.045	M10X55*	100	51110.100.055
M2,5X20	500	51110.025.020	M5X50	200	51110.050.050	M10X60	50	51110.100.060
M2,5X25*	500	51110.025.025	M5X55	200	51110.050.055	M10X70	50	51110.100.070
M2,5X30*	500	51110.025.030	M5X60	200	51110.050.060	M10X80	50	51110.100.080
M3X3*	500	51110.030.003	M5X65*	200	51110.050.065	M10X90	50	51110.100.090
M3X4	500	51110.030.004	M5X70	200	51110.050.070	M10X100	50	51110.100.100
M3X5*	500	51110.030.005	M5X80	200	51110.050.080	M10X110*	50	51110.100.110
M3X6	500	51110.030.006	M5X90*	200	51110.050.090	M10X120*	50	51110.100.120
M3X8	500	51110.030.008	M5X100	200	51110.050.100	M10X130*	50	51110.100.130
M3X10	500	51110.030.010	M5X120*	200	51110.050.120	M12X20*	50	51110.120.020
M3X12	500	51110.030.012	M6X8	200	51110.060.008	M12X25	100	51110.120.025
M3X14*	500	51110.030.014	M6X10	200	51110.060.010	M12X30*	50	51110.120.030
M3X16	500	51110.030.016	M6X12	200	51110.060.012	M12X35*	50	51110.120.035
M3X18*	500	51110.030.018	M6X14	200	51110.060.014	M12X40*	50	51110.120.040
M3X20	500	51110.030.020	M6X16	200	51110.060.016	M12X45*	50	51110.120.045
M3X22*	500	51110.030.022	M6X18	200	51110.060.018	M12X50*	50	51110.120.050
M3X25	500	51110.030.025	M6X20	200	51110.060.020	M12X55*	50	51110.120.055
M3X30	500	51110.030.030	M6X22*	200	51110.060.022	M12X60*	50	51110.120.060
M3X35	500	51110.030.035	M6X25	200	51110.060.025	M12X70*	50	51110.120.070
M3X40	500	51110.030.040	M6X28*	200	51110.060.028	M12X80*	50	51110.120.080
M3X45*	200	51110.030.045	M6X30	200	51110.060.030	M12X90*	50	51110.120.090
M3X50*	200	51110.030.050	M6X35	100	51110.060.035	M12X100*	50	51110.120.100
M3X60*	200	51110.030.060	M6X40	100	51110.060.040	M12X120*	50	51110.120.120
M3,5X6*	500	51110.035.006	M6X45	100	51110.060.045	M14X110*	25	51110.140.110
M3,5X8*	500	51110.035.008	M6X50	100	51110.060.050	M14X120*	25	51110.140.120
M3,5X10	500	51110.035.010	M6X55*	200	51110.060.055	M16X30*	25	51110.160.030
M3,5X12*	500	51110.035.012	M6X60	100	51110.060.060	M16X35*	25	51110.160.035
M3,5X16*	500	51110.035.016	M6X65	100	51110.060.065	M16X50*	25	51110.160.050
M3,5X20*	500	51110.035.020	M6X70	100	51110.060.070	M16X55*	25	51110.160.055
M3,5X30*	500	51110.035.030	M6X75	100	51110.060.075	M16X60*	25	51110.160.060
M4X5*	500	51110.040.005	M6X80	100	51110.060.080	M16X70*	25	51110.160.070
M4X6	500	51110.040.006	M6X85	100	51110.060.085	M16X120*	10	51110.160.120
M4X8	500	51110.040.008	M6X90	100	51110.060.090	M16X150*	10	51110.160.150
M4X10	500	51110.040.010	M6X100	100	51110.060.100	M18X60*	25	51110.180.060
M4X12	500	51110.040.012	M6X110*	200	51110.060.110	M18X80*	25	51110.180.080
M4X14*	500	51110.040.014	M6X120*	200	51110.060.120	M20X110*	10	51110.200.110
M4X16	500	51110.040.016	M8X10	200	51110.080.010	M20X120*	10	51110.200.120
M4X18*	500	51110.040.018	M8X12	100	51110.080.012	M20X130*	10	51110.200.130
M4X20	500	51110.040.020	M8X14*	200	51110.080.014			
M4X22*	500	51110.040.022	M8X16	100	51110.080.016			
M4X25	200	51110.040.025	M8X18*	200	51110.080.018			
			M8X20	100	51110.080.020			
			M8X22*	200	51110.080.022			

6

55110		Wkręty z łbem stożkowym płaskim z nacięciem prostym		R42A
Gwint	Metryczny			
Material	Stal nierdzewna A4			
				
				

d x L	☒	Kod artykułu	d x L	☒	Kod artykułu	d x L	☒	Kod artykułu
M1X3*	1000	55110.010.003	M4X30	200	55110.040.030	M8X20	100	55110.080.020
M1X4*	1000	55110.010.004	M4X35	200	55110.040.035	M8X25	100	55110.080.025
M1X5*	1000	55110.010.005	M4X40	200	55110.040.040	M8X30	100	55110.080.030
			M4X45	200	55110.040.045	M8X35	100	55110.080.035
M1,6X4*	1000	55110.016.004	M4X50	200	55110.040.050	M8X40	100	55110.080.040
M1,6X5*	1000	55110.016.005	M4X55*	500	55110.040.055	M8X45	100	55110.080.045
M1,6X6*	1000	55110.016.006	M4X60	200	55110.040.060	M8X50	100	55110.080.050
M1,6X8*	1000	55110.016.008	M4X70*	200	55110.040.070	M8X55*	100	55110.080.055
M1,6X10*	1000	55110.016.010				M8X60	100	55110.080.060
			M5X6	200	55110.050.006	M8X70	100	55110.080.070
M2X4*	1000	55110.020.004	M5X8	200	55110.050.008	M8X80	100	55110.080.080
M2X5	500	55110.020.005	M5X10	200	55110.050.010	M8X90	100	55110.080.090
M2X6	500	55110.020.006	M5X12	200	55110.050.012	M8X100	100	55110.080.100
M2X8	500	55110.020.008	M5X14*	500	55110.050.014	M8X110*	100	55110.080.110
M2X10	500	55110.020.010	M5X16	200	55110.050.016	M8X120*	100	55110.080.120
M2X12	500	55110.020.012	M5X18*	500	55110.050.018	M8X140*	100	55110.080.140
M2X16	500	55110.020.016	M5X20	200	55110.050.020			
M2X20	500	55110.020.020	M5X22*	500	55110.050.022	M10X16*	100	55110.100.016
			M5X25	200	55110.050.025	M10X20	50	55110.100.020
M2,5X4*	1000	55110.025.004	M5X30	200	55110.050.030	M10X25	50	55110.100.025
M2,5X5	500	55110.025.005	M5X35	200	55110.050.035	M10X30	50	55110.100.030
M2,5X6	500	55110.025.006	M5X40	200	55110.050.040	M10X35	50	55110.100.035
M2,5X8	500	55110.025.008	M5X45	200	55110.050.045	M10X40	50	55110.100.040
M2,5X10	500	55110.025.010	M5X50	200	55110.050.050	M10X45*	100	55110.100.045
M2,5X12	500	55110.025.012	M5X55*	200	55110.050.055	M10X50	50	55110.100.050
M2,5X14*	1000	55110.025.014	M5X60	200	55110.050.060	M10X55*	100	55110.100.055
M2,5X16	500	55110.025.016	M5X70	200	55110.050.070	M10X60	50	55110.100.060
M2,5X20	500	55110.025.020	M5X75*	200	55110.050.075	M10X70	50	55110.100.070
M2,5X25*	500	55110.025.025	M5X80	200	55110.050.080	M10X80	50	55110.100.080
			M5X90*	200	55110.050.090	M10X90	50	55110.100.090
M3X4*	500	55110.030.004	M5X100*	200	55110.050.100	M10X100	50	55110.100.100
M3X5*	500	55110.030.005				M10X120*	50	55110.100.120
M3X6	500	55110.030.006	M6X8*	500	55110.060.008	M10X140*	50	55110.100.140
M3X8	500	55110.030.008	M6X10	200	55110.060.010			
M3X10	500	55110.030.010	M6X12	200	55110.060.012	M12X20	50	55110.120.020
M3X12	500	55110.030.012	M6X14*	500	55110.060.014	M12X25	50	55110.120.025
M3X14*	500	55110.030.014	M6X16	200	55110.060.016	M12X30	25	55110.120.030
M3X16	500	55110.030.016	M6X18*	500	55110.060.018	M12X35*	50	55110.120.035
M3X18*	500	55110.030.018	M6X20	200	55110.060.020	M12X40	25	55110.120.040
M3X20	500	55110.030.020	M6X22*	200	55110.060.022	M12X45*	50	55110.120.045
M3X25	500	55110.030.025	M6X25	200	55110.060.025	M12X50	25	55110.120.050
M3X30	500	55110.030.030	M6X30	200	55110.060.030	M12X60	25	55110.120.060
M3X35	500	55110.030.035	M6X35	100	55110.060.035	M12X70	25	55110.120.070
M3X40	500	55110.030.040	M6X40	100	55110.060.040	M12X80	25	55110.120.080
M3X45*	200	55110.030.045	M6X45	100	55110.060.045	M12X90	25	55110.120.090
M3X50*	200	55110.030.050	M6X50	100	55110.060.050	M12X100*	50	55110.120.100
M3X60*	200	55110.030.060	M6X55*	200	55110.060.055	M12X120*	50	55110.120.120
			M6X60	100	55110.060.060			
M3,5X8*	500	55110.035.008	M6X65*	200	55110.060.065	M16X25*	25	55110.160.025
			M6X70	100	55110.060.070	M16X35*	25	55110.160.035
M4X5*	500	55110.040.005	M6X80	100	55110.060.080	M16X40*	25	55110.160.040
M4X8	500	55110.040.008	M6X90	100	55110.060.090	M16X45*	25	55110.160.045
M4X10	500	55110.040.010	M6X100	100	55110.060.100	M16X50*	25	55110.160.050
M4X12	500	55110.040.012	M6X110*	200	55110.060.110	M16X60*	25	55110.160.060
M4X14*	500	55110.040.014	M6X120*	200	55110.060.120	M16X70*	25	55110.160.070
M4X16	500	55110.040.016				M16X80*	25	55110.160.080
M4X18*	500	55110.040.018	M8X10*	200	55110.080.010	M16X90*	25	55110.160.090
M4X20	500	55110.040.020	M8X12*	200	55110.080.012	M16X100*	10	55110.160.100
M4X25	200	55110.040.025	M8X16	100	55110.080.016			

6

48170		Wkręty z łbem stożkowym płaskim z nacięciem prostym		M05A
Gwint	Metryczny			
Material	Mosiądz Cu2/Cu3			
				
				

d x L	☒	Kod artykułu	d x L	☒	Kod artykułu	d x L	☒	Kod artykułu
M2X5	200	48170.020.005	M2X12	200	48170.020.012	M2,5X6	200	48170.025.006
M2X6	200	48170.020.006	M2X16	200	48170.020.016	M2,5X8	200	48170.025.008
M2X8	200	48170.020.008	M2X20	200	48170.020.020	M2,5X10	200	48170.025.010
M2X10	200	48170.020.010				M2,5X12	200	48170.025.012

48170 Wkręty z łbem stożkowym płaskim z nacięciem prostym

d x L	☒	Kod artykułu	d x L	☒	Kod artykułu	d x L	☒	Kod artykułu
M2,5X16	200	48170.025.016	M5X12	200	48170.050.012	M8X40	100	48170.080.040
M2,5X20	200	48170.025.020	M5X16	200	48170.050.016	M8X50	100	48170.080.050
			M5X20	200	48170.050.020	M8X60	100	48170.080.060
M3X5	200	48170.030.005	M5X25	200	48170.050.025			
M3X6	200	48170.030.006	M5X30	200	48170.050.030	M10X16	100	48170.100.016
M3X8	200	48170.030.008	M5X35	200	48170.050.035	M10X20	100	48170.100.020
M3X10	200	48170.030.010	M5X40	200	48170.050.040	M10X25	100	48170.100.025
M3X12	200	48170.030.012	M5X50	200	48170.050.050	M10X30	100	48170.100.030
M3X16	200	48170.030.016				M10X35	100	48170.100.035
M3X20	200	48170.030.020	M6X8	200	48170.060.008	M10X40	100	48170.100.040
M3X25	200	48170.030.025	M6X10	200	48170.060.010	M10X45	100	48170.100.045
M3X30	200	48170.030.030	M6X12	200	48170.060.012	M10X50	100	48170.100.050
			M6X16	200	48170.060.016	M10X60	100	48170.100.060
M4X6	200	48170.040.006	M6X20	200	48170.060.020	M10X70	100	48170.100.070
M4X8	200	48170.040.008	M6X25	200	48170.060.025	M10X80	100	48170.100.080
M4X10	200	48170.040.010	M6X30	200	48170.060.030			
M4X12	200	48170.040.012	M6X35	200	48170.060.035	M12X20	100	48170.120.020
M4X16	200	48170.040.016	M6X40	200	48170.060.040	M12X25	100	48170.120.025
M4X20	200	48170.040.020	M6X50	200	48170.060.050	M12X30	100	48170.120.030
M4X25	200	48170.040.025	M6X60	100	48170.060.060	M12X35	100	48170.120.035
M4X30	200	48170.040.030	M6X70	100	48170.060.070	M12X40	100	48170.120.040
M4X35	200	48170.040.035				M12X50	100	48170.120.050
M4X40	200	48170.040.040	M8X16	100	48170.080.016	M12X60	100	48170.120.060
M4X50	200	48170.040.050	M8X20	100	48170.080.020	M12X70	100	48170.120.070
			M8X25	100	48170.080.025	M12X80	100	48170.120.080
M5X8	200	48170.050.008	M8X30	100	48170.080.030			
M5X10	200	48170.050.010	M8X35	100	48170.080.035			

6
48550 Wkręty z łbem stożkowym płaskim z nacięciem prostym
M05A

Gwint Metryczny
Materiał Mosiądz Cu2/Cu3
Obróbka powierzchni Niklowane

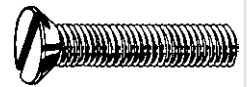

d x L	☒	Kod artykułu	d x L	☒	Kod artykułu	d x L	☒	Kod artykułu
M2,5X10	200	48550.025.010	M4X20	200	48550.040.020			
M2,5X20	200	48550.025.020	M4X25	200	48550.040.025	M6X10	200	48550.060.010
			M4X30	200	48550.040.030	M6X16	200	48550.060.016
M3X6	200	48550.030.006	M4X35	200	48550.040.035	M6X20	200	48550.060.020
M3X8	200	48550.030.008	M4X50	200	48550.040.050	M6X30	200	48550.060.030
M3X10	200	48550.030.010				M6X40	200	48550.060.040
M3X12	200	48550.030.012	M5X8	200	48550.050.008	M6X50	200	48550.060.050
M3X16	200	48550.030.016	M5X10	200	48550.050.010	M6X60	100	48550.060.060
M3X20	200	48550.030.020	M5X12	200	48550.050.012	M6X80	100	48550.060.080
M3X25	200	48550.030.025	M5X16	200	48550.050.016			
M3X35	200	48550.030.035	M5X20	200	48550.050.020	M8X16	100	48550.080.016
M3X50	200	48550.030.050	M5X25	200	48550.050.025	M8X20	100	48550.080.020
			M5X30	200	48550.050.030	M8X25	100	48550.080.025
M4X8	200	48550.040.008	M5X35	200	48550.050.035	M8X50	100	48550.080.050
M4X10	200	48550.040.010	M5X40	200	48550.050.040	M8X70	100	48550.080.070
M4X12	200	48550.040.012	M5X60	200	48550.050.060	M8X80	100	48550.080.080
M4X16	200	48550.040.016	M5X70	200	48550.050.070			

56440 Wkręty z łbem stożkowym płaskim z nacięciem prostym
W02A

Gwint Metryczny
Materiał Plastik Poliamid (nylon)
Klasa PA 6.6
Kolor Biały

DIN ≈963
ISO ≈2009
NEN ≈2370
ASME ≈B18.6.7M
NF ≈E25-123
BS ≈4183



d x L	☒	Kod artykułu	d x L	☒	Kod artykułu	d x L	☒	Kod artykułu
M3X4	200	56440.030.004	M4X16	200	56440.040.016	M5X35	100	56440.050.035
M3X6	200	56440.030.006	M4X18	200	56440.040.018	M5X40	100	56440.050.040
M3X8	200	56440.030.008	M4X20	200	56440.040.020			
M3X10	200	56440.030.010	M4X25	200	56440.040.025	M6X8	100	56440.060.008
M3X12	200	56440.030.012	M4X30	200	56440.040.030	M6X10	50	56440.060.010
M3X16	200	56440.030.016	M4X35	200	56440.040.035	M6X16	50	56440.060.016
M3X20	200	56440.030.020				M6X20	50	56440.060.020
M3X25	200	56440.030.025	M5X8	100	56440.050.008	M6X25	50	56440.060.025
M3X30	200	56440.030.030	M5X10	100	56440.050.010	M6X30	50	56440.060.030
			M5X12	100	56440.050.012	M6X40	50	56440.060.040
M4X6	200	56440.040.006	M5X16	100	56440.050.016	M6X50	50	56440.060.050
M4X8	200	56440.040.008	M5X20	100	56440.050.020			
M4X10	200	56440.040.010	M5X25	100	56440.050.025	M8X20	25	56440.080.020
M4X12	200	56440.040.012	M5X30	100	56440.050.030	M8X25	25	56440.080.025

56440 Wkręty z łbem stożkowym płaskim z nacięciem prostym								
d x L	☒	Kod artykułu	d x L	☒	Kod artykułu	d x L	☒	Kod artykułu
M8X30	25	56440.080.030	M8X40	25	56440.080.040	M8X50	25	56440.080.050

Wkręty z łbem stożkowym płaskim z nacięciem prostym, BSW

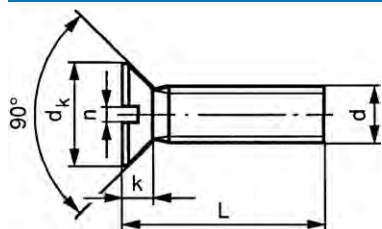

BS ≈450 (1958)
NEN ≈1780 (1960)

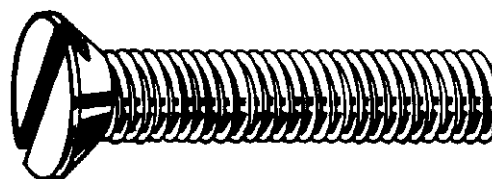



Informacje techniczne

d	d _k	k	n	Zwoje gwintu na cal
1/8	5.5	1.4	0.8	40
5/32	7	1.8	0.9	32
3/16	8.3	2.2	1.1	24
1/4	11	2.8	1.3	20
5/16	13.5	3.4	1.5	18
3/8	16.5	4.2	1.8	16

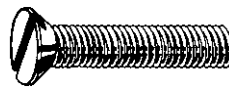

- Gwint Whitworth'a (BSW/BSF) nie jest zalecany do międzynarodowego stosowania.
- Zaleca się stosowanie gwintu metrycznego (M/MF) lub zunifikowanego (UNC/UNF).

Grupy katalogowe

Gwint	Gniazdo	Materiał	Klasa	Kod	Strona
BSW	Szczelina	St	4.8	24220	6-27
BSW	Szczelina	Mosiądz Cu2		48220	6-27

24220 Wkręty z łbem stożkowym płaskim z nacięciem prostym, BSW						X07A
Gwint	Calowy, Whitworth'a (BSW)					
Materiał	Stal					
Klasa	4.8					
						

d x L	☒	Kod artykułu	d x L	☒	Kod artykułu	d x L	☒	Kod artykułu
5/32X1.1/2	100	24220.039.012	3/16X1.1/2	100	24220.047.038	1/4X3 Inch	100	24220.063.076
5/32X5/8	100	24220.039.015	3/16X2 Inch	100	24220.047.050			
5/32X3/4	100	24220.039.019				5/16X5/8	100	24220.079.015
5/32X1 Inch	100	24220.039.025	1/4X3/8	100	24220.063.009	5/16X1 Inch	100	24220.079.025
5/32X1.1/4	100	24220.039.031	1/4X1/2	100	24220.063.012	5/16X1.3/4	50	24220.079.044
5/32X1.1/2	100	24220.039.038	1/4X5/8	100	24220.063.015	5/16X2 Inch	50	24220.079.050
			1/4X3/4	100	24220.063.019	5/16X2.1/2	50	24220.079.063
3/16X3/8	100	24220.047.009	1/4X1 Inch	100	24220.063.025			
3/16X1/2	100	24220.047.012	1/4X1.1/4	100	24220.063.031	3/8X1 Inch	100	24220.096.025
3/16X5/8	100	24220.047.015	1/4X1.1/2	100	24220.063.038	3/8X2 Inch	50	24220.096.050
3/16X3/4	100	24220.047.019	1/4X2 Inch	100	24220.063.050	3/8X2.1/2	50	24220.096.063
3/16X1 Inch	100	24220.047.025	1/4X2.1/2	100	24220.063.063	3/8X3 Inch	50	24220.096.076
3/16X1.1/4	100	24220.047.031						

48220 Wkręty z łbem stożkowym płaskim z nacięciem prostym, BSW						X07A
Gwint	Calowy, Whitworth'a (BSW)					
Materiał	Mosiądz Cu2					
						

d x L	☒	Kod artykułu	d x L	☒	Kod artykułu	d x L	☒	Kod artykułu
1/8X3/8	100	48220.031.009	5/32X3/4	100	48220.039.019	3/16X1 Inch	100	48220.047.025
1/8X1/2	100	48220.031.012	5/32X1 Inch	100	48220.039.025	3/16X1.1/4	100	48220.047.031
1/8X5/8	100	48220.031.015	5/32X1.1/4	100	48220.039.031	3/16X1.1/2	100	48220.047.038
1/8X3/4	100	48220.031.019				3/16X2 Inch	100	48220.047.050
1/8X1 Inch	100	48220.031.025	3/16X3/8	100	48220.047.009			
1/8X1.1/4	100	48220.031.031	3/16X1/2	100	48220.047.012	1/4X3/8	100	48220.063.009
			3/16X5/8	100	48220.047.015	1/4X1/2	100	48220.063.012
5/32X3/8	100	48220.039.009	3/16X3/4	100	48220.047.019	1/4X5/8	100	48220.063.015
5/32X1/2	100	48220.039.012						

48220 Wkręty z łbem stożkowym płaskim z nacięciem prostym, BSW								
d x L	☒	Kod artykułu	d x L	☒	Kod artykułu	d x L	☒	Kod artykułu
1/4X3/4	100	48220.063.019	5/16X5/8	100	48220.079.015	3/8X3/4	50	48220.096.019
1/4X1 Inch	100	48220.063.025	5/16X3/4	100	48220.079.019	3/8X1 Inch	50	48220.096.025
1/4X1.1/4	100	48220.063.031	5/16X1 Inch	100	48220.079.025	3/8X1.1/2	50	48220.096.038
1/4X1.1/2	100	48220.063.038	5/16X1.1/2	50	48220.079.038	3/8X2 Inch	50	48220.096.050
1/4X2 Inch	100	48220.063.050	5/16X2 Inch	50	48220.079.050	3/8X2.1/2	50	48220.096.063
1/4X2.1/2	50	48220.063.063	5/16X2.1/2	50	48220.079.063	3/8X3 Inch	50	48220.096.076
1/4X3 Inch	50	48220.063.076	5/16X3 Inch	50	48220.079.076			

Wkręty z łbem stożkowym soczewkowym z nacięciem prostym

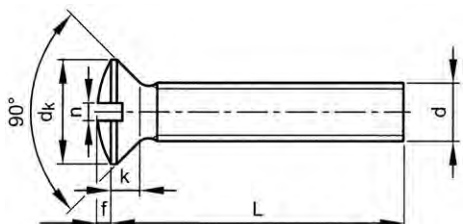

DIN 964
 ISO 2010
 NEN 2371
 ASME B18.6.7M
 NF E25-124
 BS 4183





Informacje techniczne

d	d _k	f ≈	k (maks.)	n	P	Pelen gwint L ≤
M2	3.8	0.5	1.2	0.5	0.4	16
M2.5	4.7	0.6	1.5	0.6	0.45	16
M3	5.6	0.75	1.65	0.8	0.5	20
M4	7.5	1	2.2	1	0.7	25
M5	9.2	1.25	2.5	1.2	0.8	30
M6	11	1.5	3	1.6	1	35
M8	14.5	2	4	2	1.25	40
M10	18	2.5	5	2.5	1.5	50

Grupy katalogowe

Gwint	Gniazdo	Materiał	Klasa	Obróbka powierzchni	Kod	Strona
M	Szczelina	St	4.8	Ocyнк.	24570	6-28
M	Szczelina	St.St. A2			51210	6-29
M	Szczelina	St.St. A4			55210	6-29
M	Szczelina	Mosiądz Cu2/Cu3			48180	6-30
M	Szczelina	Mosiądz Cu2/Cu3		Nikl.	48570	6-30

24570 Wkręty z łbem stożkowym soczewkowym z nacięciem prostym		H01A
Gwint	Metryczny	
Materiał	Stal	
Klasa	4.8	
Obróbka powierzchni	Ocyńkowane	

d x L	☒	Kod artykułu	d x L	☒	Kod artykułu	d x L	☒	Kod artykułu
M3X6	500	24570.030.006	M4X40	500	24570.040.040	M6X12	200	24570.060.012
M3X8	500	24570.030.008	M4X50	500	24570.040.050	M6X16	200	24570.060.016
M3X10	500	24570.030.010	M4X60	200	24570.040.060	M6X20	200	24570.060.020
M3X12	500	24570.030.012				M6X25	200	24570.060.025
M3X16	500	24570.030.016	M5X8	500	24570.050.008	M6X30	200	24570.060.030
M3X20	500	24570.030.020	M5X10	500	24570.050.010	M6X35	200	24570.060.035
M3X25	500	24570.030.025	M5X12	500	24570.050.012	M6X40	200	24570.060.040
M3X30	500	24570.030.030	M5X16	500	24570.050.016	M6X50	200	24570.060.050
M3X40	500	24570.030.040	M5X20	500	24570.050.020	M6X60	200	24570.060.060
			M5X25	500	24570.050.025			
M4X6	500	24570.040.006	M5X30	500	24570.050.030	M8X16	200	24570.080.016
M4X8	500	24570.040.008	M5X35	500	24570.050.035	M8X20	200	24570.080.020
M4X10	500	24570.040.010	M5X40	500	24570.050.040	M8X25	200	24570.080.025
M4X12	500	24570.040.012	M5X45	200	24570.050.045	M8X30	200	24570.080.030
M4X16	500	24570.040.016	M5X50	200	24570.050.050	M8X40	200	24570.080.040
M4X20	500	24570.040.020	M5X60	200	24570.050.060	M8X50	200	24570.080.050
M4X25	500	24570.040.025				M8X60	100	24570.080.060
M4X30	500	24570.040.030	M6X10	200	24570.060.010			

51210		Wkręty z łbem stożkowym soczewkowym z nacięciem prostym		R02A
Gwint	Metryczny			
Material	Stal nierdzewna A2			

d x L	☒	Kod artykułu	d x L	☒	Kod artykułu	d x L	☒	Kod artykułu
M2X3*	1000	51210.020.003	M4X14	500	51210.040.014	M6X20	200	51210.060.020
M2X4*	1000	51210.020.004	M4X16	500	51210.040.016	M6X25	200	51210.060.025
M2X5	100	51210.020.005	M4X18*	500	51210.040.018	M6X30	200	51210.060.030
M2X6	100	51210.020.006	M4X20	500	51210.040.020	M6X35	100	51210.060.035
M2X8*	1000	51210.020.008	M4X25	200	51210.040.025	M6X40	100	51210.060.040
M2X10*	1000	51210.020.010	M4X30	200	51210.040.030	M6X45	100	51210.060.045
M2X12	100	51210.020.012	M4X35	200	51210.040.035	M6X50	100	51210.060.050
M2X16*	1000	51210.020.016	M4X40	200	51210.040.040	M6X55*	200	51210.060.055
M2X20*	1000	51210.020.020	M4X45	200	51210.040.045	M6X60	100	51210.060.060
M2X30*	500	51210.020.030	M4X50	200	51210.040.050	M6X70	100	51210.060.070
			M4X60	200	51210.040.060	M6X80	100	51210.060.080
M2,5X5*	1000	51210.025.005	M4X70*	200	51210.040.070	M6X90	100	51210.060.090
M2,5X6	100	51210.025.006	M4X80*	200	51210.040.080	M6X100	100	51210.060.100
M2,5X8	100	51210.025.008						
M2,5X10	100	51210.025.010	M5X6	200	51210.050.006	M8X12*	200	51210.080.012
M2,5X12	100	51210.025.012	M5X8	200	51210.050.008	M8X16	100	51210.080.016
M2,5X16	100	51210.025.016	M5X10	200	51210.050.010	M8X20	100	51210.080.020
M2,5X20*	1000	51210.025.020	M5X12	200	51210.050.012	M8X25	100	51210.080.025
M2,5X25*	500	51210.025.025	M5X14*	500	51210.050.014	M8X30	100	51210.080.030
M2,5X30*	500	51210.025.030	M5X16	200	51210.050.016	M8X35	100	51210.080.035
			M5X18*	500	51210.050.018	M8X40	100	51210.080.040
M3X5*	500	51210.030.005	M5X20	200	51210.050.020	M8X45	100	51210.080.045
M3X6	500	51210.030.006	M5X22*	500	51210.050.022	M8X50	100	51210.080.050
M3X8	500	51210.030.008	M5X25	200	51210.050.025	M8X60	100	51210.080.060
M3X10	500	51210.030.010	M5X30	200	51210.050.030	M8X70	100	51210.080.070
M3X12	500	51210.030.012	M5X35	200	51210.050.035	M8X80	100	51210.080.080
M3X14	500	51210.030.014	M5X40	200	51210.050.040	M8X90	100	51210.080.090
M3X16	500	51210.030.016	M5X45	200	51210.050.045	M8X100	100	51210.080.100
M3X18*	500	51210.030.018	M5X50	200	51210.050.050			
M3X20	500	51210.030.020	M5X55*	200	51210.050.055	M10X16*	100	51210.100.016
M3X25	500	51210.030.025	M5X60	100	51210.050.060	M10X20*	100	51210.100.020
M3X30	500	51210.030.030	M5X70	100	51210.050.070	M10X25*	100	51210.100.025
M3X35	500	51210.030.035	M5X80	100	51210.050.080	M10X30	100	51210.100.030
M3X40	500	51210.030.040	M5X90	100	51210.050.090	M10X35	100	51210.100.035
M3X45*	200	51210.030.045	M5X100*	200	51210.050.100	M10X40	100	51210.100.040
M3X50	500	51210.030.050				M10X45*	100	51210.100.045
			M6X8*	500	51210.060.008	M10X50	100	51210.100.050
M4X5*	500	51210.040.005	M6X10	200	51210.060.010	M10X55*	100	51210.100.055
M4X6	500	51210.040.006	M6X12	200	51210.060.012	M10X60	100	51210.100.060
M4X8	500	51210.040.008	M6X14*	500	51210.060.014	M10X70	50	51210.100.070
M4X10	500	51210.040.010	M6X16	200	51210.060.016	M10X100*	50	51210.100.100
M4X12	500	51210.040.012						

6

55210		Wkręty z łbem stożkowym soczewkowym z nacięciem prostym		R42A
Gwint	Metryczny			
Material	Stal nierdzewna A4			

d x L	☒	Kod artykułu	d x L	☒	Kod artykułu	d x L	☒	Kod artykułu
M2X6	100	55210.020.006	M3X30	500	55210.030.030	M4X80*	200	55210.040.080
M2X8	100	55210.020.008	M3X35	500	55210.030.035			
M2X10*	1000	55210.020.010	M3X40	500	55210.030.040	M5X6	200	55210.050.006
M2X16	100	55210.020.016	M3X50	500	55210.030.050	M5X8	200	55210.050.008
M2X20	100	55210.020.020				M5X10	200	55210.050.010
			M4X6	500	55210.040.006	M5X12	200	55210.050.012
M2,5X6	100	55210.025.006	M4X8	500	55210.040.008	M5X14	200	55210.050.014
M2,5X8	100	55210.025.008	M4X10	500	55210.040.010	M5X16	200	55210.050.016
M2,5X10	100	55210.025.010	M4X12	500	55210.040.012	M5X18	200	55210.050.018
M2,5X12	100	55210.025.012	M4X14	500	55210.040.014	M5X20	200	55210.050.020
M2,5X16	100	55210.025.016	M4X16	500	55210.040.016	M5X25	200	55210.050.025
M2,5X25	100	55210.025.025	M4X18	500	55210.040.018	M5X30	200	55210.050.030
			M4X20	500	55210.040.020	M5X35	200	55210.050.035
M3X6	500	55210.030.006	M4X25	200	55210.040.025	M5X40	200	55210.050.040
M3X8	500	55210.030.008	M4X30	200	55210.040.030	M5X45	200	55210.050.045
M3X10	500	55210.030.010	M4X35	200	55210.040.035	M5X50	200	55210.050.050
M3X12	500	55210.030.012	M4X40	200	55210.040.040	M5X60	100	55210.050.060
M3X14	500	55210.030.014	M4X45	200	55210.040.045	M5X70	100	55210.050.070
M3X16	500	55210.030.016	M4X50	200	55210.040.050	M5X80	100	55210.050.080
M3X20	500	55210.030.020	M4X60	200	55210.040.060	M5X90*	200	55210.050.090
M3X25	500	55210.030.025	M4X70*	200	55210.040.070	M5X100	100	55210.050.100

55210 Wkręty z łbem stożkowym soczewkowym z nacięciem prostym

d x L	☒	Kod artykułu	d x L	☒	Kod artykułu	d x L	☒	Kod artykułu
M6X10	200	55210.060.010	M6X80	100	55210.060.080	M8X80*	100	55210.080.080
M6X12	200	55210.060.012	M6X90	100	55210.060.090	M8X90*	100	55210.080.090
M6X14*	500	55210.060.014	M6X100	100	55210.060.100	M8X100*	100	55210.080.100
M6X16	200	55210.060.016	M8X16	100	55210.080.016	M10X20*	100	55210.100.020
M6X20	200	55210.060.020	M8X20	100	55210.080.020	M10X25*	100	55210.100.025
M6X25	200	55210.060.025	M8X25	100	55210.080.025	M10X30*	100	55210.100.030
M6X30	200	55210.060.030	M8X30	100	55210.080.030	M10X35*	100	55210.100.035
M6X35	100	55210.060.035	M8X35	100	55210.080.035	M10X40*	100	55210.100.040
M6X40	100	55210.060.040	M8X40	100	55210.080.040	M10X45*	100	55210.100.045
M6X45	100	55210.060.045	M8X45*	200	55210.080.045	M10X50*	100	55210.100.050
M6X50	100	55210.060.050	M8X50	100	55210.080.050	M10X60*	100	55210.100.060
M6X60	100	55210.060.060	M8X60	100	55210.080.060			
M6X70	100	55210.060.070	M8X70*	100	55210.080.070			

48180 Wkręty z łbem stożkowym soczewkowym z nacięciem prostym

Gwint	Metryczny							
Materiał	Mosiądz Cu2/Cu3							
								
								

d x L	☒	Kod artykułu	d x L	☒	Kod artykułu	d x L	☒	Kod artykułu
M2,5X8	200	48180.025.008	M4X20	200	48180.040.020	M6X12	200	48180.060.012
M2,5X10	200	48180.025.010	M4X25	200	48180.040.025	M6X16	200	48180.060.016
M2,5X12	200	48180.025.012	M4X30	200	48180.040.030	M6X20	200	48180.060.020
M3X6	200	48180.030.006	M5X8	200	48180.050.008	M6X25	200	48180.060.025
M3X8	200	48180.030.008	M5X10	200	48180.050.010	M6X30	200	48180.060.030
M3X10	200	48180.030.010	M5X12	200	48180.050.012	M6X40	200	48180.060.040
M3X12	200	48180.030.012	M5X16	200	48180.050.016	M6X50	200	48180.060.050
M3X16	200	48180.030.016	M5X20	200	48180.050.020	M6X60	100	48180.060.060
M3X20	200	48180.030.020	M5X25	200	48180.050.025	M8X16	100	48180.080.016
M4X6	200	48180.040.006	M5X30	200	48180.050.030	M8X20	100	48180.080.020
M4X8	200	48180.040.008	M5X35	200	48180.050.035	M8X25	100	48180.080.025
M4X10	200	48180.040.010	M5X40	200	48180.050.040	M8X30	100	48180.080.030
M4X12	200	48180.040.012	M5X50	200	48180.050.050	M8X35	100	48180.080.035
M4X16	200	48180.040.016	M6X10	200	48180.060.010	M8X40	100	48180.080.040

48570 Wkręty z łbem stożkowym soczewkowym z nacięciem prostym

Gwint	Metryczny							
Materiał	Mosiądz Cu2/Cu3							
Obróbka powierzchni	Niklowane							
								

d x L	☒	Kod artykułu	d x L	☒	Kod artykułu	d x L	☒	Kod artykułu
M3X6	200	48570.030.006	M4X25	200	48570.040.025	M5X40	200	48570.050.040
M3X8	200	48570.030.008	M4X30	200	48570.040.030	M5X50	200	48570.050.050
M3X10	200	48570.030.010	M4X35	200	48570.040.035	M6X10	200	48570.060.010
M3X12	200	48570.030.012	M4X40	200	48570.040.040	M6X12	200	48570.060.012
M3X16	200	48570.030.016	M5X8	200	48570.050.008	M6X16	200	48570.060.016
M3X20	200	48570.030.020	M5X10	200	48570.050.010	M6X20	200	48570.060.020
M4X6	200	48570.040.006	M5X12	200	48570.050.012	M6X25	200	48570.060.025
M4X8	200	48570.040.008	M5X16	200	48570.050.016	M6X30	200	48570.060.030
M4X10	200	48570.040.010	M5X20	200	48570.050.020	M6X40	200	48570.060.040
M4X12	200	48570.040.012	M5X25	200	48570.050.025	M6X50	200	48570.060.050
M4X16	200	48570.040.016	M5X30	200	48570.050.030	M6X60	100	48570.060.060
M4X20	200	48570.040.020	M5X35	200	48570.050.035			

6

Wkręty z łbem kulistym z nacięciem prostym, BSW

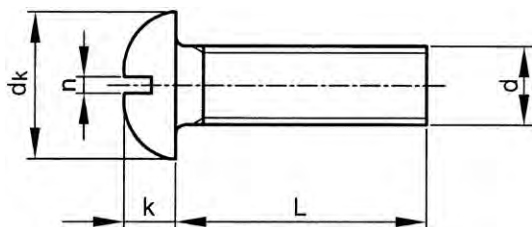

BS ≈450 (1958)
NEN ≈1779 (1960)

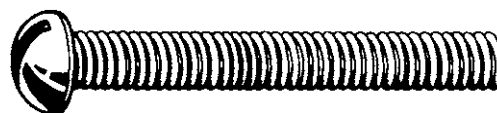

Informacje techniczne

d	dk	k	n	Zwoje gwintu na cal
1/8	5.5	2.1	0.8	40
5/32	7	2.7	0.9	32
3/16	8.3	3.2	1.1	24
1/4	11	4.3	1.3	20
5/16	13.5	5.4	1.5	18
3/8	16.5	6.5	1.8	16

- Gwint Whitworth'a (BSW/BSF) nie jest zalecany do międzynarodowego stosowania. Zaleca się stosowanie gwintu metrycznego (M/MF) lub zunifikowanego (UNC/UNF).
- Długości przekraczające 2 cale są gwintowane częściowo, min. długość gwintu to 1.3/4 cala.

Grupy katalogowe

Gwint	Gniazdo	Materiał	Klasa	Kod	Strona
BSW	Szczelina	Stal	4.8	24210	6-31
BSW	Szczelina	Mosiądz Cu2		48210	6-31

6

24210 Wkręty z łbem kulistym z nacięciem prostym, BSW		X07A
Gwint	Calowy, Whitworth'a (BSW)	
Materiał	Stal	
Klasa	4.8	

d x L	☒	Kod artykułu	d x L	☒	Kod artykułu	d x L	☒	Kod artykułu
1/8X3/8	100	24210.031.009	3/16X3/8	100	24210.047.009	1/4X1.1/4	100	24210.063.031
1/8X1/2	100	24210.031.012	3/16X1/2	100	24210.047.012	1/4X1.1/2	100	24210.063.038
1/8X5/8	100	24210.031.015	3/16X5/8	100	24210.047.015	1/4X2 Inch	100	24210.063.050
1/8X3/4	100	24210.031.019	3/16X3/4	100	24210.047.019	1/4X2.1/2	100	24210.063.063
1/8X1 Inch	100	24210.031.025	3/16X1 Inch	100	24210.047.025	1/4X3 Inch	100	24210.063.076
1/8X1.1/4	100	24210.031.031	3/16X1.1/4	100	24210.047.031			
1/8X1.1/2	100	24210.031.038	3/16X1.1/2	100	24210.047.038	5/16X5/8	100	24210.079.015
			3/16X2 Inch	100	24210.047.050	5/16X3/4	100	24210.079.019
5/32X1/2	100	24210.039.012				5/16X1 Inch	100	24210.079.025
5/32X5/8	100	24210.039.015	1/4X3/8	100	24210.063.009	5/16X1.1/4	100	24210.079.031
5/32X3/4	100	24210.039.019	1/4X1/2	100	24210.063.012	5/16X1.1/2	100	24210.079.038
5/32X1 Inch	100	24210.039.025	1/4X5/8	100	24210.063.015	5/16X2 Inch	50	24210.079.050
5/32X1.1/2	100	24210.039.038	1/4X3/4	100	24210.063.019	5/16X2.1/2	50	24210.079.063
			1/4X1 Inch	100	24210.063.025	5/16X3 Inch	50	24210.079.076
3/16X1/4	100	24210.047.006						

48210 Wkręty z łbem kulistym z nacięciem prostym, BSW		X07A
Gwint	Calowy, Whitworth'a (BSW)	
Materiał	Mosiądz Cu2	

d x L	☒	Kod artykułu	d x L	☒	Kod artykułu	d x L	☒	Kod artykułu
1/8X3/8	100	48210.031.009	3/16X3/8	100	48210.047.009	1/4X5/8	100	48210.063.015
1/8X1/2	100	48210.031.012	3/16X1/2	100	48210.047.012	1/4X3/4	100	48210.063.019
1/8X5/8	100	48210.031.015	3/16X1/2	100	48210.047.012	1/4X1 Inch	100	48210.063.025
1/8X3/4	100	48210.031.019	3/16X5/8	100	48210.047.015	1/4X1.1/4	100	48210.063.031
1/8X1 Inch	100	48210.031.025	3/16X3/4	100	48210.047.019	1/4X1.1/2	100	48210.063.038
1/8X1.1/4	144	48210.031.031	3/16X1 Inch	100	48210.047.025	1/4X2 Inch	100	48210.063.050
			3/16X1.1/4	100	48210.047.031	1/4X2.1/2	100	48210.063.063
5/32X1/2	100	48210.039.012	3/16X1.1/2	100	48210.047.038	1/4X3 Inch	100	48210.063.076
5/32X5/8	100	48210.039.015	3/16X2 Inch	100	48210.047.050			
5/32X3/4	100	48210.039.019				5/16X5/8	100	48210.079.015
5/32X1 Inch	100	48210.039.025	1/4X3/8	100	48210.063.009	5/16X3/4	100	48210.079.019
5/32X1.1/4	100	48210.039.031	1/4X1/2	100	48210.063.012	5/16X1 Inch	100	48210.079.025

48210 Wkręty z łbem kulistym z nacięciem prostym, BSW								
d x L	☒	Kod artykułu	d x L	☒	Kod artykułu	d x L	☒	Kod artykułu
5/16X1.1/4	50	48210.079.031				3/8X2 Inch	50	48210.096.050
5/16X1.1/2	50	48210.079.038	3/8X3/4	50	48210.096.019	3/8X2.1/2	50	48210.096.063
5/16X2 Inch	50	48210.079.050	3/8X1 Inch	50	48210.096.025	3/8X3 Inch	50	48210.096.076
5/16X2.1/2	50	48210.079.063	3/8X1.1/4	50	48210.096.031			
5/16X3 Inch	50	48210.079.076	3/8X1.1/2	50	48210.096.038			

Wkręty z łbem grzybkowym z nacięciem prostym

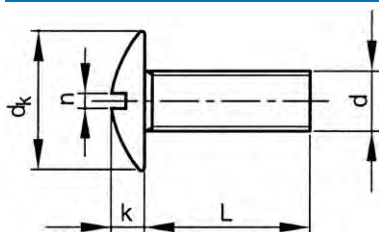

NF ≈E25-129

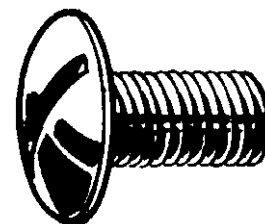

Informacje techniczne

d	dk (maks.)	k (maks.)	n	P
M3	7	2	0.8	0.5
M4	10	2.2	1.2	0.7
M5	12.5	2.7	1.2	0.8
M6	15	3.3	1.6	1
M8	20	4.4	2.0	1.25

Grupy katalogowe

Gwint	Gniazdo	Materiał	Klasa	Kolor	Kod	Strona
M	Szczelina	St.St. A2			51215	6-32
M	Szczelina	Plastik PA	PA 6.6	Biały	56460	6-33

51215 Wkręty z łbem grzybkowym z nacięciem prostym		R02A
Gwint	Metryczny	
Materiał	Stal nierdzewna A2	

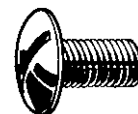

d x L	☒	Kod artykułu	d x L	☒	Kod artykułu	d x L	☒	Kod artykułu
M3X5*	1000	51215.030.005				M6X45*	200	51215.060.045
M3X6*	1000	51215.030.006	M5X8	200	51215.050.008	M6X50*	200	51215.060.050
M3X8*	1000	51215.030.008	M5X10	200	51215.050.010	M6X60*	200	51215.060.060
M3X10*	1000	51215.030.010	M5X12	200	51215.050.012	M6X70*	200	51215.060.070
M3X12*	1000	51215.030.012	M5X16	200	51215.050.016	M6X80*	200	51215.060.080
M3X16*	1000	51215.030.016	M5X20	200	51215.050.020	M6X90*	200	51215.060.090
M3X20*	1000	51215.030.020	M5X25	200	51215.050.025	M6X100*	200	51215.060.100
M3X25*	1000	51215.030.025	M5X30	200	51215.050.030			
M3X35*	1000	51215.030.035	M5X40*	500	51215.050.040	M8X12*	200	51215.080.012
M3X40*	1000	51215.030.040	M5X45*	500	51215.050.045	M8X16*	200	51215.080.016
			M5X50*	500	51215.050.050	M8X20	200	51215.080.020
M4X6*	500	51215.040.006	M5X60*	500	51215.050.060	M8X25*	200	51215.080.025
M4X8	200	51215.040.008	M5X70*	500	51215.050.070	M8X30*	200	51215.080.030
M4X10	200	51215.040.010	M5X80*	500	51215.050.080	M8X35*	200	51215.080.035
M4X12	200	51215.040.012	M5X100*	500	51215.050.100	M8X40*	200	51215.080.040
M4X16	200	51215.040.016				M8X45*	200	51215.080.045
M4X20	200	51215.040.020	M6X8*	500	51215.060.008	M8X50*	200	51215.080.050
M4X25	200	51215.040.025	M6X10	200	51215.060.010	M8X60*	100	51215.080.060
M4X30*	500	51215.040.030	M6X12	200	51215.060.012	M8X70*	100	51215.080.070
M4X35*	500	51215.040.035	M6X16	200	51215.060.016	M8X80*	100	51215.080.080
M4X40*	500	51215.040.040	M6X20	100	51215.060.020	M8X90*	100	51215.080.090
M4X45*	500	51215.040.045	M6X25	100	51215.060.025	M8X100*	100	51215.080.100
M4X50*	500	51215.040.050	M6X30	100	51215.060.030	M8X120*	100	51215.080.120
M4X60*	500	51215.040.060	M6X35*	200	51215.060.035			
M4X70*	500	51215.040.070	M6X40*	200	51215.060.040			

56460	Wkręty z łbem grzybkowym z nacięciem prostym		W02A
Gwint	Metryczny		
Materiał	Plastik Poliamid (nylon)		
Klasa	PA 6.6		
Kolor	Biały		

d x L	☒	Kod artykułu	d x L	☒	Kod artykułu	d x L	☒	Kod artykułu
M6X12	50	56460.060.012	M6X25	50	56460.060.025	M6X40	50	56460.060.040
M6X16	50	56460.060.016	M6X30	50	56460.060.030	M6X50	50	56460.060.050
M6X20	50	56460.060.020						

Wkręty z łbem walcowym z otworami z nacięciem prostym

DIN 404

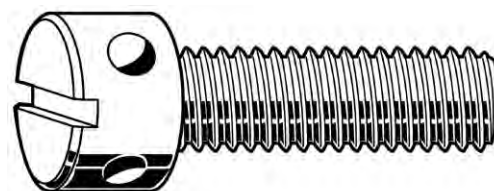
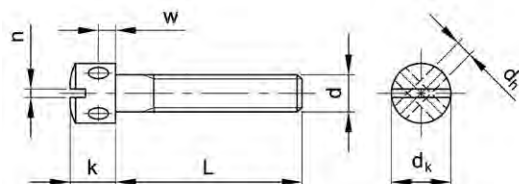

Informacje techniczne						
d	dh (min.)	dk (maks.)	k (maks.)	n	P	w
M3	1.5	5.5	4	0.8	0.5	1.5
M4	2	7	5	1	0.7	2
M5	2.5	8.5	6.5	1.2	0.8	2.5
M6	3	10	8	1.6	1	3

6

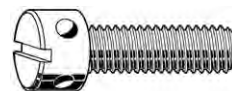
51289	Wkręty z łbem walcowym z otworami z nacięciem prostym		R09A
Gwint	Metryczny		
Materiał	Stal nierdzewna A2		
Klasa	50		



d x L	☒	Kod artykułu	d x L	☒	Kod artykułu	d x L	☒	Kod artykułu
M3X4*	200	51289.030.004	M4X8*	100	51289.040.008	M5X16*	50	51289.050.016
M3X5*	200	51289.030.005	M4X10*	100	51289.040.010	M5X20*	50	51289.050.020
M3X6*	200	51289.030.006	M4X12*	100	51289.040.012	M5X25*	50	51289.050.025
M3X8*	200	51289.030.008	M4X16*	100	51289.040.016	M5X30*	50	51289.050.030
M3X10*	200	51289.030.010	M4X20*	100	51289.040.020			
M3X12*	200	51289.030.012	M4X25*	100	51289.040.025	M6X10*	50	51289.060.010
M3X16*	200	51289.030.016	M4X30*	100	51289.040.030	M6X12*	50	51289.060.012
M3X20*	200	51289.030.020				M6X16*	50	51289.060.016
			M5X8*	50	51289.050.008	M6X20*	50	51289.060.020
M4X5*	100	51289.040.005	M5X10*	50	51289.050.010	M6X25*	50	51289.060.025
M4X6*	100	51289.040.006	M5X12*	50	51289.050.012	M6X30*	50	51289.060.030

Wkręty z trzpieniem walcowym z czopem gwintowanym z nacięciem prostym

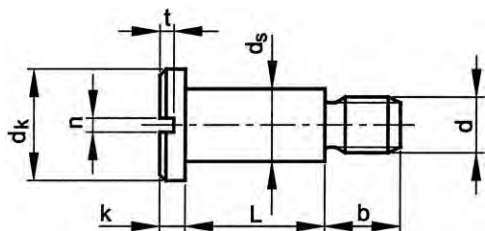

DIN 923

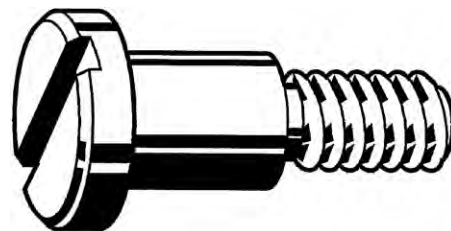

Informacje techniczne

d	b	dk (maks.)	ds (h9)	k	n	P	t (min.)
M2	3	4.5	2.8	1.2	0.5	0.4	0.6
M3	4.5	7	4	1.8	0.8	0.5	0.9
M4	6	8.5	5.5	2.4	1	0.7	1.2
M5	7	11	7	2.7	1.2	0.8	1.3
M6	9	13	8	3.1	1.6	1	1.5
M8	11	16	10	3.8	2	1.25	1.9

Grupy katalogowe

Gwint	Gniazdo	Materiał	Klasa	Obróbka powierzchni	Kod	Strona
M	Szczelina	St	5.8	Ocynk.	24992	6-34
M	Szczelina	St.St. A1			51209	6-34

6

24992		Wkręty z trzpieniem walcowym z czopem gwintowanym z nacięciem prostym					H07A
Gwint	Metryczny						
Materiał	Stal						
Klasa	5.8						
Obróbka powierzchni	Ocynkowane						



d x L	☒	Kod artykułu	d x L	☒	Kod artykułu	d x L	☒	Kod artykułu
M3X8	100	24992.030.008	M5X6	100	24992.050.006	M6X16	100	24992.060.016
M3X10	100	24992.030.010	M5X8	100	24992.050.008	M6X20	100	24992.060.020
M3X12	100	24992.030.012	M5X12	100	24992.050.012	M6X25	100	24992.060.025
M4X6	100	24992.040.006	M5X16	100	24992.050.016	M8X8	100	24992.080.008
M4X8	100	24992.040.008	M5X20	100	24992.050.020	M8X10	100	24992.080.010
M4X10	100	24992.040.010	M5X25	100	24992.050.025	M8X12	100	24992.080.012
M4X12	100	24992.040.012	M6X8	100	24992.060.008	M8X16	100	24992.080.016
M4X16	100	24992.040.016	M6X10	100	24992.060.010	M8X20	50	24992.080.020
			M6X12	100	24992.060.012	M8X25	50	24992.080.025

51209		Wkręty z trzpieniem walcowym z czopem gwintowanym z nacięciem prostym					R09A
Gwint	Metryczny						
Materiał	Stal nierdzewna A1						



d x L	☒	Kod artykułu	d x L	☒	Kod artykułu	d x L	☒	Kod artykułu
M2X6*	100	51209.020.006	M4X12*	100	51209.040.012	M6X5*	50	51209.060.005
M3X2*	100	51209.030.002	M4X16*	100	51209.040.016	M6X6*	50	51209.060.006
M3X3*	100	51209.030.003	M4X20*	100	51209.040.020	M6X8*	50	51209.060.008
M3X4*	100	51209.030.004	M5X2*	100	51209.050.002	M6X10*	50	51209.060.010
M3X5*	100	51209.030.005	M5X3*	100	51209.050.003	M6X12*	50	51209.060.012
M3X6*	100	51209.030.006	M5X4*	100	51209.050.004	M6X16*	50	51209.060.016
M3X8*	100	51209.030.008	M5X5*	100	51209.050.005	M6X20*	50	51209.060.020
M3X10*	100	51209.030.010	M5X6*	100	51209.050.006	M6X25*	50	51209.060.025
M4X2*	100	51209.040.002	M5X8*	100	51209.050.008	M8X5*	50	51209.080.005
M4X3*	100	51209.040.003	M5X10*	100	51209.050.010	M8X6*	50	51209.080.006
M4X4*	100	51209.040.004	M5X12*	100	51209.050.012	M8X8*	50	51209.080.008
M4X5*	100	51209.040.005	M5X16*	100	51209.050.016	M8X10*	50	51209.080.010
M4X6*	100	51209.040.006	M6X3*	50	51209.060.003	M8X12*	50	51209.080.012
M4X8*	100	51209.040.008	M6X4*	50	51209.060.004	M8X16*	50	51209.080.016
M4X10*	100	51209.040.010				M8X20*	50	51209.080.020

Wkręty z łbem sześciokątnym z nacięciem prostym z niespadającą podkładką okrągłą

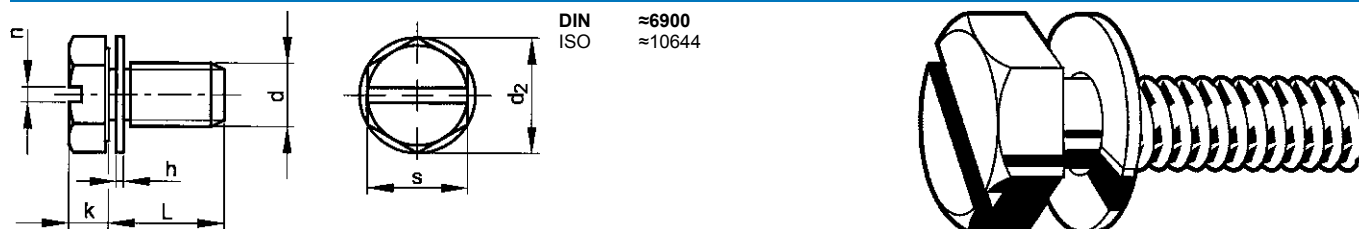

DIN ≈6900
ISO ≈10644

Informacje techniczne

d	d ₂	h	k	n	P	s
M4	8	0.8	2.8	1.2	0.7	7
M5	10	1	3.5	1.2	0.8	8
M6	12	1.2	4	1.6	1	10

24904 Wkręty z łbem sześciokątnym z nacięciem prostym z niespadającą podkładką okrągłą

H05A

Gwint Metryczny
Materiał Stal
Klasa 5.8
Obróbka powierzchni O cynkowane, po żółtej pasywacji

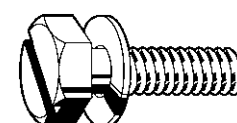

d x L	☒	Kod artykułu	d x L	☒	Kod artykułu	d x L	☒	Kod artykułu
M4X10	1000	24904.040.010	M5X12	1000	24904.050.012	M6X12	500	24904.060.012
M4X16	1000	24904.040.016	M5X18	500	24904.050.018	M6X18	500	24904.060.018

6

Wkręty z łbem walcowym soczewkowym z gniazdem krzyżowym

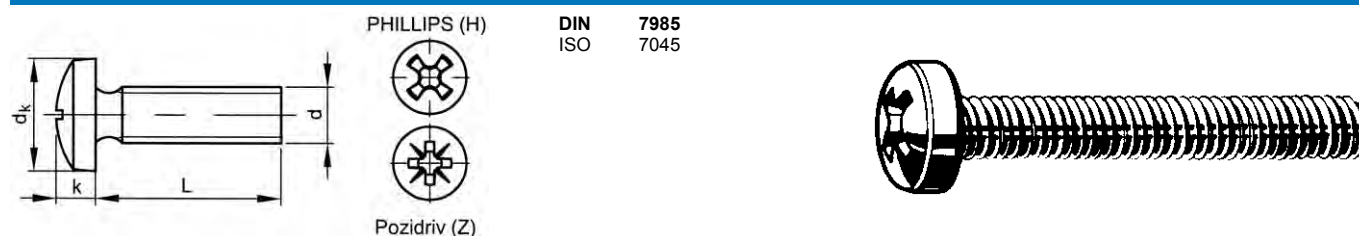

PHILLIPS (H)

DIN 7985
ISO 7045



Pozidriv (Z)

Informacje techniczne



d	d _k	k	Nr wgłębienia krzyżowego	P	Pełen gwint L ≤
M1.6	3.2	1.3	0	0.35	16
M2	4	1.6	1	0.4	16
M2.5	5	2	1	0.45	20
M3	6	2.4	1	0.5	20
M4	8	3.1	2	0.7	25
M5	10	3.8	2	0.8	25
M6	12	4.6	3	1	35
M8	16	6	4	1.25	40
M10	20	7.5	4	1.5	40

Grupy katalogowe

Gwint	Gniazdo	Materiał	Klasa	Obróbka powierzchni	Kod	Strona
M	Phillips	St	4.8	O cynk.	24665	6-36
M	Phillips	St	4.8	O cynk.	Duże Opakowanie 24660	6-36
M	Pozidriv	St	4.8	O cynk.	24662	6-37
M	Phillips	St	4.8	O cynk. żłt. pas.	24800	6-37
M	Phillips	St	4.8	O cynk. czrn. pas.	24810	6-37
M	Phillips	St.St. A2			51340	6-38
M	Pozidriv	St.St. A2			51342	6-38
M	Phillips	St.St. A4			55340	6-39
M	Pozidriv	St.St. A4			55342	6-40
M	Pozidriv	Al P65		Anod.	45445	6-40

24665 Wkręty z łbem walcowym soczewkowym z gniazdem krzyżowym Phillips				H05A
Gwint	Metryczny	DIN	7985-H	 
Materiał	Stal	ISO	7045-H	
Klasa	4.8			
Obróbka powierzchni	Ocynkowane			

d x L	☒	Kod artykułu	d x L	☒	Kod artykułu	d x L	☒	Kod artykułu
M2X4	200	24665.020.004	M4X5	200	24665.040.005	M5X45	100	24665.050.045
M2X5	200	24665.020.005	M4X6	200	24665.040.006	M5X50	100	24665.050.050
M2X6	200	24665.020.006	M4X8	200	24665.040.008	M5X60	100	24665.050.060
M2X8	200	24665.020.008	M4X10	200	24665.040.010	M5X70	100	24665.050.070
M2X10	200	24665.020.010	M4X12	200	24665.040.012	M5X80	100	24665.050.080
			M4X16	200	24665.040.016			
M2,5X4	200	24665.025.004	M4X20	200	24665.040.020	M6X8	200	24665.060.008
M2,5X5	200	24665.025.005	M4X25	200	24665.040.025	M6X10	200	24665.060.010
M2,5X6	200	24665.025.006	M4X30	200	24665.040.030	M6X12	200	24665.060.012
M2,5X8	200	24665.025.008	M4X35	200	24665.040.035	M6X16	200	24665.060.016
M2,5X10	200	24665.025.010	M4X40	200	24665.040.040	M6X20	100	24665.060.020
M2,5X12	200	24665.025.012	M4X45	200	24665.040.045	M6X25	100	24665.060.025
			M4X50	200	24665.040.050	M6X30	100	24665.060.030
M3X4	200	24665.030.004	M4X60	200	24665.040.060	M6X35	100	24665.060.035
M3X5	200	24665.030.005	M4X80	200	24665.040.080	M6X40	100	24665.060.040
M3X6	200	24665.030.006				M6X45	100	24665.060.045
M3X8	200	24665.030.008	M5X6	200	24665.050.006	M6X50	100	24665.060.050
M3X10	200	24665.030.010	M5X8	200	24665.050.008	M6X60	100	24665.060.060
M3X12	200	24665.030.012	M5X10	200	24665.050.010	M6X70	100	24665.060.070
M3X16	200	24665.030.016	M5X12	200	24665.050.012			
M3X20	200	24665.030.020	M5X16	200	24665.050.016	M8X12	100	24665.080.012
M3X25	200	24665.030.025	M5X20	200	24665.050.020	M8X16	100	24665.080.016
M3X30	200	24665.030.030	M5X25	200	24665.050.025	M8X20	100	24665.080.020
M3X40	200	24665.030.040	M5X30	100	24665.050.030	M8X25	100	24665.080.025
M3X50	200	24665.030.050	M5X35	100	24665.050.035	M8X30	100	24665.080.030
			M5X40	100	24665.050.040	M8X35	100	24665.080.035

24660 Wkręty z łbem walcowym soczewkowym z gniazdem krzyżowym Phillips				H05A
Gwint	Metryczny	DIN	7985-H	 
Materiał	Stal	ISO	7045-H	
Klasa	4.8			
Obróbka powierzchni	Ocynkowane			

d x L	☒	Kod artykułu	d x L	☒	Kod artykułu	d x L	☒	Kod artykułu
M2X4	2000	24660.020.004	M4X6	1000	24660.040.006	M6X12	1000	24660.060.012
M2X5	2000	24660.020.005	M4X8	1000	24660.040.008	M6X16	500	24660.060.016
M2X6	2000	24660.020.006	M4X10	1000	24660.040.010	M6X20	250	24660.060.020
M2X8	2000	24660.020.008	M4X12	1000	24660.040.012	M6X25	250	24660.060.025
M2X10	2000	24660.020.010	M4X16	1000	24660.040.016	M6X30	250	24660.060.030
M2X20	2000	24660.020.020	M4X20	1000	24660.040.020	M6X35	250	24660.060.035
			M4X25	1000	24660.040.025	M6X40	250	24660.060.040
M2,5X4	2000	24660.025.004	M4X30	1000	24660.040.030	M6X45	250	24660.060.045
M2,5X5	2000	24660.025.005	M4X35	500	24660.040.035	M6X50	250	24660.060.050
M2,5X6	2000	24660.025.006	M4X40	500	24660.040.040	M6X60	250	24660.060.060
M2,5X8	2000	24660.025.008	M4X45	500	24660.040.045			
M2,5X10	2000	24660.025.010	M4X50	500	24660.040.050	M8X12	250	24660.080.012
M2,5X12	2000	24660.025.012				M8X16	250	24660.080.016
			M5X8	1000	24660.050.008	M8X20	250	24660.080.020
M3X4	2000	24660.030.004	M5X10	1000	24660.050.010	M8X25	250	24660.080.025
M3X5	2000	24660.030.005	M5X12	1000	24660.050.012	M8X30	250	24660.080.030
M3X6	2000	24660.030.006	M5X16	1000	24660.050.016	M8X35	250	24660.080.035
M3X8	2000	24660.030.008	M5X20	500	24660.050.020	M8X40	100	24660.080.040
M3X10	2000	24660.030.010	M5X25	500	24660.050.025	M8X45	100	24660.080.045
M3X12	2000	24660.030.012	M5X30	250	24660.050.030	M8X50	100	24660.080.050
M3X14	2000	24660.030.014	M5X35	250	24660.050.035	M8X60	100	24660.080.060
M3X16	2000	24660.030.016	M5X40	250	24660.050.040			
M3X20	2000	24660.030.020	M5X45	250	24660.050.045	M10X25	100	24660.100.025
M3X25	1000	24660.030.025	M5X50	250	24660.050.050	M10X30	100	24660.100.030
M3X30	1000	24660.030.030	M5X60	250	24660.050.060	M10X40	100	24660.100.040
M3X40	1000	24660.030.040				M10X50	100	24660.100.050
			M6X8	1000	24660.060.008	M10X60	100	24660.100.060
M4X5	1000	24660.040.005	M6X10	1000	24660.060.010			

24662 Wkręty z łbem walcowym soczewkowym z gniazdem krzyżowym Pozidriv				H05A
Gwint	Metryczny	DIN	7985-Z	
Materiał	Stal	ISO	7045-Z	
Klasa	4.8			
Obróbka powierzchni	Ocynkowane			



d x L	☒	Kod artykułu	d x L	☒	Kod artykułu	d x L	☒	Kod artykułu
M3X6	2000	24662.030.006	M4X30	1000	24662.040.030	M6X12	1000	24662.060.012
M3X8	2000	24662.030.008	M4X35	500	24662.040.035	M6X16	500	24662.060.016
M3X10	2000	24662.030.010	M4X40	500	24662.040.040	M6X20	250	24662.060.020
M3X12	2000	24662.030.012				M6X25	250	24662.060.025
M3X16	2000	24662.030.016	M5X8	1000	24662.050.008	M6X30	250	24662.060.030
M3X20	2000	24662.030.020	M5X10	1000	24662.050.010	M6X35	250	24662.060.035
M3X25	1000	24662.030.025	M5X12	1000	24662.050.012	M6X40	250	24662.060.040
M3X30	1000	24662.030.030	M5X16	1000	24662.050.016	M6X50	250	24662.060.050
			M5X20	500	24662.050.020	M6X60	250	24662.060.060
M4X5	1000	24662.040.005	M5X25	500	24662.050.025			
M4X6	1000	24662.040.006	M5X30	250	24662.050.030	M8X16	250	24662.080.016
M4X8	1000	24662.040.008	M5X35	250	24662.050.035	M8X20	250	24662.080.020
M4X10	1000	24662.040.010	M5X40	250	24662.050.040	M8X25	250	24662.080.025
M4X12	1000	24662.040.012	M5X45	250	24662.050.045	M8X30	250	24662.080.030
M4X16	1000	24662.040.016	M5X50	250	24662.050.050	M8X40	100	24662.080.040
M4X20	1000	24662.040.020				M8X50	100	24662.080.050
M4X25	1000	24662.040.025	M6X10	1000	24662.060.010			



24800 Wkręty z łbem walcowym soczewkowym z gniazdem krzyżowym Phillips				H07A
Gwint	Metryczny	DIN	7985-H	
Materiał	Stal	ISO	7045-H	
Klasa	4.8			
Obróbka powierzchni	Ocynkowane, po żółtej pasywacji			

6



d x L	☒	Kod artykułu	d x L	☒	Kod artykułu	d x L	☒	Kod artykułu
M3X6	500	24800.030.006	M4X12	200	24800.040.012	M5X40	200	24800.050.040
M3X8	500	24800.030.008	M4X16	200	24800.040.016			
M3X10	500	24800.030.010	M4X20	200	24800.040.020	M6X10	200	24800.060.010
M3X12	500	24800.030.012	M4X25	200	24800.040.025	M6X12	200	24800.060.012
M3X16	500	24800.030.016	M4X30	200	24800.040.030	M6X16	200	24800.060.016
M3X20	500	24800.030.020				M6X20	200	24800.060.020
M3X25	200	24800.030.025	M5X10	200	24800.050.010	M6X25	200	24800.060.025
M3X30	200	24800.030.030	M5X12	200	24800.050.012	M6X30	100	24800.060.030
			M5X16	200	24800.050.016	M6X40	100	24800.060.040
M4X6	200	24800.040.006	M5X20	200	24800.050.020	M6X50	100	24800.060.050
M4X8	200	24800.040.008	M5X25	200	24800.050.025	M6X60	100	24800.060.060
M4X10	200	24800.040.010	M5X30	200	24800.050.030			

24810 Wkręty z łbem walcowym soczewkowym z gniazdem krzyżowym Phillips				H07A
Gwint	Metryczny	DIN	7985-H	
Materiał	Stal	ISO	7045-H	
Klasa	4.8			
Obróbka powierzchni	Ocynkowane, po czarnej pasywacji			

d x L	☒	Kod artykułu	d x L	☒	Kod artykułu	d x L	☒	Kod artykułu
M3X6	200	24810.030.006	M4X50	200	24810.040.050	M6X20	100	24810.060.020
M3X8	200	24810.030.008				M6X25	100	24810.060.025
M3X10	200	24810.030.010	M5X6	200	24810.050.006	M6X30	100	24810.060.030
M3X12	200	24810.030.012	M5X8	200	24810.050.008	M6X35	100	24810.060.035
M3X16	200	24810.030.016	M5X10	200	24810.050.010	M6X40	100	24810.060.040
M3X20	200	24810.030.020	M5X12	200	24810.050.012	M6X45	100	24810.060.045
M3X25	200	24810.030.025	M5X16	200	24810.050.016	M6X50	100	24810.060.050
M3X30	200	24810.030.030	M5X20	200	24810.050.020	M6X55	100	24810.060.055
			M5X25	200	24810.050.025	M6X60	100	24810.060.060
M4X6	200	24810.040.006	M5X30	100	24810.050.030			
M4X8	200	24810.040.008	M5X35	100	24810.050.035	M8X12	100	24810.080.012
M4X10	200	24810.040.010	M5X40	100	24810.050.040	M8X16	100	24810.080.016
M4X12	200	24810.040.012	M5X45	100	24810.050.045	M8X20	100	24810.080.020
M4X16	200	24810.040.016	M5X50	100	24810.050.050	M8X25	100	24810.080.025
M4X20	200	24810.040.020	M5X60	100	24810.050.060	M8X30	100	24810.080.030
M4X25	200	24810.040.025				M8X35	100	24810.080.035
M4X30	200	24810.040.030	M6X10	200	24810.060.010	M8X40	100	24810.080.040
M4X35	200	24810.040.035	M6X12	200	24810.060.012	M8X50	100	24810.080.050
M4X40	200	24810.040.040	M6X16	200	24810.060.016	M8X60	100	24810.080.060



51340	Wkręty z łbem walcowym soczewkowym z gniazdem krzyżowym Phillips			R01A
Gwint	Metryczny	DIN	7985-H	
Materiał	Stal nierdzewna A2	ISO	7045-H	
				

d x L	☒	Kod artykułu	d x L	☒	Kod artykułu	d x L	☒	Kod artykułu
M1,6X2*	1000	51340.016.002	M3X22*	500	51340.030.022	M5X40	100	51340.050.040
M1,6X3*	1000	51340.016.003	M3X25	200	51340.030.025	M5X45	100	51340.050.045
M1,6X4*	1000	51340.016.004	M3X28*	500	51340.030.028	M5X50	100	51340.050.050
M1,6X5*	1000	51340.016.005	M3X30	200	51340.030.030	M5X55*	200	51340.050.055
M1,6X6*	1000	51340.016.006	M3X35	200	51340.030.035	M5X60	100	51340.050.060
M1,6X8*	1000	51340.016.008	M3X40	200	51340.030.040	M5X65*	200	51340.050.065
M1,6X10*	1000	51340.016.010	M3X45*	200	51340.030.045	M5X70*	200	51340.050.070
M1,6X12*	1000	51340.016.012	M3X48*	200	51340.030.048	M5X75*	200	51340.050.075
M1,6X14*	1000	51340.016.014	M3X50	200	51340.030.050	M5X80	200	51340.050.080
M1,6X16*	1000	51340.016.016	M3X55*	200	51340.030.055	M5X90*	200	51340.050.090
M1,6X18*	1000	51340.016.018	M3X60*	200	51340.030.060	M5X100*	200	51340.050.100
M1,6X20*	1000	51340.016.020						
M2X3*	1000	51340.020.003	M4X4*	500	51340.040.004	M6X8	100	51340.060.008
M2X4	100	51340.020.004	M4X5*	500	51340.040.005	M6X10	100	51340.060.010
M2X5	100	51340.020.005	M4X6	200	51340.040.006	M6X12	100	51340.060.012
M2X6	100	51340.020.006	M4X8	200	51340.040.008	M6X14*	500	51340.060.014
M2X8	100	51340.020.008	M4X10	200	51340.040.010	M6X16	100	51340.060.016
M2X10	100	51340.020.010	M4X12	200	51340.040.012	M6X18*	500	51340.060.018
M2X12	100	51340.020.012	M4X14*	500	51340.040.014	M6X20	100	51340.060.020
M2X14*	1000	51340.020.014	M4X16	200	51340.040.016	M6X22*	500	51340.060.022
M2X16	100	51340.020.016	M4X18*	500	51340.040.018	M6X25	100	51340.060.025
M2X18*	1000	51340.020.018	M4X20	200	51340.040.020	M6X28*	200	51340.060.028
M2X20*	1000	51340.020.020	M4X22*	500	51340.040.022	M6X30	100	51340.060.030
			M4X25	200	51340.040.025	M6X35	100	51340.060.035
			M4X28*	500	51340.040.028	M6X40	100	51340.060.040
M2,5X3*	1000	51340.025.003	M4X30	200	51340.040.030	M6X45	100	51340.060.045
M2,5X4*	1000	51340.025.004	M4X35	200	51340.040.035	M6X50	100	51340.060.050
M2,5X5	100	51340.025.005	M4X40	200	51340.040.040	M6X55	200	51340.060.055
M2,5X6	100	51340.025.006	M4X45	200	51340.040.045	M6X60	100	51340.060.060
M2,5X8	100	51340.025.008	M4X50	200	51340.040.050	M6X65*	200	51340.060.065
M2,5X10	100	51340.025.010	M4X55*	500	51340.040.055	M6X70*	100	51340.060.070
M2,5X12	100	51340.025.012	M4X60	100	51340.040.060	M6X80*	100	51340.060.080
M2,5X14*	1000	51340.025.014	M4X65*	500	51340.040.065	M6X90*	100	51340.060.090
M2,5X16	100	51340.025.016	M4X70*	500	51340.040.070	M6X100*	100	51340.060.100
M2,5X18*	1000	51340.025.018	M4X80*	500	51340.040.080			
M2,5X20	100	51340.025.020	M4X90*	500	51340.040.090	M8X10*	200	51340.080.010
M2,5X22*	500	51340.025.022	M4X100*	500	51340.040.100	M8X12	100	51340.080.012
M2,5X25*	500	51340.025.025				M8X16	100	51340.080.016
M2,5X28*	500	51340.025.028	M5X6	100	51340.050.006	M8X20	100	51340.080.020
M2,5X30*	500	51340.025.030	M5X7*	500	51340.050.007	M8X25	100	51340.080.025
			M5X8	100	51340.050.008	M8X30	100	51340.080.030
M3X3*	500	51340.030.003	M5X10	100	51340.050.010	M8X35	100	51340.080.035
M3X4*	500	51340.030.004	M5X12	100	51340.050.012	M8X40	100	51340.080.040
M3X5	200	51340.030.005	M5X14*	500	51340.050.014	M8X45	100	51340.080.045
M3X6	200	51340.030.006	M5X16	100	51340.050.016	M8X50	100	51340.080.050
M3X8	200	51340.030.008	M5X18*	500	51340.050.018	M8X60	100	51340.080.060
M3X10	200	51340.030.010	M5X20	100	51340.050.020	M8X70*	100	51340.080.070
M3X12	200	51340.030.012	M5X22*	500	51340.050.022	M8X80*	100	51340.080.080
M3X14*	500	51340.030.014	M5X25	100	51340.050.025	M8X90*	100	51340.080.090
M3X16	200	51340.030.016	M5X28*	500	51340.050.028			
M3X18*	500	51340.030.018	M5X30	100	51340.050.030	M10X25*	100	51340.100.025
M3X20	200	51340.030.020	M5X35	100	51340.050.035			

51342	Wkręty z łbem walcowym soczewkowym z gniazdem krzyżowym Pozidriv			R01A
Gwint	Metryczny	DIN	7985-Z	
Materiał	Stal nierdzewna A2	ISO	7045-Z	
				

d x L	☒	Kod artykułu	d x L	☒	Kod artykułu	d x L	☒	Kod artykułu
M1,6X2*	1000	51342.016.002	M2X3	100	51342.020.003	M2,5X3	100	51342.025.003
M1,6X3*	1000	51342.016.003	M2X4	100	51342.020.004	M2,5X4	100	51342.025.004
M1,6X4*	1000	51342.016.004	M2X5	100	51342.020.005	M2,5X5	100	51342.025.005
M1,6X5*	1000	51342.016.005	M2X6	100	51342.020.006	M2,5X6	100	51342.025.006
M1,6X6*	1000	51342.016.006	M2X8	100	51342.020.008	M2,5X8	100	51342.025.008
M1,6X8*	1000	51342.016.008	M2X10	100	51342.020.010	M2,5X10	100	51342.025.010
M1,6X10*	1000	51342.016.010	M2X12	100	51342.020.012	M2,5X12	100	51342.025.012
M1,6X14*	1000	51342.016.014	M2X14*	1000	51342.020.014	M2,5X14	100	51342.025.014
M1,6X16*	1000	51342.016.016	M2X16	100	51342.020.016	M2,5X16	100	51342.025.016
M1,6X20*	1000	51342.016.020	M2X18*	1000	51342.020.018	M2,5X18	100	51342.025.018
			M2X20*	1000	51342.020.020			

51342 Wkręty z łbem walcowym soczewkowym z gniazdem krzyżowym Pozidriv								
d x L	☒	Kod artykułu	d x L	☒	Kod artykułu	d x L	☒	Kod artykułu
M2,5X20	100	51342.025.020	M4X12	200	51342.040.012	M5X40	100	51342.050.040
M2,5X25*	500	51342.025.025	M4X14	200	51342.040.014	M5X45	100	51342.050.045
M2,5X28*	500	51342.025.028	M4X16	200	51342.040.016	M5X50	100	51342.050.050
M2,5X30*	500	51342.025.030	M4X18*	500	51342.040.018	M5X55*	200	51342.050.055
			M4X20	200	51342.040.020	M5X60*	200	51342.050.060
M3X3*	500	51342.030.003	M4X22*	500	51342.040.022	M5X70*	200	51342.050.070
M3X4	200	51342.030.004	M4X25	200	51342.040.025	M5X80*	200	51342.050.080
M3X5	200	51342.030.005	M4X28*	500	51342.040.028	M5X90*	200	51342.050.090
M3X6	200	51342.030.006	M4X30	200	51342.040.030	M5X100*	200	51342.050.100
M3X8	200	51342.030.008	M4X35	200	51342.040.035			
M3X10	200	51342.030.010	M4X40	200	51342.040.040	M6X8	100	51342.060.008
M3X12	200	51342.030.012	M4X45*	500	51342.040.045	M6X10	100	51342.060.010
M3X14	200	51342.030.014	M4X50	200	51342.040.050	M6X12	100	51342.060.012
M3X16	200	51342.030.016	M4X55*	200	51342.040.055	M6X14*	500	51342.060.014
M3X18*	500	51342.030.018	M4X60*	200	51342.040.060	M6X16	100	51342.060.016
M3X20	200	51342.030.020	M4X70*	200	51342.040.070	M6X18*	500	51342.060.018
M3X22*	500	51342.030.022	M4X80*	200	51342.040.080	M6X20	100	51342.060.020
M3X25	200	51342.030.025				M6X25	100	51342.060.025
M3X30	200	51342.030.030	M5X6	100	51342.050.006	M6X30	100	51342.060.030
M3X35	200	51342.030.035	M5X8	100	51342.050.008	M6X35	100	51342.060.035
M3X40	200	51342.030.040	M5X10	100	51342.050.010	M6X40	100	51342.060.040
M3X45*	200	51342.030.045	M5X12	100	51342.050.012	M6X45	100	51342.060.045
M3X50	200	51342.030.050	M5X14*	500	51342.050.014	M6X50	100	51342.060.050
M3X55*	200	51342.030.055	M5X16	100	51342.050.016	M6X55*	200	51342.060.055
M3X60*	200	51342.030.060	M5X18*	500	51342.050.018	M6X60*	200	51342.060.060
			M5X20	100	51342.050.020	M6X70*	100	51342.060.070
M4X4	200	51342.040.004	M5X22*	500	51342.050.022	M6X75*	100	51342.060.075
M4X5	200	51342.040.005	M5X25	100	51342.050.025	M6X80*	100	51342.060.080
M4X6	200	51342.040.006	M5X28*	500	51342.050.028	M6X90*	100	51342.060.090
M4X8	200	51342.040.008	M5X30	100	51342.050.030	M6X100*	100	51342.060.100
M4X10	200	51342.040.010	M5X35	100	51342.050.035			

55340 Wkręty z łbem walcowym soczewkowym z gniazdem krzyżowym Phillips					R41A
Gwint	Material	Metryczny	DIN	7985-H	
		Stal nierdzewna A4	ISO	7045-H	
					
					

d x L	☒	Kod artykułu	d x L	☒	Kod artykułu	d x L	☒	Kod artykułu
M1,6X2*	1000	55340.016.002	M3X8	200	55340.030.008	M5X8	100	55340.050.008
M1,6X3*	1000	55340.016.003	M3X10	200	55340.030.010	M5X10	100	55340.050.010
M1,6X4*	1000	55340.016.004	M3X12	200	55340.030.012	M5X12	100	55340.050.012
M1,6X5*	1000	55340.016.005	M3X14*	500	55340.030.014	M5X14*	500	55340.050.014
M1,6X6*	1000	55340.016.006	M3X16	200	55340.030.016	M5X16	100	55340.050.016
M1,6X8*	1000	55340.016.008	M3X18*	500	55340.030.018	M5X18*	500	55340.050.018
M1,6X10*	1000	55340.016.010	M3X20	200	55340.030.020	M5X20	100	55340.050.020
M1,6X12*	1000	55340.016.012	M3X25	200	55340.030.025	M5X22*	500	55340.050.022
M1,6X16*	1000	55340.016.016	M3X30	200	55340.030.030	M5X25	100	55340.050.025
			M3X35*	500	55340.030.035	M5X30	100	55340.050.030
M2X3*	1000	55340.020.003	M3X40*	500	55340.030.040	M5X35	100	55340.050.035
M2X4	100	55340.020.004	M3X45*	200	55340.030.045	M5X40	100	55340.050.040
M2X5	100	55340.020.005	M3X50*	200	55340.030.050	M5X45	100	55340.050.045
M2X6	100	55340.020.006	M3X60*	500	55340.030.060	M5X50	100	55340.050.050
M2X8	100	55340.020.008				M5X55*	200	55340.050.055
M2X10	100	55340.020.010	M4X4*	500	55340.040.004	M5X60*	200	55340.050.060
M2X12	100	55340.020.012	M4X5	200	55340.040.005	M5X70*	200	55340.050.070
M2X14*	1000	55340.020.014	M4X6	200	55340.040.006	M5X80*	200	55340.050.080
M2X16	100	55340.020.016	M4X8	200	55340.040.008	M5X90*	200	55340.050.090
M2X18*	1000	55340.020.018	M4X10	200	55340.040.010	M5X100*	200	55340.050.100
M2X20*	1000	55340.020.020	M4X12	200	55340.040.012			
			M4X14*	500	55340.040.014	M6X8	100	55340.060.008
M2,5X4	100	55340.025.004	M4X16	200	55340.040.016	M6X10	100	55340.060.010
M2,5X5	100	55340.025.005	M4X18*	500	55340.040.018	M6X12	100	55340.060.012
M2,5X6	100	55340.025.006	M4X20	200	55340.040.020	M6X14*	500	55340.060.014
M2,5X8	100	55340.025.008	M4X22*	500	55340.040.022	M6X16	100	55340.060.016
M2,5X10	100	55340.025.010	M4X25	200	55340.040.025	M6X18*	500	55340.060.018
M2,5X12	100	55340.025.012	M4X30	200	55340.040.030	M6X20	100	55340.060.020
M2,5X14*	1000	55340.025.014	M4X35	200	55340.040.035	M6X22*	500	55340.060.022
M2,5X16	100	55340.025.016	M4X40	200	55340.040.040	M6X25	100	55340.060.025
M2,5X18*	1000	55340.025.018	M4X45*	500	55340.040.045	M6X28*	200	55340.060.028
M2,5X20	100	55340.025.020	M4X50	200	55340.040.050	M6X30	100	55340.060.030
M2,5X25*	500	55340.025.025	M4X55*	500	55340.040.055	M6X35	100	55340.060.035
M2,5X30*	500	55340.025.030	M4X60*	500	55340.040.060	M6X40	100	55340.060.040
			M4X70*	500	55340.040.070	M6X45	100	55340.060.045
M3X3*	500	55340.030.003	M4X80*	500	55340.040.080	M6X50	100	55340.060.050
M3X4	200	55340.030.004	M4X90*	500	55340.040.090	M6X60	200	55340.060.060
M3X5*	500	55340.030.005				M6X65*	200	55340.060.065
M3X6	200	55340.030.006	M5X6*	500	55340.050.006	M6X70	200	55340.060.070

55340 Wkręty z łbem walcowym soczewkowym z gniazdem krzyżowym Phillips

d x L	☒	Kod artykułu	d x L	☒	Kod artykułu	d x L	☒	Kod artykułu
M6X80	200	55340.060.080	M8X16	100	55340.080.016	M8X40	100	55340.080.040
M6X90*	200	55340.060.090	M8X20	100	55340.080.020	M8X45*	200	55340.080.045
M6X100*	200	55340.060.100	M8X25	100	55340.080.025	M8X50	100	55340.080.050
			M8X30	100	55340.080.030	M8X60*	100	55340.080.060
M8X12*	200	55340.080.012	M8X35*	200	55340.080.035			

55342 Wkręty z łbem walcowym soczewkowym z gniazdem krzyżowym Pozidriv

Gwint	Metryczny	DIN	7985-Z		
Materiał	Stal nierdzewna A4	ISO	7045-Z		

d x L	☒	Kod artykułu	d x L	☒	Kod artykułu	d x L	☒	Kod artykułu
M1,6X3*	1000	55342.016.003	M3X8*	500	55342.030.008	M5X10	500	55342.050.010
M1,6X4*	1000	55342.016.004	M3X10*	500	55342.030.010	M5X12*	500	55342.050.012
M1,6X5*	1000	55342.016.005	M3X12*	500	55342.030.012	M5X14*	500	55342.050.014
M1,6X6*	1000	55342.016.006	M3X14*	500	55342.030.014	M5X16*	500	55342.050.016
M1,6X10*	1000	55342.016.010	M3X16*	500	55342.030.016	M5X18*	500	55342.050.018
M1,6X12*	1000	55342.016.012	M3X18*	500	55342.030.018	M5X20*	500	55342.050.020
M1,6X14*	1000	55342.016.014	M3X20*	500	55342.030.020	M5X25*	500	55342.050.025
			M3X22*	500	55342.030.022	M5X30*	500	55342.050.030
M2X3*	1000	55342.020.003	M3X25*	500	55342.030.025	M5X35*	500	55342.050.035
M2X4*	1000	55342.020.004	M3X30*	500	55342.030.030	M5X40*	500	55342.050.040
M2X5*	1000	55342.020.005	M3X35*	500	55342.030.035	M5X45*	200	55342.050.045
M2X6*	1000	55342.020.006	M3X40*	500	55342.030.040	M5X50*	200	55342.050.050
M2X8*	1000	55342.020.008	M3X45*	200	55342.030.045	M5X60*	200	55342.050.060
M2X10*	1000	55342.020.010	M3X50*	200	55342.030.050	M5X70*	200	55342.050.070
M2X12*	1000	55342.020.012	M3X55*	200	55342.030.055	M5X80*	200	55342.050.080
M2X14*	1000	55342.020.014	M3X60*	200	55342.030.060	M5X90*	200	55342.050.090
M2X16*	1000	55342.020.016				M5X100*	200	55342.050.100
M2X18*	1000	55342.020.018	M4X4*	500	55342.040.004			
M2X20*	1000	55342.020.020	M4X5*	500	55342.040.005	M6X8*	500	55342.060.008
			M4X6	500	55342.040.006	M6X10*	500	55342.060.010
M2,5X3*	1000	55342.025.003	M4X8*	500	55342.040.008	M6X12*	500	55342.060.012
M2,5X4*	1000	55342.025.004	M4X10	500	55342.040.010	M6X16*	500	55342.060.016
M2,5X5*	1000	55342.025.005	M4X12	500	55342.040.012	M6X20*	500	55342.060.020
M2,5X6*	1000	55342.025.006	M4X14*	500	55342.040.014	M6X25*	200	55342.060.025
M2,5X8*	1000	55342.025.008	M4X16	500	55342.040.016	M6X30*	200	55342.060.030
M2,5X10*	1000	55342.025.010	M4X18*	500	55342.040.018	M6X35*	200	55342.060.035
M2,5X12*	1000	55342.025.012	M4X20*	500	55342.040.020	M6X40*	200	55342.060.040
M2,5X14*	1000	55342.025.014	M4X25*	500	55342.040.025	M6X45*	200	55342.060.045
M2,5X16*	1000	55342.025.016	M4X30*	500	55342.040.030	M6X50*	200	55342.060.050
M2,5X18*	1000	55342.025.018	M4X35*	500	55342.040.035	M6X55*	200	55342.060.055
M2,5X20*	1000	55342.025.020	M4X40*	500	55342.040.040	M6X60*	200	55342.060.060
M2,5X25*	500	55342.025.025	M4X45*	500	55342.040.045	M6X65*	100	55342.060.065
M2,5X30*	500	55342.025.030	M4X50*	500	55342.040.050	M6X70*	100	55342.060.070
			M4X55*	200	55342.040.055	M6X75*	100	55342.060.075
M3X3*	500	55342.030.003	M4X60*	200	55342.040.060	M6X80*	100	55342.060.080
M3X4*	500	55342.030.004				M6X90*	100	55342.060.090
M3X5*	500	55342.030.005	M5X6*	500	55342.050.006	M6X100*	100	55342.060.100
M3X6*	500	55342.030.006	M5X8*	500	55342.050.008			

45445 Wkręty z łbem walcowym soczewkowym z gniazdem krzyżowym Pozidriv

Gwint	Metryczny	DIN	≈7985-Z	
Materiał	Aluminium P65	ISO	≈7045-Z	
Obróbka powierzchni	Anodyzowane			

d x L	☒	Kod artykułu	d x L	☒	Kod artykułu	d x L	☒	Kod artykułu
M3X10	200	45445.030.010	M4X30	200	45445.040.030	M6X12	200	45445.060.012
M3X12	200	45445.030.012				M6X16	200	45445.060.016
M3X16	200	45445.030.016	M5X10	200	45445.050.010	M6X20	200	45445.060.020
M3X20	200	45445.030.020	M5X12	200	45445.050.012	M6X30	200	45445.060.030
			M5X16	200	45445.050.016	M6X35	200	45445.060.035
M4X12	200	45445.040.012	M5X20	200	45445.050.020	M6X40	200	45445.060.040
M4X16	200	45445.040.016	M5X25	200	45445.050.025			
M4X20	200	45445.040.020	M5X30	200	45445.050.030			
M4X25	200	45445.040.025	M5X40	200	45445.050.040			

Wkręty z łbem walcowym soczewkowym z gniazdem sześciokąrnym

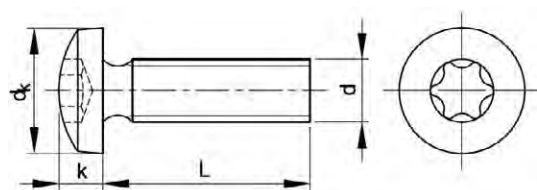

ISO 14583

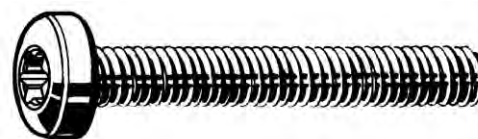

Informacje techniczne

d	dk	k	Nasadka	P
M1.6	3.2	1.3	T5	0.35
M2	4	1.6	T6	0.4
M2.5	5	2.1	T8	0.45
M3	5.6	2.4	T10	0.5
M3.5	7	2.6	T15	0.6
M4	8	3.1	T20	0.7
M5	9.5	3.7	T25	0.8
M6	12	4.6	T30	1
M8	16	6	T45	1.25
M10	20	7.5	T50	1.5

Grupy katalogowe

Gwint	Gniazdo	Materiał	Klasa	Obróbka powierzchni	Kod	Strona
M	Sześciokąrnym	St	8.8	Ocynk.	24422	6-41
M	Sześciokąrnym	St.St. A2			51345	6-41
M	Sześciokąrnym	St.St. A4			55345	6-42

6

24422 Wkręty z łbem walcowym soczewkowym z gniazdem sześciokąrnym

H07A

Gwint Metryczny
Materiał Stal
Klasa 8.8
Obróbka powierzchni Ocynkowane



d x L	☒	Kod artykułu	d x L	☒	Kod artykułu	d x L	☒	Kod artykułu
M4X8	200	24422.040.008	M5X8	200	24422.050.008	M6X10	200	24422.060.010
M4X10	200	24422.040.010	M5X10	200	24422.050.010	M6X12	200	24422.060.012
M4X12	200	24422.040.012	M5X12	200	24422.050.012	M6X16	200	24422.060.016
M4X16	200	24422.040.016	M5X16	200	24422.050.016	M6X20	200	24422.060.020
M4X20	200	24422.040.020	M5X20	200	24422.050.020			

51345 Wkręty z łbem walcowym soczewkowym z gniazdem sześciokąrnym

R01A

Gwint Metryczny
Materiał Stal nierdzewna A2



d x L	☒	Kod artykułu	d x L	☒	Kod artykułu	d x L	☒	Kod artykułu
M1,6X2*	1000	51345.016.002	M2X16*	1000	51345.020.016	M2,5X30*	500	51345.025.030
M1,6X3*	1000	51345.016.003	M2X18*	1000	51345.020.018	M3X3*	500	51345.030.003
M1,6X4*	1000	51345.016.004	M2X20*	1000	51345.020.020	M3X4*	500	51345.030.004
M1,6X5*	1000	51345.016.005				M3X5	500	51345.030.005
M1,6X6*	1000	51345.016.006	M2,5X3*	1000	51345.025.003	M3X6	200	51345.030.006
M1,6X8*	1000	51345.016.008	M2,5X4	1000	51345.025.004	M3X8	200	51345.030.008
M1,6X10*	1000	51345.016.010	M2,5X5*	1000	51345.025.005	M3X10	200	51345.030.010
M1,6X12*	1000	51345.016.012	M2,5X6	1000	51345.025.006	M3X12	200	51345.030.012
M1,6X16*	1000	51345.016.016	M2,5X8*	1000	51345.025.008	M3X14*	500	51345.030.014
			M2,5X10	1000	51345.025.010	M3X16	200	51345.030.016
M2X3*	1000	51345.020.003	M2,5X12*	1000	51345.025.012	M3X18*	500	51345.030.018
M2X4*	1000	51345.020.004	M2,5X14*	1000	51345.025.014	M3X20	200	51345.030.020
M2X5*	1000	51345.020.005	M2,5X16*	1000	51345.025.016	M3X22*	500	51345.030.022
M2X6	1000	51345.020.006	M2,5X18*	1000	51345.025.018	M3X25*	500	51345.030.025
M2X8*	1000	51345.020.008	M2,5X20*	1000	51345.025.020	M3X28*	500	51345.030.028
M2X10*	1000	51345.020.010	M2,5X22*	1000	51345.025.022	M3X30	500	51345.030.030
M2X12*	1000	51345.020.012	M2,5X25*	500	51345.025.025	M3X35*	500	51345.030.035
M2X14*	1000	51345.020.014	M2,5X28*	500	51345.025.028			

51345 Wkręty z łbem walcowym soczewkowym z gniazdem sześciokątnym

d x L	☒	Kod artykułu	d x L	☒	Kod artykułu	d x L	☒	Kod artykułu
M3X40*	500	51345.030.040	M5X6*	500	51345.050.006	M6X22*	500	51345.060.022
M3X45*	200	51345.030.045	M5X8	200	51345.050.008	M6X25	100	51345.060.025
M3X50*	200	51345.030.050	M5X10	200	51345.050.010	M6X28*	200	51345.060.028
M3X55*	200	51345.030.055	M5X12	200	51345.050.012	M6X30	100	51345.060.030
M3X60*	200	51345.030.060	M5X14*	200	51345.050.014	M6X35	50	51345.060.035
M4X4*	500	51345.040.004	M5X16	500	51345.050.016	M6X40	50	51345.060.040
M4X5*	500	51345.040.005	M5X18*	200	51345.050.018	M6X45*	200	51345.060.045
M4X6	500	51345.040.006	M5X20	500	51345.050.020	M6X50*	200	51345.060.050
M4X8	200	51345.040.008	M5X22*	200	51345.050.022	M6X55*	200	51345.060.055
M4X10	200	51345.040.010	M5X25*	500	51345.050.025	M6X60*	200	51345.060.060
M4X12	200	51345.040.012	M5X28*	500	51345.050.028	M6X65*	200	51345.060.065
M4X14	500	51345.040.014	M5X30	100	51345.050.030	M6X70*	100	51345.060.070
M4X16	200	51345.040.016	M5X35	100	51345.050.035	M6X75*	100	51345.060.075
M4X18*	500	51345.040.018	M5X40	100	51345.050.040	M6X80*	100	51345.060.080
M4X20	200	51345.040.020	M5X45*	100	51345.050.045	M6X90*	100	51345.060.090
M4X22*	500	51345.040.022	M5X50*	200	51345.050.050	M6X100*	100	51345.060.100
M4X25	200	51345.040.025	M5X55*	200	51345.050.055	M8X10*	200	51345.080.010
M4X28*	500	51345.040.028	M5X60*	200	51345.050.060	M8X12*	200	51345.080.012
M4X30	200	51345.040.030	M5X70*	200	51345.050.070	M8X16*	200	51345.080.016
M4X35	200	51345.040.035	M5X80*	200	51345.050.080	M8X20	200	51345.080.020
M4X40	200	51345.040.040	M5X90*	200	51345.050.090	M8X25*	200	51345.080.025
M4X45*	500	51345.040.045	M5X100*	200	51345.050.100	M8X30	200	51345.080.030
M4X50*	500	51345.040.050	M6X8*	500	51345.060.008	M8X35*	200	51345.080.035
M4X55*	500	51345.040.055	M6X10	100	51345.060.010	M8X40*	200	51345.080.040
M4X60*	500	51345.040.060	M6X12	100	51345.060.012	M8X45*	200	51345.080.045
M4X65*	500	51345.040.065	M6X14*	500	51345.060.014	M8X50*	200	51345.080.050
M4X70*	500	51345.040.070	M6X16	100	51345.060.016	M8X60*	200	51345.080.060
M4X80*	500	51345.040.080	M6X18*	100	51345.060.018	M8X70*	200	51345.080.070
M4X90*	500	51345.040.090	M6X20	500	51345.060.020	M8X80*	200	51345.080.080
M4X100*	500	51345.040.100						

6
55345 Wkręty z łbem walcowym soczewkowym z gniazdem sześciokątnym
R41A
Gwint Metryczny
Materiał Stal nierdzewna A4



d x L	☒	Kod artykułu	d x L	☒	Kod artykułu	d x L	☒	Kod artykułu
M1.6X3*	1000	55345.016.003	M3X12*	500	55345.030.012	M5X22*	500	55345.050.022
M1.6X4*	1000	55345.016.004	M3X14*	500	55345.030.014	M5X25*	500	55345.050.025
M1.6X5*	1000	55345.016.005	M3X16*	500	55345.030.016	M5X30*	500	55345.050.030
M1.6X6*	1000	55345.016.006	M3X18*	500	55345.030.018	M5X35*	500	55345.050.035
M1.6X8*	1000	55345.016.008	M3X20*	500	55345.030.020	M5X40*	500	55345.050.040
M1.6X10*	1000	55345.016.010	M3X25*	500	55345.030.025	M5X45*	200	55345.050.045
M1.6X12*	1000	55345.016.012	M3X30*	500	55345.030.030	M5X50*	200	55345.050.050
M1.6X16*	1000	55345.016.016	M3X35*	500	55345.030.035	M5X55*	200	55345.050.055
M2X3*	1000	55345.020.003	M3X40*	500	55345.030.040	M5X60*	200	55345.050.060
M2X4*	1000	55345.020.004	M3X45*	500	55345.030.045	M5X70*	200	55345.050.070
M2X6*	1000	55345.020.006	M3X50*	500	55345.030.050	M5X80*	200	55345.050.080
M2X8*	1000	55345.020.008	M4X5*	500	55345.040.005	M5X90*	200	55345.050.090
M2X10*	1000	55345.020.010	M4X6*	500	55345.040.006	M5X100*	200	55345.050.100
M2X12*	1000	55345.020.012	M4X8*	500	55345.040.008	M6X8*	500	55345.060.008
M2X14*	1000	55345.020.014	M4X10*	500	55345.040.010	M6X10*	500	55345.060.010
M2X16*	1000	55345.020.016	M4X12*	500	55345.040.012	M6X12*	500	55345.060.012
M2X18*	1000	55345.020.018	M4X14*	500	55345.040.014	M6X14*	500	55345.060.014
M2X20*	1000	55345.020.020	M4X16*	500	55345.040.016	M6X16*	500	55345.060.016
M2.5X3*	1000	55345.025.003	M4X18*	500	55345.040.018	M6X20*	200	55345.060.020
M2.5X4*	1000	55345.025.004	M4X20*	500	55345.040.020	M6X22*	200	55345.060.022
M2.5X5*	1000	55345.025.005	M4X22*	500	55345.040.022	M6X25*	200	55345.060.025
M2.5X6*	1000	55345.025.006	M4X25*	500	55345.040.025	M6X30*	200	55345.060.030
M2.5X8*	1000	55345.025.008	M4X30*	500	55345.040.030	M6X35*	200	55345.060.035
M2.5X10*	1000	55345.025.010	M4X35*	500	55345.040.035	M6X40*	200	55345.060.040
M2.5X12*	1000	55345.025.012	M4X40*	500	55345.040.040	M6X45*	200	55345.060.045
M2.5X14*	1000	55345.025.014	M4X45*	500	55345.040.045	M6X50*	200	55345.060.050
M2.5X16*	1000	55345.025.016	M4X50*	500	55345.040.050	M6X55*	200	55345.060.055
M2.5X20*	1000	55345.025.020	M4X55*	500	55345.040.055	M6X60*	200	55345.060.060
M2.5X25*	500	55345.025.025	M4X60*	500	55345.040.060	M6X70*	100	55345.060.070
M2.5X30*	500	55345.025.030	M5X6*	500	55345.050.006	M6X80*	100	55345.060.080
M3X3*	500	55345.030.003	M5X8*	500	55345.050.008	M6X90*	100	55345.060.090
M3X4*	500	55345.030.004	M5X10*	500	55345.050.010	M6X100*	100	55345.060.100
M3X5*	500	55345.030.005	M5X12*	500	55345.050.012	M8X10*	200	55345.080.010
M3X6*	500	55345.030.006	M5X14*	500	55345.050.014	M8X12*	200	55345.080.012
M3X8*	500	55345.030.008	M5X16*	500	55345.050.016	M8X16*	200	55345.080.016
M3X10*	500	55345.030.010	M5X18*	500	55345.050.018	M8X20*	200	55345.080.020
			M5X20*	500	55345.050.020	M8X25*	200	55345.080.025

55345 Wkręty z łbem walcowym soczewkowym z gniazdem sześciokątnym								
d x L	☒	Kod artykułu	d x L	☒	Kod artykułu	d x L	☒	Kod artykułu
M8X30*	200	55345.080.030	M8X45*	200	55345.080.045	M8X70*	200	55345.080.070
M8X35*	200	55345.080.035	M8X50*	200	55345.080.050	M8X80*	200	55345.080.080
M8X40*	200	55345.080.040	M8X60*	200	55345.080.060			

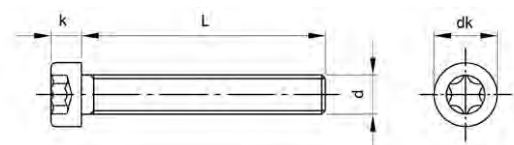
Wkręty z łbem walcowym obniżonym z gniazdem sześciokątnym



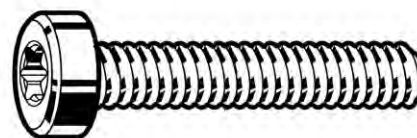

ISO 14580



Informacje techniczne					
d	d _k (maks.)	k (maks.)	Nasadka	P	
M2	3.8	1.55	T6	0.4	
M2.5	4.5	1.85	T8	0.45	
M3	5.5	2.4	T10	0.5	
M4	7	3.1	T20	0.7	
M5	8.5	3.65	T25	0.8	
M6	10	4.4	T30	1	
M8	13	5.8	T45	1.25	

6

51122 Wkręty z łbem walcowym obniżonym z gniazdem sześciokątnym		Q05A
Gwint	Metryczny	
Materiał	Stal nierdzewna A2	
Klasa	50	
		 

d x L	☒	Kod artykułu	d x L	☒	Kod artykułu	d x L	☒	Kod artykułu
M2X3*	1000	51122.020.003	M3X12*	1000	51122.030.012	M6X12*	500	51122.060.012
M2X4*	1000	51122.020.004	M3X16*	1000	51122.030.016	M6X16*	200	51122.060.016
M2X5*	1000	51122.020.005	M3X20*	1000	51122.030.020	M6X20*	200	51122.060.020
M2X6*	1000	51122.020.006				M6X25*	200	51122.060.025
M2X8*	1000	51122.020.008	M4X6*	1000	51122.040.006	M6X30*	200	51122.060.030
M2X10*	1000	51122.020.010	M4X8*	1000	51122.040.008	M6X35*	200	51122.060.035
M2X12*	1000	51122.020.012	M4X10*	1000	51122.040.010	M6X40*	200	51122.060.040
			M4X12*	1000	51122.040.012			
M2,5X3*	1000	51122.025.003	M4X16*	1000	51122.040.016	M8X10*	500	51122.080.010
M2,5X4*	1000	51122.025.004	M4X20*	500	51122.040.020	M8X12*	500	51122.080.012
M2,5X5*	1000	51122.025.005	M4X25*	500	51122.040.025	M8X16*	200	51122.080.016
M2,5X6*	1000	51122.025.006				M8X20*	200	51122.080.020
M2,5X8*	1000	51122.025.008	M5X8*	500	51122.050.008	M8X25*	200	51122.080.025
M2,5X10*	1000	51122.025.010	M5X10*	500	51122.050.010	M8X30*	100	51122.080.030
M2,5X12*	1000	51122.025.012	M5X12*	500	51122.050.012	M8X35*	100	51122.080.035
M2,5X16*	1000	51122.025.016	M5X16*	500	51122.050.016	M8X40*	100	51122.080.040
			M5X20*	500	51122.050.020	M8X45*	100	51122.080.045
M3X4*	1000	51122.030.004	M5X25*	200	51122.050.025	M8X50*	100	51122.080.050
M3X5*	1000	51122.030.005	M5X30*	200	51122.050.030	M8X55*	100	51122.080.055
M3X6*	1000	51122.030.006				M8X60*	100	51122.080.060
M3X8*	1000	51122.030.008	M6X8*	500	51122.060.008			
M3X10*	1000	51122.030.010	M6X10*	500	51122.060.010			

Wkręty z łbem stożkowym płaskim z gniazdem krzyżowym

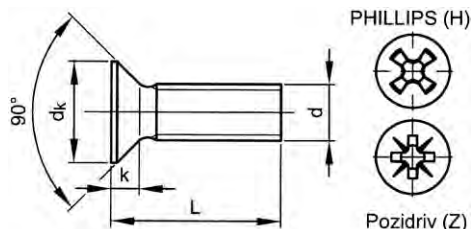

DIN 965
ISO 7046-1
NF E25-119-1

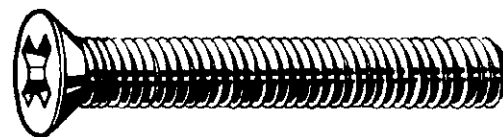

Informacje techniczne

d	d _k	k (maks.)	Nr wgłębienia krzyżowego	P	Pelen gwint L ≤
M1.6	3	0.96	0	0.35	12
M2	3.8	1.2	1	0.4	16
M2.5	4.7	1.5	1	0.45	16
M3	5.6	1.65	1	0.5	20
M4	7.5	2.2	2	0.7	25
M5	9.2	2.5	2	0.8	30
M6	11	3	3	1	35
M8	14.5	4	4	1.25	40
M10	18	5	4	1.5	50

Grupy katalogowe

Gwint	Gniazdo	Materiał	Klasa	Obróbka powierzchni	Kod	Strona
M	Phillips	St	4.8	Ocynk.	24671	6-44
M	Phillips	St	4.8	Ocynk.	24670	6-45
M	Pozidriv	St	4.8	Ocynk.	24672	6-45
M	Phillips	St	4.8	Ocynk. czm. pas.	24840	6-45
M	Phillips	St.St. A2			51300	6-46
M	Pozidriv	St.St. A2			51302	6-46
M	Phillips	St.St. A4			55300	6-47
M	Pozidriv	St.St. A4			55302	6-48
M	Pozidriv	Al P65			45425	6-48

24671 Wkręty z łbem stożkowym płaskim z gniazdem krzyżowym Phillips

H05A

Gwint Metryczny
Materiał Stal
Klasa 4.8
Obróbka powierzchni Ocynkowane

DIN 965-H
ISO 7046-1-H



d x L	☒	Kod artykułu	d x L	☒	Kod artykułu	d x L	☒	Kod artykułu
M3X5	200	24671.030.005	M4X45	200	24671.040.045	M6X12	200	24671.060.012
M3X6	200	24671.030.006	M4X60	200	24671.040.060	M6X16	200	24671.060.016
M3X8	200	24671.030.008	M4X70	200	24671.040.070	M6X20	100	24671.060.020
M3X10	200	24671.030.010				M6X25	100	24671.060.025
M3X12	200	24671.030.012	M5X8	200	24671.050.008	M6X30	100	24671.060.030
M3X16	200	24671.030.016	M5X10	200	24671.050.010	M6X35	100	24671.060.035
M3X20	200	24671.030.020	M5X12	200	24671.050.012	M6X40	100	24671.060.040
M3X25	200	24671.030.025	M5X16	200	24671.050.016	M6X50	100	24671.060.050
M3X30	200	24671.030.030	M5X20	200	24671.050.020	M6X60	100	24671.060.060
M3X40	200	24671.030.040	M5X25	200	24671.050.025	M6X70	100	24671.060.070
M3X50	200	24671.030.050	M5X30	100	24671.050.030	M6X80	100	24671.060.080
			M5X35	100	24671.050.035	M6X100	100	24671.060.100
M4X6	200	24671.040.006	M5X40	100	24671.050.040			
M4X8	200	24671.040.008	M5X50	200	24671.050.050	M8X16	100	24671.080.016
M4X10	200	24671.040.010	M5X60	100	24671.050.060	M8X20	100	24671.080.020
M4X12	200	24671.040.012	M5X70	100	24671.050.070	M8X25	100	24671.080.025
M4X16	200	24671.040.016	M5X80	100	24671.050.080	M8X30	100	24671.080.030
M4X20	200	24671.040.020	M5X100	100	24671.050.100	M8X35	100	24671.080.035
M4X25	200	24671.040.025				M8X60	100	24671.080.060
M4X30	200	24671.040.030	M6X10	200	24671.060.010	M8X80	100	24671.080.080

24670 Wkręty z łbem stożkowym płaskim z gniazdem krzyżowym Phillips				H05A
Gwint	Metryczny	DIN	965-H	
Materiał	Stal	ISO	7046-1-H	
Klasa	4.8			
Obróbka powierzchni	Ocynkowane			



d x L	☒	Kod artykułu	d x L	☒	Kod artykułu	d x L	☒	Kod artykułu
M2,5X8	2000	24670.025.008	M4X30	1000	24670.040.030	M6X12	1000	24670.060.012
M3X5	2000	24670.030.005	M4X35	1000	24670.040.035	M6X16	500	24670.060.016
M3X6	2000	24670.030.006	M4X40	1000	24670.040.040	M6X20	250	24670.060.020
M3X8	2000	24670.030.008	M4X50	1000	24670.040.050	M6X25	250	24670.060.025
M3X10	2000	24670.030.010	M5X8	1000	24670.050.008	M6X30	250	24670.060.030
M3X12	2000	24670.030.012	M5X10	1000	24670.050.010	M6X35	250	24670.060.035
M3X16	2000	24670.030.016	M5X12	1000	24670.050.012	M6X40	250	24670.060.040
M3X20	2000	24670.030.020	M5X16	1000	24670.050.016	M6X50	250	24670.060.050
M3X35	2000	24670.030.035	M5X20	500	24670.050.020	M8X16	250	24670.080.016
M4X6	1000	24670.040.006	M5X25	500	24670.050.025	M8X20	250	24670.080.020
M4X8	1000	24670.040.008	M5X30	250	24670.050.030	M8X25	250	24670.080.025
M4X10	1000	24670.040.010	M5X35	250	24670.050.035	M8X30	250	24670.080.030
M4X12	1000	24670.040.012	M5X40	250	24670.050.040	M8X35	250	24670.080.035
M4X16	1000	24670.040.016	M5X45	250	24670.050.045	M8X40	100	24670.080.040
M4X20	1000	24670.040.020	M5X50	250	24670.050.050	M8X50	100	24670.080.050
M4X25	1000	24670.040.025	M6X10	1000	24670.060.010			



24672 Wkręty z łbem stożkowym płaskim z gniazdem krzyżowym Pozidriv				H05A
Gwint	Metryczny	DIN	965-Z	
Materiał	Stal	ISO	7046-1-Z	
Klasa	4.8			
Obróbka powierzchni	Ocynkowane			





d x L	☒	Kod artykułu	d x L	☒	Kod artykułu	d x L	☒	Kod artykułu
M3X6	2000	24672.030.006	M5X8	1000	24672.050.008	M6X20	250	24672.060.020
M3X8	2000	24672.030.008	M5X10	1000	24672.050.010	M6X25	250	24672.060.025
M3X10	2000	24672.030.010	M5X12	1000	24672.050.012	M6X30	250	24672.060.030
M3X12	2000	24672.030.012	M5X16	1000	24672.050.016	M6X35	250	24672.060.035
M3X16	2000	24672.030.016	M5X20	500	24672.050.020	M6X40	250	24672.060.040
M3X20	2000	24672.030.020	M5X25	500	24672.050.025	M6X50	250	24672.060.050
M4X6	1000	24672.040.006	M5X30	250	24672.050.030	M6X60	250	24672.060.060
M4X8	1000	24672.040.008	M5X35	250	24672.050.035	M8X16	250	24672.080.016
M4X10	1000	24672.040.010	M5X40	250	24672.050.040	M8X20	250	24672.080.020
M4X12	1000	24672.040.012	M5X50	250	24672.050.050	M8X25	250	24672.080.025
M4X16	1000	24672.040.016	M5X60	250	24672.050.060	M8X30	250	24672.080.030
M4X20	1000	24672.040.020	M6X10	1000	24672.060.010	M8X35	250	24672.080.035
M4X25	1000	24672.040.025	M6X12	1000	24672.060.012	M8X40	100	24672.080.040
M4X30	1000	24672.040.030	M6X16	500	24672.060.016	M8X50	100	24672.080.050

24840 Wkręty z łbem stożkowym płaskim z gniazdem krzyżowym Phillips				H07A
Gwint	Metryczny	DIN	965-H	
Materiał	Stal	ISO	7046-1-H	
Klasa	4.8			
Obróbka powierzchni	Ocynkowane, po czarnej pasywacji			

d x L	☒	Kod artykułu	d x L	☒	Kod artykułu	d x L	☒	Kod artykułu
M2X4	200	24840.020.004	M4X25	200	24840.040.025	M6X10	200	24840.060.010
M3X6	200	24840.030.006	M4X30	200	24840.040.030	M6X12	200	24840.060.012
M3X8	200	24840.030.008	M4X35	200	24840.040.035	M6X16	200	24840.060.016
M3X10	200	24840.030.010	M4X40	200	24840.040.040	M6X20	100	24840.060.020
M3X12	200	24840.030.012	M4X50	200	24840.040.050	M6X25	100	24840.060.025
M3X16	200	24840.030.016	M5X8	200	24840.050.008	M6X30	100	24840.060.030
M3X20	200	24840.030.020	M5X10	200	24840.050.010	M6X35	100	24840.060.035
M3X25	200	24840.030.025	M5X12	200	24840.050.012	M6X40	100	24840.060.040
M3X30	200	24840.030.030	M5X16	200	24840.050.016	M6X50	100	24840.060.050
M4X6	200	24840.040.006	M5X20	200	24840.050.020	M8X16	100	24840.080.016
M4X8	200	24840.040.008	M5X25	200	24840.050.025	M8X20	100	24840.080.020
M4X10	200	24840.040.010	M5X30	100	24840.050.030	M8X25	100	24840.080.025
M4X12	200	24840.040.012	M5X35	100	24840.050.035	M8X30	100	24840.080.030
M4X16	200	24840.040.016	M5X40	100	24840.050.040	M8X35	100	24840.080.035
M4X20	200	24840.040.020	M5X50	100	24840.050.050	M8X40	100	24840.080.040
						M8X50	100	24840.080.050

51300	Wkręty z łbem stożkowym płaskim z gniazdem krzyżowym Phillips			R01A
Gwint	Metryczny	DIN	965-H	
Material	Stal nierdzewna A2	ISO	7046-2-H	
		NF	E25-119-2	
				

d x L	☒	Kod artykułu	d x L	☒	Kod artykułu	d x L	☒	Kod artykułu
M1,6X2*	1000	51300.016.002	M3X45*	500	51300.030.045	M6X12	100	51300.060.012
M1,6X3*	1000	51300.016.003	M3X50*	500	51300.030.050	M6X14*	500	51300.060.014
M1,6X4*	1000	51300.016.004	M3X55*	500	51300.030.055	M6X16	100	51300.060.016
M1,6X5*	1000	51300.016.005	M3X60*	500	51300.030.060	M6X18*	500	51300.060.018
M1,6X6*	1000	51300.016.006				M6X20	100	51300.060.020
M1,6X8*	1000	51300.016.008	M4X5	500	51300.040.005	M6X22*	200	51300.060.022
M1,6X10*	1000	51300.016.010	M4X6	500	51300.040.006	M6X25	100	51300.060.025
M1,6X12*	1000	51300.016.012	M4X8	200	51300.040.008	M6X30	100	51300.060.030
M1,6X14*	1000	51300.016.014	M4X10	200	51300.040.010	M6X35	100	51300.060.035
M1,6X16*	1000	51300.016.016	M4X12	200	51300.040.012	M6X40	100	51300.060.040
M1,6X18*	1000	51300.016.018	M4X14*	500	51300.040.014	M6X45	100	51300.060.045
M1,6X20*	1000	51300.016.020	M4X16	200	51300.040.016	M6X50	100	51300.060.050
			M4X18*	500	51300.040.018	M6X55*	200	51300.060.055
M2X3*	1000	51300.020.003	M4X20	200	51300.040.020	M6X60	100	51300.060.060
M2X4	100	51300.020.004	M4X22*	500	51300.040.022	M6X65	100	51300.060.065
M2X5	100	51300.020.005	M4X25	200	51300.040.025	M6X70	100	51300.060.070
M2X6	100	51300.020.006	M4X30	200	51300.040.030	M6X75*	200	51300.060.075
M2X8	100	51300.020.008	M4X35	200	51300.040.035	M6X80	100	51300.060.080
M2X10	100	51300.020.010	M4X40	200	51300.040.040	M6X90*	200	51300.060.090
M2X12	100	51300.020.012	M4X45	200	51300.040.045	M6X100	200	51300.060.100
M2X16	100	51300.020.016	M4X50	200	51300.040.050			
M2X18*	1000	51300.020.018	M4X55*	500	51300.040.055	M8X12*	200	51300.080.012
M2X20*	1000	51300.020.020	M4X60	200	51300.040.060	M8X16*	200	51300.080.016
			M4X70*	200	51300.040.070	M8X20	100	51300.080.020
M2,5X3*	1000	51300.025.003	M4X80*	200	51300.040.080	M8X25	100	51300.080.025
M2,5X4*	1000	51300.025.004	M4X100*	200	51300.040.100	M8X30	100	51300.080.030
M2,5X5	100	51300.025.005				M8X35	100	51300.080.035
M2,5X6	100	51300.025.006	M5X6	500	51300.050.006	M8X40	100	51300.080.040
M2,5X8	100	51300.025.008	M5X8	100	51300.050.008	M8X45*	200	51300.080.045
M2,5X10	100	51300.025.010	M5X10	100	51300.050.010	M8X50	100	51300.080.050
M2,5X12	100	51300.025.012	M5X12	100	51300.050.012	M8X60	100	51300.080.060
M2,5X14*	1000	51300.025.014	M5X14*	500	51300.050.014	M8X70	100	51300.080.070
M2,5X16	100	51300.025.016	M5X16	100	51300.050.016	M8X80	100	51300.080.080
M2,5X18*	1000	51300.025.018	M5X18*	500	51300.050.018	M8X90*	200	51300.080.090
M2,5X20	100	51300.025.020	M5X20	100	51300.050.020	M8X100*	100	51300.080.100
M2,5X22*	1000	51300.025.022	M5X22*	500	51300.050.022	M8X110*	100	51300.080.110
M2,5X25*	1000	51300.025.025	M5X25	100	51300.050.025	M8X120*	100	51300.080.120
			M5X28*	500	51300.050.028	M8X130*	100	51300.080.130
M3X4	500	51300.030.004	M5X30	100	51300.050.030	M8X150*	100	51300.080.150
M3X5*	500	51300.030.005	M5X35	100	51300.050.035			
M3X6	200	51300.030.006	M5X40	100	51300.050.040	M10X16*	100	51300.100.016
M3X8	200	51300.030.008	M5X45	100	51300.050.045	M10X20*	100	51300.100.020
M3X10	200	51300.030.010	M5X50	100	51300.050.050	M10X25*	100	51300.100.025
M3X12	200	51300.030.012	M5X55*	200	51300.050.055	M10X30*	100	51300.100.030
M3X14*	500	51300.030.014	M5X60	100	51300.050.060	M10X35*	100	51300.100.035
M3X16	200	51300.030.016	M5X65*	200	51300.050.065	M10X40	100	51300.100.040
M3X18*	500	51300.030.018	M5X70	100	51300.050.070	M10X45*	100	51300.100.045
M3X20	200	51300.030.020	M5X80	100	51300.050.080	M10X50*	100	51300.100.050
M3X22*	500	51300.030.022	M5X90*	200	51300.050.090	M10X60*	100	51300.100.060
M3X25	200	51300.030.025	M5X100	200	51300.050.100	M10X70*	50	51300.100.070
M3X30	200	51300.030.030				M10X80*	50	51300.100.080
M3X35	200	51300.030.035	M6X8*	500	51300.060.008	M10X100*	50	51300.100.100
M3X40	200	51300.030.040	M6X10	100	51300.060.010			

51302	Wkręty z łbem stożkowym płaskim z gniazdem krzyżowym Pozidriv			R01A
Gwint	Metryczny	DIN	965-Z	
Material	Stal nierdzewna A2	ISO	7046-2-Z	
		NF	E25-119-2	
				

d x L	☒	Kod artykułu	d x L	☒	Kod artykułu	d x L	☒	Kod artykułu
M1,6X2*	1000	51302.016.002	M1,6X18*	1000	51302.016.018	M2X14*	1000	51302.020.014
M1,6X3*	1000	51302.016.003	M1,6X20*	1000	51302.016.020	M2X16	100	51302.020.016
M1,6X4	100	51302.016.004				M2X18*	1000	51302.020.018
M1,6X5	100	51302.016.005	M2X3	100	51302.020.003	M2X20	100	51302.020.020
M1,6X6	100	51302.016.006	M2X4	100	51302.020.004			
M1,6X8	100	51302.016.008	M2X5	100	51302.020.005	M2,5X3*	1000	51302.025.003
M1,6X10	100	51302.016.010	M2X6	100	51302.020.006	M2,5X4	100	51302.025.004
M1,6X12*	1000	51302.016.012	M2X8	100	51302.020.008	M2,5X5	100	51302.025.005
M1,6X14*	1000	51302.016.014	M2X10	100	51302.020.010	M2,5X6	100	51302.025.006
M1,6X16*	1000	51302.016.016	M2X12	100	51302.020.012	M2,5X8	100	51302.025.008

51302 Wkręty z łbem stożkowym płaskim z gniazdem krzyżowym Pozidriv								
d x L	☒	Kod artykułu	d x L	☒	Kod artykułu	d x L	☒	Kod artykułu
M2,5X10	100	51302.025.010	M4X14*	500	51302.040.014	M5X70*	200	51302.050.070
M2,5X12	100	51302.025.012	M4X16	200	51302.040.016	M5X80*	200	51302.050.080
M2,5X14	100	51302.025.014	M4X18*	500	51302.040.018	M5X90*	200	51302.050.090
M2,5X16	100	51302.025.016	M4X20	200	51302.040.020	M5X100*	200	51302.050.100
M2,5X18*	1000	51302.025.018	M4X22*	500	51302.040.022			
M2,5X20	100	51302.025.020	M4X25	200	51302.040.025	M6X8	100	51302.060.008
M2,5X25*	1000	51302.025.025	M4X30	200	51302.040.030	M6X10	100	51302.060.010
			M4X35	200	51302.040.035	M6X12	100	51302.060.012
M3X4	200	51302.030.004	M4X40	200	51302.040.040	M6X14*	500	51302.060.014
M3X5	200	51302.030.005	M4X45*	500	51302.040.045	M6X16	100	51302.060.016
M3X6	200	51302.030.006	M4X50	200	51302.040.050	M6X20	100	51302.060.020
M3X8	200	51302.030.008	M4X55*	500	51302.040.055	M6X22*	500	51302.060.022
M3X10	200	51302.030.010	M4X60*	500	51302.040.060	M6X25	100	51302.060.025
M3X12	200	51302.030.012	M4X70*	500	51302.040.070	M6X30	100	51302.060.030
M3X14*	500	51302.030.014	M4X80*	200	51302.040.080	M6X35	100	51302.060.035
M3X16	200	51302.030.016				M6X40	100	51302.060.040
M3X18*	500	51302.030.018	M5X6	100	51302.050.006	M6X45*	200	51302.060.045
M3X20	200	51302.030.020	M5X8	100	51302.050.008	M6X50	100	51302.060.050
M3X22*	500	51302.030.022	M5X10	100	51302.050.010	M6X55*	200	51302.060.055
M3X25	200	51302.030.025	M5X12	100	51302.050.012	M6X60	100	51302.060.060
M3X30	200	51302.030.030	M5X14*	500	51302.050.014	M6X65*	200	51302.060.065
M3X35*	500	51302.030.035	M5X16	100	51302.050.016	M6X70*	200	51302.060.070
M3X40	200	51302.030.040	M5X18*	500	51302.050.018	M6X75*	200	51302.060.075
M3X45*	500	51302.030.045	M5X20	100	51302.050.020	M6X80*	200	51302.060.080
M3X50*	500	51302.030.050	M5X22*	500	51302.050.022	M6X90*	100	51302.060.090
M3X55*	500	51302.030.055	M5X25	100	51302.050.025	M6X100*	100	51302.060.100
M3X60*	500	51302.030.060	M5X30	100	51302.050.030			
			M5X35	100	51302.050.035	M8X16*	200	51302.080.016
M4X5	200	51302.040.005	M5X40	100	51302.050.040	M8X20*	200	51302.080.020
M4X6	200	51302.040.006	M5X45*	200	51302.050.045	M8X25*	200	51302.080.025
M4X8	200	51302.040.008	M5X50	100	51302.050.050	M8X30*	200	51302.080.030
M4X10	200	51302.040.010	M5X55*	200	51302.050.055	M8X35*	200	51302.080.035
M4X12	200	51302.040.012	M5X60	100	51302.050.060			

55300 Wkręty z łbem stożkowym płaskim z gniazdem krzyżowym Phillips					R41A
Gwint	Metryczny	DIN	965-H		
Material	Stal nierdzewna A4	ISO	7046-2-H		
		NF	E25-119-2		

d x L	☒	Kod artykułu	d x L	☒	Kod artykułu	d x L	☒	Kod artykułu
M1,6X3*	1000	55300.016.003	M3X10	200	55300.030.010	M5X14*	500	55300.050.014
M1,6X4*	1000	55300.016.004	M3X12	200	55300.030.012	M5X16	100	55300.050.016
M1,6X5*	1000	55300.016.005	M3X14*	500	55300.030.014	M5X18*	500	55300.050.018
M1,6X6*	1000	55300.016.006	M3X16	200	55300.030.016	M5X20	100	55300.050.020
M1,6X8*	1000	55300.016.008	M3X18*	500	55300.030.018	M5X22*	500	55300.050.022
M1,6X10*	1000	55300.016.010	M3X20	200	55300.030.020	M5X25	100	55300.050.025
M1,6X12*	1000	55300.016.012	M3X22*	500	55300.030.022	M5X30	100	55300.050.030
M1,6X14*	1000	55300.016.014	M3X25	200	55300.030.025	M5X35	100	55300.050.035
M1,6X16*	1000	55300.016.016	M3X30	200	55300.030.030	M5X40	100	55300.050.040
			M3X35*	500	55300.030.035	M5X45*	200	55300.050.045
M2X4	100	55300.020.004	M3X45*	500	55300.030.045	M5X50	100	55300.050.050
M2X5	100	55300.020.005	M3X50*	500	55300.030.050	M5X55*	200	55300.050.055
M2X6	100	55300.020.006	M3X60*	500	55300.030.060	M5X60	100	55300.050.060
M2X8	100	55300.020.008				M5X70*	200	55300.050.070
M2X10	100	55300.020.010	M4X5*	500	55300.040.005	M5X80*	200	55300.050.080
M2X12	100	55300.020.012	M4X6	200	55300.040.006	M5X90*	200	55300.050.090
M2X16	100	55300.020.016	M4X8	200	55300.040.008	M5X100*	200	55300.050.100
M2X18*	1000	55300.020.018	M4X10	200	55300.040.010			
M2X20*	1000	55300.020.020	M4X12	200	55300.040.012	M6X8	100	55300.060.008
			M4X14*	500	55300.040.014	M6X10	100	55300.060.010
M2,5X3*	1000	55300.025.003	M4X16	200	55300.040.016	M6X12	100	55300.060.012
M2,5X5	100	55300.025.005	M4X18*	500	55300.040.018	M6X14*	500	55300.060.014
M2,5X6	100	55300.025.006	M4X20	200	55300.040.020	M6X16	100	55300.060.016
M2,5X8	100	55300.025.008	M4X22*	500	55300.040.022	M6X18*	500	55300.060.018
M2,5X10	100	55300.025.010	M4X25	200	55300.040.025	M6X20	100	55300.060.020
M2,5X12	100	55300.025.012	M4X30	200	55300.040.030	M6X22*	200	55300.060.022
M2,5X14*	1000	55300.025.014	M4X35	200	55300.040.035	M6X25	100	55300.060.025
M2,5X16	100	55300.025.016	M4X40	200	55300.040.040	M6X30	100	55300.060.030
M2,5X18*	1000	55300.025.018	M4X45*	500	55300.040.045	M6X35	100	55300.060.035
M2,5X20	100	55300.025.020	M4X55*	500	55300.040.055	M6X40	100	55300.060.040
M2,5X22*	1000	55300.025.022	M4X60*	500	55300.040.060	M6X45*	200	55300.060.045
M2,5X25*	1000	55300.025.025	M4X70*	200	55300.040.070	M6X50	100	55300.060.050
						M6X55*	200	55300.060.055
M3X4*	500	55300.030.004	M5X6*	500	55300.050.006	M6X60	100	55300.060.060
M3X5	500	55300.030.005	M5X8	100	55300.050.008	M6X70	100	55300.060.070
M3X6	200	55300.030.006	M5X10	100	55300.050.010	M6X75*	200	55300.060.075
M3X8	200	55300.030.008	M5X12	100	55300.050.012	M6X80*	200	55300.060.080

55300 Wkręty z łbem stożkowym płaskim z gniazdem krzyżowym Phillips ←								
d x L	☒	Kod artykułu	d x L	☒	Kod artykułu	d x L	☒	Kod artykułu
M6X90*	200	55300.060.090	M8X40	100	55300.080.040	M10X30*	100	55300.100.030
M6X100	200	55300.060.100	M8X45*	200	55300.080.045	M10X35*	100	55300.100.035
M8X12*	200	55300.080.012	M8X50	100	55300.080.050	M10X40	100	55300.100.040
M8X16	100	55300.080.016	M8X60	100	55300.080.060	M10X45*	100	55300.100.045
M8X20	100	55300.080.020	M8X80*	100	55300.080.080	M10X50*	100	55300.100.050
M8X25	100	55300.080.025	M10X16*	100	55300.100.016	M10X60*	100	55300.100.060
M8X30	100	55300.080.030	M10X20*	100	55300.100.020	M10X70*	50	55300.100.070
M8X35	100	55300.080.035	M10X25*	100	55300.100.025	M10X80*	50	55300.100.080

55302 Wkręty z łbem stożkowym płaskim z gniazdem krzyżowym Pozidriv				R41A
Gwint	Metryczny	DIN	965-Z	
Materiał	Stal nierdzewna A4	ISO	7046-2-Z	
		NF	E25-119-2	



d x L	☒	Kod artykułu	d x L	☒	Kod artykułu	d x L	☒	Kod artykułu
M1,6X3	100	55302.016.003	M3X10	200	55302.030.010	M5X14*	500	55302.050.014
M1,6X4	100	55302.016.004	M3X12	200	55302.030.012	M5X16	100	55302.050.016
M1,6X5	100	55302.016.005	M3X14*	500	55302.030.014	M5X20	100	55302.050.020
M1,6X6	100	55302.016.006	M3X16	200	55302.030.016	M5X22*	500	55302.050.022
M1,6X8	100	55302.016.008	M3X18*	500	55302.030.018	M5X25	100	55302.050.025
M1,6X10	100	55302.016.010	M3X20	200	55302.030.020	M5X30	100	55302.050.030
M1,6X12	100	55302.016.012	M3X22*	500	55302.030.022	M5X35	100	55302.050.035
M2X3	100	55302.020.003	M3X25	200	55302.030.025	M5X40	100	55302.050.040
M2X4	100	55302.020.004	M3X30	200	55302.030.030	M5X45*	200	55302.050.045
M2X5	100	55302.020.005	M3X35*	500	55302.030.035	M5X50	100	55302.050.050
M2X6	100	55302.020.006	M3X40	200	55302.030.040	M5X55*	200	55302.050.055
M2X8	100	55302.020.008	M3X45*	500	55302.030.045	M5X60	100	55302.050.060
M2X10*	1000	55302.020.010	M4X5	200	55302.040.005	M5X70*	200	55302.050.070
M2X12	100	55302.020.012	M4X6	200	55302.040.006	M5X80*	200	55302.050.080
M2X14	100	55302.020.014	M4X8	200	55302.040.008	M6X8	100	55302.060.008
M2X16	100	55302.020.016	M4X10	200	55302.040.010	M6X10	100	55302.060.010
M2X20	100	55302.020.020	M4X12	200	55302.040.012	M6X12	100	55302.060.012
M2,5X3*	1000	55302.025.003	M4X14*	500	55302.040.014	M6X14*	500	55302.060.014
M2,5X4	100	55302.025.004	M4X16	200	55302.040.016	M6X16	100	55302.060.016
M2,5X5	100	55302.025.005	M4X18*	500	55302.040.018	M6X18*	500	55302.060.018
M2,5X6	100	55302.025.006	M4X20	200	55302.040.020	M6X20	100	55302.060.020
M2,5X8	100	55302.025.008	M4X25	200	55302.040.025	M6X22*	500	55302.060.022
M2,5X10	100	55302.025.010	M4X30	200	55302.040.030	M6X25	100	55302.060.025
M2,5X12*	1000	55302.025.012	M4X35	200	55302.040.035	M6X30	100	55302.060.030
M2,5X14	100	55302.025.014	M4X40	200	55302.040.040	M6X35	100	55302.060.035
M2,5X16	100	55302.025.016	M4X45*	500	55302.040.045	M6X40	100	55302.060.040
M2,5X18*	1000	55302.025.018	M4X50	200	55302.040.050	M6X45*	200	55302.060.045
M2,5X20	100	55302.025.020	M4X60*	500	55302.040.060	M6X50	100	55302.060.050
M2,5X25*	1000	55302.025.025	M4X70*	500	55302.040.070	M6X60	100	55302.060.060
M3X4	200	55302.030.004	M5X6	100	55302.050.006	M6X70*	200	55302.060.070
M3X5	200	55302.030.005	M5X8	100	55302.050.008	M6X75*	200	55302.060.075
M3X6	200	55302.030.006	M5X10	100	55302.050.010	M6X80*	200	55302.060.080
M3X8	200	55302.030.008	M5X12	100	55302.050.012	M6X90*	100	55302.060.090
						M6X100*	100	55302.060.100

45425 Wkręty z łbem stożkowym płaskim z gniazdem krzyżowym Pozidriv				W010
Gwint	Metryczny	DIN	≈965	
Materiał	Aluminium P65	ISO	≈7046-1	
		NF	≈E25-119-1	

d x L	☒	Kod artykułu	d x L	☒	Kod artykułu	d x L	☒	Kod artykułu
M3X8	500	45425.030.008	M4X20	500	45425.040.020	M6X20	200	45425.060.020
M3X10	500	45425.030.010	M4X25	200	45425.040.025	M6X25	200	45425.060.025
M3X16	500	45425.030.016	M5X10	200	45425.050.010	M6X30	200	45425.060.030
M3X20	500	45425.030.020	M5X12	200	45425.050.012	M6X35	200	45425.060.035
M3X25	500	45425.030.025	M5X16	200	45425.050.016	M6X40	100	45425.060.040
M4X10	500	45425.040.010	M5X20	200	45425.050.020	M6X50	100	45425.060.050
M4X12	500	45425.040.012	M6X16	200	45425.060.016	M8X20	100	45425.080.020
M4X16	500	45425.040.016				M8X30	100	45425.080.030

Wkręty z łbem stożkowym płaskim z gniazdem sześciokarbowym

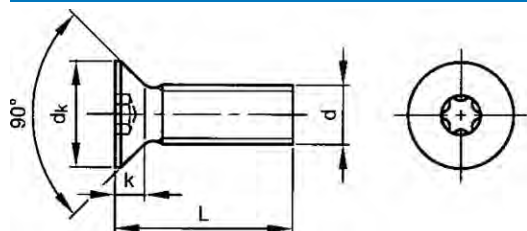

DIN ≈965
ISO ≈14581
NF ≈E25-119-1

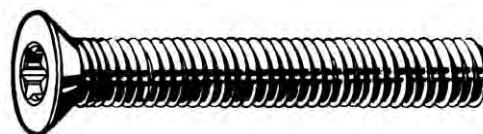

Informacje techniczne

d	d _k	k (maks.)	Nasadka	P
M1.6	3	0.96	T5	0.35
M2	3.8	1.2	T6	0.4
M2.5	4.7	1.5	T8	0.45
M3	5.6	1.65	T10	0.5
M4	7.5	2.2	T20	0.7
M5	9.2	2.5	T25	0.8
M6	11	3	T30	1
M8	14.5	4	T45	1.25
M10	18	5	T50	1.5

Grupy katalogowe

Gwint	Gniazdo	Materiał	Klasa	Obróbka powierzchni	Kod	Strona
M	Sześciokarbowy	St	4.8	Ocynk.	24677	6-49
M	Sześciokarbowy	St.St. A2			51305	6-49
M	Sześciokarbowy	St.St. A4			55303	6-50

6

24677 Wkręty z łbem stożkowym płaskim z gniazdem sześciokarbowym

H05A

Gwint: Metryczny
Materiał: Stal
Klasa: 4.8
Obróbka powierzchni: Ocynkowane



d x L	☒	Kod artykułu	d x L	☒	Kod artykułu	d x L	☒	Kod artykułu
M3X5	200	24677.030.005	M4X16	200	24677.040.016	M6X10	200	24677.060.010
M3X6	200	24677.030.006	M4X20	200	24677.040.020	M6X12	200	24677.060.012
M3X8	200	24677.030.008	M4X25	200	24677.040.025	M6X16	200	24677.060.016
M3X10	200	24677.030.010				M6X20	100	24677.060.020
M3X12	200	24677.030.012	M5X8	200	24677.050.008	M6X25	100	24677.060.025
M3X16	200	24677.030.016	M5X10	200	24677.050.010	M6X30	100	24677.060.030
M3X20	200	24677.030.020	M5X12	200	24677.050.012	M6X35	100	24677.060.035
			M5X16	200	24677.050.016	M6X40	100	24677.060.040
M4X6	200	24677.040.006	M5X20	200	24677.050.020			
M4X8	200	24677.040.008	M5X25	100	24677.050.025			
M4X10	200	24677.040.010	M5X30	100	24677.050.030	M8X16	50	24677.080.016
M4X12	200	24677.040.012	M5X35	100	24677.050.035	M8X20	50	24677.080.020

51305 Wkręty z łbem stożkowym płaskim z gniazdem sześciokarbowym

R01A

Gwint: Metryczny
Materiał: Stal nierdzewna A2



d x L	☒	Kod artykułu	d x L	☒	Kod artykułu	d x L	☒	Kod artykułu
M1,6X2*	1000	51305.016.002	M2X4*	1000	51305.020.004	M2,5X5*	1000	51305.025.005
M1,6X3*	1000	51305.016.003	M2X5*	1000	51305.020.005	M2,5X6	1000	51305.025.006
M1,6X4*	1000	51305.016.004	M2X6	1000	51305.020.006	M2,5X8*	1000	51305.025.008
M1,6X5*	1000	51305.016.005	M2X8*	1000	51305.020.008	M2,5X10*	1000	51305.025.010
M1,6X6*	1000	51305.016.006	M2X10*	1000	51305.020.010	M2,5X12*	1000	51305.025.012
M1,6X8*	1000	51305.016.008	M2X12*	1000	51305.020.012	M2,5X14*	1000	51305.025.014
M1,6X10*	1000	51305.016.010	M2X14*	1000	51305.020.014	M2,5X16*	1000	51305.025.016
M1,6X12*	1000	51305.016.012	M2X16*	1000	51305.020.016	M2,5X18*	1000	51305.025.018
M1,6X14*	1000	51305.016.014	M2X18*	1000	51305.020.018	M2,5X20*	1000	51305.025.020
M1,6X16*	1000	51305.016.016	M2X20*	1000	51305.020.020	M2,5X22*	1000	51305.025.022
M1,6X20*	1000	51305.016.020				M2,5X25*	1000	51305.025.025
			M2,5X3*	1000	51305.025.003			
M2X3*	1000	51305.020.003	M2,5X4	1000	51305.025.004	M3X4	500	51305.030.004

51305 Wkręty z łbem stożkowym płaskim z gniazdem sześciokarbowym

d x L	☒	Kod artykułu	d x L	☒	Kod artykułu	d x L	☒	Kod artykułu
M3X5	500	51305.030.005	M4X55*	500	51305.040.055	M6X16	100	51305.060.016
M3X6	200	51305.030.006	M4X60*	500	51305.040.060	M6X18*	500	51305.060.018
M3X8	200	51305.030.008	M4X65*	200	51305.040.065	M6X20	100	51305.060.020
M3X10	200	51305.030.010	M4X70*	200	51305.040.070	M6X22*	500	51305.060.022
M3X12	200	51305.030.012	M4X80*	200	51305.040.080	M6X25	100	51305.060.025
M3X14*	500	51305.030.014	M4X90*	200	51305.040.090	M6X30	100	51305.060.030
M3X16	200	51305.030.016	M4X100*	200	51305.040.100	M6X35	100	51305.060.035
M3X18*	500	51305.030.018				M6X40	100	51305.060.040
M3X20	200	51305.030.020	M5X6*	500	51305.050.006	M6X45*	200	51305.060.045
M3X22*	500	51305.030.022	M5X8	500	51305.050.008	M6X50*	200	51305.060.050
M3X25*	500	51305.030.025	M5X10	200	51305.050.010	M6X55*	200	51305.060.055
M3X30*	500	51305.030.030	M5X12	200	51305.050.012	M6X60*	200	51305.060.060
M3X35*	500	51305.030.035	M5X14*	500	51305.050.014	M6X65*	200	51305.060.065
M3X40*	500	51305.030.040	M5X16	200	51305.050.016	M6X70*	200	51305.060.070
M3X45*	500	51305.030.045	M5X18*	500	51305.050.018	M6X75*	200	51305.060.075
M3X50*	500	51305.030.050	M5X20	200	51305.050.020	M6X80*	200	51305.060.080
M3X55*	500	51305.030.055	M5X22*	500	51305.050.022	M6X90*	200	51305.060.090
M3X60*	500	51305.030.060	M5X25	100	51305.050.025	M6X100*	200	51305.060.100
			M5X28*	500	51305.050.028	M6X120*	200	51305.060.120
M4X5	500	51305.040.005	M5X30	100	51305.050.030	M6X130*	200	51305.060.130
M4X6*	500	51305.040.006	M5X35	100	51305.050.035	M6X140*	200	51305.060.140
M4X8	200	51305.040.008	M5X40	100	51305.050.040			
M4X10	200	51305.040.010	M5X45*	200	51305.050.045	M8X10*	200	51305.080.010
M4X12	200	51305.040.012	M5X50*	200	51305.050.050	M8X12*	200	51305.080.012
M4X14*	500	51305.040.014	M5X55*	200	51305.050.055	M8X16*	200	51305.080.016
M4X16	200	51305.040.016	M5X60*	200	51305.050.060	M8X20	200	51305.080.020
M4X18*	500	51305.040.018	M5X70*	200	51305.050.070	M8X25*	200	51305.080.025
M4X20	200	51305.040.020	M5X80*	200	51305.050.080	M8X30	200	51305.080.030
M4X22*	500	51305.040.022	M5X90*	200	51305.050.090	M8X35*	200	51305.080.035
M4X25	200	51305.040.025	M5X100*	200	51305.050.100	M8X40*	200	51305.080.040
M4X30	200	51305.040.030				M8X45*	200	51305.080.045
M4X35	100	51305.040.035	M6X8*	500	51305.060.008	M8X50*	200	51305.080.050
M4X40	100	51305.040.040	M6X10	100	51305.060.010	M8X60*	200	51305.080.060
M4X45*	500	51305.040.045	M6X12	100	51305.060.012	M8X70*	200	51305.080.070
M4X50	500	51305.040.050	M6X14*	500	51305.060.014	M8X80*	200	51305.080.080

6
55303 Wkręty z łbem stożkowym płaskim z gniazdem sześciokarbowym
R41A
Gwint Metryczny
Materiał Stal nierdzewna A4

d x L	☒	Kod artykułu	d x L	☒	Kod artykułu	d x L	☒	Kod artykułu
M1,6X3*	1000	55303.016.003	M3X14*	500	55303.030.014	M5X8*	500	55303.050.008
M1,6X4*	1000	55303.016.004	M3X16*	500	55303.030.016	M5X10*	500	55303.050.010
M1,6X5*	1000	55303.016.005	M3X18*	500	55303.030.018	M5X12*	500	55303.050.012
M1,6X6*	1000	55303.016.006	M3X20*	500	55303.030.020	M5X14*	500	55303.050.014
M1,6X8*	1000	55303.016.008	M3X25*	500	55303.030.025	M5X16*	500	55303.050.016
M1,6X10*	1000	55303.016.010	M3X30*	500	55303.030.030	M5X18*	500	55303.050.018
M1,6X14*	1000	55303.016.014	M3X35*	500	55303.030.035	M5X20*	500	55303.050.020
M1,6X16*	1000	55303.016.016	M3X40*	500	55303.030.040	M5X22*	500	55303.050.022
M1,6X20*	1000	55303.016.020	M3X45*	500	55303.030.045	M5X25*	500	55303.050.025
			M3X50*	500	55303.030.050	M5X28*	500	55303.050.028
M2X3*	1000	55303.020.003	M3X60*	500	55303.030.060	M5X30*	500	55303.050.030
M2X4*	1000	55303.020.004				M5X35*	500	55303.050.035
M2X6*	1000	55303.020.006	M4X5*	500	55303.040.005	M5X40*	500	55303.050.040
M2X8*	1000	55303.020.008	M4X6*	500	55303.040.006	M5X45*	200	55303.050.045
M2X12*	1000	55303.020.012	M4X8*	500	55303.040.008	M5X50*	200	55303.050.050
M2X14*	1000	55303.020.014	M4X10*	500	55303.040.010	M5X55*	200	55303.050.055
M2X16*	1000	55303.020.016	M4X12*	500	55303.040.012	M5X60*	200	55303.050.060
M2X20*	1000	55303.020.020	M4X14*	500	55303.040.014	M5X70*	200	55303.050.070
			M4X16*	500	55303.040.016	M5X80*	200	55303.050.080
M2,5X3*	1000	55303.025.003	M4X18*	500	55303.040.018	M5X90*	200	55303.050.090
M2,5X4*	1000	55303.025.004	M4X20*	500	55303.040.020	M5X100*	200	55303.050.100
M2,5X5*	1000	55303.025.005	M4X22*	500	55303.040.022			
M2,5X6*	1000	55303.025.006	M4X25*	500	55303.040.025	M6X8*	500	55303.060.008
M2,5X8*	1000	55303.025.008	M4X30*	500	55303.040.030	M6X10*	500	55303.060.010
M2,5X10*	1000	55303.025.010	M4X35*	500	55303.040.035	M6X12*	500	55303.060.012
M2,5X12	1000	55303.025.012	M4X40*	500	55303.040.040	M6X14*	500	55303.060.014
M2,5X14*	1000	55303.025.014	M4X45*	500	55303.040.045	M6X16*	500	55303.060.016
M2,5X16*	1000	55303.025.016	M4X50*	500	55303.040.050	M6X18*	500	55303.060.018
M2,5X20*	1000	55303.025.020	M4X55*	500	55303.040.055	M6X20*	500	55303.060.020
M2,5X25*	1000	55303.025.025	M4X60*	500	55303.040.060	M6X22*	500	55303.060.022
			M4X70*	200	55303.040.070	M6X25*	200	55303.060.025
M3X4*	500	55303.030.004	M4X80*	200	55303.040.080	M6X30*	200	55303.060.030
M3X5*	500	55303.030.005	M4X90*	200	55303.040.090	M6X35*	200	55303.060.035
M3X6*	500	55303.030.006				M6X40*	200	55303.060.040
M3X10*	500	55303.030.010	M5X6*	500	55303.050.006	M6X45*	200	55303.060.045

55303 Wkręty z łbem stożkowym płaskim z gniazdem sześciokątnym								
d x L	☒	Kod artykułu	d x L	☒	Kod artykułu	d x L	☒	Kod artykułu
M6X50*	200	55303.060.050				M8X35*	200	55303.080.035
M6X55*	200	55303.060.055	M8X10*	200	55303.080.010	M8X40*	200	55303.080.040
M6X60*	200	55303.060.060	M8X12*	200	55303.080.012	M8X45*	200	55303.080.045
M6X70*	200	55303.060.070	M8X16*	200	55303.080.016	M8X50*	200	55303.080.050
M6X80*	200	55303.060.080	M8X20*	200	55303.080.020	M8X60*	200	55303.080.060
M6X90*	200	55303.060.090	M8X25*	200	55303.080.025	M8X70*	200	55303.080.070
M6X100*	200	55303.060.100	M8X30*	200	55303.080.030	M8X80*	200	55303.080.080

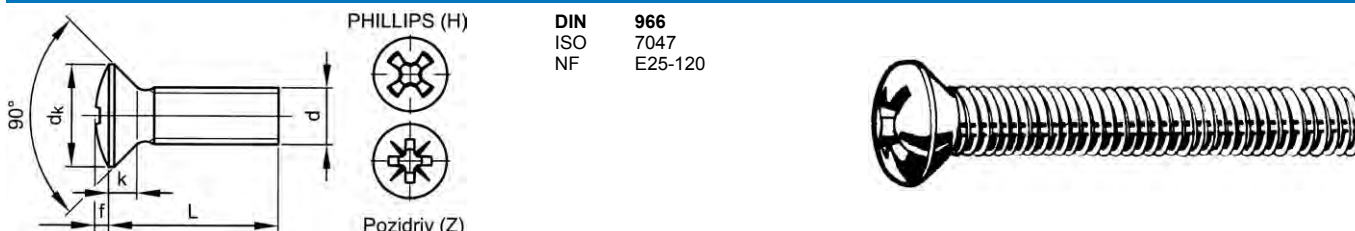

Wkręty z łbem stożkowym soczewkowym z gniazdem krzyżowym



Informacje techniczne						
d	d _k	f ≈	k (maks.)	Nr wgłębienia krzyżowego	P	Pelen gwint L ≤
M2	3.8	0.5	1.2	1	0.4	16
M2.5	4.7	0.6	1.5	1	0.45	18
M3	5.6	0.75	1.65	1	0.5	20
M4	7.5	1	2.2	2	0.7	25
M5	9.2	1.25	2.5	2	0.8	30
M6	11	1.5	3	3	1	35
M8	14.5	2	4	4	1.25	40

Grupy katalogowe						
Gwint	Gniazdo	Materiał	Klasa	Obróbka powierzchni	Kod	Strona
M	Phillips	St	4.8	Ocynk.	24691	6-51
M	Phillips	St	4.8	Ocynk.	24690	6-52
M	Pozidriv	St	4.8	Ocynk.	24692	6-52
M	Phillips	St.St. A2			51320	6-52
M	Pozidriv	St.St. A2			51322	6-53
M	Phillips	St.St. A4			55320	6-53
M	Pozidriv	St.St. A4			55322	6-53

24691 Wkręty z łbem stożkowym soczewkowym z gniazdem krzyżowym Phillips					H05A
Gwint	Metryczny	DIN	966-H		
Materiał	Stal	ISO	7047-H		
Klasa	4.8				
Obróbka powierzchni	Ocynkowane				





d x L	☒	Kod artykułu	d x L	☒	Kod artykułu	d x L	☒	Kod artykułu
M3X6	200	24691.030.006	M4X25	200	24691.040.025	M6X12		
M3X8	200	24691.030.008	M4X30	200	24691.040.030	M6X16	200	24691.060.016
M3X10	200	24691.030.010	M4X40	100	24691.040.040	M6X20	100	24691.060.020
M3X12	200	24691.030.012				M6X25	100	24691.060.025
M3X16	200	24691.030.016	M5X8	200	24691.050.008	M6X30	100	24691.060.030
M3X20	200	24691.030.020	M5X10	200	24691.050.010	M6X35	100	24691.060.035
			M5X12	200	24691.050.012	M6X40	100	24691.060.040
M4X6	200	24691.040.006	M5X16	200	24691.050.016	M6X50	100	24691.060.050
M4X8	200	24691.040.008	M5X20	200	24691.050.020			
M4X10	200	24691.040.010	M5X25	200	24691.050.025			
M4X12	200	24691.040.012	M5X30	100	24691.050.030	M8X16	100	24691.080.016
M4X16	200	24691.040.016	M5X35	100	24691.050.035	M8X20	100	24691.080.020
M4X20	200	24691.040.020	M5X40	100	24691.050.040	M8X25	100	24691.080.025

24690 Wkręty z łbem stożkowym soczewkowym z gniazdem krzyżowym Phillips				H05A
Gwint	Metryczny	DIN	966-H	
Materiał	Stal	ISO	7047-H	
Klasa	4.8			
Obróbka powierzchni	Ocynkowane			



d x L	☒	Kod artykułu	d x L	☒	Kod artykułu	d x L	☒	Kod artykułu
M3X10	2000	24690.030.010	M5X8	1000	24690.050.008	M6X20	250	24690.060.020
M3X12	2000	24690.030.012	M5X10	1000	24690.050.010	M6X25	250	24690.060.025
M3X16	2000	24690.030.016	M5X12	1000	24690.050.012	M6X30	250	24690.060.030
M3X20	2000	24690.030.020	M5X16	1000	24690.050.016	M6X35	250	24690.060.035
			M5X20	500	24690.050.020	M6X40	250	24690.060.040
M4X6	1000	24690.040.006	M5X25	500	24690.050.025	M6X50	250	24690.060.050
M4X8	1000	24690.040.008	M5X30	250	24690.050.030			
M4X10	1000	24690.040.010	M5X35	250	24690.050.035	M8X16	250	24690.080.016
M4X12	1000	24690.040.012	M5X40	250	24690.050.040	M8X20	250	24690.080.020
M4X16	1000	24690.040.016	M5X50	250	24690.050.050	M8X25	250	24690.080.025
M4X20	1000	24690.040.020				M8X30	250	24690.080.030
M4X25	1000	24690.040.025	M6X10	1000	24690.060.010	M8X35	250	24690.080.035
M4X30	1000	24690.040.030	M6X12	1000	24690.060.012	M8X40	100	24690.080.040
M4X40	500	24690.040.040	M6X16	500	24690.060.016	M8X50	100	24690.080.050

24692 Wkręty z łbem stożkowym soczewkowym z gniazdem krzyżowym Pozidriv				H05A
Gwint	Metryczny	DIN	966-Z	
Materiał	Stal	ISO	7047-Z	
Klasa	4.8			
Obróbka powierzchni	Ocynkowane			



d x L	☒	Kod artykułu	d x L	☒	Kod artykułu	d x L	☒	Kod artykułu
M3X6	2000	24692.030.006	M4X20	1000	24692.040.020			
M3X8	2000	24692.030.008	M4X25	1000	24692.040.025	M6X16	500	24692.060.016
M3X10	2000	24692.030.010	M4X30	1000	24692.040.030	M6X20	250	24692.060.020
M3X12	2000	24692.030.012				M6X25	250	24692.060.025
M3X16	2000	24692.030.016	M5X10	1000	24692.050.010	M8X16	250	24692.080.016
M3X20	2000	24692.030.020	M5X12	1000	24692.050.012	M8X20	250	24692.080.020
			M5X16	1000	24692.050.016	M8X25	250	24692.080.025
M4X10	1000	24692.040.010	M5X20	500	24692.050.020	M8X35	250	24692.080.035
M4X12	1000	24692.040.012	M5X25	500	24692.050.025			
M4X16	1000	24692.040.016	M5X30	250	24692.050.030			

51320 Wkręty z łbem stożkowym soczewkowym z gniazdem krzyżowym Phillips				R01A
Gwint	Metryczny	DIN	966-H	
Materiał	Stal nierdzewna A2	ISO	7047-H	



d x L	☒	Kod artykułu	d x L	☒	Kod artykułu	d x L	☒	Kod artykułu
M2X3*	1000	51320.020.003	M3X16	200	51320.030.016	M5X10	100	51320.050.010
M2X4*	1000	51320.020.004	M3X18*	500	51320.030.018	M5X12	100	51320.050.012
M2X5*	1000	51320.020.005	M3X20	200	51320.030.020	M5X14*	500	51320.050.014
M2X6*	1000	51320.020.006	M3X22*	500	51320.030.022	M5X16	100	51320.050.016
M2X8*	1000	51320.020.008	M3X25*	200	51320.030.025	M5X18*	500	51320.050.018
M2X10*	1000	51320.020.010	M3X30	200	51320.030.030	M5X20	100	51320.050.020
M2X12*	1000	51320.020.012				M5X22*	500	51320.050.022
M2X14*	1000	51320.020.014	M4X6*	500	51320.040.006	M5X25	100	51320.050.025
M2X16*	1000	51320.020.016	M4X8	200	51320.040.008	M5X30	100	51320.050.030
M2X18*	1000	51320.020.018	M4X10	200	51320.040.010	M5X35	100	51320.050.035
M2X20*	1000	51320.020.020	M4X12	200	51320.040.012	M5X40	100	51320.050.040
M2X25*	1000	51320.020.025	M4X14*	500	51320.040.014	M5X45*	200	51320.050.045
M2X30*	1000	51320.020.030	M4X16	200	51320.040.016	M5X50	100	51320.050.050
			M4X18*	500	51320.040.018	M5X60	100	51320.050.060
M2,5X5*	1000	51320.025.005	M4X20	200	51320.040.020	M5X70	100	51320.050.070
M2,5X6	100	51320.025.006	M4X22*	500	51320.040.022	M5X75*	200	51320.050.075
M2,5X8*	1000	51320.025.008	M4X25	200	51320.040.025	M5X80*	200	51320.050.080
M2,5X10	100	51320.025.010	M4X30	200	51320.040.030	M5X90*	200	51320.050.090
M2,5X12*	1000	51320.025.012	M4X35*	500	51320.040.035	M5X100*	200	51320.050.100
			M4X40	200	51320.040.040			
M3X5*	500	51320.030.005	M4X45*	500	51320.040.045	M6X8*	500	51320.060.008
M3X6	200	51320.030.006	M4X50	200	51320.040.050	M6X10	100	51320.060.010
M3X8	200	51320.030.008	M4X60	200	51320.040.060	M6X12	100	51320.060.012
M3X10	200	51320.030.010				M6X14*	500	51320.060.014
M3X12	200	51320.030.012	M5X6*	500	51320.050.006	M6X16	100	51320.060.016
M3X14*	500	51320.030.014	M5X8	100	51320.050.008	M6X18*	500	51320.060.018

51320 Wkręty z łbem stożkowym soczewkowym z gniazdem krzyżowym Phillips								
d x L	☒	Kod artykułu	d x L	☒	Kod artykułu	d x L	☒	Kod artykułu
M6X20	100	51320.060.020	M6X70*	200	51320.060.070	M8X25	100	51320.080.025
M6X25	100	51320.060.025	M6X75*	200	51320.060.075	M8X30	100	51320.080.030
M6X30	100	51320.060.030	M6X80	200	51320.060.080	M8X35	100	51320.080.035
M6X35	100	51320.060.035	M6X95*	200	51320.060.095	M8X40	100	51320.080.040
M6X40	100	51320.060.040	M6X100*	200	51320.060.100	M8X45*	200	51320.080.045
M6X45	100	51320.060.045				M8X50	100	51320.080.050
M6X50	100	51320.060.050	M8X12*	200	51320.080.012	M8X60	100	51320.080.060
M6X55*	200	51320.060.055	M8X16*	200	51320.080.016	M8X70*	100	51320.080.070
M6X60	100	51320.060.060	M8X20	100	51320.080.020	M8X80*	100	51320.080.080



51322 Wkręty z łbem stożkowym soczewkowym z gniazdem krzyżowym Pozidriv					R01A
Gwint	Metryczny		DIN	966-Z	
Material	Stal nierdzewna A2		ISO	7047-Z	



d x L	☒	Kod artykułu	d x L	☒	Kod artykułu	d x L	☒	Kod artykułu
M2X3*	1000	51322.020.003				M5X20	100	51322.050.020
M2X4*	1000	51322.020.004	M4X6*	500	51322.040.006	M5X25	100	51322.050.025
M2X5*	1000	51322.020.005	M4X8	200	51322.040.008	M5X30	100	51322.050.030
M2X6*	1000	51322.020.006	M4X10	200	51322.040.010	M5X35	100	51322.050.035
M2X12*	1000	51322.020.012	M4X12	200	51322.040.012	M5X40	100	51322.050.040
M2X16*	1000	51322.020.016	M4X14*	500	51322.040.014	M5X45*	200	51322.050.045
			M4X16	200	51322.040.016	M5X50*	200	51322.050.050
M2,5X5*	1000	51322.025.005	M4X20	200	51322.040.020			
M2,5X6*	1000	51322.025.006	M4X25	200	51322.040.025	M6X10	100	51322.060.010
M2,5X8*	1000	51322.025.008	M4X30	200	51322.040.030	M6X12	100	51322.060.012
M2,5X10*	1000	51322.025.010	M4X35*	500	51322.040.035	M6X16	100	51322.060.016
			M4X40*	500	51322.040.040	M6X20	100	51322.060.020
M3X5*	500	51322.030.005				M6X25	100	51322.060.025
M3X6*	500	51322.030.006	M5X6*	500	51322.050.006	M6X30	100	51322.060.030
M3X8	200	51322.030.008	M5X8	100	51322.050.008	M6X35	100	51322.060.035
M3X10	200	51322.030.010	M5X10	100	51322.050.010	M6X40	100	51322.060.040
M3X12	200	51322.030.012	M5X12	100	51322.050.012	M6X50*	200	51322.060.050
M3X16	200	51322.030.016	M5X14*	500	51322.050.014			
M3X25*	500	51322.030.025	M5X16	100	51322.050.016	M8X30*	200	51322.080.030
M3X30*	500	51322.030.030	M5X18*	500	51322.050.018	M8X50*	200	51322.080.050

6

55320 Wkręty z łbem stożkowym soczewkowym z gniazdem krzyżowym Phillips					R41A
Gwint	Metryczny		DIN	966-H	
Material	Stal nierdzewna A4		ISO	7047-H	

d x L	☒	Kod artykułu	d x L	☒	Kod artykułu	d x L	☒	Kod artykułu
M3X6*	500	55320.030.006	M3X30*	500	55320.030.030	M4X40*	500	55320.040.040
M3X8*	500	55320.030.008				M4X50*	500	55320.040.050
M3X10*	500	55320.030.010	M4X8*	500	55320.040.008			
M3X12*	500	55320.030.012	M4X12*	500	55320.040.012	M5X8*	500	55320.050.008
M3X16*	500	55320.030.016	M4X25*	500	55320.040.025			
M3X20*	500	55320.030.020	M4X30*	500	55320.040.030	M6X40*	200	55320.060.040
M3X25*	500	55320.030.025	M4X35*	500	55320.040.035			

55322 Wkręty z łbem stożkowym soczewkowym z gniazdem krzyżowym Pozidriv					R41A
Gwint	Metryczny		DIN	966-Z	
Material	Stal nierdzewna A4		ISO	7047-Z	

d x L	☒	Kod artykułu	d x L	☒	Kod artykułu	d x L	☒	Kod artykułu
M2X6	100	55322.020.006	M3X5*	500	55322.030.005			
M2X8	100	55322.020.008	M3X6	200	55322.030.006	M4X5*	500	55322.040.005
M2X10	100	55322.020.010	M3X8	200	55322.030.008	M4X6*	500	55322.040.006
			M3X10	200	55322.030.010	M4X8	500	55322.040.008
M2,5X6	100	55322.025.006	M3X12	200	55322.030.012	M4X10	200	55322.040.010
M2,5X8	100	55322.025.008	M3X16	200	55322.030.016	M4X12	200	55322.040.012
M2,5X10	100	55322.025.010	M3X18*	500	55322.030.018	M4X14*	500	55322.040.014
M2,5X12	100	55322.025.012	M3X20*	500	55322.030.020	M4X16	200	55322.040.016
			M3X25*	500	55322.030.025	M4X18*	500	55322.040.018
M3X4*	500	55322.030.004	M3X30*	500	55322.030.030	M4X20	200	55322.040.020

55322 Wkręty z łbem stożkowym soczewkowym z gniazdem krzyżowym Pozidriv								
d x L	☒	Kod artykułu	d x L	☒	Kod artykułu	d x L	☒	Kod artykułu
M4X25	200	55322.040.025	M5X20	100	55322.050.020	M6X16	100	55322.060.016
M4X30	200	55322.040.030	M5X25	100	55322.050.025	M6X20	100	55322.060.020
M4X35*	500	55322.040.035	M5X30	100	55322.050.030	M6X25	100	55322.060.025
M4X40*	500	55322.040.040	M5X35*	500	55322.050.035	M6X30	100	55322.060.030
M4X50*	500	55322.040.050	M5X40	100	55322.050.040	M6X35	100	55322.060.035
M5X8	100	55322.050.008	M5X50*	200	55322.050.050	M6X40	100	55322.060.040
M5X10	100	55322.050.010	M5X70*	200	55322.050.070	M6X50*	200	55322.060.050
M5X12	100	55322.050.012	M6X10	100	55322.060.010	M6X60*	200	55322.060.060
M5X16	100	55322.050.016	M6X12	100	55322.060.012			

Wkręt stożkowo-wypukły z gniazdem torx

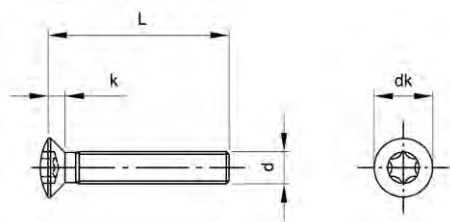

DIN ≈966
ISO ≈14584

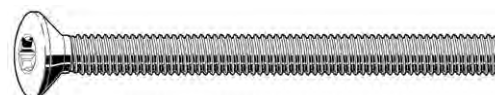

Informacje techniczne

d	d _k	k (maks.)	Nasadka	P
M3	5.6	1.65	T10	0.5
M4	7.5	2.2	T20	0.7
M5	9.2	2.5	T25	0.8
M6	11	3	T30	1

Grupy katalogowe

Gwint	Gniazdo	Materiał	Kod	Strona
M	Sześciokarbowy	St.St. A2	51325	6-54
M	Sześciokarbowy	St.St. A4	55325	6-55

51325 Wkręt stożkowo-wypukły z gniazdem torx		R01A
Gwint	Metryczny	
Materiał	Stal nierdzewna A2	



d x L	☒	Kod artykułu	d x L	☒	Kod artykułu	d x L	☒	Kod artykułu
M3X4*	500	51325.030.004	M4X25*	500	51325.040.025	M5X45*	200	51325.050.045
M3X5*	500	51325.030.005	M4X30*	500	51325.040.030	M5X50*	200	51325.050.050
M3X6*	500	51325.030.006	M4X35*	500	51325.040.035	M5X55*	200	51325.050.055
M3X8*	500	51325.030.008	M4X40*	500	51325.040.040	M5X60*	200	51325.050.060
M3X10*	500	51325.030.010	M4X45*	500	51325.040.045	M5X70*	200	51325.050.070
M3X12*	500	51325.030.012	M4X50*	500	51325.040.050	M6X10*	500	51325.060.010
M3X16*	500	51325.030.016	M4X60*	500	51325.040.060	M6X12*	500	51325.060.012
M3X20*	500	51325.030.020	M5X6*	500	51325.050.006	M6X16*	500	51325.060.016
M3X25*	500	51325.030.025	M5X8*	500	51325.050.008	M6X20*	500	51325.060.020
M3X30*	500	51325.030.030	M5X10*	500	51325.050.010	M6X25*	200	51325.060.025
M3X35*	500	51325.030.035	M5X12*	500	51325.050.012	M6X30*	200	51325.060.030
M3X40*	500	51325.030.040	M5X16*	500	51325.050.016	M6X35*	200	51325.060.035
M4X8*	500	51325.040.008	M5X20*	500	51325.050.020	M6X40*	200	51325.060.040
M4X10*	500	51325.040.010	M5X25*	500	51325.050.025	M6X45*	200	51325.060.045
M4X12*	500	51325.040.012	M5X30*	500	51325.050.030	M6X50*	200	51325.060.050
M4X16*	500	51325.040.016	M5X35*	500	51325.050.035	M6X60*	200	51325.060.060
M4X20*	500	51325.040.020	M5X40*	500	51325.050.040			

55325	Wkręt stożkowo-wypukły z gniazdem torx	R41A
Gwint	Metryczny	
Materiał	Stal nierdzewna A4	

d x L	☒	Kod artykułu	d x L	☒	Kod artykułu	d x L	☒	Kod artykułu
M4X5*	500	55325.040.005	M5X10*	500	55325.050.010	M6X12*	500	55325.060.012
M4X6*	500	55325.040.006	M5X12*	500	55325.050.012	M6X16*	500	55325.060.016
M4X8*	500	55325.040.008	M5X16*	500	55325.050.016	M6X20*	500	55325.060.020
M4X10*	500	55325.040.010	M5X20*	500	55325.050.020	M6X25*	200	55325.060.025
M4X12*	500	55325.040.012	M5X25*	500	55325.050.025	M6X30*	200	55325.060.030
M4X16*	500	55325.040.016	M5X30*	500	55325.050.030	M6X35*	200	55325.060.035
M4X20*	500	55325.040.020	M5X35*	500	55325.050.035	M6X40*	200	55325.060.040
M4X25*	500	55325.040.025	M5X40*	500	55325.050.040	M6X50*	200	55325.060.050
M4X30*	500	55325.040.030	M5X50*	200	55325.050.050	M6X60*	200	55325.060.060
M4X40*	500	55325.040.040	M5X60*	200	55325.050.060			

Wkręty z łbem grzybkowym z wgłębieniem krzyżowym

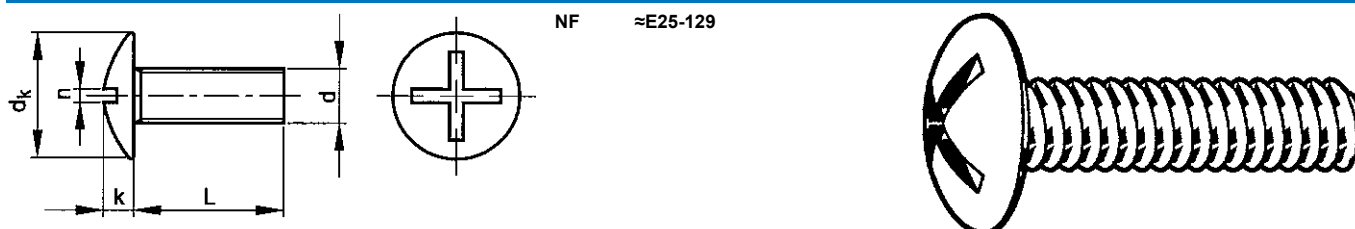

6

Informacje techniczne

d	d _k (maks.)	k (maks.)	n (maks.)	P
M5	12	4	1.3	0.8
M6	14	4.2	1.7	1
M8	20	4.4	2.31	1.25
M10	25	5.5	2.81	1.5

- M6 Zastosowanie w połączeniu z ostro zakończonymi nakrętkami w szafkach.

24650	Wkręty z łbem grzybkowym z wgłębieniem krzyżowym	H01X
Gwint	Metryczny	
Materiał	Stal	
Klasa	4.8	
Obróbka powierzchni	Ocynkowane	

d x L	☒	Kod artykułu	d x L	☒	Kod artykułu	d x L	☒	Kod artykułu
M5X8	1000	24650.050.008	M6X30	200	24650.060.030	M8X40	100	24650.080.040
M5X10	1000	24650.050.010	M6X40	100	24650.060.040	M8X50	100	24650.080.050
M5X12	1000	24650.050.012	M6X50	100	24650.060.050	M8X60	100	24650.080.060
M5X16	1000	24650.050.016	M6X60	100	24650.060.060	M8X80	100	24650.080.080
			M6X80	100	24650.060.080	M8X100	100	24650.080.100
M6X10	1000	24650.060.010						
M6X12	1000	24650.060.013	M8X15	200	24650.080.016	M10X40	100	24650.100.040
M6X16	200	24650.060.016	M8X20	100	24650.080.020			
M6X20	200	24650.060.020	M8X30	100	24650.080.030			

Wkręty z łbem grzybkowym z gniazdem krzyżowym

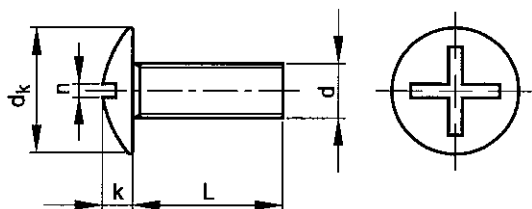

NF E25-129

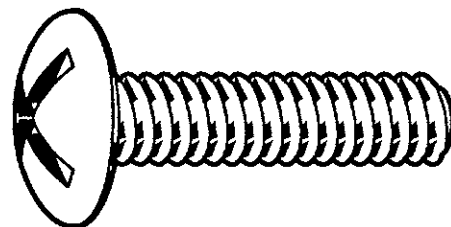

Informacje techniczne

d	d _k (maks.)	k (maks.)	n	P
M4	10.0	2.2	1.2	0.7
M5	12.5	2.7	1.2	0.8
M6	15.0	3.3	1.6	1
M8	20.0	4.4	2.0	1.25
M10	25.0	5.5	2.5	1.5

Grupy katalogowe

Gwint	Gniazdo	Materiał	Klasa	Obróbka powierzchni	Kod	Strona
M	Szczelina	St	4.8	Ocynk.	24862	6-56
M	Szczelina	St	4.8	Ocynk. z nakrętką	24874	6-56

6

24862 Wkręty z łbem grzybkowym z gniazdem krzyżowym		H01X
Gwint	Metryczny	
Materiał	Stal	
Klasa	4.8	
Obróbka powierzchni	Ocynkowane	

d x L	☒	Kod artykułu	d x L	☒	Kod artykułu	d x L	☒	Kod artykułu
M4X10	500	24862.040.010	M6X10	200	24862.060.010	M8X16	200	24862.080.016
M4X16	500	24862.040.016	M6X12	200	24862.060.012	M8X20	100	24862.080.020
M4X20	500	24862.040.020	M6X16	200	24862.060.016	M8X25	100	24862.080.025
M4X25	500	24862.040.025	M6X20	200	24862.060.020	M8X30	100	24862.080.030
M4X30	500	24862.040.030	M6X25	200	24862.060.025	M8X35	200	24862.080.035
M5X10	500	24862.050.010	M6X30	200	24862.060.030	M8X40	100	24862.080.040
M5X16	500	24862.050.016	M6X40	100	24862.060.040	M8X50	100	24862.080.050
M5X20	500	24862.050.020	M6X50	100	24862.060.050	M10X50	100	24862.100.050
M5X25	200	24862.050.025	M6X60	100	24862.060.060	M10X60	50	24862.100.060
M5X30	200	24862.050.030	M6X70	100	24862.060.070			
			M6X100	100	24862.060.100			

24874 Wkręty z łbem grzybkowym z gniazdem krzyżowym z nakrętką sześciokątną		H01X
Gwint	Metryczny	
Materiał	Stal	
Klasa	4.8	
Obróbka powierzchni	Ocynkowane	

d x L	☒	Kod artykułu	d x L	☒	Kod artykułu	d x L	☒	Kod artykułu
M4X16	500	24874.040.016	M6X10	200	24874.060.010	M8X20	200	24874.080.020
M4X20	500	24874.040.020	M6X12	200	24874.060.012	M8X25	200	24874.080.025
M4X25	500	24874.040.025	M6X16	200	24874.060.016	M8X30	200	24874.080.030
M4X30	500	24874.040.030	M6X20	200	24874.060.020	M8X35	100	24874.080.035
M4X35	200	24874.040.035	M6X25	200	24874.060.025	M8X40	100	24874.080.040
M4X40	200	24874.040.040	M6X30	200	24874.060.030	M8X45	100	24874.080.045
M4X50	200	24874.040.050	M6X35	200	24874.060.035	M8X50	100	24874.080.050
M5X16	200	24874.050.016	M6X40	200	24874.060.040	M8X60	100	24874.080.060
M5X20	200	24874.050.020	M6X45	100	24874.060.045	M8X70	100	24874.080.070
M5X25	200	24874.050.025	M6X50	100	24874.060.050	M8X80	100	24874.080.080
M5X30	200	24874.050.030	M6X60	100	24874.060.060	M8X100	100	24874.080.100
M5X35	200	24874.050.035	M6X70	100	24874.060.070			
M5X40	200	24874.050.040	M6X80	100	24874.060.080	M10X30	100	24874.100.030
M5X50	200	24874.050.050	M6X100	100	24874.060.100	M10X40	100	24874.100.040
M5X60	200	24874.050.060	M8X16	200	24874.080.016	M10X50	100	24874.100.050
						M10X60	50	24874.100.060

Wkręty samogwintujące z łbem walcowym soczewkowym z gniazdem krzyżowym

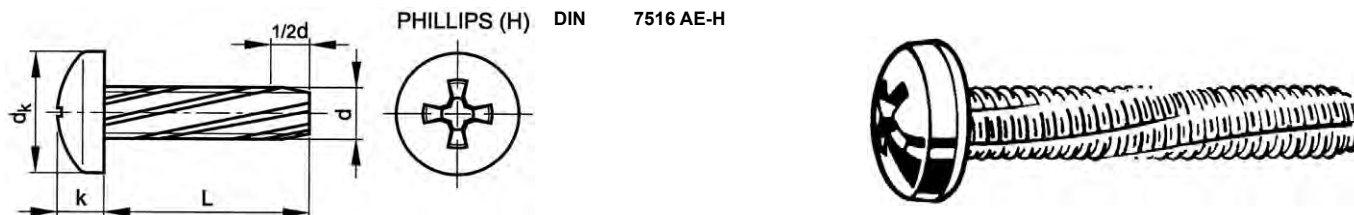

Informacje techniczne

d	d _k	k	Nr wgłębienia krzyżowego	P	Wiertło ø (H11)
M3	6	2.4	1	0.5	2.7
M4	8	3.1	2	0.7	3.6
M5	10	3.8	2	0.8	4.5
M6	12	4.6	3	1	5.5

- Wiertło ø (H11) = Podane średnice otworów to wartości sugerowane dla materiałów o średniej wytrzymałości.
- Dla elementów o cienkich ściankach lub z miękkich materiałów, można wybrać mniejszą średnicę otworu, a dla elementów o grubych ściankach lub z twardych materiałów, większą średnicę otworu.
- Zaleca się aby wyboru dokładnej średnicy dokonać na podstawie testów.
- Głębokość nawiercenia nie powinna przekraczać 2 d.

27100 Wkręty samogwintujące z łbem walcowym soczewkowym z gniazdem krzyżowym Phillips

J04A

Gwint Metryczny
 Materiał Stal
 Obróbka powierzchni Ocynkowane



6

d x L	☒	Kod artykułu	d x L	☒	Kod artykułu	d x L	☒	Kod artykułu
M3X6	2000	27100.030.006	M4X16	2000	27100.040.016	M5X30	500	27100.050.030
M3X8	2000	27100.030.008	M4X20	1000	27100.040.020	M6X12	1000	27100.060.012
M3X10	2000	27100.030.010	M4X25	1000	27100.040.025	M6X16	500	27100.060.016
M3X12	2000	27100.030.012	M5X10	2000	27100.050.010	M6X20	500	27100.060.020
M3X16	2000	27100.030.016	M5X12	1000	27100.050.012	M6X25	500	27100.060.025
M4X8	2000	27100.040.008	M5X16	1000	27100.050.016	M6X30	500	27100.060.030
M4X10	2000	27100.040.010	M5X20	500	27100.050.020	M6X35	250	27100.060.035
M4X12	2000	27100.040.012	M5X25	500	27100.050.025			

- Ostrzeżenie: cynkowanie elektrolityczne tych produktów może wywołać kruchość wodorową.

Wkręty samogwintujące z łbem stożkowym soczewkowym z gniazdem krzyżowym

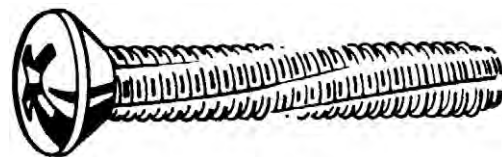
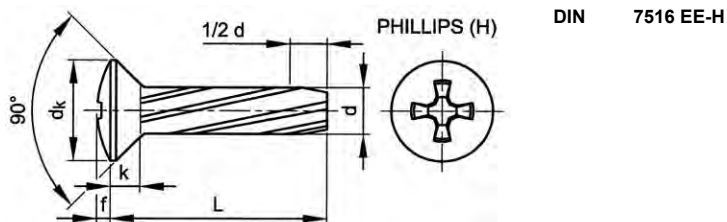

Informacje techniczne

d	d _k	f ≈	k (maks.)	Nr wgłębienia krzyżowego	P	Wiertło ø (H11)
M4	7.5	1	2.2	2	0.7	3.6
M5	9.2	1.25	2.5	2	0.8	4.5
M6	11	1.5	3	3	1	5.5

- Wiertło ø (H11) = Podane średnice otworów to wartości sugerowane dla materiałów o średniej wytrzymałości.
- Dla elementów o cienkich ściankach lub z miękkich materiałów, można wybrać mniejszą średnicę otworu, a dla elementów o grubych ściankach lub z twardych materiałów, większą średnicę otworu.
- Zaleca się aby wyboru dokładnej średnicy dokonać na podstawie testów.
- Głębokość nawiercenia nie powinna przekraczać 2 d.

27180 Wkręty samogwintujące z łbem stożkowym soczewkowym z gniazdem krzyżowym Phillips J04A

Gwint Metryczny
 Materiał Stal
 Obróbka powierzchni Ocynkowane



d x L	☒	Kod artykułu	d x L	☒	Kod artykułu	d x L	☒	Kod artykułu
M4X10	2000	27180.040.010	M5X16	1000	27180.050.016	M6X25	500	27180.060.025
M4X12	2000	27180.040.012	M5X20	500	27180.050.020	M6X30	500	27180.060.030
M4X16	2000	27180.040.016	M5X25	500	27180.050.025	M6X35	250	27180.060.035
M4X20	1000	27180.040.020	M5X30	500	27180.050.030			
M4X25	1000	27180.040.025						

- Ostrzeżenie: cynkowanie elektrolityczne tych produktów może wywołać kruchość wodorową.

Wkręty samogwintujące z łbem stożkowym płaskim z gniazdem krzyżowym

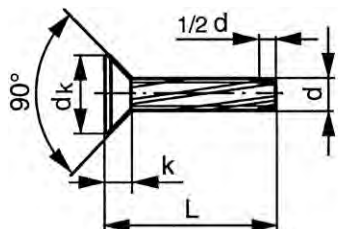

PHILLIPS(H) DIN 7516 DE-H

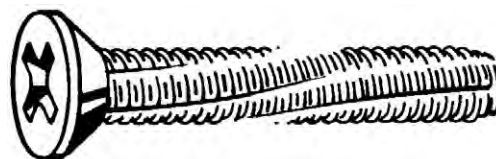

Informacje techniczne

d	d _k	k (maks.)	Nr wgłębienia krzyżowego	P	Wiertło ø (H11)
M3	5.5	1.65	1	0.5	2.7
M4	8.4	2.7	2	0.7	3.6
M5	9.3	2.7	2	0.8	4.5
M6	11.3	3.3	3	1	5.5

- Wiertło ø (H11) = Podane średnice otworów to wartości sugerowane dla materiałów o średniej wytrzymałości.
- Dla elementów o cienkich ściankach lub z miękkich materiałów, można wybrać mniejszą średnicę otworu, a dla elementów o grubych ściankach lub z twardych materiałów, większą średnicę otworu.
- Zaleca się aby wyboru dokładnej średnicy dokonać na podstawie testów.
- Głębokość nawiercenia nie powinna przekraczać 2 d.

27160 Wkręty samogwintujące z łbem stożkowym płaskim z gniazdem krzyżowym Phillips

J04A

Gwint Metryczny
 Materiał Stal
 Obróbka powierzchni Ocynkowane



6

d x L	☒	Kod artykułu	d x L	☒	Kod artykułu	d x L	☒	Kod artykułu
M3X10	2000	27160.030.010	M4X25	1000	27160.040.025	M6X16	500	27160.060.016
M3X12	2000	27160.030.012	M4X30	1000	27160.040.030	M6X20	500	27160.060.020
M3X16	2000	27160.030.016				M6X25	500	27160.060.025
M3X20	2000	27160.030.020	M5X10	1000	27160.050.010	M6X30	500	27160.060.030
			M5X12	1000	27160.050.012	M6X35	250	27160.060.035
M4X10	2000	27160.040.010	M5X16	1000	27160.050.016	M6X40	250	27160.060.040
M4X12	2000	27160.040.012	M5X20	500	27160.050.020			
M4X16	2000	27160.040.016	M5X25	500	27160.050.025			
M4X20	1000	27160.040.020	M5X30	500	27160.050.030			

- Ostrzeżenie: cynkowanie elektrolityczne tych produktów może wywołać kruchość wodorową.

Wkręty samogwintujące z łbem sześciokątnym

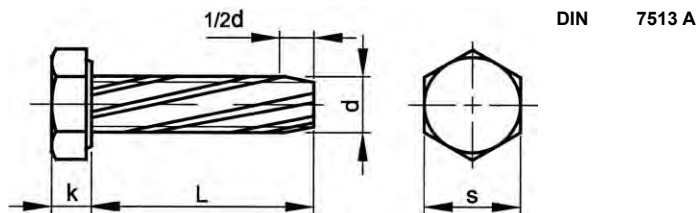

DIN 7513 A

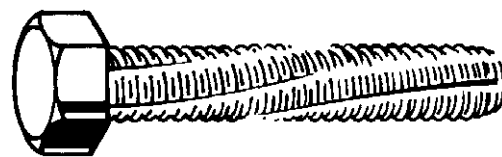

Informacje techniczne

d	k	P	s	Wiertło \varnothing (H11)
M5	3.5	0.8	8	4.5
M6	4	1	10	5.5
M8	5.3	1.25	13	7.4

- Wiertło \varnothing (H11) = Podane średnice otworów to wartości sugerowane dla materiałów o średniej wytrzymałości.
- Dla elementów o cienkich ściankach lub z miękkich materiałów, można wybrać mniejszą średnicę otworu, a dla elementów o grubych ściankach lub z twardych materiałów, większą średnicę otworu.
- Zaleca się aby wyboru dokładnej średnicy dokonać na podstawie testów.
- Głębokość nawiercenia nie powinna przekraczać 2 d.

27010 Wkręty samogwintujące z łbem sześciokątnym

J04A

Gwint Metryczny
 Materiał Stal
 Obróbka powierzchni Ocynkowane



d x L	☒	Kod artykułu	d x L	☒	Kod artykułu	d x L	☒	Kod artykułu
M5X10	2000	27010.050.010	M6X16	500	27010.060.016	M8X16	500	27010.080.016
M5X12	1000	27010.050.012	M6X20	500	27010.060.020	M8X20	250	27010.080.020
M5X16	1000	27010.050.016	M6X25	500	27010.060.025	M8X25	250	27010.080.025
M5X20	500	27010.050.020	M6X30	500	27010.060.030	M8X30	250	27010.080.030
M5X25	500	27010.050.025	M6X35	250	27010.060.035	M8X35	250	27010.080.035
M6X12	1000	27010.060.012				M8X40	200	27010.080.040

- Ostrzeżenie: cynkowanie elektrolityczne tych produktów może wywołać kruchość wodorową.

Wkręty samogwintujące z łbem stożkowym płaskim z gniazdem sześciokarbowym, UNC

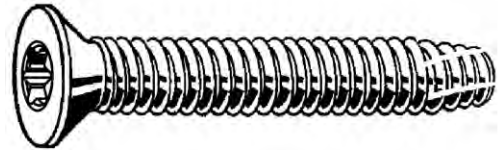
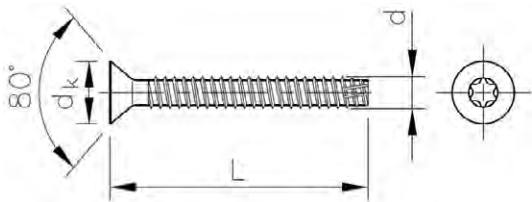

Informacje techniczne

d	d _k	Nasadka	Wiertło ø	Zwoje gwintu na cal
U6.3 (1/4)	12	T30	5.6	20

- Podane średnice otworów to wartości sugerowane dla materiałów o średniej wytrzymałości.
- Dla elementów o cienkich ściankach lub z miękkich materiałów, można wybrać mniejszą średnicę otworu, a dla elementów o grubych ściankach lub z twardych materiałów, większą średnicę otworu.
- Zaleca się aby wybór dokładnej średnicy dokonać na podstawie testów.

31290 Wkręty samogwintujące z łbem stożkowym płaskim z gniazdem sześciokarbowym, UNC		J10A
Gwint	Całowy, zunifikowany grubozwojny (UNC)	
Materiał	Stal	
Obróbka powierzchni	Ocynkowane	

d x L	☒	Kod artykułu	d x L	☒	Kod artykułu	d x L	☒	Kod artykułu
6,3X38MM	1000	31290.063.038	6,3X65MM	500	31290.063.065	6,3X80MM	500	31290.063.080
6,3X50MM	1000	31290.063.050						

TAPTITE 2000® Samogwintujące śruby i wkręty

Informacje ogólne

Dzięki specjalnemu trójkątnemu (trilobularnemu) przekrojowi i łagodnym krawędziom samogwintujące śruby i wkręty TAPTITE tworzą gwint w nawierconym lub wybitym w ścianie otworze metodą Bezwiórową. Brak tradycyjnego gwintowania sprawia, że nie dochodzi do powstania kłopotliwych, a czasami niedopuszczalnych w procesie montażowym wiórów. Oprócz potwierdzonych zalet swojego poprzednik TAPTITE 2000® ma teraz innowacyjny kształt gwintu: Radius Profile™. Dzięki niemu powstaje nowa generacja materiałów mocujących charakteryzujących się doskonałymi właściwościami mechanicznymi, montażowymi i ergonomicznymi, z których nie korzystała dotąd żadna technologia.

Zastosowanie

Samogwintujące śruby i wkręty TAPTITE 2000® stosuje się ze wszystkimi materiałami o plastyczności do 500 N/mm² lub 150 HB.

Wytrzymałość

Dzięki zastosowaniu utwardzania przez odkształcanie plastyczne materiału, nieprzerwanej struktury włókien i w pełni zachodzącej powierzchni nośnej gwintu, połączenie wytrzymuje znacznie większe obciążenia. W większości przypadków wystarczy również mniejszy rozmiar elementu łączącego niż przy gwintowaniu tradycyjnym. Dzięki temu cała konstrukcja ma mniejszy ciężar. Specjalny kształt Radius Profile™ gwarantuje ponadto niski moment wkręcania przy zwiększeniu siły zacisku wstępnego i siły wyciągania, co skutkuje większym bezpieczeństwem montażu.

Zabezpieczenie

Dzięki sile zaciskającej na flankach gwintu połączenie jest samouszczelniające, nie ma zatem potrzeby korzystania z dodatkowych materiałów zabezpieczających.

Gwint

Przy użyciu samogwintujących śrub i wkrętów TAPTITE 2000® powstaje normalny metryczny gwint ISO, do którego pasują inne metryczne materiały mocujące o tolerancji 6h (zgodne z normą ISO 965).

Wgłębienie, kształt łba i długość końcówki

Dostępne są wszystkie metody wkręcania i kształty łbów. W ofercie mamy również modele z ząbkowaniem poniżej łba, różne kolory, modele z podkładką zabezpieczoną przed wypadnięciem lub naniesionym uszczelniaczem. Stożkowa końcówka śrub i wkrętów samogwintujących nowej generacji TAPTITE 2000® została zmniejszona do rozmiaru ok. 2 – 2,5 P (wcześniej maks. 4P).

Materiał i pokrycie powierzchni

Samogwintujące śruby i wkręty TAPTITE 2000® są wykonane ze stali nawęglanej i pokryte utwardzaną powłoką (min. 450 HV0,3), przy jednoczesnym zachowaniu twardości rdzenia (300-350 HV10). Standardowo śruby/wkręty są cynkowane elektrolitycznie bez użycia chromu Cr+6. Dostępne są również inne pokrycia powierzchni lub materiały.

6

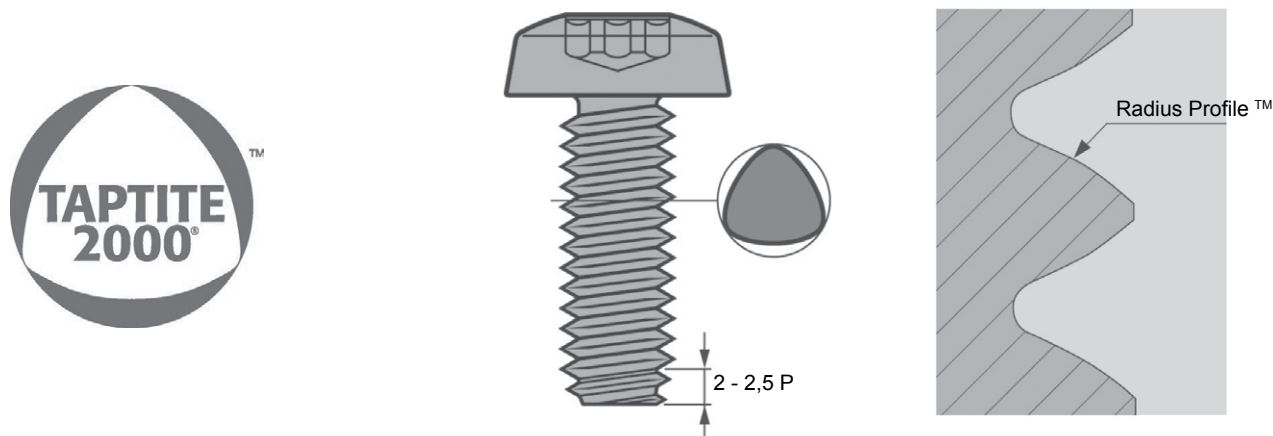

Specyfikacje samogwintujących śrub i wkrętów TAPTITE 2000® (1)

d	M2,5	M3	M3,5	M4	M5	M6	M8
Moment wkręcania (Nm)	0,4	0,8	1,3	2,0	3,2	6,4	16,0
Maks. moment dokręcania (Nm)	0,8	1,5	2,5	3,7	7,0	12,0	30,0
Min. moment końcowy (Nm) (wkręcony)	1,2	2,0	3,3	4,8	10,0	16,0	41,0
Zacisk wstępny podczas montażu (kN)	---	1,9	2,6	3,4	5,6	7,8	15,0

(1) Podane wartości dotyczą montażu w stali St 37 przy długości części wkręcanej 1 x średnica gwintu

TAPTITE 2000® jest zastrzeżonym znakiem towarowym Conti Fasteners AG

Wkręty z łbem sześciokątnym z kołnierzem

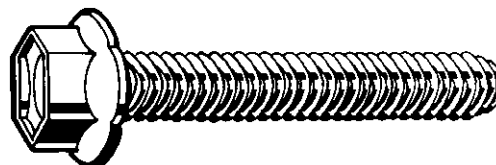
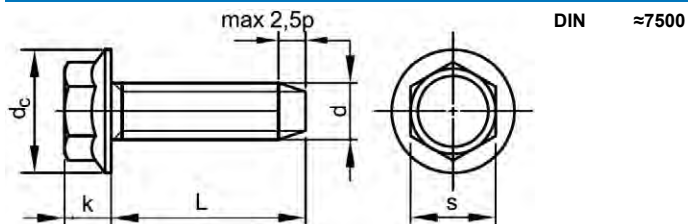

Informacje techniczne

d	d _c (maks.)	k (maks.)	P	s
M3	6.9	2.58	0.5	5.5
M4	8.9	3.58	0.7	7
M5	10.4	4.45	0.8	8
M6	13	5.2	1	10
M8	17	7	1.25	13

- Znamionowa długość (L) ma tolerancję js15.

67020 TAPTITE 2000® Wkręty z łbem sześciokątnym z kołnierzem

J05A

Gwint Metryczny
 Materiał Stal
 Obróbka powierzchni Ocynkowane



6

d x L	☒	Kod artykułu	d x L	☒	Kod artykułu	d x L	☒	Kod artykułu
M3X10	1000	67020.030.010	M5X8	500	67020.050.008	M6X16	500	67020.060.016
M4X6	1000	67020.040.006	M5X10	500	67020.050.010	M6X20	500	67020.060.020
M4X8	1000	67020.040.008	M5X12	500	67020.050.012	M6X25	500	67020.060.025
M4X10	1000	67020.040.010	M5X16	500	67020.050.016	M6X30	500	67020.060.030
M4X12	1000	67020.040.012	M5X20	500	67020.050.020	M8X15	500	67020.080.015
M4X16	1000	67020.040.016	M6X10	500	67020.060.010	M8X20	500	67020.080.020
			M6X12	500	67020.060.012	M8X25	500	67020.080.025

- Ostrzeżenie: cynkowanie elektrolityczne tych produktów może wywołać kruchość wodorową.

Wkręty z łbem stożkowym płaskim z gniazdem Torx®

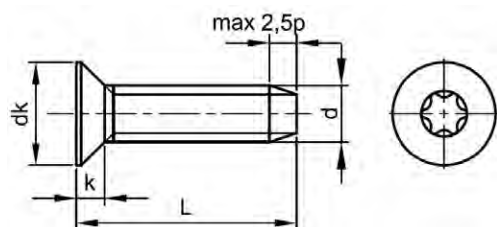

DIN ≈7500-1

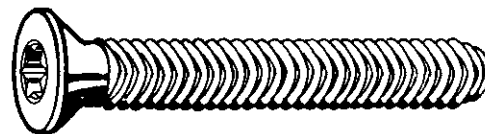

Informacje techniczne

d	d _k	k (maks.)	Nr Torx®	P
M3	5.6	1.65	10	0.5
M4	7.5	2.2	20	0.7
M5	9.2	2.5	25	0.8
M6	11	3	30	1
M8	14.5	4	40	1.25

- Znamionowa długość (L) ma tolerancję js15.

67080 TAPTITE 2000® Wkręty z łbem stożkowym płaskim z gniazdem Torx®

J05A

Gwint Metryczny
 Materiał Stal
 Obróbka powierzchni Ocynkowane



d x L	☒	Kod artykułu	d x L	☒	Kod artykułu	d x L	☒	Kod artykułu
M3X8	1000	67080.030.008	M4X25	1000	67080.040.025	M6X16	500	67080.060.016
M3X10	1000	67080.030.010				M6X20	500	67080.060.020
M3X12	1000	67080.030.012	M5X10	500	67080.050.010	M6X25	500	67080.060.025
M3X16	1000	67080.030.016	M5X12	500	67080.050.012	M6X30	500	67080.060.030
			M5X16	500	67080.050.016	M6X40	500	67080.060.040
M4X10	1000	67080.040.010	M5X20	500	67080.050.020			
M4X12	1000	67080.040.012	M5X25	500	67080.050.025	M8X40	500	67080.080.040
M4X16	1000	67080.040.016	M5X30	500	67080.050.030			
M4X20	1000	67080.040.020						

- Ostrzeżenie: cynkowanie elektrolityczne tych produktów może wywołać kruchość wodorową.

Wkręty z łbem walcowym soczewkowym z gniazdem Torx®

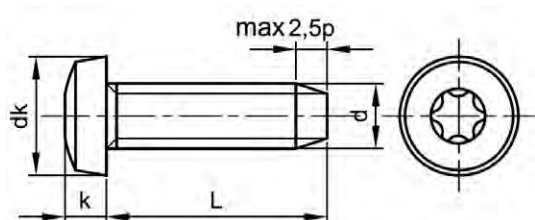

DIN ≈7500-1

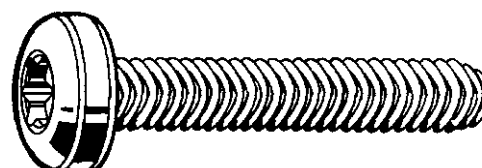

Informacje techniczne

d	d _k	k (maks.)	Nr Torx®	P
M2.5	5	2.12	8	0.45
M3	6	2.52	10	0.5
M3.5	7	2.82	15	0.6
M4	8	3.25	20	0.7
M5	10	3.95	25	0.8
M6	12	4.75	30	1

- Znamionowa długość (L) ma tolerancję js15.

67155 TAPTITE 2000® Wkręty z łbem walcowym soczewkowym z gniazdem Torx®

J05A

Gwint Metryczny
 Materiał Stal
 Obróbka powierzchni Ocynkowane



6

d x L	⊠	Kod artykułu	d x L	⊠	Kod artykułu	d x L	⊠	Kod artykułu
M2,5X16	1000	67155.025.016	M4X6	1000	67155.040.006	M5X12	500	67155.050.012
M3X6	1000	67155.030.006	M4X8	1000	67155.040.008	M5X16	500	67155.050.016
M3X8	1000	67155.030.008	M4X10	1000	67155.040.010	M5X20	500	67155.050.020
M3X10	1000	67155.030.010	M4X12	1000	67155.040.012	M5X25	500	67155.050.025
M3X12	1000	67155.030.012	M4X16	1000	67155.040.016	M5X30	500	67155.050.030
M3X16	1000	67155.030.016	M4X20	1000	67155.040.020	M6X10	500	67155.060.010
M3X20	1000	67155.030.020	M4X25	1000	67155.040.025	M6X12	500	67155.060.012
M3X25	1000	67155.030.025	M4X30	1000	67155.040.030	M6X16	500	67155.060.016
M3,5X8	1000	67155.035.008	M5X8	500	67155.050.008	M6X20	500	67155.060.020
M3,5X12	1000	67155.035.012	M5X10	500	67155.050.010	M6X30	500	67155.060.030

- Ostrzeżenie: cynkowanie elektrolityczne tych produktów może wywołać kruchość wodorową.

Wkręty samogwintujące z łbem walcowym soczewkowym z gniazdem krzyżowym

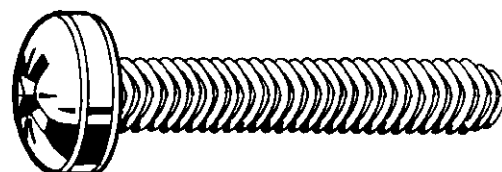
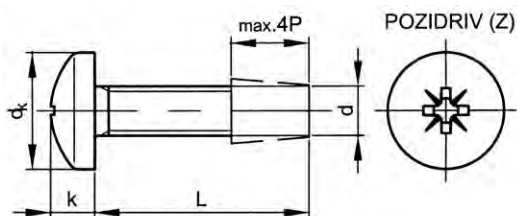

Informacje techniczne

d	dk (maks.)	k (maks.)	Nr wgłębienia krzyżowego	P
M2.5	4.6	1.96	1	0.45
M3	4.7	1.96	1	0.5
M4	7.64	2.92	2	0.7
M5	9.14	3.52	3	0.8
M6	11.57	4.3	3	1

51330 Wkręty samogwintujące z łbem walcowym soczewkowym z gniazdem krzyżowym Pozidriv

R01A

Gwint: Metryczny
 Materiał: Stal nierdzewna A2

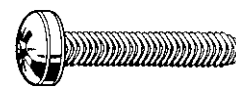

6

d x L	☒	Kod artykułu	d x L	☒	Kod artykułu	d x L	☒	Kod artykułu
M2,5X5*	1000	51330.025.005	M3X20*	1000	51330.030.020	M5X10*	500	51330.050.010
M2,5X6*	1000	51330.025.006	M4X6*	1000	51330.040.006	M5X12*	500	51330.050.012
M2,5X8*	1000	51330.025.008	M4X8*	1000	51330.040.008	M5X16*	500	51330.050.016
M2,5X10*	1000	51330.025.010	M4X10*	1000	51330.040.010	M5X20*	500	51330.050.020
M3X5*	1000	51330.030.005	M4X12*	1000	51330.040.012	M6X10*	500	51330.060.010
M3X6*	1000	51330.030.006	M4X16*	1000	51330.040.016	M6X12*	500	51330.060.012
M3X8*	1000	51330.030.008	M4X20*	1000	51330.040.020	M6X16*	500	51330.060.016
M3X10*	1000	51330.030.010	M5X8*	500	51330.050.008	M6X20*	500	51330.060.020
M3X12*	1000	51330.030.012				M6X25*	500	51330.060.025
M3X16*	1000	51330.030.016						

Wkręty samogwintujące z łbem walcowym soczewkowym z gniazdem sześciokąrnym

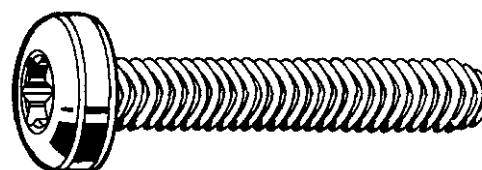
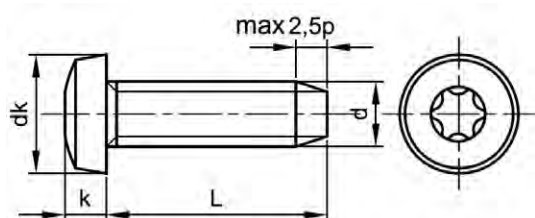

Informacje techniczne

d	d _k (maks.)	k (maks.)	Nasadka	P
M2.5	5	2.1	T8	0.45
M3	5.6	2.4	T10	0.5
M4	8	3.1	T20	0.7
M5	9.5	3.7	T25	0.8
M6	12	4.6	T30	1

51327 Wkręty samogwintujące z łbem walcowym soczewkowym z gniazdem sześciokąrnym

R01A

Gwint Metryczny
Material Stal nierdzewna A2



d x L	☒	Kod artykułu	d x L	☒	Kod artykułu	d x L	☒	Kod artykułu
M2,5X4*	1000	51327.025.004	M3X20*	1000	51327.030.020	M5X12*	500	51327.050.012
M2,5X5*	1000	51327.025.005	M4X6*	1000	51327.040.006	M5X16*	500	51327.050.016
M2,5X6*	1000	51327.025.006	M4X8	1000	51327.040.008	M5X20*	500	51327.050.020
M2,5X8*	1000	51327.025.008	M4X10*	1000	51327.040.010	M5X25*	500	51327.050.025
M2,5X10*	1000	51327.025.010	M4X12*	1000	51327.040.012	M6X8*	500	51327.060.008
M3X5*	1000	51327.030.005	M4X16*	1000	51327.040.016	M6X10*	500	51327.060.010
M3X6*	1000	51327.030.006	M4X20*	1000	51327.040.020	M6X12*	500	51327.060.012
M3X8*	1000	51327.030.008	M4X25*	1000	51327.040.025	M6X16*	500	51327.060.016
M3X10*	1000	51327.030.010	M5X8*	500	51327.050.008	M6X20*	500	51327.060.020
M3X12*	1000	51327.030.012	M5X10*	500	51327.050.010	M6X25*	500	51327.060.025
M3X16*	1000	51327.030.016						

6

Wkręty samogwintujące z łbem stożkowym płaskim z gniazdem krzyżowym

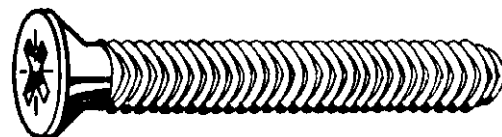
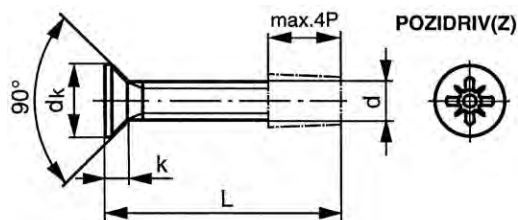

Informacje techniczne

d	d _k (maks.)	k (maks.)	Nr wgłębienia krzyżowego	P
M2.5	4.4	1.5	1	0.45
M3	5.2	1.65	1	0.5
M4	8	2.7	2	0.7
M5	8.9	2.7	2	0.8

51331 Wkręty samogwintujące z łbem stożkowym płaskim z gniazdem krzyżowym Pozidriv

R01A

Gwint Metryczny
Materiał Stal nierdzewna A2



6

d x L	☒	Kod artykułu	d x L	☒	Kod artykułu	d x L	☒	Kod artykułu
M2.5X5*	1000	51331.025.005	M3X12*	1000	51331.030.012	M5X10*	500	51331.050.010
M2.5X6*	1000	51331.025.006	M4X8*	1000	51331.040.008	M5X12	500	51331.050.012
M2.5X8*	1000	51331.025.008	M4X10*	1000	51331.040.010	M5X16*	500	51331.050.016
M2.5X10*	1000	51331.025.010	M4X12*	1000	51331.040.012	M5X20*	500	51331.050.020
M3X6*	1000	51331.030.006	M4X16*	1000	51331.040.016	M5X25*	500	51331.050.025
M3X8*	1000	51331.030.008	M4X20*	1000	51331.040.020	M5X30*	500	51331.050.030
M3X10*	1000	51331.030.010						

Wkręty samogwintujące z łbem stożkowym płaskim z gniazdem sześciokarbowym

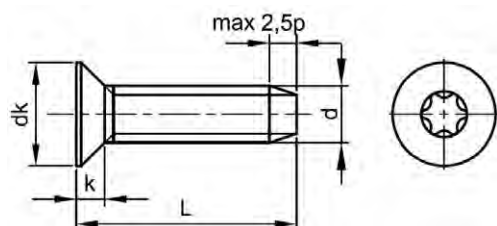

Informacje techniczne

d	d _k (maks.)	k (maks.)	Nasadka	P
M2.5	5	2.1	T8	0.45
M3	5	2.1	T8	0.45
M4	5	2.1	T8	0.45
M5	5	2.1	T8	0.45

51329 Wkręty samogwintujące z łbem stożkowym płaskim z gniazdem sześciokarbowym

R01A

Gwint Metryczny
Materiał Stal nierdzewna A2

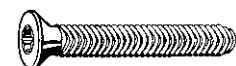

d x L	☒	Kod artykułu	d x L	☒	Kod artykułu	d x L	☒	Kod artykułu
M2.5X5*	1000	51329.025.005	M3X10*	1000	51329.030.010	M5X10*	500	51329.050.010
M2.5X6*	1000	51329.025.006	M3X12*	1000	51329.030.012	M5X12*	500	51329.050.012
M2.5X8*	1000	51329.025.008	M4X8*	1000	51329.040.008	M5X16*	500	51329.050.016
M2.5X10*	1000	51329.025.010	M4X10*	1000	51329.040.010	M5X20*	500	51329.050.020
M2.5X12*	1000	51329.025.012	M4X12*	1000	51329.040.012	M5X25*	500	51329.050.025
M3X6*	1000	51329.030.006	M4X16*	1000	51329.040.016	M5X30*	500	51329.050.030
M3X8*	1000	51329.030.008	M4X20*	1000	51329.040.020			

REMFORM® Śruby samogwintujące do tworzyw sztucznych

Szczególne właściwości śrub samogwintujących do tworzyw sztucznych REMFORM®

- Idealne rozwiązanie do mocowania wszystkich rodzajów tworzyw sztucznych (termoplast lub elastomer)
- Kąt zarysu gwintu tylko 8°
- Asymetryczna geometria gwintu, dzięki której podczas wkręcania tworzywo sztuczne gładko przesuwa się po powierzchni nośnej gwintu
 - ograniczenie ilości przesuwanego materiału
 - mniejszy moment dokręcania
 - głębszy profil
 - wzmocnione pokrycie flank gwarantujące większą wytrzymałość
 - ograniczenie możliwości powstania pęknięć materiału
 - można stosować w łącznikach o cienkich ściankach
- Standardowe wykonanie
 - klasa wytrzymałości 9,8
 - cynkowane elektrolitycznie bez chromu Cr⁶⁺
 - dostępne również inne materiały i pokrycia powierzchni
- Dzięki sile zaciskającej na flankach gwintu połączenie jest samuszczelniające

6

REMFORM® szczegóły gwintu

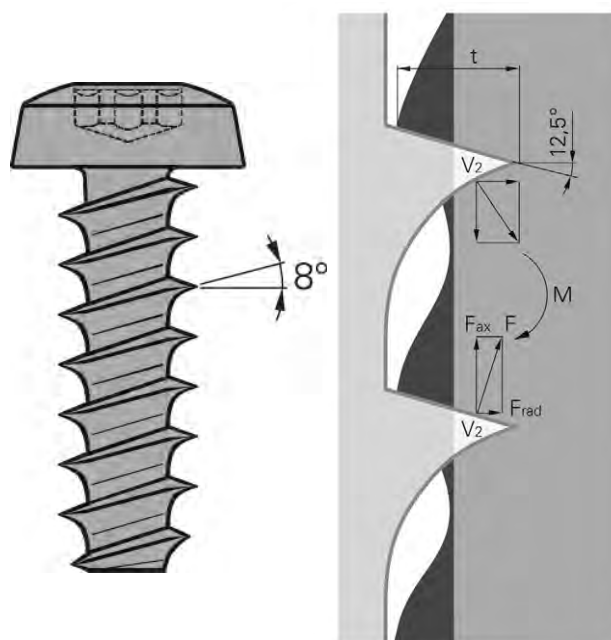

Wkręty samoformujące gwint z łbem walcowym soczewkowym z gniazdem krzyżowym

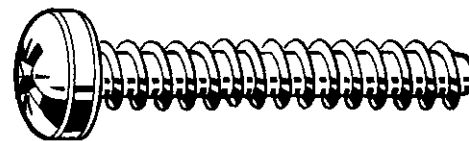
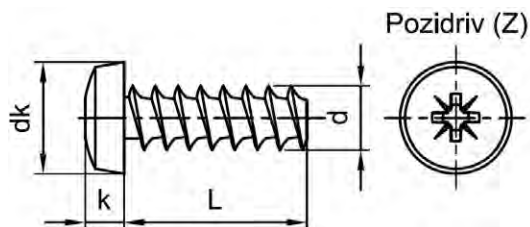

Informacje techniczne

d (nom.)	d _k (maks.)	k (maks.)	Nr wgłębienia krzyżowego
2.2	4.0	1.6	1
2.5	4.4	1.7	1
3.0	5.3	2.0	1
3.5	6.1	2.5	2
4.0	7.0	2.7	2
5.0	8.8	3.4	2
6.0	10.5	4.0	3

67551 REMFORM® Wkręty samoformujące gwint z łbem walcowym soczewkowym z gniazdem krzyżowym Pozidriv

J05A

Gwint REMFORM®
 Materiał Stal
 Obróbka powierzchni Ocynkowane



d (nom.) x L	☒	Kod artykułu	d (nom.) x L	☒	Kod artykułu	d (nom.) x L	☒	Kod artykułu
2,2X6MM	200	67551.022.006	3X10MM	200	67551.030.010	4X14MM	200	67551.040.014
2,2X8MM	200	67551.022.008	3X12MM	200	67551.030.012	4X16MM	200	67551.040.016
2,2X10MM	200	67551.022.010	3X16MM	200	67551.030.016	4X20MM	200	67551.040.020
			3X20MM	200	67551.030.020	4X40MM	200	67551.040.040
2,5X6MM	200	67551.025.006				5X16MM	200	67551.050.016
2,5X8MM	200	67551.025.008	3,5X10MM	200	67551.035.010	5X20MM	200	67551.050.020
2,5X10MM	200	67551.025.010	3,5X12MM	200	67551.035.012	5X25MM	200	67551.050.025
2,5X12MM	200	67551.025.012	3,5X16MM	200	67551.035.016	5X30MM	200	67551.050.030
2,5X16MM	200	67551.025.016	3,5X25MM	200	67551.035.025	5X40MM	200	67551.050.040
3X6MM	200	67551.030.006	4X10MM	200	67551.040.010			
3X8MM	200	67551.030.008	4X12MM	200	67551.040.012	6X20MM	200	67551.060.020

- Ostrzeżenie: cynkowanie elektrolityczne tych produktów może wywołać kruchość wodorową.

Wkręty samoformujące gwint z łbem walcowym soczewkowym z gniazdem Torx®

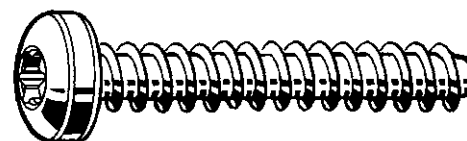
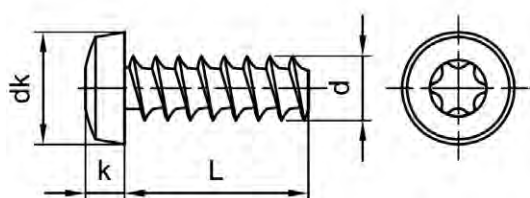

Informacje techniczne

d (nom.)	d _k (maks.)	k (maks.)	Nr Torx®
3.0	5.3	2.0	T10
4.0	7.0	2.7	T20

67552 REMFORM® Wkręty samoformujące gwint z łbem walcowym soczewkowym z gniazdem Torx®			J05A
Gwint	REMFORM®		
Materiał	Stal		
Obróbka powierzchni	Ocynkowane		

d (nom.) x L	☒	Kod artykułu	d (nom.) x L	☒	Kod artykułu	d (nom.) x L	☒	Kod artykułu
3X8MM	200	67552.030.008	4X12MM	200	67552.040.012	4X16MM	200	67552.040.016
3X10MM	200	67552.030.010	4X14MM	200	67552.040.014	4X20MM	200	67552.040.020

- Ostrzeżenie: cynkowanie elektrolityczne tych produktów może wywołać kruchość wodorową.

Wkręty samoformujące gwint z łbem grzybkowym z gniazdem krzyżowym

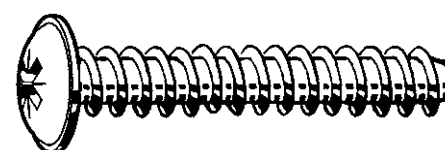
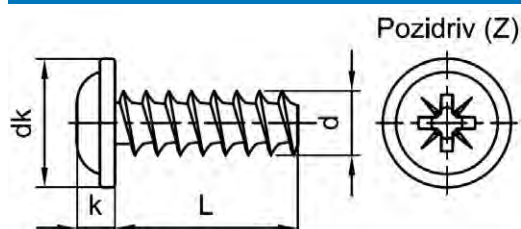

Informacje techniczne

d (nom.)	d _k (maks.)	k (maks.)	Nr wgłębienia krzyżowego
2.5	5	1.7	1
3.0	6	2	1
3.5	7	2.4	2
4.0	8	2.5	2

67553 REMFORM® Wkręty samoformujące gwint z łbem grzybkowym z gniazdem krzyżowym Pozidriv			J05A
Gwint	REMFORM®		
Materiał	Stal		
Obróbka powierzchni	Ocynkowane		

d (nom.) x L	☒	Kod artykułu	d (nom.) x L	☒	Kod artykułu	d (nom.) x L	☒	Kod artykułu
2,5X8MM	200	67553.025.008	3,5X12MM	200	67553.035.012	4X10MM	200	67553.040.010
3X8MM	200	67553.030.008	3,5X16MM	200	67553.035.016	4X12MM	200	67553.040.012
3X10MM	200	67553.030.010	3,5X20MM	200	67553.035.020	4X16MM	200	67553.040.016

- Ostrzeżenie: cynkowanie elektrolityczne tych produktów może wywołać kruchość wodorową.

Wkręty nierdzewne do płyt wiórowych łeb walcowo wypukły

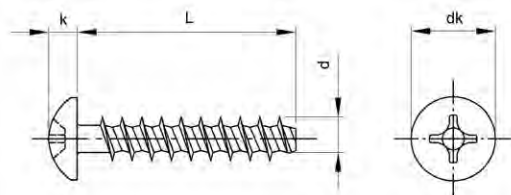

Informacje techniczne

d	d _k	k	Nr wgłębienia krzyżowego
3	5.6	2.2	1
3.5	6.5	2.55	2
4	7.5	2.7	2

51798 Wkręty nierdzewne do płyt wiórowych łeb walcowo wypukły

R03A

Gwint Gwint samoformujący do tworzyw
Materiał Stal nierdzewna A2



d x L	☒	Kod artykułu	d x L	☒	Kod artykułu	d x L	☒	Kod artykułu
3,0X8MM*	500	51798.030.008	3,5X8MM*	500	51798.035.008	4,0X8MM*	500	51798.040.008
3,0X10MM*	500	51798.030.010	3,5X10MM*	500	51798.035.010	4,0X10MM*	500	51798.040.010
3,0X12MM*	500	51798.030.012	3,5X12MM*	500	51798.035.012	4,0X12MM*	500	51798.040.012
3,0X14MM*	500	51798.030.014	3,5X14MM*	500	51798.035.014	4,0X14MM*	500	51798.040.014
3,0X16MM*	500	51798.030.016	3,5X16MM*	500	51798.035.016	4,0X16MM*	500	51798.040.016
3,0X20MM*	500	51798.030.020	3,5X20MM*	500	51798.035.020	4,0X20MM*	500	51798.040.020
3,0X25MM*	500	51798.030.025	3,5X25MM*	500	51798.035.025	4,0X25MM*	500	51798.040.025

6

Wkręty stożkowe nierdzewne do tworzyw

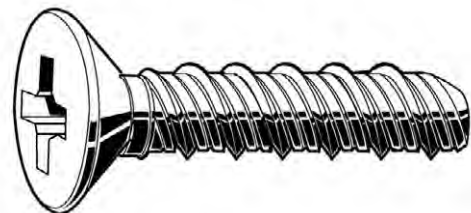
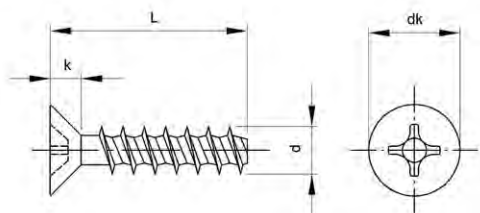

Informacje techniczne

d	d _k	k	Nr wgłębienia krzyżowego
3	5.5	2.2	1
3.5	7.3	2.55	2
4	8.4	2.7	2

51801 Wkręty samoformujące ze stali A2 z gwintem żebrowanym do tworzyw

R03A

Gwint Gwint samoformujący do tworzyw
Materiał Stal nierdzewna A2



d x L	☒	Kod artykułu	d x L	☒	Kod artykułu	d x L	☒	Kod artykułu
3,0X8MM*	500	51801.030.008	3,5X8MM*	500	51801.035.008	4,0X8MM*	500	51801.040.008
3,0X10MM*	500	51801.030.010	3,5X10MM*	500	51801.035.010	4,0X10MM*	500	51801.040.010
3,0X12MM*	500	51801.030.012	3,5X12MM*	500	51801.035.012	4,0X12MM*	500	51801.040.012
3,0X14MM*	500	51801.030.014	3,5X14MM*	500	51801.035.014	4,0X14MM*	500	51801.040.014
3,0X16MM*	500	51801.030.016	3,5X16MM*	500	51801.035.016	4,0X16MM*	500	51801.040.016

Wkręty samogwintujące z łbem walcowym płaskim z nacięciem prostym

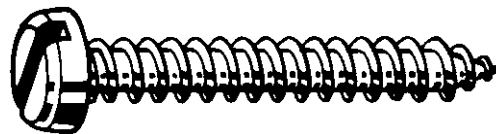
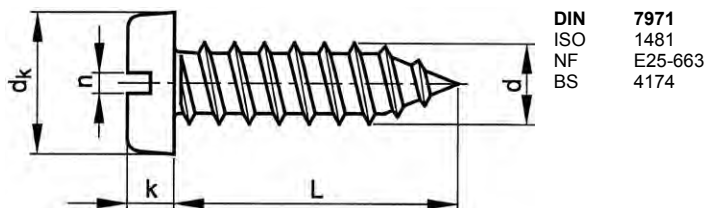

Informacje techniczne

d	dk	k	n	P	d	dk	k	n	P
ST2.2	4.2	1.35	0.6	0.8	ST4.2	8.2	2.45	1.2	1.4
ST2.9	5.6	1.75	0.8	1.1	ST4.8	9.5	2.8	1.2	1.6
ST3.5	6.9	2.1	1	1.3	ST5.5	10.8	3.2	1.6	1.8
ST3.9	7.5	2.25	1	1.4	ST6.3	12.5	3.65	1.6	1.8

Grupy katalogowe

Gwint	Gniazdo	Materiał	Obróbka powierzchni	Kod	Strona
ST	Szczelina	St	Ocyнк.	26600	6-73
ST	Szczelina	St	Nikl.	26000	6-73
ST	Szczelina	St.St. A2		51600	6-74
ST	Szczelina	St	Nikl. bez zaostrenia	26100	6-74

26600 Wkręty samogwintujące z łbem walcowym płaskim z nacięciem prostym

J02A

Gwint	Samogwintujący	DIN	7971 C
Materiał	Stal	ISO	1481 C
Obróbka powierzchni	Ocyńowane	NF	E25-663 C



d x L	☒	Kod artykułu	d x L	☒	Kod artykułu	d x L	☒	Kod artykułu
ST2,9X6,5MM	200	26600.029.006	ST3,9X22MM	200	26600.039.022	ST4,8X32MM	100	26600.048.032
ST2,9X9,5MM	200	26600.029.009	ST3,9X25MM	200	26600.039.025	ST4,8X38MM	100	26600.048.038
ST2,9X13MM	200	26600.029.013	ST3,9X32MM	200	26600.039.032	ST4,8X45MM	100	26600.048.045
ST2,9X16MM	200	26600.029.016	ST3,9X38MM	200	26600.039.038			
ST2,9X19MM	200	26600.029.019				ST5,5X13MM	200	26600.055.013
ST2,9X22MM	200	26600.029.022	ST4,2X9,5MM	200	26600.042.009	ST5,5X16MM	200	26600.055.016
ST2,9X25MM	200	26600.029.025	ST4,2X13MM	200	26600.042.013	ST5,5X19MM	200	26600.055.019
			ST4,2X16MM	200	26600.042.016	ST5,5X22MM	200	26600.055.022
ST3,5X6,5MM	200	26600.035.006	ST4,2X19MM	200	26600.042.019	ST5,5X25MM	100	26600.055.025
ST3,5X9,5MM	200	26600.035.009	ST4,2X22MM	200	26600.042.022	ST5,5X32MM	100	26600.055.032
ST3,5X13MM	200	26600.035.013	ST4,2X25MM	200	26600.042.025	ST5,5X38MM	100	26600.055.038
ST3,5X16MM	200	26600.035.016	ST4,2X32MM	200	26600.042.032	ST5,5X45MM	100	26600.055.045
ST3,5X19MM	200	26600.035.019	ST4,2X38MM	200	26600.042.038	ST5,5X50MM	100	26600.055.050
ST3,5X22MM	200	26600.035.022	ST4,2X45MM	200	26600.042.045			
ST3,5X25MM	200	26600.035.025	ST4,2X50MM	200	26600.042.050	ST6,3X13MM	100	26600.063.013
ST3,5X32MM	200	26600.035.032				ST6,3X16MM	100	26600.063.016
ST3,5X38MM	200	26600.035.038	ST4,8X9,5MM	200	26600.048.009	ST6,3X19MM	100	26600.063.019
			ST4,8X13MM	200	26600.048.013	ST6,3X25MM	100	26600.063.025
ST3,9X9,5MM	200	26600.039.009	ST4,8X16MM	200	26600.048.016	ST6,3X32MM	100	26600.063.032
ST3,9X13MM	200	26600.039.013	ST4,8X19MM	200	26600.048.019	ST6,3X38MM	100	26600.063.038
ST3,9X16MM	200	26600.039.016	ST4,8X22MM	200	26600.048.022	ST6,3X45MM	100	26600.063.045
ST3,9X19MM	200	26600.039.019	ST4,8X25MM	200	26600.048.025	ST6,3X50MM	100	26600.063.050

• Ostrzeżenie: cynkowanie elektrolityczne tych produktów może wywołać kruchość wodorową.

26600 Wkręty samogwintujące z łbem walcowym płaskim z nacięciem prostym

J03A

Gwint	Samogwintujący	DIN	7971 C
Materiał	Stal	ISO	1481 C
Obróbka powierzchni	Niklowane	NF	E25-663 C



d x L	☒	Kod artykułu	d x L	☒	Kod artykułu	d x L	☒	Kod artykułu
ST2,9X6,5MM	200	26600.029.006	ST3,5X16MM	200	26600.035.016	ST3,9X19MM	200	26600.039.019
ST2,9X9,5MM	200	26600.029.009	ST3,5X19MM	200	26600.035.019	ST3,9X25MM	200	26600.039.025
ST2,9X13MM	200	26600.029.013	ST3,5X25MM	200	26600.035.025	ST3,9X32MM	200	26600.039.032
			ST3,5X32MM	200	26600.035.032	ST3,9X38MM	200	26600.039.038
ST3,5X9,5MM	200	26600.035.009						
ST3,5X13MM	200	26600.035.013	ST3,9X9,5MM	200	26600.039.009	ST4,2X9,5MM	200	26600.042.009

26000 Wkręty samogwintujące z łbem walcowym płaskim z nacięciem prostym								
d x L	☒	Kod artykułu	d x L	☒	Kod artykułu	d x L	☒	Kod artykułu
ST4,2X13MM	200	26000.042.013	ST4,8X25MM	200	26000.048.025	ST5,5X25MM	100	26000.055.025
ST4,2X16MM	200	26000.042.016	ST4,8X32MM	100	26000.048.032	ST6,3X13MM	100	26000.063.013
ST4,2X19MM	200	26000.042.019	ST4,8X38MM	100	26000.048.038	ST6,3X16MM	100	26000.063.016
ST4,2X25MM	200	26000.042.025	ST4,8X45MM	100	26000.048.045	ST6,3X19MM	100	26000.063.019
ST4,8X9,5MM	200	26000.048.009	ST4,8X50MM	100	26000.048.050	ST6,3X25MM	100	26000.063.025
ST4,8X13MM	200	26000.048.013	ST5,5X13MM	200	26000.055.013	ST6,3X38MM	100	26000.063.038
ST4,8X16MM	200	26000.048.016	ST5,5X16MM	200	26000.055.016			
ST4,8X19MM	200	26000.048.019	ST5,5X19MM	200	26000.055.019			

• Ostrzeżenie: cynkowanie elektrolityczne tych produktów może wywołać kruchość wodorową.

51600 Wkręty samogwintujące z łbem walcowym płaskim z nacięciem prostym					R02A
Gwint	Samogwintujący	DIN	7971 C		
Materiał	Stal nierdzewna A2	ISO	1481 C		
		NF	E25-663 C		

6

d x L	☒	Kod artykułu	d x L	☒	Kod artykułu	d x L	☒	Kod artykułu
ST2,2X6,5MM*	1000	51600.022.006	ST3,9X13MM	200	51600.039.013	ST4,8X38MM	200	51600.048.038
ST2,2X9,5MM*	1000	51600.022.009	ST3,9X16MM	200	51600.039.016	ST4,8X45MM	200	51600.048.045
ST2,2X13MM*	1000	51600.022.013	ST3,9X19MM	200	51600.039.019	ST4,8X50MM	200	51600.048.050
ST2,2X16MM*	1000	51600.022.016	ST3,9X22MM	200	51600.039.022	ST4,8X60MM	200	51600.048.060
ST2,2X22MM*	1000	51600.022.022	ST3,9X25MM	200	51600.039.025	ST4,8X70MM	200	51600.048.070
ST2,2X25MM*	1000	51600.022.025	ST3,9X32MM	200	51600.039.032			
ST2,2X4,5MM*	1000	51600.022.045	ST3,9X38MM	200	51600.039.038	ST5,5X13MM	200	51600.055.013
ST2,9X6,5MM	200	51600.029.006	ST4,2X6,5MM*	1000	51600.042.006	ST5,5X16MM	200	51600.055.016
ST2,9X9,5MM	200	51600.029.009	ST4,2X9,5MM	200	51600.042.009	ST5,5X19MM	200	51600.055.019
ST2,9X13MM	200	51600.029.013	ST4,2X13MM	200	51600.042.013	ST5,5X22MM	200	51600.055.022
ST2,9X16MM	200	51600.029.016	ST4,2X16MM	200	51600.042.016	ST5,5X25MM	200	51600.055.025
ST2,9X19MM	200	51600.029.019	ST4,2X19MM	200	51600.042.019	ST5,5X32MM	100	51600.055.032
ST2,9X22MM	200	51600.029.022	ST4,2X22MM*	1000	51600.042.022	ST5,5X38MM	100	51600.055.038
ST2,9X25MM	200	51600.029.025	ST4,2X25MM	200	51600.042.025	ST5,5X45MM	100	51600.055.045
ST3,5X6,5MM	200	51600.035.006	ST4,2X32MM	200	51600.042.032	ST5,5X50MM	100	51600.055.050
ST3,5X9,5MM	200	51600.035.009	ST4,2X38MM	200	51600.042.038	ST5,5X70MM*	200	51600.055.070
ST3,5X13MM	200	51600.035.013	ST4,2X45MM	200	51600.042.045	ST6,3X13MM	100	51600.063.013
ST3,5X16MM	200	51600.035.016	ST4,2X50MM	200	51600.042.050	ST6,3X16MM	100	51600.063.016
ST3,5X19MM	200	51600.035.019	ST4,2X60MM*	200	51600.042.060	ST6,3X19MM	100	51600.063.019
ST3,5X22MM	200	51600.035.022	ST4,8X9,5MM	200	51600.048.009	ST6,3X22MM	100	51600.063.022
ST3,5X25MM	200	51600.035.025	ST4,8X13MM	200	51600.048.013	ST6,3X25MM	100	51600.063.025
ST3,5X32MM	200	51600.035.032	ST4,8X16MM	200	51600.048.016	ST6,3X32MM	100	51600.063.032
ST3,5X38MM	200	51600.035.038	ST4,8X19MM	200	51600.048.019	ST6,3X38MM	100	51600.063.038
ST3,9X6,5MM	200	51600.039.006	ST4,8X22MM	200	51600.048.022	ST6,3X45MM	100	51600.063.045
ST3,9X9,5MM	200	51600.039.009	ST4,8X25MM	200	51600.048.025	ST6,3X50MM	100	51600.063.050
			ST4,8X32MM	200	51600.048.032	ST6,3X60MM*	200	51600.063.060
						ST6,3X70MM*	200	51600.063.070

26100 Wkręty samogwintujące z łbem walcowym płaskim z nacięciem prostym, bez zaostrenia					J03A
Gwint	Samogwintujący	DIN	7971 F		
Materiał	Stal	ISO	1481 F		
Obróbka powierzchni	Niklowane	NF	E25-663 F		

d x L	☒	Kod artykułu	d x L	☒	Kod artykułu	d x L	☒	Kod artykułu
ST2,2X4,5MM	500	26100.022.004	ST2,2X8MM	500	26100.022.008	ST2,9X6,5MM	500	26100.029.006
ST2,2X6,5MM	500	26100.022.006	ST2,2X9,5MM	500	26100.022.009			

• Ostrzeżenie: cynkowanie elektrolityczne tych produktów może wywołać kruchość wodorową.

Wkręty samogwintujące z łbem stożkowym płaskim z nacięciem prostym

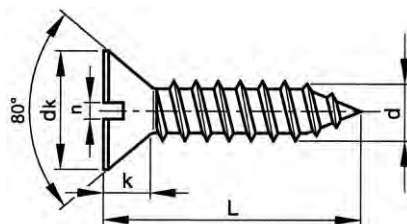

DIN 7972 C
ISO 1482 C
NF E25-660 C
BS 4174

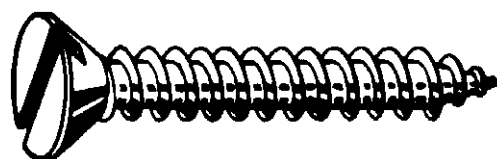

Informacje techniczne

d	d _k	k ≈	n	P	d	d _k	k ≈	n	P
ST2.2	4.3	1.3	0.6	0.8	ST4.2	8.1	2.5	1.2	1.4
ST2.9	5.5	1.7	0.8	1.1	ST4.8	9.5	3	1.2	1.6
ST3.5	6.8	2.1	1	1.3	ST5.5	10.8	3.4	1.6	1.8
ST3.9	7.5	2.3	1	1.4	ST6.3	12.4	3.8	1.6	1.8

Grupy katalogowe

Gwint	Gniazdo	Materiał	Obróbka powierzchni	Kod	Strona
ST	Szczelina	St	Ocynk.	26620	6-75
ST	Szczelina	St.St. A2		51620	6-75

26620 Wkręty samogwintujące z łbem stożkowym płaskim z nacięciem prostym

J02A

Gwint Samogwintujący
Materiał Stal
Obróbka powierzchni Ocynkowane



d x L	⊠	Kod artykułu	d x L	⊠	Kod artykułu	d x L	⊠	Kod artykułu
ST2,9X6,5MM	200	26620.029.006	ST3,9X22MM	200	26620.039.022	ST4,8X32MM	100	26620.048.032
ST2,9X9,5MM	200	26620.029.009	ST3,9X25MM	200	26620.039.025	ST4,8X38MM	100	26620.048.038
ST2,9X13MM	200	26620.029.013	ST3,9X32MM	200	26620.039.032	ST4,8X45MM	100	26620.048.045
ST2,9X16MM	200	26620.029.016	ST3,9X38MM	200	26620.039.038	ST4,8X50MM	100	26620.048.050
ST2,9X19MM	200	26620.029.019	ST4,2X9,5MM	200	26620.042.009	ST5,5X13MM	200	26620.055.013
ST2,9X25MM	200	26620.029.025	ST4,2X13MM	200	26620.042.013	ST5,5X16MM	200	26620.055.016
ST3,5X9,5MM	200	26620.035.009	ST4,2X16MM	200	26620.042.016	ST5,5X19MM	200	26620.055.019
ST3,5X13MM	200	26620.035.013	ST4,2X19MM	200	26620.042.019	ST5,5X25MM	100	26620.055.025
ST3,5X16MM	200	26620.035.016	ST4,2X22MM	200	26620.042.022	ST5,5X32MM	100	26620.055.032
ST3,5X19MM	200	26620.035.019	ST4,2X25MM	200	26620.042.025	ST5,5X38MM	100	26620.055.038
ST3,5X22MM	200	26620.035.022	ST4,2X32MM	200	26620.042.032	ST5,5X45MM	100	26620.055.045
ST3,5X25MM	200	26620.035.025	ST4,2X38MM	200	26620.042.038	ST5,5X50MM	100	26620.055.050
ST3,5X32MM	200	26620.035.032	ST4,2X45MM	200	26620.042.045	ST6,3X25MM	100	26620.063.025
ST3,9X9,5MM	200	26620.039.009	ST4,8X13MM	200	26620.048.013	ST6,3X32MM	100	26620.063.032
ST3,9X13MM	200	26620.039.013	ST4,8X16MM	200	26620.048.016	ST6,3X38MM	100	26620.063.038
ST3,9X16MM	200	26620.039.016	ST4,8X19MM	200	26620.048.019	ST6,3X45MM	100	26620.063.045
ST3,9X19MM	200	26620.039.019	ST4,8X25MM	200	26620.048.025	ST6,3X50MM	100	26620.063.050

• Ostrzeżenie: cynkowanie elektrolityczne tych produktów może wywołać kruchość wodorową.

51620 Wkręty samogwintujące z łbem stożkowym płaskim z nacięciem prostym

R02A

Gwint Samogwintujący
Materiał Stal nierdzewna A2



d x L	⊠	Kod artykułu	d x L	⊠	Kod artykułu	d x L	⊠	Kod artykułu
ST2,2X6,5MM*	1000	51620.022.006	ST2,9X25MM	200	51620.029.025	ST3,9X9,5MM	200	51620.039.009
ST2,2X9,5MM*	1000	51620.022.009	ST3,5X6,5MM	200	51620.035.006	ST3,9X13MM	200	51620.039.013
ST2,2X13MM*	1000	51620.022.013	ST3,5X9,5MM	200	51620.035.009	ST3,9X16MM	200	51620.039.016
ST2,2X16MM*	1000	51620.022.016	ST3,5X13MM	200	51620.035.013	ST3,9X19MM	200	51620.039.019
ST2,9X6,5MM	200	51620.029.006	ST3,5X16MM	200	51620.035.016	ST3,9X22MM	200	51620.039.022
ST2,9X9,5MM	200	51620.029.009	ST3,5X19MM	200	51620.035.019	ST3,9X25MM	200	51620.039.025
ST2,9X13MM	200	51620.029.013	ST3,5X22MM	200	51620.035.022	ST3,9X32MM	200	51620.039.032
ST2,9X16MM	200	51620.029.016	ST3,5X25MM	200	51620.035.025	ST3,9X38MM	200	51620.039.038
ST2,9X19MM	200	51620.029.019	ST3,5X32MM	200	51620.035.032			
ST2,9X22MM*	1000	51620.029.022	ST3,5X38MM	200	51620.035.038	ST4,2X9,5MM*	1000	51620.042.009

51620 Wkręty samogwintujące z łbem stożkowym płaskim z nacięciem prostym								
d x L	☒	Kod artykułu	d x L	☒	Kod artykułu	d x L	☒	Kod artykułu
ST4,2X13MM	200	51620.042.013	ST4,8X32MM	200	51620.048.032	ST5,5X60MM*	200	51620.055.060
ST4,2X16MM	200	51620.042.016	ST4,8X38MM	200	51620.048.038	ST5,5X70MM*	200	51620.055.070
ST4,2X19MM	200	51620.042.019	ST4,8X45MM	200	51620.048.045	ST6,3X13MM	100	51620.063.013
ST4,2X22MM	200	51620.042.022	ST4,8X50MM	200	51620.048.050	ST6,3X16MM	100	51620.063.016
ST4,2X25MM	200	51620.042.025	ST4,8X70MM*	200	51620.048.070	ST6,3X19MM	100	51620.063.019
ST4,2X32MM	200	51620.042.032	ST4,8X80MM*	200	51620.048.080	ST6,3X22MM	100	51620.063.022
ST4,2X38MM	200	51620.042.038	ST5,5X13MM	200	51620.055.013	ST6,3X25MM	100	51620.063.025
ST4,2X45MM	200	51620.042.045	ST5,5X16MM	200	51620.055.016	ST6,3X32MM	100	51620.063.032
ST4,2X50MM*	200	51620.042.050	ST5,5X19MM	200	51620.055.019	ST6,3X38MM	100	51620.063.038
ST4,8X9,5MM	200	51620.048.009	ST5,5X22MM	200	51620.055.022	ST6,3X45MM	100	51620.063.045
ST4,8X13MM	200	51620.048.013	ST5,5X25MM	200	51620.055.025	ST6,3X50MM	100	51620.063.050
ST4,8X16MM	200	51620.048.016	ST5,5X32MM	100	51620.055.032	ST6,3X70MM*	200	51620.063.070
ST4,8X19MM	200	51620.048.019	ST5,5X38MM	100	51620.055.038	ST6,3X80MM*	200	51620.063.080
ST4,8X22MM	200	51620.048.022	ST5,5X45MM	100	51620.055.045			
ST4,8X25MM	200	51620.048.025	ST5,5X50MM	100	51620.055.050			

Wkręty samogwintujące z łbem stożkowym soczewkowym z nacięciem prostym

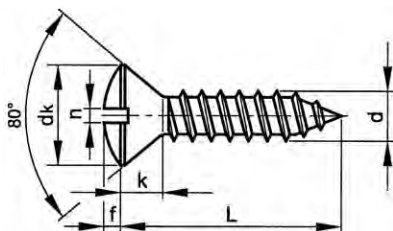

DIN 7973 C
ISO 1483 C
NF E25-661 C
BS 4174

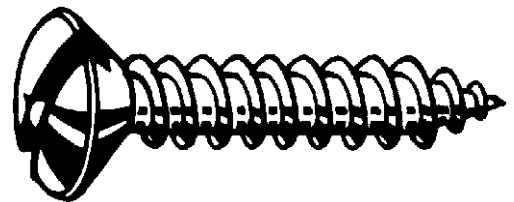

6

Informacje techniczne

d	d _k	f ≈	k ≈	n	P
ST2.2	4.2	0.7	1.3	0.6	0.8
ST2.9	5.5	0.9	1.7	0.8	1.5
ST3.5	6.8	1.2	2.1	1	1.3
ST3.9	7.5	1.3	2.3	1	1.4
ST4.2	8.1	1.4	2.5	1.2	1.4
ST4.8	9.5	1.5	3	1.2	1.6
ST5.5	10.8	1.7	3.4	1.6	1.8
ST6.3	12.4	2	3.8	1.6	1.8

Grupy katalogowe

Gwint	Gniazdo	Materiał	Obróbka powierzchni	Kod	Strona
ST	Szczelina	St	Ocynk.	26640	6-76
ST	Szczelina	St	Nikl.	26040	6-77
ST	Szczelina	St.St. A2		51640	6-77

26640 Wkręty samogwintujące z łbem stożkowym soczewkowym z nacięciem prostym			J02A
Gwint	Samogwintujący		
Materiał	Stal		
Obróbka powierzchni	Ocynkowane		



d x L	☒	Kod artykułu	d x L	☒	Kod artykułu	d x L	☒	Kod artykułu
ST2,9X9,5MM	200	26640.029.009	ST3,9X25MM	200	26640.039.025	ST4,8X32MM	100	26640.048.032
ST2,9X13MM	200	26640.029.013	ST3,9X32MM	200	26640.039.032	ST4,8X38MM	100	26640.048.038
ST2,9X16MM	200	26640.029.016				ST4,8X45MM	100	26640.048.045
ST2,9X19MM	200	26640.029.019	ST4,2X9,5MM	200	26640.042.009	ST4,8X50MM	100	26640.048.050
ST2,9X25MM	200	26640.029.025	ST4,2X13MM	200	26640.042.013			
			ST4,2X16MM	200	26640.042.016	ST5,5X13MM	200	26640.055.013
ST3,5X9,5MM	200	26640.035.009	ST4,2X19MM	200	26640.042.019	ST5,5X16MM	200	26640.055.016
ST3,5X13MM	200	26640.035.013	ST4,2X25MM	200	26640.042.025	ST5,5X19MM	200	26640.055.019
ST3,5X16MM	200	26640.035.016	ST4,2X32MM	200	26640.042.032	ST5,5X25MM	100	26640.055.025
ST3,5X19MM	200	26640.035.019	ST4,2X38MM	200	26640.042.038	ST5,5X32MM	100	26640.055.032
ST3,5X25MM	200	26640.035.025	ST4,2X45MM	200	26640.042.045	ST5,5X38MM	100	26640.055.038
ST3,5X32MM	200	26640.035.032	ST4,2X50MM	200	26640.042.050	ST5,5X45MM	100	26640.055.045
ST3,5X38MM	200	26640.035.038						
			ST4,8X9,5MM	200	26640.048.009	ST6,3X16MM	100	26640.063.016
ST3,9X9,5MM	200	26640.039.009	ST4,8X13MM	200	26640.048.013	ST6,3X19MM	100	26640.063.019
ST3,9X13MM	200	26640.039.013	ST4,8X16MM	200	26640.048.016	ST6,3X25MM	100	26640.063.025
ST3,9X16MM	200	26640.039.016	ST4,8X19MM	200	26640.048.019	ST6,3X32MM	100	26640.063.032
ST3,9X19MM	200	26640.039.019	ST4,8X25MM	200	26640.048.025	ST6,3X38MM	100	26640.063.038

26640 Wkręty samogwintujące z łbem stożkowym soczewkowym z nacięciem prostym

d x L	☒	Kod artykułu	d x L	☒	Kod artykułu
ST6,3X45MM	100	26640.063.045	ST6,3X50MM	100	26640.063.050

• Ostrzeżenie: cynkowanie elektrolityczne tych produktów może wywołać kruchość wodorową.

26040 Wkręty samogwintujące z łbem stożkowym soczewkowym z nacięciem prostym
J03A

Gwint Samogwintujący
Materiał Stal
Obróbka powierzchni Niklowane



d x L	☒	Kod artykułu	d x L	☒	Kod artykułu	d x L	☒	Kod artykułu
ST2,9X13MM	200	26040.029.013	ST3,9X25MM	200	26040.039.025	ST4,8X25MM	200	26040.048.025
ST2,9X19MM	200	26040.029.019	ST3,9X32MM	200	26040.039.032			
			ST3,9X38MM	200	26040.039.038	ST5,5X13MM	200	26040.055.013
ST3,5X13MM	200	26040.035.013				ST5,5X16MM	200	26040.055.016
ST3,5X16MM	200	26040.035.016	ST4,2X16MM	200	26040.042.016	ST5,5X19MM	200	26040.055.019
ST3,5X19MM	200	26040.035.019	ST4,2X19MM	200	26040.042.019	ST5,5X25MM	100	26040.055.025
ST3,5X25MM	200	26040.035.025	ST4,2X25MM	200	26040.042.025	ST5,5X32MM	100	26040.055.032
			ST4,2X38MM	200	26040.042.038	ST5,5X50MM	100	26040.055.050
ST3,9X9,5MM	200	26040.039.009						
ST3,9X13MM	200	26040.039.013	ST4,8X13MM	200	26040.048.013	ST6,3X25MM	100	26040.063.025
ST3,9X16MM	200	26040.039.016	ST4,8X16MM	200	26040.048.016	ST6,3X32MM	100	26040.063.032
ST3,9X19MM	200	26040.039.019	ST4,8X19MM	200	26040.048.019	ST6,3X38MM	100	26040.063.038

• Ostrzeżenie: cynkowanie elektrolityczne tych produktów może wywołać kruchość wodorową.

6

51640 Wkręty samogwintujące z łbem stożkowym soczewkowym z nacięciem prostym
R02A

Gwint Samogwintujący
Materiał Stal nierdzewna A2



d x L	☒	Kod artykułu	d x L	☒	Kod artykułu	d x L	☒	Kod artykułu
ST2,2X9,5MM*	1000	51640.022.009	ST3,9X22MM	200	51640.039.022	ST4,8X45MM	200	51640.048.045
ST2,2X13MM*	1000	51640.022.013	ST3,9X25MM	200	51640.039.025	ST4,8X50MM	200	51640.048.050
			ST3,9X32MM	200	51640.039.032	ST4,8X60MM*	200	51640.048.060
ST2,9X6,5MM	200	51640.029.006	ST3,9X38MM	200	51640.039.038	ST4,8X70MM*	200	51640.048.070
ST2,9X9,5MM	200	51640.029.009						
ST2,9X13MM	200	51640.029.013	ST4,2X9,5MM	200	51640.042.009	ST5,5X13MM	200	51640.055.013
ST2,9X16MM	200	51640.029.016	ST4,2X13MM	200	51640.042.013	ST5,5X16MM*	1000	51640.055.016
ST2,9X19MM	200	51640.029.019	ST4,2X16MM	200	51640.042.016	ST5,5X19MM	200	51640.055.019
ST2,9X22MM	200	51640.029.022	ST4,2X19MM	200	51640.042.019	ST5,5X22MM	200	51640.055.022
ST2,9X25MM	200	51640.029.025	ST4,2X22MM	200	51640.042.022	ST5,5X25MM	200	51640.055.025
			ST4,2X25MM	200	51640.042.025	ST5,5X32MM	100	51640.055.032
ST3,5X6,5MM	200	51640.035.006	ST4,2X32MM	200	51640.042.032	ST5,5X38MM	100	51640.055.038
ST3,5X9,5MM	200	51640.035.009	ST4,2X38MM	200	51640.042.038	ST5,5X45MM	100	51640.055.045
ST3,5X13MM	200	51640.035.013	ST4,2X45MM	200	51640.042.045	ST5,5X50MM	100	51640.055.050
ST3,5X16MM	200	51640.035.016	ST4,2X50MM	200	51640.042.050			
ST3,5X19MM	200	51640.035.019				ST6,3X13MM	100	51640.063.013
ST3,5X22MM	200	51640.035.022	ST4,8X9,5MM	200	51640.048.009	ST6,3X16MM	100	51640.063.016
ST3,5X25MM	200	51640.035.025	ST4,8X13MM	200	51640.048.013	ST6,3X19MM	100	51640.063.019
ST3,5X32MM	200	51640.035.032	ST4,8X16MM	200	51640.048.016	ST6,3X22MM*	500	51640.063.022
ST3,5X38MM	200	51640.035.038	ST4,8X19MM	200	51640.048.019	ST6,3X25MM	100	51640.063.025
			ST4,8X22MM	200	51640.048.022	ST6,3X32MM	100	51640.063.032
ST3,9X9,5MM	200	51640.039.009	ST4,8X25MM	200	51640.048.025	ST6,3X38MM	100	51640.063.038
ST3,9X13MM	200	51640.039.013	ST4,8X32MM	200	51640.048.032	ST6,3X45MM	100	51640.063.045
ST3,9X16MM	200	51640.039.016	ST4,8X38MM	200	51640.048.038	ST6,3X50MM	100	51640.063.050
ST3,9X19MM	200	51640.039.019						

Wkręty samogwintujące z łbem walcowym wypukłym z gniazdem krzyżowym

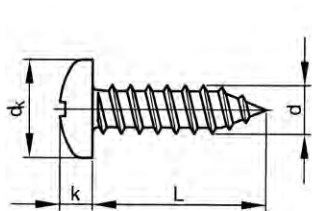

PHILLIPS (H)



Pozidriv (Z)

DIN 7981
ISO 7049
ASME B18.6.4
NF E25-658

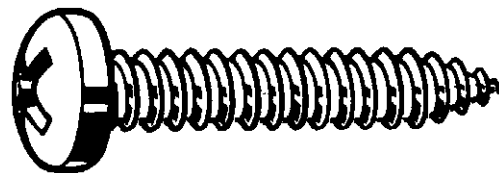

Informacje techniczne

d	dk	k	Nr wgłębienia krzyżowego	P
ST2.2	4.2	1.8	1	0.8
ST2.9	5.6	2.2	1	1.1
ST3.5	6.9	2.6	2	1.3
ST3.9	7.5	2.8	2	1.4
ST4.2	8.2	3.05	2	1.4
ST4.8	9.5	3.55	2	1.6
ST5.5	10.8	3.95	3	1.8
ST6.3	12.5	4.55	3	1.8

Grupy katalogowe

Gwint	Gniazdo	Materiał	Obróbka powierzchni	Kod	Strona
ST	Phillips	St	Ocynk.	26660	6-78
ST	Phillips	St	Ocynk.	26670	6-79
ST	Pozidriv	St	Ocynk.	26760	6-79
ST	Phillips	St	Nikl.	26200	6-79
ST	Phillips	St	Nikl.	26210	6-80
ST	Phillips	St	Ocynk. czrn. pas.	26400	6-80
ST	Pozidriv	St	Ocynk. czrn. pas.	26402	6-80
ST	Phillips	St.St. A2		51660	6-81
ST	Phillips	St.St. A2		51670	6-81
ST	Pozidriv	St.St. A2		51661	6-82
ST	Pozidriv	St.St. A4		55661	6-82
ST	Phillips	St.St. A4		55660	6-83
ST	Phillips	St	Nikl.	26300	6-83

26660 Wkręty samogwintujące z łbem walcowym wypukłym z gniazdem krzyżowym Phillips

J01B

Gwint Samogwintujący
Materiał Stal
Obróbka powierzchni Ocynkowane

DIN 7981 C-H
ISO 7049 C-H

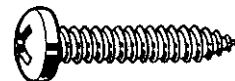

d x L	✉	Kod artykułu	d x L	✉	Kod artykułu	d x L	✉	Kod artykułu
ST2,2X6,5MM	200	26660.022.006	ST3,9X19MM	200	26660.039.019	ST4,8X45MM	100	26660.048.045
ST2,2X9,5MM	200	26660.022.009	ST3,9X22MM	200	26660.039.022	ST4,8X50MM	100	26660.048.050
ST2,2X16MM	200	26660.022.016	ST3,9X25MM	200	26660.039.025	ST4,8X70MM	100	26660.048.070
ST2,9X6,5MM	200	26660.029.006	ST3,9X32MM	200	26660.039.032	ST5,5X13MM	200	26660.055.013
ST2,9X9,5MM	200	26660.029.009	ST3,9X38MM	200	26660.039.038	ST5,5X16MM	200	26660.055.016
ST2,9X13MM	200	26660.029.013	ST4,2X9,5MM	200	26660.042.009	ST5,5X19MM	200	26660.055.019
ST2,9X16MM	200	26660.029.016	ST4,2X13MM	200	26660.042.013	ST5,5X22MM	100	26660.055.022
ST2,9X19MM	200	26660.029.019	ST4,2X16MM	200	26660.042.016	ST5,5X25MM	100	26660.055.025
ST2,9X22MM	200	26660.029.022	ST4,2X19MM	200	26660.042.019	ST5,5X32MM	100	26660.055.032
ST2,9X25MM	200	26660.029.025	ST4,2X22MM	200	26660.042.022	ST5,5X38MM	100	26660.055.038
ST3,5X6,5MM	200	26660.035.006	ST4,2X25MM	200	26660.042.025	ST5,5X45MM	100	26660.055.045
ST3,5X9,5MM	200	26660.035.009	ST4,2X32MM	200	26660.042.032	ST5,5X50MM	100	26660.055.050
ST3,5X13MM	200	26660.035.013	ST4,2X38MM	200	26660.042.038	ST6,3X13MM	100	26660.063.013
ST3,5X16MM	200	26660.035.016	ST4,2X45MM	200	26660.042.045	ST6,3X16MM	100	26660.063.016
ST3,5X19MM	200	26660.035.019	ST4,2X50MM	200	26660.042.050	ST6,3X19MM	100	26660.063.019
ST3,5X22MM	200	26660.035.022	ST4,2X60MM	200	26660.042.060	ST6,3X22MM	100	26660.063.022
ST3,5X25MM	200	26660.035.025	ST4,8X9,5MM	200	26660.048.009	ST6,3X25MM	100	26660.063.025
ST3,5X32MM	200	26660.035.032	ST4,8X13MM	200	26660.048.013	ST6,3X32MM	100	26660.063.032
ST3,5X38MM	200	26660.035.038	ST4,8X16MM	200	26660.048.016	ST6,3X38MM	100	26660.063.038
ST3,9X6,5MM	200	26660.039.006	ST4,8X19MM	200	26660.048.019	ST6,3X45MM	100	26660.063.045
ST3,9X9,5MM	200	26660.039.009	ST4,8X22MM	200	26660.048.022	ST6,3X50MM	100	26660.063.050
ST3,9X13MM	200	26660.039.013	ST4,8X25MM	200	26660.048.025	ST6,3X60MM	100	26660.063.060
ST3,9X16MM	200	26660.039.016	ST4,8X32MM	100	26660.048.032	ST6,3X70MM	100	26660.063.070
			ST4,8X38MM	100	26660.048.038			

26660 Wkręty samogwintujące z łbem walcowym wypukłym z gniazdem krzyżowym Phillips

• Ostrzeżenie: cynkowanie elektrolityczne tych produktów może wywołać kruchość wodorową.

26670 Wkręty samogwintujące z łbem walcowym wypukłym z gniazdem krzyżowym Phillips
J01B

Gwint Samogwintujący
Materiał Stal
Obróbka powierzchni Ocynkowane

DIN 7981 C-H
ISO 7049 C-H



d x L	☒	Kod artykułu	d x L	☒	Kod artykułu	d x L	☒	Kod artykułu
ST2,9X6,5MM	2000	26670.029.006	ST3,5X22MM	2000	26670.035.022	ST4,2X25MM	1000	26670.042.025
ST2,9X9,5MM	2000	26670.029.009	ST3,5X25MM	2000	26670.035.025	ST4,2X32MM	500	26670.042.032
ST2,9X13MM	2000	26670.029.013				ST4,2X50MM	500	26670.042.050
ST2,9X16MM	2000	26670.029.016	ST3,9X9,5MM	1000	26670.039.009			
ST2,9X19MM	2000	26670.029.019	ST3,9X16MM	1000	26670.039.016	ST4,8X13MM	1000	26670.048.013
						ST4,8X16MM	1000	26670.048.016
ST3,5X6,5MM	2000	26670.035.006	ST4,2X9,5MM	1000	26670.042.009	ST4,8X19MM	1000	26670.048.019
ST3,5X9,5MM	2000	26670.035.009	ST4,2X13MM	1000	26670.042.013	ST4,8X25MM	1000	26670.048.025
ST3,5X13MM	2000	26670.035.013	ST4,2X16MM	1000	26670.042.016	ST4,8X32MM	500	26670.048.032
ST3,5X16MM	2000	26670.035.016	ST4,2X19MM	1000	26670.042.019	ST4,8X38MM	500	26670.048.038
ST3,5X19MM	2000	26670.035.019						

• Ostrzeżenie: cynkowanie elektrolityczne tych produktów może wywołać kruchość wodorową.

26760 Wkręty samogwintujące z łbem walcowym wypukłym z gniazdem krzyżowym Pozidriv
J01A

Gwint Samogwintujący
Materiał Stal
Obróbka powierzchni Ocynkowane

DIN 7981 C-Z
ISO 7049 C-Z
NF E25-658 C



d x L	☒	Kod artykułu	d x L	☒	Kod artykułu	d x L	☒	Kod artykułu
ST2,2X6,5MM	200	26760.022.006	ST3,9X19MM	200	26760.039.019	ST4,8X50MM	100	26760.048.050
			ST3,9X25MM	200	26760.039.025			
ST2,9X6,5MM	200	26760.029.006				ST5,5X13MM	200	26760.055.013
ST2,9X9,5MM	200	26760.029.009	ST4,2X9,5MM	200	26760.042.009	ST5,5X16MM	200	26760.055.016
ST2,9X13MM	200	26760.029.013	ST4,2X13MM	200	26760.042.013	ST5,5X19MM	200	26760.055.019
ST2,9X16MM	200	26760.029.016	ST4,2X16MM	200	26760.042.016	ST5,5X25MM	100	26760.055.025
ST2,9X19MM	200	26760.029.019	ST4,2X19MM	200	26760.042.019	ST5,5X32MM	100	26760.055.032
ST2,9X25MM	200	26760.029.025	ST4,2X25MM	200	26760.042.025	ST5,5X38MM	100	26760.055.038
			ST4,2X32MM	200	26760.042.032	ST5,5X45MM	100	26760.055.045
ST3,5X6,5MM	200	26760.035.006	ST4,2X38MM	200	26760.042.038	ST5,5X50MM	100	26760.055.050
ST3,5X9,5MM	200	26760.035.009	ST4,2X45MM	200	26760.042.045			
ST3,5X13MM	200	26760.035.013	ST4,2X50MM	200	26760.042.050	ST6,3X13MM	100	26760.063.013
ST3,5X16MM	200	26760.035.016				ST6,3X16MM	100	26760.063.016
ST3,5X19MM	200	26760.035.019	ST4,8X9,5MM	200	26760.048.009	ST6,3X19MM	100	26760.063.019
ST3,5X25MM	200	26760.035.025	ST4,8X13MM	200	26760.048.013	ST6,3X25MM	100	26760.063.025
ST3,5X32MM	200	26760.035.032	ST4,8X16MM	200	26760.048.016	ST6,3X32MM	100	26760.063.032
ST3,5X38MM	200	26760.035.038	ST4,8X19MM	200	26760.048.019	ST6,3X38MM	100	26760.063.038
			ST4,8X25MM	200	26760.048.025	ST6,3X45MM	100	26760.063.045
ST3,9X9,5MM	200	26760.039.009	ST4,8X32MM	100	26760.048.032	ST6,3X50MM	100	26760.063.050
ST3,9X13MM	200	26760.039.013	ST4,8X38MM	100	26760.048.038			
ST3,9X16MM	200	26760.039.016	ST4,8X45MM	100	26760.048.045			

• Ostrzeżenie: cynkowanie elektrolityczne tych produktów może wywołać kruchość wodorową.

26200 Wkręty samogwintujące z łbem walcowym wypukłym z gniazdem krzyżowym Phillips
J03B

Gwint Samogwintujący
Materiał Stal
Obróbka powierzchni Niklowane

DIN 7981 C-H
ISO 7049 C-H

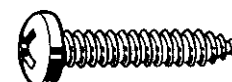

d x L	☒	Kod artykułu	d x L	☒	Kod artykułu	d x L	☒	Kod artykułu
ST2,9X6,5MM	200	26200.029.006	ST3,5X19MM	200	26200.035.019	ST3,9X25MM	200	26200.039.025
ST2,9X9,5MM	200	26200.029.009	ST3,5X25MM	200	26200.035.025			
ST2,9X13MM	200	26200.029.013	ST3,5X32MM	200	26200.035.032	ST4,2X9,5MM	200	26200.042.009
ST2,9X16MM	200	26200.029.016	ST3,5X38MM	200	26200.035.038	ST4,2X13MM	200	26200.042.013
ST2,9X19MM	200	26200.029.019				ST4,2X16MM	200	26200.042.016
			ST3,9X9,5MM	200	26200.039.009	ST4,2X19MM	200	26200.042.019
ST3,5X6,5MM	200	26200.035.006	ST3,9X13MM	200	26200.039.013	ST4,2X25MM	200	26200.042.025
ST3,5X9,5MM	200	26200.035.009	ST3,9X16MM	200	26200.039.016	ST4,2X32MM	200	26200.042.032
ST3,5X13MM	200	26200.035.013	ST3,9X19MM	200	26200.039.019	ST4,2X38MM	200	26200.042.038
ST3,5X16MM	200	26200.035.016						

26200 Wkręty samogwintujące z łbem walcowym wypukłym z gniazdem krzyżowym Phillips

d x L	☒	Kod artykułu	d x L	☒	Kod artykułu	d x L	☒	Kod artykułu
ST4,8X13MM	200	26200.048.013	ST5,5X13MM	200	26200.055.013	ST6,3X13MM	100	26200.063.013
ST4,8X16MM	200	26200.048.016	ST5,5X16MM	200	26200.055.016	ST6,3X16MM	100	26200.063.016
ST4,8X19MM	200	26200.048.019	ST5,5X19MM	200	26200.055.019	ST6,3X19MM	100	26200.063.019
ST4,8X25MM	200	26200.048.025	ST5,5X25MM	100	26200.055.025	ST6,3X25MM	100	26200.063.025
ST4,8X32MM	100	26200.048.032	ST5,5X32MM	100	26200.055.032	ST6,3X32MM	100	26200.063.032
ST4,8X38MM	100	26200.048.038	ST5,5X38MM	100	26200.055.038	ST6,3X38MM	100	26200.063.038

• Ostrzeżenie: cynkowanie elektrolityczne tych produktów może wywołać kruchość wodorową.

26210 Wkręty samogwintujące z łbem walcowym wypukłym z gniazdem krzyżowym Phillips J03B

Gwint	Samogwintujący	DIN	7981 C-H
Materiał	Stal	ISO	7049 C-H
Obróbka powierzchni	Niklowane		

d x L	☒	Kod artykułu	d x L	☒	Kod artykułu	d x L	☒	Kod artykułu
ST3,5X6,5MM	2000	26210.035.006	ST4,2X9,5MM	1000	26210.042.009	ST4,2X45MM	500	26210.042.045
ST3,5X9,5MM	2000	26210.035.009	ST4,2X13MM	1000	26210.042.013	ST4,8X13MM	1000	26210.048.013
ST3,5X13MM	2000	26210.035.013	ST4,2X16MM	1000	26210.042.016	ST4,8X16MM	1000	26210.048.016
ST3,5X16MM	2000	26210.035.016	ST4,2X19MM	1000	26210.042.019			
ST3,5X19MM	2000	26210.035.019						

• Ostrzeżenie: cynkowanie elektrolityczne tych produktów może wywołać kruchość wodorową.

6

26400 Wkręty samogwintujące z łbem walcowym wypukłym z gniazdem krzyżowym Phillips J03B

Gwint	Samogwintujący	DIN	7981 C-H
Materiał	Stal	ISO	7049 C-H
Obróbka powierzchni	Ocynkowane, po czarnej pasywacji		

d x L	☒	Kod artykułu	d x L	☒	Kod artykułu	d x L	☒	Kod artykułu
ST2,9X6,5MM	200	26400.029.006	ST3,9X9,5MM	200	26400.039.009	ST4,8X16MM	200	26400.048.016
ST2,9X9,5MM	200	26400.029.009	ST3,9X13MM	200	26400.039.013	ST4,8X19MM	200	26400.048.019
ST2,9X13MM	200	26400.029.013	ST3,9X16MM	200	26400.039.016	ST4,8X25MM	200	26400.048.025
ST2,9X16MM	200	26400.029.016	ST3,9X19MM	200	26400.039.019	ST4,8X32MM	100	26400.048.032
ST2,9X19MM	200	26400.029.019	ST3,9X25MM	200	26400.039.025	ST4,8X38MM	100	26400.048.038
ST2,9X25MM	200	26400.029.025				ST4,8X50MM	100	26400.048.050
			ST4,2X9,5MM	200	26400.042.009			
ST3,5X6,5MM	200	26400.035.006	ST4,2X13MM	200	26400.042.013	ST5,5X13MM	200	26400.055.013
ST3,5X9,5MM	200	26400.035.009	ST4,2X16MM	200	26400.042.016	ST5,5X16MM	200	26400.055.016
ST3,5X13MM	200	26400.035.013	ST4,2X19MM	200	26400.042.019	ST5,5X19MM	200	26400.055.019
ST3,5X16MM	200	26400.035.016	ST4,2X25MM	200	26400.042.025	ST5,5X25MM	100	26400.055.025
ST3,5X19MM	200	26400.035.019	ST4,2X32MM	200	26400.042.032	ST5,5X32MM	100	26400.055.032
ST3,5X25MM	200	26400.035.025	ST4,2X38MM	200	26400.042.038	ST5,5X38MM	100	26400.055.038
ST3,5X32MM	200	26400.035.032	ST4,2X50MM	200	26400.042.050	ST5,5X45MM	100	26400.055.045
ST3,5X38MM	200	26400.035.038				ST5,5X50MM	100	26400.055.050
			ST4,8X13MM	200	26400.048.013			

• Ostrzeżenie: cynkowanie elektrolityczne tych produktów może wywołać kruchość wodorową.

26402 Wkręty samogwintujące z łbem walcowym wypukłym z gniazdem krzyżowym Pozidriv J03B

Gwint	Samogwintujący	DIN	7981 C-Z
Materiał	Stal	ISO	7049 C-Z
Obróbka powierzchni	Ocynkowane, po czarnej pasywacji	NF	E25-658 C

d x L	☒	Kod artykułu	d x L	☒	Kod artykułu	d x L	☒	Kod artykułu
ST2,9X6,5MM	200	26402.029.006	ST3,5X25MM	200	26402.035.025	ST4,2X32MM	200	26402.042.032
ST2,9X9,5MM	200	26402.029.009				ST4,2X38MM	200	26402.042.038
ST2,9X13MM	200	26402.029.013	ST3,9X13MM	200	26402.039.013	ST4,2X50MM	200	26402.042.050
ST2,9X16MM	200	26402.029.016	ST3,9X16MM	200	26402.039.016			
ST2,9X19MM	200	26402.029.019	ST3,9X19MM	200	26402.039.019	ST4,8X13MM	200	26402.048.013
ST2,9X25MM	200	26402.029.025	ST3,9X25MM	200	26402.039.025	ST4,8X16MM	200	26402.048.016
						ST4,8X19MM	200	26402.048.019
ST3,5X6,5MM	200	26402.035.006	ST4,2X9,5MM	200	26402.042.009	ST4,8X25MM	200	26402.048.025
ST3,5X9,5MM	200	26402.035.009	ST4,2X13MM	200	26402.042.013	ST4,8X32MM	100	26402.048.032
ST3,5X13MM	200	26402.035.013	ST4,2X16MM	200	26402.042.016	ST4,8X38MM	100	26402.048.038
ST3,5X16MM	200	26402.035.016	ST4,2X19MM	200	26402.042.019	ST4,8X50MM	100	26402.048.050
ST3,5X19MM	200	26402.035.019	ST4,2X25MM	200	26402.042.025			

26402 Wkręty samogwintujące z łbem walcowym wypukłym z gniazdem krzyżowym Pozidriv								
d x L	☒	Kod artykułu	d x L	☒	Kod artykułu	d x L	☒	Kod artykułu
ST5,5X13MM	200	26402.055.013	ST5,5X19MM	200	26402.055.019			
ST5,5X16MM	200	26402.055.016	ST5,5X25MM	100	26402.055.025	ST6,3X19MM	100	26402.063.019

• Ostrzeżenie: cynkowanie elektrolityczne tych produktów może wywołać kruchość wodorową.

51660 Wkręty samogwintujące z łbem walcowym wypukłym z gniazdem krzyżowym Phillips					R01A
Gwint	Samogwintujący	DIN	7981 C-H		
Material	Stal nierdzewna A2	ISO	7049 C-H		

d x L	☒	Kod artykułu	d x L	☒	Kod artykułu	d x L	☒	Kod artykułu
ST2,2X4,5MM	1000	51660.022.004	ST3,9X25MM	200	51660.039.025	ST4,8X90MM	200	51660.048.090
ST2,2X6,5MM*	1000	51660.022.006	ST3,9X28MM*	1000	51660.039.028	ST4,8X100MM	100	51660.048.100
ST2,2X9,5MM	1000	51660.022.009	ST3,9X32MM	200	51660.039.032	ST4,8X120MM*	200	51660.048.120
ST2,2X13MM*	1000	51660.022.013	ST3,9X38MM	200	51660.039.038			
ST2,2X16MM*	1000	51660.022.016	ST3,9X45MM*	500	51660.039.045	ST5,5X13MM	200	51660.055.013
ST2,2X19MM*	1000	51660.022.019	ST3,9X50MM*	500	51660.039.050	ST5,5X16MM	200	51660.055.016
ST2,2X22MM*	1000	51660.022.022	ST3,9X60MM*	500	51660.039.060	ST5,5X19MM	200	51660.055.019
ST2,2X25MM*	1000	51660.022.025	ST3,9X70MM*	500	51660.039.070	ST5,5X22MM	200	51660.055.022
						ST5,5X25MM	200	51660.055.025
ST2,9X6,5MM	200	51660.029.006	ST4,2X6,5MM	200	51660.042.006	ST5,5X32MM	100	51660.055.032
ST2,9X9,5MM	200	51660.029.009	ST4,2X9,5MM	200	51660.042.009	ST5,5X38MM	100	51660.055.038
ST2,9X13MM	200	51660.029.013	ST4,2X13MM	200	51660.042.013	ST5,5X42MM*	500	51660.055.042
ST2,9X16MM	200	51660.029.016	ST4,2X16MM	200	51660.042.016	ST5,5X45MM	100	51660.055.045
ST2,9X19MM	200	51660.029.019	ST4,2X19MM	200	51660.042.019	ST5,5X50MM	100	51660.055.050
ST2,9X22MM	200	51660.029.022	ST4,2X22MM	200	51660.042.022	ST5,5X55MM*	200	51660.055.055
ST2,9X25MM	200	51660.029.025	ST4,2X25MM	200	51660.042.025	ST5,5X60MM	200	51660.055.060
ST2,9X32MM*	1000	51660.029.032	ST4,2X32MM	200	51660.042.032	ST5,5X70MM*	200	51660.055.070
ST2,9X38MM	500	51660.029.038	ST4,2X38MM	200	51660.042.038	ST5,5X80MM*	200	51660.055.080
			ST4,2X45MM	200	51660.042.045	ST5,5X90MM*	200	51660.055.090
ST3,5X6,5MM	200	51660.035.006	ST4,2X50MM	200	51660.042.050	ST5,5X100MM*	200	51660.055.100
ST3,5X9,5MM	200	51660.035.009	ST4,2X60MM	200	51660.042.060	ST5,5X120MM*	200	51660.055.120
ST3,5X13MM	200	51660.035.013	ST4,2X70MM*	200	51660.042.070			
ST3,5X16MM	200	51660.035.016	ST4,2X80MM*	200	51660.042.080	ST6,3X13MM	100	51660.063.013
ST3,5X19MM	200	51660.035.019				ST6,3X16MM	100	51660.063.016
ST3,5X22MM	200	51660.035.022	ST4,8X9,5MM	200	51660.048.009	ST6,3X19MM	100	51660.063.019
ST3,5X25MM	200	51660.035.025	ST4,8X13MM	200	51660.048.013	ST6,3X22MM	100	51660.063.022
ST3,5X32MM	200	51660.035.032	ST4,8X16MM	200	51660.048.016	ST6,3X25MM	100	51660.063.025
ST3,5X38MM	200	51660.035.038	ST4,8X19MM	200	51660.048.019	ST6,3X32MM	100	51660.063.032
ST3,5X45MM*	500	51660.035.045	ST4,8X22MM	200	51660.048.022	ST6,3X38MM	100	51660.063.038
ST3,5X50MM*	500	51660.035.050	ST4,8X25MM	200	51660.048.025	ST6,3X45MM	100	51660.063.045
ST3,5X60MM*	500	51660.035.060	ST4,8X32MM	200	51660.048.032	ST6,3X50MM	100	51660.063.050
ST3,5X70MM*	500	51660.035.070	ST4,8X35MM*	500	51660.048.035	ST6,3X60MM*	200	51660.063.060
			ST4,8X38MM	200	51660.048.038	ST6,3X70MM*	200	51660.063.070
ST3,9X6,5MM	1000	51660.039.006	ST4,8X45MM	200	51660.048.045	ST6,3X80MM*	200	51660.063.080
ST3,9X9,5MM	200	51660.039.009	ST4,8X50MM	200	51660.048.050	ST6,3X90MM*	200	51660.063.090
ST3,9X13MM	200	51660.039.013	ST4,8X55MM*	200	51660.048.055	ST6,3X100MM*	200	51660.063.100
ST3,9X16MM	200	51660.039.016	ST4,8X60MM	200	51660.048.060	ST6,3X120MM*	200	51660.063.120
ST3,9X19MM	200	51660.039.019	ST4,8X70MM	200	51660.048.070			
ST3,9X22MM	200	51660.039.022	ST4,8X80MM	200	51660.048.080			

51670 Wkręty samogwintujące z łbem walcowym wypukłym z gniazdem krzyżowym Phillips					R01A
Gwint	Samogwintujący	DIN	7981 C-H		
Material	Stal nierdzewna A2	ISO	7049 C-H		

d x L	☒	Kod artykułu	d x L	☒	Kod artykułu	d x L	☒	Kod artykułu
ST3,5X9,5MM	1000	51670.035.009	ST4,2X32MM	1000	51670.042.032	ST4,8X16MM	1000	51670.048.016
			ST4,2X38MM	500	51670.042.038	ST4,8X19MM	1000	51670.048.019
ST4,2X13MM	1000	51670.042.013	ST4,2X50MM	1000	51670.042.050	ST4,8X25MM	1000	51670.048.025
ST4,2X16MM	1000	51670.042.016				ST4,8X38MM	500	51670.048.038
ST4,2X19MM	1000	51670.042.019	ST4,8X9,5MM	1000	51670.048.009	ST4,8X50MM	500	51670.048.050
ST4,2X25MM	1000	51670.042.025	ST4,8X13MM	1000	51670.048.013			

51661 Wkręty samogwintujące z łbem walcowym wypukłym z gniazdem krzyżowym Pozidriv				R01A
Gwint	Samogwintujący	DIN	7981 C-Z	
Materiał	Stal nierdzewna A2	ISO	7049 C-Z	
		NF	E25-658 C	

d x L	☒	Kod artykułu	d x L	☒	Kod artykułu	d x L	☒	Kod artykułu
ST2,2X6,5MM*	1000	51661.022.006	ST3,9X32MM	200	51661.039.032	ST4,8X80MM*	200	51661.048.080
ST2,2X9,5MM*	1000	51661.022.009	ST3,9X38MM	200	51661.039.038	ST4,8X90MM*	200	51661.048.090
ST2,2X13MM*	1000	51661.022.013	ST3,9X45MM*	500	51661.039.045	ST4,8X100MM*	200	51661.048.100
ST2,2X16MM*	1000	51661.022.016	ST3,9X50MM*	500	51661.039.050			
			ST4,2X9,5MM	200	51661.042.009	ST5,5X13MM	200	51661.055.013
ST2,9X6,5MM	200	51661.029.006	ST4,2X13MM	200	51661.042.013	ST5,5X16MM	200	51661.055.016
ST2,9X9,5MM	200	51661.029.009	ST4,2X16MM	200	51661.042.016	ST5,5X19MM	200	51661.055.019
ST2,9X13MM	200	51661.029.013	ST4,2X19MM	200	51661.042.019	ST5,5X22MM*	1000	51661.055.022
ST2,9X16MM	200	51661.029.016	ST4,2X22MM*	1000	51661.042.022	ST5,5X25MM	200	51661.055.025
ST2,9X19MM	200	51661.029.019	ST4,2X25MM	200	51661.042.025	ST5,5X32MM	100	51661.055.032
ST2,9X22MM*	1000	51661.029.022	ST4,2X32MM	200	51661.042.032	ST5,5X38MM	100	51661.055.038
ST2,9X25MM	200	51661.029.025	ST4,2X38MM	200	51661.042.038	ST5,5X45MM	100	51661.055.045
ST2,9X32MM*	1000	51661.029.032	ST4,2X45MM	200	51661.042.045	ST5,5X50MM	100	51661.055.050
			ST4,2X50MM	200	51661.042.050	ST5,5X60MM*	200	51661.055.060
ST3,5X6,5MM	200	51661.035.006	ST4,2X60MM*	200	51661.042.060	ST5,5X70MM*	200	51661.055.070
ST3,5X9,5MM	200	51661.035.009	ST4,2X70MM*	200	51661.042.070	ST5,5X80MM*	200	51661.055.080
ST3,5X13MM	200	51661.035.013				ST5,5X100MM*	200	51661.055.100
ST3,5X16MM	200	51661.035.016	ST4,8X9,5MM	200	51661.048.009	ST6,3X13MM*	500	51661.063.013
ST3,5X19MM	200	51661.035.019	ST4,8X13MM	200	51661.048.013	ST6,3X16MM	100	51661.063.016
ST3,5X22MM*	1000	51661.035.022	ST4,8X16MM	200	51661.048.016	ST6,3X19MM	100	51661.063.019
ST3,5X25MM	200	51661.035.025	ST4,8X19MM	200	51661.048.019	ST6,3X22MM*	500	51661.063.022
ST3,5X32MM	200	51661.035.032	ST4,8X22MM*	1000	51661.048.022	ST6,3X25MM	100	51661.063.025
ST3,5X38MM	200	51661.035.038	ST4,8X25MM	200	51661.048.025	ST6,3X32MM	100	51661.063.032
			ST4,8X32MM	200	51661.048.032	ST6,3X38MM	100	51661.063.038
ST3,9X6,5MM*	1000	51661.039.006	ST4,8X38MM	200	51661.048.038	ST6,3X45MM*	200	51661.063.045
ST3,9X9,5MM	200	51661.039.009	ST4,8X45MM	200	51661.048.045	ST6,3X50MM	100	51661.063.050
ST3,9X13MM	200	51661.039.013	ST4,8X50MM	200	51661.048.050	ST6,3X60MM*	200	51661.063.060
ST3,9X16MM	200	51661.039.016	ST4,8X60MM	200	51661.048.060	ST6,3X70MM*	200	51661.063.070
ST3,9X19MM	200	51661.039.019	ST4,8X70MM*	200	51661.048.070	ST6,3X80MM*	200	51661.063.080
ST3,9X22MM*	1000	51661.039.022						
ST3,9X25MM	200	51661.039.025						

6

55661 Wkręty samogwintujące z łbem walcowym wypukłym z gniazdem krzyżowym Pozidriv				R41A
Gwint	Samogwintujący	DIN	7981 C-Z	
Materiał	Stal nierdzewna A4	ISO	7049 C-Z	
		NF	E25-658 C	

d x L	☒	Kod artykułu	d x L	☒	Kod artykułu	d x L	☒	Kod artykułu
ST2,2X6,5MM*	1000	55661.022.006	ST3,9X32MM*	1000	55661.039.032	ST4,8X100MM*	200	55661.048.100
ST2,2X9,5MM*	1000	55661.022.009	ST3,9X38MM*	500	55661.039.038	ST5,5X13MM*	1000	55661.055.013
ST2,2X13MM*	1000	55661.022.013	ST3,9X45MM*	500	55661.039.045	ST5,5X16MM*	1000	55661.055.016
ST2,2X16MM*	1000	55661.022.016	ST3,9X50MM*	500	55661.039.050	ST5,5X19MM*	1000	55661.055.019
ST2,2X19MM*	1000	55661.022.019				ST5,5X22MM*	1000	55661.055.022
			ST4,2X9,5MM*	1000	55661.042.009	ST5,5X25MM*	500	55661.055.025
ST2,9X6,5MM*	1000	55661.029.006	ST4,2X13MM*	1000	55661.042.013	ST5,5X32MM*	500	55661.055.032
ST2,9X9,5MM*	1000	55661.029.009	ST4,2X16MM*	1000	55661.042.016	ST5,5X38MM*	500	55661.055.038
ST2,9X13MM*	1000	55661.029.013	ST4,2X19MM*	1000	55661.042.019	ST5,5X45MM*	200	55661.055.045
ST2,9X16MM*	1000	55661.029.016	ST4,2X22MM*	1000	55661.042.022	ST5,5X50MM*	200	55661.055.050
ST2,9X19MM*	1000	55661.029.019	ST4,2X25MM*	1000	55661.042.025	ST5,5X60MM*	200	55661.055.060
ST2,9X22MM*	1000	55661.029.022	ST4,2X32MM*	500	55661.042.032	ST5,5X70MM*	200	55661.055.070
ST2,9X25MM*	1000	55661.029.025	ST4,2X38MM*	500	55661.042.038	ST5,5X80MM*	200	55661.055.080
			ST4,2X45MM*	500	55661.042.045	ST5,5X100MM*	200	55661.055.100
ST3,5X6,5MM*	1000	55661.035.006	ST4,2X50MM*	200	55661.042.050	ST6,3X13MM*	500	55661.063.013
ST3,5X9,5MM*	1000	55661.035.009	ST4,2X60MM*	200	55661.042.060	ST6,3X16MM*	500	55661.063.016
ST3,5X13MM*	1000	55661.035.013	ST4,2X70MM*	200	55661.042.070	ST6,3X19MM*	500	55661.063.019
ST3,5X16MM*	1000	55661.035.016				ST6,3X22MM*	500	55661.063.022
ST3,5X19MM*	1000	55661.035.019	ST4,8X9MM*	1000	55661.048.009	ST6,3X25MM*	200	55661.063.025
ST3,5X22MM*	1000	55661.035.022	ST4,8X13MM*	1000	55661.048.013	ST6,3X32MM*	200	55661.063.032
ST3,5X25MM*	1000	55661.035.025	ST4,8X16MM*	1000	55661.048.016	ST6,3X38MM*	200	55661.063.038
ST3,5X32MM*	1000	55661.035.032	ST4,8X19MM*	1000	55661.048.019	ST6,3X45MM*	200	55661.063.045
ST3,5X38MM*	1000	55661.035.038	ST4,8X22MM*	1000	55661.048.022	ST6,3X50MM*	200	55661.063.050
			ST4,8X25MM*	500	55661.048.025	ST6,3X60MM*	200	55661.063.060
ST3,9X9,5MM*	1000	55661.039.009	ST4,8X32MM*	500	55661.048.032	ST6,3X70MM*	200	55661.063.070
ST3,9X13MM*	1000	55661.039.013	ST4,8X38MM*	500	55661.048.038	ST6,3X80MM*	200	55661.063.080
ST3,9X16MM*	1000	55661.039.016	ST4,8X45MM*	200	55661.048.045	ST6,3X100MM*	200	55661.063.100
ST3,9X19MM*	1000	55661.039.019	ST4,8X50MM*	200	55661.048.050			
ST3,9X22MM*	1000	55661.039.022	ST4,8X70MM*	200	55661.048.070			
ST3,9X25MM*	1000	55661.039.025	ST4,8X80MM*	200	55661.048.080			

55660 Wkręty samogwintujące z łbem walcowym wypukłym z gniazdem krzyżowym Phillips				R41A
Gwint	Samogwintujący	DIN	7981 C-H	
Materiał	Stal nierdzewna A4	ISO	7049 C-H	

d x L	☒	Kod artykułu	d x L	☒	Kod artykułu	d x L	☒	Kod artykułu
ST2,2X6,5MM*	1000	55660.022.006	ST3,9X32MM*	1000	55660.039.032	ST5,5X13MM	200	55660.055.013
ST2,2X9,5MM*	1000	55660.022.009	ST3,9X38MM*	500	55660.039.038	ST5,5X16MM	200	55660.055.016
ST2,2X13MM*	1000	55660.022.013	ST3,9X45MM*	500	55660.039.045	ST5,5X19MM	200	55660.055.019
ST2,2X22MM*	1000	55660.022.022	ST3,9X50MM*	500	55660.039.050	ST5,5X22MM	200	55660.055.022
ST2,9X6,5MM	200	55660.029.006	ST4,2X9,5MM	200	55660.042.009	ST5,5X25MM	200	55660.055.025
ST2,9X9,5MM	200	55660.029.009	ST4,2X13MM	200	55660.042.013	ST5,5X32MM	100	55660.055.032
ST2,9X13MM	200	55660.029.013	ST4,2X16MM	200	55660.042.016	ST5,5X38MM	100	55660.055.038
ST2,9X16MM	200	55660.029.016	ST4,2X19MM	200	55660.042.019	ST5,5X45MM	100	55660.055.045
ST2,9X19MM	200	55660.029.019	ST4,2X22MM	200	55660.042.022	ST5,5X50MM	100	55660.055.050
ST2,9X22MM*	1000	55660.029.022	ST4,2X25MM	200	55660.042.025	ST5,5X60MM*	200	55660.055.060
ST2,9X25MM	1000	55660.029.025	ST4,2X32MM	200	55660.042.032	ST5,5X70MM*	200	55660.055.070
ST2,9X32MM*	1000	55660.029.032	ST4,2X38MM	200	55660.042.038	ST5,5X80MM*	200	55660.055.080
ST3,5X6,5MM*	1000	55660.035.006	ST4,2X45MM*	500	55660.042.045	ST5,5X90MM*	200	55660.055.090
ST3,5X9,5MM	200	55660.035.009	ST4,2X50MM	200	55660.042.050	ST5,5X100MM*	200	55660.055.100
ST3,5X13MM	200	55660.035.013	ST4,2X60MM*	200	55660.042.060	ST6,3X13MM	100	55660.063.013
ST3,5X16MM	200	55660.035.016	ST4,2X70MM*	200	55660.042.070	ST6,3X16MM	100	55660.063.016
ST3,5X19MM	200	55660.035.019	ST4,8X9,5MM*	1000	55660.048.009	ST6,3X19MM	100	55660.063.019
ST3,5X22MM	200	55660.035.022	ST4,8X13MM	200	55660.048.013	ST6,3X22MM	100	55660.063.022
ST3,5X25MM	200	55660.035.025	ST4,8X16MM	200	55660.048.016	ST6,3X25MM	100	55660.063.025
ST3,5X32MM	200	55660.035.032	ST4,8X19MM	200	55660.048.019	ST6,3X32MM	100	55660.063.032
ST3,5X38MM*	1000	55660.035.038	ST4,8X22MM	200	55660.048.022	ST6,3X38MM	100	55660.063.038
ST3,9X6,5MM*	1000	55660.039.006	ST4,8X25MM	200	55660.048.025	ST6,3X45MM	100	55660.063.045
ST3,9X9,5MM	200	55660.039.009	ST4,8X32MM	200	55660.048.032	ST6,3X50MM	100	55660.063.050
ST3,9X13MM	200	55660.039.013	ST4,8X38MM	200	55660.048.038	ST6,3X60MM*	200	55660.063.060
ST3,9X16MM	200	55660.039.016	ST4,8X45MM*	200	55660.048.045	ST6,3X70MM*	200	55660.063.070
ST3,9X19MM	200	55660.039.019	ST4,8X50MM	200	55660.048.050	ST6,3X80MM*	200	55660.063.080
ST3,9X22MM	200	55660.039.022	ST4,8X60MM*	200	55660.048.060	ST6,3X90MM*	200	55660.063.090
ST3,9X25MM	200	55660.039.025	ST4,8X70MM*	200	55660.048.070	ST6,3X100MM*	200	55660.063.100
			ST4,8X80MM*	200	55660.048.080			

6

26300 Wkręty samogwintujące z łbem walcowym wypukłym z gniazdem krzyżowym Phillips, z zakończeniem tępym, bez zaostrenia				J03B
Gwint	Samogwintujący	DIN	7981 F-H	
Materiał	Stal	ISO	7049 F-H	
Obróbka powierzchni	Niklowane			

d x L	☒	Kod artykułu	d x L	☒	Kod artykułu	d x L	☒	Kod artykułu
ST2,2X4,5MM	2000	26300.022.004	ST2,9X19MM	2000	26300.029.019	ST4,2X9,5MM	1000	26300.042.009
ST2,2X6,5MM	2000	26300.022.006	ST3,5X6,5MM	2000	26300.035.006	ST4,2X13MM	1000	26300.042.013
ST2,9X4,5MM	2000	26300.029.004	ST3,5X8MM	2000	26300.035.008	ST4,2X16MM	1000	26300.042.016
ST2,9X6,5MM	2000	26300.029.006	ST3,5X9,5MM	2000	26300.035.009	ST4,2X19MM	500	26300.042.019
ST2,9X8MM	2000	26300.029.008	ST3,5X13MM	2000	26300.035.013	ST4,2X32MM	500	26300.042.032
ST2,9X9,5MM	2000	26300.029.009	ST3,5X16MM	1000	26300.035.016	ST4,8X13MM	1000	26300.048.013
ST2,9X13MM	2000	26300.029.013	ST3,5X19MM	1000	26300.035.019	ST4,8X19MM	500	26300.048.019
ST2,9X16MM	2000	26300.029.016						

- Ostrzeżenie: cynkowanie elektrolityczne tych produktów może wywołać kruchość wodorową.

Wkręty samogwintujące z łbem walcowym wypukłym z gniazdem sześciokarbowym

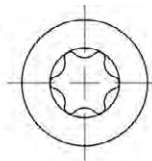
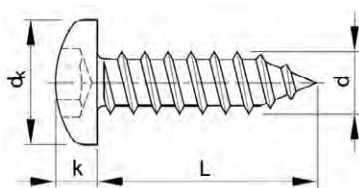

ISO 14585 C
DIN ≈7981 C
ASME ≈B18.6.4
NF ≈E25-654 C

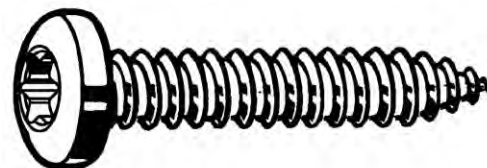

Informacje techniczne

d	dk	k	Nasadka	P
ST2.2	4.2	1.8	T6	0.8
ST2.9	5.6	2.2	T8/T10	1.1
ST3.5	6.9	2.6	T10	1.3
ST3.9 (#ISO)	7.5	2.8	T15	1.4
ST4.2	8.2	3.05	T20	1.4
ST4.8	9.5	3.55	T25	1.6
ST5.5	10.8	3.95	T25	1.8
ST6.3	12.5	4.55	T30	1.8

Grupy katalogowe

Gwint	Gniazdo	Materiał	Obróbka powierzchni	Kod	Strona
ST	Sześciokarbowy	St	Ocynk.	26501	6-84
ST	Sześciokarbowy	St.St. A2		51664	6-84
ST	Sześciokarbowy	St.St. A4		55664	6-85

6

26501 Wkręty samogwintujące z łbem walcowym wypukłym z gniazdem sześciokarbowym J03A

Gwint Samogwintujący
Materiał Stal
Obróbka powierzchni Ocynkowane

d x L	⊠	Kod artykułu	d x L	⊠	Kod artykułu	d x L	⊠	Kod artykułu
ST2,9X9,5MM	200	26501.029.009	ST3,9X13MM	200	26501.039.013	ST4,8X19MM	200	26501.048.019
ST2,9X13MM	200	26501.029.013						
			ST4,2X13MM	200	26501.042.013	ST5,5X19MM	200	26501.055.019
ST3,5X9,5MM	200	26501.035.009	ST4,2X16MM	200	26501.042.016	ST5,5X25MM	100	26501.055.025
ST3,5X13MM	200	26501.035.013	ST4,2X19MM	200	26501.042.019			
ST3,5X16MM	200	26501.035.016	ST4,2X25MM	200	26501.042.025	ST6,3X19MM	100	26501.063.019
ST3,5X19MM	200	26501.035.019				ST6,3X25MM	100	26501.063.025
			ST4,8X13MM	200	26501.048.013	ST6,3X32MM	100	26501.063.032
ST3,9X9,5MM	200	26501.039.009	ST4,8X16MM	200	26501.048.016	ST6,3X45MM	100	26501.063.045

• Ostrzeżenie: cynkowanie elektrolityczne tych produktów może wywołać kruchość wodorową.

51664 Wkręty samogwintujące z łbem walcowym wypukłym z gniazdem sześciokarbowym R03A

Gwint Samogwintujący
Materiał Stal nierdzewna A2

d x L	⊠	Kod artykułu	d x L	⊠	Kod artykułu	d x L	⊠	Kod artykułu
ST2,2X6,5MM*	1000	51664.022.006	ST3,5X6,5MM*	1000	51664.035.006	ST3,9X16MM*	1000	51664.039.016
ST2,2X9,5MM*	1000	51664.022.009	ST3,5X9,5MM*	1000	51664.035.009	ST3,9X19MM*	1000	51664.039.019
ST2,2X13MM*	1000	51664.022.013	ST3,5X13MM*	1000	51664.035.013	ST3,9X22MM*	1000	51664.039.022
ST2,2X16MM*	1000	51664.022.016	ST3,5X16MM	1000	51664.035.016	ST3,9X25MM*	1000	51664.039.025
ST2,2X19MM*	1000	51664.022.019	ST3,5X19MM*	1000	51664.035.019	ST3,9X32MM*	1000	51664.039.032
ST2,2X22MM*	1000	51664.022.022	ST3,5X22MM*	1000	51664.035.022	ST3,9X38MM*	500	51664.039.038
ST2,2X25MM*	1000	51664.022.025	ST3,5X25MM*	1000	51664.035.025	ST3,9X45MM*	500	51664.039.045
			ST3,5X32MM*	1000	51664.035.032	ST3,9X50MM*	500	51664.039.050
ST2,9X6,5MM*	1000	51664.029.006	ST3,5X38MM*	1000	51664.035.038	ST3,9X60MM*	500	51664.039.060
ST2,9X9,5MM*	1000	51664.029.009	ST3,5X45MM*	500	51664.035.045			
ST2,9X13MM*	1000	51664.029.013	ST3,5X50MM*	500	51664.035.050	ST4,2X9,5MM*	1000	51664.042.009
ST2,9X16MM*	1000	51664.029.016				ST4,2X13MM	1000	51664.042.013
ST2,9X19MM*	1000	51664.029.019	ST3,9X6,5MM*	1000	51664.039.006	ST4,2X16MM*	1000	51664.042.016
ST2,9X22MM*	1000	51664.029.022	ST3,9X9,5MM*	1000	51664.039.009	ST4,2X19MM	1000	51664.042.019
ST2,9X25MM*	1000	51664.029.025	ST3,9X13MM*	1000	51664.039.013	ST4,2X22MM*	1000	51664.042.022
ST2,9X32MM*	1000	51664.029.032				ST4,2X25MM*	1000	51664.042.025

51664 Wkręty samogwintujące z Ibem walcowym wypukłym z gniazdem sześciokątnym								
d x L	☒	Kod artykułu	d x L	☒	Kod artykułu	d x L	☒	Kod artykułu
ST4,2X32MM	500	51664.042.032	ST4,8X50MM*	200	51664.048.050	ST5,5X80MM*	200	51664.055.080
ST4,2X38MM	500	51664.042.038	ST4,8X60MM*	200	51664.048.060	ST6,3X13MM*	500	51664.063.013
ST4,2X45MM*	500	51664.042.045	ST4,8X70MM*	200	51664.048.070	ST6,3X16MM*	500	51664.063.016
ST4,2X50MM*	200	51664.042.050	ST5,5X13MM*	1000	51664.055.013	ST6,3X19MM*	500	51664.063.019
ST4,2X60MM*	200	51664.042.060	ST5,5X16MM*	1000	51664.055.016	ST6,3X22MM*	500	51664.063.022
ST4,8X9,5MM*	1000	51664.048.009	ST5,5X19MM*	1000	51664.055.019	ST6,3X25MM*	200	51664.063.025
ST4,8X13MM*	1000	51664.048.013	ST5,5X22MM*	1000	51664.055.022	ST6,3X32MM*	200	51664.063.032
ST4,8X16MM*	1000	51664.048.016	ST5,5X25MM*	500	51664.055.025	ST6,3X38MM*	200	51664.063.038
ST4,8X19MM*	1000	51664.048.019	ST5,5X32MM*	500	51664.055.032	ST6,3X45MM*	200	51664.063.045
ST4,8X22MM*	1000	51664.048.022	ST5,5X38MM*	500	51664.055.038	ST6,3X50MM*	200	51664.063.050
ST4,8X25MM*	500	51664.048.025	ST5,5X45MM*	200	51664.055.045	ST6,3X60MM*	200	51664.063.060
ST4,8X32MM*	500	51664.048.032	ST5,5X50MM	200	51664.055.050	ST6,3X70MM*	200	51664.063.070
ST4,8X38MM	500	51664.048.038	ST5,5X60MM	200	51664.055.060	ST6,3X80MM*	200	51664.063.080
ST4,8X45MM*	200	51664.048.045	ST5,5X70MM*	200	51664.055.070			

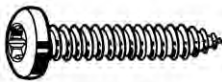
55664 Wkręty samogwintujące z Ibem walcowym wypukłym z gniazdem sześciokątnym		R43A
Gwint	Samogwintujący	
Material	Stal nierdzewna A4	
		

d x L	☒	Kod artykułu	d x L	☒	Kod artykułu	d x L	☒	Kod artykułu
ST2,2X6,5MM*	1000	55664.022.006	ST3,9X16MM*	1000	55664.039.016	ST4,8X45MM*	200	55664.048.045
ST2,2X9,5MM*	1000	55664.022.009	ST3,9X19MM*	1000	55664.039.019	ST4,8X50MM*	200	55664.048.050
ST2,2X13MM*	1000	55664.022.013	ST3,9X22MM*	1000	55664.039.022	ST4,8X60MM*	200	55664.048.060
ST2,2X16MM*	1000	55664.022.016	ST3,9X25MM*	1000	55664.039.025	ST4,8X70MM*	200	55664.048.070
ST2,2X19MM*	1000	55664.022.019	ST3,9X32MM*	1000	55664.039.032	ST5,5X13MM*	1000	55664.055.013
ST2,2X22MM*	1000	55664.022.022	ST3,9X38MM*	500	55664.039.038	ST5,5X16MM*	1000	55664.055.016
ST2,2X25MM*	1000	55664.022.025	ST3,9X45MM*	500	55664.039.045	ST5,5X19MM*	1000	55664.055.019
ST2,9X6,5MM*	1000	55664.029.006	ST3,9X50MM*	500	55664.039.050	ST5,5X22MM*	1000	55664.055.022
ST2,9X9,5MM*	1000	55664.029.009	ST3,9X60MM*	500	55664.039.060	ST5,5X25MM*	500	55664.055.025
ST2,9X13MM*	1000	55664.029.013	ST4,2X9,5MM*	1000	55664.042.009	ST5,5X32MM*	500	55664.055.032
ST2,9X16MM*	1000	55664.029.016	ST4,2X13MM*	1000	55664.042.013	ST5,5X38MM*	500	55664.055.038
ST2,9X19MM*	1000	55664.029.019	ST4,2X16MM*	1000	55664.042.016	ST5,5X45MM*	200	55664.055.045
ST2,9X22MM*	1000	55664.029.022	ST4,2X19MM*	1000	55664.042.019	ST5,5X50MM*	200	55664.055.050
ST2,9X25MM*	1000	55664.029.025	ST4,2X22MM*	1000	55664.042.022	ST5,5X60MM*	200	55664.055.060
ST2,9X32MM*	1000	55664.029.032	ST4,2X25MM*	1000	55664.042.025	ST5,5X70MM*	200	55664.055.070
ST3,5X6,5MM*	1000	55664.035.006	ST4,2X32MM*	500	55664.042.032	ST5,5X80MM*	200	55664.055.080
ST3,5X9,5MM*	1000	55664.035.009	ST4,2X38MM*	500	55664.042.038	ST6,3X13MM*	500	55664.063.013
ST3,5X13MM*	1000	55664.035.013	ST4,2X45MM*	500	55664.042.045	ST6,3X16MM*	500	55664.063.016
ST3,5X16MM*	1000	55664.035.016	ST4,2X50MM*	200	55664.042.050	ST6,3X19MM*	500	55664.063.019
ST3,5X19MM*	1000	55664.035.019	ST4,2X60MM*	200	55664.042.060	ST6,3X22MM*	500	55664.063.022
ST3,5X22MM*	1000	55664.035.022	ST4,8X9,5MM*	1000	55664.048.009	ST6,3X25MM*	200	55664.063.025
ST3,5X25MM*	1000	55664.035.025	ST4,8X13MM*	1000	55664.048.013	ST6,3X32MM*	200	55664.063.032
ST3,5X32MM*	1000	55664.035.032	ST4,8X16MM*	1000	55664.048.016	ST6,3X38MM*	200	55664.063.038
ST3,5X38MM*	1000	55664.035.038	ST4,8X19MM*	1000	55664.048.019	ST6,3X45MM*	200	55664.063.045
ST3,5X50MM*	500	55664.035.050	ST4,8X22MM*	1000	55664.048.022	ST6,3X50MM*	200	55664.063.050
ST3,9X6,5MM*	1000	55664.039.006	ST4,8X25MM*	500	55664.048.025	ST6,3X60MM*	200	55664.063.060
ST3,9X9,5MM*	1000	55664.039.009	ST4,8X32MM*	500	55664.048.032	ST6,3X70MM*	200	55664.063.070
ST3,9X13MM*	1000	55664.039.013	ST4,8X38MM*	500	55664.048.038	ST6,3X80MM*	200	55664.063.080

Wkręty samogwintujące z łbem walcowym wypukłym z gniazdem kwadratowym

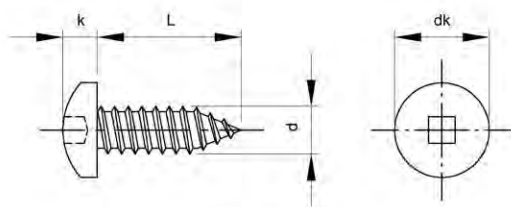

DIN ≈7981 C
 ISO ≈7049 C
 ASME ≈B18.6.4
 NF ≈E25-654 C

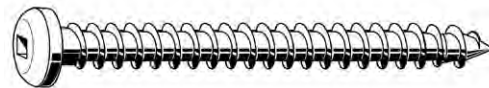

Informacje techniczne

d	d _k	k	Nr kwadratowy	P
ST3.5	6.9	2.6	1	1.3
ST3.9	7.5	2.8	1	1.4
ST4.2	8.2	3.05	2	1.4
ST4.8	9.5	3.55	2	1.6

51663 Wkręty samogwintujące z łbem walcowym wypukłym z gniazdem kwadratowym

R03A

Gwint
Materiał Samogwintujący
 Stal nierdzewna A2



6

d x L	☒	Kod artykułu	d x L	☒	Kod artykułu	d x L	☒	Kod artykułu
ST3,5X9,5MM*	200	51663.035.009	ST4,2X9,5MM*	200	51663.042.009	ST4,8X22MM*	200	51663.048.022
ST3,5X13MM*	200	51663.035.013	ST4,2X13MM*	200	51663.042.013	ST4,8X25MM*	200	51663.048.025
ST3,5X19MM*	200	51663.035.019	ST4,2X16MM*	200	51663.042.016	ST4,8X32MM*	200	51663.048.032
ST3,5X22MM*	200	51663.035.022	ST4,2X19MM*	200	51663.042.019	ST4,8X38MM*	200	51663.048.038
ST3,5X25MM*	200	51663.035.025	ST4,2X25MM*	200	51663.042.025	ST4,8X45MM*	200	51663.048.045
ST3,9X9,5MM*	200	51663.039.009	ST4,2X32MM*	200	51663.042.032	ST4,8X50MM*	200	51663.048.050
ST3,9X13MM*	200	51663.039.013	ST4,2X38MM*	200	51663.042.038	ST4,8X60MM*	200	51663.048.060
ST3,9X16MM*	200	51663.039.016	ST4,2X45MM*	200	51663.042.045	ST4,8X70MM*	200	51663.048.070
ST3,9X19MM*	200	51663.039.019	ST4,2X50MM*	200	51663.042.050	ST4,8X80MM*	200	51663.048.080
ST3,9X22MM*	200	51663.039.022				ST4,8X100MM*	200	51663.048.100
ST3,9X25MM*	200	51663.039.025	ST4,8X13MM*	200	51663.048.013	ST4,8X120MM*	200	51663.048.120
ST3,9X32MM*	200	51663.039.032	ST4,8X16MM*	200	51663.048.016	ST4,8X150MM*	200	51663.048.150
ST3,9X38MM*	200	51663.039.038	ST4,8X19MM*	200	51663.048.019			

Wkręty samogwintujące z łbem stożkowym płaskim z gniazdem krzyżowym

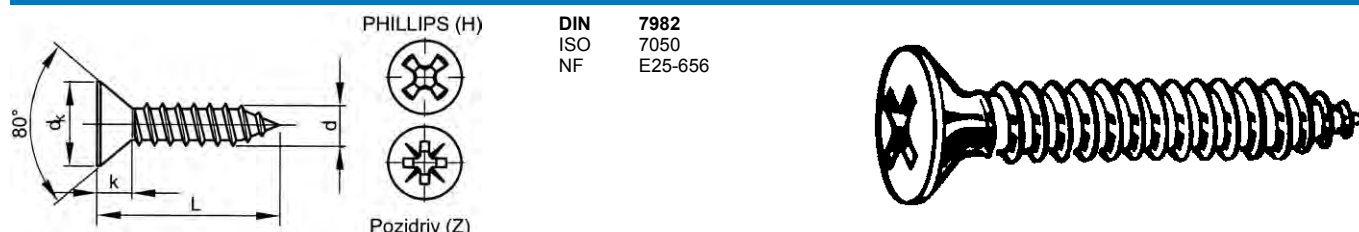

DIN 7982
ISO 7050
NF E25-656

Informacje techniczne

d	dk	k ≈	Nr wgłębienia krzyżowego	P
ST2.2	4.3	1.3	1	0.8
ST2.9	5.5	1.7	1	1.1
ST3.5	6.8	2.1	2	1.3
ST3.9	7.5	2.3	2	1.4
ST4.2	8.1	2.5	2	1.4
ST4.8	9.5	3	2	1.6
ST5.5	10.8	3.4	3	1.8
ST6.3	12.4	3.8	3	1.8

Grupy katalogowe

Gwint	Gniazdo	Materiał	Obróbka powierzchni	Kod	Strona
ST	Phillips	St	Ocynk.	26680	6-87
ST	Phillips	St	Ocynk. Duże Opakowanie	26690	6-88
ST	Pozidriv	St	Ocynk.	26770	6-88
ST	Phillips	St	Nikl.	26220	6-88
ST	Pozidriv	St	Ocynk. czrn. pas.	26432	6-89
ST	Phillips	St.St. A2		51680	6-89
ST	Pozidriv	St.St. A2		51681	6-89
ST	Phillips	St.St. A4		55680	6-90
ST	Pozidriv	St.St. A4		55681	6-90

6

26680 Wkręty samogwintujące z łbem stożkowym płaskim z gniazdem krzyżowym Phillips

J01B

Gwint Samogwintujący
Materiał Stal
Obróbka powierzchni Ocynkowane

DIN 7982 C-H
ISO 7050 C-H



d x L	☒	Kod artykułu	d x L	☒	Kod artykułu	d x L	☒	Kod artykułu
ST2,9X6,5MM	200	26680.029.006	ST3,9X25MM	200	26680.039.025	ST4,8X50MM	100	26680.048.050
ST2,9X9,5MM	200	26680.029.009	ST3,9X32MM	200	26680.039.032	ST5,5X13MM	200	26680.055.013
ST2,9X13MM	200	26680.029.013	ST4,2X9,5MM	200	26680.042.009	ST5,5X16MM	200	26680.055.016
ST2,9X16MM	200	26680.029.016	ST4,2X13MM	200	26680.042.013	ST5,5X19MM	200	26680.055.019
ST2,9X19MM	200	26680.029.019	ST4,2X16MM	200	26680.042.016	ST5,5X22MM	100	26680.055.022
ST2,9X22MM	200	26680.029.022	ST4,2X19MM	200	26680.042.019	ST5,5X25MM	100	26680.055.025
ST2,9X25MM	200	26680.029.025	ST4,2X22MM	200	26680.042.022	ST5,5X32MM	100	26680.055.032
ST3,5X9,5MM	200	26680.035.009	ST4,2X25MM	200	26680.042.025	ST5,5X38MM	100	26680.055.038
ST3,5X13MM	200	26680.035.013	ST4,2X32MM	200	26680.042.032	ST5,5X45MM	100	26680.055.045
ST3,5X16MM	200	26680.035.016	ST4,2X38MM	200	26680.042.038	ST5,5X50MM	100	26680.055.050
ST3,5X19MM	200	26680.035.019	ST4,2X45MM	200	26680.042.045	ST6,3X16MM	100	26680.063.016
ST3,5X22MM	200	26680.035.022	ST4,2X50MM	200	26680.042.050	ST6,3X19MM	100	26680.063.019
ST3,5X25MM	200	26680.035.025	ST4,8X13MM	200	26680.048.013	ST6,3X22MM	100	26680.063.022
ST3,5X32MM	200	26680.035.032	ST4,8X16MM	200	26680.048.016	ST6,3X25MM	100	26680.063.025
ST3,5X38MM	200	26680.035.038	ST4,8X19MM	200	26680.048.019	ST6,3X32MM	100	26680.063.032
ST3,9X9,5MM	200	26680.039.009	ST4,8X22MM	200	26680.048.022	ST6,3X38MM	100	26680.063.038
ST3,9X13MM	200	26680.039.013	ST4,8X25MM	200	26680.048.025	ST6,3X45MM	100	26680.063.045
ST3,9X16MM	200	26680.039.016	ST4,8X32MM	100	26680.048.032	ST6,3X50MM	100	26680.063.050
ST3,9X19MM	200	26680.039.019	ST4,8X38MM	100	26680.048.038	ST6,3X60MM	100	26680.063.060
ST3,9X22MM	200	26680.039.022	ST4,8X45MM	100	26680.048.045			

• Ostrzeżenie: cynkowanie elektrolityczne tych produktów może wywołać kruchość wodorową.

26690 Wkręty samogwintujące z łbem stożkowym płaskim z gniazdem krzyżowym Phillips				J01B
Gwint	Samogwintujący	DIN	7982 C-H	
Materiał	Stal	ISO	7050 C-H	
Obróbka powierzchni	O cynkowane			



d x L	✉	Kod artykułu	d x L	✉	Kod artykułu	d x L	✉	Kod artykułu
ST2,9X9,5MM	2000	26690.029.009	ST3,5X25MM	2000	26690.035.025	ST4,2X25MM	1000	26690.042.025
ST2,9X13MM	2000	26690.029.013						
ST3,5X9,5MM	2000	26690.035.009	ST3,9X32MM	500	26690.039.032	ST4,8X16MM	1000	26690.048.016
ST3,5X13MM	2000	26690.035.013				ST4,8X19MM	1000	26690.048.019
ST3,5X16MM	2000	26690.035.016	ST4,2X13MM	1000	26690.042.013	ST4,8X25MM	1000	26690.048.025
ST3,5X19MM	2000	26690.035.019	ST4,2X16MM	1000	26690.042.016	ST4,8X32MM	500	26690.048.032
			ST4,2X19MM	1000	26690.042.019	ST4,8X38MM	500	26690.048.038

• Ostrzeżenie: cynkowanie elektrolityczne tych produktów może wywołać kruchość wodorową.

26770 Wkręty samogwintujące z łbem stożkowym płaskim z gniazdem krzyżowym Pozidriv				J01A
Gwint	Samogwintujący	DIN	7982 C-Z	
Materiał	Stal	ISO	7050 C-Z	
Obróbka powierzchni	O cynkowane	NF	E25-656 C	



d x L	✉	Kod artykułu	d x L	✉	Kod artykułu	d x L	✉	Kod artykułu
ST2,9X9,5MM	200	26770.029.009	ST3,9X32MM	200	26770.039.032	ST5,5X13MM	200	26770.055.013
ST2,9X13MM	200	26770.029.013				ST5,5X16MM	200	26770.055.016
ST2,9X16MM	200	26770.029.016	ST4,2X9,5MM	200	26770.042.009	ST5,5X19MM	200	26770.055.019
ST2,9X19MM	200	26770.029.019	ST4,2X13MM	200	26770.042.013	ST5,5X25MM	100	26770.055.025
ST2,9X25MM	200	26770.029.025	ST4,2X16MM	200	26770.042.016	ST5,5X32MM	100	26770.055.032
			ST4,2X19MM	200	26770.042.019	ST5,5X38MM	100	26770.055.038
ST3,5X9,5MM	200	26770.035.009	ST4,2X25MM	200	26770.042.025	ST5,5X45MM	100	26770.055.045
ST3,5X13MM	200	26770.035.013	ST4,2X32MM	200	26770.042.032	ST5,5X50MM	100	26770.055.050
ST3,5X16MM	200	26770.035.016	ST4,2X38MM	200	26770.042.038			
ST3,5X19MM	200	26770.035.019	ST4,2X45MM	200	26770.042.045	ST6,3X16MM	100	26770.063.016
ST3,5X25MM	200	26770.035.025				ST6,3X19MM	100	26770.063.019
ST3,5X32MM	200	26770.035.032	ST4,8X13MM	200	26770.048.013	ST6,3X25MM	100	26770.063.025
ST3,5X38MM	200	26770.035.038	ST4,8X16MM	200	26770.048.016	ST6,3X32MM	100	26770.063.032
			ST4,8X19MM	200	26770.048.019	ST6,3X38MM	100	26770.063.038
ST3,9X9,5MM	200	26770.039.009	ST4,8X25MM	200	26770.048.025	ST6,3X45MM	100	26770.063.045
ST3,9X13MM	200	26770.039.013	ST4,8X32MM	100	26770.048.032	ST6,3X50MM	100	26770.063.050
ST3,9X16MM	200	26770.039.016	ST4,8X38MM	100	26770.048.038	ST6,3X60MM	100	26770.063.060
ST3,9X19MM	200	26770.039.019	ST4,8X45MM	100	26770.048.045			
ST3,9X25MM	200	26770.039.025	ST4,8X50MM	100	26770.048.050			

• Ostrzeżenie: cynkowanie elektrolityczne tych produktów może wywołać kruchość wodorową.

26220 Wkręty samogwintujące z łbem stożkowym płaskim z gniazdem krzyżowym Phillips				J03B
Gwint	Samogwintujący	DIN	7982 C-H	
Materiał	Stal	ISO	7050 C-H	
Obróbka powierzchni	Niklowane			



d x L	✉	Kod artykułu	d x L	✉	Kod artykułu	d x L	✉	Kod artykułu
ST3,5X13MM	200	26220.035.013	ST4,2X25MM	200	26220.042.025	ST5,5X25MM	100	26220.055.025
ST3,5X16MM	200	26220.035.016	ST4,2X32MM	200	26220.042.032	ST5,5X32MM	100	26220.055.032
ST3,5X19MM	200	26220.035.019	ST4,2X38MM	200	26220.042.038			
ST3,5X25MM	200	26220.035.025				ST6,3X25MM	100	26220.063.025
			ST4,8X16MM	200	26220.048.016	ST6,3X45MM	100	26220.063.045
ST4,2X9,5MM	200	26220.042.009	ST4,8X19MM	200	26220.048.019	ST6,3X50MM	100	26220.063.050
ST4,2X13MM	200	26220.042.013	ST4,8X25MM	200	26220.048.025	ST6,3X55MM	100	26220.063.055
ST4,2X16MM	200	26220.042.016	ST4,8X32MM	100	26220.048.032	ST6,3X60MM	100	26220.063.060
ST4,2X19MM	200	26220.042.019						

• Ostrzeżenie: cynkowanie elektrolityczne tych produktów może wywołać kruchość wodorową.

6

26432 Wkręty samogwintujące z łbem stożkowym płaskim z gniazdem krzyżowym Pozidriv				J03B
Gwint	Samogwintujący	DIN	7982 C-Z	
Materiał	Stal	ISO	7050 C-Z	
Obróbka powierzchni	Ocynkowane, po czarnej pasywacji	NF	E25-656 C	

d x L	☒	Kod artykułu	d x L	☒	Kod artykułu	d x L	☒	Kod artykułu
ST2,9X13MM	200	26432.029.013	ST3,5X16MM	200	26432.035.016	ST4,2X16MM	200	26432.042.016
ST3,5X9,5MM	200	26432.035.009	ST3,5X19MM	200	26432.035.019	ST4,2X19MM	200	26432.042.019

• Ostrzeżenie: cynkowanie elektrolityczne tych produktów może wywołać kruchość wodorową.

51680 Wkręty samogwintujące z łbem stożkowym płaskim z gniazdem krzyżowym Phillips				R01A
Gwint	Samogwintujący	DIN	7982 C-H	
Materiał	Stal nierdzewna A2	ISO	7050 C-H	



d x L	☒	Kod artykułu	d x L	☒	Kod artykułu	d x L	☒	Kod artykułu
ST2,2X6,5MM	1000	51680.022.006	ST3,9X22MM	200	51680.039.022	ST4,8X80MM	200	51680.048.080
ST2,2X9,5MM*	1000	51680.022.009	ST3,9X25MM	200	51680.039.025	ST4,8X90MM	200	51680.048.090
ST2,2X13MM*	1000	51680.022.013	ST3,9X32MM	200	51680.039.032	ST4,8X100MM	100	51680.048.100
ST2,2X16MM	1000	51680.022.016	ST3,9X38MM	200	51680.039.038	ST4,8X120MM*	200	51680.048.120
ST2,2X19MM*	1000	51680.022.019	ST3,9X45MM*	500	51680.039.045	ST5,5X13MM	200	51680.055.013
ST2,2X22MM*	1000	51680.022.022	ST3,9X50MM	500	51680.039.050	ST5,5X16MM	200	51680.055.016
ST2,2X25MM*	1000	51680.022.025	ST3,9X60MM*	500	51680.039.060	ST5,5X19MM	200	51680.055.019
			ST3,9X70MM*	500	51680.039.070	ST5,5X22MM	200	51680.055.022
ST2,9X6,5MM	200	51680.029.006				ST5,5X25MM	200	51680.055.025
ST2,9X9,5MM	200	51680.029.009	ST4,2X9,5MM	200	51680.042.009	ST5,5X32MM	100	51680.055.032
ST2,9X13MM	200	51680.029.013	ST4,2X13MM	200	51680.042.013	ST5,5X38MM	100	51680.055.038
ST2,9X16MM	200	51680.029.016	ST4,2X16MM	200	51680.042.016	ST5,5X45MM	100	51680.055.045
ST2,9X19MM	200	51680.029.019	ST4,2X19MM	200	51680.042.019	ST5,5X50MM	100	51680.055.050
ST2,9X22MM	200	51680.029.022	ST4,2X22MM	200	51680.042.022	ST5,5X60MM	200	51680.055.060
ST2,9X25MM	200	51680.029.025	ST4,2X25MM	200	51680.042.025	ST5,5X70MM*	200	51680.055.070
ST2,9X32MM*	1000	51680.029.032	ST4,2X32MM	200	51680.042.032	ST5,5X80MM*	200	51680.055.080
			ST4,2X38MM	200	51680.042.038	ST5,5X90MM*	200	51680.055.090
ST3,5X6,5MM*	1000	51680.035.006	ST4,2X45MM	200	51680.042.045	ST5,5X100MM*	200	51680.055.100
ST3,5X9,5MM	200	51680.035.009	ST4,2X50MM	200	51680.042.050	ST5,5X120MM*	200	51680.055.120
ST3,5X13MM	200	51680.035.013	ST4,2X60MM	200	51680.042.060			
ST3,5X16MM	200	51680.035.016	ST4,2X70MM*	200	51680.042.070	ST6,3X13MM*	500	51680.063.013
ST3,5X19MM	200	51680.035.019	ST4,2X80MM*	200	51680.042.080	ST6,3X16MM	100	51680.063.016
ST3,5X22MM	200	51680.035.022				ST6,3X19MM	100	51680.063.019
ST3,5X25MM	200	51680.035.025	ST4,8X9,5MM	200	51680.048.009	ST6,3X22MM	100	51680.063.022
ST3,5X32MM	200	51680.035.032	ST4,8X13MM	200	51680.048.013	ST6,3X25MM	100	51680.063.025
ST3,5X38MM	200	51680.035.038	ST4,8X16MM	200	51680.048.016	ST6,3X32MM	100	51680.063.032
ST3,5X45MM*	500	51680.035.045	ST4,8X19MM	200	51680.048.019	ST6,3X38MM	100	51680.063.038
ST3,5X50MM*	500	51680.035.050	ST4,8X22MM	200	51680.048.022	ST6,3X45MM	100	51680.063.045
ST3,5X60MM*	500	51680.035.060	ST4,8X25MM	200	51680.048.025	ST6,3X50MM	100	51680.063.050
ST3,5X70MM*	500	51680.035.070	ST4,8X32MM	200	51680.048.032	ST6,3X60MM*	200	51680.063.060
			ST4,8X38MM	200	51680.048.038	ST6,3X70MM*	200	51680.063.070
ST3,9X6,5MM*	1000	51680.039.006	ST4,8X45MM	200	51680.048.045	ST6,3X80MM*	200	51680.063.080
ST3,9X9,5MM	200	51680.039.009	ST4,8X50MM	200	51680.048.050	ST6,3X90MM*	200	51680.063.090
ST3,9X13MM	200	51680.039.013	ST4,8X55MM*	200	51680.048.055	ST6,3X100MM*	200	51680.063.100
ST3,9X16MM	200	51680.039.016	ST4,8X60MM	200	51680.048.060			
ST3,9X19MM	200	51680.039.019	ST4,8X70MM	200	51680.048.070			

6

51681 Wkręty samogwintujące z łbem stożkowym płaskim z gniazdem krzyżowym Pozidriv				R01A
Gwint	Samogwintujący	DIN	7982 C-Z	
Materiał	Stal nierdzewna A2	ISO	7050 C-Z	
		NF	E25-656 C	



d x L	☒	Kod artykułu	d x L	☒	Kod artykułu	d x L	☒	Kod artykułu
ST2,2X6,5MM*	1000	51681.022.006	ST2,9X16MM	200	51681.029.016	ST3,5X19MM	200	51681.035.019
ST2,2X9,5MM*	1000	51681.022.009	ST2,9X19MM	200	51681.029.019	ST3,5X22MM*	1000	51681.035.022
ST2,2X13MM*	1000	51681.022.013	ST2,9X22MM*	1000	51681.029.022	ST3,5X25MM	200	51681.035.025
ST2,2X16MM*	1000	51681.022.016	ST2,9X25MM	200	51681.029.025	ST3,5X32MM	200	51681.035.032
ST2,2X19MM*	1000	51681.022.019	ST2,9X32MM*	1000	51681.029.032	ST3,5X38MM	200	51681.035.038
ST2,2X25MM*	1000	51681.022.025				ST3,9X6,5MM*	1000	51681.039.006
ST2,9X6,5MM*	1000	51681.029.006	ST3,5X6,5MM*	1000	51681.035.006	ST3,9X9,5MM*	1000	51681.039.009
ST2,9X9,5MM	200	51681.029.009	ST3,5X9,5MM	200	51681.035.009	ST3,9X13MM	200	51681.039.013
ST2,9X13MM	200	51681.029.013	ST3,5X13MM	200	51681.035.013	ST3,9X16MM	200	51681.039.016
			ST3,5X16MM	200	51681.035.016			

51681 Wkręty samogwintujące z łbem stożkowym płaskim z gniazdem krzyżowym Pozidriv								
d x L	☒	Kod artykułu	d x L	☒	Kod artykułu	d x L	☒	Kod artykułu
ST3,9X19MM	200	51681.039.019	ST4,8X9,5MM*	1000	51681.048.009	ST5,5X38MM	100	51681.055.038
ST3,9X22MM*	1000	51681.039.022	ST4,8X16MM	200	51681.048.016	ST5,5X45MM	100	51681.055.045
ST3,9X25MM	200	51681.039.025	ST4,8X19MM	200	51681.048.019	ST5,5X50MM	100	51681.055.050
ST3,9X32MM	200	51681.039.032	ST4,8X22MM*	1000	51681.048.022	ST5,5X60MM*	200	51681.055.060
ST3,9X38MM*	500	51681.039.038	ST4,8X25MM	200	51681.048.025	ST5,5X70MM*	200	51681.055.070
ST3,9X45MM*	500	51681.039.045	ST4,8X32MM	200	51681.048.032	ST5,5X80MM*	200	51681.055.080
ST3,9X50MM*	500	51681.039.050	ST4,8X38MM	200	51681.048.038	ST5,5X100MM*	200	51681.055.100
ST4,2X9,5MM*	1000	51681.042.009	ST4,8X45MM	200	51681.048.045	ST6,3X16MM*	500	51681.063.016
ST4,2X13MM	200	51681.042.013	ST4,8X50MM	200	51681.048.050	ST6,3X19MM*	500	51681.063.019
ST4,2X16MM	200	51681.042.016	ST4,8X60MM	200	51681.048.060	ST6,3X22MM*	500	51681.063.022
ST4,2X19MM	200	51681.042.019	ST4,8X70MM	200	51681.048.070	ST6,3X25MM	100	51681.063.025
ST4,2X22MM*	1000	51681.042.022	ST4,8X80MM*	200	51681.048.080	ST6,3X32MM	100	51681.063.032
ST4,2X25MM	200	51681.042.025	ST4,8X90MM*	200	51681.048.090	ST6,3X38MM	100	51681.063.038
ST4,2X32MM	200	51681.042.032	ST4,8X100MM*	200	51681.048.100	ST6,3X45MM	100	51681.063.045
ST4,2X38MM	200	51681.042.038	ST5,5X13MM*	1000	51681.055.013	ST6,3X50MM	100	51681.063.050
ST4,2X45MM	200	51681.042.045	ST5,5X16MM*	1000	51681.055.016	ST6,3X60MM*	200	51681.063.060
ST4,2X50MM	200	51681.042.050	ST5,5X19MM	200	51681.055.019	ST6,3X70MM*	200	51681.063.070
ST4,2X60MM*	200	51681.042.060	ST5,5X22MM*	1000	51681.055.022	ST6,3X80MM*	200	51681.063.080
ST4,2X70MM*	200	51681.042.070	ST5,5X25MM*	500	51681.055.025			
			ST5,5X32MM	100	51681.055.032			

55680 Wkręty samogwintujące z łbem stożkowym płaskim z gniazdem krzyżowym Phillips					R41A
Gwint	Samogwintujący	DIN	7982 C-H		
Materiał	Stal nierdzewna A4	ISO	7050 C-H		
					

d x L	☒	Kod artykułu	d x L	☒	Kod artykułu	d x L	☒	Kod artykułu
ST2,2X6,5MM*	1000	55680.022.006	ST3,9X38MM*	500	55680.039.038	ST4,8X90MM*	200	55680.048.090
ST2,2X9,5MM*	1000	55680.022.009	ST3,9X45MM*	500	55680.039.045	ST4,8X100MM*	200	55680.048.100
ST2,2X19MM*	1000	55680.022.019	ST3,9X50MM*	500	55680.039.050			
ST2,9X6,5MM*	1000	55680.029.006	ST4,2X9,5MM*	1000	55680.042.009	ST5,5X13MM*	1000	55680.055.013
ST2,9X9,5MM	200	55680.029.009	ST4,2X13MM	200	55680.042.013	ST5,5X16MM	200	55680.055.016
ST2,9X13MM	200	55680.029.013	ST4,2X16MM	200	55680.042.016	ST5,5X19MM	200	55680.055.019
ST2,9X16MM	200	55680.029.016	ST4,2X19MM	200	55680.042.019	ST5,5X22MM	200	55680.055.022
ST2,9X19MM	200	55680.029.019	ST4,2X22MM	200	55680.042.022	ST5,5X25MM	200	55680.055.025
ST2,9X22MM*	1000	55680.029.022	ST4,2X25MM	200	55680.042.025	ST5,5X32MM	100	55680.055.032
ST2,9X25MM	200	55680.029.025	ST4,2X32MM	200	55680.042.032	ST5,5X38MM	100	55680.055.038
ST2,9X32MM*	1000	55680.029.032	ST4,2X38MM	200	55680.042.038	ST5,5X45MM	100	55680.055.045
			ST4,2X45MM*	500	55680.042.045	ST5,5X50MM	100	55680.055.050
ST3,5X6,5MM*	1000	55680.035.006	ST4,2X50MM*	200	55680.042.050	ST5,5X60MM*	200	55680.055.060
ST3,5X9,5MM	200	55680.035.009	ST4,2X60MM*	200	55680.042.060	ST5,5X70MM*	200	55680.055.070
ST3,5X13MM	200	55680.035.013	ST4,2X70MM*	200	55680.042.070	ST5,5X80MM*	200	55680.055.080
ST3,5X16MM	200	55680.035.016				ST5,5X100MM*	200	55680.055.100
ST3,5X19MM	200	55680.035.019	ST4,8X9,5MM*	1000	55680.048.009	ST6,3X13MM*	500	55680.063.013
ST3,5X22MM	200	55680.035.022	ST4,8X13MM*	1000	55680.048.013	ST6,3X16MM	100	55680.063.016
ST3,5X25MM	200	55680.035.025	ST4,8X16MM	200	55680.048.016	ST6,3X19MM	100	55680.063.019
ST3,5X32MM	200	55680.035.032	ST4,8X19MM	200	55680.048.019	ST6,3X22MM	100	55680.063.022
ST3,5X38MM*	1000	55680.035.038	ST4,8X22MM	200	55680.048.022	ST6,3X25MM	100	55680.063.025
			ST4,8X25MM	200	55680.048.025	ST6,3X32MM	100	55680.063.032
ST3,9X9,5MM*	1000	55680.039.009	ST4,8X32MM	200	55680.048.032	ST6,3X38MM	100	55680.063.038
ST3,9X13MM	200	55680.039.013	ST4,8X38MM	200	55680.048.038	ST6,3X45MM	100	55680.063.045
ST3,9X16MM	200	55680.039.016	ST4,8X45MM*	200	55680.048.045	ST6,3X50MM	100	55680.063.050
ST3,9X19MM	200	55680.039.019	ST4,8X50MM*	200	55680.048.050	ST6,3X60MM*	200	55680.063.060
ST3,9X22MM	200	55680.039.022	ST4,8X60MM*	200	55680.048.060	ST6,3X70MM*	200	55680.063.070
ST3,9X25MM	200	55680.039.025	ST4,8X70MM*	200	55680.048.070	ST6,3X80MM*	200	55680.063.080
ST3,9X32MM*	1000	55680.039.032	ST4,8X80MM*	200	55680.048.080	ST6,3X90MM*	200	55680.063.090

55681 Wkręty samogwintujące z łbem stożkowym płaskim z gniazdem krzyżowym Pozidriv					R41A
Gwint	Samogwintujący	DIN	7982 C-Z		
Materiał	Stal nierdzewna A4	ISO	7050 C-Z		
		NF	E25-656 C		
					

d x L	☒	Kod artykułu	d x L	☒	Kod artykułu	d x L	☒	Kod artykułu
ST2,2X6,5MM*	1000	55681.022.006	ST2,9X9,5MM*	1000	55681.029.009	ST3,5X6,5MM*	1000	55681.035.006
ST2,2X9,5MM*	1000	55681.022.009	ST2,9X13MM*	1000	55681.029.013	ST3,5X9,5MM*	1000	55681.035.009
ST2,2X13MM*	1000	55681.022.013	ST2,9X16MM*	1000	55681.029.016	ST3,5X13MM*	1000	55681.035.013
ST2,2X16MM*	1000	55681.022.016	ST2,9X19MM*	1000	55681.029.019	ST3,5X16MM*	1000	55681.035.016
ST2,2X19MM*	1000	55681.022.019	ST2,9X22MM*	1000	55681.029.022	ST3,5X19MM*	1000	55681.035.019
			ST2,9X25MM*	1000	55681.029.025	ST3,5X22MM*	1000	55681.035.022
ST2,9X6,5MM*	1000	55681.029.006	ST2,9X32MM*	1000	55681.029.032			

55681 Wkręty samogwintujące z łbem stożkowym płaskim z gniazdem krzyżowym Pozidriv								
d x L	☒	Kod artykułu	d x L	☒	Kod artykułu	d x L	☒	Kod artykułu
ST3,5X25MM*	1000	55681.035.025	ST4,2X50MM*	200	55681.042.050	ST5,5X38MM*	500	55681.055.038
ST3,5X32MM*	1000	55681.035.032	ST4,2X60MM*	200	55681.042.060	ST5,5X45MM*	200	55681.055.045
ST3,5X38MM*	1000	55681.035.038				ST5,5X50MM*	200	55681.055.050
			ST4,8X9MM*	1000	55681.048.009	ST5,5X60MM*	200	55681.055.060
ST3,9X9,5MM*	1000	55681.039.009	ST4,8X13MM*	1000	55681.048.013	ST5,5X70MM*	200	55681.055.070
ST3,9X13MM*	1000	55681.039.013	ST4,8X16MM*	1000	55681.048.016	ST5,5X80MM*	200	55681.055.080
ST3,9X16MM*	1000	55681.039.016	ST4,8X19MM*	1000	55681.048.019	ST5,5X90MM*	200	55681.055.090
ST3,9X19MM*	1000	55681.039.019	ST4,8X22MM*	1000	55681.048.022	ST5,5X100MM*	200	55681.055.100
ST3,9X22MM*	1000	55681.039.022	ST4,8X25MM*	500	55681.048.025			
ST3,9X25MM*	1000	55681.039.025	ST4,8X32MM*	500	55681.048.032	ST6,3X13MM*	500	55681.063.013
ST3,9X32MM*	1000	55681.039.032	ST4,8X38MM*	500	55681.048.038	ST6,3X16MM*	500	55681.063.016
ST3,9X38MM*	500	55681.039.038	ST4,8X45MM*	200	55681.048.045	ST6,3X19MM*	500	55681.063.019
ST3,9X50MM*	500	55681.039.050	ST4,8X50MM*	200	55681.048.050	ST6,3X22MM*	500	55681.063.022
			ST4,8X60MM*	200	55681.048.060	ST6,3X25MM*	200	55681.063.025
ST4,2X9,5MM*	1000	55681.042.009	ST4,8X70MM*	200	55681.048.070	ST6,3X32MM*	200	55681.063.032
ST4,2X13MM*	1000	55681.042.013	ST4,8X80MM*	200	55681.048.080	ST6,3X38MM*	200	55681.063.038
ST4,2X16MM*	1000	55681.042.016				ST6,3X45MM*	200	55681.063.045
ST4,2X19MM*	1000	55681.042.019	ST5,5X13MM*	1000	55681.055.013	ST6,3X50MM*	200	55681.063.050
ST4,2X22MM*	1000	55681.042.022	ST5,5X16MM*	1000	55681.055.016	ST6,3X60MM*	200	55681.063.060
ST4,2X25MM*	1000	55681.042.025	ST5,5X19MM*	1000	55681.055.019	ST6,3X70MM*	200	55681.063.070
ST4,2X32MM*	500	55681.042.032	ST5,5X22MM*	1000	55681.055.022	ST6,3X80MM*	200	55681.063.080
ST4,2X38MM*	500	55681.042.038	ST5,5X25MM*	500	55681.055.025	ST6,3X90MM*	200	55681.063.090
ST4,2X45MM*	500	55681.042.045	ST5,5X32MM*	500	55681.055.032	ST6,3X100MM*	200	55681.063.100

Wkręty samogwintujące z łbem stożkowym płaskim z gniazdem sześciokarbowym

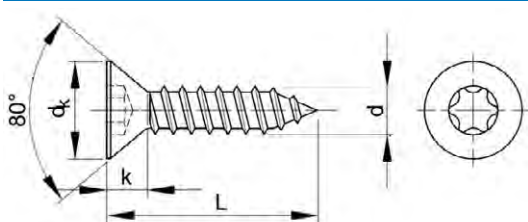

ISO 14586 C
DIN ≈7982 C

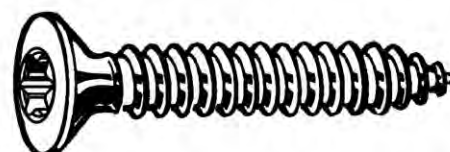

6

Informacje techniczne

d	dk	k ≈	Nasadka	P
ST2.2	4.3	1.3	T6	0.8
ST2.9	5.5	1.7	T10	1.1
ST3.5	7.3	2.35	T15	1.3
ST3.9 (#ISO)	7.5	2.3	T20	1.3
ST4.2	8.4	2.6	T20	1.4
ST4.8	9.3	2.8	T25	1.6
ST5.5	10.3	3	T25	1.8
ST6.3	11.3	3.15	T30	1.8

Grupy katalogowe

Gwint	Gniazdo	Materiał	Obróbka powierzchni	Kod	Strona
ST	Sześciokarbowy	St	Ocynk.	26521	6-91
ST	Sześciokarbowy	St.St. A2		51683	6-92
ST	Sześciokarbowy	St.St. A4		55683	6-92

26521 Wkręty samogwintujące z łbem stożkowym płaskim z gniazdem sześciokarbowym

J03A

Gwint Samogwintujący
Materiał Stal
Obróbka powierzchni Ocynkowane

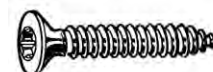

d x L	☒	Kod artykułu	d x L	☒	Kod artykułu	d x L	☒	Kod artykułu
ST2,9X9,5MM	200	26521.029.009	ST3,5X32MM	200	26521.035.032	ST4,2X9,5MM	500	26521.042.009
ST2,9X13MM	200	26521.029.013	ST3,5X38MM	200	26521.035.038	ST4,2X13MM	500	26521.042.013
ST2,9X16MM	500	26521.029.016				ST4,2X16MM	500	26521.042.016
ST2,9X19MM	500	26521.029.019	ST3,9X9,5MM	200	26521.039.009	ST4,2X19MM	200	26521.042.019
			ST3,9X16MM	500	26521.039.016	ST4,2X22MM	500	26521.042.022
ST3,5X9,5MM	1000	26521.035.009	ST3,9X19MM	500	26521.039.019	ST4,2X25MM	500	26521.042.025
ST3,5X13MM	1000	26521.035.013	ST3,9X22MM	500	26521.039.022	ST4,2X32MM	200	26521.042.032
ST3,5X16MM	200	26521.035.016	ST3,9X25MM	500	26521.039.025	ST4,2X38MM	200	26521.042.038
ST3,5X19MM	200	26521.035.019	ST3,9X32MM	500	26521.039.032	ST4,2X45MM	200	26521.042.045
ST3,5X22MM	500	26521.035.022	ST3,9X38MM	200	26521.039.038	ST4,2X50MM	200	26521.042.050
ST3,5X25MM	500	26521.035.025						

26521 Wkręty samogwintujące z łbem stożkowym płaskim z gniazdem sześciokątnym

d x L	☒	Kod artykułu	d x L	☒	Kod artykułu	d x L	☒	Kod artykułu
ST4,8X16MM	500	26521.048.016	ST4,8X38MM	200	26521.048.038	ST6,3X45MM	100	26521.063.045
ST4,8X19MM	200	26521.048.019	ST4,8X45MM	200	26521.048.045	ST6,3X50MM	100	26521.063.050
ST4,8X22MM	500	26521.048.022	ST4,8X50MM	100	26521.048.050			
ST4,8X25MM	200	26521.048.025						
ST4,8X32MM	200	26521.048.032	ST5,5X45MM	100	26521.055.045			

• Ostrzeżenie: cynkowanie elektrolityczne tych produktów może wywołać kruchość wodorową.

51683 Wkręty samogwintujące z łbem stożkowym płaskim z gniazdem sześciokątnym
R03A

Gwint Samogwintujący
Materiał Stal nierdzewna A2

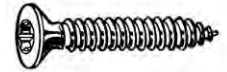

d x L	☒	Kod artykułu	d x L	☒	Kod artykułu	d x L	☒	Kod artykułu
ST2,2X6,5MM*	1000	51683.022.006	ST3,9X9,5MM*	1000	51683.039.009	ST4,8X45MM*	200	51683.048.045
ST2,2X9,5MM*	1000	51683.022.009	ST3,9X13MM*	1000	51683.039.013	ST4,8X50MM*	200	51683.048.050
ST2,2X13MM*	1000	51683.022.013	ST3,9X16MM*	1000	51683.039.016	ST4,8X60MM*	200	51683.048.060
ST2,2X16MM*	1000	51683.022.016	ST3,9X19MM*	1000	51683.039.019			
ST2,2X19MM*	1000	51683.022.019	ST3,9X22MM*	1000	51683.039.022	ST5,5X13MM*	1000	51683.055.013
ST2,2X22MM*	1000	51683.022.022	ST3,9X25MM*	1000	51683.039.025	ST5,5X16MM*	1000	51683.055.016
ST2,2X25MM*	1000	51683.022.025	ST3,9X32MM*	1000	51683.039.032	ST5,5X19MM*	1000	51683.055.019
			ST3,9X38MM*	500	51683.039.038	ST5,5X22MM*	1000	51683.055.022
ST2,9X6,5MM*	1000	51683.029.006	ST3,9X45MM*	500	51683.039.045	ST5,5X25MM*	500	51683.055.025
ST2,9X9,5MM*	1000	51683.029.009	ST3,9X50MM*	500	51683.039.050	ST5,5X32MM*	500	51683.055.032
ST2,9X13MM*	1000	51683.029.013				ST5,5X38MM*	500	51683.055.038
ST2,9X16MM*	1000	51683.029.016	ST4,2X9,5MM*	1000	51683.042.009	ST5,5X45MM*	200	51683.055.045
ST2,9X19MM*	1000	51683.029.019	ST4,2X13MM*	1000	51683.042.013	ST5,5X50MM*	200	51683.055.050
ST2,9X22MM*	1000	51683.029.022	ST4,2X16MM*	1000	51683.042.016	ST5,5X60MM*	200	51683.055.060
ST2,9X25MM*	1000	51683.029.025	ST4,2X19MM*	1000	51683.042.019	ST5,5X70MM*	200	51683.055.070
ST2,9X32MM*	1000	51683.029.032	ST4,2X22MM*	1000	51683.042.022	ST5,5X80MM*	200	51683.055.080
			ST4,2X25MM*	1000	51683.042.025			
ST3,5X6,5MM*	1000	51683.035.006	ST4,2X32MM*	500	51683.042.032	ST6,3X13MM*	500	51683.063.013
ST3,5X9,5MM*	1000	51683.035.009	ST4,2X38MM*	500	51683.042.038	ST6,3X16MM*	500	51683.063.016
ST3,5X13MM*	1000	51683.035.013	ST4,2X45MM*	500	51683.042.045	ST6,3X19MM*	500	51683.063.019
ST3,5X16MM*	1000	51683.035.016	ST4,2X50MM*	200	51683.042.050	ST6,3X22MM*	500	51683.063.022
ST3,5X19MM*	1000	51683.035.019				ST6,3X25MM*	200	51683.063.025
ST3,5X22MM*	1000	51683.035.022	ST4,8X9,5MM*	1000	51683.048.009	ST6,3X32MM*	200	51683.063.032
ST3,5X25MM*	1000	51683.035.025	ST4,8X13MM*	1000	51683.048.013	ST6,3X38MM*	200	51683.063.038
ST3,5X32MM*	1000	51683.035.032	ST4,8X16MM*	1000	51683.048.016	ST6,3X45MM*	200	51683.063.045
ST3,5X38MM*	1000	51683.035.038	ST4,8X19MM*	1000	51683.048.019	ST6,3X50MM*	200	51683.063.050
ST3,5X45MM*	500	51683.035.045	ST4,8X22MM*	1000	51683.048.022	ST6,3X60MM*	200	51683.063.060
ST3,5X50MM*	500	51683.035.050	ST4,8X25MM*	500	51683.048.025	ST6,3X70MM*	200	51683.063.070
			ST4,8X32MM*	500	51683.048.032	ST6,3X80MM*	200	51683.063.080
ST3,9X6,5MM*	1000	51683.039.006	ST4,8X38MM*	500	51683.048.038			

55683 Wkręty samogwintujące z łbem stożkowym płaskim z gniazdem sześciokątnym
R43A

Gwint Samogwintujący
Materiał Stal nierdzewna A4

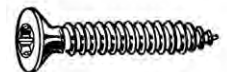

d x L	☒	Kod artykułu	d x L	☒	Kod artykułu	d x L	☒	Kod artykułu
ST2,2X6,5MM*	1000	55683.022.006	ST3,5X22MM*	1000	55683.035.022	ST4,2X16MM*	1000	55683.042.016
ST2,2X9,5MM*	1000	55683.022.009	ST3,5X25MM*	1000	55683.035.025	ST4,2X19MM*	1000	55683.042.019
ST2,2X13MM*	1000	55683.022.013	ST3,5X32MM*	1000	55683.035.032	ST4,2X22MM*	1000	55683.042.022
ST2,2X16MM*	1000	55683.022.016	ST3,5X38MM*	1000	55683.035.038	ST4,2X25MM*	1000	55683.042.025
ST2,2X19MM*	1000	55683.022.019	ST3,5X45MM*	500	55683.035.045	ST4,2X32MM*	500	55683.042.032
ST2,2X25MM*	1000	55683.022.025	ST3,5X50MM*	500	55683.035.050	ST4,2X38MM*	500	55683.042.038
						ST4,2X45MM*	500	55683.042.045
ST2,9X6,5MM*	1000	55683.029.006	ST3,9X6,5MM*	1000	55683.039.006	ST4,2X50MM*	200	55683.042.050
ST2,9X9,5MM*	1000	55683.029.009	ST3,9X9,5MM*	1000	55683.039.009	ST4,2X60MM*	200	55683.042.060
ST2,9X13MM*	1000	55683.029.013	ST3,9X13MM*	1000	55683.039.013			
ST2,9X16MM*	1000	55683.029.016	ST3,9X16MM*	1000	55683.039.016	ST4,8X9,5MM*	1000	55683.048.009
ST2,9X19MM*	1000	55683.029.019	ST3,9X19MM*	1000	55683.039.019	ST4,8X13MM*	1000	55683.048.013
ST2,9X22MM*	1000	55683.029.022	ST3,9X22MM*	1000	55683.039.022	ST4,8X16MM*	1000	55683.048.016
ST2,9X25MM*	1000	55683.029.025	ST3,9X25MM*	1000	55683.039.025	ST4,8X19MM*	1000	55683.048.019
ST2,9X32MM*	1000	55683.029.032	ST3,9X32MM*	1000	55683.039.032	ST4,8X22MM*	1000	55683.048.022
			ST3,9X38MM*	500	55683.039.038	ST4,8X25MM*	500	55683.048.025
ST3,5X6,5MM*	1000	55683.035.006	ST3,9X45MM*	500	55683.039.045	ST4,8X32MM*	500	55683.048.032
ST3,5X9,5MM*	1000	55683.035.009	ST3,9X50MM*	500	55683.039.050	ST4,8X38MM*	500	55683.048.038
ST3,5X13MM*	1000	55683.035.013				ST4,8X45MM*	200	55683.048.045
ST3,5X16MM*	1000	55683.035.016	ST4,2X9,5MM*	1000	55683.042.009	ST4,8X50MM*	200	55683.048.050
ST3,5X19MM*	1000	55683.035.019	ST4,2X13MM*	1000	55683.042.013	ST4,8X60MM*	200	55683.048.060

55683 Wkręty samogwintujące z łbem stożkowym płaskim z gniazdem sześciokąrtowym								
d x L	☒	Kod artykułu	d x L	☒	Kod artykułu	d x L	☒	Kod artykułu
ST5,5X13MM*	1000	55683.055.013	ST5,5X50MM*	200	55683.055.050	ST6,3X25MM*	200	55683.063.025
ST5,5X16MM*	1000	55683.055.016	ST5,5X60MM*	200	55683.055.060	ST6,3X32MM*	200	55683.063.032
ST5,5X19MM*	1000	55683.055.019	ST5,5X70MM*	200	55683.055.070	ST6,3X38MM*	200	55683.063.038
ST5,5X22MM*	1000	55683.055.022	ST5,5X80MM*	200	55683.055.080	ST6,3X45MM*	200	55683.063.045
ST5,5X25MM*	500	55683.055.025	ST6,3X13MM*	500	55683.063.013	ST6,3X50MM*	200	55683.063.050
ST5,5X32MM*	500	55683.055.032	ST6,3X16MM*	500	55683.063.016	ST6,3X60MM*	200	55683.063.060
ST5,5X38MM*	500	55683.055.038	ST6,3X19MM*	500	55683.063.019	ST6,3X70MM*	200	55683.063.070
ST5,5X45MM*	200	55683.055.045	ST6,3X22MM*	500	55683.063.022	ST6,3X80MM*	200	55683.063.080

Wkręty samogwintujące z łbem stożkowym płaskim z gniazdem kwadratowym

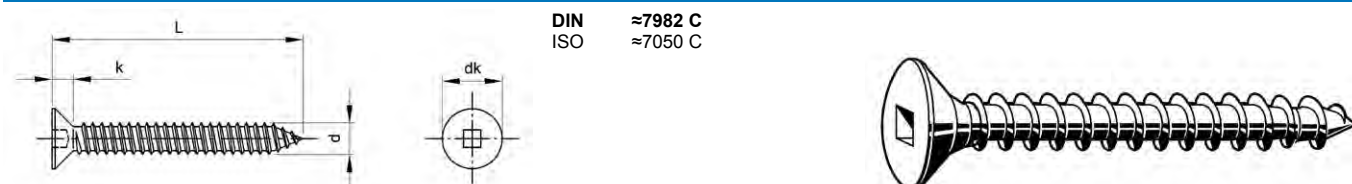

DIN ≈7982 C
ISO ≈7050 C

Informacje techniczne				
d	d _k	k ≈	Nr kwadratowy	P
ST3.9	7.5	2.3	1	1.4
ST4.2	8.1	2.5	2	1.4
ST4.8	9.5	3	2	1.6

6

51864 Wkręty samogwintujące z łbem stożkowym płaskim z gniazdem kwadratowym		R03A
Gwint	Samogwintujący	
Materiał	Stal nierdzewna A2	

d x L	☒	Kod artykułu	d x L	☒	Kod artykułu	d x L	☒	Kod artykułu
ST3,9X16MM*	200	51864.039.016	ST4,2X19MM*	200	51864.042.019	ST4,8X32MM*	200	51864.048.032
ST3,9X19MM*	200	51864.039.019	ST4,2X32MM*	200	51864.042.032	ST4,8X38MM*	200	51864.048.038
ST3,9X25MM*	200	51864.039.025	ST4,2X38MM*	200	51864.042.038	ST4,8X45MM*	200	51864.048.045
ST3,9X32MM*	200	51864.039.032	ST4,2X45MM*	200	51864.042.045	ST4,8X50MM*	200	51864.048.050
ST3,9X50MM*	200	51864.039.050	ST4,2X50MM*	200	51864.042.050	ST4,8X60MM*	200	51864.048.060
ST4,2X13MM*	200	51864.042.013	ST4,8X16MM*	200	51864.048.016	ST4,8X70MM*	200	51864.048.070
ST4,2X25MM*	200	51864.042.015	ST4,8X19MM*	200	51864.048.019	ST4,8X80MM*	200	51864.048.080
ST4,2X16MM*	200	51864.042.016	ST4,8X25MM*	200	51864.048.025	ST4,8X95MM*	200	51864.048.095

Wkręty samogwintujące z łbem soczewkowym z gniazdem krzyżowym

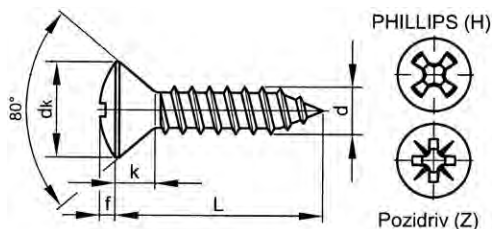

DIN 7983
ISO 7051
NF E25-657

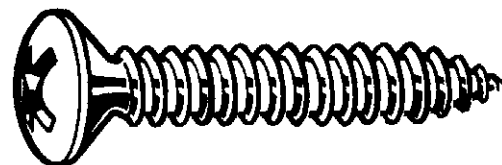

Informacje techniczne

d	d _k	f ≈	k ≈	Nr wgłębienia krzyżowego	P
ST2.2	4.3	0.7	1.3	1	0.8
ST2.9	5.5	0.9	1.7	1	1.1
ST3.5	6.8	1.2	2.1	2	1.3
ST3.9	7.5	1.3	2.3	2	1.4
ST4.2	8.1	1.4	2.5	2	1.4
ST4.8	9.5	1.5	3	2	1.6
ST5.5	10.8	1.7	3.4	3	1.8
ST6.3	12.4	2	3.8	3	1.8

Grupy katalogowe

Gwint	Gniazdo	Materiał	Obróbka powierzchni	Kod	Strona
ST	Phillips	St	Ocynk.	26700	6-94
ST	Pozidriv	St	Ocynk.	26780	6-95
ST	Phillips	St	Ocynk. czrn. pas.	26450	6-95
ST	Pozidriv	St	Ocynk. czrn. pas.	26452	6-95
ST	Phillips	St	Nikl.	26240	6-96
ST	Phillips	St.St. A2		51690	6-96
ST	Pozidriv	St.St. A2		51689	6-96
ST	Phillips	St.St. A4		55690	6-97
ST	Pozidriv	St.St. A4		55689	6-97

26700 Wkręty samogwintujące z łbem soczewkowym z gniazdem krzyżowym Phillips

J01B

Gwint Samogwintujący
Materiał Stal
Obróbka powierzchni Ocynkowane

DIN 7983 C-H
ISO 7051 C-H



d x L	☒	Kod artykułu	d x L	☒	Kod artykułu	d x L	☒	Kod artykułu
ST2,9X9,5MM	200	26700.029.009	ST3,9X22MM	200	26700.039.022	ST4,8X45MM	100	26700.048.045
ST2,9X13MM	200	26700.029.013	ST3,9X25MM	200	26700.039.025	ST4,8X50MM	100	26700.048.050
ST2,9X16MM	200	26700.029.016						
ST2,9X19MM	200	26700.029.019	ST4,2X13MM	200	26700.042.013	ST5,5X13MM	200	26700.055.013
ST2,9X22MM	200	26700.029.022	ST4,2X16MM	200	26700.042.016	ST5,5X16MM	200	26700.055.016
ST2,9X25MM	200	26700.029.025	ST4,2X19MM	200	26700.042.019	ST5,5X19MM	200	26700.055.019
			ST4,2X22MM	200	26700.042.022	ST5,5X25MM	100	26700.055.025
ST3,5X9,5MM	200	26700.035.009	ST4,2X25MM	200	26700.042.025	ST5,5X32MM	100	26700.055.032
ST3,5X13MM	200	26700.035.013	ST4,2X32MM	200	26700.042.032	ST5,5X38MM	100	26700.055.038
ST3,5X16MM	200	26700.035.016	ST4,2X38MM	200	26700.042.038	ST5,5X45MM	100	26700.055.045
ST3,5X19MM	200	26700.035.019	ST4,2X45MM	200	26700.042.045	ST5,5X50MM	100	26700.055.050
ST3,5X22MM	200	26700.035.022	ST4,2X50MM	200	26700.042.050			
ST3,5X25MM	200	26700.035.025				ST6,3X16MM	100	26700.063.016
ST3,5X32MM	200	26700.035.032	ST4,8X13MM	200	26700.048.013	ST6,3X19MM	100	26700.063.019
ST3,5X38MM	200	26700.035.038	ST4,8X16MM	200	26700.048.016	ST6,3X22MM	100	26700.063.022
			ST4,8X19MM	200	26700.048.019	ST6,3X25MM	100	26700.063.025
ST3,9X9,5MM	200	26700.039.009	ST4,8X22MM	200	26700.048.022	ST6,3X32MM	100	26700.063.032
ST3,9X13MM	200	26700.039.013	ST4,8X25MM	200	26700.048.025	ST6,3X38MM	100	26700.063.038
ST3,9X16MM	200	26700.039.016	ST4,8X32MM	100	26700.048.032	ST6,3X45MM	100	26700.063.045
ST3,9X19MM	200	26700.039.019	ST4,8X38MM	100	26700.048.038	ST6,3X50MM	100	26700.063.050

• Ostrzeżenie: cynkowanie elektrolityczne tych produktów może wywołać kruchość wodorową.

26780 Wkręty samogwintujące z łbem soczewkowym z gniazdem krzyżowym Pozidriv				J01A
Gwint	Samogwintujący	DIN	7983 C-Z	
Materiał	Stal	ISO	7051 C-Z	
Obróbka powierzchni	Ocynkowane	NF	E25-657 C	



d x L	☒	Kod artykułu	d x L	☒	Kod artykułu	d x L	☒	Kod artykułu
ST2,9X9,5MM	200	26780.029.009	ST3,9X32MM	200	26780.039.032	ST5,5X13MM	200	26780.055.013
ST2,9X13MM	200	26780.029.013	ST4,2X13MM	200	26780.042.013	ST5,5X16MM	200	26780.055.016
ST2,9X16MM	200	26780.029.016	ST4,2X16MM	200	26780.042.016	ST5,5X19MM	200	26780.055.019
ST2,9X19MM	200	26780.029.019	ST4,2X19MM	200	26780.042.019	ST5,5X25MM	100	26780.055.025
ST2,9X25MM	200	26780.029.025	ST4,2X25MM	200	26780.042.025	ST5,5X32MM	100	26780.055.032
ST3,5X9,5MM	200	26780.035.009	ST4,2X32MM	200	26780.042.032	ST5,5X38MM	100	26780.055.038
ST3,5X13MM	200	26780.035.013	ST4,2X38MM	200	26780.042.038	ST5,5X45MM	100	26780.055.045
ST3,5X16MM	200	26780.035.016	ST4,2X45MM	200	26780.042.045	ST5,5X50MM	100	26780.055.050
ST3,5X19MM	200	26780.035.019	ST4,8X13MM	200	26780.048.013	ST6,3X16MM	100	26780.063.016
ST3,5X25MM	200	26780.035.025	ST4,8X16MM	200	26780.048.016	ST6,3X19MM	100	26780.063.019
ST3,5X32MM	200	26780.035.032	ST4,8X19MM	200	26780.048.019	ST6,3X22MM	100	26780.063.022
ST3,5X38MM	200	26780.035.038	ST4,8X25MM	200	26780.048.025	ST6,3X25MM	100	26780.063.025
ST3,9X9,5MM	200	26780.039.009	ST4,8X32MM	100	26780.048.032	ST6,3X32MM	100	26780.063.032
ST3,9X13MM	200	26780.039.013	ST4,8X38MM	100	26780.048.038	ST6,3X38MM	100	26780.063.038
ST3,9X16MM	200	26780.039.016	ST4,8X45MM	100	26780.048.045	ST6,3X45MM	100	26780.063.045
ST3,9X19MM	200	26780.039.019	ST4,8X50MM	100	26780.048.050	ST6,3X50MM	100	26780.063.050
ST3,9X25MM	200	26780.039.025						

26450 Wkręty samogwintujące z łbem soczewkowym z gniazdem krzyżowym Phillips				J03B
Gwint	Samogwintujący	DIN	7983 C-H	
Materiał	Stal	ISO	7051 C-H	
Obróbka powierzchni	Ocynkowane, po czarnej pasywacji			

d x L	☒	Kod artykułu	d x L	☒	Kod artykułu	d x L	☒	Kod artykułu
ST2,9X9,5MM	200	26450.029.009	ST3,9X9,5MM	200	26450.039.009	ST4,8X16MM	200	26450.048.016
ST2,9X13MM	200	26450.029.013	ST3,9X13MM	200	26450.039.013	ST4,8X19MM	200	26450.048.019
ST2,9X16MM	200	26450.029.016	ST3,9X16MM	200	26450.039.016	ST4,8X25MM	200	26450.048.025
ST2,9X19MM	200	26450.029.019	ST3,9X19MM	200	26450.039.019	ST4,8X32MM	100	26450.048.032
ST2,9X25MM	200	26450.029.025	ST3,9X25MM	200	26450.039.025	ST4,8X38MM	100	26450.048.038
ST3,5X9,5MM	200	26450.035.009	ST4,2X13MM	200	26450.042.013	ST4,8X45MM	100	26450.048.045
ST3,5X13MM	200	26450.035.013	ST4,2X16MM	200	26450.042.016	ST4,8X50MM	100	26450.048.050
ST3,5X16MM	200	26450.035.016	ST4,2X19MM	200	26450.042.019	ST5,5X16MM	200	26450.055.016
ST3,5X19MM	200	26450.035.019	ST4,2X25MM	200	26450.042.025	ST5,5X19MM	200	26450.055.019
ST3,5X25MM	200	26450.035.025	ST4,2X32MM	200	26450.042.032	ST5,5X25MM	100	26450.055.025
ST3,5X32MM	200	26450.035.032	ST4,2X38MM	200	26450.042.038	ST5,5X32MM	100	26450.055.032
ST3,5X38MM	200	26450.035.038	ST4,8X13MM	200	26450.048.013	ST5,5X38MM	100	26450.055.038
						ST5,5X50MM	100	26450.055.050

• Ostrzeżenie: cynkowanie elektrolityczne tych produktów może wywołać kruchość wodorową.

26452 Wkręty samogwintujące z łbem soczewkowym z gniazdem krzyżowym Pozidriv				J03B
Gwint	Samogwintujący	DIN	7983 C-Z	
Materiał	Stal	ISO	7051 C-Z	
Obróbka powierzchni	Ocynkowane, po czarnej pasywacji	NF	E25-657 C	

d x L	☒	Kod artykułu	d x L	☒	Kod artykułu	d x L	☒	Kod artykułu
ST2,9X13MM	200	26452.029.013	ST3,9X19MM	200	26452.039.019	ST4,2X38MM	200	26452.042.038
ST2,9X19MM	200	26452.029.019	ST4,2X13MM	200	26452.042.013	ST4,8X16MM	200	26452.048.016
ST3,5X13MM	200	26452.035.013	ST4,2X16MM	200	26452.042.016	ST4,8X19MM	200	26452.048.019
ST3,5X16MM	200	26452.035.016	ST4,2X19MM	200	26452.042.019	ST4,8X25MM	200	26452.048.025
ST3,5X19MM	200	26452.035.019	ST4,2X25MM	200	26452.042.025	ST4,8X32MM	100	26452.048.032
ST3,5X25MM	200	26452.035.025	ST4,2X32MM	200	26452.042.032	ST4,8X38MM	100	26452.048.038

• Ostrzeżenie: cynkowanie elektrolityczne tych produktów może wywołać kruchość wodorową.

26240	Wkręty samogwintujące z łbem soczewkowym z gniazdem krzyżowym Phillips				J03B
Gwint	Samogwintujący	DIN	7983 C-H		
Materiał	Stal	ISO	7051 C-H		
Obróbka powierzchni	Niklowane				

d x L	☒	Kod artykułu	d x L	☒	Kod artykułu	d x L	☒	Kod artykułu
ST2,9X13MM	200	26240.029.013	ST4,2X19MM	200	26240.042.019	ST4,8X38MM	100	26240.048.038
ST2,9X19MM	200	26240.029.019	ST4,2X25MM	200	26240.042.025	ST4,8X50MM	100	26240.048.050
			ST4,2X32MM	200	26240.042.032			
ST3,5X13MM	200	26240.035.013	ST4,2X38MM	200	26240.042.038	ST5,5X19MM	200	26240.055.019
ST3,5X16MM	200	26240.035.016	ST4,2X45MM	200	26240.042.045	ST5,5X25MM	100	26240.055.025
ST3,5X19MM	200	26240.035.019				ST5,5X32MM	100	26240.055.032
ST3,5X25MM	200	26240.035.025	ST4,8X13MM	200	26240.048.013	ST5,5X38MM	100	26240.055.038
ST3,5X32MM	200	26240.035.032	ST4,8X16MM	200	26240.048.016			
			ST4,8X19MM	200	26240.048.019	ST6,3X25MM	100	26240.063.025
ST4,2X13MM	200	26240.042.013	ST4,8X25MM	200	26240.048.025	ST6,3X38MM	100	26240.063.038
ST4,2X16MM	200	26240.042.016	ST4,8X32MM	100	26240.048.032			

• Ostrzeżenie: cynkowanie elektrolityczne tych produktów może wywołać kruchość wodorową.

51690	Wkręty samogwintujące z łbem soczewkowym z gniazdem krzyżowym Phillips				R01A
Gwint	Samogwintujący	DIN	7983 C-H		
Materiał	Stal nierdzewna A2	ISO	7051 C-H		

d x L	☒	Kod artykułu	d x L	☒	Kod artykułu	d x L	☒	Kod artykułu
ST2,2X6,5MM*	1000	51690.022.006	ST3,9X22MM	200	51690.039.022	ST4,8X80MM	200	51690.048.080
ST2,2X9,5MM*	1000	51690.022.009	ST3,9X25MM	200	51690.039.025	ST4,8X90MM*	200	51690.048.090
ST2,2X13MM*	1000	51690.022.013	ST3,9X32MM	200	51690.039.032	ST4,8X100MM	100	51690.048.100
ST2,2X16MM*	1000	51690.022.016	ST3,9X38MM	200	51690.039.038	ST4,8X110MM*	200	51690.048.110
ST2,2X19MM*	1000	51690.022.019	ST3,9X45MM*	500	51690.039.045			
ST2,2X25MM*	1000	51690.022.025	ST3,9X50MM*	500	51690.039.050	ST5,5X13MM	200	51690.055.013
			ST3,9X60MM*	500	51690.039.060	ST5,5X16MM	200	51690.055.016
ST2,9X6,5MM	200	51690.029.006	ST3,9X70MM*	500	51690.039.070	ST5,5X19MM	200	51690.055.019
ST2,9X9,5MM	200	51690.029.009				ST5,5X22MM	200	51690.055.022
ST2,9X13MM	200	51690.029.013	ST4,2X9,5MM	200	51690.042.009	ST5,5X25MM	200	51690.055.025
ST2,9X16MM	200	51690.029.016	ST4,2X13MM	200	51690.042.013	ST5,5X32MM	100	51690.055.032
ST2,9X19MM	200	51690.029.019	ST4,2X16MM	200	51690.042.016	ST5,5X38MM	100	51690.055.038
ST2,9X22MM	200	51690.029.022	ST4,2X19MM	200	51690.042.019	ST5,5X45MM	100	51690.055.045
ST2,9X25MM	200	51690.029.025	ST4,2X22MM	200	51690.042.022	ST5,5X50MM	100	51690.055.050
ST2,9X32MM*	1000	51690.029.032	ST4,2X25MM	200	51690.042.025	ST5,5X60MM*	200	51690.055.060
			ST4,2X32MM	200	51690.042.032	ST5,5X70MM*	200	51690.055.070
ST3,5X6,5MM*	1000	51690.035.006	ST4,2X38MM	200	51690.042.038	ST5,5X80MM*	200	51690.055.080
ST3,5X9,5MM	200	51690.035.009	ST4,2X45MM	200	51690.042.045	ST5,5X90MM*	200	51690.055.090
ST3,5X13MM	200	51690.035.013	ST4,2X50MM	200	51690.042.050	ST5,5X100MM*	200	51690.055.100
ST3,5X16MM	200	51690.035.016	ST4,2X60MM	200	51690.042.060			
ST3,5X19MM	200	51690.035.019	ST4,2X70MM*	200	51690.042.070	ST6,3X13MM*	500	51690.063.013
ST3,5X22MM	200	51690.035.022				ST6,3X16MM	100	51690.063.016
ST3,5X25MM	200	51690.035.025	ST4,8X9,5MM	200	51690.048.009	ST6,3X19MM	100	51690.063.019
ST3,5X32MM	200	51690.035.032	ST4,8X13MM	200	51690.048.013	ST6,3X22MM	100	51690.063.022
ST3,5X38MM	200	51690.035.038	ST4,8X16MM	200	51690.048.016	ST6,3X25MM	100	51690.063.025
ST3,5X45MM*	500	51690.035.045	ST4,8X19MM	200	51690.048.019	ST6,3X32MM	100	51690.063.032
ST3,5X50MM*	500	51690.035.050	ST4,8X22MM	200	51690.048.022	ST6,3X38MM	100	51690.063.038
ST3,5X60MM*	500	51690.035.060	ST4,8X25MM	200	51690.048.025	ST6,3X45MM	100	51690.063.045
ST3,5X70MM*	500	51690.035.070	ST4,8X32MM	200	51690.048.032	ST6,3X50MM	100	51690.063.050
			ST4,8X38MM	200	51690.048.038	ST6,3X60MM*	200	51690.063.060
ST3,9X6,5MM*	1000	51690.039.006	ST4,8X45MM	200	51690.048.045	ST6,3X70MM*	200	51690.063.070
ST3,9X9,5MM	200	51690.039.009	ST4,8X50MM	200	51690.048.050	ST6,3X80MM*	200	51690.063.080
ST3,9X13MM	200	51690.039.013	ST4,8X60MM	200	51690.048.060	ST6,3X90MM*	200	51690.063.090
ST3,9X16MM	200	51690.039.016	ST4,8X70MM	200	51690.048.070	ST6,3X100MM*	200	51690.063.100
ST3,9X19MM	200	51690.039.019						

51689	Wkręty samogwintujące z łbem soczewkowym z gniazdem krzyżowym Pozidriv				R01A
Gwint	Samogwintujący	DIN	7983 C-Z		
Materiał	Stal nierdzewna A2	ISO	7051 C-Z		
		NF	E25-657 C		

d x L	☒	Kod artykułu	d x L	☒	Kod artykułu	d x L	☒	Kod artykułu
ST2,2X9,5MM*	1000	51689.022.009	ST2,9X9,5MM	200	51689.029.009	ST2,9X19MM	200	51689.029.019
			ST2,9X13MM	200	51689.029.013	ST2,9X22MM*	1000	51689.029.022
ST2,9X6,5MM*	1000	51689.029.006	ST2,9X16MM	200	51689.029.016	ST2,9X25MM	200	51689.029.025

51689 Wkręty samogwintujące z łbem soczewkowym z gniazdem krzyżowym Pozidriv								
d x L	☒	Kod artykułu	d x L	☒	Kod artykułu	d x L	☒	Kod artykułu
ST2,9X32MM*	1000	51689.029.032	ST4,2X16MM	200	51689.042.016	ST4,8X100MM*	200	51689.048.100
ST3,5X6,5MM*	1000	51689.035.006	ST4,2X19MM	200	51689.042.019	ST5,5X13MM*	1000	51689.055.013
ST3,5X9,5MM*	1000	51689.035.009	ST4,2X22MM*	1000	51689.042.022	ST5,5X16MM*	1000	51689.055.016
ST3,5X13MM	200	51689.035.013	ST4,2X25MM	200	51689.042.025	ST5,5X19MM*	1000	51689.055.019
ST3,5X16MM	200	51689.035.016	ST4,2X32MM	200	51689.042.032	ST5,5X22MM*	1000	51689.055.022
ST3,5X19MM	200	51689.035.019	ST4,2X38MM	200	51689.042.038	ST5,5X25MM	200	51689.055.025
ST3,5X22MM*	1000	51689.035.022	ST4,2X45MM	200	51689.042.045	ST5,5X32MM	100	51689.055.032
ST3,5X25MM	200	51689.035.025	ST4,2X50MM	200	51689.042.050	ST5,5X38MM	100	51689.055.038
ST3,5X32MM	200	51689.035.032	ST4,2X70MM*	200	51689.042.070	ST5,5X45MM	100	51689.055.045
ST3,5X38MM*	1000	51689.035.038	ST4,8X9,5MM*	1000	51689.048.009	ST5,5X50MM	100	51689.055.050
ST3,9X13MM	200	51689.039.013	ST4,8X13MM*	1000	51689.048.013	ST5,5X60MM*	200	51689.055.060
ST3,9X16MM	200	51689.039.016	ST4,8X16MM	200	51689.048.016	ST6,3X16MM	100	51689.063.016
ST3,9X19MM	200	51689.039.019	ST4,8X19MM	200	51689.048.019	ST6,3X19MM*	500	51689.063.019
ST3,9X22MM*	1000	51689.039.022	ST4,8X22MM*	1000	51689.048.022	ST6,3X22MM*	500	51689.063.022
ST3,9X25MM	200	51689.039.025	ST4,8X25MM	200	51689.048.025	ST6,3X25MM	100	51689.063.025
ST3,9X32MM	200	51689.039.032	ST4,8X32MM	200	51689.048.032	ST6,3X32MM	100	51689.063.032
ST3,9X38MM	200	51689.039.038	ST4,8X38MM	200	51689.048.038	ST6,3X38MM	100	51689.063.038
ST3,9X45MM*	500	51689.039.045	ST4,8X45MM	200	51689.048.045	ST6,3X45MM*	200	51689.063.045
ST4,2X9,5MM*	1000	51689.042.009	ST4,8X50MM	200	51689.048.050	ST6,3X50MM	100	51689.063.050
ST4,2X13MM	200	51689.042.013	ST4,8X60MM*	200	51689.048.060	ST6,3X90MM*	200	51689.063.090
			ST4,8X70MM*	200	51689.048.070			
			ST4,8X80MM*	200	51689.048.080			

55690 Wkręty samogwintujące z łbem soczewkowym z gniazdem krzyżowym Phillips					R41A
Gwint	Samogwintujący	DIN	7983 C-H		
Materiał	Stal nierdzewna A4	ISO	7051 C-H		

d x L	☒	Kod artykułu	d x L	☒	Kod artykułu	d x L	☒	Kod artykułu
ST2,2X9,5MM*	1000	55690.022.009	ST3,9X45MM*	500	55690.039.045	ST4,8X70MM*	200	55690.048.070
ST2,9X9,5MM	200	55690.029.009	ST3,9X50MM*	500	55690.039.050	ST5,5X13MM*	1000	55690.055.013
ST2,9X13MM	200	55690.029.013	ST4,2X9,5MM*	1000	55690.042.009	ST5,5X16MM*	1000	55690.055.016
ST2,9X16MM	200	55690.029.016	ST4,2X13MM	200	55690.042.013	ST5,5X19MM	200	55690.055.019
ST2,9X19MM	200	55690.029.019	ST4,2X16MM	200	55690.042.016	ST5,5X22MM*	1000	55690.055.022
ST2,9X22MM*	1000	55690.029.022	ST4,2X19MM	200	55690.042.019	ST5,5X25MM	200	55690.055.025
ST2,9X25MM*	1000	55690.029.025	ST4,2X22MM	200	55690.042.022	ST5,5X32MM*	500	55690.055.032
ST2,9X32MM*	1000	55690.029.032	ST4,2X25MM	200	55690.042.025	ST5,5X38MM	100	55690.055.038
ST3,5X9,5MM	200	55690.035.009	ST4,2X32MM	200	55690.042.032	ST5,5X45MM	100	55690.055.045
ST3,5X13MM	200	55690.035.013	ST4,2X38MM	200	55690.042.038	ST5,5X50MM	100	55690.055.050
ST3,5X16MM	200	55690.035.016	ST4,2X45MM*	500	55690.042.045	ST5,5X70MM*	200	55690.055.070
ST3,5X19MM	200	55690.035.019	ST4,2X50MM*	200	55690.042.050	ST5,5X80MM*	200	55690.055.080
ST3,5X22MM*	1000	55690.035.022	ST4,2X60MM*	200	55690.042.060	ST5,5X90MM*	200	55690.055.090
ST3,5X25MM*	1000	55690.035.025	ST4,2X70MM*	200	55690.042.070	ST6,3X16MM*	500	55690.063.016
ST3,5X32MM*	1000	55690.035.032	ST4,8X13MM*	1000	55690.048.013	ST6,3X19MM*	500	55690.063.019
ST3,5X38MM*	1000	55690.035.038	ST4,8X16MM	200	55690.048.016	ST6,3X22MM*	500	55690.063.022
ST3,9X9,5MM*	1000	55690.039.009	ST4,8X19MM	200	55690.048.019	ST6,3X25MM*	200	55690.063.025
ST3,9X13MM	200	55690.039.013	ST4,8X22MM	200	55690.048.022	ST6,3X32MM*	200	55690.063.032
ST3,9X16MM	200	55690.039.016	ST4,8X25MM	200	55690.048.025	ST6,3X38MM*	200	55690.063.038
ST3,9X19MM	200	55690.039.019	ST4,8X32MM	200	55690.048.032	ST6,3X45MM*	200	55690.063.045
ST3,9X22MM	200	55690.039.022	ST4,8X38MM	200	55690.048.038	ST6,3X50MM*	200	55690.063.050
ST3,9X25MM	200	55690.039.025	ST4,8X45MM*	200	55690.048.045	ST6,3X60MM*	200	55690.063.060
ST3,9X32MM*	1000	55690.039.032	ST4,8X50MM*	200	55690.048.050	ST6,3X70MM*	200	55690.063.070
ST3,9X38MM*	500	55690.039.038	ST4,8X60MM*	200	55690.048.060	ST6,3X80MM*	200	55690.063.080

55689 Wkręty samogwintujące z łbem soczewkowym z gniazdem krzyżowym Pozidriv					R41A
Gwint	Samogwintujący	DIN	7983 C-Z		
Materiał	Stal nierdzewna A4	ISO	7051 C-Z		
		NF	E25-657 C		

d x L	☒	Kod artykułu	d x L	☒	Kod artykułu	d x L	☒	Kod artykułu
ST2,2X9,5MM*	1000	55689.022.009	ST2,9X25MM*	1000	55689.029.025	ST3,5X22MM*	1000	55689.035.022
ST2,2X13MM*	1000	55689.022.013	ST2,9X32MM*	1000	55689.029.032	ST3,5X25MM*	1000	55689.035.025
ST2,9X6,5MM*	1000	55689.029.006	ST3,5X6,5MM*	1000	55689.035.006	ST3,5X32MM*	1000	55689.035.032
ST2,9X9,5MM*	1000	55689.029.009	ST3,5X9,5MM*	1000	55689.035.009	ST3,5X38MM*	1000	55689.035.038
ST2,9X13MM*	1000	55689.029.013	ST3,5X13MM*	1000	55689.035.013	ST3,9X9,5MM*	1000	55689.039.000
ST2,9X16MM*	1000	55689.029.016	ST3,5X16MM*	1000	55689.035.016	ST3,9X13MM*	1000	55689.039.013
ST2,9X19MM*	1000	55689.029.019	ST3,5X19MM*	1000	55689.035.019	ST3,9X16MM*	1000	55689.039.016

55689 Wkręty samogwintujące z łbem soczewkowym z gniazdem krzyżowym Pozidriv								
d x L	☒	Kod artykułu	d x L	☒	Kod artykułu	d x L	☒	Kod artykułu
ST3,9X19MM*	1000	55689.039.019	ST4,8X13MM*	1000	55689.048.013	ST5,5X45MM*	200	55689.055.045
ST3,9X22MM*	1000	55689.039.022	ST4,8X16MM*	1000	55689.048.016	ST5,5X50MM*	200	55689.055.050
ST3,9X25MM*	1000	55689.039.025	ST4,8X19MM*	1000	55689.048.019	ST5,5X60MM*	200	55689.055.060
ST3,9X32MM*	1000	55689.039.032	ST4,8X22MM*	1000	55689.048.022	ST5,5X70MM*	200	55689.055.070
ST3,9X38MM*	500	55689.039.038	ST4,8X25MM*	500	55689.048.025	ST5,5X80MM*	200	55689.055.080
ST4,2X9,5MM*	1000	55689.042.009	ST4,8X32MM*	500	55689.048.032	ST6,3X16MM*	500	55689.063.016
ST4,2X13MM*	1000	55689.042.013	ST4,8X38MM*	500	55689.048.038	ST6,3X19MM*	500	55689.063.019
ST4,2X16MM*	1000	55689.042.016	ST4,8X45MM*	200	55689.048.045	ST6,3X25MM*	200	55689.063.025
ST4,2X19MM*	1000	55689.042.019	ST4,8X50MM*	200	55689.048.050	ST6,3X32MM*	200	55689.063.032
ST4,2X22MM*	1000	55689.042.022	ST4,8X60MM*	200	55689.048.060	ST6,3X38MM*	200	55689.063.038
ST4,2X25MM*	1000	55689.042.025	ST4,8X70MM*	200	55689.048.070	ST6,3X45MM*	200	55689.063.045
ST4,2X32MM*	500	55689.042.032	ST5,5X13MM*	1000	55689.055.013	ST6,3X50MM*	200	55689.063.050
ST4,2X38MM*	500	55689.042.038	ST5,5X16MM*	1000	55689.055.016	ST6,3X60MM*	200	55689.063.060
ST4,2X45MM*	500	55689.042.045	ST5,5X19MM*	1000	55689.055.019	ST6,3X70MM*	200	55689.063.070
ST4,2X50MM*	200	55689.042.050	ST5,5X22MM*	1000	55689.055.022	ST6,3X80MM*	200	55689.063.080
ST4,2X60MM*	200	55689.042.060	ST5,5X25MM*	500	55689.055.025	ST6,3X100MM*	200	55689.063.100
ST4,8X9MM*	1000	55689.048.009	ST5,5X32MM*	500	55689.055.032			
			ST5,5X38MM*	500	55689.055.038			

Wkręty samogwintujące z łbem sześciokątnym

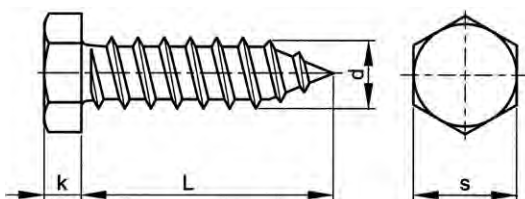

DIN 7976
ISO 1479
ASME B18.6.5M
NF E25-662
BS 4174

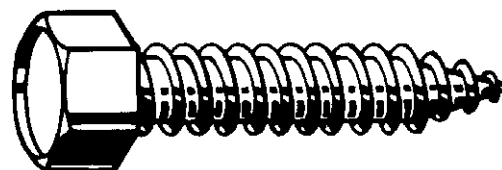

6

Informacje techniczne

d	k	P	s	d	k	P	s
ST2.9	1.5	1.1	5	ST4.8	3	1.6	8
ST3.5	2.3	1.3	5.5	ST5.5	4	1.8	8
ST3.9	2.3	1.3	7	ST6.3	4.8	1.8	10
ST4.2	2.8	1.4	7	ST8	5.8	2.1	13

Grupy katalogowe

Gwint	Gniazdo	Materiał	Obróbka powierzchni	Kod	Strona
ST	Sześciokąt	St	Ocyнк.	26080	6-98
ST	Sześciokąt	St	Ocyнк.	bez zaostżenia	26180 6-99
ST	Sześciokąt	St.St. A2		51650	6-99

26080 Wkręty samogwintujące z łbem sześciokątnym				J04A
Gwint	Samogwintujący	DIN	7976 C	
Materiał	Stal	ISO	1479 C	
Obróbka powierzchni	Ocyńkowane	NF	E25-662 C	

d x L	☒	Kod artykułu	d x L	☒	Kod artykułu	d x L	☒	Kod artykułu
ST4,2X25MM	1000	26080.042.025	ST4,8X50MM	200	26080.048.050	ST6,3X19MM	100	26080.063.019
ST4,8X9,5MM	200	26080.048.009	ST5,5X16MM	250	26080.055.016	ST6,3X25MM	100	26080.063.025
ST4,8X13MM	250	26080.048.013	ST6,3X13MM	100	26080.063.013	ST6,3X32MM	100	26080.063.032
ST4,8X16MM	1000	26080.048.016	ST6,3X16MM	100	26080.063.016	ST6,3X38MM	100	26080.063.038
ST4,8X25MM	100	26080.048.025				ST6,3X45MM	100	26080.063.045
ST4,8X38MM	200	26080.048.038				ST6,3X50MM	100	26080.063.050

• Ostrzeżenie: cynkowanie elektrolityczne tych produktów może wywołać kruchość wodorową.

26180 Wkręty samogwintujące z łbem sześciokątnym, koniec płaski				J04A	
Gwint	Samogwintujący	DIN	7976 F		
Materiał	Stal	ISO	1479 F		
Obróbka powierzchni	Ocynkowane	NF	E25-662 F		

d x L	☒	Kod artykułu	d x L	☒	Kod artykułu	d x L	☒	Kod artykułu
ST4,8X9,5MM	200	26180.048.009						
ST4,8X13MM	200	26180.048.013	ST6,3X13MM	100	26180.063.013	ST8(7,9)X16MM	100	26180.079.016
ST4,8X16MM	200	26180.048.016	ST6,3X16MM	100	26180.063.016	ST8(7,9)X19MM	100	26180.079.019
ST4,8X19MM	200	26180.048.019	ST6,3X19MM	100	26180.063.019	ST8(7,9)X25MM	100	26180.079.025
ST4,8X25MM	200	26180.048.025	ST6,3X25MM	100	26180.063.025			

• Ostrzeżenie: cynkowanie elektrolityczne tych produktów może wywołać kruchość wodorową.

51650 Wkręty samogwintujące z łbem sześciokątnym				R01A	
Gwint	Samogwintujący	DIN	7976 C		
Materiał	Stal nierdzewna A2	ISO	1479 C		
		NF	E25-662 C		

d x L	☒	Kod artykułu	d x L	☒	Kod artykułu	d x L	☒	Kod artykułu
ST2,9X9,5MM*	1000	51650.029.009	ST4,2X38MM*	500	51650.042.038	ST5,5X80MM*	200	51650.055.080
ST2,9X13MM*	1000	51650.029.013	ST4,2X45MM*	500	51650.042.045	ST5,5X90MM*	200	51650.055.090
ST2,9X16MM*	1000	51650.029.016	ST4,2X50MM*	200	51650.042.050			
ST2,9X19MM*	1000	51650.029.019	ST4,2X70MM*	200	51650.042.070	ST6,3X13MM	100	51650.063.013
						ST6,3X16MM	100	51650.063.016
ST3,5X13MM*	1000	51650.035.013	ST4,8X9,5MM*	1000	51650.048.009	ST6,3X19MM	100	51650.063.019
ST3,5X16MM*	1000	51650.035.016	ST4,8X13MM	100	51650.048.013	ST6,3X22MM	100	51650.063.022
ST3,5X19MM*	1000	51650.035.019	ST4,8X16MM	100	51650.048.016	ST6,3X25MM	100	51650.063.025
ST3,5X22MM*	1000	51650.035.022	ST4,8X19MM	100	51650.048.019	ST6,3X32MM*	500	51650.063.032
ST3,5X25MM*	1000	51650.035.025	ST4,8X22MM*	1000	51650.048.022	ST6,3X38MM*	200	51650.063.038
ST3,5X32MM*	1000	51650.035.032	ST4,8X25MM	100	51650.048.025	ST6,3X45MM*	200	51650.063.045
			ST4,8X32MM	500	51650.048.032	ST6,3X50MM	200	51650.063.050
ST3,9X9,5MM*	1000	51650.039.009	ST4,8X38MM*	500	51650.048.038	ST6,3X60MM*	200	51650.063.060
ST3,9X13MM*	1000	51650.039.013	ST4,8X45MM*	200	51650.048.045	ST6,3X70MM*	200	51650.063.070
ST3,9X16MM*	1000	51650.039.016	ST4,8X50MM*	200	51650.048.050	ST6,3X80MM*	200	51650.063.080
ST3,9X19MM*	1000	51650.039.019	ST4,8X60MM*	200	51650.048.060	ST6,3X90MM*	200	51650.063.090
ST3,9X22MM*	1000	51650.039.022	ST4,8X70MM*	200	51650.048.070	ST6,3X100MM*	200	51650.063.100
ST3,9X25MM*	1000	51650.039.025	ST4,8X80MM*	200	51650.048.080	ST6,3X120MM*	200	51650.063.120
ST3,9X32MM*	1000	51650.039.032						
ST3,9X38MM*	500	51650.039.038	ST5,5X13MM*	1000	51650.055.013	ST8,0X16MM*	200	51650.080.016
ST3,9X45MM*	500	51650.039.045	ST5,5X16MM*	1000	51650.055.016	ST8,0X19MM*	200	51650.080.019
ST3,9X50MM*	500	51650.039.050	ST5,5X19MM*	1000	51650.055.019	ST8,0X22MM*	200	51650.080.022
			ST5,5X22MM*	1000	51650.055.022	ST8,0X25MM*	200	51650.080.025
ST4,2X9,5MM*	1000	51650.042.009	ST5,5X25MM*	500	51650.055.025	ST8,0X32MM*	200	51650.080.032
ST4,2X13MM	100	51650.042.013	ST5,5X32MM*	500	51650.055.032	ST8,0X38MM	200	51650.080.038
ST4,2X16MM	100	51650.042.016	ST5,5X38MM*	500	51650.055.038	ST8,0X45MM*	200	51650.080.045
ST4,2X19MM*	1000	51650.042.019	ST5,5X45MM*	200	51650.055.045	ST8,0X50MM*	200	51650.080.050
ST4,2X22MM	100	51650.042.022	ST5,5X50MM*	200	51650.055.050	ST8,0X60MM*	200	51650.080.060
ST4,2X25MM*	1000	51650.042.025	ST5,5X60MM*	200	51650.055.060	ST8,0X70MM*	200	51650.080.070
ST4,2X32MM*	500	51650.042.032	ST5,5X70MM*	200	51650.055.070			

Wkręty samogwintujące z łbem sześciokątnym z kołnierzem

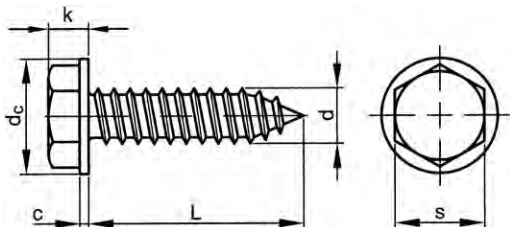

DIN ≈6928 C
ISO ≈7053 C
BS ≈7599

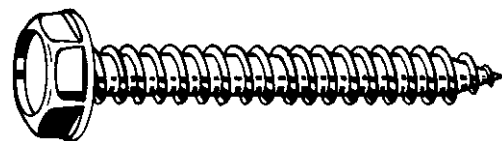

Informacje techniczne

d	c	dc	k	P	s
ST3.5	0.5	7.2	2.5	1.3	5.5
ST4.2	0.6	9	2.8	1.4	7
ST4.8	0.7	10	3.1	1.6	8

28100 Wkręty samogwintujące z łbem sześciokątnym z kołnierzem

J04A

Gwint Samogwintujący
Materiał Stal
Obróbka powierzchni Ocynkowane



d x L	☒	Kod artykułu	d x L	☒	Kod artykułu	d x L	☒	Kod artykułu
ST3,5X9,5MM	200	28100.035.009	ST4,2X13MM	200	28100.042.013	ST4,8X16MM	200	28100.048.016
ST3,5X13MM	200	28100.035.013	ST4,2X16MM	200	28100.042.016	ST4,8X19MM	200	28100.048.019
ST3,5X16MM	200	28100.035.016	ST4,2X19MM	200	28100.042.019	ST4,8X25MM	200	28100.048.025
ST3,5X19MM	200	28100.035.019	ST4,2X25MM	200	28100.042.025	ST4,8X32MM	200	28100.048.032
ST4,2X9,5MM	200	28100.042.009	ST4,8X13MM	200	28100.048.013			

- Ostrzeżenie: cynkowanie elektrolityczne tych produktów może wywołać kruchość wodorową.

Wkręty samogwintujące z łbem sześciokątnym ze stożkową końcówką i podkładką

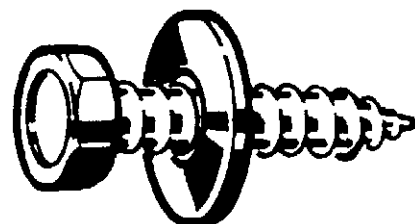
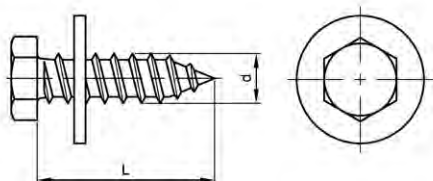

Informacje techniczne

d	ø podkładki
ST4.8	12x1.6
ST5.6	14.8x1.6
ST6.5	18x1.6

72045 Wkręty samogwintujące z łbem sześciokątnym ze stożkową końcówką i podkładką

Y92D

Gwint Samogwintujący
Materiał Stal
Obróbka powierzchni Ocynkowane



d x L	☒	Kod artykułu	d x L	☒	Kod artykułu	d x L	☒	Kod artykułu
ST4,8X16MM	200	72045.048.016	ST5,6X13MM	200	72045.056.013	ST6,5X20MM	200	72045.065.020
ST4,8X19MM	200	72045.048.019	ST5,6X16MM	200	72045.056.016	ST6,5X25MM	200	72045.065.025
			ST5,6X19MM	200	72045.056.019			

Wkręty samogwintujące z gniazdem imbusowym stal nierdzewna

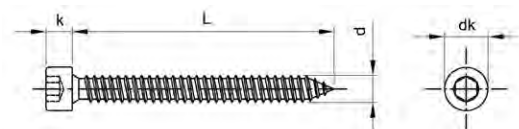

Informacje techniczne

d	d _k	k	s
4.8	8.5	5	4
5.5	10	6	5
6.3	10	6	5

Grupy katalogowe

Gwint	Gniazdo	Materiał	Kod	Strona
ST	Sześciokąt	St.St. A2	51651	6-101
ST	Sześciokąt	St.St. A4	55651	6-101

51651 Wkręty samogwintujące z gniazdem imbusowym stal A2

Q05A

Gwint Samogwintujący
Materiał Stal nierdzewna A2



d x L	☒	Kod artykułu	d x L	☒	Kod artykułu	d x L	☒	Kod artykułu
4,8X9,5MM*	500	51651.048.009	5,5X13MM*	500	51651.055.013	6,3X13MM*	200	51651.063.013
4,8X13MM*	500	51651.048.013	5,5X16MM*	500	51651.055.016	6,3X16MM*	500	51651.063.016
4,8X16MM*	500	51651.048.016	5,5X19MM*	500	51651.055.019	6,3X19MM*	500	51651.063.019
4,8X19MM*	500	51651.048.019	5,5X22MM*	500	51651.055.022	6,3X22MM*	500	51651.063.022
4,8X22MM*	500	51651.048.022	5,5X25MM*	500	51651.055.025	6,3X25MM*	500	51651.063.025
4,8X25MM*	500	51651.048.025	5,5X30MM*	500	51651.055.030	6,3X30MM*	500	51651.063.030
4,8X30MM*	500	51651.048.030	5,5X32MM*	500	51651.055.032	6,3X32MM*	500	51651.063.032
4,8X32MM*	500	51651.048.032	5,5X35MM*	500	51651.055.035	6,3X38MM*	500	51651.063.038
4,8X35MM*	500	51651.048.035	5,5X38MM*	500	51651.055.038	6,3X42MM*	500	51651.063.042
4,8X38MM*	500	51651.048.038	5,5X40MM*	500	51651.055.040	6,3X45MM*	500	51651.063.045
4,8X40MM*	500	51651.048.040	5,5X42MM*	500	51651.055.042	6,3X50MM*	200	51651.063.050
4,8X42MM*	500	51651.048.042	5,5X45MM*	500	51651.055.045	6,3X55MM*	200	51651.063.055
4,8X45MM*	500	51651.048.045	5,5X50MM*	200	51651.055.050	6,3X60MM*	200	51651.063.060
4,8X50MM*	200	51651.048.050	5,5X55MM*	200	51651.055.055	6,3X65MM*	200	51651.063.065
4,8X55MM*	200	51651.048.055	5,5X60MM*	200	51651.055.060	6,3X70MM*	200	51651.063.070
4,8X60MM*	200	51651.048.060	5,5X65MM*	200	51651.055.065	6,3X75MM*	200	51651.063.075
4,8X70MM*	200	51651.048.070	5,5X70MM*	200	51651.055.070	6,3X80MM*	200	51651.063.080
4,8X80MM*	200	51651.048.080	5,5X75MM*	200	51651.055.075	6,3X90MM*	200	51651.063.090
4,8X90MM*	200	51651.048.090	5,5X80MM*	200	51651.055.080	6,3X100MM*	200	51651.063.100
4,8X100MM*	200	51651.048.100	5,5X90MM*	200	51651.055.090			
			5,5X100MM*	200	51651.055.100			

55651 Wkręty samogwintujące z gniazdem imbusowym stal A4

Q45A

Gwint Samogwintujący
Materiał Stal nierdzewna A4



d x L	☒	Kod artykułu	d x L	☒	Kod artykułu	d x L	☒	Kod artykułu
4,8X13MM*	500	55651.048.013	5,5X19MM*	500	55651.055.019	5,5X75MM*	200	55651.055.075
4,8X16MM*	500	55651.048.016	5,5X22MM*	500	55651.055.022	5,5X90MM*	200	55651.055.090
4,8X19MM*	500	55651.048.019	5,5X25MM*	500	55651.055.025	6,3X13MM*	500	55651.063.013
4,8X22MM*	500	55651.048.022	5,5X30MM*	500	55651.055.030	6,3X16MM*	500	55651.063.016
4,8X25MM*	500	55651.048.025	5,5X32MM*	500	55651.055.032	6,3X19MM*	500	55651.063.019
4,8X32MM*	500	55651.048.032	5,5X38MM*	500	55651.055.038	6,3X25MM*	500	55651.063.025
4,8X38MM*	500	55651.048.038	5,5X42MM*	500	55651.055.042	6,3X32MM*	500	55651.063.032
4,8X45MM*	500	55651.048.045	5,5X45MM*	500	55651.055.045	6,3X35MM*	500	55651.063.035
4,8X70MM*	200	55651.048.070	5,5X50MM*	200	55651.055.050	6,3X45MM*	500	55651.063.045
4,8X100MM*	200	55651.048.100	5,5X55MM*	200	55651.055.055	6,3X50MM*	200	55651.063.050
			5,5X60MM*	200	55651.055.060	6,3X55MM*	200	55651.063.055
5,5X16MM*	500	55651.055.016	5,5X70MM*	200	55651.055.070	6,3X60MM*	200	55651.063.060

Łeb stożkowo-wypukły z gniazdem torx

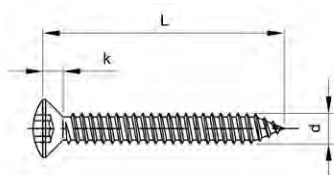

ISO 14587 C
DIN ≈7983 C



Informacje techniczne

d	d _k	k	Nasadka
2.2 (#ISO)	4.3	1.3	T6
2.9	5.5	1.7	T8
3.5	6.8	2.1	T10
3.9 (#ISO)	7.5	2.3	T15
4.2	8.1	2.5	T20
4.8	9.5	3	T25
5.5	10.8	3.4	T25
6.3	12.4	3.8	T30

Grupy katalogowe

Gwint	Gniazdo	Materiał	Kod	Strona
ST	Sześciokarbowy	St.St. A2	51693	6-102
ST	Sześciokarbowy	St.St. A4	55693	6-103

6

51693 Wkręty samogwintujące z łebem stożkowym soczewkowym z gniazdem sześciokarbowym ze stali A2 R03A

Gwint Samogwintujący
Materiał Stal nierdzewna A2



d x L	☒	Kod artykułu	d x L	☒	Kod artykułu	d x L	☒	Kod artykułu
2,2X6,5MM*	1000	51693.022.006	3,9X13MM*	1000	51693.039.013	4,8X60MM*	200	51693.048.060
2,2X9,5MM*	1000	51693.022.009	3,9X16MM*	1000	51693.039.016	4,8X70MM*	200	51693.048.070
2,2X13MM*	1000	51693.022.013	3,9X19MM*	1000	51693.039.019	4,8X80MM*	200	51693.048.080
2,2X16MM*	1000	51693.022.016	3,9X22MM*	1000	51693.039.022			
2,2X19MM*	1000	51693.022.019	3,9X25MM*	1000	51693.039.025	5,5X13MM*	1000	51693.055.013
2,2X22MM*	1000	51693.022.022	3,9X32MM*	1000	51693.039.032	5,5X16MM*	1000	51693.055.016
2,2X25MM*	1000	51693.022.025	3,9X38MM*	500	51693.039.038	5,5X19MM*	1000	51693.055.019
			3,9X45MM*	500	51693.039.045	5,5X22MM*	1000	51693.055.022
2,9X6,5MM*	1000	51693.029.006	3,9X50MM*	500	51693.039.050	5,5X25MM*	500	51693.055.025
2,9X9,5MM*	1000	51693.029.009				5,5X32MM*	500	51693.055.032
2,9X13MM*	1000	51693.029.013	4,2X9,5MM*	1000	51693.042.009	5,5X38MM*	500	51693.055.038
2,9X16MM*	1000	51693.029.016	4,2X13MM*	1000	51693.042.013	5,5X45MM*	200	51693.055.045
2,9X19MM*	1000	51693.029.019	4,2X16MM*	1000	51693.042.016	5,5X60MM*	200	51693.055.060
2,9X22MM*	1000	51693.029.022	4,2X19MM*	1000	51693.042.019	5,5X70MM*	200	51693.055.070
2,9X25MM*	1000	51693.029.025	4,2X22MM*	1000	51693.042.022	5,5X80MM*	200	51693.055.080
2,9X32MM*	1000	51693.029.032	4,2X25MM*	1000	51693.042.025	5,5X50MM*	200	51693.055.950
			4,2X32MM*	500	51693.042.032			
3,5X6,5MM*	1000	51693.035.006	4,2X38MM*	500	51693.042.038	6,3X13MM*	500	51693.063.013
3,5X9,5MM*	1000	51693.035.009	4,2X45MM*	500	51693.042.045	6,3X16MM*	500	51693.063.016
3,5X13MM*	1000	51693.035.013	4,2X50MM*	200	51693.042.050	6,3X19MM*	500	51693.063.019
3,5X16MM*	1000	51693.035.016				6,3X22MM*	500	51693.063.022
3,5X19MM*	1000	51693.035.019	4,8X9MM*	1000	51693.048.009	6,3X25MM*	200	51693.063.025
3,5X22MM*	1000	51693.035.022	4,8X13MM*	1000	51693.048.013	6,3X32MM*	200	51693.063.032
3,5X25MM*	1000	51693.035.025	4,8X16MM*	1000	51693.048.016	6,3X38MM*	200	51693.063.038
3,5X32MM*	1000	51693.035.032	4,8X19MM*	1000	51693.048.019	6,3X45MM*	200	51693.063.045
3,5X38MM*	1000	51693.035.038	4,8X22MM*	1000	51693.048.022	6,3X50MM*	200	51693.063.050
3,5X45MM*	500	51693.035.045	4,8X25MM*	500	51693.048.025	6,3X60MM*	200	51693.063.060
3,5X50MM*	500	51693.035.050	4,8X32MM*	500	51693.048.032	6,3X70MM*	200	51693.063.070
			4,8X38MM*	500	51693.048.038	6,3X80MM*	200	51693.063.080
3,9X6,5MM*	1000	51693.039.006	4,8X45MM*	200	51693.048.045			
3,9X9,5MM*	1000	51693.039.009	4,8X50MM*	200	51693.048.050			

55693	Wkręty samogwintujące z łbem stożkowym soczewkowym z gniazdem sześciokorbym ze stali A4		R43A
Gwint	Samogwintujący		
Materiał	Stal nierdzewna A4		

d x L	☒	Kod artykułu	d x L	☒	Kod artykułu	d x L	☒	Kod artykułu
2,2X16MM*	1000	55693.022.016	4,2X9,5MM*	1000	55693.042.009	4,8X80MM*	200	55693.048.080
2,9X13MM*	1000	55693.029.013	4,2X13MM*	1000	55693.042.013	5,5X13MM*	1000	55693.055.013
2,9X16MM*	1000	55693.029.016	4,2X16MM*	1000	55693.042.016	5,5X16MM*	1000	55693.055.016
2,9X19MM*	1000	55693.029.019	4,2X19MM*	1000	55693.042.019	5,5X19MM*	1000	55693.055.019
2,9X25MM*	1000	55693.029.025	4,2X22MM*	1000	55693.042.022	5,5X22MM*	1000	55693.055.022
3,5X32MM*	1000	55693.029.032	4,2X25MM*	1000	55693.042.025	5,5X25MM*	500	55693.055.025
3,5X6,5MM*	1000	55693.035.006	4,2X32MM*	500	55693.042.032	5,5X32MM*	500	55693.055.032
3,5X13MM*	1000	55693.035.013	4,2X38MM*	500	55693.042.038	5,5X38MM*	500	55693.055.038
3,5X16MM*	1000	55693.035.016	4,2X45MM*	500	55693.042.045	5,5X45MM*	200	55693.055.045
3,5X19MM*	1000	55693.035.019	4,2X50MM*	200	55693.042.050	5,5X50MM*	200	55693.055.050
3,5X22MM*	1000	55693.035.022	4,2X60MM*	200	55693.042.060	5,5X60MM*	200	55693.055.060
3,5X25MM*	1000	55693.035.025	4,8X13MM*	1000	55693.048.013	5,5X70MM*	200	55693.055.070
3,5X32MM*	1000	55693.035.032	4,8X16MM*	1000	55693.048.016	5,5X80MM*	200	55693.055.080
3,5X38MM*	1000	55693.035.038	4,8X19MM*	1000	55693.048.019	6,3X19MM*	500	55693.063.019
3,5X45MM*	500	55693.035.045	4,8X22MM*	1000	55693.048.022	6,3X25MM*	200	55693.063.025
3,9X16MM*	1000	55693.039.016	4,8X25MM*	500	55693.048.025	6,3X32MM*	200	55693.063.032
3,9X19MM*	1000	55693.039.019	4,8X32MM*	500	55693.048.032	6,3X38MM*	200	55693.063.038
3,9X22MM*	1000	55693.039.022	4,8X38MM*	500	55693.048.038	6,3X50MM*	200	55693.063.050
3,9X32MM*	1000	55693.039.032	4,8X45MM*	200	55693.048.045	6,3X60MM*	200	55693.063.060
3,9X38MM*	500	55693.039.038	4,8X50MM*	200	55693.048.050	6,3X70MM*	200	55693.063.070
3,9X50MM*	500	55693.039.050	4,8X60MM*	200	55693.048.060	6,3X80MM*	200	55693.063.080
			4,8X70MM*	200	55693.048.070			

6

Wkręty samogwintujące z łbem grzybkowym z gniazdem krzyżowym

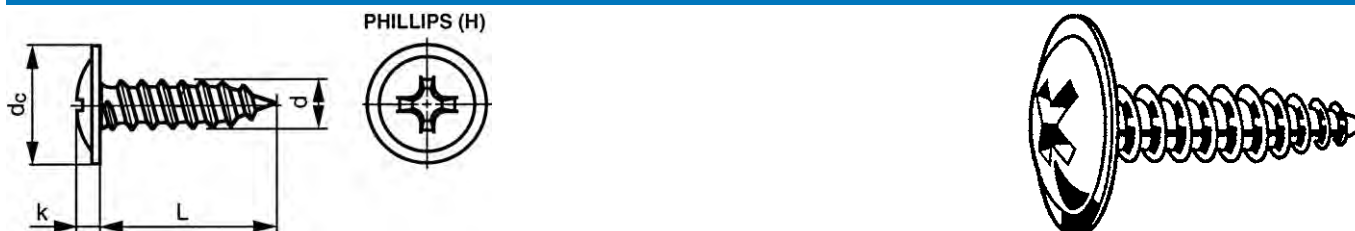

Informacje techniczne				
d	d _c (maks.)	k	Nr wgłębienia krzyżowego	P
ST3.5	9	2.3	2	1.3
ST3.9	10	2.5	2	1.4
ST4.2	10	2.6	2	1.4
ST4.8	11.5	2.7	2	1.6

26456	Wkręty samogwintujące z łbem grzybkowym z gniazdem krzyżowym Phillips		J03A
Gwint	Samogwintujący		
Materiał	Stal		
Obróbka powierzchni	Ocynkowane, po czarnej pasywacji		

d x L	☒	Kod artykułu	d x L	☒	Kod artykułu	d x L	☒	Kod artykułu
ST3,5X16MM	100	26456.035.016	ST3,9X25MM	100	26456.039.025	ST4,2X25MM	100	26456.042.025
ST3,9X9,5MM	100	26456.039.009	ST4,2X13MM	100	26456.042.013	ST4,8X13MM	100	26456.048.013
ST3,9X13MM	100	26456.039.013	ST4,2X16MM	100	26456.042.016	ST4,8X16MM	100	26456.048.016
ST3,9X16MM	100	26456.039.016	ST4,2X19MM	100	26456.042.019	ST4,8X19MM	100	26456.048.019
ST3,9X19MM	100	26456.039.019	ST4,2X22MM	100	26456.042.022	ST4,8X25MM	100	26456.048.025

Wkręty do okien ze stali nierdzewnej z gniazdem Pozidriv i podkładką

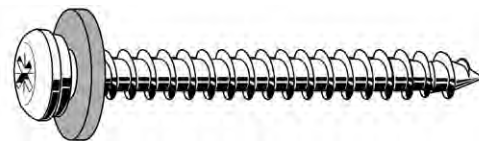
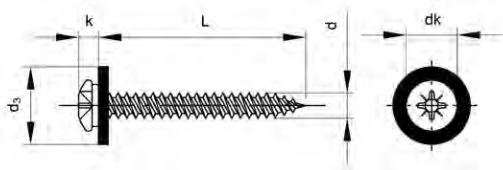

Informacje techniczne

d	d ₃	d _k	k	Nr wgłębienia krzyżowego
3.9	12	7.9	3.1	2

Grupy katalogowe

Gwint	Gniazdo	Materiał	Kolor	Kod	Strona
ST	Pozidriv	St.St. A2	Naturalny	51760	6-104
ST	Pozidriv	St.St. A2	Biały	51764	6-104
ST	Pozidriv	St.St. A2	Brązowy	51767	6-104

51760 Wkręty do okien ze stali nierdzewnej z gniazdem Pozidriv i podkładką w kolorze naturalnym

R03A

Gwint Samogwintujący
Materiał Stal nierdzewna A2
Kolor Naturalny



d x L	☒	Kod artykułu	d x L	☒	Kod artykułu	d x L	☒	Kod artykułu
ST3,9X16MM*	1000	51760.039.016	ST3,9X22MM*	1000	51760.039.022	ST3,9X32MM*	1000	51760.039.032
ST3,9X19MM*	1000	51760.039.019	ST3,9X25MM*	1000	51760.039.025			

51764 Wkręty do okien ze stali nierdzewnej z gniazdem Pozidriv i podkładką w kolorze białym

R03A

Gwint Samogwintujący
Materiał Stal nierdzewna A2
Kolor Biały



d x L	☒	Kod artykułu	d x L	☒	Kod artykułu	d x L	☒	Kod artykułu
ST3,9X16MM*	1000	51764.039.016	ST3,9X22MM*	1000	51764.039.022	ST3,9X32MM*	1000	51764.039.032
ST3,9X19MM*	1000	51764.039.019	ST3,9X25MM*	1000	51764.039.025			

51767 Wkręty do okien ze stali nierdzewnej z gniazdem Pozidriv i podkładką w kolorze brązowym

R03A

Gwint Samogwintujący
Materiał Stal nierdzewna A2
Kolor Brązowy



d x L	☒	Kod artykułu	d x L	☒	Kod artykułu	d x L	☒	Kod artykułu
ST3,9X16MM*	1000	51767.039.016	ST3,9X22MM*	1000	51767.039.022	ST3,9X32MM*	1000	51767.039.032
ST3,9X19MM*	1000	51767.039.019	ST3,9X25MM*	1000	51767.039.025			

Wkręty do okien ze stali nierdzewnej z gniazdem sześciokątnym i podkładką

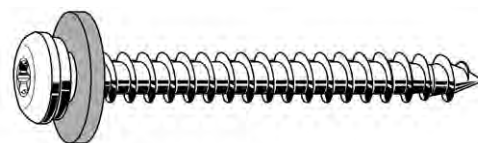
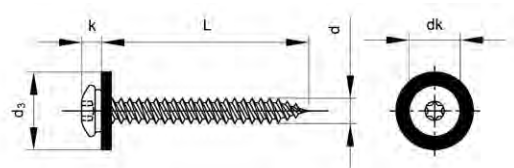

Informacje techniczne

d	d _s	d _k	k	Nasadka
3.9	12	7.9	3.1	T15

Grupy katalogowe

Gwint	Gniazdo	Materiał	Kolor	Kod	Strona
ST	Sześciokątny	St.St. A2	Naturalny	51761	6-105
ST	Sześciokątny	St.St. A2	Biały	51765	6-105
ST	Sześciokątny	St.St. A2	Brązowy	51768	6-105

51761 Wkręty do okien ze stali nierdzewnej z gniazdem sześciokątnym i podkładką w kolorze naturalnym

R03A

Gwint Samogwintujący
Materiał Stal nierdzewna A2
Kolor Naturalny



d x L	☒	Kod artykułu	d x L	☒	Kod artykułu	d x L	☒	Kod artykułu
ST3,9X16MM*	200	51761.039.016	ST3,9X22MM*	200	51761.039.022	ST3,9X32MM*	200	51761.039.032
ST3,9X19MM*	200	51761.039.019	ST3,9X25MM*	200	51761.039.025			

51765 Wkręty do okien ze stali nierdzewnej z gniazdem sześciokątnym i podkładką w kolorze białym

R03A

Gwint Samogwintujący
Materiał Stal nierdzewna A2
Kolor Biały



d x L	☒	Kod artykułu	d x L	☒	Kod artykułu	d x L	☒	Kod artykułu
ST3,9X16MM*	200	51765.039.016	ST3,9X22MM*	200	51765.039.022	ST3,9X32MM*	200	51765.039.032
ST3,9X19MM*	200	51765.039.019	ST3,9X25MM*	200	51765.039.025			

51768 Wkręty do okien ze stali nierdzewnej z gniazdem sześciokątnym i podkładką w kolorze brązowym

R03A

Gwint Samogwintujący
Materiał Stal nierdzewna A2
Kolor Brązowy



d x L	☒	Kod artykułu	d x L	☒	Kod artykułu	d x L	☒	Kod artykułu
ST3,9X16MM*	200	51768.039.016	ST3,9X22MM*	200	51768.039.022	ST3,9X32MM*	200	51768.039.032
ST3,9X19MM*	200	51768.039.019	ST3,9X25MM*	200	51768.039.025			

Wkręty do okien ze stali nierdzewnej z gniazdem sześciokątnym i podkładką

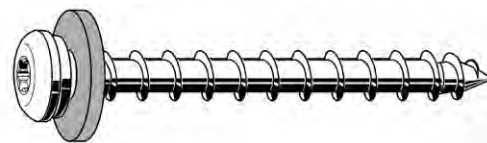
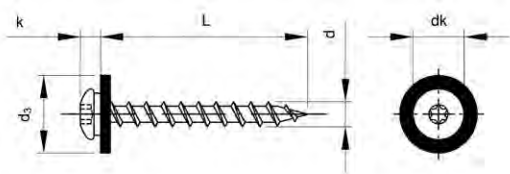

Informacje techniczne

d	d ₃	d _k	k	Nasadka
3.9	12	7.9	3.1	T15

Grupy katalogowe

Gwint	Gniazdo	Materiał	Kolor	Kod	Strona
CT	Sześciokątny	St.St. A2	Naturalny	51762	6-106
CT	Sześciokątny	St.St. A2	Biały	51766	6-106
CT	Sześciokątny	St.St. A2	Brązowy	51769	6-106

51762 Wkręty do okien ze stali nierdzewnej z gniazdem sześciokątnym i podkładką w kolorze naturalnym R03A

Gwint Gwint grubożwojny
Materiał Stal nierdzewna A2
Kolor Naturalny



d x L	☒	Kod artykułu	d x L	☒	Kod artykułu	d x L	☒	Kod artykułu
ST3,9X16MM*	200	51762.039.016	ST3,9X22MM*	200	51762.039.022	ST3,9X32MM*	200	51762.039.032
ST3,9X19MM*	200	51762.039.019	ST3,9X25MM*	200	51762.039.025			

51766 Wkręty do okien ze stali nierdzewnej z gniazdem sześciokątnym i podkładką w kolorze białym R03A

Gwint Gwint grubożwojny
Materiał Stal nierdzewna A2
Kolor Biały



d x L	☒	Kod artykułu	d x L	☒	Kod artykułu	d x L	☒	Kod artykułu
ST3,9X16MM*	200	51766.039.016	ST3,9X22MM*	200	51766.039.022	ST3,9X32MM*	200	51766.039.032
ST3,9X19MM*	200	51766.039.019	ST3,9X25MM*	200	51766.039.025			

51769 Wkręty do okien ze stali nierdzewnej z gniazdem sześciokątnym i podkładką w kolorze brązowym R03A

Gwint Gwint grubożwojny
Materiał Stal nierdzewna A2
Kolor Brązowy



d x L	☒	Kod artykułu	d x L	☒	Kod artykułu	d x L	☒	Kod artykułu
ST3,9X16MM*	200	51769.039.016	ST3,9X22MM*	200	51769.039.022	ST3,9X32MM*	200	51769.039.032
ST3,9X19MM*	200	51769.039.019	ST3,9X25MM*	200	51769.039.025			

Wkręty do tylnych ścianek paneli z wgłębieniem krzyżowym

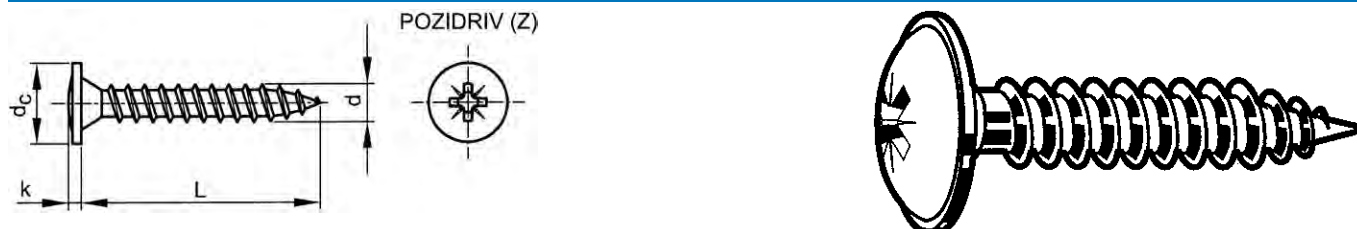

Informacje techniczne

d	d _c	k	Nr wgłębienia krzyżowego
3.5	8	1.4	2
4	9	1.7	2
4.5	10	1.9	2
5	11.5	2.1	2

29570 Wkręty samogwintujące z Ibem grzybkowym z gniazdem krzyżowym Pozidriv, do tylnych ścianek paneli K04A

Material Stal
Obróbka powierzchni Ocynkowane

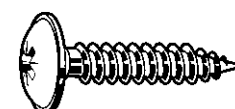

d x L	☒	Kod artykułu	d x L	☒	Kod artykułu	d x L	☒	Kod artykułu
3,5X17MM	200	29570.035.017	4X30MM	200	29570.040.030	4,5X40MM	200	29570.045.040
3,5X20MM	200	29570.035.020	4X35MM	200	29570.040.035	4,5X45MM	200	29570.045.045
3,5X25MM	200	29570.035.025	4X40MM	200	29570.040.040	5X40MM	100	29570.050.040
3,5X30MM	200	29570.035.030				5X60MM	100	29570.050.060
3,5X35MM	200	29570.035.035						

- Gwint wkrętów do płyt wiórowych Heco-fix plus.
- W zależności od dostępności wymiary mogą się różnić.

6

Wkręty z wgłębieniem krzyżowym do tablic rejestracyjnych

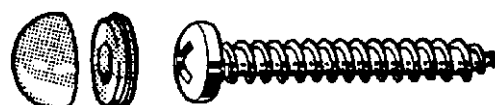

Grupy katalogowe



Gwint	Gniazdo	Material	Obróbka powierzchni	Kod	Strona
ST	Phillips	St	Ocynk.	72008	6-107
ST	Phillips	St	Ocynk. z nasadką	72005	6-108
ST	Pozidriv	St	FLZNNC-NC6 samowierzące	72022	6-108

72008 Wkręty z gniazdem krzyżowym Phillips (H) Y92D

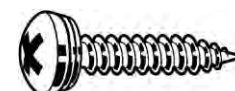
Gwint Samogwintujący
Material Stal
Obróbka powierzchni Ocynkowane



d x L	☒	Kod artykułu	d x L	☒	Kod artykułu	d x L	☒	Kod artykułu
ST4,8X16MM	100	72008.048.016	ST4,8X25MM	100	72008.048.025	ST4,8X32MM	100	72008.048.032
ST4,8X19MM	100	72008.048.020						

72005	Wkręty z łbem stożkowym soczewkowym z wgłębieniem krzyżowym Philips (H) z nasadką zatraskową			Y92D
Gwint	Samogwintujący			
Materiał	Stal			
Obróbka powierzchni	Ocynkowane			
				 

d x L	✉	Kod artykułu	d x L	✉	Kod artykułu
4,8X13 BIAŁY	100	72005.048.013	4,8X19 ŻÓŁTY	100	72005.048.019

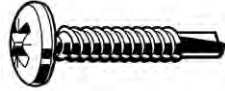
72022	Wkręty samowierzące z wgłębieniem krzyżowym Pozidriv (Z) Delta-Magni			Y92A
Gwint	Samogwintujący			
Materiał	Stal			
Obróbka powierzchni	Ocynk płatkowy bez Cr6+ wg ISO 10683 (fiZnnc)			
				 

d x L	✉	Kod artykułu	d x L	✉	Kod artykułu	d x L	✉	Kod artykułu
5,0X16MM	100	72022.050.016	5,0X19MM	100	72022.050.019	5,0X25MM	100	72022.050.025

Wkręty z gniazdem krzyżowym Philips (H) ze stali nierdzewnej

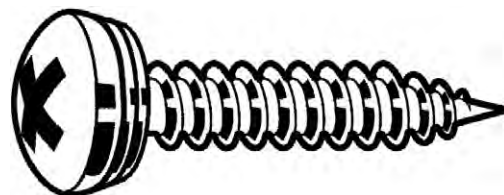
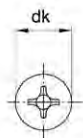
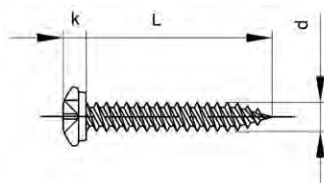

6

Informacje techniczne

d	d_k	k	Nr wgłębienia krzyżowego
3.9	7.8	1.9	2

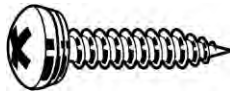
51652	Wkręty z gniazdem krzyżowym Philips (H) ze stali nierdzewnej			R03A
Gwint	Samogwintujący			
Materiał	Stal nierdzewna A2			
				 

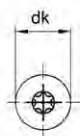
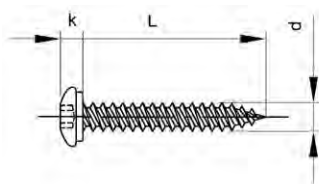

d x L	✉	Kod artykułu	d x L	✉	Kod artykułu	d x L	✉	Kod artykułu
ST3,9X9,5MM*	1000	51652.039.009	ST3,9X19MM*	1000	51652.039.019	ST3,9X32MM*	1000	51652.039.032
ST3,9X13MM*	1000	51652.039.013	ST3,9X22MM*	1000	51652.039.022	ST3,9X38MM*	1000	51652.039.038
ST3,9X16MM*	1000	51652.039.016	ST3,9X25MM*	1000	51652.039.025			

Wkręty z gniazdem sześciokarbowym ze stali nierdzewnej



Informacje techniczne

d	d _k	k	Nasadka
3.9	7.8	1.9	T15

51653	Wkręty z gniazdem sześciokarbowym ze stali nierdzewnej	R03A
Gwint	Samogwintujący	
Materiał	Stal nierdzewna A2	
		
		

d x L	☒	Kod artykułu	d x L	☒	Kod artykułu	d x L	☒	Kod artykułu
ST3,9X13MM*	1000	51653.039.013	ST3,9X22MM*	1000	51653.039.022	ST3,9X32MM*	1000	51653.039.032
ST3,9X16MM*	1000	51653.039.016	ST3,9X25MM*	1000	51653.039.025	ST3,9X38MM*	1000	51653.039.038
ST3,9X19MM*	1000	51653.039.019						

6

Wkręty z rowkiem do tablic rejestracyjnych

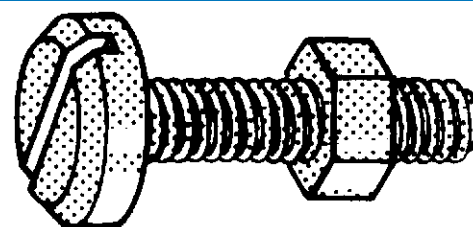

Grupy katalogowe

Gwint	Gniazdo	Materiał	Kolor	Kod	Strona
M	Szczelina	Plastik Nylon	Żółty	72000	6-109
M	Szczelina	Plastik Nylon	Czarny	72002	6-109

72000	Wkręty z rowkiem do tablic rejestracyjnych	Y92D
Gwint	Metryczny	
Materiał	Plastik Nylon (poliamid)	
Kolor	Żółty	
		

d x L	☒	Kod artykułu	d x L	☒	Kod artykułu
M6X16	100	72000.060.016	M6X25	100	72000.060.025

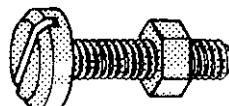
72002	Wkręty z rowkiem do tablic rejestracyjnych	Y92D
Gwint	Metryczny	
Materiał	Plastik Nylon (poliamid)	
Kolor	Czarny	
		

d x L	☒	Kod artykułu
M6X16	100	72002.060.016

Nasadki na śruby do tablic rejestracyjnych

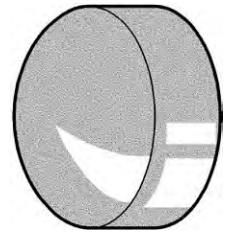

Grupy katalogowe

Material	Kod	Strona
Plastik Nylon	72011	6-110
Plastik Nylon do wkrętów samogwintujących Phillips	72018	6-110

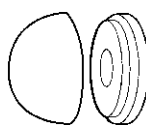
72011	Nasadki na śruby do tablic rejestracyjnych	Y92D
Material	Plastik Nylon (poliamid)	

Typ	⊗	Kod artykułu	Typ	⊗	Kod artykułu
CAP YELLOW M5	100	72011.050.001	CAP BLACK M5	100	72011.050.002

- Do wkrętów.

72018	Nasadki na śruby do tablic rejestracyjnych	Y92D
Material	Plastik Nylon (poliamid)	

Typ	⊗	Kod artykułu	Typ	⊗	Kod artykułu	Typ	⊗	Kod artykułu
NIEBIESKI	100	72018.000.002	BIAŁY	100	72018.000.011	CZARNY	100	72018.000.012
ZÓŁTY	100	72018.000.004						

- Do wkrętówz (grupy 72008/72022/51652/51653).

Wkręty do pokryć dachowych i ściennych z podkładką uszczelniającą z elastomeru



- Wkręty do pokryć dachowych i ściennych ze stali nierdzewnej są cynkowane.

Dane montażowe

Grubość materiału		0,63 - 1,1	1,25 - 1,5	2,0 - 3,0	3,0 - 3,9	4,0 - 4,9	5,0 - 5,9	6,0 - 6,9	>10,0
Zalecana śruba do pokryć dachowych i ściennych		Typ A				Typ B			
MATERIAŁ		ROZMIAR OTWORU							
Sruba do pokryć dachowych i ściennych	Konstrukcja								
Stal nierdzewna	Stal i aluminium	4,0	4,5	5,0	5,05	5,35	5,65	5,8	5,85
Aluminium	Aluminium	4,0 - 4,5			--				
Aluminium	Drewno	4,0			--				
Długość uchwytu w stali i aluminium		L-12				L-10			
Długość śruby L w drewnie		Min. 30 mm				--			

Grupy katalogowe

Gwint	Gniazdo	Materiał	Obróbka powierzchni		Kod	Strona
ST	Sześciokąt	St.St. A2	Ocynk.	A/Duże Pakowanie	31710	6-111
ST	Sześciokąt	St.St. A2	Ocynk.	A	31711	6-111
ST	Sześciokąt	St.St. A2	Ocynk.	B	31720	6-112
ST	Sześciokąt	St	Ocynk.	A	31705	6-112

31710 SFS-TOPFORM Wkręty do pokryć dachowych i ściennych z podkładką uszczelniającą z elastomeru, typ A J07A

Gwint: Samogwintujący
 Materiał: Stal nierdzewna A2
 Obróbka powierzchni: Ocynkowane

d x L	☒	Kod artykułu	d x L	☒	Kod artykułu	d x L	☒	Kod artykułu
6,5X19MM	500	31710.065.019	6,5X51MM	100	31710.065.050	6,5X115MM	100	31710.065.115
6,5X25MM	500	31710.065.025	6,5X64MM	100	31710.065.064	6,5X127MM	100	31710.065.130
6,5X32MM	500	31710.065.032	6,5X76MM	100	31710.065.075	6,5X152MM	50	31710.065.150
6,5X38MM	250	31710.065.038	6,5X90MM	100	31710.065.090	6,5X178MM	50	31710.065.175
6,5X45MM	100	31710.065.045	6,5X100MM	100	31710.065.100			

- Nadaje się do mocowania np. cienkich arkuszy stali o grubości do 3 mm (Wytrzymałość na rozciąganie około 370 N/mm²), w aluminium lub w drewnie.

31711 SFS-TOPFORM Wkręty do pokryć dachowych i ściennych z podkładką uszczelniającą z elastomeru, typ A J07A

Gwint: Samogwintujący
 Materiał: Stal nierdzewna A2
 Obróbka powierzchni: Ocynkowane

d x L	☒	Kod artykułu	d x L	☒	Kod artykułu	d x L	☒	Kod artykułu
6,5X19MM	100	31711.065.019	6,5X32MM	100	31711.065.032	6,5X38MM	100	31711.065.038
6,5X25MM	100	31711.065.025						

- Applicable for fastening f.i. thin purlins of steel up to 3 mm thickness (tensile strength about 370 N/mm²), in aluminium or in wood.

31720	SFS-TOPFORM Wkręty do pokryć dachowych i ściennych z podkładką uszczelniającą z elastomeru, typ B	J07A
Gwint	Samogwintujący	
Materiał	Stal nierdzewna A2	
Obróbka powierzchni	Ocynkowane	

d x L	☒	Kod artykułu	d x L	☒	Kod artykułu
6,3X19MM	500	31720.063.019	6,3X25MM	500	31720.063.025

Wkręty do pokryć dachowych i ściennych ze stali nierdzewnej są cynkowane

31705	Wkręty do pokryć dachowych i ściennych z podkładką uszczelniającą z elastomeru, typ A	J07A
Gwint	Samogwintujący	
Materiał	Stal	
Obróbka powierzchni	Ocynkowane	

d x L	☒	Kod artykułu	d x L	☒	Kod artykułu	d x L	☒	Kod artykułu
6,5X19MM	100	31705.065.019	6,5X50MM	100	31705.065.050	6,5X115MM	100	31705.065.115
6,5X25MM	100	31705.065.025	6,5X64MM	100	31705.065.064	6,5X130MM	100	31705.065.130
6,5X32MM	100	31705.065.032	6,5X75MM	100	31705.065.075	6,5X150MM	50	31705.065.150
6,5X38MM	100	31705.065.038	6,5X90MM	100	31705.065.090			

• Nadaje się do mocowania np. cienkich arkuszy stali o grubości do 3 mm (Wytrzymałość na rozciąganie około 370 N/mm²), w aluminium lub w drewnie.

6

Śruby do elewacji z podkł. uszcz. 16mm

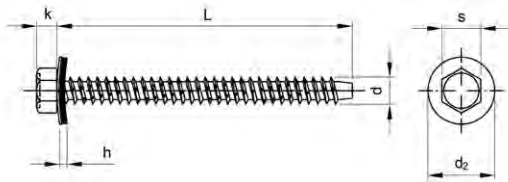

Informacje techniczne



d	d ₂	h	k	s
6.3	16	3	4.6	3/8
6.5	16	3	4.6	3/8

Grupy katalogowe

Gwint	Gniazdo	Materiał	Kod	Strona	
ST	Sześciokąt	St.St. A2	flat point	51891	6-112
ST	Sześciokąt	St.St. A2	cone point	51892	6-113

51891	Śruby do elewacji z końcem płaskim i z podkł. uszcz. 16mm	R03A
Gwint	Samogwintujący	
Materiał	Stal nierdzewna A2	

d x L	☒	Kod artykułu	d x L	☒	Kod artykułu	d x L	☒	Kod artykułu
6,3X16MM*	500	51891.063.016	6,3X64MM*	100	51891.063.064	6,3X150MM*	100	51891.063.150
6,3X19MM*	500	51891.063.019	6,3X75MM*	100	51891.063.075	6,3X175MM*	100	51891.063.175
6,3X25MM*	200	51891.063.025	6,3X90MM*	100	51891.063.090	6,3X200MM*	100	51891.063.200
6,3X32MM*	200	51891.063.032	6,3X100MM*	100	51891.063.100	6,3X220MM*	100	51891.063.220
6,3X38MM*	200	51891.063.038	6,3X115MM*	100	51891.063.115	6,3X240MM*	100	51891.063.240
6,3X45MM*	200	51891.063.045	6,3X130MM*	100	51891.063.130	6,3X260MM*	100	51891.063.260
6,3X50MM*	200	51891.063.050						

51892	Śruby do elewacji z końcem stożkowym i z podkł. uszcz. 16mm			R03A
Gwint	Samogwintujący			
Materiał	Stal nierdzewna A2			
				 

d x L	☒	Kod artykułu	d x L	☒	Kod artykułu	d x L	☒	Kod artykułu
6,5X13MM*	500	51892.065.013	6,5X50MM*	200	51892.065.050	6,5X130MM*	100	51892.065.130
6,5X16MM*	500	51892.065.016	6,5X55MM*	200	51892.065.055	6,5X150MM*	100	51892.065.150
6,5X19MM*	500	51892.065.019	6,5X60MM*	200	51892.065.060	6,5X175MM*	100	51892.065.175
6,5X25MM*	200	51892.065.025	6,5X64MM*	100	51892.065.064	6,5X200MM*	100	51892.065.200
6,5X32MM*	200	51892.065.032	6,5X75MM*	100	51892.065.075	6,5X220MM*	100	51892.065.220
6,5X38MM*	200	51892.065.038	6,5X90MM*	100	51892.065.090	6,5X240MM*	100	51892.065.240
6,5X40MM*	200	51892.065.040	6,5X100MM*	100	51892.065.100	6,5X260MM*	100	51892.065.260
6,5X45MM*	200	51892.065.045	6,5X115MM*	100	51892.065.115			

Śruby do elewacji z podkł. uszcz 19mm

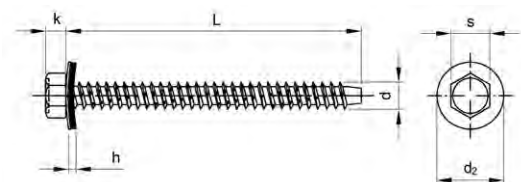



Informacje techniczne



d	d ₂	h	k	s
6.3	19	3	4.6	3/8
6.5	19	3	4.6	3/8

Grupy katalogowe

Gwint	Gniazdo	Materiał	Kod	Strona
ST	Sześciokąt	St.St. A2	flat point	51893 6-113
ST	Sześciokąt	St.St. A2	cone point	51894 6-113

51893	Śruby do elewacji z końcem płaskim i z podkł. uszcz. 19mm			R03A
Gwint	Samogwintujący			
Materiał	Stal nierdzewna A2			
				 

d x L	☒	Kod artykułu	d x L	☒	Kod artykułu	d x L	☒	Kod artykułu
6,3X16MM*	500	51893.063.016	6,3X64MM*	100	51893.063.064	6,3X150MM*	100	51893.063.150
6,3X19MM*	500	51893.063.019	6,3X75MM*	100	51893.063.075	6,3X175MM*	100	51893.063.175
6,3X25MM*	200	51893.063.025	6,3X90MM*	100	51893.063.090	6,3X200MM*	100	51893.063.200
6,3X32MM*	200	51893.063.032	6,3X100MM*	100	51893.063.100	6,3X220MM*	100	51893.063.220
6,3X38MM*	200	51893.063.038	6,3X115MM*	100	51893.063.115	6,3X240MM*	100	51893.063.240
6,3X45MM*	200	51893.063.045	6,3X130MM*	100	51893.063.130	6,3X260MM*	100	51893.063.260
6,3X50MM*	200	51893.063.050						

51894	Śruby do elewacji z końcem stożkowym i z podkł. uszcz. 19mm			R03A
Gwint	Samogwintujący			
Materiał	Stal nierdzewna A2			
				 

d x L	☒	Kod artykułu	d x L	☒	Kod artykułu	d x L	☒	Kod artykułu
6,5X16MM*	500	51894.065.016	6,5X64MM*	100	51894.065.064	6,5X165MM*	100	51894.065.165
6,5X19MM*	500	51894.065.019	6,5X75MM*	100	51894.065.075	6,5X175MM*	100	51894.065.175
6,5X25MM*	200	51894.065.025	6,5X90MM*	100	51894.065.090	6,5X200MM*	100	51894.065.200
6,5X32MM*	200	51894.065.032	6,5X100MM*	100	51894.065.100	6,5X220MM*	100	51894.065.220
6,5X38MM*	200	51894.065.038	6,5X115MM*	100	51894.065.115	6,5X240MM*	100	51894.065.240
6,5X45MM*	200	51894.065.045	6,5X130MM*	100	51894.065.130	6,5X260MM*	100	51894.065.260
6,5X50MM*	200	51894.065.050	6,5X150MM*	100	51894.065.150			

Śruby do elewacji z podkładką uszcz. 22mm

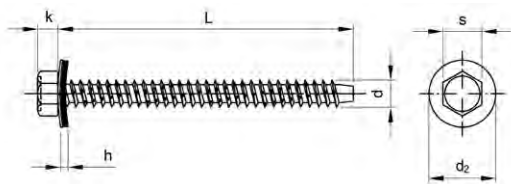

Informacje techniczne

d	d ₂	h	k	s
6.3	22	3	4.6	3/8
6.5	22	3	4.6	3/8

Grupy katalogowe

Gwint	Gniazdo	Materiał		Kod	Strona
ST	Sześciokąt	St.St. A2	flat point	51777	6-114
ST	Sześciokąt	St.St. A2	cone point	51771	6-114

51777 Śruby do elewacji z końcem płaskim i z podkł. uszcz. 22mm

R03A

Gwint Samogwintujący
Materiał Stal nierdzewna A2



d x L	☒	Kod artykułu	d x L	☒	Kod artykułu	d x L	☒	Kod artykułu
6,3X16MM*	500	51777.063.016	6,3X64MM*	100	51777.063.064	6,3X150MM*	100	51777.063.150
6,3X19MM*	500	51777.063.019	6,3X75MM*	100	51777.063.075	6,3X175MM*	100	51777.063.175
6,3X25MM*	200	51777.063.025	6,3X90MM*	100	51777.063.090	6,3X200MM*	100	51777.063.200
6,3X32MM*	200	51777.063.032	6,3X100MM*	100	51777.063.100	6,3X220MM*	100	51777.063.220
6,3X38MM*	200	51777.063.038	6,3X115MM*	100	51777.063.115	6,3X240MM*	100	51777.063.240
6,3X45MM*	200	51777.063.045	6,3X130MM*	100	51777.063.130	6,3X260MM*	100	51777.063.260
6,3X50MM*	200	51777.063.050						

51771 Śruby do elewacji z końcem stożkowym i z podkł. uszcz. 22mm

R03A

Gwint Samogwintujący
Materiał Stal nierdzewna A2



d x L	☒	Kod artykułu	d x L	☒	Kod artykułu	d x L	☒	Kod artykułu
6,5X16MM*	500	51771.065.016	6,5X64MM*	100	51771.065.064	6,5X150MM*	100	51771.065.150
6,5X19MM*	500	51771.065.019	6,5X75MM*	100	51771.065.075	6,5X175MM*	100	51771.065.175
6,5X25MM*	200	51771.065.025	6,5X90MM*	100	51771.065.090	6,5X200MM*	100	51771.065.200
6,5X32MM*	200	51771.065.032	6,5X100MM*	100	51771.065.100	6,5X220MM*	100	51771.065.220
6,5X38MM*	200	51771.065.038	6,5X115MM*	100	51771.065.115	6,5X240MM*	100	51771.065.240
6,5X45MM*	200	51771.065.045	6,5X130MM*	100	51771.065.130	6,5X260MM*	100	51771.065.260
6,5X50MM*	200	51771.065.050						

Wkręty do elewacji z gwintem żebrowanym ze stali A2

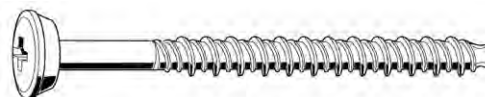
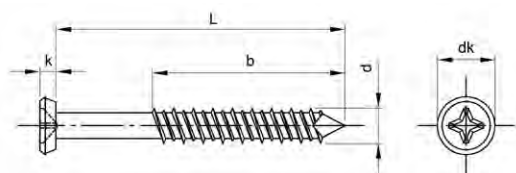

Informacje techniczne

d	d _k	k
5.5	9.2	3

51799 Wkręty do elewacji z gwintem żebrowanym ze stali A2 R03A

Gwint Samogwintujący
 Materiał Stal nierdzewna A2
 Klasa 50



d x L x b	☒	Kod artykułu	d x L x b	☒	Kod artykułu	d x L x b	☒	Kod artykułu
ST5,5X25MM*	100	51799.055.025	ST5,5X45MM*	100	51799.055.045	ST5,5X55MM*	100	51799.055.055
ST5,5X35MM*	100	51799.055.035						

6

Wkręty do pokryć dachowych i ściennych z podkładką uszczelniającą z elastomeru końcówką wiertła

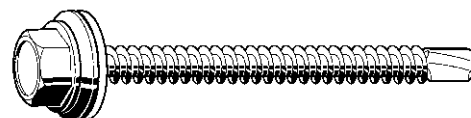
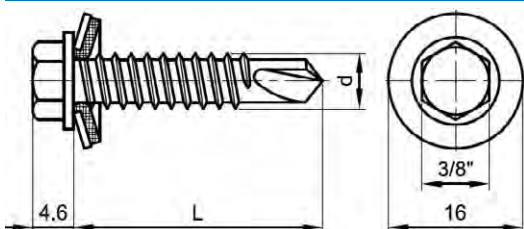

31702 Wkręty do pokryć dachowych i ściennych z podkładką uszczelniającą z elastomeru końcówką wiertła J07A

Gwint Samogwintujący
 Materiał Stal
 Obróbka powierzchni Ocynkowane



d x L	☒	Kod artykułu	d x L	☒	Kod artykułu	d x L	☒	Kod artykułu
6,3X19MM	250	31702.063.019	6,3X38MM	250	31702.063.038	6,3X60MM	100	31702.063.060
6,3X25MM	250	31702.063.025	6,3X50MM	100	31702.063.050	6,3X75MM	100	31702.063.075
6,3X32MM	200	31702.063.032						

- Ostrzeżenie: cynkowanie elektrolityczne tych produktów może wywołać kruchość wodorową.

Podkładki uszczelniające z elastomeru

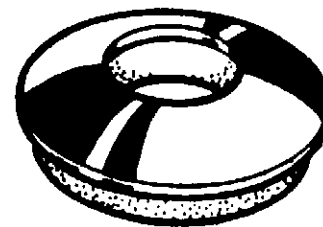
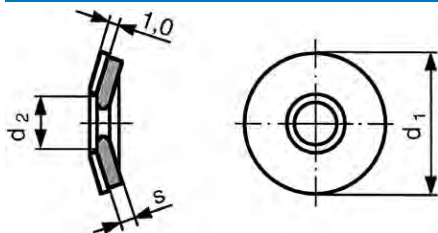

Informacje techniczne

d ₁	d ₂	s	d ₁	d ₂	s
16	6.7	2	22	6.7	3
19	6.7	3	29	6.7	3

Dane montażowe

Grubość materiału	0,63 - 1,1	1,25 - 1,5	2,0 - 3,0	3,0 - 3,9	4,0 - 4,9	5,0 - 5,9	6,0 - 6,9	>10,0	
Zalecana śruba do pokryć dachowych i ściennych	Typ A			Typ B					
MATERIAŁ		ROZMIAR OTWORU							
Śruba do pokryć dachowych i ściennych	Konstrukcja								
Stal nierdzewna	Stal i aluminium	4,0	4,5	5,0	5,05	5,35	5,65	5,8	5,85
Aluminium	Aluminium	4,0 - 4,5			--				
Aluminium	Drewno	4,0			--				
Długość uchwyty w stali i aluminium		L-12			L-10				
Długość śruby L w drewnie		Min. 30 mm			--				

Grupy katalogowe

Material	Kod	Strona
St.St. A2	31781	6-116
St.St. A2 Duże Opakowanie	31780	6-116

31781	Podkładki uszczelniające z elastomeru	J07A
Material	Stal nierdzewna A2	

d ₁	☒	Kod artykułu	d ₁	☒	Kod artykułu	d ₁	☒	Kod artykułu
16MM	100	31781.160.001	19MM	100	31781.190.001	22MM	100	31781.220.001

31780	Podkładki uszczelniające z elastomeru	J07A
Material	Stal nierdzewna A2	

d ₁	☒	Kod artykułu	d ₁	☒	Kod artykułu	d ₁	☒	Kod artykułu
16MM	500	31780.160.001	22MM	500	31780.220.001	29MM	100	31780.290.001
19MM	500	31780.190.001						

Podkładki nierdzewne uszczelniające EPDM szare łukowe

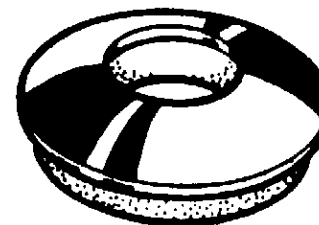
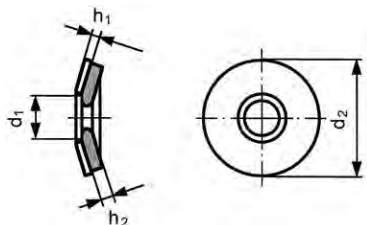

Informacje techniczne

d_1	h_1	h_2
4.8	1	2
5.3	1	2
6.2	1	2
6.7	1	2
8.4	1	2
10.5	1	2
13	1	2

51422 Podkładki nierdzewne uszczelniające EPDM szare łukowe

R05A

Materiał Stal nierdzewna A2



6

$d_1 \times d_2$	☒	Kod artykułu	$d_1 \times d_2$	☒	Kod artykułu	$d_1 \times d_2$	☒	Kod artykułu
4,8X12MM*	1000	51422.048.012	6,7X16MM*	1000	51422.067.016	8,4X22MM*	1000	51422.084.022
4,8X14MM*	1000	51422.048.014	6,7X19MM*	1000	51422.067.019	8,4X25MM*	1000	51422.084.025
5,3X12MM*	1000	51422.053.012	6,7X22MM*	1000	51422.067.022	8,4X29MM*	500	51422.084.029
5,3X14MM*	1000	51422.053.014	6,7X25MM*	1000	51422.067.025	10,5X25MM*	1000	51422.105.025
5,3X16MM*	1000	51422.053.016	6,7X29MM*	500	51422.067.029	10,5X29MM*	500	51422.105.029
5,3X19MM*	1000	51422.053.019	8,4X16MM*	1000	51422.084.016	13,0X29MM*	500	51422.130.029
6,2X16MM*	1000	51422.062.016	8,4X19MM*	1000	51422.084.019			

Wkręty samowierzące MaxxFast

Wysoka jakość

Program wkrętów samowierzących MaxxFast obejmuje wysokiej jakości samowierzące elementy złączne. Dzięki użyciu wkrętów samowierzących MaxxFast możliwe jest wykonanie solidnego połączenia podczas jednej operacji. W trakcie jednej operacji wywiercony jest odpowiedni otwór, uformowany gwint i utworzone połączenie. Koniec z dodatkowym wierceniem czy przebijaniem, koniec z gwintowaniem.

Wysokiej jakości elementy złączne!

Zintegrowana końcówka wierząca zapewnia znaczne oszczędności w całkowitym koszcie wykonania połączenia. Zapobiega także błędom wynikającym z przemieszczania części roboczych. Podczas procesu połączenia eliminujemy czasochłonne przygotowanie odpowiedniego miejsca pracy, jak i konieczność wymiany narzędzi.

W szczególności podczas pracy z dużymi częściami możliwa jest oszczędność czasu w wielu aspektach. Każdy wkręt używa "własnego" punktu wiercenia i zapobiega stratom czasu spowodowanym użyciem osobnych wiertel. Zastosowanie odpowiedniej średnicy wiercenia w stosunku do rozmiaru wkrętu jest gwarantowane, eliminując ryzyko błędu. Stosowanie wkrętów samowierzących zapobiega błędom połączenia i zmniejsza ogólne koszty wykonania połączeń.

Oszczędność czasu i sprzętu!

Szybsze i łatwiejsze połączenie, brak strat czasu na wyrównanie i pozycjonowanie łączonych komponentów. Nasze testy wykazały możliwą oszczędność czasu do 50% w stosunku do tradycyjnego łączenia. Brak dodatkowych kosztów inwestycyjnych związanych z dodatkowymi narzędziami montażowymi.

Wkręty samowierzące MaxxFast dostępne są w 3 różnych materiałach:

- Stal ocynkowana
- Stal nierdzewna
- Bimetaliczne w powłoce Ruspert 500

Wkręty samowierzące MaxxFast produkowane są z najbardziej popularnymi typami gniazd takimi jak Phillips, sześciokąt, kwadrat aby móc zastosować je we wszystkich możliwych typach narzędzi. Dodatkowo oprócz standardowych gniazd, wkręty samowierzące MaxxFast dostępne są również z innowacyjnym gniazdem ttap®.

6

Wkręty z łbem walcowym i napędem krzyżowym MaxxFast

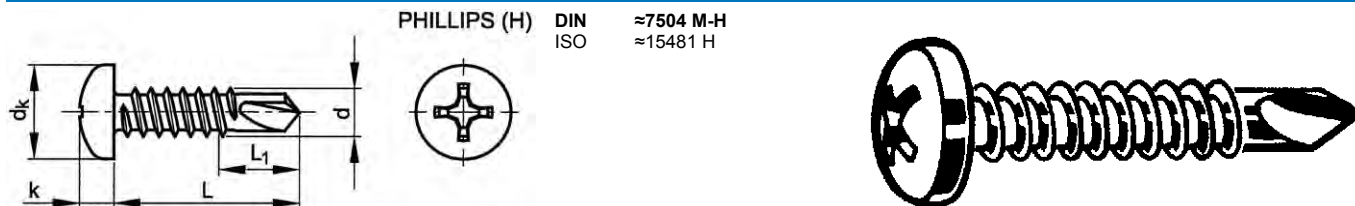

Informacje techniczne

d	dk	k	L ₁	Nr wgłębienia krzyżowego
ST2.9	5.30 - 5.60	1.95 - 2.20	4	1
ST3.5	6.54 - 6.90	2.35 - 2.60	4	2
ST3.9	7.14 - 7.50	2.55 - 2.80	4.5	2
ST4.2	7.84 - 8.20	2.75 - 3.05	5	2
ST4.8	9.14 - 9.50	3.25 - 3.55	6.5	2
ST5.5	10.37 - 10.80	3.65 - 3.95	8	3

30320 MAXXFAST wkręt samowierzący soczewkowy z napędem Philips

MF1A

Gwint Samogwintujący
 Materiał Stal
 Obróbka powierzchni Ocynkowane

MAXXFAST
 PROFESSIONAL HARDWARE



d x L	☒	Kod artykułu	d x L	☒	Kod artykułu	d x L	☒	Kod artykułu
ST2,9X9,5MM	200	30320.029.009	ST3,9X25MM	200	30320.039.025	ST4,8X25MM	200	30320.048.025
ST2,9X13MM	200	30320.029.013	ST3,9X32MM	200	30320.039.032	ST4,8X32MM	200	30320.048.032
ST3,5X9,5MM	200	30320.035.009	ST4,2X13MM	200	30320.042.013	ST4,8X38MM	200	30320.048.038
ST3,5X13MM	200	30320.035.013	ST4,2X16MM	200	30320.042.016	ST4,8X45MM	200	30320.048.045
ST3,5X16MM	200	30320.035.016	ST4,2X19MM	200	30320.042.019	ST4,8X50MM	200	30320.048.050
ST3,5X19MM	200	30320.035.019	ST4,2X22MM	200	30320.042.022	ST5,5X19MM	200	30320.055.019
ST3,5X22MM	200	30320.035.022	ST4,2X25MM	200	30320.042.025	ST5,5X22MM	200	30320.055.022
ST3,5X25MM	200	30320.035.025	ST4,2X32MM	200	30320.042.032	ST5,5X25MM	200	30320.055.025
ST3,9X13MM	200	30320.039.013	ST4,8X13MM	200	30320.048.013	ST5,5X32MM	200	30320.055.032
ST3,9X16MM	200	30320.039.016	ST4,8X16MM	200	30320.048.016	ST5,5X38MM	200	30320.055.038
ST3,9X19MM	200	30320.039.019	ST4,8X19MM	200	30320.048.019	ST5,5X45MM	200	30320.055.045
ST3,9X22MM	200	30320.039.022	ST4,8X22MM	200	30320.048.022	ST5,5X50MM	200	30320.055.050

• Tylko pełne opakowania.

Wkręty z łbem walcowym z gniazdem krzyżowym MaxxFast stal A2

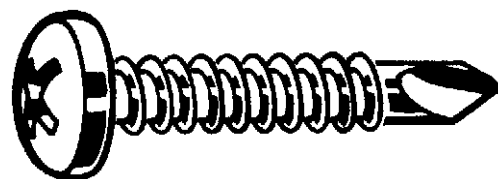
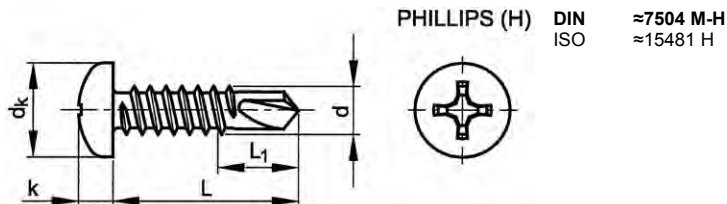

Informacje techniczne

d	d _k	k	L ₁	Nr wgłębienia krzyżowego
ST2.9	5.30 - 5.60	2.15 - 2.40	4	1
ST3.5	6.64 - 7.00	2.35 - 2.60	4	2
ST3.9	7.14 - 7.50	2.55 - 2.80	4.5	2
ST4.2	7.64 - 8.00	2.80 - 3.10	4.5	2
ST4.8	9.14 - 9.50	3.40 - 3.70	6.5	2
ST5.5	10.57 - 11.00	3.70 - 4.00	8	3

Grupy katalogowe

Gwint	Gniazdo	Materiał	Kod	Strona
ST	Phillips	St.St. A2	30325	6-120
ST	Phillips	Bi-Metal	30330	6-120

6

30325 MAXXFAST wkręt samowierzący soczewkowy z napędem Philips MF1A

Gwint: Samogwintujący
Materiał: Stal nierdzewna A2

MAXXFAST
PROFESSIONAL HARDWARE

d x L	☒	Kod artykułu	d x L	☒	Kod artykułu	d x L	☒	Kod artykułu
ST2,9X9,5MM	200	30325.029.009	ST3,9X25MM	200	30325.039.025	ST4,8X25MM	200	30325.048.025
ST2,9X13MM	200	30325.029.013	ST3,9X32MM	200	30325.039.032	ST4,8X32MM	200	30325.048.032
ST3,5X9,5MM	200	30325.035.009	ST4,2X13MM	200	30325.042.013	ST4,8X38MM	200	30325.048.038
ST3,5X13MM	200	30325.035.013	ST4,2X16MM	200	30325.042.016	ST4,8X45MM	200	30325.048.045
ST3,5X16MM	200	30325.035.016	ST4,2X19MM	200	30325.042.019	ST4,8X50MM	200	30325.048.050
ST3,5X19MM	200	30325.035.019	ST4,2X22MM	200	30325.042.022	ST5,5X19MM	200	30325.055.019
ST3,5X22MM	200	30325.035.022	ST4,2X25MM	200	30325.042.025	ST5,5X22MM	200	30325.055.022
ST3,5X25MM	200	30325.035.025	ST4,2X32MM	200	30325.042.032	ST5,5X25MM	200	30325.055.025
ST3,9X13MM	200	30325.039.013	ST4,8X13MM	200	30325.048.013	ST5,5X32MM	200	30325.055.032
ST3,9X16MM	200	30325.039.016	ST4,8X16MM	200	30325.048.016	ST5,5X38MM	200	30325.055.038
ST3,9X19MM	200	30325.039.019	ST4,8X19MM	200	30325.048.019	ST5,5X45MM	200	30325.055.045
ST3,9X22MM	200	30325.039.022	ST4,8X22MM	200	30325.048.022	ST5,5X50MM	200	30325.055.050

• Tylko pełne opakowania.

30330 MAXXFAST wkręt samowierzący soczewkowy z napędem Philips MF1A

Gwint: Samogwintujący
Materiał: Bi-Metal

MAXXFAST
PROFESSIONAL HARDWARE

d x L	☒	Kod artykułu	d x L	☒	Kod artykułu	d x L	☒	Kod artykułu
ST3,5X16MM	200	30330.035.016	ST4,2X16MM	200	30330.042.016	ST4,8X38MM	200	30330.048.038
ST3,5X19MM	200	30330.035.019	ST4,2X19MM	200	30330.042.019	ST4,8X45MM	200	30330.048.045
ST3,5X22MM	200	30330.035.022	ST4,2X22MM	200	30330.042.022	ST4,8X50MM	200	30330.048.050
ST3,5X25MM	200	30330.035.025	ST4,2X25MM	200	30330.042.025	ST5,5X19MM	200	30330.055.019
ST3,9X16MM	200	30330.039.016	ST4,2X32MM	200	30330.042.032	ST5,5X22MM	200	30330.055.022
ST3,9X19MM	200	30330.039.019	ST4,8X16MM	200	30330.048.016	ST5,5X25MM	200	30330.055.025
ST3,9X22MM	200	30330.039.022	ST4,8X19MM	200	30330.048.019	ST5,5X32MM	200	30330.055.032
ST3,9X25MM	200	30330.039.025	ST4,8X22MM	200	30330.048.022	ST5,5X38MM	200	30330.055.038
ST3,9X32MM	200	30330.039.032	ST4,8X25MM	200	30330.048.025	ST5,5X45MM	200	30330.055.045
			ST4,8X32MM	200	30330.048.032	ST5,5X50MM	200	30330.055.050

• Tylko pełne opakowania.

Fabory-Spedec Wkręty samowierzące

Informacje ogólne

Z systemem mocowań montażu bezpośredniego Fabory Spedec podczas montażu dokonuje się wiercenia materiałów i ich łączenia w jednej operacji. Nie ma potrzeby osobnego wiercenia czy wybijania otworu a gwint jest typu samogwintującego. Istotną rolę dla szybkiego montażu odgrywają też odpowiednie wgłębienia i gniazda. Pozwala to na szybkie tworzenie solidnego połączenia również przy zmechanizowanym montażu masowym.

Normy

Typy łbów oraz wielkości wkrętów samowierzących Fabory-Spedec są zgodne z normą DIN dla wkrętów standardowych.

Material

Wkręty samowierzące Fabory-Spedec są wytwarzane ze stali nawęglanej (min. 560 HV 0.3), z twardym rdzeniem (270-425 HV 0.3). Wkręty samowierzące Fabory-Spedec spełniają normę DIN 7504 pod względem rozmiarów, wymagań i testów.

Gwinty

Wkręty samowierzące Fabory-Spedec mają gwinty samogwintujące (oznaczenie ST) zgodnie z DIN 7970. Pełen gwint celem uzyskania lepszego zacisku złącza.

System

Każdy wkręt samowierzący Fabory-Spedec nawierca otwór swym integralnym ostrzem do samonawiercania. Oznacza to szybszy i łatwiejszy montaż i brak potrzeby czasochłonnego osiowania i ustawiania elementów konstrukcyjnych.

Zastosowanie

Wkręty samowierzące Fabory-Spedec ze stali nierdzewnej A2 są do wyłącznego stosowania do stopów aluminium o twardości Brinella do 75 HB, natomiast wkręty samowierzące aluminiowe przeznaczone są do wyłącznego stosowania do tworzyw sztucznych i stopów aluminium.

6

Wartości zalecane dla stalowych wkrętów samowierzących Fabory-Spedec typu SN

d		ST2,9	ST3,5	ST3,9	ST4,2	ST4,8	ST5,5	ST6,3
Min. siła rozciągająca w N		4400	6300	8000	8300	12000	14000	21000
Min. wytrż. na ścinanie w N		2100	3700	3600	4100	6800	9000	13300
Moment zrywający w Nm		2	3,7	4,5	5,1	9,2	14,5	23
Zdolność nawiercania w poprzecznicach stalowych (St 37/52) włącznie z obszarem ingerencji	(min.)	0,5	1	1	1,75	2,75	2,75	2,75
	(max.)	2	2	2,5	3,5/3	5/4	6	6
Urządzenie wierzące (niezaładowane)	r.p.m.	3500	3500	3500	3500	3500	2900	2900
	Wyjściowo Wat	340-400	340-400	340-400	340-400	340-400	400-700	400-700
Średniczas nawiercania w St 37	Okolo (sek.)	3,5	4	5,7	4,1	3,6	6,9	13

Typy wgłębien

Wkręty mają różnego rodzaju wgłębienia tj. płaskie, krzyżowe, krzyżowe typu Pozidriv, gniazdo sześciokątne oraz wgłębienie krzyżowe typu SR. Pierwsze rodzaje mają jedną ogólną wadę: odchylenie wymiarowe wgłębienia i narzędzia, co skutkuje nadmiernym prześwitem między wgłębieniem a narzędziem i w konsekwencji niestabilnością na początku wkręcania (wibracje i chybotanie). Ten nadmierny prześwit może też stanowić problem przy demontażu śrub w trudnej lokalizacji.

Wgłębienie krzyżowe typu SR

Wgłębienie krzyżowe typu SR zostało opracowane celem wyeliminowania problemu nadmiernego prześwitu. Jest w zasadzie kombinacją gniazda kwadratowego i wgłębienia krzyżowego. Stożkowe gniazdo kwadratowe pozwala

wkrętowi typu SR na bezpośrednie przyleganie do narzędzia SR. Wkręt, bez względu na swą masę, pozostaje silnie zespolony z narzędziem. To doskonałe połączenie zapewnia, że ścieranie się wgłębienia i bitu narzędzia jest ograniczone do minimum. Żywotność narzędzia (bitu) typu SR jest dwukrotnie większa niż żywotność narzędzia konwencjonalnego.

A nawet więcej... W tej sekcji Fabory znajdziesz szeroki asortyment wkrętów samowierzących MaxxFast ze stali, stali nierdzewnej a także wersji bi-metal. Głównie wgłębienia typu ttap®, ale także sześciokątne, pozidriv oraz kwadratowe.

Wkręty samowierzące z łbem walcowym wypukłym z gniazdem krzyżowym

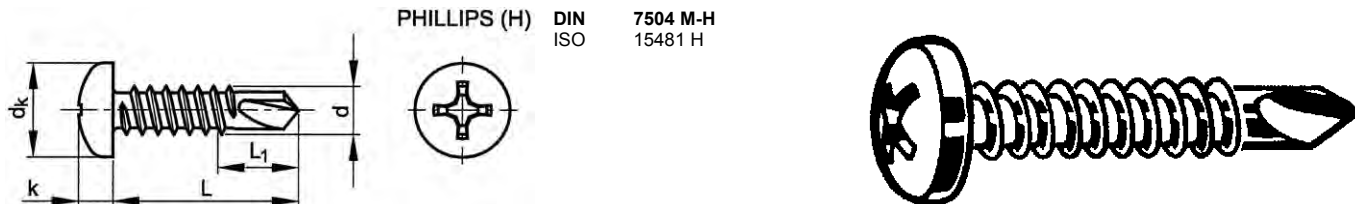

Informacje techniczne

d	d _k	k	L ₁ ≈	Nr wgłębienia krzyżowego	P
ST2.9	5.6	2.2	4.5	1	1.1
ST3.5	6.9	2.6	5	2	1.3
ST3.9	7.5	2.8	6	2	1.4
ST4.2	8.2	3.05	7	2	1.4
ST4.8	9.5	3.55	8	2	1.6

- Maks. długość uchwytu KL = L - L₁.

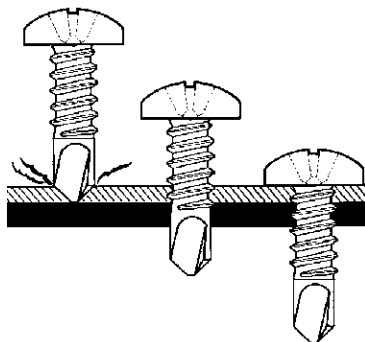

6

Grupy katalogowe

Gwint	Gniazdo	Materiał	Obróbka powierzchni	Kod	Strona
ST	Phillips	St	Ocynk.	31255	6-122
ST	Phillips	St	Ocynk.	31250	6-123
ST	Phillips	St.St. A2		31120	6-123
ST	Phillips	St	Ocynk.	31825	6-123
ST	Phillips	St	Ocynk.	31820	6-123
ST	Phillips	St.St. A2		31870	6-124

31255 SPEDEC SN Wkręty samowierzące z łbem walcowym wypukłym z gniazdem krzyżowym Phillips



J09A

Gwint Samogwintujący
Materiał Stal
Obróbka powierzchni Ocynkowane





d x L	☒	Kod artykułu	d x L	☒	Kod artykułu	d x L	☒	Kod artykułu
ST3,5X9,5MM	200	31255.035.009	ST3,9X16MM	200	31255.039.016	ST4,2X25MM	200	31255.042.025
ST3,5X13MM	200	31255.035.013	ST3,9X19MM	200	31255.039.019	ST4,2X32MM	200	31255.042.032
ST3,5X16MM	200	31255.035.016						
ST3,5X19MM	200	31255.035.019	ST4,2X13MM	200	31255.042.013	ST4,8X13MM	200	31255.048.013
ST3,5X25MM	200	31255.035.025	ST4,2X16MM	200	31255.042.016	ST4,8X16MM	200	31255.048.016
			ST4,2X19MM	200	31255.042.019	ST4,8X19MM	200	31255.048.019

- Ostrzeżenie: cynkowanie elektrolityczne tych produktów może wywołać kruchość wodorową.



31250 SPEDEC SN Wkręty samowierzące z łbem walcowym wypukłym z gniazdem krzyżowym Phillips		J09A
Gwint	Samogwintujący	 
Materiał	Stal	
Obróbka powierzchni	Ocynkowane	

d x L	☒	Kod artykułu	d x L	☒	Kod artykułu	d x L	☒	Kod artykułu																									
ST2,9X9,5MM	1000	31250.029.009	ST3,9X19MM	1000	31250.039.019	<table border="1"> <thead> <tr> <th>d x L</th> <th>☒</th> <th>Kod artykułu</th> </tr> </thead> <tbody> <tr> <td>ST4,8X13MM</td> <td>1000</td> <td>31250.048.013</td> </tr> <tr> <td>ST4,8X16MM</td> <td>1000</td> <td>31250.048.016</td> </tr> <tr> <td>ST4,8X19MM</td> <td>1000</td> <td>31250.048.019</td> </tr> <tr> <td>ST4,8X22MM</td> <td>1000</td> <td>31250.048.022</td> </tr> <tr> <td>ST4,8X25MM</td> <td>1000</td> <td>31250.048.025</td> </tr> <tr> <td>ST4,8X32MM</td> <td>1000</td> <td>31250.048.032</td> </tr> <tr> <td>ST4,8X38MM</td> <td>500</td> <td>31250.048.038</td> </tr> <tr> <td>ST4,8X50MM</td> <td>500</td> <td>31250.048.050</td> </tr> </tbody> </table>	d x L	☒	Kod artykułu	ST4,8X13MM	1000	31250.048.013	ST4,8X16MM	1000	31250.048.016	ST4,8X19MM	1000	31250.048.019	ST4,8X22MM	1000	31250.048.022	ST4,8X25MM	1000	31250.048.025	ST4,8X32MM	1000	31250.048.032	ST4,8X38MM	500	31250.048.038	ST4,8X50MM	500	31250.048.050
d x L	☒	Kod artykułu																															
ST4,8X13MM	1000	31250.048.013																															
ST4,8X16MM	1000	31250.048.016																															
ST4,8X19MM	1000	31250.048.019																															
ST4,8X22MM	1000	31250.048.022																															
ST4,8X25MM	1000	31250.048.025																															
ST4,8X32MM	1000	31250.048.032																															
ST4,8X38MM	500	31250.048.038																															
ST4,8X50MM	500	31250.048.050																															
ST3,5X9,5MM	1000	31250.035.009	ST3,9X25MM	1000	31250.039.025																												
ST3,5X13MM	1000	31250.035.013	ST3,9X32MM	1000	31250.039.032																												
ST3,5X16MM	1000	31250.035.016	ST4,2X13MM	1000	31250.042.013																												
ST3,5X19MM	1000	31250.035.019	ST4,2X16MM	1000	31250.042.016																												
ST3,5X25MM	1000	31250.035.025	ST4,2X19MM	1000	31250.042.019																												
ST3,9X13MM	1000	31250.039.013	ST4,2X22MM	1000	31250.042.022																												
ST3,9X16MM	1000	31250.039.016	ST4,2X25MM	1000	31250.042.025																												
			ST4,2X32MM	1000	31250.042.032																												

• Ostrzeżenie: cynkowanie elektrolityczne tych produktów może wywołać kruchość wodorową.



31120 SPEDEC SN Wkręty samowierzące z łbem walcowym wypukłym z gniazdem krzyżowym Phillips		J09A
Gwint	Samogwintujący	 
Materiał	Stal nierdzewna A2	
Obróbka powierzchni		

d x L	☒	Kod artykułu	d x L	☒	Kod artykułu	d x L	☒	Kod artykułu
ST2,9X13MM	1000	31120.029.013	ST3,9X16MM	1000	31120.039.016	ST4,2X25MM	1000	31120.042.025
ST3,5X9,5MM	1000	31120.035.009	ST3,9X25MM	1000	31120.039.025	ST4,8X16MM	1000	31120.048.016
ST3,5X13MM	1000	31120.035.013	ST4,2X13MM	1000	31120.042.013	ST4,8X22MM	1000	31120.048.022
ST3,5X19MM	1000	31120.035.019	ST4,2X16MM	1000	31120.042.016			
			ST4,2X19MM	1000	31120.042.019			

31825 Wkręty samowierzące z łbem walcowym wypukłym z gniazdem krzyżowym Phillips		J09B
Gwint	Samogwintujący	 
Materiał	Stal	
Obróbka powierzchni	Ocynkowane	



d x L	☒	Kod artykułu	d x L	☒	Kod artykułu	d x L	☒	Kod artykułu
ST3,5X9,5MM	1000	31825.035.009	ST4,2X13MM	1000	31825.042.013	ST4,8X13MM	1000	31825.048.013
ST3,5X13MM	1000	31825.035.013	ST4,2X16MM	1000	31825.042.016	ST4,8X16MM	1000	31825.048.016
ST3,5X16MM	1000	31825.035.016	ST4,2X19MM	1000	31825.042.019	ST4,8X19MM	1000	31825.048.019
ST3,5X19MM	1000	31825.035.019	ST4,2X25MM	1000	31825.042.025	ST4,8X22MM	1000	31825.048.022
						ST4,8X25MM	1000	31825.048.025

• Ostrzeżenie: cynkowanie elektrolityczne tych produktów może wywołać kruchość wodorową.

31820 Wkręty samowierzące z łbem walcowym wypukłym z gniazdem krzyżowym Phillips		J09B
Gwint	Samogwintujący	 
Materiał	Stal	
Obróbka powierzchni	Ocynkowane	

d x L	☒	Kod artykułu	d x L	☒	Kod artykułu	d x L	☒	Kod artykułu
ST3,5X9,5MM	2000	31820.035.009	ST3,9X25MM	2000	31820.039.025	ST4,2X38MM	2000	31820.042.038
ST3,5X13MM	2000	31820.035.013	ST4,2X9,5MM	2000	31820.042.009	ST4,8X13MM	2000	31820.048.013
ST3,5X16MM	2000	31820.035.016	ST4,2X13MM	2000	31820.042.013	ST4,8X16MM	2000	31820.048.016
ST3,5X19MM	2000	31820.035.019	ST4,2X16MM	2000	31820.042.016	ST4,8X19MM	2000	31820.048.019
ST3,5X25MM	2000	31820.035.025	ST4,2X19MM	2000	31820.042.019	ST4,8X25MM	2000	31820.048.025
ST3,9X16MM	2000	31820.039.016	ST4,2X25MM	2000	31820.042.025	ST4,8X32MM	1000	31820.048.032
ST3,9X19MM	2000	31820.039.019	ST4,2X32MM	2000	31820.042.032	ST4,8X50MM	1000	31820.048.050

• Ostrzeżenie: cynkowanie elektrolityczne tych produktów może wywołać kruchość wodorową.

31870	Wkręty samowiercące z łbem walcowym wypukłym z gniazdem krzyżowym Phillips	J09B
Gwint	Samogwintujący	
Materiał	Stal nierdzewna A2	
		 

d x L	☒	Kod artykułu	d x L	☒	Kod artykułu	d x L	☒	Kod artykułu
ST3,5X9,5MM	2000	31870.035.009	ST3,9X25MM	2000	31870.039.025	ST4,2X25MM	2000	31870.042.025
ST3,5X13MM	2000	31870.035.013						
ST3,5X19MM	2000	31870.035.019	ST4,2X13MM	2000	31870.042.013	ST4,8X16MM	2000	31870.048.016
			ST4,2X16MM	2000	31870.042.016	ST4,8X22MM	2000	31870.048.022
ST3,9X16MM	2000	31870.039.016	ST4,2X19MM	2000	31870.042.019			

ttap[®] drive

ttap[®] to innowacyjny nowy system wkręcania hex-lob z odrębnymi zaletami w porównaniu z wyjściowym systemem hex-lob (Torx[®]). ttap[®] jest systemem wkręcania przewidzianym do współpracy ze wszystkimi rodzajami systemów montażowych, w tym wymagających aplikacji profesjonalnych. Zachowywanie ustalonej pozycji w gnieździe i brak chybotania umożliwiają pracę jedną ręką bez stosowania magnetycznego uchwytu końcówki wkrętaka. System ttap[®] sprawia, że wkręcanie wkrętów jest łatwiejsze i tańsze.

Łatwiej:

- Dopasowane przyleganie; śrubokręt przylega dokładnie do gniazda
- Brak chybotania; śrubokręt nie chybotaje się w gnieździe, nie jest wypychany
- Nie ma potrzeby dociskania, nie ma potrzeby stosowania nacisku w ostatniej fazie dokręcania
- Możliwa jest praca jedną ręką
- Nie ma potrzeby stosowania magnetycznego chwytaka końcówki, a zatem nie występują żadne metalowe odpryski, które mogłyby zapchać końcówkę wkręcającą
- Śrubokręt wchodzi łatwo w gniazdo wkrętu

Tanio:

- Obniżenie zużycia narzędzia
- Zwiększona produktywność
- Obniżone ryzyko uszkodzenia pokrycia antykorozyjnego
- Wyższe zyski i zadowolenie z pracy

Zgodność z systemem Hex-Lob (Torx[®]):

- ttap[®] to w 100 % gniazdo typu hexalobular (gwiazdkowe sześcioramienne), kompatybilne z poprzednimi wersjami – lecz bez ich wad
- Można wykorzystywać końcówki Torx[®] na wkrętach ttap[®], stąd strategiczna łatwość przejścia na ttap[®]

Korzyści dla zdrowia:

- Nie ma potrzeby dociskania – ani potrzeby wywierania nacisku w końcowej fazie dokręcania na wkrętarce
- Porównując ttap[®] z gniazdami Phillips lub Pozidrive, główną zaletą jest to, że nie ma potrzeby stosowania tak wielkiego nacisku, aby wkręcić wkręt, stąd - ttap[®] obniża wysiłek pracownika

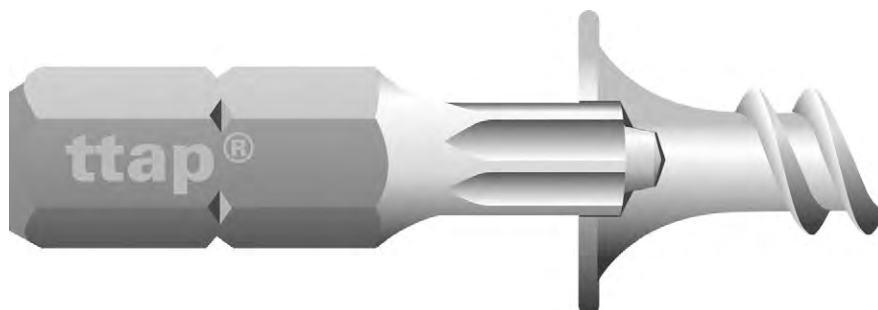

Wkręty z łbem walcowym ttap® MaxxFast St+A2

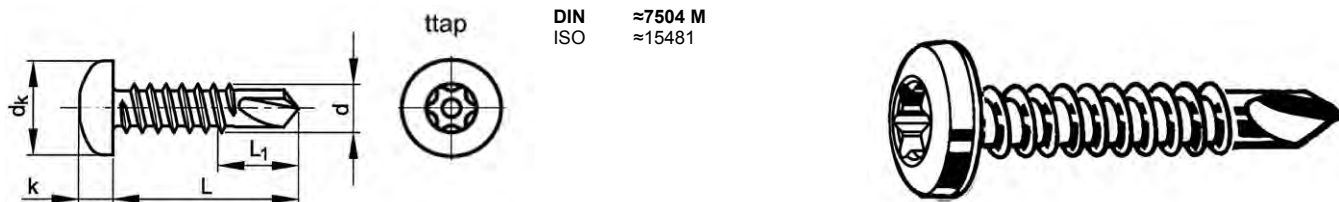

DIN ≈7504 M
ISO ≈15481

Informacje techniczne

d	dk	k	L ₁	Nr ttap
ST2.9	5.30 - 5.60	2.15 - 2.40	4	10
ST3.5	6.64 - 7.00	2.35 - 2.60	4	15
ST3.9	7.14 - 7.50	2.55 - 2.80	4.5	15
ST4.2	7.64 - 8.00	2.80 - 3.10	4.5	20
ST4.8	9.14 - 9.50	3.40 - 3.70	6.5	25
ST5.5	10.57 - 11.00	3.70 - 4.00	8	25

Grupy katalogowe

Gwint	Gniazdo	Materiał	Obróbka powierzchni	Kod	Strona
ST	ttap®	St	Ocynk.	30380	6-126
ST	ttap®	St.St. A2		30385	6-126

6

30380 MAXXFAST wkręt samowierzący soczewkowy z bitem ttap® MF1A

Gwint: Samogwintujący
Materiał: Stal
Obróbka powierzchni: Ocynkowane

d x L	☒	Kod artykułu	d x L	☒	Kod artykułu	d x L	☒	Kod artykułu
ST2,9X9,5MM	200	30380.029.009	ST3,9X25MM	200	30380.039.025	ST4,8X25MM	200	30380.048.025
ST2,9X13MM	200	30380.029.013	ST3,9X32MM	200	30380.039.032	ST4,8X32MM	200	30380.048.032
ST3,5X9,5MM	200	30380.035.009	ST4,2X13MM	200	30380.042.013	ST4,8X38MM	200	30380.048.038
ST3,5X13MM	200	30380.035.013	ST4,2X16MM	200	30380.042.016	ST4,8X45MM	200	30380.048.045
ST3,5X16MM	200	30380.035.016	ST4,2X19MM	200	30380.042.019	ST4,8X50MM	200	30380.048.050
ST3,5X19MM	200	30380.035.019	ST4,2X22MM	200	30380.042.022	ST5,5X19MM	200	30380.055.019
ST3,5X22MM	200	30380.035.022	ST4,2X25MM	200	30380.042.025	ST5,5X22MM	200	30380.055.022
ST3,5X25MM	200	30380.035.025	ST4,2X32MM	200	30380.042.032	ST5,5X25MM	200	30380.055.025
ST3,9X13MM	200	30380.039.013	ST4,8X13MM	200	30380.048.013	ST5,5X32MM	200	30380.055.032
ST3,9X16MM	200	30380.039.016	ST4,8X16MM	200	30380.048.016	ST5,5X38MM	200	30380.055.038
ST3,9X19MM	200	30380.039.019	ST4,8X19MM	200	30380.048.019	ST5,5X45MM	200	30380.055.045
ST3,9X22MM	200	30380.039.022	ST4,8X22MM	200	30380.048.022	ST5,5X50MM	200	30380.055.050

• Tylko pełne opakowania.

30385 MAXXFAST wkręt samowierzący soczewkowy z bitem ttap® MF1A

Gwint: Samogwintujący
Materiał: Stal nierdzewna A2

d x L	☒	Kod artykułu	d x L	☒	Kod artykułu	d x L	☒	Kod artykułu
ST2,9X9,5MM	200	30385.029.009	ST3,9X25MM	200	30385.039.025	ST4,8X25MM	200	30385.048.025
ST2,9X13MM	200	30385.029.013	ST3,9X32MM	200	30385.039.032	ST4,8X32MM	200	30385.048.032
ST3,5X9,5MM	200	30385.035.009	ST4,2X13MM	200	30385.042.013	ST4,8X38MM	200	30385.048.038
ST3,5X13MM	200	30385.035.013	ST4,2X16MM	200	30385.042.016	ST4,8X45MM	200	30385.048.045
ST3,5X16MM	200	30385.035.016	ST4,2X19MM	200	30385.042.019	ST4,8X50MM	200	30385.048.050
ST3,5X19MM	200	30385.035.019	ST4,2X22MM	200	30385.042.022	ST5,5X19MM	200	30385.055.019
ST3,5X22MM	200	30385.035.022	ST4,2X25MM	200	30385.042.025	ST5,5X22MM	200	30385.055.022
ST3,5X25MM	200	30385.035.025	ST4,2X32MM	200	30385.042.032	ST5,5X25MM	200	30385.055.025
ST3,9X13MM	200	30385.039.013	ST4,8X13MM	200	30385.048.013	ST5,5X32MM	200	30385.055.032
ST3,9X16MM	200	30385.039.016	ST4,8X16MM	200	30385.048.016	ST5,5X38MM	200	30385.055.038
ST3,9X19MM	200	30385.039.019	ST4,8X19MM	200	30385.048.019	ST5,5X45MM	200	30385.055.045
ST3,9X22MM	200	30385.039.022	ST4,8X22MM	200	30385.048.022	ST5,5X50MM	200	30385.055.050

30385 MAXXFAST wkręt samowierzący soczewkowy z bitem ttap®

- Tylko pełne opakowania.

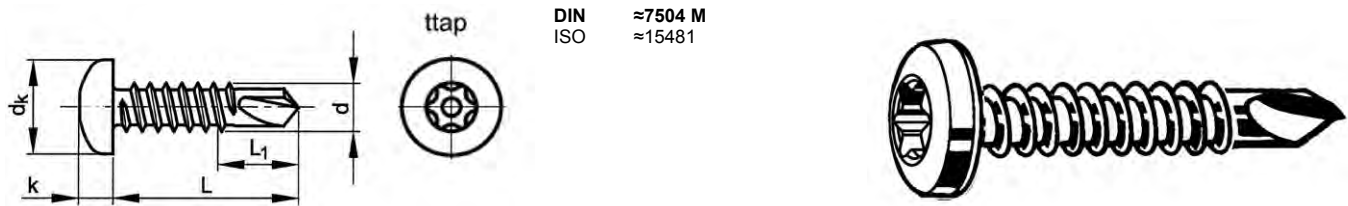
Wkręty z bitem walcowym ttap® MaxxFast A2

 DIN ≈7504 M
 ISO ≈15481

Informacje techniczne

d	dk	k	L ₁	Nr ttap
ST3.5	6.90 - 7.30	2.35	4	15
ST3.9	7.14 - 7.50	2.30	4.5	15
ST4.2	8.00 - 8.40	2.60	4.5	20
ST4.8	8.90 - 9.30	2.80	6.5	25
ST5.5	9.90 - 10.30	4.25	8	25

30390 MAXXFAST wkręt samowierzący soczewkowy z bitem ttap®
MF1A

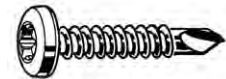
 Gwint Samogwintujący
 Materiał Bi-Metal

MAXXFAST
 PROFESSIONAL HARDWARE

d x L	☒	Kod artykułu	d x L	☒	Kod artykułu	d x L	☒	Kod artykułu
ST3,5X16MM	200	30390.035.016	ST4,2X16MM	200	30390.042.016	ST4,8X38MM	200	30390.048.038
ST3,5X19MM	200	30390.035.019	ST4,2X19MM	200	30390.042.019	ST4,8X45MM	200	30390.048.045
ST3,5X22MM	200	30390.035.022	ST4,2X22MM	200	30390.042.022	ST4,8X50MM	200	30390.048.050
ST3,5X25MM	200	30390.035.025	ST4,2X25MM	200	30390.042.025			
			ST4,2X32MM	200	30390.042.032	ST5,5X19MM	200	30390.055.019
ST3,9X16MM	200	30390.039.016				ST5,5X22MM	200	30390.055.022
ST3,9X19MM	200	30390.039.019	ST4,8X16MM	200	30390.048.016	ST5,5X25MM	200	30390.055.025
ST3,9X22MM	200	30390.039.022	ST4,8X19MM	200	30390.048.019	ST5,5X32MM	200	30390.055.032
ST3,9X25MM	200	30390.039.025	ST4,8X22MM	200	30390.048.022	ST5,5X38MM	200	30390.055.038
ST3,9X32MM	200	30390.039.032	ST4,8X25MM	200	30390.048.025	ST5,5X45MM	200	30390.055.045
			ST4,8X32MM	200	30390.048.032	ST5,5X50MM	200	30390.055.050

- Tylko pełne opakowania.

Wkręty samowierzące z łbem walcowym i kwadratowym gniazdem MaxxFast

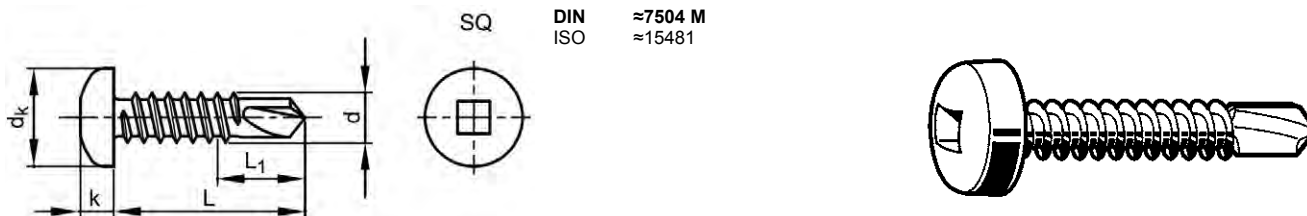

Informacje techniczne

d	dk	k	L ₁	Nr kwadratowy
ST3.5	6.64 - 7.00	2.35 - 2.60	4	1
ST3.9	7.14 - 7.50	2.55 - 2.80	4.5	2
ST4.2	7.64 - 8.00	2.80 - 3.10	5	2
ST4.8	9.14 - 9.50	3.40 - 3.70	6.5	2

30400 MAXXFAST wkręt samowierzący z łbem soczewkowym i gniazdem kwadratowym

MF1A

Gwint Samogwintujący
Materiał Stal
Obróbka powierzchni Ocynkowane

MAXXFAST
PROFESSIONAL HARDWARE



6

d x L	☒	Kod artykułu	d x L	☒	Kod artykułu	d x L	☒	Kod artykułu
ST3.5X9,5MM	200	30400.035.009	ST3.9X25MM	200	30400.039.025	ST4.8X13MM	200	30400.048.013
ST3.5X13MM	200	30400.035.013	ST3.9X32MM	200	30400.039.032	ST4.8X16MM	200	30400.048.016
ST3.5X16MM	200	30400.035.016				ST4.8X19MM	200	30400.048.019
ST3.5X19MM	200	30400.035.019	ST4.2X13MM	200	30400.042.013	ST4.8X22MM	200	30400.048.022
ST3.5X22MM	200	30400.035.022	ST4.2X16MM	200	30400.042.016	ST4.8X25MM	200	30400.048.025
ST3.5X25MM	200	30400.035.025	ST4.2X19MM	200	30400.042.019	ST4.8X32MM	200	30400.048.032
			ST4.2X22MM	200	30400.042.022	ST4.8X35MM	200	30400.048.035
ST3.9X13MM	200	30400.039.013	ST4.2X25MM	200	30400.042.025	ST4.8X38MM	200	30400.048.038
ST3.9X16MM	200	30400.039.016	ST4.2X30MM	200	30400.042.030	ST4.8X45MM	200	30400.048.045
ST3.9X19MM	200	30400.039.019	ST4.2X32MM	200	30400.042.032	ST4.8X50MM	200	30400.048.050
ST3.9X22MM	200	30400.039.022	ST4.2X40MM	200	30400.042.040			

- Tylko pełne opakowania.

Wkręty samowierzące z łbem walcowym wypukłym z gniazdem SR

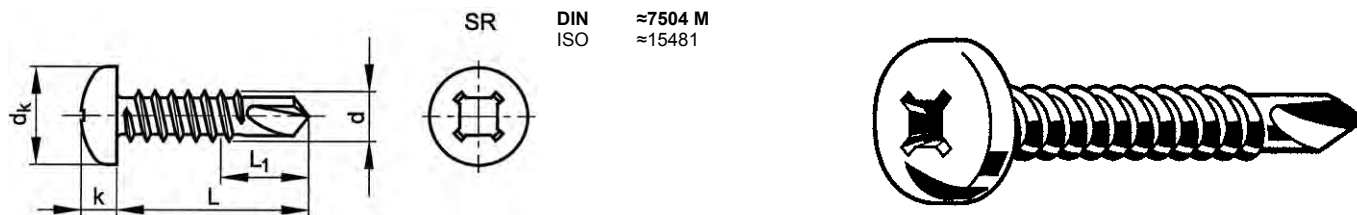

SR
DIN ≈7504 M
ISO ≈15481

Informacje techniczne

d	d _k	k	L ₁ ≈	Nr SR	P
ST3.5	7	2.6	5	1	1.3
ST3.9	7.5	2.95	6	2	1.4
ST4.2	8	3.25	7	2	1.4
ST4.8	9.5	3.7	8	2	1.6

- Wgłębienie SR to połączenie wgłębienia krzyżowego i kwadratowego. Montaż końcówką wkrętaka SR, patrz kody grup 31535 i 31640
- Maks. długość chwytu KL = L - L₁.
- Ostrzeżenie: cynkowanie elektrolityczne tych produktów może wywołać kruchość wodorową.



6

31480 SPEDEC SN Wkręty samowierzące z łbem walcowym wypukłym z gniazdem SR		J08A
Gwint	Samogwintujący	
Materiał	Stal	
Obróbka powierzchni	Ocynkowane	

d x L	☒	Kod artykułu	d x L	☒	Kod artykułu	d x L	☒	Kod artykułu
ST3,5X13MM	1000	31480.035.013	ST3,9X25MM	1000	31480.039.025	ST4,8X13MM	1000	31480.048.013
ST3,5X16MM	1000	31480.035.016	ST4,2X13MM	1000	31480.042.013	ST4,8X16MM	1000	31480.048.016
ST3,5X19MM	1000	31480.035.019	ST4,2X16MM	1000	31480.042.016	ST4,8X19MM	1000	31480.048.019
ST3,5X25MM	1000	31480.035.025	ST4,2X19MM	1000	31480.042.019	ST4,8X25MM	1000	31480.048.025
ST3,9X13MM	1000	31480.039.013	ST4,2X25MM	1000	31480.042.025	ST4,8X32MM	1000	31480.048.032
ST3,9X16MM	1000	31480.039.016	ST4,2X32MM	1000	31480.042.032	ST4,8X38MM	1000	31480.048.038
ST3,9X19MM	1000	31480.039.019						

Wkręty samowierzące z łbem walcowym wypukłym z kwadratowym gniazdem

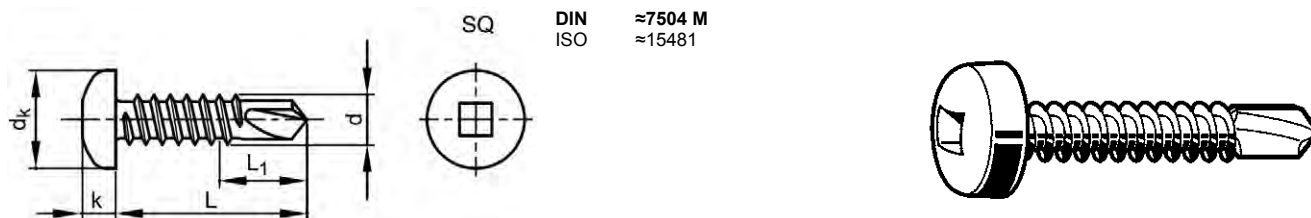

Informacje techniczne

d	d _k	k	L ₁ ≈	Nr kwadratowy	P
ST3.5	6.7	2.6	2	1	1.3
ST4.2	7.9	3.25	3	2	1.4
ST4.8	9.3	3.7	4	2	1.6

26820 Wkręty samowierzące z łbem walcowym wypukłym z kwadratowym gniazdem

J61A

Gwint Samogwintujący
Materiał Stal
Obróbka powierzchni Ocynkowane

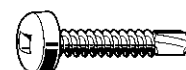

d x L	☒	Kod artykułu	d x L	☒	Kod artykułu	d x L	☒	Kod artykułu
3,5X9,5MM	200	26820.035.009	4,2X16MM	200	26820.042.016	4,2X32MM	200	26820.042.032
3,5X13MM	200	26820.035.013	4,2X19MM	200	26820.042.019	4,8X16MM	200	26820.048.016
4,2X13MM	200	26820.042.013	4,2X25MM	200	26820.042.025			

6

Wkręt samowierzący stożkowy z napędem krzyżowym

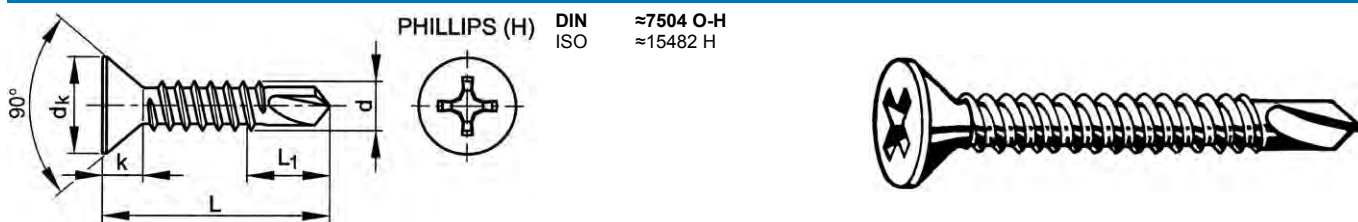

Informacje techniczne

d	d _k	k	L ₁	Nr wgłębienia krzyżowego
ST3.5	6.90 - 7.30	2.35	4	2
ST3.9	8.00 - 8.40	2.60	4.5	2
ST4.2	8.00 - 8.40	2.60	4.5	2
ST4.8	8.90 - 9.30	2.80	6.5	2
ST5.5	9.90 - 10.30	3.00	8	3

Grupy katalogowe

Gwint	Gniazdo	Materiał	Obróbka powierzchni	Kod	Strona
ST	Phillips	St	Ocynk.	30300	6-130
ST	Phillips	St.St. A2		30305	6-131
ST	Phillips	Bi-Metal		30310	6-131

30300 MAXXFAST wkręt samowierzący stożkowy z napędem Philips

MF1A

Gwint Samogwintujący
Materiał Stal
Obróbka powierzchni Ocynkowane

MAXXFAST
PROFESSIONAL HARDWARE



d x L	☒	Kod artykułu	d x L	☒	Kod artykułu	d x L	☒	Kod artykułu
ST3,5X13MM	200	30300.035.013	ST3,5X25MM	200	30300.035.025	ST3,9X19MM	200	30300.039.019
ST3,5X16MM	200	30300.035.016	ST3,9X13MM	200	30300.039.013	ST3,9X22MM	200	30300.039.022
ST3,5X19MM	200	30300.035.019	ST3,9X16MM	200	30300.039.016	ST3,9X25MM	200	30300.039.025
ST3,5X22MM	200	30300.035.022				ST3,9X32MM	200	30300.039.032

30300 MAXXFAST wkręt samowiercący stożkowy z napędem Philips

d x L	☒	Kod artykułu	d x L	☒	Kod artykułu	d x L	☒	Kod artykułu
ST4,2X16MM	200	30300.042.016	ST4,8X16MM	200	30300.048.016	ST4,8X50MM	200	30300.048.050
ST4,2X19MM	200	30300.042.019	ST4,8X19MM	200	30300.048.019	ST5,5X22MM	200	30300.055.022
ST4,2X22MM	200	30300.042.022	ST4,8X22MM	200	30300.048.022	ST5,5X25MM	200	30300.055.025
ST4,2X25MM	200	30300.042.025	ST4,8X25MM	200	30300.048.025	ST5,5X32MM	200	30300.055.032
ST4,2X32MM	200	30300.042.032	ST4,8X32MM	200	30300.048.032			
			ST4,8X38MM	200	30300.048.038			
			ST4,8X45MM	200	30300.048.045			

• Tylko pełne opakowania.

30305 MAXXFAST wkręt samowiercący stożkowy z napędem Philips
MF1A

Gwint Samogwintujący
Material Stal nierdzewna A2

MAXXFAST
PROFESSIONAL HARDWARE

d x L	☒	Kod artykułu	d x L	☒	Kod artykułu	d x L	☒	Kod artykułu
ST3,5X13MM	200	30305.035.013	ST3,9X32MM	200	30305.039.032	ST4,8X22MM	200	30305.048.022
ST3,5X16MM	200	30305.035.016	ST4,2X16MM	200	30305.042.016	ST4,8X25MM	200	30305.048.025
ST3,5X19MM	200	30305.035.019	ST4,2X19MM	200	30305.042.019	ST4,8X32MM	200	30305.048.032
ST3,5X22MM	200	30305.035.022	ST4,2X22MM	200	30305.042.022	ST4,8X38MM	200	30305.048.038
ST3,5X25MM	200	30305.035.025	ST4,2X25MM	200	30305.042.025	ST4,8X45MM	200	30305.048.045
ST3,9X13MM	200	30305.039.013	ST4,2X32MM	200	30305.042.032	ST4,8X50MM	200	30305.048.050
ST3,9X16MM	200	30305.039.016				ST5,5X22MM	200	30305.055.022
ST3,9X19MM	200	30305.039.019	ST4,8X16MM	200	30305.048.016	ST5,5X25MM	200	30305.055.025
ST3,9X22MM	200	30305.039.022	ST4,8X19MM	200	30305.048.019	ST5,5X32MM	200	30305.055.032
ST3,9X25MM	200	30305.039.025						

• Tylko pełne opakowania.

30310 MAXXFAST wkręt samowiercący stożkowy z napędem Philips
MF1A

Gwint Samogwintujący
Material Bi-Metal

MAXXFAST
PROFESSIONAL HARDWARE

d x L	☒	Kod artykułu	d x L	☒	Kod artykułu	d x L	☒	Kod artykułu
ST3,5X16MM	200	30310.035.016	ST4,2X16MM	200	30310.042.016	ST4,8X25MM	200	30310.048.025
ST3,5X19MM	200	30310.035.019	ST4,2X19MM	200	30310.042.019	ST4,8X32MM	200	30310.048.032
ST3,5X22MM	200	30310.035.022	ST4,2X22MM	200	30310.042.022	ST4,8X38MM	200	30310.048.038
ST3,5X25MM	200	30310.035.025	ST4,2X25MM	200	30310.042.025	ST4,8X45MM	200	30310.048.045
ST3,9X19MM	200	30310.039.019	ST4,2X32MM	200	30310.042.032	ST4,8X50MM	200	30310.048.050
ST3,9X22MM	200	30310.039.022	ST4,8X16MM	200	30310.048.016	ST5,5X22MM	200	30310.055.022
ST3,9X25MM	200	30310.039.025	ST4,8X19MM	200	30310.048.019	ST5,5X25MM	200	30310.055.025
ST3,9X32MM	200	30310.039.032	ST4,8X22MM	200	30310.048.022	ST5,5X32MM	200	30310.055.032

• Tylko pełne opakowania.

Wkręty samowierzące z łbem stożkowym płaskim z gniazdem krzyżowym

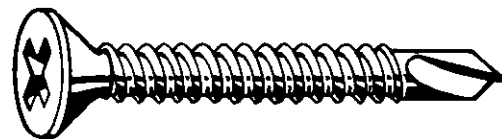
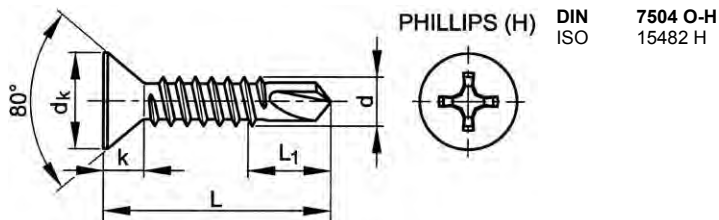

Informacje techniczne

d	d _k	L ₁ ≈	Nr wgłębienia krzyżowego	P
ST3.5	6.8	5	2	1.3
ST3.9	7.5	6	2	1.4
ST4.2	8.1	7	2	1.4
ST4.8	9.5	8	2	1.6
ST5.5	10.8	10	3	1.8
ST6.3	12.4	11	3	1.8

- Maks. długość uchwyty KL = L - L₁.

Grupy katalogowe

Gwint	Gniazdo	Materiał	Obróbka powierzchni	Kod	Strona
ST	Phillips	St	Ocynk.	31256	6-132
ST	Phillips	St	Ocynk.	31260	6-132
ST	Phillips	St	Ocynk.	31830	6-133
ST	Phillips	St.St. A2		31140	6-133
ST	Phillips	St.St. A2		31880	6-133

6

31256 SPEDEC SN Wkręty samowierzące z łbem stożkowym płaskim z gniazdem krzyżowym Phillips J09A

Gwint Samogwintujący
Materiał Stal
Obróbka powierzchni Ocynkowane



d x L	☒	Kod artykułu	d x L	☒	Kod artykułu	d x L	☒	Kod artykułu
ST3,5X13MM	200	31256.035.013	ST4,2X32MM	200	31256.042.032	ST4,8X32MM	200	31256.048.032
ST4,2X19MM	200	31256.042.019				ST4,8X38MM	200	31256.048.038

- Ostrzeżenie: cynkowanie elektrolityczne tych produktów może wywołać kruchość wodorową.



31260 SPEDEC SN Wkręty samowierzące z łbem stożkowym płaskim z gniazdem krzyżowym Phillips J09A

Gwint Samogwintujący
Materiał Stal
Obróbka powierzchni Ocynkowane





d x L	☒	Kod artykułu	d x L	☒	Kod artykułu	d x L	☒	Kod artykułu
ST3,5X13MM	1000	31260.035.013	ST3,9X32MM	1000	31260.039.032	ST4,8X38MM	500	31260.048.038
ST3,5X16MM	1000	31260.035.016				ST4,8X45MM	500	31260.048.045
ST3,5X19MM	1000	31260.035.019	ST4,2X16MM	1000	31260.042.016	ST4,8X50MM	500	31260.048.050
ST3,5X25MM	1000	31260.035.025	ST4,2X19MM	1000	31260.042.019			
			ST4,2X22MM	1000	31260.042.022	ST5,5X32MM	500	31260.055.032
ST3,9X13MM	1000	31260.039.013	ST4,2X25MM	1000	31260.042.025			
ST3,9X16MM	1000	31260.039.016	ST4,2X32MM	1000	31260.042.032	ST6,3X45MM	500	31260.063.045
ST3,9X19MM	1000	31260.039.019				ST6,3X50MM	500	31260.063.050
ST3,9X22MM	1000	31260.039.022	ST4,8X25MM	1000	31260.048.025	ST6,3X55MM	500	31260.063.055
ST3,9X25MM	1000	31260.039.025	ST4,8X32MM	1000	31260.048.032			

- Ostrzeżenie: cynkowanie elektrolityczne tych produktów może wywołać kruchość wodorową.

31830	SN Wkręty samowierzące z łbem stożkowym płaskim z gniazdem krzyżowym Phillips		J09B
Gwint	Samogwintujący		 
Materiał	Stal		
Obróbka powierzchni	O cynkowane		



d x L	☒	Kod artykułu	d x L	☒	Kod artykułu	d x L	☒	Kod artykułu
ST3,5X13MM	2000	31830.035.013	ST3,9X32MM	2000	31830.039.032	ST4,8X25MM	2000	31830.048.025
ST3,5X16MM	2000	31830.035.016				ST4,8X32MM	2000	31830.048.032
ST3,5X19MM	2000	31830.035.019	ST4,2X13MM	2000	31830.042.013	ST4,8X38MM	2000	31830.048.038
ST3,5X25MM	2000	31830.035.025	ST4,2X16MM	2000	31830.042.016	ST4,8X45MM	2000	31830.048.045
			ST4,2X19MM	2000	31830.042.019	ST4,8X50MM	2000	31830.048.050
ST3,9X13MM	2000	31830.039.013	ST4,2X25MM	2000	31830.042.025			
ST3,9X16MM	2000	31830.039.016	ST4,2X32MM	2000	31830.042.032	ST5,5X38MM	250	31830.055.038
ST3,9X19MM	2000	31830.039.019	ST4,2X38MM	2000	31830.042.038			
ST3,9X25MM	2000	31830.039.025						

• Ostrzeżenie: cynkowanie elektrolityczne tych produktów może wywołać kruchość wodorową.

31140	SPEDEC SN Wkręty samowierzące z łbem stożkowym płaskim z gniazdem krzyżowym Phillips		J09A
Gwint	Samogwintujący		 
Materiał	Stal nierdzewna A2		

d x L	☒	Kod artykułu	d x L	☒	Kod artykułu	d x L	☒	Kod artykułu
ST3,5X16MM	1000	31140.035.016	ST4,2X25MM	1000	31140.042.025	ST4,8X25MM	1000	31140.048.025
ST3,9X19MM	1000	31140.039.019						

6

31880	SN Wkręty samowierzące z łbem stożkowym płaskim z gniazdem krzyżowym Phillips		J09B
Gwint	Samogwintujący		 
Materiał	Stal nierdzewna A2		

d x L	☒	Kod artykułu	d x L	☒	Kod artykułu	d x L	☒	Kod artykułu
ST3,5X16MM	1000	31880.035.016	ST3,9X19MM	1000	31880.039.019	ST4,2X25MM	1000	31880.042.025

Wkręty z łbem stożkowym ttap®

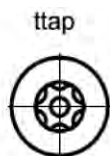
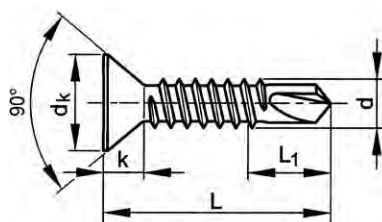

DIN ≈7504 O
ISO ≈15482

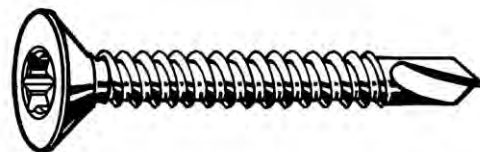

Informacje techniczne

d	d _k	k	L ₁	Nr ttap
ST3.5	6.90 - 7.30	2.35	4	15
ST3.9	7.14 - 7.50	2.60	4.5	20
ST4.2	8.00 - 8.40	2.60	4.5	20
ST4.8	8.90 - 9.30	2.80	6.5	25
ST5.5	9.90 - 10.30	3.00	8	25

Grupy katalogowe

Gwint	Gniazdo	Materiał	Obróbka powierzchni	Kod	Strona
ST	ttap®	St	Ocynk.	30350	6-134
ST	ttap®	St.St. A2		30355	6-134
ST	ttap®	Bi-Metal		30360	6-135

6

30350 MAXXFAST wkręt samowierzący stożkowy z bitem ttap®

MF1A

Gwint Samogwintujący
Materiał Stal
Obróbka powierzchni Ocynkowane

MAXXFAST
PROFESSIONAL HARDWARE



d x L	☒	Kod artykułu	d x L	☒	Kod artykułu	d x L	☒	Kod artykułu
ST3,5X13MM	200	30350.035.013	ST3,9X32MM	200	30350.039.032	ST4,8X22MM	200	30350.048.022
ST3,5X16MM	200	30350.035.016	ST4,2X16MM	200	30350.042.016	ST4,8X25MM	200	30350.048.025
ST3,5X19MM	200	30350.035.019	ST4,2X19MM	200	30350.042.019	ST4,8X32MM	200	30350.048.032
ST3,5X22MM	200	30350.035.022	ST4,2X22MM	200	30350.042.022	ST4,8X38MM	200	30350.048.038
ST3,5X25MM	200	30350.035.025	ST4,2X25MM	200	30350.042.025	ST4,8X45MM	200	30350.048.045
ST3,9X13MM	200	30350.039.013	ST4,2X32MM	200	30350.042.032	ST4,8X50MM	200	30350.048.050
ST3,9X16MM	200	30350.039.016				ST5,5X22MM	200	30350.055.022
ST3,9X19MM	200	30350.039.019	ST4,8X16MM	200	30350.048.016	ST5,5X25MM	200	30350.055.025
ST3,9X22MM	200	30350.039.022	ST4,8X19MM	200	30350.048.019	ST5,5X32MM	200	30350.055.032
ST3,9X25MM	200	30350.039.025						

• Tylko pełne opakowania.

30355 MAXXFAST wkręt samowierzący stożkowy z bitem ttap®

MF1A

Gwint Samogwintujący
Materiał Stal nierdzewna A2

MAXXFAST
PROFESSIONAL HARDWARE



d x L	☒	Kod artykułu	d x L	☒	Kod artykułu	d x L	☒	Kod artykułu
ST3,5X13MM	200	30355.035.013	ST3,9X32MM	200	30355.039.032	ST4,8X25MM	200	30355.048.025
ST3,5X16MM	200	30355.035.016	ST4,2X16MM	200	30355.042.016	ST4,8X32MM	200	30355.048.032
ST3,5X19MM	200	30355.035.019	ST4,2X19MM	200	30355.042.019	ST4,8X38MM	200	30355.048.038
ST3,5X22MM	200	30355.035.022	ST4,2X22MM	200	30355.042.022	ST4,8X45MM	200	30355.048.045
ST3,5X25MM	200	30355.035.025	ST4,2X25MM	200	30355.042.025	ST4,8X50MM	200	30355.048.050
ST3,9X13MM	200	30355.039.013	ST4,2X32MM	200	30355.042.032	ST5,5X22MM	200	30355.055.022
ST3,9X16MM	200	30355.039.016				ST5,5X25MM	200	30355.055.025
ST3,9X19MM	200	30355.039.019	ST4,8X16MM	200	30355.048.016	ST5,5X32MM	200	30355.055.032
ST3,9X22MM	200	30355.039.022	ST4,8X19MM	200	30355.048.019			
ST3,9X25MM	200	30355.039.025	ST4,8X22MM	200	30355.048.022			

• Tylko pełne opakowania.

30360	MAXXFAST wkręt samowiercący stożkowy z bitem ttap®			MF1A
Gwint	Samogwintujący			
Materiał	Bi-Metal			

d x L	☒	Kod artykułu	d x L	☒	Kod artykułu	d x L	☒	Kod artykułu
ST3,5X16MM	200	30360.035.016	ST4,2X16MM	200	30360.042.016	ST4,8X25MM	200	30360.048.025
ST3,5X19MM	200	30360.035.019	ST4,2X19MM	200	30360.042.019	ST4,8X32MM	200	30360.048.032
ST3,5X22MM	200	30360.035.022	ST4,2X22MM	200	30360.042.022	ST4,8X38MM	200	30360.048.038
ST3,5X25MM	200	30360.035.025	ST4,2X25MM	200	30360.042.025	ST4,8X45MM	200	30360.048.045
			ST4,2X32MM	200	30360.042.032	ST4,8X50MM	200	30360.048.050
ST3,9X19MM	200	30360.039.019						
ST3,9X22MM	200	30360.039.022	ST4,8X16MM	200	30360.048.016	ST5,5X22MM	200	30360.055.022
ST3,9X25MM	200	30360.039.025	ST4,8X19MM	200	30360.048.019	ST5,5X25MM	200	30360.055.025
ST3,9X32MM	200	30360.039.032	ST4,8X22MM	200	30360.048.022	ST5,5X32MM	200	30360.055.032

• Tylko pełne opakowania.

Wkręty z łbem sześciokątnym MaxxFast

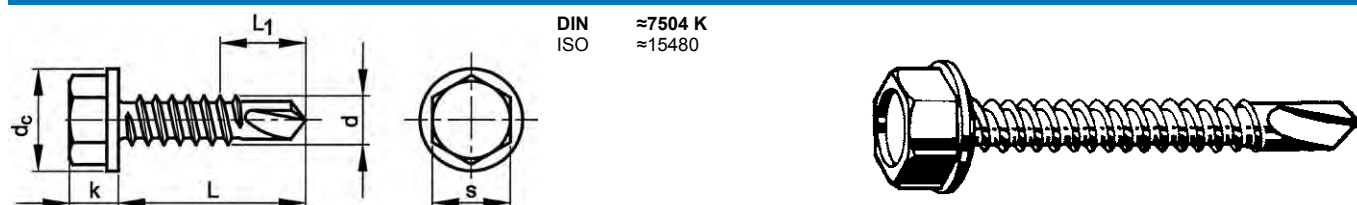

6

Informacje techniczne

d	d _c (maks.)	k (maks.) - 30410	k (maks.) - 30415	k (maks.) - 30420	L ₁	s
ST3.9	8.30	3.45	3.45	3.45	4.5	5.5
ST4.2	8.80	4.10	4.10	4.25	4.5	7.0
ST4.8	10.50	4.30	4.30	4.45	5.5	8.0
ST5.5	11	5.40	5.40	5.45	6.5	8.0
ST6.3	13.50	5.90	5.90	6.45	7.5	10.0

Grupy katalogowe

Gwint	Gniazdo	Materiał	Obróbka powierzchni	Kod	Strona
ST	Sześciokąt	St	Ocynk.	30410	6-135
ST	Sześciokąt	St.St. A2		30415	6-136
ST	Sześciokąt	Bi-Metal		30420	6-136

30410	MAXXFAST wkręt samowiercący z łbem sześciokątnym			MF1A
Gwint	Samogwintujący			
Materiał	Stal			
Obróbka powierzchni	Ocynkowane			

d x L	☒	Kod artykułu	d x L	☒	Kod artykułu	d x L	☒	Kod artykułu
ST3,9X19MM	200	30410.039.019	ST4,8X22MM	200	30410.048.022	ST5,5X50MM	200	30410.055.050
ST3,9X25MM	200	30410.039.025	ST4,8X25MM	200	30410.048.025			
ST3,9X32MM	200	30410.039.032	ST4,8X32MM	200	30410.048.032	ST6,3X19MM	200	30410.063.019
			ST4,8X38MM	200	30410.048.038	ST6,3X22MM	200	30410.063.022
ST4,2X13MM	200	30410.042.013	ST4,8X45MM	200	30410.048.045	ST6,3X25MM	200	30410.063.025
ST4,2X16MM	200	30410.042.016	ST4,8X50MM	200	30410.048.050	ST6,3X32MM	200	30410.063.032
ST4,2X19MM	200	30410.042.019				ST6,3X38MM	200	30410.063.038
ST4,2X22MM	200	30410.042.022	ST5,5X19MM	200	30410.055.019	ST6,3X45MM	200	30410.063.045
ST4,2X25MM	200	30410.042.025	ST5,5X22MM	200	30410.055.022	ST6,3X50MM	200	30410.063.050
ST4,2X32MM	200	30410.042.032	ST5,5X25MM	200	30410.055.025	ST6,3X60MM	200	30410.063.060
			ST5,5X32MM	200	30410.055.032	ST6,3X70MM	200	30410.063.070
ST4,8X13MM	200	30410.048.013	ST5,5X38MM	200	30410.055.038	ST6,3X80MM	100	30410.063.080
ST4,8X16MM	200	30410.048.016	ST5,5X45MM	200	30410.055.045	ST6,3X85MM	100	30410.063.085
ST4,8X19MM	200	30410.048.019						

• Tylko pełne opakowania.

30415	MAXXFAST wkręt samowierzący z łbem sześciokątnym	MF1A
Gwint	Samogwintujący	
Materiał	Stal nierdzewna A2	

d x L	✉	Kod artykułu	d x L	✉	Kod artykułu	d x L	✉	Kod artykułu
ST3,9X19MM	200	30415.039.019	ST4,8X22MM	200	30415.048.022	ST6,3X19MM	200	30415.063.019
ST3,9X25MM	200	30415.039.025	ST4,8X25MM	200	30415.048.025	ST6,3X22MM	200	30415.063.022
ST3,9X32MM	200	30415.039.032	ST4,8X32MM	200	30415.048.032	ST6,3X25MM	200	30415.063.025
ST4,2X13MM	200	30415.042.013	ST4,8X38MM	200	30415.048.038	ST6,3X32MM	200	30415.063.032
ST4,2X16MM	200	30415.042.016	ST4,8X45MM	200	30415.048.045	ST6,3X38MM	200	30415.063.038
ST4,2X19MM	200	30415.042.019	ST4,8X50MM	200	30415.048.050	ST6,3X45MM	200	30415.063.045
ST4,2X22MM	200	30415.042.022	ST5,5X19MM	200	30415.055.019	ST6,3X50MM	200	30415.063.050
ST4,2X25MM	200	30415.042.025	ST5,5X22MM	200	30415.055.022	ST6,3X60MM	200	30415.063.060
ST4,2X32MM	200	30415.042.032	ST5,5X25MM	200	30415.055.025	ST6,3X70MM	200	30415.063.070
ST4,8X13MM	200	30415.048.013	ST5,5X32MM	200	30415.055.032	ST6,3X80MM	100	30415.063.080
ST4,8X16MM	200	30415.048.016	ST5,5X38MM	200	30415.055.038	ST6,3X85MM	100	30415.063.085
ST4,8X19MM	200	30415.048.019	ST5,5X45MM	200	30415.055.045			
			ST5,5X50MM	200	30415.055.050			

• Tylko pełne opakowania.

30420	MAXXFAST wkręt samowierzący z łbem sześciokątnym	MF1A
Gwint	Samogwintujący	
Materiał	Bi-Metal	

d x L	✉	Kod artykułu	d x L	✉	Kod artykułu	d x L	✉	Kod artykułu
ST3,9X19MM	200	30420.039.019	ST4,8X25MM	200	30420.048.025	ST6,3X19MM	200	30420.063.019
ST3,9X25MM	200	30420.039.025	ST4,8X32MM	200	30420.048.032	ST6,3X22MM	200	30420.063.022
ST3,9X32MM	200	30420.039.032	ST4,8X38MM	200	30420.048.038	ST6,3X25MM	200	30420.063.025
ST4,2X16MM	200	30420.042.016	ST4,8X45MM	200	30420.048.045	ST6,3X32MM	200	30420.063.032
ST4,2X19MM	200	30420.042.019	ST4,8X50MM	200	30420.048.050	ST6,3X38MM	200	30420.063.038
ST4,2X22MM	200	30420.042.022	ST5,5X19MM	200	30420.055.019	ST6,3X45MM	200	30420.063.045
ST4,2X25MM	200	30420.042.025	ST5,5X22MM	200	30420.055.022	ST6,3X50MM	200	30420.063.050
ST4,2X32MM	200	30420.042.032	ST5,5X25MM	200	30420.055.025	ST6,3X60MM	200	30420.063.060
ST4,8X16MM	200	30420.048.016	ST5,5X32MM	200	30420.055.032	ST6,3X70MM	200	30420.063.070
ST4,8X19MM	200	30420.048.019	ST5,5X38MM	200	30420.055.038	ST6,3X80MM	100	30420.063.080
ST4,8X22MM	200	30420.048.022	ST5,5X45MM	200	30420.055.045	ST6,3X85MM	100	30420.063.085
			ST5,5X50MM	200	30420.055.050			

• Tylko pełne opakowania.

Wkręty samowierzące z łbem sześciokątnym z kołnierzem

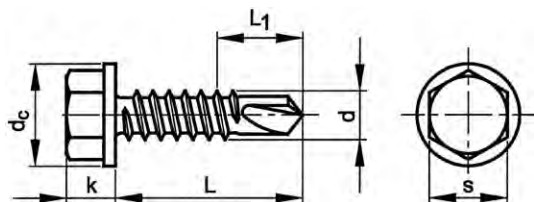

DIN 7504 K
ISO 15480



Informacje techniczne

d	d _c	k (maks.)	L ₁ ≈	P	s
ST3.5	8.3	3.4	6.8	1.3	5.5
ST4.2	8.8	4.25	7	1.4	7
ST4.8	10.5	4.45	8	1.6	8
ST5.5	11	5.45	10	1.8	8
ST6.3	13.2	6.45	11	1.8	10

- Maks. długość uchwyty KL = L - L₁.

Grupy katalogowe

Gwint	Gniazdo	Materiał	Obróbka powierzchni	Kod	Strona
ST	Sześciokąt	St	Ocynk.	31235	6-137
ST	Sześciokąt	St	Ocynk.	31230	6-137
ST	Sześciokąt	St	Ocynk.	31815	6-138
ST	Sześciokąt	St	Ocynk.	31810	6-138
ST	Sześciokąt	St.St. A2		31100	6-138
ST	Sześciokąt	St.St. A2		31860	6-138

6

31235 SPEDEC SN Wkręty samowierzące z łbem sześciokątnym z kołnierzem

J09A

Gwint Samogwintujący
Materiał Stal
Obróbka powierzchni Ocynkowane



d x L	☒	Kod artykułu	d x L	☒	Kod artykułu	d x L	☒	Kod artykułu
ST4,2X13MM	200	31235.042.013	ST4,8X25MM	200	31235.048.025	ST5,5X32MM	100	31235.055.032
ST4,2X16MM	200	31235.042.016	ST4,8X32MM	200	31235.048.032	ST6,3X19MM	200	31235.063.019
ST4,2X19MM	200	31235.042.019	ST4,8X38MM	100	31235.048.038	ST6,3X22MM	200	31235.063.022
ST4,2X25MM	200	31235.042.025	ST4,8X45MM	100	31235.048.045	ST6,3X25MM	200	31235.063.025
ST4,2X32MM	200	31235.042.032	ST4,8X50MM	100	31235.048.050	ST6,3X32MM	100	31235.063.032
ST4,8X13MM	200	31235.048.013	ST5,5X19MM	200	31235.055.019	ST6,3X38MM	100	31235.063.038
ST4,8X16MM	200	31235.048.016	ST5,5X22MM	200	31235.055.022	ST6,3X45MM	100	31235.063.045
ST4,8X19MM	200	31235.048.019	ST5,5X25MM	200	31235.055.025	ST6,3X50MM	100	31235.063.050
ST4,8X22MM	200	31235.048.022						

- Ostrzeżenie: cynkowanie elektrolityczne tych produktów może wywołać kruchość wodorową.

31230 SPEDEC SN Wkręty samowierzące z łbem sześciokątnym z kołnierzem



J09A

Gwint Samogwintujący
Materiał Stal
Obróbka powierzchni Ocynkowane





d x L	☒	Kod artykułu	d x L	☒	Kod artykułu	d x L	☒	Kod artykułu
ST4,2X13MM	1000	31230.042.013	ST4,8X25MM	1000	31230.048.025	ST5,5X38MM	500	31230.055.038
ST4,2X16MM	1000	31230.042.016	ST4,8X32MM	1000	31230.048.032	ST6,3X19MM	500	31230.063.019
ST4,2X19MM	1000	31230.042.019	ST4,8X38MM	500	31230.048.038	ST6,3X22MM	500	31230.063.022
ST4,2X25MM	1000	31230.042.025	ST4,8X45MM	500	31230.048.045	ST6,3X25MM	500	31230.063.025
ST4,2X32MM	1000	31230.042.032	ST4,8X50MM	500	31230.048.050	ST6,3X32MM	500	31230.063.032
ST4,8X13MM	1000	31230.048.013	ST5,5X19MM	1000	31230.055.019	ST6,3X38MM	500	31230.063.038
ST4,8X16MM	1000	31230.048.016	ST5,5X22MM	1000	31230.055.022	ST6,3X45MM	500	31230.063.045
ST4,8X19MM	1000	31230.048.019	ST5,5X25MM	500	31230.055.025	ST6,3X50MM	500	31230.063.050
ST4,8X22MM	1000	31230.048.022	ST5,5X32MM	500	31230.055.032			

- Ostrzeżenie: cynkowanie elektrolityczne tych produktów może wywołać kruchość wodorową.

31815	Wkręty samowierzące z łbem sześciokątnym z kołnierzem	J09B
Gwint	Samogwintujący	
Materiał	Stal	
Obróbka powierzchni	Ocynkowane	
		



d x L	☒	Kod artykułu	d x L	☒	Kod artykułu	d x L	☒	Kod artykułu
ST3,5X9,5MM	1000	31815.035.009	ST4,2X38MM	1000	31815.042.038	ST5,5X32MM	500	31815.055.032
ST3,5X13MM	1000	31815.035.013				ST5,5X50MM	500	31815.055.050
ST3,5X16MM	1000	31815.035.016	ST4,8X13MM	1000	31815.048.013			
ST3,5X19MM	1000	31815.035.019	ST4,8X16MM	1000	31815.048.016	ST6,3X16MM	500	31815.063.016
ST3,5X25MM	1000	31815.035.025	ST4,8X19MM	1000	31815.048.019	ST6,3X19MM	500	31815.063.019
			ST4,8X25MM	1000	31815.048.025	ST6,3X25MM	500	31815.063.025
ST4,2X13MM	1000	31815.042.013	ST4,8X32MM	1000	31815.048.032	ST6,3X32MM	500	31815.063.032
ST4,2X16MM	1000	31815.042.016	ST4,8X38MM	1000	31815.048.038	ST6,3X38MM	500	31815.063.038
ST4,2X19MM	1000	31815.042.019				ST6,3X50MM	500	31815.063.050
ST4,2X25MM	1000	31815.042.025	ST5,5X19MM	1000	31815.055.019	ST6,3X60MM	500	31815.063.060
ST4,2X32MM	1000	31815.042.032	ST5,5X25MM	500	31815.055.025			

• Ostrzeżenie: cynkowanie elektrolityczne tych produktów może wywołać kruchość wodorową.



31810	Wkręty samowierzące z łbem sześciokątnym z kołnierzem	J09B
Gwint	Samogwintujący	
Materiał	Stal	
Obróbka powierzchni	Ocynkowane	
		

d x L	☒	Kod artykułu	d x L	☒	Kod artykułu	d x L	☒	Kod artykułu
ST4,2X13MM	2000	31810.042.013	ST4,8X16MM	2000	31810.048.016	ST5,5X25MM	1000	31810.055.025
ST4,2X16MM	2000	31810.042.016	ST4,8X19MM	2000	31810.048.019			
ST4,2X19MM	2000	31810.042.019	ST4,8X25MM	2000	31810.048.025	ST6,3X19MM	1000	31810.063.019
ST4,2X25MM	2000	31810.042.025	ST4,8X32MM	2000	31810.048.032	ST6,3X25MM	1000	31810.063.025
ST4,2X32MM	2000	31810.042.032	ST4,8X38MM	2000	31810.048.038	ST6,3X32MM	1000	31810.063.032
						ST6,3X38MM	1000	31810.063.038
ST4,8X13MM	2000	31810.048.013	ST5,5X19MM	2000	31810.055.019	ST6,3X50MM	1000	31810.063.050

• Ostrzeżenie: cynkowanie elektrolityczne tych produktów może wywołać kruchość wodorową.

31100	SPEDEC SN Wkręty samowierzące z łbem sześciokątnym z kołnierzem	J09A
Gwint	Samogwintujący	
Materiał	Stal nierdzewna A2	
		

d x L	☒	Kod artykułu	d x L	☒	Kod artykułu	d x L	☒	Kod artykułu
ST4,2X25MM	1000	31100.042.025	ST4,8X32MM	1000	31100.048.032	ST6,3X22MM	1000	31100.063.022
ST4,8X19MM	1000	31100.048.019						

31860	Wkręty samowierzące z łbem sześciokątnym z kołnierzem	J09B
Gwint	Samogwintujący	
Materiał	Stal nierdzewna A2	
		

d x L	☒	Kod artykułu	d x L	☒	Kod artykułu	d x L	☒	Kod artykułu
ST4,2X25MM	2000	31860.042.025	ST4,8X32MM	1000	31860.048.032	ST5,5X22MM	1000	31860.055.022
ST4,8X19MM	1000	31860.048.019						

Samowierzący wkręt z wgłębieniem krzyżowym do ścianek tylnich



Informacje techniczne

d	dk	k	Nr wgłębienia krzyżowego
4.2	11	2.5	2

Grupy katalogowe

Gwint	Gniazdo	Materiał	Obróbka powierzchni	Kod	Strona
ST	Phillips	St	Ocynk.	29580	6-139
ST	Phillips	St	Ocynk. czrn. pas.	29581	6-139

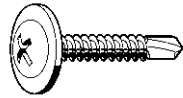
29580	Samowierzący wkręt z wgłębieniem krzyżowym do ścianek tylnich	K04A
Gwint	Samogwintujący	
Materiał	Stal	
Obróbka powierzchni	Ocynkowane	
		

d x L	☒	Kod artykułu	d x L	☒	Kod artykułu	d x L	☒	Kod artykułu
4,2X13MM	200	29580.042.013	4,2X19MM	200	29580.042.019	4,2X25MM	200	29580.042.025
4,2X16MM	200	29580.042.016						

- Ostrzeżenie: cynkowanie elektrolityczne tych produktów może wywołać kruchość wodorową.

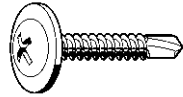
29581	Samowierzący wkręt z wgłębieniem krzyżowym do ścianek tylnich	K04A
Gwint	Samogwintujący	
Materiał	Stal	
Obróbka powierzchni	Ocynkowane, po czarnej pasywacji	
		

d x L	☒	Kod artykułu	d x L	☒	Kod artykułu	d x L	☒	Kod artykułu
4,2X13MM	200	29581.042.013	4,2X19MM	200	29581.042.019	4,2X25MM	200	29581.042.025
4,2X16MM	200	29581.042.016						

- Ostrzeżenie: cynkowanie elektrolityczne tych produktów może wywołać kruchość wodorową.

Wkręty samowierzące z łbem grzybkowym z gniazdem SR



Informacje techniczne

d x L	A	B	C	D	d _k	E	F	G	L ₁ ≈	Nr SR	P
ST4.8x16	9000	6000	6.5	1	13	3	1.5	4	9	2	1.6
ST4.8x19	9000	6000	6.5	1	15	3	1.5	4	9	2	1.6
ST4.8x25	9000	6000	6.5	1	15	3	1.5	4	9	2	1.6
ST4.8x32	9000	6000	6.5	1	15	3	1.5	4	9	2	1.6

- A = Obciążenie niszczące min. w N.
- B = Wytrzymałość na ścinanie min. w N.
- C = Moment końcowy w Nm.
- D = Możliwość wiercenia w stalowych poprzecznicach (min.).
- E = Możliwość wiercenia w stalowych poprzecznicach (max.).
- F = Możliwość wiercenia w aluminiowych poprzecznicach (min.).
- G = Możliwość wiercenia w aluminiowych poprzecznicach (max.).
- Nadaje się do bezpośredniego montażu sklejki i płyty wiórowej na aluminiowych i stalowych poprzecznicach.
- Maks. długość chwytu KL = L - L₁
- Wgłębienie SR to połączenie wgłębienia krzyżowego i kwadratowego. Montaż i końcówką wkrętaka SR, patrz kody grup 31630 i 31640.
- Stal o wytrzymałości maks. 540 N/mm².

6

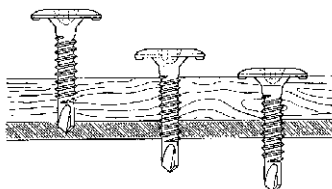

31445 SPEDEC SI Wkręty z łbem grzybkowym gniazdownym SR

J12A

Gwint Samogwintujący
Materiał Stal
Obróbka powierzchni Ocynkowane

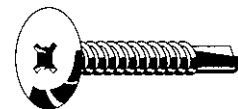

d x L	☒	Kod artykułu	d x L	☒	Kod artykułu	d x L	☒	Kod artykułu
ST4,8X16MM	1000	31445.048.016	ST4,8X25MM	1000	31445.048.025	ST4,8X32MM	1000	31445.048.032
ST4,8X19MM	1000	31445.048.019						

- Ostrzeżenie: cynkowanie elektrolityczne tych produktów może wywołać kruchość wodorową.

Wkręty z zębem stożkowym ze skrzydełkami i napędem ttap® MaxxFast

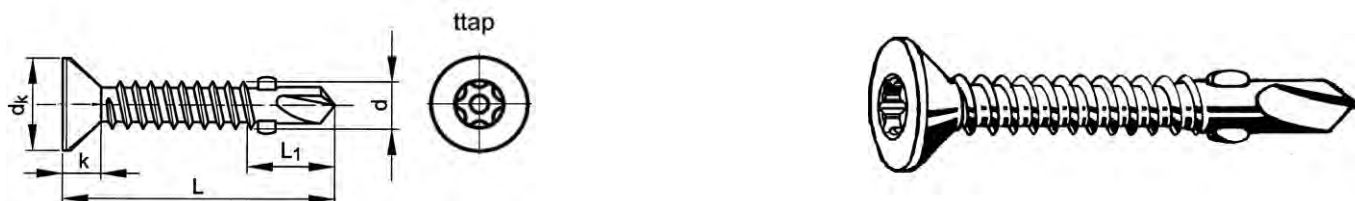

Informacje techniczne

d	d _k	k	L ₁	Nr ttap
ST3.9	7.14 - 7.50	2.30	4.5	20
ST4.2	8.00 - 8.40	2.60	4.5	20
ST4.8	8.90 - 9.30	2.80	6.5	25
ST5.5	9.90 - 10.30	3.00	8	25
ST6.3	10.90 - 11.30	3.15	9	25

Grupy katalogowe

Gwint	Gniazdo	Materiał	Obróbka powierzchni	Kod	Strona
ST	ttap®	St	Ocynk.	30365	6-141
ST	ttap®	Bi-Metal		30375	6-141

30365 MAXXFAST wkręt samowierzący stożkowy ze skrzydełkami i bitem ttap®

MF1A

Gwint Samogwintujący
Materiał Stal
Obróbka powierzchni Ocynkowane

MAXXFAST
PROFESSIONAL HARDWARE



d x L	☒	Kod artykułu	d x L	☒	Kod artykułu	d x L	☒	Kod artykułu
ST3.9X25MM	200	30365.039.025	ST4.8X45MM	200	30365.048.045	ST6.3X38MM	200	30365.063.038
ST4.2X32MM	200	30365.042.032	ST4.8X50MM	200	30365.048.050	ST6.3X50MM	200	30365.063.050
ST4.8X32MM	200	30365.048.032	ST5.5X38MM	200	30365.055.038	ST6.3X60MM	200	30365.063.060
ST4.8X38MM	200	30365.048.038	ST5.5X45MM	200	30365.055.045			
			ST5.5X50MM	200	30365.055.050			

- Tylko pełne opakowania.

30375 MAXXFAST wkręt samowierzący stożkowy ze skrzydełkami i bitem ttap®

MF1A

Gwint Samogwintujący
Materiał Bi-Metal

MAXXFAST
PROFESSIONAL HARDWARE

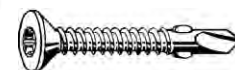

d x L	☒	Kod artykułu	d x L	☒	Kod artykułu	d x L	☒	Kod artykułu
ST3.9X25MM	200	30375.039.025	ST4.8X45MM	200	30375.048.045	ST6.3X38MM	200	30375.063.038
ST4.2X32MM	200	30375.042.032	ST4.8X50MM	200	30375.048.050	ST6.3X50MM	200	30375.063.050
ST4.8X32MM	200	30375.048.032	ST5.5X38MM	200	30375.055.038	ST6.3X60MM	200	30375.063.060
ST4.8X38MM	200	30375.048.038	ST5.5X45MM	200	30375.055.045			
			ST5.5X50MM	200	30375.055.050			

- Tylko pełne opakowania.

Wkręty samowierzące z łbem stożkowym płaskim, ze skrzydełkami, z gniazdem Torx®, metryczne

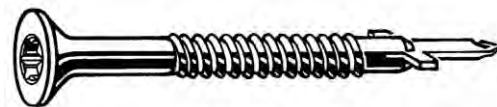
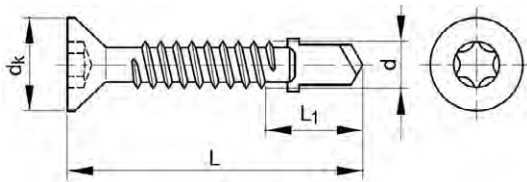

Informacje techniczne

d	A	B	C	D	d _k	E	F	G	L ₁ ≈	Nasadka	P
ST6.3	17000	10000	16	3	12	6	3	6	25	T30	1.8

- A = Obciążenie niszczące min. w N.
- B = Wytrzymałość na ścinanie min. w N.
- C = Moment końcowy w Nm.
- D = Możliw. wiercenia w stalowych poprzecznicach St37 (min.).
- E = Możliw. wiercenia w stalowych poprzecznicach St37 (max.).
- F = Możliw. wiercenia w stalowych poprzecznicach St52 (min.).
- G = Możliw. wiercenia w stalowych poprzecznicach St52 (max.).
- Nadaje się do bezpośredniego montażu belek z miękkiego drewna na stalowych poprzecznicach.
- Maks. długość chwytu KL = L - L₁
- St52: Ze stali wyższej jakości zmniejszana jest maks. grubość wiercenia.

Specjalne właściwości wkrętów samowierzących FABORY-SPEDEC typu **SCT**:

- normalne ostrze wierzące zastąpione zostało przez płytkę wierzącą ze specjalnej stali hartowanej. Typ ten zapewnia, gdy wkręty samowierzące SC powodują problemy, że zakres zastosowania może zostać znacznie poszerzony.
- w jednej pojedynczej operacji: rozpoczęcie montażu, wiercenie w drewnie, wiercenie w stali, łopatki odłamują się, formowanie gwintu, montaż zakończony, patrz na kolejność montażu poniżej.
- montaż z elektrycznymi narzędziami nastawczymi typu CF 250(P), patrz grupa kodów 31570 (31572).

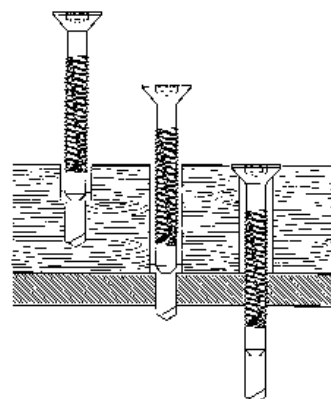

6

31460 SPEDEC SCT Wkręty z łbem stożkowym gniazdowym ze skrzydełkami Torx®		J10A
Gwint	Samogwintujący	
Materiał	Stal	
Obróbka powierzchni	Ocynkowane	

d x L	☒	Kod artykułu	d x L	☒	Kod artykułu	d x L	☒	Kod artykułu
ST6,3X50MM	500	31460.063.050	ST6,3X70MM	500	31460.063.070	ST6,3X90MM	250	31460.063.090
ST6,3X60MM	500	31460.063.060	ST6,3X80MM	500	31460.063.080			

- Ostrzeżenie: cynkowanie elektrolityczne tych produktów może wywołać kruchość wodorową.

Wkręty samowierzące z łbem stożkowym płaskim, ze skrzydełkami, z gniazdem Torx®

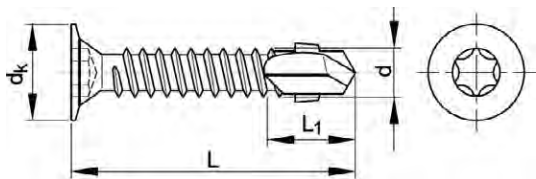

Informacje techniczne

d	A	B	C	D	dk	E	L ₁ ≈	Nr Torx®	P
ST5.5	10000	8000	10	2	12	5	15	T30	1.8

- A = Obciążenie niszczące min. w N.
- B = Wytrzymałość na ścinanie min. w N.
- C = Moment końcowy w Nm.
- D = Możliw. wiercenia w stalowych poprzecznicach St37 (min.).
- E = Możliw. wiercenia w stalowych poprzecznicach St37 (max.).
- Nadaje się do bezpośredniego montażu belek z miękkiego drewna na stalowych poprzecznicach.
- Maks. długość chwytu KL = L - L1St37
- Ze stałą wyższej jakości zmniejszana jest maks. grubość wiercenia.

Specjalne właściwości wkrętów samowierzących FABORY-SPEDEC typu **SC**:

- z prasowaną końcówką wierzącą
- z podwójnym łbem stożkowym płaskim (31411) dla lepszego zachowania się powierzchni w miękkim drewnie
- z żeberkami pod łbem do wykonywania pogłębień stożkowych w drewnie
- montaż z elektrycznym narzędziem nastawczym typu CF 250(P), patrz grupa kodów 31570 (31572).

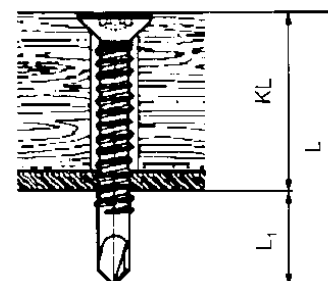

6

Grupy katalogowe

Gwint	Gniazdo	Materiał	Obróbka powierzchni	Kod	Strona
ST	Torx®	St	Ocynk.	31416	6-143
ST	Torx®	St	Ocynk. podwójny łeb stożkowy	31411	6-143

31416 SPEDEC SC Wkręty samowierzące z łbem stożkowym płaskim, ze skrzydełkami, z gniazdem Torx®

J10A

Gwint Samogwintujący
Materiał Stal
Obróbka powierzchni Ocynkowane

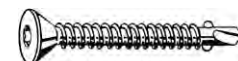

d x L	Kod artykułu	d x L	Kod artykułu	d x L	Kod artykułu
ST5,5X38MM	1000 31416.055.038	ST5,5X50MM	1000 31416.055.050	ST5,5X55MM	1000 31416.055.055
ST5,5X45MM	1000 31416.055.045				

- Ostrzeżenie: cynkowanie elektrolityczne tych produktów może wywołać kruchość wodorową.

31411 SPEDEC SC Wkręty samowierzące z łbem stożkowym płaskim, ze skrzydełkami, z gniazdem Torx®

J10A

Gwint Samogwintujący
Materiał Stal
Obróbka powierzchni Ocynkowane



d x L	Kod artykułu	d x L	Kod artykułu	d x L	Kod artykułu
ST5,5X38MM	1000 31411.055.038	ST5,5X50MM	1000 31411.055.050	ST5,5X60MM	1000 31411.055.060
ST5,5X45MM	1000 31411.055.045	ST5,5X55MM	1000 31411.055.055		

- Ostrzeżenie: cynkowanie elektrolityczne tych produktów może wywołać kruchość wodorową.

Wkręty samowierzące z łbem stożkowym płaskim, ze skrzydełkami, z gniazdem Torx®, UNC

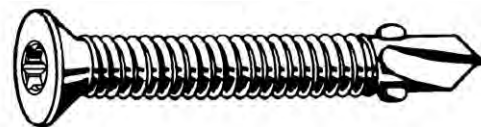
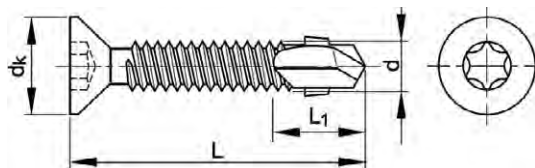

Informacje techniczne

d	A	B	C	D	d _k	E	L ₁ ≈	Nr Torx®	Zwoje gwintu na cal
U6.3 (1/4)	17000	10000	16	2.5	12	6	16	T30	20

- A = Obciążenie niszczące min. w N.
- B = Wytrzymałość na ścinanie min. w N.
- C = Moment końcowy w Nm.
- D = Możliw. wiercenia w stalowych poprzecznicach St37 (min.).
- E = Możliw. wiercenia w stalowych poprzecznicach St37 (max.).
- Nadaje się do bezpośredniego montażu belek z miękkiego drewna na stalowych poprzecznicach.
- Maks. długość chwytu KL = L - L1St37
- Ze stałą wyższej jakości zmniejszana jest maks. grubość wiercenia.

Specjalne właściwości wkrętów samowierzących FABORY-SPEDEC typu SC:
- z **zeberkami pod łbem** do wykonywania pogłębień stożkowych w drewnie

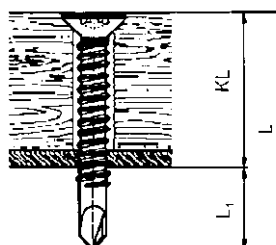

6

31426 SPEDEC SC Wkręty samowierzące z łbem stożkowym płaskim, ze skrzydełkami, z gniazdem Torx®, UNC		J10A
Gwint	Całowy, zunifikowany grubozwojny (UNC)	
Materiał	Stal	
Obróbka powierzchni	Ocynkowane	

d x L	☒	Kod artykułu	d x L	☒	Kod artykułu	d x L	☒	Kod artykułu
U6,3X45MM	1000	31426.063.045	U6,3X60MM	1000	31426.063.060	U6,3X80MM	500	31426.063.080
U6,3X50MM	1000	31426.063.050	U6,3X65MM	1000	31426.063.065	U6,3X85MM	500	31426.063.085
U6,3X55MM	1000	31426.063.055	U6,3X70MM	500	31426.063.070			

- Ostrzeżenie: cynkowanie elektrolityczne tych produktów może wywołać kruchość wodorową.

Wkręty samowierzące z łbem stożkowym płaskim z gniazdem krzyżowym, ze skrzydełkami



Informacje techniczne

d	A	B	C	D	d _k	E	L ≈	Nr wgłębienia krzyżowego	P
ST4.2	7500	3500	5	0.7	8.1	2	9	2	1.4
ST4.8	11000	6000	8.5	2	9.5	3	10	2	1.6

- A = Obciążenie niszczące min. w N.
- B = Wytrzymałość na ścinanie min. w N.
- C = Moment końcowy w Nm.
- D = Możliwość wiercenia w stalowych poprzecznicach St37 (min.).
- E = Możliwość wiercenia w stalowych poprzecznicach St37 (max.).
- Nadaje się do bezpośredniego montażu belek z miękkiego drewna na stalowych poprzecznic.
- Maks. długość chwytu $KL = L - L_1$
- St37: Ze stałą wyższej jakości zmniejszana jest maks. grubość wiercenia.

Specjalne właściwości wkrętów samowierzących FABORY-SPEDEC typu SC:
- z żeberkami pod łbem do wykonywania pogłębień stożkowych w drewnie

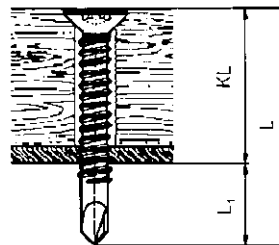

6

31282		SPEDEC SN Wkręty samowierzące z łbem stożkowym płaskim z gniazdem krzyżowym Phillips, ze skrzydełkami						J10A
Gwint	Samogwintujący							
Materiał	Stal							
Obróbka powierzchni	Ocynkowane							



d x L	☒	Kod artykułu	d x L	☒	Kod artykułu	d x L	☒	Kod artykułu
ST4,2X30MM	500	31282.042.030	ST4,8X35MM	500	31282.048.035	ST4,8X45MM	500	31282.048.045
ST4,2X40MM	500	31282.042.040				ST4,8X65MM	500	31282.048.065

- Ostrzeżenie: cynkowanie elektrolityczne tych produktów może wywołać kruchość wodorową.

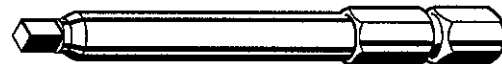

Grupy katalogowe

Gniazdo		Kod	Strona
SR		31535	6-146
	CF 250	31570	6-146
	CF 250P	31572	6-146
Sześciokąt		31536	6-147

31535 SPEDEC Wymienne ostrze wkrętaka SR J90A



Typ	☒	Kod artykułu	Typ	☒	Kod artykułu
SR2-49	2	31535.001.770	SR1-49	2	31535.001.771

- Z trzonkiem sześciokątnym 1/4 cala.
- Odpowiedni dla wkrętów samowiercących z wgłębieniem SR (połączenie wgłębienia krzyżowego i kwadratowego).
- Długość 49 mm.
- Więcej bitów dostępnych www.fabory.com

31570 SPEDEC Narzędzie osadzające typ CF 250 J91A

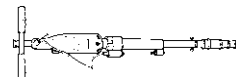

Typ	☒	Kod artykułu
Kompletne narzędzie	1	31570.001.770

- Odpowiednie dla wkrętów samowiercących typ SC (z Torx® TX30) i typ SCT (z Torx® TX30).
- Wkrętak producenta: Fein ASze 648 d.
- Moc pobierana 740 W.
- Napięcie 220 V/50 Hz.
- Obroty 0 - 1560 obr./min. (obciążony) i 0-2600 obr./min. (nieobciążony).
- Łączna długość 1080 mm.
- Waga 9,8 kg.
- Obracający się w prawo.
- Regulowana głębokość zatrzymania.
- Pionowa pozycja robocza.
- Ergonomiczne.
- Teoretyczna wydajność 250 wkrętów samowiercących na godzinę.

31572 SPEDEC Urządzenie pneumatyczne CF 250 P J91A

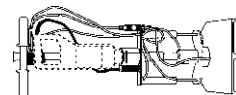

Typ	☒	Kod artykułu
CF250	1	31572.001.770

- Do odbudowania typ CF 250.
- Waga 16,3 kg.

31536 SPEDEC Adapter typ E480

J90A



Typ		Kod artykułu
E480	1	31536.001.770

- Z trzonkiem sześciokątnym 1/4 cala.
- Samozaciskowe.
- Odpowiednie dla wkrętów samowiercących z kołnierzem typ SN z szerokością powierzchni 8 mm.
- Długość 73 mm.

Wkręty do drewna MaxxFast

Uniwersalny wkręt do drewna

Uniwersalny wkręt do drewna MaxxFast to unikalny wszechstronny zastosowania wkręt do drewna do wszystkich aplikacji drewnianych. Wkręty te posiadają najnowsze rewolucyjne własności techniczne, które sprawiają, że nadają się one do wszystkich celów dla miękkiego i twardego drewna, MDF, sklejki, drewna laminowanego (melamina) oraz do wszystkich rodzajów drewna egzotycznego i tropikalnego. Jednakże wstępne nawiercanie jest zalecane do bardzo twardej aplikacji.

Charakterystyka techniczna:

- Ostra końcówka z 2 korbami tnącymi
- Żebra frezujące (wkręty >40mm)
- Powłoka woskowa
- Samozagłębiający się łeb w dwóch etapach
- Żebra nacinające
- ttap®

Uniwersalny wkręt do drewna MaxxFast jest dostępny w szerokim zakresie wymiarów w wykonaniu ze stali cynkowanej, w tym również na żółto oraz ze stali odpornej na korozję. Dostępny również z różnymi kształtami łba, wpuszczanym stożkowym i walcowym oraz w systemie ttap® drive i Pozidriv.

Wkręt konstrukcyjny do drewna

Wkręt konstrukcyjny do drewna MaxxFast to unikalny wkręt ogólnego zastosowania dla szerokiego zakresu aplikacji w profesjonalnych konstrukcjach drewnianych, takich jak drewniane konstrukcje szkieletowe i konstrukcje domów, konstrukcje klatek schodowych, wiaty garażowe, mocowanie i łączenie krokwi. Wkręty te są wyjątkowo wytrzymałe i nie wymagają wstępnego nawiercania.

Charakterystyka techniczna:

- Ostra końcówka z 2 korbami tnącymi
- Żebra frezujące
- Powłoka woskowa
- Samozagłębiający się łeb w dwóch etapach lub łeb z dużym kołnierzem
- Żebra nacinające
- ttap®

Wkręt konstrukcyjny do drewna MaxxFast jest dostępny w szerokim zakresie wymiarów w wykonaniu ze stali ocynkowanej na żółto, z łbem samozagłębiającym się lub z łbem kołnierzowym.

Wkręt tarasowy

Wkręt tarasowy MaxxFast to unikalny wkręt odpowiedni do mocowania na zewnątrz budynków desek tarasowych z wszelkiego rodzaju twardego egzotycznego lub tropikalnego drewna. Jednakże wstępne nawiercanie jest zalecane do bardzo twardej aplikacji. Ten wkręt posiada bardzo ostrą końcówkę i dwa karby tnące, które zapewniają szybkie wprowadzanie i zapobiegają rozszczepianiu się drewna.

Charakterystyka techniczna:

- Ostra końcówka z 2 korbami tnącymi
- Żebra frezujące
- Powłoka woskowa
- Zmniejszony łeb samozagłębiający się
- Żebra tnące
- ttap®

Wkręt tarasowy MaxxFast jest dostępny w szerokim zakresie wymiarów w wykonaniu ze stali odpornej na korozję A2.

6



Wkręt do drewna uniwersalny z łbem stożkowym płaskim z gniazdem krzyżowym

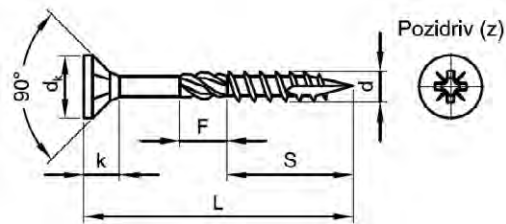

Informacje techniczne

d	dk	k	Nr wgłębienia krzyżowego	d	dk	k	Nr wgłębienia krzyżowego
3	6	3.5	1	4.5	9	5.0	2
3.5	7	4.0	2	5	10	5.5	2
4	8	4.5	2	6	12	6.3	3

- Tylko pełne opakowania.
- F=9mm tylko wtedy, gdy L≥40mm.
- Srednice 3 oraz 3,5 nie są przystosowane do konstrukcji drewnianych i z tego powodu nie są znakowane CE

Grupy katalogowe

Gniazdo	Materiał	Obróbka powierzchni	Kod	Strona
Pozidriv	St	Ocynk.	30000	6-149
Pozidriv	St	Ocynk. żłt. pas.	30005	6-149
Pozidriv	St.St. A2		30015	6-150

30000 MAXXFAST Wkręt do drewna uniwersalny z łbem stożkowym płaskim z gniazdem krzyżowym Pozidriv MF0A

Materiał: Stal
Obróbka powierzchni: Ocynkowane

MAXXFAST
PROFESSIONAL HARDWARE

d x L (S)	☒	Kod artykułu	d x L (S)	☒	Kod artykułu	d x L (S)	☒	Kod artykułu
3X10MM (6)	200	30000.030.010	4X40MM (25)	200	30000.040.040	5X45MM (30)	200	30000.050.045
3X12MM (8)	200	30000.030.012	4X45MM (30)	200	30000.040.045	5X50MM (35)	200	30000.050.050
3X16MM (12)	200	30000.030.016	4X50MM (35)	200	30000.040.050	5X60MM (45)	200	30000.050.060
3X20MM (16)	200	30000.030.020	4X60MM (45)	200	30000.040.060	5X70MM (54)	200	30000.050.070
3X25MM (21)	200	30000.030.025	4X70MM (54)	200	30000.040.070	5X80MM (54)	100	30000.050.080
3X30MM (26)	200	30000.030.030				5X90MM (60)	100	30000.050.090
3X35MM (31)	200	30000.030.035	4,5X16MM (11)	200	30000.045.016	5X100MM (66)	100	30000.050.100
			4,5X20MM (15)	200	30000.045.020			
3,5X12MM (8)	200	30000.035.012	4,5X25MM (20)	200	30000.045.025	6X30MM (23)	200	30000.060.030
3,5X16MM (12)	200	30000.035.016	4,5X30MM (25)	200	30000.045.030	6X35MM (28)	200	30000.060.035
3,5X20MM (16)	200	30000.035.020	4,5X35MM (30)	200	30000.045.035	6X40MM (25)	200	30000.060.040
3,5X25MM (21)	200	30000.035.025	4,5X40MM (25)	200	30000.045.040	6X45MM (30)	200	30000.060.045
3,5X30MM (26)	200	30000.035.030	4,5X45MM (30)	200	30000.045.045	6X50MM (35)	200	30000.060.050
3,5X35MM (31)	200	30000.035.035	4,5X50MM (35)	200	30000.045.050	6X60MM (45)	200	30000.060.060
3,5X40MM (25)	200	30000.035.040	4,5X60MM (45)	200	30000.045.060	6X70MM (54)	200	30000.060.070
3,5X45MM (30)	200	30000.035.045	4,5X70MM (54)	200	30000.045.070	6X80MM (54)	100	30000.060.080
3,5X50MM (35)	200	30000.035.050	4,5X80MM (54)	200	30000.045.080	6X90MM (60)	100	30000.060.090
						6X100MM (66)	100	30000.060.100
4X12MM (7)	200	30000.040.012	5X16MM (9)	200	30000.050.016	6X110MM (73)	100	30000.060.110
4X16MM (11)	200	30000.040.016	5X20MM (14)	200	30000.050.020	6X120MM (80)	100	30000.060.120
4X20MM (15)	200	30000.040.020	5X25MM (19)	200	30000.050.025	6X130MM (86)	100	30000.060.130
4X25MM (20)	200	30000.040.025	5X30MM (24)	200	30000.050.030	6X140MM (93)	100	30000.060.140
4X30MM (25)	200	30000.040.030	5X35MM (29)	200	30000.050.035	6X150MM (100)	100	30000.060.150
4X35MM (30)	200	30000.040.035	5X40MM (25)	200	30000.050.040			

30005 MAXXFAST Wkręt do drewna uniwersalny z łbem stożkowym płaskim z gniazdem krzyżowym Pozidriv MF0A

Materiał: Stal
Obróbka powierzchni: Ocynkowane, po żółtej pasywacji

MAXXFAST
PROFESSIONAL HARDWARE

d x L (S)	☒	Kod artykułu	d x L (S)	☒	Kod artykułu	d x L (S)	☒	Kod artykułu
3X10MM (6)	200	30005.030.010	3X35MM (31)	200	30005.030.035	3,5X30MM (26)	200	30005.035.030
3X12MM (8)	200	30005.030.012				3,5X35MM (31)	200	30005.035.035
3X16MM (12)	200	30005.030.016	3,5X12MM (8)	200	30005.035.012	3,5X40MM (25)	200	30005.035.040
3X20MM (16)	200	30005.030.020	3,5X16MM (12)	200	30005.035.016	3,5X45MM (30)	200	30005.035.045
3X25MM (21)	200	30005.030.025	3,5X20MM (16)	200	30005.035.020	3,5X50MM (35)	200	30005.035.050
3X30MM (26)	200	30005.030.030	3,5X25MM (21)	200	30005.035.025			

30005 MAXXFAST Wkręt do drewna uniwersalny z łbem stożkowym płaskim z gniazdem krzyżowym Pozidriv								
d x L (S)	☒	Kod artykułu	d x L (S)	☒	Kod artykułu	d x L (S)	☒	Kod artykułu
4X12MM (7)	200	30005.040.012	4,5X45MM (30)	200	30005.045.045	5X100MM (66)	100	30005.050.100
4X16MM (11)	200	30005.040.016	4,5X50MM (35)	200	30005.045.050	6X30MM (23)	200	30005.060.030
4X20MM (15)	200	30005.040.020	4,5X60MM (45)	200	30005.045.060	6X35MM (28)	200	30005.060.035
4X25MM (20)	200	30005.040.025	4,5X70MM (54)	200	30005.045.070	6X40MM (25)	200	30005.060.040
4X30MM (25)	200	30005.040.030	4,5X80MM (54)	200	30005.045.080	6X45MM (30)	200	30005.060.045
4X35MM (30)	200	30005.040.035				6X50MM (35)	200	30005.060.050
4X40MM (25)	200	30005.040.040	5X16MM (9)	200	30005.050.016	6X60MM (45)	200	30005.060.060
4X45MM (30)	200	30005.040.045	5X20MM (14)	200	30005.050.020	6X70MM (54)	200	30005.060.070
4X50MM (35)	200	30005.040.050	5X25MM (19)	200	30005.050.025	6X80MM (54)	100	30005.060.080
4X60MM (45)	200	30005.040.060	5X30MM (24)	200	30005.050.030	6X90MM (60)	100	30005.060.090
4X70MM (54)	200	30005.040.070	5X35MM (29)	200	30005.050.035	6X100MM (66)	100	30005.060.100
			5X40MM (25)	200	30005.050.040	6X110MM (73)	100	30005.060.110
4,5X16MM (11)	200	30005.045.016	5X45MM (30)	200	30005.050.045	6X120MM (80)	100	30005.060.120
4,5X20MM (15)	200	30005.045.020	5X50MM (35)	200	30005.050.050	6X130MM (86)	100	30005.060.130
4,5X25MM (20)	200	30005.045.025	5X60MM (45)	200	30005.050.060	6X140MM (93)	100	30005.060.140
4,5X30MM (25)	200	30005.045.030	5X70MM (54)	200	30005.050.070	6X150MM (100)	100	30005.060.150
4,5X35MM (30)	200	30005.045.035	5X80MM (54)	100	30005.050.080			
4,5X40MM (25)	200	30005.045.040	5X90MM (60)	100	30005.050.090			

30015 MAXXFAST Wkręt do drewna uniwersalny z łbem stożkowym płaskim z gniazdem krzyżowym Pozidriv		MF0A
Materiał	Stal nierdzewna A2	
CE		

d x L (S)	☒	Kod artykułu	d x L (S)	☒	Kod artykułu	d x L (S)	☒	Kod artykułu
3X10MM (6)	200	30015.030.010	4X40MM (25)	200	30015.040.040	5X45MM (30)	200	30015.050.045
3X12MM (8)	200	30015.030.012	4X45MM (30)	200	30015.040.045	5X50MM (35)	200	30015.050.050
3X16MM (12)	200	30015.030.016	4X50MM (35)	200	30015.040.050	5X60MM (45)	200	30015.050.060
3X20MM (16)	200	30015.030.020	4X60MM (45)	200	30015.040.060	5X70MM (54)	200	30015.050.070
3X25MM (21)	200	30015.030.025	4X70MM (54)	200	30015.040.070	5X80MM (54)	100	30015.050.080
3X30MM (26)	200	30015.030.030				5X90MM (60)	100	30015.050.090
3X35MM (31)	200	30015.030.035	4,5X16MM (11)	200	30015.045.016	5X100MM (66)	100	30015.050.100
			4,5X20MM (15)	200	30015.045.020	6X30MM (23)	200	30015.060.030
3,5X12MM (8)	200	30015.035.012	4,5X25MM (20)	200	30015.045.025	6X35MM (28)	200	30015.060.035
3,5X16MM (12)	200	30015.035.016	4,5X30MM (25)	200	30015.045.030	6X40MM (25)	200	30015.060.040
3,5X20MM (16)	200	30015.035.020	4,5X35MM (30)	200	30015.045.035	6X45MM (30)	200	30015.060.045
3,5X25MM (21)	200	30015.035.025	4,5X40MM (25)	200	30015.045.040	6X50MM (35)	200	30015.060.050
3,5X30MM (26)	200	30015.035.030	4,5X45MM (30)	200	30015.045.045	6X60MM (45)	200	30015.060.060
3,5X35MM (31)	200	30015.035.035	4,5X50MM (35)	200	30015.045.050	6X70MM (54)	200	30015.060.070
3,5X40MM (25)	200	30015.035.040	4,5X60MM (45)	200	30015.045.060	6X80MM (54)	100	30015.060.080
3,5X45MM (30)	200	30015.035.045	4,5X70MM (54)	200	30015.045.070	6X90MM (60)	100	30015.060.090
3,5X50MM (35)	200	30015.035.050	4,5X80MM (54)	200	30015.045.080	6X100MM (66)	100	30015.060.100
						6X110MM (73)	100	30015.060.110
4X12MM (7)	200	30015.040.012	5X16MM (9)	200	30015.050.016	6X120MM (80)	100	30015.060.120
4X16MM (11)	200	30015.040.016	5X20MM (14)	200	30015.050.020	6X130MM (86)	100	30015.060.130
4X20MM (15)	200	30015.040.020	5X25MM (19)	200	30015.050.025	6X140MM (93)	100	30015.060.140
4X25MM (20)	200	30015.040.025	5X30MM (24)	200	30015.050.030	6X150MM (100)	100	30015.060.150
4X30MM (25)	200	30015.040.030	5X35MM (29)	200	30015.050.035			
4X35MM (30)	200	30015.040.035	5X40MM (25)	200	30015.050.040			

Wkręt do drewna uniwersalny z łbem stożkowym płaskim z ttap®

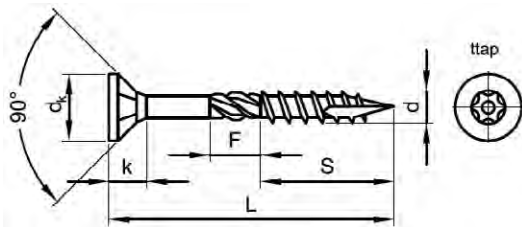

Informacje techniczne

d	dk	k	Nr ttap	d	dk	k	Nr ttap
3	6	3.5	10	4.5	9	5.0	20
3.5	7	4.0	15	5	10	5.5	25
4	8	4.5	20	6	12	6.3	25

- Tylko pełne opakowania.
- F=9mm tylko wtedy, gdy L≥40mm.
- Średnice 3 oraz 3,5 nie są przystosowane do konstrukcji drewnianych i z tego powodu nie są znakowane CE

Grupy katalogowe

Gniazdo	Materiał	Obróbka powierzchni	Kod	Strona
ttap®	St	Ocynk.	30100	6-151
ttap®	St	Ocynk. żłt. pas.	30105	6-151
ttap®	St.St. A2		30115	6-152

30100 MAXXFAST Wkręt do drewna uniwersalny z łbem stożkowym płaskim z ttap®

MF0A

Materiał Stal
Obróbka powierzchni Ocynkowane

MAXXFAST
PROFESSIONAL HARDWARE



CE

d x L (S)	☒	Kod artykułu	d x L (S)	☒	Kod artykułu	d x L (S)	☒	Kod artykułu
3X10MM (6)	200	30100.030.010	4X40MM (25)	200	30100.040.040	5X45MM (30)	200	30100.050.045
3X12MM (8)	200	30100.030.012	4X45MM (30)	200	30100.040.045	5X50MM (35)	200	30100.050.050
3X16MM (12)	200	30100.030.016	4X50MM (35)	200	30100.040.050	5X60MM (45)	200	30100.050.060
3X20MM (16)	200	30100.030.020	4X60MM (45)	200	30100.040.060	5X70MM (54)	200	30100.050.070
3X25MM (21)	200	30100.030.025	4X70MM (54)	200	30100.040.070	5X80MM (54)	100	30100.050.080
3X30MM (26)	200	30100.030.030				5X90MM (60)	100	30100.050.090
3X35MM (31)	200	30100.030.035	4,5X16MM (11)	200	30100.045.016	5X100MM (66)	100	30100.050.100
			4,5X20MM (15)	200	30100.045.020			
3,5X12MM (8)	200	30100.035.012	4,5X25MM (20)	200	30100.045.025	6X30MM (23)	200	30100.060.030
3,5X16MM (12)	200	30100.035.016	4,5X30MM (25)	200	30100.045.030	6X35MM (28)	200	30100.060.035
3,5X20MM (16)	200	30100.035.020	4,5X35MM (30)	200	30100.045.035	6X40MM (25)	200	30100.060.040
3,5X25MM (21)	200	30100.035.025	4,5X40MM (25)	200	30100.045.040	6X45MM (30)	200	30100.060.045
3,5X30MM (26)	200	30100.035.030	4,5X45MM (30)	200	30100.045.045	6X50MM (35)	200	30100.060.050
3,5X35MM (31)	200	30100.035.035	4,5X50MM (35)	200	30100.045.050	6X60MM (45)	200	30100.060.060
3,5X40MM (25)	200	30100.035.040	4,5X60MM (45)	200	30100.045.060	6X70MM (54)	200	30100.060.070
3,5X45MM (30)	200	30100.035.045	4,5X70MM (54)	200	30100.045.070	6X80MM (54)	100	30100.060.080
3,5X50MM (35)	200	30100.035.050	4,5X80MM (54)	200	30100.045.080	6X90MM (60)	100	30100.060.090
						6X100MM (66)	100	30100.060.100
4X12MM (7)	200	30100.040.012	5X16MM (9)	200	30100.050.016	6X110MM (73)	100	30100.060.110
4X16MM (11)	200	30100.040.016	5X20MM (14)	200	30100.050.020	6X120MM (80)	100	30100.060.120
4X20MM (15)	200	30100.040.020	5X25MM (19)	200	30100.050.025	6X130MM (86)	100	30100.060.130
4X25MM (20)	200	30100.040.025	5X30MM (24)	200	30100.050.030	6X140MM (93)	100	30100.060.140
4X30MM (25)	200	30100.040.030	5X35MM (29)	200	30100.050.035	6X150MM (100)	100	30100.060.150
4X35MM (30)	200	30100.040.035	5X40MM (25)	200	30100.050.040			

30105 MAXXFAST Wkręt do drewna uniwersalny z łbem stożkowym płaskim z ttap®

MF0A

Materiał Stal
Obróbka powierzchni Ocynkowane, po żółtej pasywacji

MAXXFAST
PROFESSIONAL HARDWARE



CE

d x L (S)	☒	Kod artykułu	d x L (S)	☒	Kod artykułu	d x L (S)	☒	Kod artykułu
3X10MM (6)	200	30105.030.010	3X35MM (31)	200	30105.030.035	3,5X30MM (26)	200	30105.035.030
3X12MM (8)	200	30105.030.012				3,5X35MM (31)	200	30105.035.035
3X16MM (12)	200	30105.030.016	3,5X12MM (8)	200	30105.035.012	3,5X40MM (25)	200	30105.035.040
3X20MM (16)	200	30105.030.020	3,5X16MM (12)	200	30105.035.016	3,5X45MM (30)	200	30105.035.045
3X25MM (21)	200	30105.030.025	3,5X20MM (16)	200	30105.035.020	3,5X50MM (35)	200	30105.035.050
3X30MM (26)	200	30105.030.030	3,5X25MM (21)	200	30105.035.025			

30105 MAXXFAST Wkręt do drewna uniwersalny z łbem stożkowym płaskim z ttap®								
d x L (S)	☒	Kod artykułu	d x L (S)	☒	Kod artykułu	d x L (S)	☒	Kod artykułu
4X12MM (7)	200	30105.040.012	4,5X45MM (30)	200	30105.045.045	5X100MM (66)	100	30105.050.100
4X16MM (11)	200	30105.040.016	4,5X50MM (35)	200	30105.045.050			
4X20MM (15)	200	30105.040.020	4,5X60MM (45)	200	30105.045.060	6X30MM (23)	200	30105.060.030
4X25MM (20)	200	30105.040.025	4,5X70MM (54)	200	30105.045.070	6X35MM (28)	200	30105.060.035
4X30MM (25)	200	30105.040.030	4,5X80MM (54)	200	30105.045.080	6X40MM (25)	200	30105.060.040
4X35MM (30)	200	30105.040.035				6X45MM (30)	200	30105.060.045
4X40MM (25)	200	30105.040.040	5X16MM (9)	200	30105.050.016	6X50MM (35)	200	30105.060.050
4X45MM (30)	200	30105.040.045	5X20MM (14)	200	30105.050.020	6X60MM (45)	200	30105.060.060
4X50MM (35)	200	30105.040.050	5X25MM (19)	200	30105.050.025	6X70MM (54)	200	30105.060.070
4X60MM (45)	200	30105.040.060	5X30MM (24)	200	30105.050.030	6X80MM (54)	100	30105.060.080
4X70MM (54)	200	30105.040.070	5X35MM (29)	200	30105.050.035	6X90MM (60)	100	30105.060.090
			5X40MM (25)	200	30105.050.040	6X100MM (66)	100	30105.060.100
4,5X16MM (11)	200	30105.045.016	5X45MM (30)	200	30105.050.045	6X110MM (73)	100	30105.060.110
4,5X20MM (15)	200	30105.045.020	5X50MM (35)	200	30105.050.050	6X120MM (80)	100	30105.060.120
4,5X25MM (20)	200	30105.045.025	5X60MM (45)	200	30105.050.060	6X130MM (86)	100	30105.060.130
4,5X30MM (25)	200	30105.045.030	5X70MM (54)	200	30105.050.070	6X140MM (93)	100	30105.060.140
4,5X35MM (30)	200	30105.045.035	5X80MM (54)	100	30105.050.080	6X150MM (100)	100	30105.060.150
4,5X40MM (25)	200	30105.045.040	5X90MM (60)	100	30105.050.090			

30115 MAXXFAST Wkręt do drewna uniwersalny z łbem stożkowym płaskim z ttap®		MF0A
Materiał	Stal nierdzewna A2	
CE		

6

d x L (S)	☒	Kod artykułu	d x L (S)	☒	Kod artykułu	d x L (S)	☒	Kod artykułu
3X10MM (6)	200	30115.030.010	4X40MM (25)	200	30115.040.040	5X45MM (30)	200	30115.050.045
3X12MM (8)	200	30115.030.012	4X45MM (30)	200	30115.040.045	5X50MM (35)	200	30115.050.050
3X16MM (12)	200	30115.030.016	4X50MM (35)	200	30115.040.050	5X60MM (45)	200	30115.050.060
3X20MM (16)	200	30115.030.020	4X60MM (45)	200	30115.040.060	5X70MM (54)	200	30115.050.070
3X25MM (21)	200	30115.030.025	4X70MM (54)	200	30115.040.070	5X80MM (54)	100	30115.050.080
3X30MM (26)	200	30115.030.030				5X90MM (60)	100	30115.050.090
3X35MM (31)	200	30115.030.035	4,5X16MM (11)	200	30115.045.016	5X100MM (66)	100	30115.050.100
			4,5X20MM (15)	200	30115.045.020			
3,5X12MM (8)	200	30115.035.012	4,5X25MM (20)	200	30115.045.025	6X30MM (23)	200	30115.060.030
3,5X16MM (12)	200	30115.035.016	4,5X30MM (25)	200	30115.045.030	6X35MM (28)	200	30115.060.035
3,5X20MM (16)	200	30115.035.020	4,5X35MM (30)	200	30115.045.035	6X40MM (25)	200	30115.060.040
3,5X25MM (21)	200	30115.035.025	4,5X40MM (25)	200	30115.045.040	6X45MM (30)	200	30115.060.045
3,5X30MM (26)	200	30115.035.030	4,5X45MM	200	30115.045.045	6X50MM (35)	200	30115.060.050
3,5X35MM (31)	200	30115.035.035	4,5X50MM	200	30115.045.050	6X60MM (45)	200	30115.060.060
3,5X40MM (25)	200	30115.035.040	4,5X60MM (45)	200	30115.045.060	6X70MM (54)	200	30115.060.070
3,5X45MM (30)	200	30115.035.045	4,5X70MM (54)	200	30115.045.070	6X80MM (54)	100	30115.060.080
3,5X50MM (35)	200	30115.035.050	4,5X80MM (54)	200	30115.045.080	6X90MM (60)	100	30115.060.090
						6X100MM (66)	100	30115.060.100
4X12MM (7)	200	30115.040.012	5X16MM (9)	200	30115.050.016	6X110MM (73)	100	30115.060.110
4X16MM (11)	200	30115.040.016	5X20MM (14)	200	30115.050.020	6X120MM (80)	100	30115.060.120
4X20MM (15)	200	30115.040.020	5X25MM (19)	200	30115.050.025	6X130MM (86)	100	30115.060.130
4X25MM (20)	200	30115.040.025	5X30MM (24)	200	30115.050.030	6X140MM (93)	100	30115.060.140
4X30MM (25)	200	30115.040.030	5X35MM (29)	200	30115.050.035	6X150MM (100)	100	30115.060.150
4X35MM (30)	200	30115.040.035	5X40MM (25)	200	30115.050.040			

Wkręty do płyt wiórowych

Informacje ogólne

Wkręty do płyt wiórowych, zwane także wkrętami do szybkiego montażu, zostały specjalnie opracowane, aby zapobiegać problemom powstającym przy stosowaniu tradycyjnych wkrętów do drewna w płycie wiórowej i innych rodzajach drewna. Wkręty do płyt wiórowych mają wiele technicznych ulepszeń zapewniających łatwy i szybki montaż z zastosowaniem nowoczesnych narzędzi, a tym samym pozwalają zmniejszyć koszty całkowite.

Właściwości

Korzyści wynikają z następujących właściwości: zaadoptowana geometria gwintu, kąt zarysu gwintu do drewna został zmniejszony z 60° do 40°.

Zalety

Przy tej samej średnicy zewnętrznej, średnica rdzenia wkrętu jest mniejsza i ma taką samą grubość na całej długości gwintu (z wyjątkiem końcówki). Normalnej długości wkręty do płyt wiórowych mają gwint aż do łba. W zależności od dostępności mogą być dostarczone z gwintem na całej długości, jak również nagwintowane częściowo. Ostra, samocentrująca końcówka, zapewnia łatwiejsze rozpoczęcie wkręcania i zmniejsza ryzyko bicia osiowego. W związku z czym, często zbędne staje się kosztowne i czasochłonne wiercenie wstępne. Ostrzejszy i głębszy profil gwintu nie wypycha na zewnątrz materiału, lecz się w niego wcina.

Dzięki temu zmniejsza się ryzyko kruszenia i rozłupywania się małych, przeciętych boków materiału, np. Przy montażu drzwi i okien mebli. Oprócz tego uzyskuje się lepszy zacisk (do 35% wyższe wartości sił wyciągających) i do 40% niższy moment obrotowy dokręcania przy montażu.

Materiał

Wkręty do płyt wiórowych wykonane są ze stali nierdzewnej a także ze stali nawęglanej i utwardzanej powierzchniowo. Są one mocniejsze i odporniejsze na zużycie niż wkręty do drewna, posiadają zwiększoną wydajność nacinania i zapobieganie uszkodzeniu podczas instalacji. Rdzeń wkrętu pozostaje ciągliwy, co zapobiega łamaniu łba wkrętu przy zginaniu.

Montaż

Stalowe wkręty do płyt wiórowych dostarczane są ze specjalnym smarowaniem antykorozyjnym, który powoduje skrócenie montażu.

Typy

Wkręty do płyt wiórowych dostępne są w wersji Pozidriv (Z) oraz z gniazdem sześciokarbowym. Fabory oferuje, obok wkrętów do płyt wiórowych Heco-Fix, szeroką gamę wkrętów uniwersalnych MaxxFast z gniazdem ttap®. Bardziej szczegółowych informacji szukaj na odpowiednich stronach produktów w tej sekcji.

6

Informacje techniczne

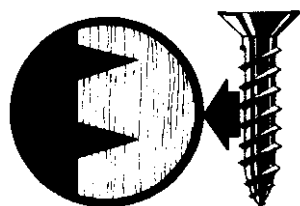

Wkręty do płyt wiórowych

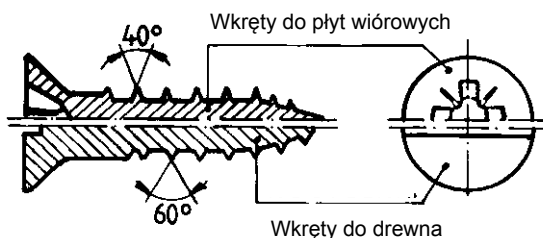

Wkręty do drewna

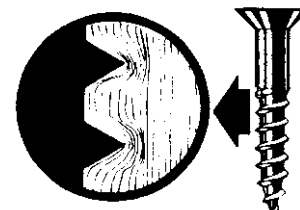

Wkręty do drewna

Wkręty z łbem stożkowym z gniazdem krzyżowym

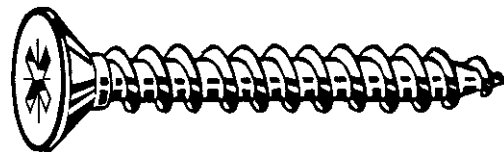
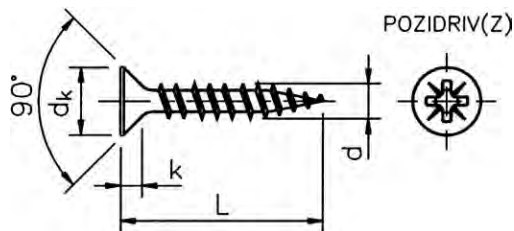

Informacje techniczne

d	d _k (maks.)	k (maks.)	Nr wgłębienia krzyżowego
2.5	5	1.2	1
3	5.9	1.9	1
3.5	6.9	2.1	2
4	7.9	2.5	2
4.5	8.9	2.7	2
5	9.6	3	2
6	11.6	3.6	3

- Wszystkie wymiary są wartościami sugerowanymi i mogą się różnić w zależności od producenta.

Grupy katalogowe

Gniazdo	Materiał	Obróbka powierzchni	Kod	Strona	
Pozidriv	St	Ocynk.	29240	6-154	
Pozidriv	St	Ocynk.	Duże Opakowanie	29242	6-155
Pozidriv	St	Ocynk.	HECO-FIX PLUS	29248	6-155
Pozidriv	St	Ocynk. żłt. pas.	29440	6-155	
Pozidriv	St.St. A2		51750	6-156	
Pozidriv	St.St. A4		55750	6-156	
Pozidriv	St	Ocynk.	HECO-TOPIX	29349	6-157
Pozidriv	St	Ocynk. żłt. pas.	HECO-TOPIX	29353	6-157
Pozidriv	St	Ocynk.	HECO-UNIX PLUS	29370	6-157

6

29240 Wkręty do płyt wiórowych z łbem stożkowym z gniazdem krzyżowym Pozidriv

K01A

Materiał Stal
Obróbka powierzchni Ocynkowane



d x L	☒	Kod artykułu	d x L	☒	Kod artykułu	d x L	☒	Kod artykułu
2,5X10MM	200	29240.025.010	4X35MM	200	29240.040.035	5X50MM	200	29240.050.050
2,5X12MM	200	29240.025.012	4X40MM	200	29240.040.040	5X60MM	200	29240.050.060
2,5X16MM	200	29240.025.016	4X45MM	200	29240.040.045	5X70MM	200	29240.050.070
3X10MM	200	29240.030.010	4X50MM	200	29240.040.050	5X80MM	200	29240.050.080
3X12MM	200	29240.030.012	4X60MM	200	29240.040.060	5X90MM	200	29240.050.090
3X16MM	200	29240.030.016	4X70MM	200	29240.040.070	5X100MM	200	29240.050.100
3X20MM	200	29240.030.020	4,5X16MM	200	29240.045.016	6X30MM	200	29240.060.030
3X25MM	200	29240.030.025	4,5X20MM	200	29240.045.020	6X35MM	200	29240.060.035
3X30MM	200	29240.030.030	4,5X25MM	200	29240.045.025	6X40MM	200	29240.060.040
3X35MM	200	29240.030.035	4,5X30MM	200	29240.045.030	6X45MM	200	29240.060.045
3,5X12MM	200	29240.035.012	4,5X35MM	200	29240.045.035	6X50MM	200	29240.060.050
3,5X16MM	200	29240.035.016	4,5X40MM	200	29240.045.040	6X60MM	200	29240.060.060
3,5X20MM	200	29240.035.020	4,5X45MM	200	29240.045.045	6X70MM	200	29240.060.070
3,5X25MM	200	29240.035.025	4,5X50MM	200	29240.045.050	6X80MM	200	29240.060.080
3,5X30MM	200	29240.035.030	4,5X60MM	200	29240.045.060	6X90MM	200	29240.060.090
3,5X35MM	200	29240.035.035	4,5X70MM	200	29240.045.070	6X100MM	200	29240.060.100
3,5X40MM	200	29240.035.040	4,5X80MM	200	29240.045.080	6X110MM	200	29240.060.110
4X12MM	200	29240.040.012	5X20MM	200	29240.050.020	6X120MM	200	29240.060.120
4X16MM	200	29240.040.016	5X25MM	200	29240.050.025	6X130MM	200	29240.060.130
4X20MM	200	29240.040.020	5X30MM	200	29240.050.030	6X140MM	200	29240.060.140
4X25MM	200	29240.040.025	5X35MM	200	29240.050.035	6X150MM	200	29240.060.150
4X30MM	200	29240.040.030	5X40MM	200	29240.050.040	6X160MM	100	29240.060.160
			5X45MM	200	29240.050.045			

- Ostrzeżenie: cynkowanie elektrolityczne tych produktów może wywołać kruchość wodorową.

29242 Wkręty do płyt wiórowych z łbem stożkowym z gniazdem krzyżowym Pozidriv		K01A	
Materiał	Stal		
Obróbka powierzchni	Ocynkowane		

d x L	☒	Kod artykułu	d x L	☒	Kod artykułu	d x L	☒	Kod artykułu
3X16MM	2000	29242.030.016	3,5X25MM	2000	29242.035.025	4X25MM	2000	29242.040.025
3X20MM	2000	29242.030.020	3,5X30MM	2000	29242.035.030	4X30MM	2000	29242.040.030
3X25MM	2000	29242.030.025	3,5X40MM	2000	29242.035.040	4X35MM	2000	29242.040.035
						4X40MM	2000	29242.040.040
3,5X16MM	2000	29242.035.016	4X16MM	2000	29242.040.016	4X45MM	2000	29242.040.045
3,5X20MM	2000	29242.035.020	4X20MM	2000	29242.040.020	4X50MM	2000	29242.040.050

- Ostrzeżenie: cynkowanie elektrolityczne tych produktów może wywołać kruchość wodorową.

29248 HECO-FIX PLUS Wkręty do płyt wiórowych z łbem stożkowym z gniazdem krzyżowym Pozidriv		K04A	
Materiał	Stal		
Obróbka powierzchni	Ocynkowane		

d x L	☒	Kod artykułu	d x L	☒	Kod artykułu	d x L	☒	Kod artykułu
2,5X10MM	200	29248.025.010	4X20MM	200	29248.040.020	5X40MM	200	29248.050.040
2,5X12MM	200	29248.025.012	4X25MM	200	29248.040.025	5X45MM	200	29248.050.045
2,5X16MM	200	29248.025.016	4X30MM	200	29248.040.030	5X50MM	200	29248.050.050
2,5X20MM	200	29248.025.020	4X35MM	200	29248.040.035	5X60MM	200	29248.050.060
			4X40MM	200	29248.040.040	5X70MM	200	29248.050.070
3X10MM	200	29248.030.010	4X45MM	200	29248.040.045	5X80MM	200	29248.050.080
3X12MM	200	29248.030.012	4X50MM	200	29248.040.050	5X90MM	200	29248.050.090
3X16MM	200	29248.030.016	4X55MM	200	29248.040.055	5X100MM	200	29248.050.100
3X20MM	200	29248.030.020	4X60MM	200	29248.040.060			
3X25MM	200	29248.030.025	4X70MM	200	29248.040.070	6X30MM	200	29248.060.030
3X30MM	200	29248.030.030				6X35MM	200	29248.060.035
3X35MM	200	29248.030.035	4,5X16MM	200	29248.045.016	6X40MM	200	29248.060.040
3X40MM	200	29248.030.040	4,5X20MM	200	29248.045.020	6X45MM	200	29248.060.045
3X45MM	500	29248.030.045	4,5X25MM	200	29248.045.025	6X50MM	200	29248.060.050
			4,5X30MM	200	29248.045.030	6X60MM	200	29248.060.060
3,5X12MM	1000	29248.035.012	4,5X35MM	200	29248.045.035	6X70MM	200	29248.060.070
3,5X15MM	200	29248.035.015	4,5X40MM	200	29248.045.040	6X80MM	100	29248.060.080
3,5X16MM	200	29248.035.016	4,5X45MM	200	29248.045.045	6X90MM	100	29248.060.090
3,5X20MM	200	29248.035.020	4,5X50MM	200	29248.045.050	6X100MM	100	29248.060.100
3,5X25MM	200	29248.035.025	4,5X60MM	200	29248.045.060	6X110MM	100	29248.060.110
3,5X30MM	200	29248.035.030	4,5X70MM	200	29248.045.070	6X120MM	100	29248.060.120
3,5X35MM	200	29248.035.035	4,5X80MM	200	29248.045.080	6X130MM	100	29248.060.130
3,5X40MM	200	29248.035.040				6X140MM	100	29248.060.140
3,5X45MM	200	29248.035.045	5X20MM	200	29248.050.020	6X150MM	100	29248.060.150
3,5X50MM	200	29248.035.050	5X25MM	200	29248.050.025	6X160MM	100	29248.060.160
			5X30MM	200	29248.050.030	6X180MM	100	29248.060.180
4X16MM	200	29248.040.016	5X35MM	200	29248.050.035	6X200MM	100	29248.060.200

- Cechy szczególne wkrętów do płyt wiórowych HECO-FIX PLUS:
- Zmniejszenie wymaganego momentu obrotowego napędu o do 30%.
- Łatwiejsze wykorzystanie.
- Znacząco lepsze efekty przy wkręcaniu przy pomocy wkrętaaków akumulatorowych.
- Zmniejszenie sił osiowych, a tym samym zmniejszone zużycie końcówek wkrętaaka.
- Dzięki geometrii zębów uzyskiwany jest wyższy moment obrotowy przy odkręcaniu, a w związku z tym uzyskane jest bezpieczne połączenie wkręcane..
- Ostrzeżenie: cynkowanie elektrolityczne tych produktów może wywołać kruchość wodorową.

29440 Wkręty do płyt wiórowych z łbem stożkowym z gniazdem krzyżowym Pozidriv		K01B	
Materiał	Stal		
Obróbka powierzchni	Ocynkowane, po żółtej pasywacji		

d x L	☒	Kod artykułu	d x L	☒	Kod artykułu	d x L	☒	Kod artykułu
2,5X12MM	200	29440.025.013	3X25MM	200	29440.030.025	3,5X35MM	200	29440.035.035
2,5X15MM	200	29440.025.015	3X30MM	200	29440.030.030	3,5X40MM	200	29440.035.040
2,5X16MM	200	29440.025.016	3X35MM	200	29440.030.035	3,5X45MM	200	29440.035.045
2,5X17MM	200	29440.025.017				3,5X50MM	200	29440.035.050
			3,5X12MM	200	29440.035.012			
3X10MM	200	29440.030.010	3,5X16MM	200	29440.035.016	4X12MM	200	29440.040.012
3X12MM	200	29440.030.012	3,5X20MM	200	29440.035.020	4X16MM	200	29440.040.016
3X16MM	200	29440.030.016	3,5X25MM	200	29440.035.025	4X20MM	200	29440.040.020
3X20MM	200	29440.030.020	3,5X30MM	200	29440.035.030	4X25MM	200	29440.040.025

29440 Wkręty do płyt wiórowych z łbem stożkowym z gniazdem krzyżowym Pozidriv

d x L	☒	Kod artykułu	d x L	☒	Kod artykułu	d x L	☒	Kod artykułu
4X30MM	200	29440.040.030	4,5X60MM	200	29440.045.060	5X100MM	200	29440.050.100
4X35MM	200	29440.040.035	4,5X70MM	200	29440.045.070	6X30MM	200	29440.060.030
4X40MM	200	29440.040.040	4,5X80MM	200	29440.045.080	6X40MM	200	29440.060.040
4X45MM	200	29440.040.045				6X50MM	200	29440.060.050
4X50MM	200	29440.040.050	5X20MM	200	29440.050.020	6X60MM	200	29440.060.060
4X60MM	200	29440.040.060	5X25MM	200	29440.050.025	6X70MM	200	29440.060.070
4X70MM	200	29440.040.070	5X30MM	200	29440.050.030	6X80MM	200	29440.060.080
4,5X16MM	200	29440.045.016	5X35MM	200	29440.050.035	6X90MM	200	29440.060.090
4,5X20MM	200	29440.045.020	5X40MM	200	29440.050.040	6X100MM	200	29440.060.100
4,5X25MM	200	29440.045.025	5X45MM	200	29440.050.045	6X110MM	200	29440.060.110
4,5X30MM	200	29440.045.030	5X50MM	200	29440.050.050	6X120MM	200	29440.060.120
4,5X35MM	200	29440.045.035	5X55MM	200	29440.050.055	6X130MM	200	29440.060.130
4,5X40MM	200	29440.045.040	5X60MM	200	29440.050.060	6X140MM	200	29440.060.140
4,5X45MM	200	29440.045.045	5X70MM	200	29440.050.070	6X150MM	200	29440.060.150
4,5X50MM	200	29440.045.050	5X80MM	200	29440.050.080			
			5X90MM	200	29440.050.090			

• Ostrzeżenie: cynkowanie elektrolityczne tych produktów może wywołać kruchość wodorową.

51750 Wkręty do płyt wiórowych z łbem stożkowym z gniazdem krzyżowym Pozidriv
R03A
Materiał Stal nierdzewna A2

6



d x L	☒	Kod artykułu	d x L	☒	Kod artykułu	d x L	☒	Kod artykułu
3X10MM	200	51750.030.010	4X25MM	200	51750.040.025	5X45MM	200	51750.050.045
3X12MM	200	51750.030.012	4X30MM	200	51750.040.030	5X50MM	200	51750.050.050
3X13MM	200	51750.030.013	4X35MM	200	51750.040.035	5X55MM*	200	51750.050.055
3X14MM	200	51750.030.014	4X40MM	200	51750.040.040	5X60MM	200	51750.050.060
3X16MM	200	51750.030.016	4X45MM	200	51750.040.045	5X65MM*	100	51750.050.065
3X20MM	200	51750.030.020	4X50MM	200	51750.040.050	5X70MM	200	51750.050.070
3X25MM	200	51750.030.025	4X60MM	200	51750.040.060	5X80MM	200	51750.050.080
3X30MM	200	51750.030.030	4X70MM	200	51750.040.070	5X90MM	100	51750.050.090
3X35MM	200	51750.030.035				5X100MM	100	51750.050.100
3X40MM	200	51750.030.040	4,5X20MM	200	51750.045.020	5X120MM	100	51750.050.120
3X50MM*	200	51750.030.050	4,5X25MM	200	51750.045.025	6X20MM*	100	51750.060.020
			4,5X30MM	200	51750.045.030	6X25MM*	100	51750.060.025
3,5X12MM*	500	51750.035.012	4,5X35MM	200	51750.045.035	6X30MM	100	51750.060.030
3,5X13MM	200	51750.035.013	4,5X40MM	200	51750.045.040	6X35MM	100	51750.060.035
3,5X16MM	200	51750.035.016	4,5X45MM	200	51750.045.045	6X40MM	100	51750.060.040
3,5X20MM	200	51750.035.020	4,5X50MM	200	51750.045.050	6X50MM	100	51750.060.050
3,5X25MM	200	51750.035.025	4,5X60MM	200	51750.045.060	6X60MM	100	51750.060.060
3,5X30MM	200	51750.035.030	4,5X70MM	200	51750.045.070	6X70MM	100	51750.060.070
3,5X35MM	200	51750.035.035				6X80MM	100	51750.060.080
3,5X40MM	200	51750.035.040	5X20MM	200	51750.050.020	6X90MM	100	51750.060.090
			5X25MM	200	51750.050.025	6X100MM	100	51750.060.100
4X12MM*	500	51750.040.012	5X30MM	200	51750.050.030	6X110MM	100	51750.060.110
4X16MM	200	51750.040.016	5X35MM	200	51750.050.035	6X120MM	100	51750.060.120
4X20MM	200	51750.040.020	5X40MM	200	51750.050.040			

55750 Wkręty do płyt wiórowych z łbem stożkowym z gniazdem krzyżowym Pozidriv
R43A
Materiał Stal nierdzewna A4

d x L	☒	Kod artykułu	d x L	☒	Kod artykułu	d x L	☒	Kod artykułu
3X12MM	200	55750.030.012	4X20MM	200	55750.040.020	5X20MM*	500	55750.050.020
3X16MM	200	55750.030.016	4X25MM	200	55750.040.025	5X30MM	200	55750.050.030
3X20MM	200	55750.030.020	4X30MM	200	55750.040.030	5X40MM	200	55750.050.040
3X25MM	200	55750.030.025	4X35MM	200	55750.040.035	5X50MM	200	55750.050.050
3X30MM	200	55750.030.030	4X40MM	200	55750.040.040	5X60MM	200	55750.050.060
			4X45MM	200	55750.040.045	5X65MM*	100	55750.050.065
3,5X12MM	200	55750.035.012	4X50MM	200	55750.040.050	5X70MM	200	55750.050.070
3,5X16MM	200	55750.035.016	4X60MM	200	55750.040.060			
3,5X20MM	200	55750.035.020	4X70MM*	200	55750.040.070	6X40MM	100	55750.060.040
3,5X25MM	200	55750.035.025				6X50MM*	100	55750.060.050
3,5X30MM	200	55750.035.030	4,5X20MM*	500	55750.045.020	6X60MM	100	55750.060.060
3,5X35MM	200	55750.035.035	4,5X40MM*	200	55750.045.040	6X70MM	100	55750.060.070
3,5X40MM	200	55750.035.040	4,5X45MM*	200	55750.045.045	6X80MM	100	55750.060.080
			4,5X50MM*	200	55750.045.050	6X90MM	100	55750.060.090
4X12MM	200	55750.040.012	4,5X60MM*	200	55750.045.060			
4X16MM	200	55750.040.016	4,5X70MM*	200	55750.045.070			

29349 HECO TOPIX Wkręty do płyt wiórowych z łbem stożkowym z gniazdem krzyżowym Pozidriv K04A

Materiał Stal
Obróbka powierzchni Ocynkowane





d x L	☒	Kod artykułu	d x L	☒	Kod artykułu	d x L	☒	Kod artykułu
3,5X20MM	1000	29349.035.020	4X50MM	500	29349.040.050	5X60MM	200	29349.050.060
3,5X25MM	1000	29349.035.025	4X60MM	200	29349.040.060	5X70MM	200	29349.050.070
3,5X30MM	1000	29349.035.030	4X70MM	200	29349.040.070	5X80MM	200	29349.050.080
3,5X35MM	1000	29349.035.035				5X90MM	200	29349.050.090
3,5X40MM	500	29349.035.040	4,5X30MM	500	29349.045.030	5X100MM	200	29349.050.100
3,5X45MM	500	29349.035.045	4,5X35MM	500	29349.045.035	5X120MM	100	29349.050.120
3,5X50MM	500	29349.035.050	4,5X40MM	500	29349.045.040			
			4,5X45MM	500	29349.045.045	6X50MM	200	29349.060.050
4X25MM	1000	29349.040.025	4,5X50MM	200	29349.045.050	6X80MM	200	29349.060.080
4X30MM	1000	29349.040.030	4,5X60MM	200	29349.045.060	6X100MM	100	29349.060.100
4X35MM	1000	29349.040.035				6X110MM	100	29349.060.110
4X40MM	500	29349.040.040	5X40MM	500	29349.050.040	6X120MM	100	29349.060.120
4X45MM	500	29349.040.045	5X50MM	200	29349.050.050			

• Ostrzeżenie: cynkowanie elektrolityczne tych produktów może wywołać kruchość wodorową.

29353 HECO TOPIX Wkręty do płyt wiórowych z łbem stożkowym z gniazdem krzyżowym Pozidriv K04A

Materiał Stal
Obróbka powierzchni Ocynkowane, po żółtej pasywacji





d x L	☒	Kod artykułu	d x L	☒	Kod artykułu	d x L	☒	Kod artykułu
3,5X15MM	1000	29353.035.015	4X60MM	200	29353.040.060	5X60MM	200	29353.050.060
3,5X30MM	1000	29353.035.030				5X70MM	200	29353.050.070
3,5X35MM	1000	29353.035.035	4,5X30MM	500	29353.045.030	5X80MM	200	29353.050.080
			4,5X35MM	500	29353.045.035			
4X25MM	1000	29353.040.025	4,5X40MM	500	29353.045.040	6X80MM	100	29353.060.080
4X30MM	1000	29353.040.030	4,5X70MM	200	29353.045.070	6X90MM	100	29353.060.090
4X35MM	500	29353.040.035				6X100MM	100	29353.060.100
4X40MM	500	29353.040.040	5X40MM	500	29353.050.040	6X120MM	100	29353.060.120
4X50MM	500	29353.040.050	5X50MM	200	29353.050.050			

• Ostrzeżenie: cynkowanie elektrolityczne tych produktów może wywołać kruchość wodorową.

29370 HECO UNIX PLUS Wkręty z łbem stożkowym z gniazdem krzyżowym Pozidriv K04A

Materiał Stal
Obróbka powierzchni Ocynkowane

d x L	☒	Kod artykułu	d x L	☒	Kod artykułu	d x L	☒	Kod artykułu
3,5X20MM	1000	29370.035.020	4X60MM	200	29370.040.060	5X45MM	200	29370.050.045
3,5X25MM	1000	29370.035.025				5X50MM	200	29370.050.050
3,5X30MM	1000	29370.035.030	4,5X25MM	500	29370.045.025	5X60MM	200	29370.050.060
3,5X35MM	1000	29370.035.035	4,5X30MM	500	29370.045.030	5X80MM	200	29370.050.080
3,5X40MM	500	29370.035.040	4,5X35MM	500	29370.045.035			
3,5X50MM	500	29370.035.050	4,5X40MM	500	29370.045.040	6X35MM	200	29370.060.035
			4,5X45MM	500	29370.045.045	6X40MM	200	29370.060.040
4X25MM	1000	29370.040.025	4,5X50MM	200	29370.045.050	6X45MM	200	29370.060.045
4X30MM	1000	29370.040.030	4,5X60MM	200	29370.045.060	6X50MM	200	29370.060.050
4X35MM	500	29370.040.035				6X60MM	200	29370.060.060
4X40MM	500	29370.040.040	5X30MM	500	29370.050.030	6X80MM	100	29370.060.080
4X45MM	500	29370.040.045	5X35MM	500	29370.050.035	6X100MM	100	29370.060.100
4X50MM	500	29370.040.050	5X40MM	500	29370.050.040	6X120MM	100	29370.060.120

• Ostrzeżenie: cynkowanie elektrolityczne tych produktów może wywołać kruchość wodorową.

Wkręty do płyt wiórowych z łbem stożkowym z gniazdem krzyżowym

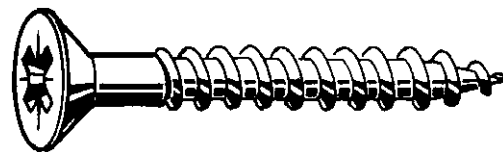
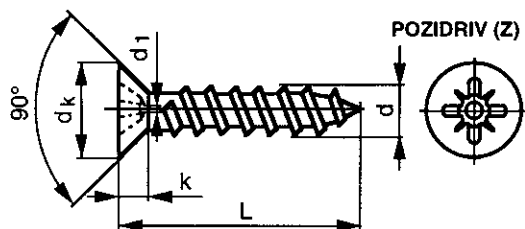

Informacje techniczne

d	d ₁	d _k	k	Nr wgłębienia krzyżowego
4	2.5	8	2.6	2
4.5	2.5	9	2.9	2
5	2.5	10	3.2	2
6	2.5	12	3.9	3

- Wszystkie wymiary są wartościami sugerowanymi i mogą się różnić w zależności od producenta.

29385 Wkręty do płyt wiórowych z łbem stożkowym z gniazdem krzyżowym ze zmniejszonym łbem

K03A

Materiał Stal
Obróbka powierzchni O cynkowane



6

d x L	☒	Kod artykułu	d x L	☒	Kod artykułu	d x L	☒	Kod artykułu
4X50MM	200	29385.040.050	4,5X60MM	200	29385.045.060	6X50MM	200	29385.060.050
4,5X20MM	200	29385.045.020	4,5X70MM	200	29385.045.070	6X60MM	100	29385.060.060
4,5X25MM	200	29385.045.025	5X40MM	200	29385.050.040	6X70MM	100	29385.060.070
4,5X30MM	200	29385.045.030	5X50MM	200	29385.050.050	6X80MM	100	29385.060.080
4,5X35MM	200	29385.045.035	5X60MM	200	29385.050.060	6X90MM	100	29385.060.090
4,5X40MM	200	29385.045.040	5X70MM	200	29385.050.070	6X100MM	100	29385.060.100
4,5X45MM	200	29385.045.045	5X80MM	200	29385.050.080	6X110MM	100	29385.060.110
4,5X50MM	200	29385.045.050	5X100MM	200	29385.050.100			

- Ostrzeżenie: cynkowanie elektrolityczne tych produktów może wywołać kruchość wodorową.

Wkręty do płyt wiórowych z łbem stożkowym z gniazdem krzyżowym Pozidriv

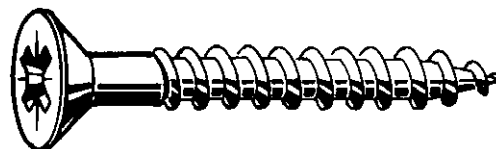
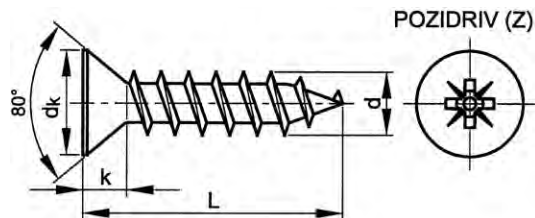

Informacje techniczne

d	d _k	k	Nr wgłębienia krzyżowego
3	5	1.9	1

- Wszystkie wymiary są wartościami sugerowanymi i mogą się różnić w zależności od producenta.

29243 Wkręty do płyt wiórowych z łbem stożkowym z gniazdem krzyżowym Pozidriv, ze zmniejszonym łbem

K03A

Materiał Stal
Obróbka powierzchni Ocynkowane, po żółtej pasywacji



d x L	☒	Kod artykułu	d x L	☒	Kod artykułu	d x L	☒	Kod artykułu
3X13MM	200	29243.030.013	3X17MM	200	29243.030.017	3X25MM	200	29243.030.025
3X15MM	200	29243.030.015	3X20MM	200	29243.030.020			

- Ostrzeżenie: cynkowanie elektrolityczne tych produktów może wywołać kruchość wodorową.

Wkręty do płyt wiórowych z łbem stożkowym z gniazdem sześciokąrnym

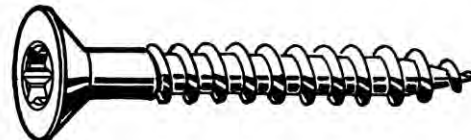
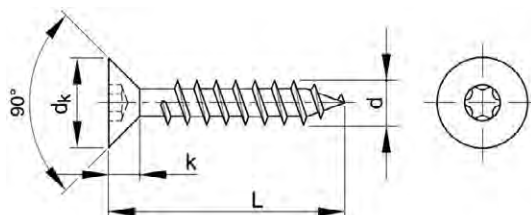

Informacje techniczne

d	d _k	k	Nasadka	d	d _k	k	Nasadka
3	6	1.9	T10	5	10	3.2	T25
3.5	7	2.3	T15	6	12	3.5	T30
4	8	2.6	T20	8	14	4.1	T40
4.5	9	2.9	T25				

- Wszystkie wymiary są wartościami sugerowanymi i mogą się różnić w zależności od producenta.

Grupy katalogowe

Gniazdo	Materiał	Obróbka powierzchni	Kod	Strona
Sześciokąrnym	St	Ocynk.	29310	6-160
Sześciokąrnym	St	Ocynk.	HECO-TOPIX	6-160
Sześciokąrnym	St	Ocynk.	HECO-UNIX TOP	6-160
Sześciokąrnym	St.St. A2		51775	6-161
Sześciokąrnym	St.St. A4		55775	6-161

29310 Wkręty do płyt wiórowych z łbem stożkowym z gniazdem sześciokątnym K01A

Materiał Stal
Obróbka powierzchni Ocynkowane



d x L	☒	Kod artykułu	d x L	☒	Kod artykułu	d x L	☒	Kod artykułu
3X16MM	200	29310.030.016	4X30MM	200	29310.040.030	4,5X70MM	200	29310.045.070
3X20MM	200	29310.030.020	4X35MM	200	29310.040.035	5X20MM	1000	29310.050.020
3X25MM	200	29310.030.025	4X40MM	200	29310.040.040	5X25MM	1000	29310.050.025
3X30MM	200	29310.030.030	4X45MM	200	29310.040.045	5X30MM	200	29310.050.030
3,5X16MM	200	29310.035.016	4X50MM	200	29310.040.050	5X35MM	200	29310.050.035
3,5X20MM	200	29310.035.020	4X60MM	200	29310.040.060	5X40MM	200	29310.050.040
3,5X25MM	200	29310.035.025	4,5X20MM	200	29310.045.020	5X45MM	200	29310.050.045
3,5X30MM	200	29310.035.030	4,5X25MM	200	29310.045.025	5X50MM	200	29310.050.050
3,5X35MM	200	29310.035.035	4,5X30MM	200	29310.045.030	5X60MM	200	29310.050.060
3,5X40MM	200	29310.035.040	4,5X35MM	200	29310.045.035	5X70MM	200	29310.050.070
4X16MM	200	29310.040.016	4,5X40MM	200	29310.045.040	5X80MM	200	29310.050.080
4X20MM	200	29310.040.020	4,5X45MM	200	29310.045.045	5X90MM	200	29310.050.090
4X25MM	200	29310.040.025	4,5X50MM	200	29310.045.050	5X100MM	200	29310.050.100
			4,5X60MM	200	29310.045.060			

• Ostrzeżenie: cynkowanie elektrolityczne tych produktów może wywołać kruchość wodorową.

29360 HECO TOPIX Wkręty do płyt wiórowych z łbem stożkowym z gniazdem sześciokątnym K04A

Materiał Stal
Obróbka powierzchni Ocynkowane



d x L	☒	Kod artykułu	d x L	☒	Kod artykułu	d x L	☒	Kod artykułu
3,5X30MM	1000	29360.035.030	4,5X40MM	500	29360.045.040	5X100MM	200	29360.050.100
3,5X35MM	1000	29360.035.035	4,5X45MM	500	29360.045.045	6X50MM	200	29360.060.050
3,5X40MM	500	29360.035.040	4,5X50MM	200	29360.045.050	6X60MM	200	29360.060.060
3,5X50MM	500	29360.035.050	4,5X60MM	200	29360.045.060	6X70MM	200	29360.060.070
4X30MM	1000	29360.040.030	4,5X70MM	200	29360.045.070	6X80MM	100	29360.060.080
4X35MM	500	29360.040.035	4,5X80MM	200	29360.045.080	6X90MM	100	29360.060.090
4X40MM	500	29360.040.040	5X40MM	500	29360.050.040	6X100MM	100	29360.060.100
4X45MM	500	29360.040.045	5X50MM	200	29360.050.050	6X120MM	100	29360.060.120
4X50MM	500	29360.040.050	5X60MM	200	29360.050.060	6X140MM	100	29360.060.140
4X60MM	200	29360.040.060	5X70MM	200	29360.050.070	6X160MM	100	29360.060.160
4X70MM	200	29360.040.070	5X80MM	200	29360.050.080	6X180MM	100	29360.060.180
			5X90MM	200	29360.050.090	6X200MM	100	29360.060.200

• Ostrzeżenie: cynkowanie elektrolityczne tych produktów może wywołać kruchość wodorową.

29375 HECO UNIX TOP Wkręty do płyt wiórowych z łbem stożkowym z gniazdem sześciokątnym K04A

Materiał Stal
Obróbka powierzchni Ocynkowane





d x L	☒	Kod artykułu	d x L	☒	Kod artykułu	d x L	☒	Kod artykułu
3,5X30MM	1000	29375.035.030	4,5X40MM	500	29375.045.040	5X90MM	200	29375.050.090
3,5X35MM	1000	29375.035.035	4,5X45MM	500	29375.045.045	5X100MM	100	29375.050.100
3,5X40MM	500	29375.035.040	4,5X50MM	200	29375.045.050	5X120MM	100	29375.050.120
3,5X45MM	500	29375.035.045	4,5X60MM	200	29375.045.060	6X50MM	200	29375.060.050
3,5X50MM	500	29375.035.050	4,5X70MM	200	29375.045.070	6X60MM	200	29375.060.060
4X35MM	500	29375.040.035	4,5X80MM	200	29375.045.080	6X70MM	200	29375.060.070
4X40MM	500	29375.040.040	5X40MM	500	29375.050.040	6X80MM	100	29375.060.080
4X45MM	500	29375.040.045	5X45MM	200	29375.050.045	6X90MM	100	29375.060.090
4X50MM	500	29375.040.050	5X50MM	200	29375.050.050	6X100MM	100	29375.060.100
4X60MM	200	29375.040.060	5X60MM	200	29375.050.060	6X120MM	100	29375.060.120
4X70MM	200	29375.040.070	5X70MM	200	29375.050.070	6X140MM	100	29375.060.140
			5X80MM	200	29375.050.080	6X160MM	100	29375.060.160

• Ostrzeżenie: cynkowanie elektrolityczne tych produktów może wywołać kruchość wodorową.

51775 **Wkręty do płyt wiórowych z łbem stożkowym z gniazdem sześciokątnym** **R03A**

Material Stal nierdzewna A2





d x L	☒	Kod artykułu	d x L	☒	Kod artykułu	d x L	☒	Kod artykułu
3X10MM*	500	51775.030.010	4X40MM	200	51775.040.040	5X60MM	200	51775.050.060
3X12MM*	500	51775.030.012	4X45MM	200	51775.040.045	5X65MM*	100	51775.050.065
3X16MM	200	51775.030.016	4X50MM	200	51775.040.050	5X70MM	200	51775.050.070
3X20MM	200	51775.030.020	4X60MM	200	51775.040.060	5X80MM	100	51775.050.080
3X25MM	200	51775.030.025	4X70MM	200	51775.040.070	5X90MM	100	51775.050.090
3X30MM	200	51775.030.030				5X100MM*	100	51775.050.100
3X35MM	200	51775.030.035	4,5X20MM	200	51775.045.020	5X120MM	100	51775.050.120
3X40MM	200	51775.030.040	4,5X25MM	200	51775.045.025			
3X50MM*	200	51775.030.050	4,5X30MM	200	51775.045.030	6X20MM*	100	51775.060.020
			4,5X35MM	200	51775.045.035	6X25MM*	100	51775.060.025
3,5X12MM*	500	51775.035.012	4,5X40MM	200	51775.045.040	6X30MM*	100	51775.060.030
3,5X16MM	200	51775.035.016	4,5X45MM	200	51775.045.045	6X35MM*	100	51775.060.035
3,5X20MM	200	51775.035.020	4,5X50MM	200	51775.045.050	6X40MM	100	51775.060.040
3,5X25MM	200	51775.035.025	4,5X60MM	200	51775.045.060	6X50MM*	100	51775.060.050
3,5X30MM	200	51775.035.030	4,5X70MM*	200	51775.045.070	6X60MM	100	51775.060.060
3,5X35MM	200	51775.035.035				6X70MM*	100	51775.060.070
3,5X40MM	200	51775.035.040	5X20MM	200	51775.050.020	6X80MM	100	51775.060.080
			5X25MM	200	51775.050.025	6X90MM*	100	51775.060.090
4X12MM*	500	51775.040.012	5X30MM	200	51775.050.030	6X100MM*	100	51775.060.100
4X16MM	200	51775.040.016	5X35MM	200	51775.050.035	6X120MM	100	51775.060.120
4X20MM	200	51775.040.020	5X40MM	200	51775.050.040			
4X25MM	200	51775.040.025	5X45MM	200	51775.050.045	8X60MM*	100	51775.080.060
4X30MM	200	51775.040.030	5X50MM	200	51775.050.050	8X90MM	100	51775.080.090
4X35MM	200	51775.040.035	5X55MM*	200	51775.050.055			

6

55775 **Wkręty do płyt wiórowych z łbem stożkowym z gniazdem sześciokątnym** **R43A**

Material Stal nierdzewna A4

d x L	☒	Kod artykułu	d x L	☒	Kod artykułu	d x L	☒	Kod artykułu
3X16MM*	200	55775.030.016	4X30MM*	200	55775.040.030	5X20MM*	200	55775.050.020
3X20MM*	200	55775.030.020	4X35MM*	200	55775.040.035	5X25MM*	200	55775.050.025
3X25MM*	200	55775.030.025	4X40MM*	200	55775.040.040	5X30MM*	200	55775.050.030
3X30MM*	200	55775.030.030	4X45MM*	200	55775.040.045	5X35MM*	200	55775.050.035
3X40MM*	200	55775.030.040	4X50MM*	200	55775.040.050	5X40MM*	200	55775.050.040
			4X60MM*	200	55775.040.060	5X45MM*	200	55775.050.045
3,5X16MM*	200	55775.035.016				5X50MM*	200	55775.050.050
3,5X20MM*	200	55775.035.020	4,5X20MM*	200	55775.045.020	5X55MM*	200	55775.050.055
3,5X25MM*	200	55775.035.025	4,5X25MM*	200	55775.045.025	5X60MM*	100	55775.050.060
3,5X30MM*	200	55775.035.030	4,5X30MM*	200	55775.045.030	5X70MM*	100	55775.050.070
3,5X35MM*	200	55775.035.035	4,5X35MM*	200	55775.045.035	5X80MM*	100	55775.050.080
3,5X40MM*	200	55775.035.040	4,5X40MM*	200	55775.045.040	5X90MM*	100	55775.050.090
3,5X45MM*	200	55775.035.045	4,5X45MM*	200	55775.045.045	5X100MM*	100	55775.050.100
			4,5X50MM*	200	55775.045.050	5X120MM*	100	55775.050.120
4X16MM*	200	55775.040.016	4,5X55MM*	200	55775.045.055			
4X20MM*	200	55775.040.020	4,5X60MM*	200	55775.045.060			
4X25MM*	200	55775.040.025	4,5X70MM*	200	55775.045.070			

Wkręty do płyt wiórowych z łbem stożkowym z gniazdem sześciokarbowym

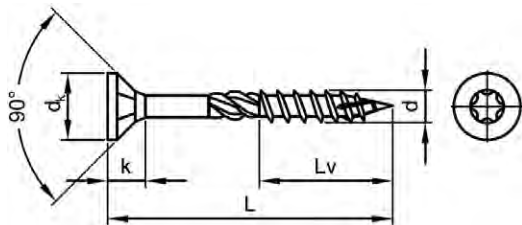

Informacje techniczne

d	d _k (maks.)	k (maks.)	Nasadka
3.5	7.0	2.1	T15
4	8.0	2.5	T15
4.5	9.0	2.7	T25
5	9.7	3.0	T25
6	11.8	3.6	T25

51773 HECO TOPIX Wkręty do płyt wiórowych z łbem stożkowym z gniazdem sześciokarbowym

K04A

Materiał Stal nierdzewna A2



6

d x L	☒	Kod artykułu	d x L	☒	Kod artykułu	d x L	☒	Kod artykułu
3,5X30MM	200	51773.035.030	4,5X40MM	200	51773.045.040	5X70MM	200	51773.050.070
3,5X35MM	200	51773.035.035	4,5X45MM	200	51773.045.045	5X80MM	200	51773.050.080
3,5X40MM	200	51773.035.040	4,5X50MM	200	51773.045.050	5X90MM	200	51773.050.090
3,5X45MM	200	51773.035.045	4,5X60MM	200	51773.045.060	5X100MM	200	51773.050.100
3,5X50MM	200	51773.035.050	4,5X70MM	200	51773.045.070	6X50MM	200	51773.060.050
4X30MM	200	51773.040.030	4,5X80MM	200	51773.045.080	6X60MM	200	51773.060.060
4X35MM	200	51773.040.035	5X40MM	200	51773.050.040	6X70MM	200	51773.060.070
4X40MM	200	51773.040.040	5X45MM	200	51773.050.045	6X80MM	100	51773.060.080
4X45MM	200	51773.040.045	5X50MM	200	51773.050.050	6X90MM	200	51773.060.090
4X50MM	200	51773.040.050	5X60MM	200	51773.050.060	6X100MM	100	51773.060.100
4X60MM	200	51773.040.060				6X120MM	100	51773.060.120

Wkręty A4 do płyt wiórowych, łeb stożkowy żebrowany

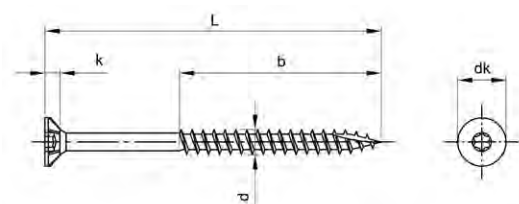

Informacje techniczne

d	d _k	k	Nasadka
3	6	1.9	T10
3.5	7	2.1	T10
4	8	2.5	T20
4.5	9	2.7	T20
5	10	3	T25
6	12	3.6	T25

55755 Wkręty A4 do płyt wiórowych, łeb stożkowy żebrowany

R43A

Materiał Stal nierdzewna A4



6

d x L x b	☒	Kod artykułu	d x L x b	☒	Kod artykułu	d x L x b	☒	Kod artykułu
3X12x12MM*	500	55755.030.012	4X45x30MM*	200	55755.040.045	5X45x30MM*	200	55755.050.045
3X16x16MM*	500	55755.030.016	4X50x30MM*	200	55755.040.050	5X50x30MM*	200	55755.050.050
3X20x20MM*	500	55755.030.020	4X60x36MM*	200	55755.040.060	5X55x36MM*	200	55755.050.055
3X25x18MM*	500	55755.030.025	4X70x42MM*	200	55755.040.070	5X60x36MM*	100	55755.050.060
3X30x18MM*	500	55755.030.030				5X70x42MM*	100	55755.050.070
3X40x24MM*	200	55755.030.040	4,5X20x20MM*	500	55755.045.020	5X80x48MM*	100	55755.050.080
			4,5X25x18MM*	500	55755.045.025	5X90x54MM*	100	55755.050.090
3,5X16x16MM*	500	55755.035.016	4,5X30x18MM*	500	55755.045.030	5X100x60MM*	100	55755.050.100
3,5X20x20MM*	500	55755.035.020	4,5X35x24MM*	500	55755.045.035	5X120x70MM*	100	55755.050.120
3,5X25x18MM*	500	55755.035.025	4,5X40x24MM*	200	55755.045.040			
3,5X30x18MM*	500	55755.035.030	4,5X45x30MM*	200	55755.045.045	6X30x20MM*	100	55755.060.030
3,5X35x24MM*	500	55755.035.035	4,5X50x30MM*	200	55755.045.050	6X40x24MM*	100	55755.060.040
3,5X40x24MM*	200	55755.035.040	4,5X55x36MM*	200	55755.045.055	6X45x30MM*	100	55755.060.045
3,5X45x30MM*	200	55755.035.045	4,5X60x36MM*	200	55755.045.060	6X50x30MM*	100	55755.060.050
3,5X50x30MM*	200	55755.035.050	4,5X70x42MM*	200	55755.045.070	6X60x36MM*	100	55755.060.060
			4,5X80x48MM*	200	55755.045.080	6X70x42MM*	100	55755.060.070
4X16x16MM*	500	55755.040.016				6X80x48MM*	100	55755.060.080
4X20x20MM*	500	55755.040.020	5X20x20MM*	500	55755.050.020	6X90x54MM*	100	55755.060.090
4X25x18MM*	500	55755.040.025	5X25x18MM*	500	55755.050.025	6X100x70MM*	100	55755.060.100
4X30x18MM*	500	55755.040.030	5X30x20MM*	500	55755.050.030	6X110x70MM*	100	55755.060.110
4X35x24MM*	500	55755.040.035	5X35x24MM*	500	55755.050.035	6X120x70MM*	100	55755.060.120
4X40x24MM*	200	55755.040.040	5X40x24MM*	200	55755.050.040			

Wkręty do drewna łeb stożkowy płaski obniżony z ttap®

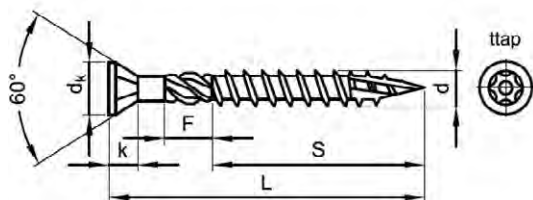

Informacje techniczne

d	dk	k	Nr ttap
5	9	5.1	20

- Tylko pełne opakowania.
- F=9mm tylko wtedy, gdy L≥40mm.

30250 MAXXFAST Wkręt do drewna uniwersalny z łebem stożkowym płaskim obniżonym z ttap® MF0A

Materiał Stal nierdzewna A2

MAXXFAST
PROFESSIONAL HARDWARE



CE



d x L (S)	☒	Kod artykułu	d x L (S)	☒	Kod artykułu	d x L (S)	☒	Kod artykułu
5X40MM (25)	200	30250.050.040	5X50MM (35)	200	30250.050.050	5X70MM (55)	100	30250.050.070
5X45MM (30)	200	30250.050.045	5X60MM (45)	100	30250.050.060	5X80MM (65)	100	30250.050.080

6

Wkręty do drewna z łebem stożkowym płaskim obniżonym z gniazdem sześciokątnym

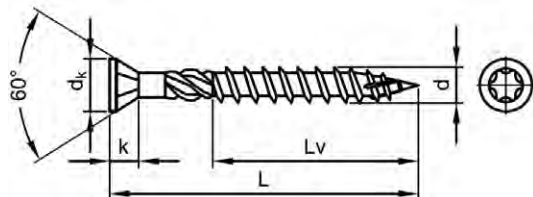

Informacje techniczne

d	dk (maks.)	k (maks.)	Nasadka
5	8.5	2.7	T25

51774 HECO TOPIX Wkręty do drewna z łebem stożkowym płaskim obniżonym z gniazdem sześciokątnym K04A

Materiał Stal nierdzewna A2

HECO
SCHRAUBEN



d x L	☒	Kod artykułu	d x L	☒	Kod artykułu	d x L	☒	Kod artykułu
5X40MM	200	51774.050.040	5X60MM	200	51774.050.060	5X80MM	200	51774.050.080
5X50MM	200	51774.050.050	5X70MM	200	51774.050.070			

Wkręty tarasowe z łbem walcowym

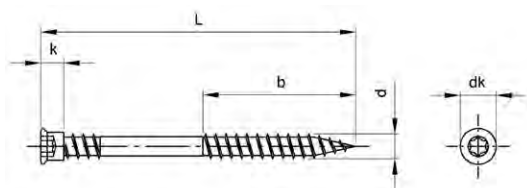

Informacje techniczne

d	d _k	k	Nasadka
5.5	8	5.1	No.25

55561 Wkręty tarasowe z łbem walcowym

R03A
Materiał Stal nierdzewna A4

d x L x b	☒	Kod artykułu	d x L x b	☒	Kod artykułu	d x L x b	☒	Kod artykułu
5,5X40X18MM*	100	55561.055.040	5,5X70X34MM*	100	55561.055.070	5,5X90X36MM*	100	55561.055.090
5,5X50X18MM*	100	55561.055.050	5,5X80X36MM*	100	55561.055.080	5,5X100X36MM*	100	55561.055.100
5,5X60X24MM*	100	55561.055.060						

6

Wkręt do drewna uniwersalny z łbem walcowo soczewkowym z gniazdem krzyżowym

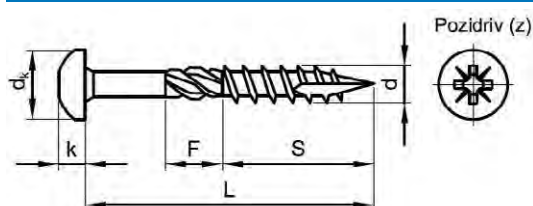

Informacje techniczne

d	d _k	k	Nr wgłębienia krzyżowego	d	d _k	k	Nr wgłębienia krzyżowego
3	6	2.4	1	4.5	9	3.2	2
3.5	7	2.6	2	5	10	3.6	2
4	8	3.0	2	6	12	4.9	3

- Tylko pełne opakowania.
- F=9mm tylko wtedy, gdy L≥40mm.
- Średnice 3 oraz 3,5 nie są przystosowane do konstrukcji drewnianych i z tego powodu nie są znakowane CE

Grupy katalogowe

Gniazdo	Materiał	Obróbka powierzchni	Kod	Strona
Pozidriv	St	Ocynk.	30025	6-165
Pozidriv	St	Ocynk. żłt. pas.	30030	6-166
Pozidriv	St.St. A2		30040	6-166

30025 MAXXFAST Wkręt do drewna uniwersalny z łbem walcowo soczewkowym z gniazdem krzyżowym

MF0A
Materiał Stal
Obróbka powierzchni Ocynkowane

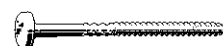
MAXXFAST
 PROFESSIONAL HARDWARE

CE

d x L (S)	☒	Kod artykułu	d x L (S)	☒	Kod artykułu	d x L (S)	☒	Kod artykułu
3X12MM (9)	200	30025.030.012	3,5X16MM (13)	200	30025.035.016	4X12MM (9)	200	30025.040.012
3X16MM (13)	200	30025.030.016	3,5X20MM (17)	200	30025.035.020	4X16MM (13)	200	30025.040.016
3X20MM (17)	200	30025.030.020	3,5X25MM (22)	200	30025.035.025	4X20MM (17)	200	30025.040.020
3X25MM (22)	200	30025.030.025	3,5X30MM (27)	200	30025.035.030	4X25MM (22)	200	30025.040.025
3X30MM (27)	200	30025.030.030	3,5X35MM (32)	200	30025.035.035	4X30MM (27)	200	30025.040.030
			3,5X40MM (25)	200	30025.035.040	4X35MM (32)	200	30025.040.035
3,5X12MM (9)	200	30025.035.012				4X40MM (25)	200	30025.040.040

30025 MAXXFAST Wkręt do drewna uniwersalny z łbem walcowo soczewkowym z gniazdem krzyżowym

d x L (S)	☒	Kod artykułu	d x L (S)	☒	Kod artykułu	d x L (S)	☒	Kod artykułu
4X45MM (30)	200	30025.040.045	4,5X50MM (35)	200	30025.045.050	5X70MM (54)	200	30025.050.070
4X50MM (35)	200	30025.040.050				5X80MM (54)	100	30025.050.080
4X60MM (45)	200	30025.040.060	5X16MM (12)	200	30025.050.016			
			5X20MM (16)	200	30025.050.020	6X30MM (25)	200	30025.060.030
4,5X16MM (12)	200	30025.045.016	5X25MM (21)	200	30025.050.025	6X40MM (25)	200	30025.060.040
4,5X20MM (16)	200	30025.045.020	5X30MM (26)	200	30025.050.030	6X50MM (35)	200	30025.060.050
4,5X25MM (21)	200	30025.045.025	5X35MM (31)	200	30025.050.035	6X60MM (45)	200	30025.060.060
4,5X30MM (26)	200	30025.045.030	5X40MM (25)	200	30025.050.040	6X80MM (54)	100	30025.060.080
4,5X35MM (31)	200	30025.045.035	5X45MM (30)	200	30025.050.045	6X100MM (66)	100	30025.060.100
4,5X40MM (25)	200	30025.045.040	5X50MM (35)	200	30025.050.050			
4,5X45MM (30)	200	30025.045.045	5X60MM (45)	200	30025.050.060			

30030 MAXXFAST Wkręt do drewna uniwersalny z łbem walcowo soczewkowym z gniazdem krzyżowym Pozidriv MF0A

Materiał Stal
Obróbka powierzchni Ocynkowane, po żółtej pasywacji

MAXXFAST
 PROFESSIONAL HARDWARE

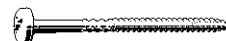

CE

d x L (S)	☒	Kod artykułu	d x L (S)	☒	Kod artykułu	d x L (S)	☒	Kod artykułu
3X12MM (9)	200	30030.030.012	4X30MM (27)	200	30030.040.030	5X25MM (21)	200	30030.050.025
3X16MM (13)	200	30030.030.016	4X35MM (32)	200	30030.040.035	5X30MM (26)	200	30030.050.030
3X20MM (17)	200	30030.030.020	4X40MM (25)	200	30030.040.040	5X35MM (31)	200	30030.050.035
3X25MM (22)	200	30030.030.025	4X45MM (30)	200	30030.040.045	5X40MM (25)	200	30030.050.040
3X30MM (27)	200	30030.030.030	4X50MM (35)	200	30030.040.050	5X45MM (30)	200	30030.050.045
			4X60MM (45)	200	30030.040.060	5X50MM (35)	200	30030.050.050
3,5X12MM (9)	200	30030.035.012				5X60MM (45)	200	30030.050.060
3,5X16MM (13)	200	30030.035.016	4,5X16MM (12)	200	30030.045.016	5X70MM (54)	200	30030.050.070
3,5X20MM (17)	200	30030.035.020	4,5X20MM (16)	200	30030.045.020	5X80MM (54)	100	30030.050.080
3,5X25MM (22)	200	30030.035.025	4,5X25MM (21)	200	30030.045.025			
3,5X30MM (27)	200	30030.035.030	4,5X30MM (26)	200	30030.045.030	6X30MM (25)	200	30030.060.030
3,5X35MM (32)	200	30030.035.035	4,5X35MM (31)	200	30030.045.035	6X40MM (25)	200	30030.060.040
3,5X40MM (25)	200	30030.035.040	4,5X40MM (25)	200	30030.045.040	6X50MM (35)	200	30030.060.050
			4,5X45MM (30)	200	30030.045.045	6X60MM (45)	200	30030.060.060
4X12MM (9)	200	30030.040.012	4,5X50MM (35)	200	30030.045.050	6X80MM (54)	100	30030.060.080
4X16MM (13)	200	30030.040.016				6X100MM (66)	100	30030.060.100
4X20MM (17)	200	30030.040.020	5X16MM (12)	200	30030.050.016			
4X25MM (22)	200	30030.040.025	5X20MM (16)	200	30030.050.020			

30040 MAXXFAST Wkręt do drewna uniwersalny z łbem walcowo soczewkowym z gniazdem krzyżowym Pozidriv MF0A

Materiał Stal nierdzewna A2

MAXXFAST
 PROFESSIONAL HARDWARE

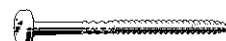

CE



d x L (S)	☒	Kod artykułu	d x L (S)	☒	Kod artykułu	d x L (S)	☒	Kod artykułu
3X16MM (13)	200	30040.030.016	4X16MM (13)	200	30040.040.016	5X20MM (16)	200	30040.050.020
3X20MM (17)	200	30040.030.020	4X20MM (17)	200	30040.040.020	5X25MM (21)	200	30040.050.025
3X25MM (22)	200	30040.030.025	4X25MM (22)	200	30040.040.025	5X30MM (26)	200	30040.050.030
3X30MM (27)	200	30040.030.030	4X30MM (27)	200	30040.040.030	5X40MM (25)	200	30040.050.040
			4X35MM (32)	200	30040.040.035	5X50MM (35)	200	30040.050.050
3,5X16MM (13)	200	30040.035.016	4X40MM (25)	200	30040.040.040	5X60MM (45)	200	30040.050.060
3,5X20MM (17)	200	30040.035.020	4X45MM (30)	200	30040.040.045			
3,5X25MM (22)	200	30040.035.025	4X50MM (35)	200	30040.040.050			
3,5X30MM (27)	200	30040.035.030						

Wkręt do drewna uniwersalny z łbem walcowo soczewkowym z ttap®

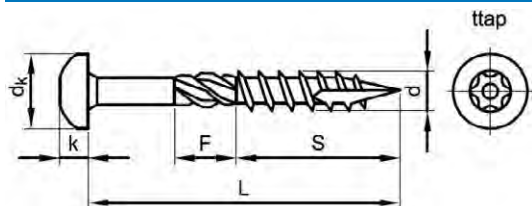

Informacje techniczne

d	dk	k	Nr ttap	d	dk	k	Nr ttap
3	6	2.4	10	4.5	9	3.2	20
3.5	7	2.6	15	5	10	3.6	25
4	8	2.9	20	6	12	4.2	25

- Tylko pełne opakowania.
- F=9mm tylko wtedy, gdy L≥40mm.
- Średnice 3 oraz 3,5 nie są przystosowane do konstrukcji drewnianych i z tego powodu nie są znakowane CE

Grupy katalogowe

Gniazdo	Materiał	Obróbka powierzchni	Kod	Strona
ttap®	St	Ocynk.	30125	6-167
ttap®	St	Ocynk. żłt. pas.	30130	6-167
ttap®	St.St. A2		30140	6-168

30125 MAXXFAST Wkręt do drewna uniwersalny z łbem walcowo soczewkowym z ttap®

MF0A

Materiał Stal
Obróbka powierzchni Ocynkowane

MAXXFAST
PROFESSIONAL HARDWARE

CE

d x L (S)	☒	Kod artykułu	d x L (S)	☒	Kod artykułu	d x L (S)	☒	Kod artykułu
3X12MM (9)	200	30125.030.012	4X30MM (27)	200	30125.040.030	5X20MM (16)	200	30125.050.020
3X16MM (13)	200	30125.030.016	4X35MM (32)	200	30125.040.035	5X25MM (21)	200	30125.050.025
3X20MM (17)	200	30125.030.020	4X40MM (25)	200	30125.040.040	5X30MM (26)	200	30125.050.030
3X25MM (22)	200	30125.030.025	4X45MM (30)	200	30125.040.045	5X35MM (31)	200	30125.050.035
3X30MM (27)	200	30125.030.030	4X50MM (35)	200	30125.040.050	5X40MM (25)	200	30125.050.040
			4X60MM (45)	200	30125.040.060	5X45MM (30)	200	30125.050.045
3,5X12MM (9)	200	30125.035.012				5X50MM (35)	200	30125.050.050
3,5X16MM (13)	200	30125.035.016	4,5X16MM (12)	200	30125.045.016	5X60MM (45)	200	30125.050.060
3,5X20MM (17)	200	30125.035.020	4,5X20MM (16)	200	30125.045.020	5X70MM (54)	200	30125.050.070
3,5X25MM (22)	200	30125.035.025	4,5X25MM (21)	200	30125.045.025	5X80MM (54)	100	30125.050.080
3,5X30MM (27)	200	30125.035.030	4,5X30MM (26)	200	30125.045.030			
3,5X35MM (32)	200	30125.035.035	4,5X35MM (31)	200	30125.045.035	6X30MM (25)	200	30125.060.030
3,5X40MM (25)	200	30125.035.040	4,5X40MM (25)	200	30125.045.040	6X40MM (25)	200	30125.060.040
			4,5X45MM (30)	200	30125.045.045	6X50MM (35)	200	30125.060.050
4X12MM (9)	200	30125.040.012	4,5X50MM (35)	200	30125.045.050	6X60MM (45)	200	30125.060.060
4X16MM (13)	200	30125.040.016				6X80MM (54)	100	30125.060.080
4X20MM (17)	200	30125.040.020	5X16MM (12)	200	30125.050.016	6X100MM (66)	100	30125.060.100
4X25MM (22)	200	30125.040.025						

30130 MAXXFAST Wkręt do drewna uniwersalny z łbem walcowo soczewkowym z ttap®

MF0A

Materiał Stal
Obróbka powierzchni Ocynkowane, po żółtej pasywacji

MAXXFAST
PROFESSIONAL HARDWARE

CE

d x L (S)	☒	Kod artykułu	d x L (S)	☒	Kod artykułu	d x L (S)	☒	Kod artykułu
3X12MM (9)	200	30130.030.012	3,5X40MM (25)	200	30130.035.040	4,5X16MM (12)	200	30130.045.016
3X16MM (13)	200	30130.030.016				4,5X20MM (16)	200	30130.045.020
3X20MM (17)	200	30130.030.020	4X12MM (9)	200	30130.040.012	4,5X25MM (21)	200	30130.045.025
3X25MM (22)	200	30130.030.025	4X16MM (13)	200	30130.040.016	4,5X30MM (26)	200	30130.045.030
3X30MM (27)	200	30130.030.030	4X20MM (17)	200	30130.040.020	4,5X35MM (31)	200	30130.045.035
			4X25MM (22)	200	30130.040.025	4,5X40MM (25)	200	30130.045.040
3,5X12MM (9)	200	30130.035.012	4X30MM (27)	200	30130.040.030	4,5X45MM (30)	200	30130.045.045
3,5X16MM (13)	200	30130.035.016	4X35MM (32)	200	30130.040.035	4,5X50MM (35)	200	30130.045.050
3,5X20MM (17)	200	30130.035.020	4X40MM (25)	200	30130.040.040			
3,5X25MM (22)	200	30130.035.025	4X45MM (30)	200	30130.040.045	5X16MM (12)	200	30130.050.016
3,5X30MM (27)	200	30130.035.030	4X50MM (35)	200	30130.040.050	5X20MM (16)	200	30130.050.020
3,5X35MM (32)	200	30130.035.035	4X60MM (45)	200	30130.040.060			

30130 MAXXFAST Wkręt do drewna uniwersalny z łbem walcowo soczewkowym z ttap®								
d x L (S)	☒	Kod artykułu	d x L (S)	☒	Kod artykułu	d x L (S)	☒	Kod artykułu
5X25MM (21)	200	30130.050.025	5X60MM (45)	200	30130.050.060	6X50MM (35)	200	30130.060.050
5X30MM (26)	200	30130.050.030	5X70MM (54)	200	30130.050.070	6X60MM (45)	200	30130.060.060
5X35MM (31)	200	30130.050.035	5X80MM (54)	100	30130.050.080	6X80MM (54)	100	30130.060.080
5X40MM (25)	200	30130.050.040				6X100MM (66)	100	30130.060.100
5X45MM (30)	200	30130.050.045	6X30MM (25)	200	30130.060.030			
5X50MM (35)	200	30130.050.050	6X40MM (25)	200	30130.060.040			

30140 MAXXFAST Wkręt do drewna uniwersalny z łbem walcowo soczewkowym z ttap®								MF0A
Materiał		Stal nierdzewna A2						
CE								

d x L (S)	☒	Kod artykułu	d x L (S)	☒	Kod artykułu	d x L (S)	☒	Kod artykułu
3X16MM (13)	200	30140.030.016	4X16MM (13)	200	30140.040.016	5X20MM (16)	200	30140.050.020
3X20MM (17)	200	30140.030.020	4X20MM (17)	200	30140.040.020	5X25MM (21)	200	30140.050.025
3X25MM (22)	200	30140.030.025	4X25MM (22)	200	30140.040.025	5X30MM (26)	200	30140.050.030
3X30MM (27)	200	30140.030.030	4X30MM (27)	200	30140.040.030	5X40MM (25)	200	30140.050.040
3,5X16MM (13)	200	30140.035.016	4X35MM (32)	200	30140.040.035	5X50MM (35)	200	30140.050.050
3,5X20MM (17)	200	30140.035.020	4X40MM (25)	200	30140.040.040	5X60MM (45)	200	30140.050.060
3,5X25MM (22)	200	30140.035.025	4X45MM (30)	200	30140.040.045			
3,5X30MM (27)	200	30140.035.030	4X50MM (35)	200	30140.040.050			

6

Wkręty z łbem wypukłym soczewkowym z gniazdem krzyżowym

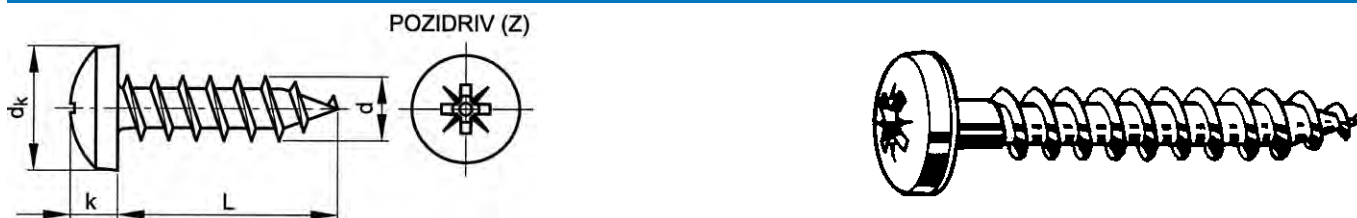

Informacje techniczne

d	dk (maks.)	k (maks.)	Nr wgłębienia krzyżowego
2.5	5	2.12	1
3	5.9	2.2	1
3.5	6.9	2.6	2
4	7.9	2.8	2
4.5	8.9	3.05	2
5	9.6	3.4	2
5.5	10.5	4.2	3
6	11.6	4	3

- Wszystkie wymiary są wartościami sugerowanymi i mogą się różnić w zależności od producenta.

Grupy katalogowe

Gniazdo	Materiał	Obróbka powierzchni	Kod	Strona
Pozidriv	St	Ocynk.	29340	6-168
Pozidriv	St	Ocynk.	HECO-FIX PLUS 29345	6-169
Pozidriv	St.St. A2		51770	6-169

29340 Wkręty do płyt wiórowych z łbem walcowym wypukłym z gniazdem krzyżowym Pozidriv								K01A
Materiał		Stal						
Obróbka powierzchni		Ocynkowane						

d x L	☒	Kod artykułu	d x L	☒	Kod artykułu	d x L	☒	Kod artykułu
3X12MM	200	29340.030.012	3,5X12MM	200	29340.035.012	3,5X30MM	200	29340.035.030
3X16MM	200	29340.030.016	3,5X16MM	200	29340.035.016	3,5X35MM	200	29340.035.035
3X20MM	200	29340.030.020	3,5X20MM	200	29340.035.020	3,5X40MM	200	29340.035.040
3X25MM	200	29340.030.025	3,5X25MM	200	29340.035.025	4X12MM	200	29340.040.012

29340 Wkręty do płyt wiórowych z łbem walcowym wypukłym z gniazdem krzyżowym Pozidriv								
d x L	☒	Kod artykułu	d x L	☒	Kod artykułu	d x L	☒	Kod artykułu
4X16MM	200	29340.040.016	4,5X20MM	200	29340.045.020	5X25MM	200	29340.050.025
4X20MM	200	29340.040.020	4,5X25MM	200	29340.045.025	5X30MM	200	29340.050.030
4X25MM	200	29340.040.025	4,5X30MM	200	29340.045.030	5X35MM	200	29340.050.035
4X30MM	200	29340.040.030	4,5X35MM	200	29340.045.035	5X40MM	200	29340.050.040
4X35MM	200	29340.040.035	4,5X40MM	200	29340.045.040	5X45MM	200	29340.050.045
4X40MM	200	29340.040.040	4,5X45MM	200	29340.045.045	5X50MM	200	29340.050.050
4X45MM	200	29340.040.045	4,5X50MM	200	29340.045.050	5X60MM	200	29340.050.060
4X50MM	200	29340.040.050	5X16MM	200	29340.050.016	5X70MM	200	29340.050.070
4,5X16MM	200	29340.045.016	5X20MM	200	29340.050.020	5X80MM	200	29340.050.080

• Ostrzeżenie: cynkowanie elektrolityczne tych produktów może wywołać kruchość wodorową.

29345 HECO-FIX PLUS Wkręty do płyt wiórowych z łbem walcowym wypukłym z gniazdem krzyżowym Pozidriv								K04A
Materiał	Stal							
Obróbka powierzchni	Ocynkowane							

d x L	☒	Kod artykułu	d x L	☒	Kod artykułu	d x L	☒	Kod artykułu
2,5X12MM	1000	29345.025.012	4X16MM	200	29345.040.016	5X20MM	200	29345.050.020
2,5X16MM	200	29345.025.016	4X20MM	200	29345.040.020	5X25MM	200	29345.050.025
			4X25MM	200	29345.040.025	5X30MM	200	29345.050.030
3X12MM	200	29345.030.012	4X30MM	200	29345.040.030	5X35MM	200	29345.050.035
3X15MM	200	29345.030.015	4X35MM	200	29345.040.035	5X40MM	200	29345.050.040
3X16MM	200	29345.030.016	4X40MM	200	29345.040.040	5X45MM	200	29345.050.045
3X20MM	200	29345.030.020	4X45MM	200	29345.040.045	5X50MM	200	29345.050.050
3X25MM	200	29345.030.025	4X50MM	200	29345.040.050	5X60MM	200	29345.050.060
3X30MM	200	29345.030.030	4X60MM	200	29345.040.060	5X70MM	200	29345.050.070
						5X80MM	200	29345.050.080
3,5X15MM	200	29345.035.015	4,5X15MM	200	29345.045.015	6X30MM	200	29345.060.030
3,5X16MM	200	29345.035.016	4,5X16MM	200	29345.045.016	6X35MM	200	29345.060.035
3,5X20MM	200	29345.035.020	4,5X20MM	200	29345.045.020	6X40MM	200	29345.060.040
3,5X25MM	200	29345.035.025	4,5X25MM	200	29345.045.025	6X50MM	200	29345.060.050
3,5X30MM	200	29345.035.030	4,5X30MM	200	29345.045.030	6X60MM	200	29345.060.060
3,5X35MM	200	29345.035.035	4,5X40MM	200	29345.045.040	6X70MM	200	29345.060.070
3,5X40MM	200	29345.035.040	4,5X45MM	200	29345.045.045	6X80MM	200	29345.060.080
4X12MM	200	29345.040.012	4,5X50MM	200	29345.045.050			
4X15MM	200	29345.040.015	4,5X60MM	200	29345.045.060			

- Cechy szczególne śrub do płyt wiórowych HECO-FIX PLUS:
- Zmniejszenie wymaganego momentu obrotowego napędu o do 30%.
- Łatwiejsze wykorzystanie.
- Znacząco lepsze efekty przy wkręcaniu przy pomocy wkręteków akumulatorowych.
- Zmniejszenie sił osiowych, tym samym zmniejszając zużycie końcówek wkrętaka.
- Dzięki geometrii zębów uzyskiwany jest wyższy moment obrotowy przy odkręcaniu, a w związku z tym uzyskane jest bezpieczne połączenie wkręcane.
- Ostrzeżenie: cynkowanie elektrolityczne tych produktów może wywołać kruchość wodorową.

51770 Wkręty do płyt wiórowych z łbem walcowym wypukłym z gniazdem krzyżowym Pozidriv								R03A
Materiał	Stal nierdzewna A2							

d x L	☒	Kod artykułu	d x L	☒	Kod artykułu	d x L	☒	Kod artykułu
3X16MM	200	51770.030.016	4X45MM	200	51770.040.045	5X35MM	200	51770.050.035
3X20MM	200	51770.030.020	4X50MM	200	51770.040.050	5X40MM	200	51770.050.040
3X25MM	200	51770.030.025	4X60MM	200	51770.040.060	5X45MM	200	51770.050.045
3X30MM	200	51770.030.030	4X70MM*	200	51770.040.070	5X50MM	200	51770.050.050
3X35MM*	500	51770.030.035				5X60MM	100	51770.050.060
			4,5X16MM*	500	51770.045.016	5X70MM	100	51770.050.070
3,5X16MM	200	51770.035.016	4,5X20MM*	500	51770.045.020	5X80MM	100	51770.050.080
3,5X20MM	200	51770.035.020	4,5X25MM*	500	51770.045.025	5X90MM	100	51770.050.090
3,5X25MM	200	51770.035.025	4,5X30MM	200	51770.045.030	5X100MM	100	51770.050.100
3,5X30MM	200	51770.035.030	4,5X35MM	200	51770.045.035			
3,5X35MM	200	51770.035.035	4,5X40MM	200	51770.045.040	5,5X50MM*	200	51770.055.050
3,5X40MM	200	51770.035.040	4,5X45MM*	200	51770.045.045			
			4,5X50MM	200	51770.045.050	6X20MM*	100	51770.060.020
4X16MM	200	51770.040.016	4,5X60MM*	200	51770.045.060	6X25MM*	100	51770.060.025
4X20MM	200	51770.040.020	4,5X70MM*	200	51770.045.070	6X30MM*	100	51770.060.030
4X25MM	200	51770.040.025				6X35MM*	100	51770.060.035
4X30MM	200	51770.040.030	5X20MM	200	51770.050.020	6X40MM*	100	51770.060.040
4X35MM	200	51770.040.035	5X25MM	200	51770.050.025	6X50MM*	100	51770.060.050
4X40MM	200	51770.040.040	5X30MM	200	51770.050.030	6X60MM*	100	51770.060.060

51770 Wkręty do płyt wiórowych z łbem walcowym wypukłym z gniazdem krzyżowym Pozidriv								
d x L	☒	Kod artykułu	d x L	☒	Kod artykułu	d x L	☒	Kod artykułu
6X70MM*	100	51770.060.070	6X100MM*	100	51770.060.100	6X130MM*	100	51770.060.130
6X80MM*	100	51770.060.080	6X110MM*	100	51770.060.110			
6X90MM*	100	51770.060.090	6X120MM*	100	51770.060.120			

Wkręty do drewna z łbem tłoczonym z gniazdem sześciokarbowym

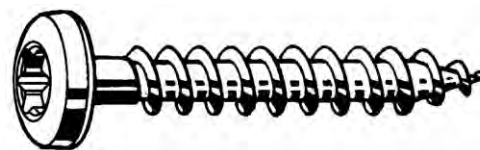
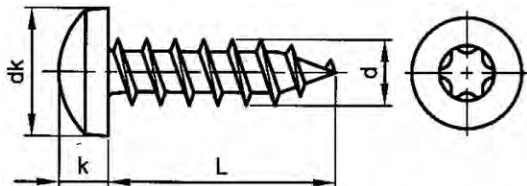

Informacje techniczne

d	dk	k	Nasadka	d	dk	k	Nasadka
3	5.7/6.0	2.1/2.3	T10	4.5	8.7/9.0	2.9/3.1	T25
3.5	6.7/7.0	2.2/2.4	T15	5	9.7/10.0	3.3/3.5	T25
4	7.7/8.0	2.6/2.8	T20				

29346 Wkręty do drewna z łbem tłoczonym z gniazdem sześciokarbowym K01A

Materiał: Stal
Obróbka powierzchni: Ocynkowane



d x L	☒	Kod artykułu	d x L	☒	Kod artykułu	d x L	☒	Kod artykułu
3X10MM	1000	29346.030.010	4X12MM	1000	29346.040.012	4,5X30MM	500	29346.045.030
3X12MM	1000	29346.030.012	4X13MM	1000	29346.040.013	4,5X35MM	500	29346.045.035
3X13MM	1000	29346.030.013	4X15MM	1000	29346.040.015	4,5X40MM	500	29346.045.040
3X15MM	1000	29346.030.015	4X16MM	1000	29346.040.016	4,5X45MM	500	29346.045.045
3X16MM	1000	29346.030.016	4X16MM	1000	29346.040.016	4,5X50MM	200	29346.045.050
3X20MM	1000	29346.030.020	4X20MM	1000	29346.040.020	4,5X60MM	200	29346.045.060
3X25MM	1000	29346.030.025	4X25MM	1000	29346.040.025	4,5X70MM	200	29346.045.070
3X30MM	1000	29346.030.030	4X30MM	1000	29346.040.030			
3X35MM	500	29346.030.035	4X35MM	500	29346.040.035	5X16MM	1000	29346.050.016
3X40MM	500	29346.030.040	4X40MM	500	29346.040.040	5X20MM	1000	29346.050.020
			4X45MM	500	29346.040.045	5X25MM	500	29346.050.025
3,5X16MM	1000	29346.035.016	4X50MM	500	29346.040.050	5X30MM	500	29346.050.030
3,5X20MM	1000	29346.035.020	4X60MM	500	29346.040.060	5X35MM	500	29346.050.035
3,5X25MM	1000	29346.035.025	4X70MM	500	29346.040.070	5X40MM	500	29346.050.040
3,5X30MM	1000	29346.035.030				5X45MM	200	29346.050.045
3,5X35MM	1000	29346.035.035	4,5X15MM	1000	29346.045.015	5X50MM	200	29346.050.050
3,5X40MM	500	29346.035.040	4,5X16MM	1000	29346.045.016	5X60MM	200	29346.050.060
3,5X45MM	500	29346.035.045	4,5X20MM	1000	29346.045.020	5X70MM	200	29346.050.070
3,5X50MM	500	29346.035.050	4,5X25MM	500	29346.045.025	5X80MM	200	29346.050.080

Wkręty z łbem soczewkowym z gniazdem sześciokarbowym

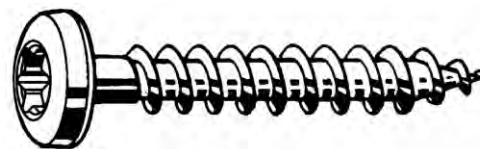
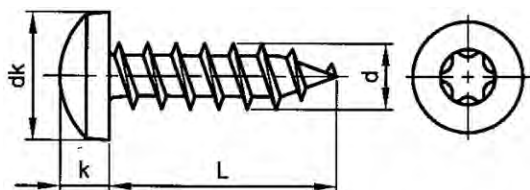

Informacje techniczne

d	d _k	k	Nasadka
6	13	3	T30
7	14	3	T30

51789 Wkręty z łbem soczewkowym z gniazdem sześciokarbowym

R03A

Materiał Stal nierdzewna A2



d _s x L	☒	Kod artykułu	d _s x L	☒	Kod artykułu	d _s x L	☒	Kod artykułu
6X20MM*	200	51789.060.020	6X45MM*	200	51789.060.045	7X40MM*	200	51789.070.040
6X25MM*	200	51789.060.025	6X50MM*	200	51789.060.050	7X50MM*	200	51789.070.050
6X30MM*	200	51789.060.030				7X60MM*	200	51789.070.060
6X35MM*	200	51789.060.035	7X30MM*	200	51789.070.030	7X70MM*	200	51789.070.070
6X40MM*	200	51789.060.040	7X35MM*	200	51789.070.035			

6

Wkręty do płyt wiórowych z łbem stożkowym soczewkowym z gniazdem krzyżowym

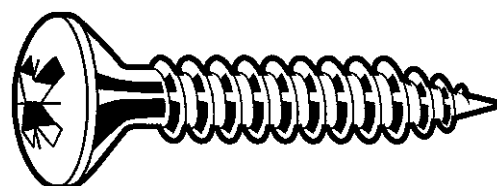
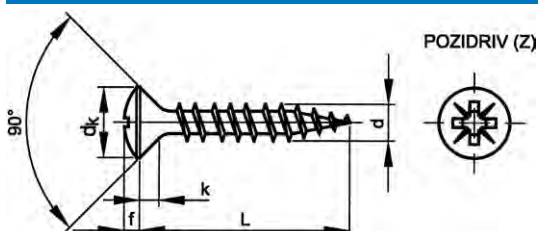

Informacje techniczne

d	d _k (maks.)	f ≈	k (maks.)	Nr wgłębienia krzyżowego
3	5.9	0.7	1.9	1
3.5	6.9	0.9	2.1	2
4	7.9	1.05	2.45	2
4.5	8.9	1.2	2.7	2
5	9.6	1.2	3.1	2
6	11.6	1.6	3.7	3

Grupy katalogowe

Gniazdo	Materiał	Obróbka powierzchni	Kod	Strona
Pozidriv	St	Ocynk.	29367	6-171
Pozidriv	St.St. A2		51756	6-172

29367 HECO-FIX PLUS Wkręty do płyt wiórowych z łbem stożkowym soczewkowym z gniazdem krzyżowym Pozidriv

K04A

Materiał Stal
Obróbka powierzchni Ocynkowane

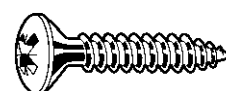

d x L	☒	Kod artykułu	d x L	☒	Kod artykułu	d x L	☒	Kod artykułu
3X20MM	1000	29367.030.020	3,5X25MM	1000	29367.035.025	4X20MM	1000	29367.040.020
3,5X16MM	1000	29367.035.016	3,5X30MM	1000	29367.035.030	4X30MM	1000	29367.040.030
3,5X20MM	1000	29367.035.020	3,5X35MM	1000	29367.035.035	4X35MM	500	29367.040.035
			3,5X40MM	500	29367.035.040			

29367 HECO-FIX PLUS Wkręty do płyt wiórowych z łbem stożkowym soczewkowym z gniazdem krzyżowym Pozidriv

d x L	☒	Kod artykułu	d x L	☒	Kod artykułu	d x L	☒	Kod artykułu
4X40MM	500	29367.040.040	4X50MM	500	29367.040.050	4,5X40MM	500	29367.045.040
4X45MM	500	29367.040.045						

- Cechy szczególne wkrętów do płyt wiórowych HECO-FIX PLUS:
- Zmniejszenie wymaganego momentu obrotowego napędu o do 30%.
- Łatwiejsze wykorzystanie.
- Znacząco lepsze efekty przy wkręcaniu przy pomocy wkrętaaków akumulatorowych.
- Zmniejszenie sił osiowych, tym samym zmniejszając zużycie końcówek wkrętaaka.
- Dzięki geometrii zębów uzyskiwany jest wyższy moment obrotowy przy odkręcaniu, a w związku z tym uzyskane jest bezpieczne połączenie wkręcane.
- Ostrzeżenie: cynkowanie elektrolityczne tych produktów może wywołać kruchość wodorową.

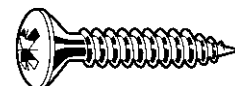
51756 Wkręty do płyt wiórowych z łbem stożkowym soczewkowym z gniazdem krzyżowym Pozidriv
R03A
Materiał Stal nierdzewna A2

d x L	☒	Kod artykułu	d x L	☒	Kod artykułu	d x L	☒	Kod artykułu
3X16MM	200	51756.030.016	4X45MM	200	51756.040.045	5X50MM	200	51756.050.050
3X20MM	200	51756.030.020	4X50MM	200	51756.040.050	5X60MM	200	51756.050.060
3X25MM	200	51756.030.025				5X70MM	200	51756.050.070
3X30MM	200	51756.030.030	4,5X20MM	200	51756.045.020	5X90MM	100	51756.050.090
			4,5X25MM	200	51756.045.025	5X100MM	100	51756.050.100
3,5X16MM	200	51756.035.016	4,5X30MM	200	51756.045.030			
3,5X20MM	200	51756.035.020	4,5X35MM	200	51756.045.035	6X20MM	200	51756.060.020
3,5X25MM	200	51756.035.025	4,5X40MM	200	51756.045.040	6X25MM	200	51756.060.025
3,5X30MM	200	51756.035.030	4,5X45MM	200	51756.045.045	6X30MM	100	51756.060.030
3,5X35MM	200	51756.035.035	4,5X50MM	200	51756.045.050	6X35MM	100	51756.060.035
3,5X40MM	200	51756.035.040	4,5X60MM	200	51756.045.060	6X40MM	100	51756.060.040
						6X45MM	100	51756.060.045
4X16MM	200	51756.040.016	5X20MM	200	51756.050.020	6X50MM	100	51756.060.050
4X20MM	200	51756.040.020	5X25MM	200	51756.050.025	6X60MM	100	51756.060.060
4X25MM	200	51756.040.025	5X30MM	200	51756.050.030	6X70MM	100	51756.060.070
4X30MM	200	51756.040.030	5X35MM	200	51756.050.035	6X80MM	100	51756.060.080
4X35MM	200	51756.040.035	5X40MM	200	51756.050.040	6X90MM	100	51756.060.090
4X40MM	200	51756.040.040	5X45MM	200	51756.050.045	6X100MM	100	51756.060.100

- Wszystkie wymiary są wartościami sugerowanymi i mogą się różnić w zależności od producenta.

Wkręty z łbem sześciokątnym do drewna

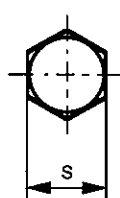
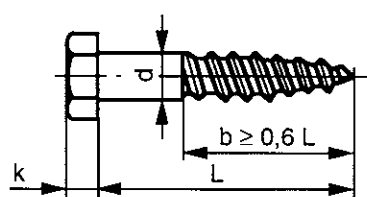

DIN 571
NEN 2260
NF E25-607

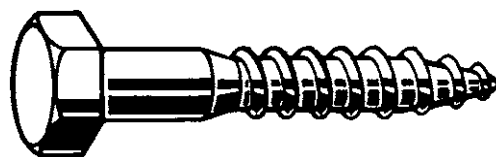

Informacje techniczne

d	k	s	d	k	s
4	2.8	7	10	7	17
5	3.5	8	12	8	19
6	4	10	16	10	24
7	5	12	20	13	30
8	5.5	13			

- Gwint wkrętu do drewna zgodny z DIN 7998.

Grupy katalogowe

Gniazdo	Materiał	Obróbka powierzchni	Kod	Strona
Sześciokąt	St	Ocynk.	08280	6-173
Sześciokąt	St	Ocynk. gor.	08450	6-174
Sześciokąt	St.St. A2		51900	6-174
Sześciokąt	St.St. A4		55900	6-175
Sześciokąt	St.St. A2	podkładki bitumowe	51890	6-176

6

08280 Wkręty z łbem sześciokątnym do drewna

E07A

Materiał Stal
Obróbka powierzchni Ocynkowane



d x L	☒	Kod artykułu	d x L	☒	Kod artykułu	d x L	☒	Kod artykułu
5X20MM	200	08280.050.020	7X90MM	100	08280.070.090	8X260MM	25	08280.080.260
5X25MM	200	08280.050.025	7X100MM	100	08280.070.100	8X280MM	25	08280.080.280
5X30MM	200	08280.050.030	7X110MM	100	08280.070.110	8X300MM	25	08280.080.300
5X35MM	200	08280.050.035	7X120MM	100	08280.070.120			
5X40MM	200	08280.050.040	7X130MM	100	08280.070.130	10X30MM	200	08280.100.030
5X45MM	200	08280.050.045	7X140MM	100	08280.070.140	10X35MM	100	08280.100.035
5X50MM	200	08280.050.050	7X150MM	100	08280.070.150	10X40MM	100	08280.100.040
5X60MM	200	08280.050.060	7X160MM	50	08280.070.160	10X45MM	100	08280.100.045
			7X170MM	50	08280.070.170	10X50MM	100	08280.100.050
6X20MM	200	08280.060.020	7X200MM	50	08280.070.200	10X55MM	100	08280.100.055
6X25MM	200	08280.060.025	7X210MM	50	08280.070.210	10X60MM	100	08280.100.060
6X30MM	200	08280.060.030	7X230MM	50	08280.070.230	10X65MM	100	08280.100.065
6X35MM	200	08280.060.035	7X250MM	50	08280.070.250	10X70MM	100	08280.100.070
6X40MM	200	08280.060.040	7X270MM	50	08280.070.270	10X80MM	100	08280.100.080
6X45MM	200	08280.060.045				10X90MM	100	08280.100.090
6X50MM	200	08280.060.050	8X25MM	200	08280.080.025	10X100MM	100	08280.100.100
6X55MM	200	08280.060.055	8X30MM	200	08280.080.030	10X110MM	50	08280.100.110
6X60MM	200	08280.060.060	8X35MM	200	08280.080.035	10X120MM	50	08280.100.120
6X65MM	200	08280.060.065	8X40MM	200	08280.080.040	10X130MM	50	08280.100.130
6X70MM	200	08280.060.070	8X45MM	200	08280.080.045	10X140MM	50	08280.100.140
6X80MM	200	08280.060.080	8X50MM	200	08280.080.050	10X150MM	50	08280.100.150
6X90MM	100	08280.060.090	8X55MM	200	08280.080.055	10X160MM	50	08280.100.160
6X100MM	100	08280.060.100	8X60MM	200	08280.080.060	10X180MM	50	08280.100.180
6X110MM	100	08280.060.110	8X65MM	200	08280.080.065	10X200MM	50	08280.100.200
6X120MM	100	08280.060.120	8X70MM	200	08280.080.070	10X220MM	25	08280.100.220
6X130MM	100	08280.060.130	8X80MM	200	08280.080.080	10X240MM	25	08280.100.240
6X140MM	100	08280.060.140	8X90MM	100	08280.080.090	10X260MM	25	08280.100.260
6X150MM	100	08280.060.150	8X100MM	100	08280.080.100	10X280MM	25	08280.100.280
6X160MM	100	08280.060.160	8X110MM	100	08280.080.110	10X300MM	25	08280.100.300
6X180MM	100	08280.060.180	8X120MM	100	08280.080.120			
6X200MM	100	08280.060.200	8X130MM	100	08280.080.130	12X40MM	100	08280.120.040
			8X140MM	50	08280.080.140	12X45MM	100	08280.120.045
7X35MM	100	08280.070.035	8X150MM	50	08280.080.150	12X50MM	100	08280.120.050
7X40MM	100	08280.070.040	8X160MM	50	08280.080.160	12X55MM	100	08280.120.055
7X50MM	100	08280.070.050	8X180MM	50	08280.080.180	12X60MM	100	08280.120.060
7X60MM	100	08280.070.060	8X200MM	50	08280.080.200	12X70MM	50	08280.120.070
7X70MM	100	08280.070.070	8X220MM	50	08280.080.220	12X80MM	50	08280.120.080
7X80MM	100	08280.070.080	8X240MM	50	08280.080.240	12X90MM	50	08280.120.090

08280 Wkręty z łbem sześciokątnym do drewna								
d x L	☒	Kod artykułu	d x L	☒	Kod artykułu	d x L	☒	Kod artykułu
12X100MM	50	08280.120.100	12X280MM	25	08280.120.280	16X160MM	25	08280.160.160
12X110MM	50	08280.120.110	12X300MM	25	08280.120.300	16X180MM	25	08280.160.180
12X120MM	50	08280.120.120				16X200MM	25	08280.160.200
12X130MM	50	08280.120.130	16X60MM	25	08280.160.060	16X220MM	25	08280.160.220
12X140MM	50	08280.120.140	16X70MM	25	08280.160.070			
12X150MM	50	08280.120.150	16X80MM	25	08280.160.080	20X120MM	25	08280.200.120
12X160MM	25	08280.120.160	16X90 MM	25	08280.160.090	20X140MM	25	08280.200.140
12X180MM	25	08280.120.180	16X100MM	25	08280.160.100	20X160MM	10	08280.200.160
12X200MM	25	08280.120.200	16X110MM	25	08280.160.110	20X180MM	10	08280.200.180
12X220MM	25	08280.120.220	16X120MM	25	08280.160.120	20X200MM	10	08280.200.200
12X240MM	25	08280.120.240	16X140MM	25	08280.160.140			
12X260MM	25	08280.120.260	16X150MM	25	08280.160.150			

08450 Wkręty z łbem sześciokątnym do drewna								A08A
Materiał	Stal							
Obróbka powierzchni	O cynkowane na gorąco							
								

d x L	☒	Kod artykułu	d x L	☒	Kod artykułu	d x L	☒	Kod artykułu
7X70MM	100	08450.070.070	10X50MM	100	08450.100.050	12X100MM	50	08450.120.100
7X8MM	100	08450.070.080	10X60MM	100	08450.100.060	12X120MM	50	08450.120.120
7X90MM	100	08450.070.090	10X70MM	100	08450.100.070	12X140MM	50	08450.120.140
7X120MM	100	08450.070.120	10X80MM	100	08450.100.080	12X150MM	50	08450.120.150
7X130MM	100	08450.070.130	10X90MM	100	08450.100.090	12X160MM	25	08450.120.160
7X150MM	100	08450.070.150	10X100MM	100	08450.100.100	12X180MM	25	08450.120.180
7X170MM	50	08450.070.170	10X110MM	50	08450.100.110	12X200MM	25	08450.120.200
7X190MM	50	08450.070.190	10X120MM	50	08450.100.120	12X220MM	25	08450.120.220
			10X130MM	50	08450.100.130	12X240MM	25	08450.120.240
			10X140MM	50	08450.100.140			
8X40MM	200	08450.080.040	10X150MM	50	08450.100.150	16X60MM	25	08450.160.060
8X50MM	200	08450.080.050	10X160MM	50	08450.100.160	16X80MM	25	08450.160.080
8X60MM	200	08450.080.060	10X180MM	50	08450.100.180	16X100MM	25	08450.160.100
8X70MM	200	08450.080.070	10X200MM	50	08450.100.200	16X120MM	25	08450.160.120
8X80MM	200	08450.080.080	10X220MM	25	08450.100.220	16X130MM	25	08450.160.130
8X90MM	100	08450.080.090	10X240MM	25	08450.100.240	16X140MM	25	08450.160.140
8X100MM	100	08450.080.100				16X160MM	25	08450.160.160
8X110MM	100	08450.080.110	12X60MM	100	08450.120.060	16X180MM	25	08450.160.180
8X120MM	100	08450.080.120	12X70MM	50	08450.120.070	16X200MM	25	08450.160.200
8X130MM	100	08450.080.130	12X80MM	50	08450.120.080	16X220MM	25	08450.160.220
8X140MM	50	08450.080.140	12X90MM	50	08450.120.090	16X240MM	25	08450.160.240
8X150MM	50	08450.080.150						

51900 Wkręty z łbem sześciokątnym do drewna								R03A
Materiał	Stal nierdzewna A2							
								

d x L	☒	Kod artykułu	d x L	☒	Kod artykułu	d x L	☒	Kod artykułu
4X20MM*	200	51900.040.020	6X55MM*	200	51900.060.055	7X130MM	25	51900.070.130
4X25MM	200	51900.040.025	6X60MM	50	51900.060.060	7X140MM*	100	51900.070.140
4X30MM*	200	51900.040.030	6X65MM*	100	51900.060.065	7X150MM	25	51900.070.150
4X40MM*	200	51900.040.040	6X70MM	50	51900.060.070	7X160MM*	100	51900.070.160
4X45MM*	200	51900.040.045	6X80MM	50	51900.060.080	7X170MM	25	51900.070.170
			6X90MM	50	51900.060.090	7X180MM*	100	51900.070.180
5X20MM*	200	51900.050.020	6X100MM	50	51900.060.100	7X190MM*	100	51900.070.190
5X25MM*	200	51900.050.025	6X110MM	25	51900.060.110	7X210MM*	100	51900.070.210
5X30MM	100	51900.050.030	6X120MM	25	51900.060.120			
5X35MM*	200	51900.050.035	6X130MM*	100	51900.060.130	8X25MM*	100	51900.080.025
5X40MM	100	51900.050.040	6X140MM*	100	51900.060.140	8X30MM	50	51900.080.030
5X45MM*	200	51900.050.045				8X35MM*	100	51900.080.035
5X50MM	100	51900.050.050	7X30MM	50	51900.070.030	8X40MM	50	51900.080.040
5X60MM	100	51900.050.060	7X35MM*	200	51900.070.035	8X45MM	50	51900.080.045
5X70MM	100	51900.050.070	7X40MM	50	51900.070.040	8X50MM	50	51900.080.050
5X80MM*	200	51900.050.080	7X45MM*	200	51900.070.045	8X55MM	50	51900.080.055
5X90MM*	200	51900.050.090	7X50MM	50	51900.070.050	8X60MM	50	51900.080.060
			7X60MM	50	51900.070.060	8X65MM*	100	51900.080.065
6X25MM	100	51900.060.025	7X70MM	50	51900.070.070	8X70MM	25	51900.080.070
6X30MM	100	51900.060.030	7X80MM	50	51900.070.080	8X75MM*	100	51900.080.075
6X35MM	100	51900.060.035	7X90MM	50	51900.070.090	8X80MM	25	51900.080.080
6X40MM	100	51900.060.040	7X100MM	50	51900.070.100	8X90MM	25	51900.080.090
6X45MM	100	51900.060.045	7X110MM	50	51900.070.110	8X100MM	25	51900.080.100
6X50MM	100	51900.060.050	7X120MM	25	51900.070.120	8X110MM	25	51900.080.110

51900 Wkręty z łbem sześciokątnym do drewna								
d x L	☒	Kod artykułu	d x L	☒	Kod artykułu	d x L	☒	Kod artykułu
8X120MM	10	51900.080.120	10X160MM	10	51900.100.160	12X220MM*	25	51900.120.220
8X130MM	10	51900.080.130	10X180MM	10	51900.100.180	12X240MM*	25	51900.120.240
8X140MM	10	51900.080.140	10X200MM	10	51900.100.200	12X250MM*	25	51900.120.250
8X150MM	10	51900.080.150	10X220MM*	50	51900.100.220	12X260MM*	25	51900.120.260
8X160MM	10	51900.080.160	10X240MM*	50	51900.100.240	12X280MM*	25	51900.120.280
8X180MM	10	51900.080.180	10X260MM*	25	51900.100.260	12X300MM*	25	51900.120.300
8X200MM	10	51900.080.200	10X280MM*	25	51900.100.280			
			10X300MM*	25	51900.100.300	16X50MM*	25	51900.160.050
10X40MM	25	51900.100.040				16X60MM*	25	51900.160.060
10X45MM*	100	51900.100.045	12X50MM	10	51900.120.050	16X70MM*	25	51900.160.070
10X50MM	25	51900.100.050	12X60MM	10	51900.120.060	16X80MM*	25	51900.160.080
10X55MM*	100	51900.100.055	12X70MM	10	51900.120.070	16X90MM*	25	51900.160.090
10X60MM	25	51900.100.060	12X80MM	10	51900.120.080	16X100MM*	25	51900.160.100
10X65MM*	100	51900.100.065	12X90MM	10	51900.120.090	16X110MM*	25	51900.160.110
10X70MM	25	51900.100.070	12X100MM	10	51900.120.100	16X120MM*	25	51900.160.120
10X80MM	10	51900.100.080	12X110MM	10	51900.120.110	16X130MM*	25	51900.160.130
10X90MM	10	51900.100.090	12X120MM	10	51900.120.120	16X140MM*	25	51900.160.140
10X100MM	10	51900.100.100	12X130MM	10	51900.120.130	16X150MM*	25	51900.160.150
10X110MM	10	51900.100.110	12X140MM	10	51900.120.140	16X160MM*	25	51900.160.160
10X120MM	10	51900.100.120	12X150MM	10	51900.120.150	16X180MM*	25	51900.160.180
10X130MM	10	51900.100.130	12X160MM	10	51900.120.160	16X200MM*	25	51900.160.200
10X140MM	10	51900.100.140	12X180MM	10	51900.120.180			
10X150MM	10	51900.100.150	12X200MM	10	51900.120.200			

55900 Wkręty z łbem sześciokątnym do drewna		R43A
Materiał	Stal nierdzewna A4	
		
		

d x L	☒	Kod artykułu	d x L	☒	Kod artykułu	d x L	☒	Kod artykułu
5X25MM*	200	55900.050.025	8X50MM	50	55900.080.050	10X200MM*	50	55900.100.200
5X30MM*	200	55900.050.030	8X60MM	50	55900.080.060			
5X35MM*	200	55900.050.035	8X65MM*	100	55900.080.065	12X50MM*	100	55900.120.050
5X40MM*	200	55900.050.040	8X70MM	25	55900.080.070	12X60MM*	100	55900.120.060
5X45MM*	200	55900.050.045	8X75MM*	100	55900.080.075	12X65MM*	100	55900.120.065
5X50MM*	200	55900.050.050	8X80MM	25	55900.080.080	12X70MM*	50	55900.120.070
5X60MM*	200	55900.050.060	8X90MM	25	55900.080.090	12X75MM*	50	55900.120.075
5X70MM*	200	55900.050.070	8X100MM	25	55900.080.100	12X80 MM	50	55900.120.080
			8X110MM*	100	55900.080.110	12X90MM*	50	55900.120.090
6X25MM	100	55900.060.025	8X120MM*	100	55900.080.120	12X100MM*	50	55900.120.100
6X30MM	100	55900.060.030	8X130MM*	100	55900.080.130	12X110MM*	25	55900.120.110
6X35MM*	200	55900.060.035	8X140MM*	50	55900.080.140	12X120MM*	25	55900.120.120
6X40MM	100	55900.060.040	8X150MM*	50	55900.080.150	12X130MM*	25	55900.120.130
6X45MM	100	55900.060.045	8X160MM*	50	55900.080.160	12X140MM*	25	55900.120.140
6X50MM	100	55900.060.050	8X180MM*	50	55900.080.180	12X150MM*	25	55900.120.150
6X60MM	50	55900.060.060	8X200MM*	50	55900.080.200	12X160MM*	25	55900.120.160
6X65MM*	100	55900.060.065				12X180MM*	25	55900.120.180
6X70MM	50	55900.060.070	10X40MM	25	55900.100.040	12X200MM*	25	55900.120.200
6X75MM*	100	55900.060.075	10X50MM	25	55900.100.050			
6X80MM	50	55900.060.080	10X55MM*	100	55900.100.055	16X50MM*	25	55900.160.050
6X90MM*	100	55900.060.090	10X60MM	25	55900.100.060	16X60MM*	25	55900.160.060
6X100MM*	100	55900.060.100	10X65MM*	100	55900.100.065	16X70MM*	25	55900.160.070
6X110MM*	100	55900.060.110	10X70MM	25	55900.100.070	16X80MM*	25	55900.160.080
6X120MM*	100	55900.060.120	10X75MM*	100	55900.100.075	16X90MM*	25	55900.160.090
6X130MM*	100	55900.060.130	10X80MM	10	55900.100.080	16X100MM*	25	55900.160.100
			10X90MM*	50	55900.100.090	16X110MM*	25	55900.160.110
7X100MM*	100	55900.070.100	10X100MM	10	55900.100.100	16X120MM*	25	55900.160.120
7X110MM	100	55900.070.110	10X110MM*	50	55900.100.110	16X130MM*	25	55900.160.130
			10X120MM*	50	55900.100.120	16X140MM*	25	55900.160.140
8X25MM*	100	55900.080.025	10X130MM*	50	55900.100.130	16X150MM*	25	55900.160.150
8X30MM	50	55900.080.030	10X140MM*	50	55900.100.140	16X160MM*	25	55900.160.160
8X35MM*	100	55900.080.035	10X150MM*	50	55900.100.150	16X180MM*	25	55900.160.180
8X40MM	50	55900.080.040	10X160MM*	50	55900.100.160	16X200MM*	25	55900.160.200
8X45MM*	100	55900.080.045	10X180MM*	50	55900.100.180			

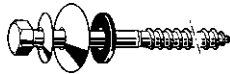
51890	Wkręty z łbem sześciokątnym do drewna, z podkładkami ze stali nierdzewnej i bitumu			R03A
Materiał	Stal nierdzewna A2	DIN	≈571	

d x L	☒	Kod artykułu	d x L	☒	Kod artykułu	d x L	☒	Kod artykułu
7X110MM	100	51890.070.110	7X130MM	100	51890.070.130	7X150MM	100	51890.070.150

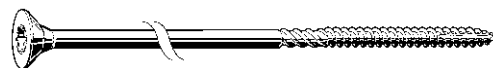
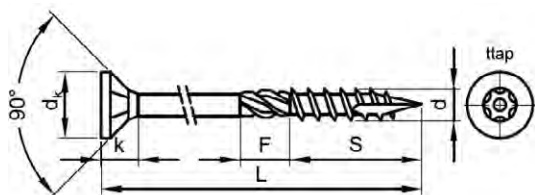

Wkręt do drewna konstrukcyjny uniwersalny z łbem stożkowym płaskim z ttap®



Informacje techniczne

d	dk	k	Nr ttap
6	12	3.8	30
8	15	4.8	40
10	18.4	5.8	40

- Tylko pełne opakowania.
- F=9mm tylko wtedy, gdy L≥40mm.

30205	MAXXFAST Wkręt do drewna konstrukcyjny z łbem stożkowym płaskim z ttap®			MF0A
Materiał	Stal			
Obróbka powierzchni	Ocynkowane, po żółtej pasywacji			
CE				

d x L (S)	☒	Kod artykułu	d x L (S)	☒	Kod artykułu	d x L (S)	☒	Kod artykułu
6X160MM (98)	50	30205.060.160	8X200MM (124)	50	30205.080.200	10X140MM (85)	50	30205.100.140
6X180MM (111)	50	30205.060.180	8X220MM (138)	50	30205.080.220	10X160MM (98)	50	30205.100.160
6X200MM (124)	50	30205.060.200	8X240MM (152)	50	30205.080.240	10X180MM (111)	50	30205.100.180
6X220MM (138)	50	30205.060.220	8X260MM (166)	50	30205.080.260	10X200MM (124)	50	30205.100.200
6X240MM (152)	50	30205.060.240	8X280MM (178)	50	30205.080.280	10X220MM (138)	50	30205.100.220
6X260MM (166)	50	30205.060.260	8X300MM (192)	50	30205.080.300	10X240MM (152)	50	30205.100.240
6X280MM (178)	50	30205.060.280	8X320MM (205)	50	30205.080.320	10X260MM (166)	50	30205.100.260
6X300MM (192)	50	30205.060.300	8X340MM (218)	50	30205.080.340	10X280MM (178)	50	30205.100.280
8X80MM (45)	50	30205.080.080	8X360MM (232)	50	30205.080.360	10X300MM (192)	50	30205.100.300
8X100MM (58)	50	30205.080.100	8X380MM (246)	50	30205.080.380	10X320MM (205)	50	30205.100.320
8X120MM (72)	50	30205.080.120	8X400MM (258)	50	30205.080.400	10X340MM (218)	50	30205.100.340
8X140MM (85)	50	30205.080.140	10X80MM (45)	50	30205.100.080	10X360MM (232)	50	30205.100.360
8X160MM (98)	50	30205.080.160	10X100MM (58)	50	30205.100.100	10X380MM (246)	50	30205.100.380
8X180MM (111)	50	30205.080.180	10X120MM (72)	50	30205.100.120	10X400MM (258)	50	30205.100.400

Wkręty do drewna konstrukcyjne uniwersalne z kołnierzem z gniazdem ttap®

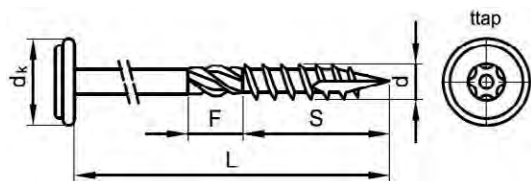

Informacje techniczne

d	dk	k	Nr ttap
6	15	3.3	30
8	18	4.2	40
10	21	4.7	40

- Tylko pełne opakowania.
- F=9mm tylko wtedy, gdy L≥40mm.

Grupy katalogowe

Gniazdo	Materiał	Obróbka powierzchni	Kod	Strona
ttap®	St	Ocynk. żłt. pas.	30225	6-177
ttap®	St.St. A2		30230	6-177

30225 MAXXFAST Wkręty do drewna konstrukcyjne z kołnierzem z gniazdem ttap®

MF0A

Materiał Stal
Obróbka powierzchni Ocynkowane, po żółtej pasywacji

MAXXFAST
PROFESSIONAL HARDWARE



CE

d x L (S)	☒	Kod artykułu	d x L (S)	☒	Kod artykułu	d x L (S)	☒	Kod artykułu
6X80MM (45)	100	30225.060.080	8X140MM (85)	50	30225.080.140	10X100MM (58)	50	30225.100.100
6X100MM (58)	100	30225.060.100	8X160MM (98)	50	30225.080.160	10X120MM (72)	50	30225.100.120
6X120MM (72)	100	30225.060.120	8X180MM (111)	50	30225.080.180	10X140MM (85)	50	30225.100.140
6X140MM (85)	100	30225.060.140	8X200MM (124)	50	30225.080.200	10X160MM (98)	50	30225.100.160
6X160MM (98)	50	30225.060.160	8X220MM (138)	50	30225.080.220	10X180MM (111)	50	30225.100.180
6X180MM (111)	50	30225.060.180	8X240MM (152)	50	30225.080.240	10X200MM (124)	50	30225.100.200
6X200MM (124)	50	30225.060.200	8X260MM (166)	50	30225.080.260	10X220MM (138)	50	30225.100.220
6X220MM (138)	50	30225.060.220	8X280MM (178)	50	30225.080.280	10X240MM (152)	50	30225.100.240
6X240MM (152)	50	30225.060.240	8X300MM (192)	50	30225.080.300	10X260MM (166)	50	30225.100.260
6X260MM (166)	50	30225.060.260	8X320MM (205)	50	30225.080.320	10X280MM (178)	50	30225.100.280
6X280MM (178)	50	30225.060.280	8X340MM (218)	50	30225.080.340	10X300MM (192)	50	30225.100.300
6X300MM (192)	50	30225.060.300	8X360MM (232)	50	30225.080.360	10X320MM (205)	50	30225.100.320
8X80MM (45)	50	30225.080.080	8X380MM (246)	50	30225.080.380	10X340MM (218)	50	30225.100.340
8X100MM (58)	50	30225.080.100	8X400MM (258)	50	30225.080.400	10X360MM (232)	50	30225.100.360
8X120MM (72)	50	30225.080.120	10X80MM (45)	50	30225.100.080	10X380MM (246)	50	30225.100.380
						10X400MM (258)	50	30225.100.400

30230 MAXXFAST Wkręty do drewna konstrukcyjne z kołnierzem z gniazdem ttap® stal A2

MF0A

Materiał Stal nierdzewna A2

MAXXFAST
PROFESSIONAL HARDWARE



CE

d x L (S)	☒	Kod artykułu	d x L (S)	☒	Kod artykułu	d x L (S)	☒	Kod artykułu
8X80MM (45)	50	30230.080.080	8X120MM (72)	50	30230.080.120	8X160MM (98)	50	30230.080.160
8X100MM (58)	50	30230.080.100	8X140MM (85)	50	30230.080.140	8X180MM (111)	50	30230.080.180

Wkręty do drewna z łbem stożkowym z gniazdem sześciokarbowym

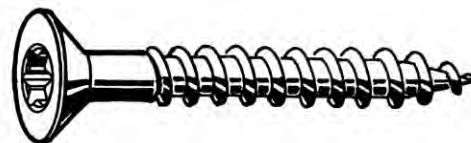
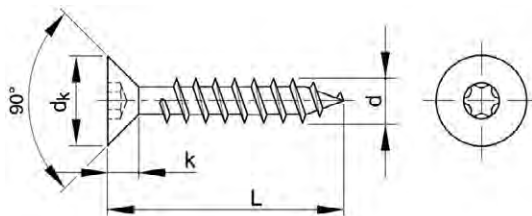

Informacje techniczne

d	d _k	k	Nasadka
3	6	1.9	T10
3.5	7	2.1	T10
4	8	2.5	T20
4.5	9	2.7	T20
5	10	3	T25
6	12	3.6	T25
8	15	4.1	T40

Grupy katalogowe

Gniazdo	Materiał	Kod	Strona
Sześciokarbowy	St.St. A2	51878	6-178
Sześciokarbowy	St.St. A4	55878	6-179

6



51878 Wkręty do drewna z łbem stożkowym z gniazdem sześciokarbowym stal A2

R03A

Materiał Stal nierdzewna A2



d x L	☒	Kod artykułu	d x L	☒	Kod artykułu	d x L	☒	Kod artykułu
3,0X25MM*	500	51878.030.025	4,5X55MM*	200	51878.045.055	6,0X110MM*	100	51878.060.110
3,0X30MM*	500	51878.030.030	4,5X60MM*	200	51878.045.060	6,0X130MM*	100	51878.060.130
3,0X35MM*	500	51878.030.035	4,5X70MM*	200	51878.045.070	6,0X140MM*	100	51878.060.140
3,0X40MM*	200	51878.030.040	4,5X80MM*	200	51878.045.080	6,0X150MM*	100	51878.060.150
3,0X45MM*	200	51878.030.045	4,5X100MM*	200	51878.045.100	6,0X160MM*	100	51878.060.160
3,0X50MM*	200	51878.030.050				6,0X180MM*	100	51878.060.180
			5,0X20MM*	500	51878.050.020	6,0X200MM*	100	51878.060.200
3,5X25MM*	500	51878.035.025	5,0X25MM*	500	51878.050.025	6,0X220MM*	100	51878.060.220
3,5X30MM*	500	51878.035.030	5,0X35MM*	500	51878.050.035	6,0X240MM*	100	51878.060.240
3,5X35MM*	500	51878.035.035	5,0X40MM*	200	51878.050.040	6,0X260MM*	100	51878.060.260
3,5X40MM*	200	51878.035.040	5,0X45MM*	200	51878.050.045	6,0X280MM*	100	51878.060.280
3,5X45MM*	200	51878.035.045	5,0X50MM*	200	51878.050.050	6,0X300MM*	100	51878.060.300
3,5X50MM*	200	51878.035.050	5,0X55MM*	200	51878.050.055			
			5,0X60MM*	100	51878.050.060	8,0X70MM*	100	51878.080.070
4,0X25MM*	500	51878.040.025	5,0X65MM*	100	51878.050.065	8,0X80MM*	100	51878.080.080
4,0X30MM*	500	51878.040.030	5,0X80MM*	100	51878.050.080	8,0X100MM*	100	51878.080.100
4,0X35MM*	500	51878.040.035	5,0X90MM*	100	51878.050.090	8,0X120MM*	100	51878.080.120
4,0X40MM*	200	51878.040.040	5,0X100MM*	100	51878.050.100	8,0X140MM*	100	51878.080.140
4,0X45MM*	200	51878.040.045	5,0X110MM*	100	51878.050.110	8,0X160MM*	100	51878.080.160
4,0X50MM*	200	51878.040.050				8,0X180MM*	100	51878.080.180
4,0X55MM*	200	51878.040.055	6,0X30MM*	100	51878.060.030	8,0X200MM*	100	51878.080.200
4,0X60MM*	200	51878.040.060	6,0X35MM*	100	51878.060.035	8,0X220MM*	100	51878.080.220
4,0X65MM*	200	51878.040.065	6,0X40MM*	100	51878.060.040	8,0X225MM*	100	51878.080.225
4,0X80MM*	200	51878.040.080	6,0X45MM*	100	51878.060.045	8,0X240MM*	100	51878.080.240
			6,0X50MM*	100	51878.060.050	8,0X260MM*	100	51878.080.260
4,5X25MM*	500	51878.045.025	6,0X55MM*	100	51878.060.055	8,0X280MM*	100	51878.080.280
4,5X30MM*	500	51878.045.030	6,0X60MM*	100	51878.060.060	8,0X300MM*	100	51878.080.300
4,5X35MM*	500	51878.045.035	6,0X70MM*	100	51878.060.070	8,0X325MM*	100	51878.080.325
4,5X40MM*	200	51878.045.040	6,0X80MM*	100	51878.060.080	8,0X350MM*	100	51878.080.350
4,5X45MM*	200	51878.045.045	6,0X90MM*	100	51878.060.090	8,0X360MM*	100	51878.080.360
4,5X50MM*	200	51878.045.050	6,0X100MM*	100	51878.060.100	8,0X375MM*	100	51878.080.375

55878	Wkręty do drewna z łbem stożkowym z gniazdem sześciokąrtowym stal A4			R43A
Materiał	Stal nierdzewna A4			
				
				

d x L	☒	Kod artykułu	d x L	☒	Kod artykułu	d x L	☒	Kod artykułu
6,0X40MM*	100	55878.060.040	6,0X120MM*	100	55878.060.120	8,0X70MM*	100	55878.080.070
6,0X45MM*	100	55878.060.045	6,0X130MM*	100	55878.060.130	8,0X80MM*	100	55878.080.080
6,0X50MM*	100	55878.060.050	6,0X140MM*	100	55878.060.140	8,0X90MM*	100	55878.080.090
6,0X60MM*	100	55878.060.060	6,0X150MM*	100	55878.060.150	8,0X100MM*	100	55878.080.100
6,0X70MM*	100	55878.060.070	6,0X160MM*	100	55878.060.160	8,0X120MM*	100	55878.080.120
6,0X80MM*	100	55878.060.080	6,0X180MM*	100	55878.060.180	8,0X140MM*	100	55878.080.140
6,0X90MM*	100	55878.060.090	6,0X200MM*	100	55878.060.200	8,0X160MM*	100	55878.080.160
6,0X100MM*	100	55878.060.100				8,0X180MM*	100	55878.080.180
6,0X110MM*	100	55878.060.110	8,0X60MM*	100	55878.080.060	8,0X200MM*	100	55878.080.200

Wkręty do drewna z łbem stożkowym płaskim z nacięciem prostym

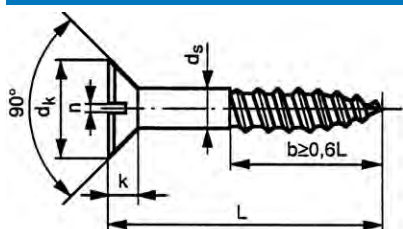

DIN 97
NEN 2250
NF E25-604



6



Informacje techniczne

d _s	d _k	k (maks.)	n	d _s	d _k	k (maks.)	n
2	3.8	1.2	0.5	5	9.2	2.5	1.2
2.5	4.7	1.5	0.6	5.5	10.2	2.75	1.2
3	5.6	1.65	0.8	6	11	3	1.6
3.5	6.5	1.93	0.8	7	12.5	3.5	2
4	7.5	2.2	1	8	14.5	4	2
4.5	8.3	2.35	1	10	18	5	2.5

* Gwint wkrętu do drewna zgodny z DIN 7998.



Grupy katalogowe

Gniazdo	Materiał	Obróbka powierzchni	Kod	Strona
Szczelina	St	Ocynk.	25130	6-179
Szczelina	St.St. A2		51870	6-180
Szczelina	St.St. A4		55870	6-180
Szczelina	Mosiądz Cu2/Cu3		49230	6-181
Szczelina	Mosiądz Cu2/Cu3	Nikl.	49330	6-181



25130	Wkręty do drewna z łbem stożkowym płaskim z nacięciem prostym			K05A
Materiał	Stal			
Obróbka powierzchni	Ocynkowane			
				
				

d _s x L	☒	Kod artykułu	d _s x L	☒	Kod artykułu	d _s x L	☒	Kod artykułu
2X10MM	200	25130.020.010	3X30MM	200	25130.030.030	4X10MM	200	25130.040.010
2X12MM	200	25130.020.012	3X35MM	200	25130.030.035	4X16MM	200	25130.040.016
2X16MM	200	25130.020.016	3X40MM	200	25130.030.040	4X20MM	200	25130.040.020
2X20MM	200	25130.020.020	3X45MM	200	25130.030.045	4X25MM	200	25130.040.025
			3X50MM	200	25130.030.050	4X30MM	200	25130.040.030
2,5X10MM	200	25130.025.010				4X35MM	200	25130.040.035
2,5X12MM	200	25130.025.012	3,5X10MM	200	25130.035.010	4X40MM	200	25130.040.040
2,5X16MM	200	25130.025.016	3,5X12MM	200	25130.035.012	4X45MM	200	25130.040.045
2,5X20MM	200	25130.025.020	3,5X16MM	200	25130.035.016	4X50MM	200	25130.040.050
2,5X30MM	200	25130.025.030	3,5X20MM	200	25130.035.020	4X60MM	200	25130.040.060
			3,5X25MM	200	25130.035.025	4X70MM	200	25130.040.070
3X10MM	200	25130.030.010	3,5X30MM	200	25130.035.030	4X80MM	200	25130.040.080
3X12MM	200	25130.030.012	3,5X35MM	200	25130.035.035	4X100MM	200	25130.040.100
3X16MM	200	25130.030.016	3,5X40MM	200	25130.035.040			
3X20MM	200	25130.030.020	3,5X45MM	200	25130.035.045			
3X25MM	200	25130.030.025	3,5X50MM	200	25130.035.050	4,5X20MM	200	25130.045.020

25130 Wkręty do drewna z łbem stożkowym płaskim z nacięciem prostym								
d _s x L	☒	Kod artykułu	d _s x L	☒	Kod artykułu	d _s x L	☒	Kod artykułu
4,5X25MM	200	25130.045.025	5X50MM	200	25130.050.050	6X40MM	200	25130.060.040
4,5X30MM	200	25130.045.030	5X60MM	200	25130.050.060	6X45MM	200	25130.060.045
4,5X35MM	200	25130.045.035	5X70MM	200	25130.050.070	6X50MM	200	25130.060.050
4,5X40MM	200	25130.045.040	5X80MM	200	25130.050.080	6X60MM	100	25130.060.060
4,5X45MM	200	25130.045.045				6X70MM	100	25130.060.070
4,5X50MM	200	25130.045.050	5,5X25MM	200	25130.055.025	6X80MM	100	25130.060.080
4,5X60MM	200	25130.045.060	5,5X30MM	200	25130.055.030	6X90MM	100	25130.060.090
4,5X70MM	200	25130.045.070	5,5X40MM	200	25130.055.040	6X100MM	100	25130.060.100
			5,5X45MM	200	25130.055.045	6X120MM	100	25130.060.120
			5,5X50MM	200	25130.055.050			
5X20MM	200	25130.050.020				7X50MM	100	25130.070.050
5X25MM	200	25130.050.025				7X60MM	100	25130.070.060
5X30MM	200	25130.050.030	6X20MM	200	25130.060.020	7X70MM	100	25130.070.070
5X35MM	200	25130.050.035	6X25MM	200	25130.060.025	7X80MM	100	25130.070.080
5X40MM	200	25130.050.040	6X30MM	200	25130.060.030	7X100MM	100	25130.070.100
5X45MM	200	25130.050.045	6X35MM	200	25130.060.035			

51870 Wkręty do drewna z łbem stożkowym płaskim z nacięciem prostym		R03A
Materiał	Stal nierdzewna A2	
		
		

d _s x L	☒	Kod artykułu	d _s x L	☒	Kod artykułu	d _s x L	☒	Kod artykułu
2,5X10MM	200	51870.025.010	4X60MM	200	51870.040.060	5,5X50MM	200	51870.055.050
2,5X12MM	200	51870.025.012	4X70MM	200	51870.040.070	5,5X60MM	100	51870.055.060
2,5X16MM	200	51870.025.016				5,5X70MM	100	51870.055.070
2,5X20MM	200	51870.025.020	4,5X16MM*	200	51870.045.016	5,5X75MM*	100	51870.055.075
2,5X25MM	200	51870.025.025	4,5X20MM	200	51870.045.020	5,5X90MM	100	51870.055.090
			4,5X25MM	200	51870.045.025	5,5X100MM	100	51870.055.100
3X10MM	200	51870.030.010	4,5X30MM	200	51870.045.030			
3X12MM	200	51870.030.012	4,5X35MM	200	51870.045.035	6X25MM	200	51870.060.025
3X16MM	200	51870.030.016	4,5X40MM	200	51870.045.040	6X30MM	200	51870.060.030
3X20MM	200	51870.030.020	4,5X45MM	200	51870.045.045	6X35MM	200	51870.060.035
3X25MM	200	51870.030.025	4,5X50MM	200	51870.045.050	6X40MM	200	51870.060.040
3X30MM	200	51870.030.030	4,5X60MM*	200	51870.045.060	6X45MM	200	51870.060.045
3X35MM*	200	51870.030.035	4,5X70MM*	200	51870.045.070	6X50MM	200	51870.060.050
3X40MM*	200	51870.030.040				6X60MM	100	51870.060.060
			5X16MM*	200	51870.050.016	6X65MM*	100	51870.060.065
3,5X12MM	200	51870.035.012	5X20MM	200	51870.050.020	6X70MM	100	51870.060.070
3,5X16MM	200	51870.035.016	5X25MM	200	51870.050.025	6X80MM	100	51870.060.080
3,5X20MM	200	51870.035.020	5X30MM	200	51870.050.030	6X90MM*	100	51870.060.090
3,5X25MM	200	51870.035.025	5X35MM	200	51870.050.035	6X100MM	100	51870.060.100
3,5X30MM	200	51870.035.030	5X40MM	200	51870.050.040	6X110MM*	100	51870.060.110
3,5X35MM	200	51870.035.035	5X45MM	200	51870.050.045	6X120MM*	100	51870.060.120
3,5X40MM	200	51870.035.040	5X50MM	200	51870.050.050			
3,5X45MM*	200	51870.035.045	5X60MM	200	51870.050.060	8X30MM*	100	51870.080.030
3,5X50MM	200	51870.035.050	5X65MM*	100	51870.050.065	8X40MM*	100	51870.080.040
			5X70MM	200	51870.050.070	8X50MM*	100	51870.080.050
4X10MM*	200	51870.040.010	5X75MM*	100	51870.050.075	8X60MM*	100	51870.080.060
4X12MM*	200	51870.040.012	5X80MM	200	51870.050.080	8X70MM*	100	51870.080.070
4X16MM	200	51870.040.016	5X90MM	200	51870.050.090	8X80MM*	100	51870.080.080
4X20MM	200	51870.040.020	5X100MM*	100	51870.050.100	8X90MM*	100	51870.080.090
4X25MM	200	51870.040.025				8X100MM*	100	51870.080.100
4X30MM	200	51870.040.030	5,5X25MM	200	51870.055.025	8X120MM*	100	51870.080.120
4X35MM	200	51870.040.035	5,5X30MM	200	51870.055.030			
4X40MM	200	51870.040.040	5,5X35MM	200	51870.055.035	10X120MM*	100	51870.100.120
4X45MM	200	51870.040.045	5,5X40MM	200	51870.055.040			
4X50MM	200	51870.040.050	5,5X45MM	200	51870.055.045			

55870 Wkręty do drewna z łbem stożkowym płaskim z nacięciem prostym		R43A
Materiał	Stal nierdzewna A4	
		
		

d _s x L	☒	Kod artykułu	d _s x L	☒	Kod artykułu	d _s x L	☒	Kod artykułu
2,5X12MM*	500	55870.025.012	3X20MM	200	55870.030.020	3,5X20MM	200	55870.035.020
2,5X16MM*	500	55870.025.016	3X25MM*	200	55870.030.025	3,5X25MM	200	55870.035.025
2,5X20MM*	500	55870.025.020	3X30MM*	200	55870.030.030	3,5X30MM*	200	55870.035.030
2,5X25MM*	500	55870.025.025	3X35MM*	200	55870.030.035	3,5X35MM*	200	55870.035.035
			3X40MM*	200	55870.030.040	3,5X40MM*	200	55870.035.040
3X10MM*	200	55870.030.010				3,5X45MM*	200	55870.035.045
3X12MM*	200	55870.030.012	3,5X12MM*	200	55870.035.012	3,5X50MM*	200	55870.035.050
3X16MM	200	55870.030.016	3,5X16MM*	200	55870.035.016			

55870 Wkręty do drewna z łbem stożkowym płaskim z nacięciem prostym								
d _s x L	☒	Kod artykułu	d _s x L	☒	Kod artykułu	d _s x L	☒	Kod artykułu
4X16MM*	200	55870.040.016				6X40MM*	200	55870.060.040
4X20MM*	200	55870.040.020	5X16MM*	200	55870.050.016	6X45MM*	200	55870.060.045
4X25MM	200	55870.040.025	5X20MM*	200	55870.050.020	6X50MM	200	55870.060.050
4X30MM	200	55870.040.030	5X25MM*	200	55870.050.025	6X60MM	100	55870.060.060
4X35MM*	200	55870.040.035	5X30MM	200	55870.050.030	6X70MM	100	55870.060.070
4X40MM	200	55870.040.040	5X35MM*	200	55870.050.035	6X80MM	100	55870.060.080
4X45MM*	200	55870.040.045	5X40MM	200	55870.050.040	6X90MM	100	55870.060.090
4X50MM	200	55870.040.050	5X45MM*	200	55870.050.045	6X100MM	100	55870.060.100
4X60MM*	200	55870.040.060	5X50MM	200	55870.050.050	6X110MM*	100	55870.060.110
			5X60MM	200	55870.050.060			
4,5X25MM*	200	55870.045.025	5X70MM	200	55870.050.070	8X40MM*	100	55870.080.040
4,5X30MM*	200	55870.045.030	5X80MM	200	55870.050.080	8X50MM*	100	55870.080.050
4,5X35MM*	200	55870.045.035	5X90MM	200	55870.050.090	8X60MM*	100	55870.080.060
4,5X40MM*	200	55870.045.040				8X70MM*	100	55870.080.070
4,5X45MM*	200	55870.045.045	5,5X40MM	200	55870.055.040	8X80MM*	100	55870.080.080
4,5X50MM*	200	55870.045.050				8X100MM*	100	55870.080.100
4,5X60MM*	200	55870.045.060	6X30MM*	200	55870.060.030			
4,5X80MM*	200	55870.045.080	6X35MM*	200	55870.060.035			

49230 Wkręty do drewna z łbem stożkowym płaskim z nacięciem prostym M07A

Materiał Mosiądz Cu2/Cu3



d _s x L	☒	Kod artykułu	d _s x L	☒	Kod artykułu	d _s x L	☒	Kod artykułu
2X8MM	200	49230.020.008	3,5X40MM	200	49230.035.040	5X40MM	200	49230.050.040
2X10MM	200	49230.020.010	3,5X45MM	200	49230.035.045	5X45MM	200	49230.050.045
2X12MM	200	49230.020.012	3,5X50MM	200	49230.035.050	5X50MM	200	49230.050.050
2X16MM	200	49230.020.016				5X60MM	200	49230.050.060
2X20MM	200	49230.020.020	4X12MM	200	49230.040.012	5X70MM	200	49230.050.070
			4X16MM	200	49230.040.016	5X80MM	200	49230.050.080
2,5X10MM	200	49230.025.010	4X20MM	200	49230.040.020			
2,5X12MM	200	49230.025.012	4X25MM	200	49230.040.025	5,5X30MM	200	49230.055.030
2,5X16MM	200	49230.025.016	4X30MM	200	49230.040.030	5,5X40MM	200	49230.055.040
2,5X20MM	200	49230.025.020	4X35MM	200	49230.040.035	5,5X45MM	200	49230.055.045
2,5X25MM	200	49230.025.025	4X40MM	200	49230.040.040	5,5X50MM	200	49230.055.050
2,5X30MM	200	49230.025.030	4X45MM	200	49230.040.045	5,5X60MM	100	49230.055.060
			4X50MM	200	49230.040.050	5,5X70MM	100	49230.055.070
3X10MM	200	49230.030.010	4X60MM	200	49230.040.060	5,5X80MM	100	49230.055.080
3X12MM	200	49230.030.012	4X70MM	200	49230.040.070	5,5X90MM	100	49230.055.090
3X16MM	200	49230.030.016				5,5X100MM	100	49230.055.100
3X20MM	200	49230.030.020	4,5X20MM	200	49230.045.020			
3X25MM	200	49230.030.025	4,5X25MM	200	49230.045.025	6X30MM	200	49230.060.030
3X30MM	200	49230.030.030	4,5X30MM	200	49230.045.030	6X35MM	200	49230.060.035
3X35MM	200	49230.030.035	4,5X35MM	200	49230.045.035	6X40MM	200	49230.060.040
3X40MM	200	49230.030.040	4,5X40MM	200	49230.045.040	6X45MM	200	49230.060.045
			4,5X45MM	200	49230.045.045	6X50MM	200	49230.060.050
3,5X10MM	200	49230.035.010	4,5X50MM	200	49230.045.050	6X60MM	100	49230.060.060
3,5X12MM	200	49230.035.012	4,5X60MM	200	49230.045.060	6X70MM	100	49230.060.070
3,5X16MM	200	49230.035.016				6X80MM	100	49230.060.080
3,5X20MM	200	49230.035.020	5X20MM	200	49230.050.020	6X90MM	100	49230.060.090
3,5X25MM	200	49230.035.025	5X25MM	200	49230.050.025	6X100MM	100	49230.060.100
3,5X30MM	200	49230.035.030	5X30MM	200	49230.050.030			
3,5X35MM	200	49230.035.035	5X35MM	200	49230.050.035	7X70MM	100	49230.070.070

49330 Wkręty do drewna z łbem stożkowym płaskim z nacięciem prostym M07A

Materiał Mosiądz Cu2/Cu3
Obróbka powierzchni Niklowane



d _s x L	☒	Kod artykułu	d _s x L	☒	Kod artykułu	d _s x L	☒	Kod artykułu
2X10MM	200	49330.020.010	3X25MM	200	49330.030.025	4X25MM	200	49330.040.025
2X12MM	200	49330.020.012				4X30MM	200	49330.040.030
			3,5X10MM	200	49330.035.010	4X35MM	200	49330.040.035
2,5X12MM	200	49330.025.012	3,5X16MM	200	49330.035.016	4X40MM	200	49330.040.040
2,5X16MM	200	49330.025.016	3,5X20MM	200	49330.035.020	4X45MM	200	49330.040.045
2,5X20MM	200	49330.025.020	3,5X25MM	200	49330.035.025	4X50MM	200	49330.040.050
			3,5X40MM	200	49330.035.040			
3X10MM	200	49330.030.010				4,5X20MM	200	49330.045.020
3X12MM	200	49330.030.012	4X12MM	200	49330.040.012	4,5X25MM	200	49330.045.025
3X16MM	200	49330.030.016	4X16MM	200	49330.040.016	4,5X30MM	200	49330.045.030
3X20MM	200	49330.030.020	4X20MM	200	49330.040.020	4,5X35MM	200	49330.045.035

49330 Wkręty do drewna z łbem stożkowym płaskim z nacięciem prostym								
$d_s \times L$	☒	Kod artykułu	$d_s \times L$	☒	Kod artykułu	$d_s \times L$	☒	Kod artykułu
4,5X40MM	200	49330.045.040				6X30MM	200	49330.060.030
4,5X60MM	200	49330.045.060	5,5X25MM	200	49330.055.025	6X40MM	200	49330.060.040
4,5X70MM	200	49330.045.070	5,5X30MM	200	49330.055.030	6X50MM	200	49330.060.050
			5,5X40MM	200	49330.055.040	6X60MM	100	49330.060.060
5X30MM	200	49330.050.030	5,5X50MM	200	49330.055.050	6X70MM	100	49330.060.070
5X40MM	200	49330.050.040	5,5X60MM	100	49330.055.060	6X80MM	100	49330.060.080
5X45MM	200	49330.050.045	5,5X70MM	100	49330.055.070			
5X60MM	200	49330.050.060						

Wkręty do drewna z łbem kulistym z nacięciem prostym

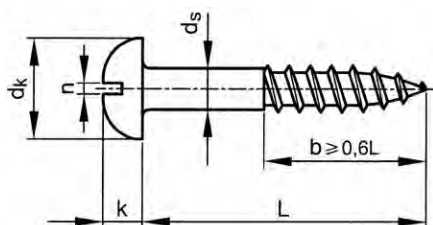

DIN 96
NEN 2251
NF E25-606



Informacje techniczne

d_s	d_k	k (maks.)	n
2	4	1.4	0.5
2.5	5	1.7	0.6
3	6	2.1	0.8
3.5	7	2.4	0.8
4	8	2.8	1
4.5	9	3.1	1
5	10	3.5	1.2
5.5	11	3.8	1.2
6	12	4.2	1.6
7	14	4.9	2
8	16	5.6	2

- Gwint wkrętu do drewna zgodny z DIN 7998.



Grupy katalogowe

Gniazdo	Materiał	Obróbka powierzchni	Kod	Strona
Szczelina	St	Ocynk.	25110	6-182
Szczelina	St.St. A2		51860	6-183
Szczelina	St.St. A4		55860	6-183
Szczelina	Mosiądz Cu2/Cu3		49210	6-184
Szczelina	Mosiądz Cu2/Cu3	Nikl.	49310	6-184



25110 Wkręty do drewna z łbem kulistym z nacięciem prostym				K05A
Materiał	Stal			
Obróbka powierzchni	Ocynkowane			

$d_s \times L$	☒	Kod artykułu	$d_s \times L$	☒	Kod artykułu	$d_s \times L$	☒	Kod artykułu
2X10MM	200	25110.020.010				4X40MM	200	25110.040.040
2X12MM	200	25110.020.012	3,5X10MM	200	25110.035.010	4X50MM	200	25110.040.050
			3,5X12MM	200	25110.035.012	4X60MM	200	25110.040.060
2,5X10MM	200	25110.025.010	3,5X16MM	200	25110.035.016	4X70MM	200	25110.040.070
2,5X12MM	200	25110.025.012	3,5X20MM	200	25110.035.020	4X80MM	200	25110.040.080
2,5X16MM	200	25110.025.016	3,5X25MM	200	25110.035.025			
2,5X20MM	200	25110.025.020	3,5X30MM	200	25110.035.030	4,5X16MM	200	25110.045.016
2,5X25MM	200	25110.025.025	3,5X35MM	200	25110.035.035	4,5X20MM	200	25110.045.020
2,5X30MM	200	25110.025.030	3,5X40MM	200	25110.035.040	4,5X25MM	200	25110.045.025
			3,5X45MM	200	25110.035.045	4,5X30MM	200	25110.045.030
3X10MM	200	25110.030.010	3,5X60MM	200	25110.035.060	4,5X40MM	200	25110.045.040
3X12MM	200	25110.030.012				4,5X45MM	200	25110.045.045
3X16MM	200	25110.030.016	4X12MM	200	25110.040.012	4,5X50MM	200	25110.045.050
3X20MM	200	25110.030.020	4X16MM	200	25110.040.016	4,5X60MM	200	25110.045.060
3X25MM	200	25110.030.025	4X20MM	200	25110.040.020			
3X30MM	200	25110.030.030	4X25MM	200	25110.040.025	5X16MM	200	25110.050.016
3X35MM	200	25110.030.035	4X30MM	200	25110.040.030	5X20MM	200	25110.050.020
3X40MM	200	25110.030.040	4X35MM	200	25110.040.035	5X25MM	200	25110.050.025

25110 Wkręty do drewna z łbem kulistym z nacięciem prostym								
d _s x L	☒	Kod artykułu	d _s x L	☒	Kod artykułu	d _s x L	☒	Kod artykułu
5X30MM	200	25110.050.030	5,5X25MM	200	25110.055.025	6X30MM	200	25110.060.030
5X35MM	200	25110.050.035	5,5X30MM	200	25110.055.030	6X35MM	200	25110.060.035
5X40MM	200	25110.050.040	5,5X40MM	200	25110.055.040	6X40MM	200	25110.060.040
5X45MM	200	25110.050.045	5,5X45MM	200	25110.055.045	6X50MM	200	25110.060.050
5X50MM	200	25110.050.050	5,5X50MM	200	25110.055.050	6X60MM	100	25110.060.060
5X60MM	200	25110.050.060	5,5X60MM	100	25110.055.060	6X70MM	100	25110.060.070
5X70MM	200	25110.050.070	5,5X70MM	100	25110.055.070	6X80MM	100	25110.060.080
5X80MM	200	25110.050.080	5,5X100MM	100	25110.055.100			
5,5X20MM	200	25110.055.020	6X25MM	200	25110.060.025	7X50MM	100	25110.070.050
						7X60MM	100	25110.070.060

51860 Wkręty do drewna z łbem kulistym z nacięciem prostym		R03A
Materiał	Stal nierdzewna A2	
	 	

d _s x L	☒	Kod artykułu	d _s x L	☒	Kod artykułu	d _s x L	☒	Kod artykułu
2,5X10MM	200	51860.025.010	4X35MM	200	51860.040.035	5X80MM	200	51860.050.080
2,5X12MM	200	51860.025.012	4X40MM	200	51860.040.040	5X90MM	200	51860.050.090
2,5X16MM	200	51860.025.016	4X45MM	200	51860.040.045	5X100MM*	100	51860.050.100
2,5X20MM	200	51860.025.020	4X50MM	200	51860.040.050			
2,5X25MM*	500	51860.025.025	4X60MM	200	51860.040.060	5,5X25MM	200	51860.055.025
			4X70MM*	200	51860.040.070	5,5X30MM	200	51860.055.030
3X10MM	200	51860.030.010				5,5X35MM	200	51860.055.035
3X12MM	200	51860.030.012	4,5X16MM*	200	51860.045.016	5,5X40MM	200	51860.055.040
3X16MM	200	51860.030.016	4,5X20MM*	200	51860.045.020	5,5X50MM	200	51860.055.050
3X20MM	200	51860.030.020	4,5X25MM	200	51860.045.025	5,5X60MM*	200	51860.055.060
3X25MM	200	51860.030.025	4,5X30MM	200	51860.045.030	5,5X90MM*	100	51860.055.090
3X30MM	200	51860.030.030	4,5X35MM	200	51860.045.035			
3X35MM*	200	51860.030.035	4,5X40MM	200	51860.045.040	6X20MM*	200	51860.060.020
3X40MM*	200	51860.030.040	4,5X45MM*	200	51860.045.045	6X25MM	200	51860.060.025
			4,5X50MM	200	51860.045.050	6X30MM	200	51860.060.030
3,5X12MM	200	51860.035.012	4,5X60MM*	200	51860.045.060	6X35MM	200	51860.060.035
3,5X16MM	200	51860.035.016	4,5X70MM*	200	51860.045.070	6X40MM	200	51860.060.040
3,5X20MM	200	51860.035.020				6X45MM	200	51860.060.045
3,5X25MM	200	51860.035.025	5X16MM	200	51860.050.016	6X50MM	200	51860.060.050
3,5X30MM	200	51860.035.030	5X20MM	200	51860.050.020	6X55MM*	200	51860.060.055
3,5X35MM	200	51860.035.035	5X25MM	200	51860.050.025	6X60MM	100	51860.060.060
3,5X40MM*	200	51860.035.040	5X30MM	200	51860.050.030	6X70MM	100	51860.060.070
3,5X45MM*	200	51860.035.045	5X35MM	200	51860.050.035	6X80MM	100	51860.060.080
3,5X50MM*	200	51860.035.050	5X40MM	200	51860.050.040	6X90MM	100	51860.060.090
			5X45MM	200	51860.050.045	6X100MM	100	51860.060.100
4X12MM	200	51860.040.012	5X50MM	200	51860.050.050	6X110MM*	100	51860.060.110
4X16MM	200	51860.040.016	5X55MM*	200	51860.050.055	6X120MM*	100	51860.060.120
4X20MM	200	51860.040.020	5X60MM	200	51860.050.060			
4X25MM	200	51860.040.025	5X65MM*	100	51860.050.065	8X60MM*	100	51860.080.060
4X30MM	200	51860.040.030	5X70MM	200	51860.050.070			

55860 Wkręty do drewna z łbem kulistym z nacięciem prostym		R43A
Materiał	Stal nierdzewna A4	
	 	

d _s x L	☒	Kod artykułu	d _s x L	☒	Kod artykułu	d _s x L	☒	Kod artykułu
2,5X10MM*	500	55860.025.010	3,5X50MM*	200	55860.035.050	5X25MM*	200	55860.050.025
2,5X12MM*	500	55860.025.012				5X30MM*	200	55860.050.030
2,5X20MM*	500	55860.025.020	4X16MM*	200	55860.040.016	5X35MM*	200	55860.050.035
			4X20MM*	200	55860.040.020	5X40MM*	200	55860.050.040
3X12MM*	200	55860.030.012	4X25MM*	200	55860.040.025	5X45MM*	200	55860.050.045
3X16MM*	200	55860.030.016	4X30MM*	200	55860.040.030	5X50MM*	200	55860.050.050
3X20MM*	200	55860.030.020	4X35MM*	200	55860.040.035	5X60MM*	200	55860.050.060
3X25MM*	200	55860.030.025	4X40MM*	200	55860.040.040	5X70MM*	100	55860.050.070
3X30MM*	200	55860.030.030	4X45MM*	200	55860.040.045	5X75MM*	100	55860.050.075
3X40MM*	200	55860.030.040	4X50MM*	200	55860.040.050			
						6X30MM*	200	55860.060.030
3,5X16MM*	200	55860.035.016	4,5X20MM*	200	55860.045.020	6X35MM*	200	55860.060.035
3,5X20MM*	200	55860.035.020	4,5X35MM*	200	55860.045.035	6X40MM*	200	55860.060.040
3,5X25MM*	200	55860.035.025	4,5X50MM*	200	55860.045.050	6X45MM*	200	55860.060.045
3,5X30MM*	200	55860.035.030				6X50MM*	200	55860.060.050
3,5X40MM*	200	55860.035.040	5X20MM*	200	55860.050.020	6X70MM*	100	55860.060.070

49210 Wkręty do drewna z łbem kulistym z nacięciem prostym
M07A
Materiał Mosiądz Cu2/Cu3

$d_s \times L$	☒	Kod artykułu	$d_s \times L$	☒	Kod artykułu	$d_s \times L$	☒	Kod artykułu
2X8MM	200	49210.020.008	3,5X30MM	200	49210.035.030	5X20MM	200	49210.050.020
2X10MM	200	49210.020.010	3,5X35MM	200	49210.035.035	5X25MM	200	49210.050.025
2X12MM	200	49210.020.012	3,5X40MM	200	49210.035.040	5X30MM	200	49210.050.030
2X16MM	200	49210.020.016	3,5X45MM	200	49210.035.045	5X35MM	200	49210.050.035
			3,5X50MM	200	49210.035.050	5X40MM	200	49210.050.040
2,5X10MM	200	49210.025.010				5X45MM	200	49210.050.045
2,5X12MM	200	49210.025.012	4X12MM	200	49210.040.012	5X50MM	200	49210.050.050
2,5X16MM	200	49210.025.016	4X16MM	200	49210.040.016	5X60MM	200	49210.050.060
2,5X20MM	200	49210.025.020	4X20MM	200	49210.040.020	5X70MM	200	49210.050.070
2,5X25MM	200	49210.025.025	4X25MM	200	49210.040.025	5X80MM	200	49210.050.080
2,5X30MM	200	49210.025.030	4X30MM	200	49210.040.030			
			4X35MM	200	49210.040.035	5,5X20MM	200	49210.055.020
3X10MM	200	49210.030.010	4X40MM	200	49210.040.040	5,5X30MM	200	49210.055.030
3X12MM	200	49210.030.012	4X45MM	200	49210.040.045	5,5X40MM	200	49210.055.040
3X16MM	200	49210.030.016	4X50MM	200	49210.040.050	5,5X50MM	200	49210.055.050
3X20MM	200	49210.030.020	4X60MM	200	49210.040.060	5,5X60MM	100	49210.055.060
3X25MM	200	49210.030.025	4X70MM	200	49210.040.070	5,5X70MM	100	49210.055.070
3X30MM	200	49210.030.030						
3X35MM	200	49210.030.035	4,5X20MM	200	49210.045.020	6X30MM	200	49210.060.030
3X40MM	200	49210.030.040	4,5X25MM	200	49210.045.025	6X35MM	200	49210.060.035
			4,5X30MM	200	49210.045.030	6X40MM	200	49210.060.040
3,5X10MM	200	49210.035.010	4,5X35MM	200	49210.045.035	6X45MM	200	49210.060.045
3,5X12MM	200	49210.035.012	4,5X40MM	200	49210.045.040	6X50MM	200	49210.060.050
3,5X16MM	200	49210.035.016	4,5X45MM	200	49210.045.045	6X60MM	100	49210.060.060
3,5X20MM	200	49210.035.020	4,5X50MM	200	49210.045.050	6X70MM	100	49210.060.070
3,5X25MM	200	49210.035.025				6X80MM	100	49210.060.080

6
49310 Wkręty do drewna z łbem kulistym z nacięciem prostym
M07A
Materiał Mosiądz Cu2/Cu3
Obróbka powierzchni Niklowane

$d_s \times L$	☒	Kod artykułu	$d_s \times L$	☒	Kod artykułu	$d_s \times L$	☒	Kod artykułu
2X10MM	200	49310.020.010	3,5X16MM	200	49310.035.016	4,5X35MM	200	49310.045.035
2X12MM	200	49310.020.012	3,5X20MM	200	49310.035.020	4,5X40MM	200	49310.045.040
2X16MM	200	49310.020.016	3,5X25MM	200	49310.035.025	4,5X50MM	200	49310.045.050
			3,5X30MM	200	49310.035.030			
2,5X10MM	200	49310.025.010	3,5X35MM	200	49310.035.035	5X25MM	200	49310.050.025
2,5X12MM	200	49310.025.012	3,5X40MM	200	49310.035.040	5X30MM	200	49310.050.030
2,5X16MM	200	49310.025.016				5X35MM	200	49310.050.035
2,5X20MM	200	49310.025.020	4X12MM	200	49310.040.012	5X40MM	200	49310.050.040
2,5X25MM	200	49310.025.025	4X20MM	200	49310.040.020	5X50MM	200	49310.050.050
			4X25MM	200	49310.040.025			
3X10MM	200	49310.030.010	4X30MM	200	49310.040.030	5,5X50MM	200	49310.055.050
3X12MM	200	49310.030.012	4X35MM	200	49310.040.035	5,5X60MM	100	49310.055.060
3X16MM	200	49310.030.016	4X40MM	200	49310.040.040	5,5X70MM	100	49310.055.070
3X20MM	200	49310.030.020	4X45MM	200	49310.040.045			
3X25MM	200	49310.030.025	4X50MM	200	49310.040.050	6X30MM	200	49310.060.030
3X30MM	200	49310.030.030				6X40MM	200	49310.060.040
			4,5X20MM	200	49310.045.020	6X60MM	100	49310.060.060
3,5X10MM	200	49310.035.010	4,5X25MM	200	49310.045.025	6X70MM	100	49310.060.070
3,5X12MM	200	49310.035.012	4,5X30MM	200	49310.045.030	6X80MM	100	49310.060.080

Wkręty do drewna z łbem stożkowym soczewkowym z nacięciem prostym

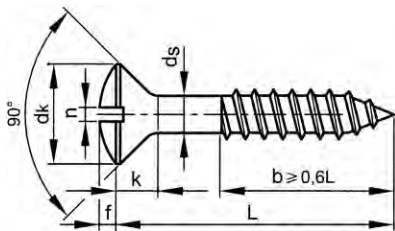

DIN 95
NEN 2252
NF E25-605



Informacje techniczne

d_s	d_k	$f \approx$	k (maks.)	n
2	3.8	0.5	1.2	0.5
2.5	4.7	0.6	1.5	0.6
3	5.6	0.75	1.65	0.8
3.5	6.5	0.9	1.93	0.8
4	7.5	1	2.2	1
4.5	8.3	1.1	2.35	1
5	9.2	1.25	2.5	1.2
5.5	10.2	1.4	2.75	1.2
6	11	1.5	3	1.6
7	12.5	1.75	3.5	1.8
8	14.5	2	4	2

- Gwint wkrętu do drewna zgodny z DIN 7998.

Grupy katalogowe

Gniazdo	Materiał	Obróbka powierzchni	Kod	Strona
Szczelina	St.St. A2		51880	6-185
Szczelina	St.St. A4		55880	6-186
Szczelina	Mosiądz Cu2/Cu3		49250	6-186
Szczelina	Mosiądz Cu2/Cu3	Nikl.	49350	6-186

51880 Wkręty do drewna z łbem stożkowym soczewkowym z nacięciem prostym

R03A

Materiał Stal nierdzewna A2



$d_s \times L$	☒	Kod artykułu	$d_s \times L$	☒	Kod artykułu	$d_s \times L$	☒	Kod artykułu
2,5X10MM	200	51880.025.010	4X45MM	200	51880.040.045	5,5X20MM*	200	51880.055.020
2,5X12MM*	500	51880.025.012	4X50MM	200	51880.040.050	5,5X30MM*	200	51880.055.030
2,5X16MM	200	51880.025.016	4X60MM	200	51880.040.060	5,5X35MM*	200	51880.055.035
2,5X20MM	200	51880.025.020	4X70MM*	200	51880.040.070	5,5X40MM	200	51880.055.040
2,5X25MM	200	51880.025.025				5,5X45MM	200	51880.055.045
			4,5X16MM*	200	51880.045.016	5,5X50MM	200	51880.055.050
3X10MM*	200	51880.030.010	4,5X20MM*	200	51880.045.020	5,5X60MM	100	51880.055.060
3X12MM	200	51880.030.012	4,5X25MM	200	51880.045.025	5,5X70MM	100	51880.055.070
3X16MM	200	51880.030.016	4,5X30MM	200	51880.045.030			
3X20MM	200	51880.030.020	4,5X35MM	200	51880.045.035	6X20MM*	200	51880.060.020
3X25MM	200	51880.030.025	4,5X40MM	200	51880.045.040	6X25MM*	200	51880.060.025
3X30MM	200	51880.030.030	4,5X45MM	200	51880.045.045	6X30MM	200	51880.060.030
3X35MM	200	51880.030.035	4,5X50MM	200	51880.045.050	6X35MM	200	51880.060.035
3X40MM*	200	51880.030.040	4,5X60MM*	200	51880.045.060	6X40MM	200	51880.060.040
			4,5X65MM*	200	51880.045.065	6X45MM	200	51880.060.045
3,5X12MM	200	51880.035.012	4,5X70MM*	200	51880.045.070	6X50MM	200	51880.060.050
3,5X16MM	200	51880.035.016				6X60MM	100	51880.060.060
3,5X20MM	200	51880.035.020	5X16MM*	200	51880.050.016	6X65MM*	100	51880.060.065
3,5X25MM	200	51880.035.025	5X20MM	200	51880.050.020	6X70MM	100	51880.060.070
3,5X30MM	200	51880.035.030	5X25MM	200	51880.050.025	6X75MM*	100	51880.060.075
3,5X35MM	200	51880.035.035	5X30MM	200	51880.050.030	6X80MM*	100	51880.060.080
3,5X40MM	200	51880.035.040	5X35MM	200	51880.050.035	6X90MM*	100	51880.060.090
3,5X45MM*	200	51880.035.045	5X40MM	200	51880.050.040	6X100MM*	100	51880.060.100
3,5X50MM*	200	51880.035.050	5X45MM	200	51880.050.045	6X110MM*	100	51880.060.110
			5X50MM	200	51880.050.050	6X120MM*	100	51880.060.120
4X12MM	200	51880.040.012	5X60MM	200	51880.050.060			
4X16MM	200	51880.040.016	5X70MM	200	51880.050.070	7X80MM*	100	51880.070.080
4X20MM	200	51880.040.020	5X75MM*	100	51880.050.075			
4X25MM	200	51880.040.025	5X80MM*	100	51880.050.080	8X40MM*	100	51880.080.040
4X30MM	200	51880.040.030	5X90MM*	100	51880.050.090	8X45MM*	100	51880.080.045
4X35MM	200	51880.040.035	5X100MM*	100	51880.050.100	8X60MM*	100	51880.080.060
4X40MM	200	51880.040.040				8X80MM*	100	51880.080.080

51880 Wkręty do drewna z łbem stożkowym soczewkowym z nacięciem prostym

d _s x L	☒	Kod artykułu
8X90MM*	100	51880.080.090

55880 Wkręty do drewna z łbem stożkowym soczewkowym z nacięciem prostym
R43A
Materiał Stal nierdzewna A4

d _s x L	☒	Kod artykułu	d _s x L	☒	Kod artykułu	d _s x L	☒	Kod artykułu
2,5X10MM*	500	55880.025.010	4X16MM*	200	55880.040.016	5X40MM*	200	55880.050.040
2,5X12MM*	500	55880.025.012	4X20MM*	200	55880.040.020	5X45MM*	200	55880.050.045
2,5X16MM*	500	55880.025.016	4X25MM*	200	55880.040.025	5X50MM*	200	55880.050.050
2,5X20MM*	500	55880.025.020	4X30MM*	200	55880.040.030	5X60MM*	200	55880.050.060
3X12MM*	200	55880.030.012	4X35MM*	200	55880.040.035	5X70MM*	100	55880.050.070
3X16MM*	200	55880.030.016	4X40MM*	200	55880.040.040	5X80MM*	100	55880.050.080
3X20MM*	200	55880.030.020	4X45MM*	200	55880.040.045	6X20MM*	200	55880.060.020
3X25MM*	200	55880.030.025	4X50MM*	200	55880.040.050	6X25MM*	200	55880.060.025
3X30MM*	200	55880.030.030	4X60MM*	200	55880.040.060	6X30MM*	200	55880.060.030
3X35MM*	200	55880.030.035	4X70MM*	200	55880.040.070	6X35MM*	200	55880.060.035
3X40MM*	200	55880.030.040	4,5X20MM*	200	55880.045.020	6X40MM*	200	55880.060.040
3,5X16MM*	200	55880.035.016	4,5X25MM*	200	55880.045.025	6X45MM*	200	55880.060.045
3,5X20MM*	200	55880.035.020	4,5X30MM*	200	55880.045.030	6X50MM*	200	55880.060.050
3,5X25MM*	200	55880.035.025	4,5X45MM*	200	55880.045.045	6X60MM*	200	55880.060.060
3,5X30MM*	200	55880.035.030	4,5X50MM*	200	55880.045.050	6X70MM*	100	55880.060.070
3,5X35MM*	200	55880.035.035	5X20MM*	200	55880.050.020	6X75MM*	100	55880.060.075
3,5X40MM*	200	55880.035.040	5X25MM*	200	55880.050.025	6X80MM*	100	55880.060.080
3,5X45MM*	200	55880.035.045	5X30MM*	200	55880.050.030	8X80MM*	100	55880.080.080
			5X35MM*	200	55880.050.035	8X90MM*	100	55880.080.090

49250 Wkręty do drewna z łbem stożkowym soczewkowym z nacięciem prostym
M07A
Materiał Mosiądz Cu2/Cu3



d _s x L	☒	Kod artykułu	d _s x L	☒	Kod artykułu	d _s x L	☒	Kod artykułu
2,5X10MM	200	49250.025.010	4X16MM	200	49250.040.016	4,5X70MM	200	49250.045.070
2,5X12MM	200	49250.025.012	4X20MM	200	49250.040.020	5X25MM	200	49250.050.025
2,5X16MM	200	49250.025.016	4X25MM	200	49250.040.025	5X30MM	200	49250.050.030
3X12MM	200	49250.030.012	4X30MM	200	49250.040.030	5X35MM	200	49250.050.035
3X16MM	200	49250.030.016	4X35MM	200	49250.040.035	5X40MM	200	49250.050.040
3X20MM	200	49250.030.020	4X40MM	200	49250.040.040	5X45MM	200	49250.050.045
3X25MM	200	49250.030.025	4X45MM	200	49250.040.045	5X50MM	200	49250.050.050
3X30MM	200	49250.030.030	4X50MM	200	49250.040.050	5X60MM	200	49250.050.060
3,5X12MM	200	49250.035.012	4X60MM	200	49250.040.060	5X70MM	200	49250.050.070
3,5X16MM	200	49250.035.016	4X70MM	200	49250.040.070	5X80MM	200	49250.050.080
3,5X20MM	200	49250.035.020	4,5X25MM	200	49250.045.025	5,5X40MM	200	49250.055.040
3,5X25MM	200	49250.035.025	4,5X30MM	200	49250.045.030	5,5X50MM	200	49250.055.050
3,5X30MM	200	49250.035.030	4,5X35MM	200	49250.045.035	5,5X60MM	100	49250.055.060
3,5X35MM	200	49250.035.035	4,5X40MM	200	49250.045.040	5,5X70MM	100	49250.055.070
3,5X40MM	200	49250.035.040	4,5X45MM	200	49250.045.045	5,5X80MM	100	49250.055.080
			4,5X50MM	200	49250.045.050			
			4,5X60MM	200	49250.045.060			

49350 Wkręty do drewna z łbem stożkowym soczewkowym z nacięciem prostym
M07A
Materiał Mosiądz Cu2/Cu3
Obróbka powierzchni Niklowane

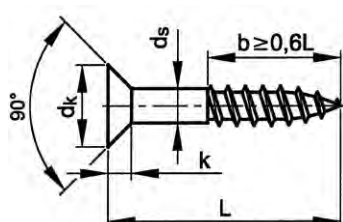

d _s x L	☒	Kod artykułu	d _s x L	☒	Kod artykułu	d _s x L	☒	Kod artykułu
2X10MM	200	49350.020.010	2,5X16MM	200	49350.025.016	3X12MM	200	49350.030.012
2X12MM	200	49350.020.012	2,5X20MM	200	49350.025.020	3X16MM	200	49350.030.016
2X16MM	200	49350.020.016	2,5X25MM	200	49350.025.025	3X20MM	200	49350.030.020
			2,5X30MM	200	49350.025.030	3X25MM	200	49350.030.025
2,5X10MM	200	49350.025.010				3X30MM	200	49350.030.030
2,5X12MM	200	49350.025.012	3X10MM	200	49350.030.010	3X35MM	200	49350.030.035

49350 Wkręty do drewna z łbem stożkowym soczewkowym z nacięciem prostym								
$d_s \times L$	☒	Kod artykułu	$d_s \times L$	☒	Kod artykułu	$d_s \times L$	☒	Kod artykułu
3X40MM	200	49350.030.040	4X45MM	200	49350.040.045	5X40MM	200	49350.050.040
3,5X12MM	200	49350.035.012	4X50MM	200	49350.040.050	5X45MM	200	49350.050.045
3,5X16MM	200	49350.035.016	4X60MM	200	49350.040.060	5X50MM	200	49350.050.050
3,5X20MM	200	49350.035.020	4X70MM	200	49350.040.070	5X60MM	200	49350.050.060
3,5X25MM	200	49350.035.025	4,5X20MM	200	49350.045.020	5X70MM	200	49350.050.070
3,5X30MM	200	49350.035.030	4,5X25MM	200	49350.045.025	5,5X40MM	200	49350.055.040
3,5X35MM	200	49350.035.035	4,5X30MM	200	49350.045.030	5,5X50MM	200	49350.055.050
3,5X40MM	200	49350.035.040	4,5X35MM	200	49350.045.035	5,5X60MM	100	49350.055.060
3,5X45MM	200	49350.035.045	4,5X40MM	200	49350.045.040	5,5X70MM	100	49350.055.070
3,5X50MM	200	49350.035.050	4,5X45MM	200	49350.045.045	6X30MM	200	49350.060.030
4X12MM	200	49350.040.012	4,5X50MM	200	49350.045.050	6X35MM	200	49350.060.035
4X16MM	200	49350.040.016	4,5X60MM	200	49350.045.060	6X40MM	200	49350.060.040
4X20MM	200	49350.040.020	4,5X70MM	200	49350.045.070	6X45MM	200	49350.060.045
4X25MM	200	49350.040.025	5X20MM	200	49350.050.020	6X50MM	200	49350.060.050
4X30MM	200	49350.040.030	5X25MM	200	49350.050.025	6X60MM	100	49350.060.060
4X35MM	200	49350.040.035	5X30MM	200	49350.050.030	6X70MM	100	49350.060.070
4X40MM	200	49350.040.040	5X35MM	200	49350.050.035	6X80MM	100	49350.060.080

Wkręty do drewna z łbem stożkowym płaskim z gniazdem krzyżowym

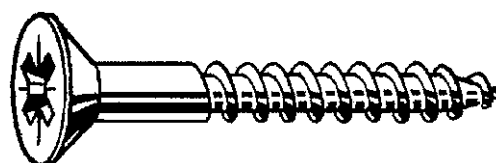

POZIDRIV (Z) DIN 7997-Z
NEN 2253
NF E25-601



6

Informacje techniczne

d_s	d_k	k (maks.)	Nr wgłębienia krzyżowego
3	5.6	1.65	1
3.5	6.5	1.93	2
4	7.5	2.2	2
4.5	8.3	2.35	2
5	9.2	2.5	2
6	11	3	3

• Gwint wkrętu do drewna zgodny z DIN 7998.

51876 Wkręty do drewna z łbem stożkowym płaskim z gniazdem krzyżowym Pozidriv		R03A
Materiał	Stal nierdzewna A2	

$d_s \times L$	☒	Kod artykułu	$d_s \times L$	☒	Kod artykułu	$d_s \times L$	☒	Kod artykułu
3X12MM	200	51876.030.012	4X50MM	200	51876.040.050	5X60MM	200	51876.050.060
3X16MM	200	51876.030.016	4X60MM	200	51876.040.060	5X70MM	200	51876.050.070
3X20MM	200	51876.030.020	4,5X20MM	200	51876.045.020	5X75MM*	100	51876.050.075
3X25MM	200	51876.030.025	4,5X25MM	200	51876.045.025	5X80MM	200	51876.050.080
3X30MM*	200	51876.030.030	4,5X30MM	200	51876.045.030	5X90MM	200	51876.050.090
3,5X16MM	200	51876.035.016	4,5X35MM	200	51876.045.035	5X100MM	200	51876.050.100
3,5X20MM	200	51876.035.020	4,5X40MM	200	51876.045.040	6X30MM*	200	51876.060.030
3,5X25MM	200	51876.035.025	4,5X45MM*	200	51876.045.045	6X35MM*	200	51876.060.035
3,5X30MM	200	51876.035.030	4,5X50MM	200	51876.045.050	6X40MM	200	51876.060.040
3,5X35MM*	200	51876.035.035	4,5X60MM*	200	51876.045.060	6X45MM*	200	51876.060.045
3,5X40MM	200	51876.035.040	5X20MM	200	51876.050.020	6X50MM	200	51876.060.050
4X16MM	200	51876.040.016	5X25MM*	200	51876.050.025	6X60MM	100	51876.060.060
4X20MM	200	51876.040.020	5X30MM	200	51876.050.030	6X70MM	100	51876.060.070
4X25MM	200	51876.040.025	5X35MM*	200	51876.050.035	6X80MM	100	51876.060.080
4X30MM	200	51876.040.030	5X40MM	200	51876.050.040	6X90MM*	100	51876.060.090
4X35MM	200	51876.040.035	5X45MM	200	51876.050.045	6X100MM	100	51876.060.100
4X40MM	200	51876.040.040	5X50MM	200	51876.050.050	6X110MM*	100	51876.060.110
4X45MM	200	51876.040.045				6X120MM*	100	51876.060.120

Wkręty ciesielskie nierdzewne łeb stożkowy żebrowane/PZ

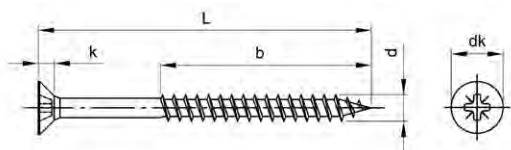

Informacje techniczne

d	d _k	k	Nr wgłębienia krzyżowego
3	6	1.9	1
3.5	7	2.1	2
4	8	2.5	2
4.5	9	2.7	2
5	10	3	2
6	12	3.6	3



Grupy katalogowe

Gniazdo	Materiał	Kod	Strona
Pozidriv	St.St. A2	51874	6-188
Pozidriv	St.St. A4	55874	6-188

6

51874 Wkręty ciesielskie nierdzewne łeb stożkowy żebrowane/PZ R03A

Materiał Stal nierdzewna A2

d _s x L x b	☒	Kod artykułu	d _s x L x b	☒	Kod artykułu	d _s x L x b	☒	Kod artykułu
3X25X18MM*	500	51874.030.025	4X70X36MM*	200	51874.040.070	5X70X42MM*	100	51874.050.070
3X30X18MM*	500	51874.030.030	4X80X48MM*	200	51874.040.080	5X80X48MM*	100	51874.050.080
3X35X24MM*	500	51874.030.035				5X90X54MM*	100	51874.050.090
3X40X24MM*	200	51874.030.040	4,5X25X18MM*	500	51874.045.025	5X100X60MM*	100	51874.050.100
3X45X30MM*	200	51874.030.045	4,5X30X18MM*	500	51874.045.030	5X110X70MM*	100	51874.050.110
3X50X30MM*	200	51874.030.050	4,5X35X24MM*	500	51874.045.035			
			4,5X40X24MM*	200	51874.045.040	6X30X20MM*	100	51874.060.030
3,5X25X18MM*	500	51874.035.025	4,5X45X30MM*	200	51874.045.045	6X35X24MM*	100	51874.060.035
3,5X30X18MM*	500	51874.035.030	4,5X50X30MM*	200	51874.045.050	6X40X24MM*	100	51874.060.040
3,5X35X24MM*	500	51874.035.035	4,5X55X36MM*	200	51874.045.055	6X45X30MM*	100	51874.060.045
3,5X40X24MM*	200	51874.035.040	4,5X60X36MM*	200	51874.045.060	6X50X30MM*	100	51874.060.050
3,5X45X30MM*	200	51874.035.045	4,5X80X48MM*	200	51874.045.080	6X55X36MM*	100	51874.060.055
3,5X50X30MM*	200	51874.035.050	4,5X100X60MM*	200	51874.045.100	6X60X36MM*	100	51874.060.060
						6X70X42MM*	100	51874.060.070
4X25X18MM*	500	51874.040.025	5X25X18MM*	500	51874.050.025	6X80X48MM*	100	51874.060.080
4X30X18MM*	500	51874.040.030	5X30X20MM*	500	51874.050.030	6X90X54MM*	100	51874.060.090
4X35X24MM*	500	51874.040.035	5X35X24MM*	500	51874.050.035	6X130X70MM*	100	51874.060.130
4X40X24MM*	200	51874.040.040	5X40X24MM*	200	51874.050.040	6X140X70MM*	100	51874.060.140
4X45X30MM*	200	51874.040.045	5X45X30MM*	200	51874.050.045	6X150X70MM*	100	51874.060.150
4X50X30MM*	200	51874.040.050	5X50X30MM*	200	51874.050.050	6X160X70MM*	100	51874.060.160
4X55X36MM*	200	51874.040.055	5X55X36MM*	200	51874.050.055	6X180X70MM*	100	51874.060.180
4X60X36MM*	200	51874.040.060	5X60X36MM*	100	51874.050.060	6X200X70MM*	100	51874.060.200
4X65X36MM*	200	51874.040.065	5X65X36MM*	100	51874.050.065			

55874 Wkręty ciesielskie nierdzewne łeb stożkowy żebrowane/PZ R43A

Materiał Stal nierdzewna A4



d _s x L x b	☒	Kod artykułu	d _s x L x b	☒	Kod artykułu	d _s x L x b	☒	Kod artykułu
4X40X24MM*	200	55874.040.040	4,5X25X18MM*	500	55874.045.025	4,5X60X36MM*	200	55874.045.060
4X45X30MM*	200	55874.040.045	4,5X30X18MM*	500	55874.045.030	4,5X70X42MM*	200	55874.045.070
4X50X30MM*	200	55874.040.050	4,5X35X24MM*	500	55874.045.035	4,5X100X60MM*	100	55874.045.100
4X55X36MM*	200	55874.040.055	4,5X40X24MM*	200	55874.045.040			
4X60X36MM*	200	55874.040.060	4,5X45X30MM*	200	55874.045.045	5X25X18MM*	500	55874.050.025
4X70X42MM*	200	55874.040.070	4,5X50X30MM*	200	55874.045.050	5X30X20MM*	500	55874.050.030
			4,5X55X36MM*	200	55874.045.055	5X35X24MM*	500	55874.050.035

55874 Wkręty ciesielskie nierdzewne łeb stożkowy żebrowane/PZ								
$d_s \times L \times b$	☒	Kod artykułu	$d_s \times L \times b$	☒	Kod artykułu	$d_s \times L \times b$	☒	Kod artykułu
5X40X24MM*	200	55874.050.040	6X30X20MM*	100	55874.060.030	6X120X70MM*	100	55874.060.120
5X45X30MM*	200	55874.050.045	6X35X24MM*	100	55874.060.035	6X130X70MM*	100	55874.060.130
5X50X30MM*	200	55874.050.050	6X40X24MM*	100	55874.060.040	6X140X70MM*	100	55874.060.140
5X55X36MM*	200	55874.050.055	6X45X60MM*	100	55874.060.045	6X150X70MM*	100	55874.060.150
5X60X36MM*	100	55874.050.060	6X50X60MM*	100	55874.060.050	6X160X70MM*	100	55874.060.160
5X65X36MM*	100	55874.050.065	6X55X36MM*	100	55874.060.055	6X180X70MM*	100	55874.060.180
5X80X48MM*	100	55874.050.080	6X60X36MM*	100	55874.060.060	6X200X70MM*	100	55874.060.200
5X90X54MM*	100	55874.050.090	6X100X70MM*	100	55874.060.100			
			6X110X70MM*	100	55874.060.110			

Wkręty do drewna z łbem kulistym z gniazdem krzyżowym

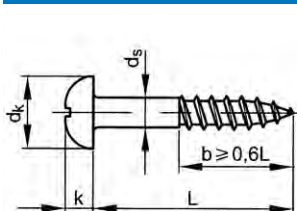

PHILLIPS (H)



Pozidriv (Z)

DIN 7996
NEN 2254
NF E25-603

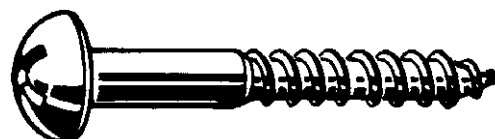

Informacje techniczne

d_s	d_k	k	Nr wgłębienia krzyżowego
3	6	2.1	1
3.5	7	2.35	2
4	8	2.8	2
4.5	9	3.1	2
5	10	3.5	2
6	12	4.2	3

* Gwint wkrętu do drewna zgodny z DIN 7998.

Grupy katalogowe

Gniazdo	Materiał	Obróbka powierzchni	Kod	Strona
Phillips	St	Ocynk.	25710	6-189
Pozidriv	St.St. A2		51866	6-189

25710 Wkręty do drewna z łbem kulistym z gniazdem krzyżowym Phillips				K05A
Materiał	Stal	DIN	7996-H	
Obróbka powierzchni	Ocynkowane			

$d_s \times L$	☒	Kod artykułu	$d_s \times L$	☒	Kod artykułu	$d_s \times L$	☒	Kod artykułu
4X15MM	200	25710.040.015	4X25MM	200	25710.040.025	4X40MM	200	25710.040.040
4X20MM	200	25710.040.020	4X30MM	200	25710.040.030	4X50MM	200	25710.040.050

51866 Wkręty do drewna z łbem kulistym z gniazdem krzyżowym Pozidriv				R03A
Materiał	Stal nierdzewna A2	DIN	7996-Z	

$d_s \times L$	☒	Kod artykułu	$d_s \times L$	☒	Kod artykułu	$d_s \times L$	☒	Kod artykułu
3X10MM	200	51866.030.010				4,5X30MM*	200	51866.045.030
3X12MM*	200	51866.030.012	4X12MM	200	51866.040.012	4,5X35MM*	200	51866.045.035
3X16MM	200	51866.030.016	4X16MM	200	51866.040.016	4,5X40MM*	200	51866.045.040
3X20MM	200	51866.030.020	4X20MM	200	51866.040.020	4,5X45MM*	200	51866.045.045
3X25MM	200	51866.030.025	4X25MM	200	51866.040.025	4,5X60MM*	200	51866.045.060
3X30MM*	200	51866.030.030	4X35MM*	200	51866.040.035			
			4X40MM	200	51866.040.040			
3,5X20MM	200	51866.035.020	4X45MM*	200	51866.040.045	5X20MM	200	51866.050.020
3,5X25MM	200	51866.035.025	4X50MM*	200	51866.040.050	5X25MM	200	51866.050.025
3,5X30MM	200	51866.035.030	4X60MM*	200	51866.040.060	5X30MM	200	51866.050.030
3,5X35MM*	200	51866.035.035				5X35MM	200	51866.050.035
3,5X40MM*	200	51866.035.040	4,5X25MM*	200	51866.045.025	5X40MM	200	51866.050.040
						5X45MM	200	51866.050.045

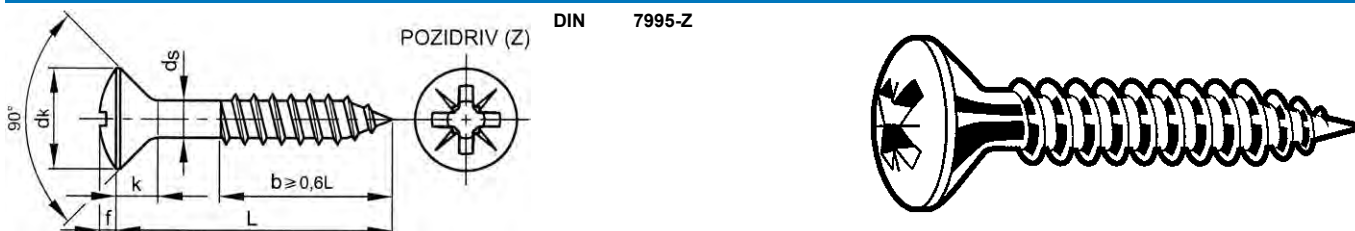

51866 Wkręty do drewna z łbem kulistym z gniazdem krzyżowym Pozidriv								
$d_s \times L$	☒	Kod artykułu	$d_s \times L$	☒	Kod artykułu	$d_s \times L$	☒	Kod artykułu
5X50MM	200	51866.050.050	5X100MM	200	51866.050.100	6X50MM*	200	51866.060.050
5X60MM	200	51866.050.060				6X60MM*	200	51866.060.060
5X70MM	200	51866.050.070	6X30MM*	200	51866.060.030	6X70MM*	100	51866.060.070
5X80MM	200	51866.050.080	6X40MM*	200	51866.060.040	6X80MM*	100	51866.060.080
5X90MM	200	51866.050.090	6X45MM*	200	51866.060.045			

Wkręty do drewna z łbem stożkowym soczewkowym z gniazdem krzyżowym



Informacje techniczne

d_s	d_k	$f \approx$	k (maks.)	Nr wgłębienia krzyżowego
3	5.6	0.75	1.65	1
3.5	6.5	0.9	1.93	2
4	7.5	1	2.2	2
4.5	8.3	1.1	2.35	2
5	9.2	1.25	2.5	2
6	11	1.5	3	3

51866 Wkręty do drewna z łbem stożkowym soczewkowym z gniazdem krzyżowym Pozidriv		R03A
Materiał	Stal nierdzewna A2	 

$d_s \times L$	☒	Kod artykułu	$d_s \times L$	☒	Kod artykułu	$d_s \times L$	☒	Kod artykułu
3X16MM	200	51886.030.016	4X60MM*	200	51886.040.060	5X25MM*	200	51886.050.025
3X20MM*	200	51886.030.020	4X70MM*	200	51886.040.070	5X30MM*	200	51886.050.030
3X25MM	200	51886.030.025				5X35MM*	200	51886.050.035
3X30MM*	200	51886.030.030	4,5X20MM*	200	51886.045.020	5X40MM	200	51886.050.040
3X35MM*	200	51886.030.035	4,5X25MM*	200	51886.045.025	5X45MM*	200	51886.050.045
			4,5X30MM*	200	51886.045.030	5X50MM*	200	51886.050.050
3,5X16MM	200	51886.035.016	4,5X35MM*	200	51886.045.035	5X60MM*	200	51886.050.060
3,5X20MM	200	51886.035.020	4,5X40MM*	200	51886.045.040	5X70MM*	100	51886.050.070
3,5X25MM*	200	51886.035.025	4,5X45MM*	200	51886.045.045	5X80MM*	100	51886.050.080
3,5X30MM*	200	51886.035.030	4,5X50MM*	200	51886.045.050			
3,5X35MM*	200	51886.035.035	4,5X55MM*	200	51886.045.055	6X25MM*	200	51886.060.025
			4,5X60MM*	200	51886.045.060	6X35MM*	200	51886.060.035
4X16MM	200	51886.040.016	4,5X65MM*	200	51886.045.065	6X40MM*	200	51886.060.040
4X20MM	200	51886.040.020	4,5X70MM*	200	51886.045.070	6X45MM*	200	51886.060.045
4X25MM	200	51886.040.025	4,5X80MM*	200	51886.045.080	6X50MM*	200	51886.060.050
4X30MM*	200	51886.040.030	4,5X90MM*	200	51886.045.090	6X60MM*	200	51886.060.060
4X35MM*	200	51886.040.035	4,5X100MM*	200	51886.045.100	6X70MM*	100	51886.060.070
4X40MM*	200	51886.040.040	4,5X120MM*	200	51886.045.120	6X80MM*	100	51886.060.080
4X45MM*	200	51886.040.045	4,5X150MM*	200	51886.045.150	6X90MM*	100	51886.060.090
4X50MM*	200	51886.040.050				6X100MM*	100	51886.060.100

Wkręty do drewna Pozidriv z podkładką /3TG

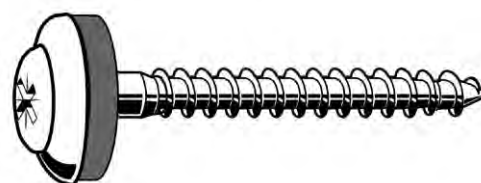
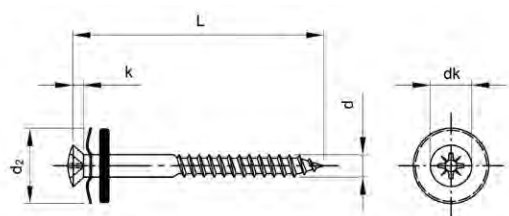

Informacje techniczne

d	d _k	k	Nr wgłębienia krzyżowego
4.5	8.3	2.35	2
5	9.2	2.5	2

Grupy katalogowe

Gniazdo	Materiał	Obróbka powierzchni	Kod	Strona
Pozidriv	St.St. A2		ø podkładki=15mm	51781 6-191
Pozidriv	St.St. A2		ø podkładki=20mm	51785 6-191
Pozidriv	St.St. A2		ø podkładki=25mm	51787 6-191
Pozidriv	St.St. A2	Miedz.	ø podkładki=15mm	51844 6-192
Pozidriv	St.St. A2	Miedz.	ø podkładki=20mm	51846 6-192
Pozidriv	St.St. A2	Miedz.	ø podkładki=25mm	51848 6-192

51781 Wkręty do drewna Pozidriv z podkładką 15mm/3TG

R03A
Materiał Stal nierdzewna A2

d x L x d ₂	⊠	Kod artykułu	d x L x d ₂	⊠	Kod artykułu	d x L x d ₂	⊠	Kod artykułu
4,5X20x15MM*	200	51781.045.020	4,5X55x15MM*	200	51781.045.055	4,5X100x15MM*	100	51781.045.100
4,5X25x15MM*	200	51781.045.025	4,5X60x15MM*	200	51781.045.060	4,5X120x15MM*	100	51781.045.120
4,5X30x15MM*	200	51781.045.030	4,5X65x15MM*	200	51781.045.065	4,5X150x15MM*	100	51781.045.150
4,5X35x15MM*	200	51781.045.035	4,5X70x15MM*	200	51781.045.070			
4,5X40x15MM*	200	51781.045.040	4,5X80x15MM*	200	51781.045.080	5,0X180x15MM*	100	51781.050.180
4,5X45x15MM*	200	51781.045.045	4,5X90x15MM*	200	51781.045.090	5,0X200x15MM*	100	51781.050.200
4,5X50x15MM*	200	51781.045.050						

51785 Wkręty do drewna Pozidriv z podkładką 20mm/3TG

R03A
Materiał Stal nierdzewna A2

d x L x d ₂	⊠	Kod artykułu	d x L x d ₂	⊠	Kod artykułu	d x L x d ₂	⊠	Kod artykułu
4,5X20x20MM*	200	51785.045.020	4,5X35x20MM*	200	51785.045.035	4,5X60x20MM*	200	51785.045.060
4,5X25x20MM*	200	51785.045.025	4,5X45x20MM*	200	51785.045.045	4,5X70x20MM*	200	51785.045.070
4,5X30x20MM*	200	51785.045.030	4,5X55x20MM*	200	51785.045.055	4,5X80x20MM*	200	51785.045.080

51787 Wkręty do drewna Pozidriv z podkładką 25mm/3TG

R03A
Materiał Stal nierdzewna A2

d x L x d ₂	⊠	Kod artykułu	d x L x d ₂	⊠	Kod artykułu	d x L x d ₂	⊠	Kod artykułu
4,5X20x25MM*	200	51787.045.020	4,5X35x25MM*	200	51787.045.035	4,5X70x25MM*	200	51787.045.070
4,5X25x25MM*	200	51787.045.025	4,5X60x25MM*	200	51787.045.060			

51844 Wkręty do drewna Pozidriv z podkładką 15mm/3TG R03A

Materiał Stal nierdzewna A2
Obróbka powierzchni Miedziowane



d x L x d ₂	☒	Kod artykułu	d x L x d ₂	☒	Kod artykułu	d x L x d ₂	☒	Kod artykułu
4,5X20x15MM*	200	51844.045.020	4,5X60x15MM*	200	51844.045.060	4,5X150x15MM*	100	51844.045.150
4,5X25x15MM*	200	51844.045.025	4,5X70x15MM*	200	51844.045.070			
4,5X35x15MM*	200	51844.045.035	4,5X80x15MM*	200	51844.045.080	5,0X180x15MM*	100	51844.050.180
4,5X45x15MM*	200	51844.045.045	4,5X100x15MM*	100	51844.045.100	5,0X200x15MM*	100	51844.050.200
4,5X55x15MM*	200	51844.045.055	4,5X120x15MM*	100	51844.045.120			

51846 Wkręty do drewna Pozidriv z podkładką 20mm/3TG R03A

Materiał Stal nierdzewna A2
Obróbka powierzchni Miedziowane



d x L x d ₂	☒	Kod artykułu	d x L x d ₂	☒	Kod artykułu	d x L x d ₂	☒	Kod artykułu
4,5X20x20MM*	200	51846.045.020	4,5X35x20MM*	200	51846.045.035	4,5X60x20MM*	200	51846.045.060
4,5X25x20MM*	200	51846.045.025	4,5X50x20MM*	200	51846.045.050	4,5X70x20MM*	200	51846.045.070

6
51848 Wkręty do drewna Pozidriv z podkładką 25mm/3TG R03A

Materiał Stal nierdzewna A2
Obróbka powierzchni Miedziowane



d x L x d ₂	☒	Kod artykułu	d x L x d ₂	☒	Kod artykułu
4,5X35x25MM*	200	51848.045.035	4,5X45x25MM*	200	51848.045.045

Wkręty do drewna Pozidriv z podkładką /2TG

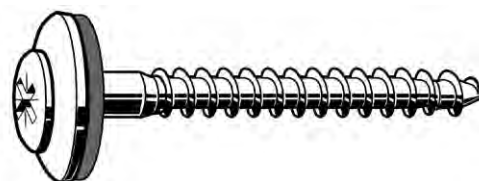
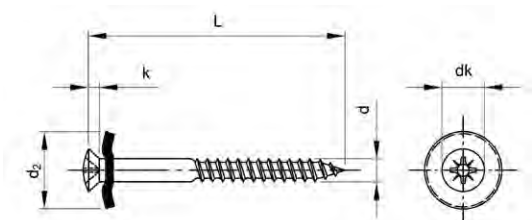

Informacje techniczne

d	d _k	k	Nr wgłębienia krzyżowego
4.5	8.3	2.35	2
5	9.2	2.5	2

Grupy katalogowe

Gniazdo	Materiał	Obróbka powierzchni	Kod	Strona	
Pozidriv	St.St. A2		ø podkładki=15mm	51780	6-193
Pozidriv	St.St. A2		ø podkładki=20mm	51788	6-193
Pozidriv	St.St. A2		ø podkładki=25mm	51786	6-193
Pozidriv	St.St. A2	Miedz.	ø podkładki=15mm	51843	6-194
Pozidriv	St.St. A2	Miedz.	ø podkładki=20mm	51845	6-194
Pozidriv	St.St. A2	Miedz.	ø podkładki=25mm	51847	6-194

51780 Wkręty do drewna Pozidriv z podkładką 25mm/2TG

R03A
Materiał Stal nierdzewna A2

d x L x d ₂	☒	Kod artykułu	d x L x d ₂	☒	Kod artykułu	d x L x d ₂	☒	Kod artykułu
4,5X20x15MM*	200	51780.045.020	4,5X60x15MM*	200	51780.045.060	4,5X150x15MM*	100	51780.045.150
4,5X25x15MM*	200	51780.045.025	4,5X65x15MM*	200	51780.045.065			
4,5X30x15MM*	200	51780.045.030	4,5X70x15MM*	200	51780.045.070	5,0X180x15MM*	100	51780.050.180
4,5X35x15MM*	200	51780.045.035	4,5X80x15MM*	200	51780.045.080	5,0X200x15MM*	100	51780.050.200
4,5X40x15MM*	200	51780.045.040	4,5X90x15MM*	200	51780.045.090	5,0X220x15MM*	100	51780.050.220
4,5X45x15MM*	200	51780.045.045	4,5X100x15MM*	100	51780.045.100	5,0X250x15MM*	100	51780.050.250
4,5X50x15MM*	200	51780.045.050	4,5X120x15MM*	100	51780.045.120	5,0X300x15MM*	100	51780.050.300
4,5X55x15MM*	200	51780.045.055						

51788 Wkręty do drewna Pozidriv z podkładką 20mm/2TG

R03A
Materiał Stal nierdzewna A2

d x L x d ₂	☒	Kod artykułu	d x L x d ₂	☒	Kod artykułu	d x L x d ₂	☒	Kod artykułu
4,5X20x20MM*	200	51788.045.020	4,5X55x20MM*	200	51788.045.055	4,5X150x20MM*	100	51788.045.150
4,5X25x20MM*	200	51788.045.025	4,5X60x20MM*	200	51788.045.060			
4,5X30x20MM*	200	51788.045.030	4,5X65x20MM*	100	51788.045.065	5,0X180x20MM*	100	51788.050.180
4,5X35x20MM*	200	51788.045.035	4,5X70x20MM*	100	51788.045.070	5,0X200x20MM*	100	51788.050.200
4,5X40x20MM*	200	51788.045.040	4,5X80x20MM*	100	51788.045.080	5,0X220x20MM*	100	51788.050.220
4,5X45x20MM*	200	51788.045.045	4,5X100x20MM*	100	51788.045.100	5,0X250x20MM*	100	51788.050.250
4,5X50x20MM*	200	51788.045.050	4,5X120x20MM*	100	51788.045.120			



51786 Wkręty do drewna Pozidriv z podkładką 15mm/2TG

R03A
Materiał Stal nierdzewna A2



d x L x d ₂	☒	Kod artykułu	d x L x d ₂	☒	Kod artykułu	d x L x d ₂	☒	Kod artykułu
4,5X20x25MM*	200	51786.045.020	4,5X40x25MM*	200	51786.045.040	4,5X55x25MM*	200	51786.045.055
4,5X25x25MM*	200	51786.045.025	4,5X45x25MM*	200	51786.045.045	4,5X60x25MM*	200	51786.045.060
4,5X30x25MM*	200	51786.045.030	4,5X50x25MM*	200	51786.045.050	4,5X70x25MM*	200	51786.045.070
4,5X35x25MM*	200	51786.045.035						

51843	Wkręty do drewna Pozidriv z podkładką 25mm/2TG	R03A
Materiał	Stal nierdzewna A2	
Obróbka powierzchni	Miedziowane	
		

d x L x d ₂	☒	Kod artykułu	d x L x d ₂	☒	Kod artykułu	d x L x d ₂	☒	Kod artykułu
4,5X20x15MM*	200	51843.045.020	4,5X55x15MM*	200	51843.045.055	4,5X150x15MM*	100	51843.045.150
4,5X25x15MM*	200	51843.045.025	4,5X60x15MM*	200	51843.045.060			
4,5X30x15MM*	200	51843.045.030	4,5X65x15MM*	200	51843.045.065	5,0X220x15MM*	100	51843.050.220
4,5X35x15MM*	200	51843.045.035	4,5X80x15MM*	200	51843.045.080	5,0X250x15MM*	100	51843.050.250
4,5X40x15MM*	200	51843.045.040	4,5X100x15MM*	100	51843.045.100	5,0X280x15MM*	100	51843.050.280
4,5X45x15MM*	200	51843.045.045	4,5X120x15MM*	100	51843.045.120	5,0X300x15MM*	100	51843.050.300
4,5X50x15MM*	200	51843.045.050						

51845	Wkręty do drewna Pozidriv z podkładką 15mm/2TG	R03A
Materiał	Stal nierdzewna A2	
Obróbka powierzchni	Miedziowane	
		

d x L x d ₂	☒	Kod artykułu	d x L x d ₂	☒	Kod artykułu	d x L x d ₂	☒	Kod artykułu
4,5X20x20MM*	200	51845.045.020	4,5X45x20MM*	200	51845.045.045	4,5X70x20MM*	100	51845.045.070
4,5X25x20MM*	200	51845.045.025	4,5X50x20MM*	200	51845.045.050	4,5X80x20MM*	100	51845.045.080
4,5X30x20MM*	200	51845.045.030	4,5X55x20MM*	200	51845.045.055	4,5X100x20MM*	100	51845.045.100
4,5X35x20MM*	200	51845.045.035	4,5X60x20MM*	200	51845.045.060	4,5X120x20MM*	100	51845.045.120
4,5X40x20MM*	200	51845.045.040	4,5X65x20MM*	100	51845.045.065			

51847	Wkręty do drewna Pozidriv z podkładką 20mm/2TG	R03A
Materiał	Stal nierdzewna A2	
Obróbka powierzchni	Miedziowane	
		

d x L x d ₂	☒	Kod artykułu	d x L x d ₂	☒	Kod artykułu	d x L x d ₂	☒	Kod artykułu
4,5X20x25MM*	200	51847.045.020	4,5X35x25MM*	200	51847.045.035	4,5X50x25MM*	200	51847.045.050
4,5X25x25MM*	200	51847.045.025	4,5X40x25MM*	200	51847.045.040	4,5X60x25MM*	200	51847.045.060
4,5X30x25MM*	200	51847.045.030	4,5X45x25MM*	200	51847.045.045	4,5X70x25MM*	200	51847.045.070

6

Wkręty do drewna TX z podkładką /3TG

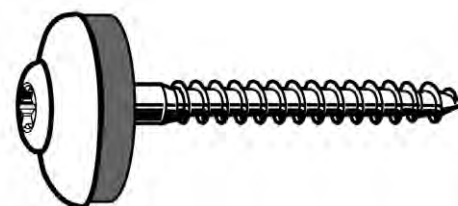
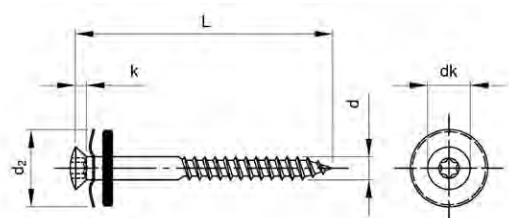

Informacje techniczne

d	d _k	k	Nasadka
4.5	8.3	2.35	T20
5	9.2	2.5	T20

Grupy katalogowe

Gniazdo	Materiał	Obróbka powierzchni	Kod	Strona
Sześciokarbowy	St.St. A2		ø podkładki=15mm	51793 6-195
Sześciokarbowy	St.St. A2		ø podkładki=20mm	51795 6-195
Sześciokarbowy	St.St. A2		ø podkładki=25mm	51797 6-195
Sześciokarbowy	St.St. A2	Miedz.	ø podkładki=15mm	51850 6-196
Sześciokarbowy	St.St. A2	Miedz.	ø podkładki=20mm	51852 6-196

51793 Wkręty do drewna TX z podkładką 15mm/3TG

R03A
Materiał Stal nierdzewna A2

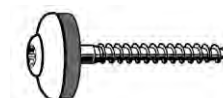

d x L x d ₂	☒	Kod artykułu	d x L x d ₂	☒	Kod artykułu	d x L x d ₂	☒	Kod artykułu
4,5X20X15MM*	200	51793.045.020	4,5X55X15MM*	200	51793.045.055	4,5X120X15MM*	100	51793.045.120
4,5X25X15MM*	200	51793.045.025	4,5X60X15MM*	200	51793.045.060	4,5X150X15MM*	100	51793.045.150
4,5X30X15MM*	200	51793.045.030	4,5X65X15MM*	200	51793.045.065			
4,5X35X15MM*	200	51793.045.035	4,5X70X15MM*	200	51793.045.070	5,0X180X15MM*	100	51793.050.180
4,5X40X15MM*	200	51793.045.040	4,5X80X15MM*	200	51793.045.080	5,0X200X15MM*	100	51793.050.200
4,5X45X15MM*	200	51793.045.045	4,5X90X15MM*	200	51793.045.090	5,0X250X15MM*	100	51793.050.250
4,5X50X15MM*	200	51793.045.050	4,5X100X15MM*	100	51793.045.100	5,0X300X15MM*	100	51793.050.300

51795 Wkręty do drewna TX z podkładką 20mm/3TG

R03A
Materiał Stal nierdzewna A2

d x L x d ₂	☒	Kod artykułu	d x L x d ₂	☒	Kod artykułu	d x L x d ₂	☒	Kod artykułu
4,5X20X20MM*	200	51795.045.020	4,5X40X20MM*	200	51795.045.040	4,5X60X20MM*	200	51795.045.060
4,5X25X20MM*	200	51795.045.025	4,5X45X20MM*	200	51795.045.045	4,5X65X20MM*	100	51795.045.065
4,5X30X20MM*	200	51795.045.030	4,5X50X20MM*	200	51795.045.050	4,5X70X20MM*	100	51795.045.070
4,5X35X20MM*	200	51795.045.035	4,5X55X20MM*	200	51795.045.055	4,5X80X20MM*	100	51795.045.080

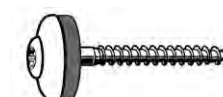
51797 Wkręty do drewna TX z podkładką 25mm/3TG

R03A
Materiał Stal nierdzewna A2

d x L x d ₂	☒	Kod artykułu	d x L x d ₂	☒	Kod artykułu	d x L x d ₂	☒	Kod artykułu
4,5X25X25MM*	200	51797.045.025	4,5X45X25MM*	200	51797.045.045	4,5X55X25MM*	200	51797.045.055
4,5X35X25MM*	200	51797.045.035						

51850	Wkręty do drewna TX z podkładką 15mm/3TG	R03A
Materiał	Stal nierdzewna A2	
Obróbka powierzchni	Miedziowane	

d x L x d ₂	☒	Kod artykułu	d x L x d ₂	☒	Kod artykułu	d x L x d ₂	☒	Kod artykułu
4,5X20X15MM*	200	51850.045.020	4,5X65X15MM*	200	51850.045.065	5,0X180X15MM*	100	51850.050.180
4,5X25X15MM*	200	51850.045.025	4,5X70X15MM*	200	51850.045.070	5,0X200X15MM*	100	51850.050.200
4,5X30X15MM*	200	51850.045.030	4,5X80X15MM*	200	51850.045.080	5,0X220X15MM*	100	51850.050.220
4,5X35X15MM*	200	51850.045.035	4,5X100X15MM*	100	51850.045.100	5,0X250X15MM*	100	51850.050.250
4,5X45X15MM*	200	51850.045.045	4,5X120X15MM*	100	51850.045.120	5,0X280X15MM*	100	51850.050.280
4,5X55X15MM*	200	51850.045.055	4,5X150X15MM*	100	51850.045.150	5,0X300X15MM*	100	51850.050.300
4,5X60X15MM*	200	51850.045.060						

51852	Wkręty do drewna TX z podkładką 20mm/3TG	R03A
Materiał	Stal nierdzewna A2	
Obróbka powierzchni	Miedziowane	

d x L x d ₂	☒	Kod artykułu	d x L x d ₂	☒	Kod artykułu	d x L x d ₂	☒	Kod artykułu
4,5X20X20MM*	200	51852.045.020	4,5X40X20MM*	200	51852.045.040	4,5X60X20MM*	200	51852.045.060
4,5X25X20MM*	200	51852.045.025	4,5X45X20MM*	200	51852.045.045	4,5X70X20MM*	100	51852.045.070
4,5X35X20MM*	200	51852.045.035	4,5X50X20MM*	200	51852.045.050			

6

Wkręty do drewna TX z podkładką /2TG

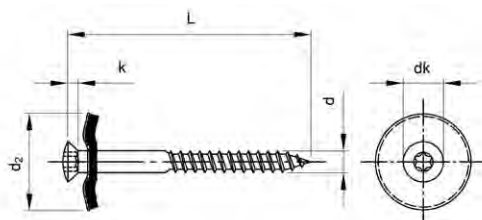

Informacje techniczne

d	d _k	k	Nasadka
4.5	8.3	2.35	T20
5	9.2	2.5	T20
5.5	8.3	5.1	T20

Grupy katalogowe

Gniazdo	Materiał	Obróbka powierzchni	Kod	Strona
Sześciokarbony	St.St. A2		51792	6-196
Sześciokarbony	St.St. A2	∅ podkładki=15mm	51794	6-197
Sześciokarbony	St.St. A2	∅ podkładki=20mm	51796	6-197
Sześciokarbony	St.St. A2	Miedz. ∅ podkładki=15mm	51849	6-197
Sześciokarbony	St.St. A2	Miedz. ∅ podkładki=20mm	51851	6-197

51792	Wkręty do drewna TX z podkładką 15mm/2TG	R03A
Materiał	Stal nierdzewna A2	

d x L x d ₂	☒	Kod artykułu	d x L x d ₂	☒	Kod artykułu	d x L x d ₂	☒	Kod artykułu
4,5X20X15MM*	200	51792.045.020	4,5X60X15MM*	200	51792.045.060	5,0X180X15MM*	100	51792.050.180
4,5X25X15MM*	200	51792.045.025	4,5X65X15MM*	200	51792.045.065	5,0X200X15MM*	100	51792.050.200
4,5X30X15MM*	200	51792.045.030	4,5X70X15MM*	200	51792.045.070	5,0X220X15MM*	100	51792.050.220
4,5X35X15MM*	200	51792.045.035	4,5X80X15MM*	200	51792.045.080	5,0X250X15MM*	100	51792.050.250
4,5X40X15MM*	200	51792.045.040	4,5X90X15MM*	200	51792.045.090	5,0X280X15MM*	100	51792.050.280
4,5X45X15MM*	200	51792.045.045	4,5X120X15MM*	100	51792.045.120	5,0X300X15MM*	100	51792.050.300
4,5X50X15MM*	200	51792.045.050	4,5X150X15MM*	100	51792.045.150			
4,5X55X15MM*	200	51792.045.055						

51794 Wkręty do drewna TX z podkładką 20mm/2TG R03A

Materiał Stal nierdzewna A2



d x L x d ₂	☒	Kod artykułu	d x L x d ₂	☒	Kod artykułu	d x L x d ₂	☒	Kod artykułu
4,5X20X20MM*	200	51794.045.020	4,5X55X20MM*	200	51794.045.055	4,5X150X20MM*	100	51794.045.150
4,5X25X20MM*	200	51794.045.025	4,5X60X20MM*	200	51794.045.060	5,0X180X20MM*	100	51794.050.180
4,5X30X20MM*	200	51794.045.030	4,5X65X20MM*	100	51794.045.065	5,0X200X20MM*	100	51794.050.200
4,5X35X20MM*	200	51794.045.035	4,5X70X20MM*	100	51794.045.070	5,0X220X20MM*	100	51794.050.220
4,5X40X20MM*	200	51794.045.040	4,5X80X20MM*	100	51794.045.080	5,0X250X20MM*	100	51794.050.250
4,5X45X20MM*	200	51794.045.045	4,5X100X20MM*	100	51794.045.100			
4,5X50X20MM*	200	51794.045.050	4,5X120X20MM*	100	51794.045.120			

51796 Wkręty do drewna TX z podkładką 25mm/2TG R03A

Materiał Stal nierdzewna A2



d x L x d ₂	☒	Kod artykułu	d x L x d ₂	☒	Kod artykułu	d x L x d ₂	☒	Kod artykułu
4,5X20X25MM*	200	51796.045.020	4,5X45X25MM*	200	51796.045.045	4,5X60X25MM*	200	51796.045.060
4,5X25X25MM*	200	51796.045.025	4,5X55X25MM*	200	51796.045.055	4,5X70X25MM*	100	51796.045.070
4,5X35X25MM*	200	51796.045.035						

51849 Wkręty do drewna TX z podkładką 15mm/2TG R03A

Materiał Stal nierdzewna A2
Obrobka powierzchni Miedziane



d x L x d ₂	☒	Kod artykułu	d x L x d ₂	☒	Kod artykułu	d x L x d ₂	☒	Kod artykułu
4,5X20X15MM*	200	51849.045.020	4,5X55X15MM*	200	51849.045.055	4,5X150X15MM*	100	51849.045.150
4,5X25X15MM*	200	51849.045.025	4,5X60X15MM*	200	51849.045.060	5,0X180X15MM*	100	51849.045.180
4,5X30X15MM*	200	51849.045.030	4,5X65X15MM*	200	51849.045.065	5,0X200X15MM*	100	51849.050.200
4,5X35X15MM*	200	51849.045.035	4,5X70X15MM*	200	51849.045.070	5,0X220X15MM*	100	51849.050.220
4,5X40X15MM*	200	51849.045.040	4,5X80X15MM*	200	51849.045.080	5,0X250X15MM*	100	51849.050.250
4,5X45X15MM*	200	51849.045.045	4,5X90X15MM*	200	51849.045.090	5,0X280X15MM*	100	51849.050.280
4,5X50X15MM*	200	51849.045.050	4,5X100X15MM*	100	51849.045.100	5,0X300X15MM*	100	51849.050.300
			4,5X120X15MM*	100	51849.045.120			

51851 Wkręty do drewna TX z podkładką 20mm/2TG R03A

Materiał Stal nierdzewna A2
Obrobka powierzchni Miedziane



d x L x d ₂	☒	Kod artykułu	d x L x d ₂	☒	Kod artykułu	d x L x d ₂	☒	Kod artykułu
4,5X20X20MM*	200	51851.045.020	4,5X55X20MM*	200	51851.045.055	5,0X200X20MM*	100	51851.050.200
4,5X25X20MM*	200	51851.045.025	4,5X60X20MM*	200	51851.045.060	5,0X220X20MM*	100	51851.050.220
4,5X30X20MM*	200	51851.045.030	4,5X65X20MM*	100	51851.045.065	5,0X250X20MM*	100	51851.050.250
4,5X35X20MM*	200	51851.045.035	4,5X70X20MM*	100	51851.045.070	5,0X280X20MM*	100	51851.050.280
4,5X40X20MM*	200	51851.045.040	4,5X80X20MM*	100	51851.045.080	5,0X300X20MM*	100	51851.050.300
4,5X45X20MM*	200	51851.045.045	4,5X100X20MM*	100	51851.045.100			
4,5X50X20MM*	200	51851.045.050	4,5X120X20MM*	100	51851.045.120			

Wkręty do ścian z płytami okładzinowymi (mur suchy) z łbem stożkowym

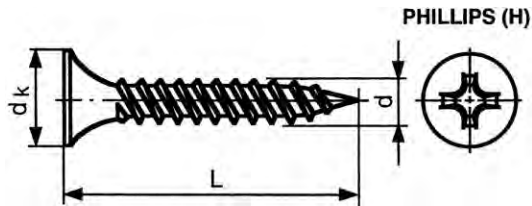

Informacje techniczne



Nr	d	d _k	Nr wgłębienia krzyżowego
6	3.5	8.3	2

Specjalne właściwości wkrętów do suchego muru (ścian pokrytych płytami okładzinowymi):

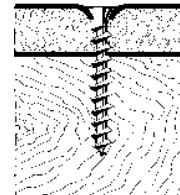
- odpowiednie do mocowania tynku gipsowego na szkieletie konstrukcji każdego typu drewna lub metalu do grubości 0,75 mm
- łeb w kształcie tuby zagłębia się w taki sposób, że może on w prosty sposób zostać przykryty i nie pozostawiając widocznych, sterzących miejsc



6

31305	Wkręty do ścian pokrytych płytami okładzinowymi z łbem stożkowym płaskim z gniazdem krzyżowym Philips z gwintem drobno-zwojnym o 2 początkach	J11A
Materiał	Stal	
Obróbka powierzchni	Fosfatowane	
		
		

Nr x L	⊠	Kod artykułu	Nr x L	⊠	Kod artykułu	Nr x L	⊠	Kod artykułu
NO.6X1 Inch	1000	31305.035.025	NO.6X1.5/8	1000	31305.035.041	NO.6X2.1/4	500	31305.035.057

- Szybkie przenikanie z powodu dwóch nacinających gwintów (drobnozwojnych).

Wkręty z łbem stożkowym do ścian pokrytych płytami gipsowo-kartonowymi

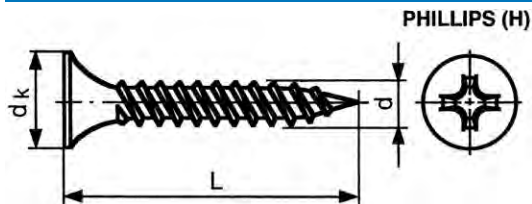

Informacje techniczne

d	dk	Nr wgłębienia krzyżowego
3.5	8.5	2
3.9	8.5	2
4.2	8.5	2
4.8	8.5	2

Specjalne właściwości wkrętów do suchego muru (ścian pokrytych płytami okładzinowymi):

- odpowiednie do mocowania tynku gipsowego na szkielecie konstrukcji każdego typu drewna lub metalu do grubości 0,75 mm
- łeb w kształcie tuby zagłębia się w taki sposób, że może on w prosty sposób zostać przykryty i nie pozostawiając widocznych, sterczących miejsc



6

31310 Wkręty do ścian pokrytych płytami okładzinowymi z łbem stożkowym płaskim z gniazdem krzyżowym Philips z gwintem drobno-zwojnym o 2 początkach J11A

Materiał Stal
Obróbka powierzchni Fosfatowane



d x L	☒	Kod artykułu	d x L	☒	Kod artykułu	d x L	☒	Kod artykułu
3,5X25MM	1000	31310.035.025	3,9X45MM	1000	31310.039.045	4,2X75MM	1000	31310.042.075
3,5X35MM	1000	31310.035.035	3,9X65MM	1000	31310.039.065	4,8X70MM	250	31310.048.070
3,5X45MM	1000	31310.035.045						
3,5X55MM	500	31310.035.055						

- Szybkie przenikanie z powodu dwóch nacinających gwintów (drobnozwojnych).

Zaślepki do wkrętów z łbem stożkowym z otworem

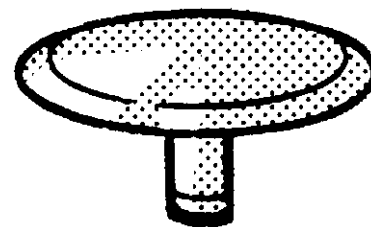
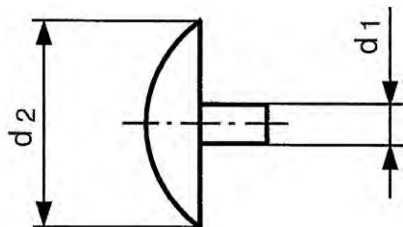

RAL	
1001	Beżowy
1005	Miodowo żółty
1011	Brązowo beżowy
1014	Kość słoniowa
1015	Jasna kość słoniowa
1017	Szafranowo żółty

RAL	
6009	Jodłowo zielony
7001	Srebro szary
7011	Żelazno-szary
7035	Jasnoszary
7038	Agatowo szary

RAL	
8001	Orchowo brązowy
8007	Płowo brązowy
8011	Orzechowo brązowy
8014	Sepiowo brązowy

RAL	
9005	Czarny
9010	Czysta biel

Grupy katalogowe

Materiał	Klasa	Kolor	Kod	Strona
Plastik PA	PA 6.6	Różny	25860	6-200
Plastik PA	PA 6.6	d2=15mm	25862	6-200

6

25860 Zaślepki do wkrętów z łbem stożkowym z otworem K90A

Materiał	Plastik Poliamid (nylon)
Klasa	PA 6.6
Kolor	Różny



d ₁ x d ₂ - RAL	☒	Kod artykułu	d ₁ x d ₂ - RAL	☒	Kod artykułu	d ₁ x d ₂ - RAL	☒	Kod artykułu
2,5x12-1001	200	25860.251.001	2,5x12-7035	200	25860.257.035	3x15-1014	200	25860.301.014
2,5x12-1005	200	25860.251.005	2,5x12-7038	200	25860.257.038	3x15-1017	200	25860.301.017
2,5x12-1011	200	25860.251.011	2,5x12-8001	200	25860.258.001	3x15-8001	200	25860.308.001
2,5x12-1014	200	25860.251.014	2,5x12-8011	200	25860.258.011	3x15-8007	200	25860.308.007
2,5x12-1015	200	25860.251.015	2,5x12-8014	200	25860.258.014	3x15-8011	200	25860.308.011
2,5x12-6009	200	25860.256.009	2,5x12-9005	200	25860.259.005	3x15-9005	200	25860.309.005
2,5x12-7001	200	25860.257.001	2,5x12-9010	200	25860.259.010	3x15-9010	200	25860.309.010
2,5x12-7011	200	25860.257.011	3x15-1011	200	25860.301.011			

25862 Zaślepki do wkrętów z łbem stożkowym z otworem, d2=15 K90A

Materiał	Plastik Poliamid (nylon)
Klasa	PA 6.6
Kolor	Różny



d ₁ x d ₂ - RAL	☒	Kod artykułu	d ₁ x d ₂ - RAL	☒	Kod artykułu	d ₁ x d ₂ - RAL	☒	Kod artykułu
2,5x15-1011	200	25862.251.011	2,5x15-8007	200	25862.258.007	2,5x15-9005	200	25862.259.005
2,5x15-1014	200	25862.251.014	2,5x15-8011	200	25862.258.011	2,5x15-9010	200	25862.259.010

Zaślepki do wkrętów do płyt wiórowych z łbem stożkowym z gniazdem krzyżowym

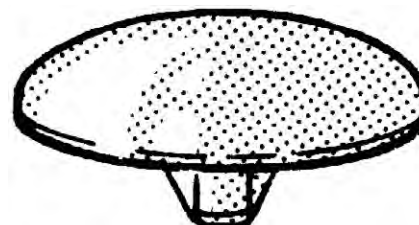
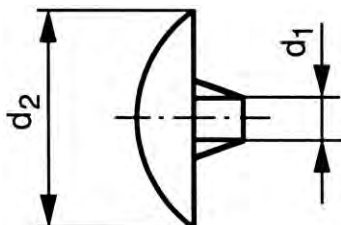

- Cechy specjalne pokryw do wkrętów do płyt wiórowych z łbem stożkowym z gniazdem krzyżowym Pozidriv:
- Zapobiegają korozji i zbieraniu się brudu we wgłębieniu.
- Ładny wygląd.
- Proste w montażu.
- Wielokrotnego użytku.

RAL	
1011	Brązowo beżowy
1014	Kość słoniowa
1017	Szafranowo żółty

RAL	
7001	Srebrno szary

RAL	
8001	Orchowo brązowy
8007	Płowo brązowy
8011	Orzechowo brązowy
8012	Czerwono brązowy

RAL	
9005	Czarny
9010	Czysta biel

29390 Zaślepki do wkrętów do płyt wiórowych z łbem stożkowym z gniazdem krzyżowym

K03D

Materiał	Plastik Poliamid (nylon)
Klasa	PA 6.6
Kolor	Różny

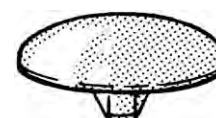

$d_1 \times d_2$ - RAL	☒	Kod artykułu	$d_1 \times d_2$ - RAL	☒	Kod artykułu	$d_1 \times d_2$ - RAL	☒	Kod artykułu
2x12-7001	200	29390.001.770	2x12-8007	200	29390.028.007	3x14,5-1014	200	29390.031.014
2x12-1011	200	29390.021.011	2x12-8011	200	29390.028.011	3x14,5-8011	200	29390.038.011
2x12-1014	200	29390.021.014	2x12-8012	200	29390.028.012	3x14,5-9005	200	29390.039.005
2x12-1017	200	29390.021.017	2x12-9005	200	29390.029.005	3x14,5-9010	200	29390.039.010
2x12-8001	200	29390.028.001	2x12-9010	200	29390.029.010			

Zaślepki do wkrętów do drewna z łbem sześciokątnym

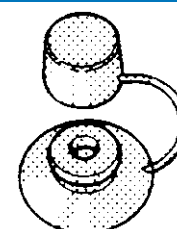

08290 Zaślepki do wkrętów do drewna z łbem sześciokątnym

E07A

Materiał	Plastik Poliamid (nylon)
Klasa	6
Kolor	Różny

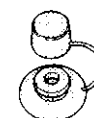

Dla wymiaru nominalnego	☒	Kod artykułu	Dla wymiaru nominalnego	☒	Kod artykułu
6-7MM Czarny	100	08290.070.001	7MM Szary	100	08290.070.011

Zaślepki zatrzaskowe do wkrętów

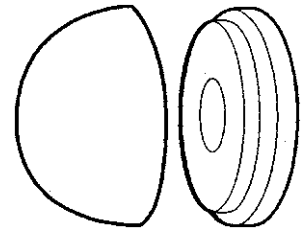
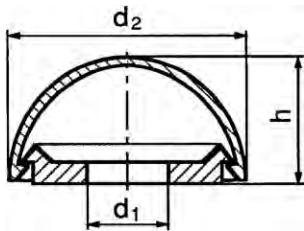

Informacje techniczne

d	d ₁	d ₂	h	d	d ₁	d ₂	h
M4	4.3	12	5.9	M6	6.4	16.8	7.5
M5	5.3	14.5	6.5	M8	8.4	20.8	10.2

Przykład zastosowania

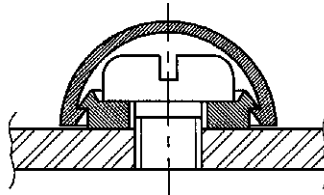

6

56610		Zaślepki zatrzaskowe do wkrętów		W02A	
Materiał	Plastik Poliamid (nylon)				
Klasa	PA 6.6				
Kolor	Biały				



d	☒	Kod artykułu	d	☒	Kod artykułu	d	☒	Kod artykułu
M4	250	56610.040.001	M6	250	56610.060.001	M8	250	56610.080.001
M5	250	56610.050.001						

Śruby z łbem płytkowym

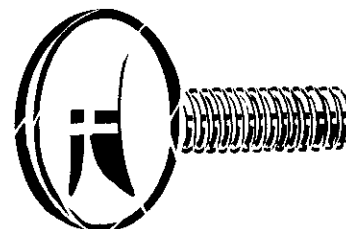
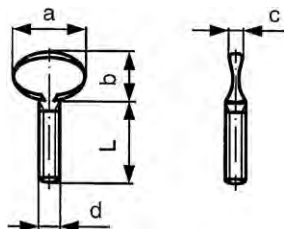

Informacje techniczne

d	a	b	c	P
M5	20.5	15.5	3.5	0.8
M6	23.5	16	4.5	1
M8	27.5	19	4.5	1.25
M10	36	25	6.5	1.5

16295 Śruby z łbem płytkowym

F11G

Gwint Metryczny
Materiał Żeliwo 35
Obróbka powierzchni Ocynkowane

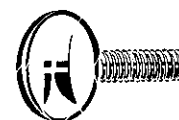

d x L	☒	Kod artykułu	d x L	☒	Kod artykułu	d x L	☒	Kod artykułu
M5X10	200	16295.050.010	M6X20	100	16295.060.020	M8X40	50	16295.080.040
M5X12	200	16295.050.012	M6X25	100	16295.060.025	M8X50	50	16295.080.050
M5X16	200	16295.050.016	M6X30	100	16295.060.030	M10X20	50	16295.100.020
M5X20	200	16295.050.020	M8X16	100	16295.080.016	M10X25	50	16295.100.025
M6X10	200	16295.060.010	M8X20	100	16295.080.020	M10X30	50	16295.100.030
M6X12	200	16295.060.012	M8X25	100	16295.080.025	M10X40	50	16295.100.040
M6X16	100	16295.060.016	M8X30	100	16295.080.030	M10X50	20	16295.100.050

- L = użyteczna długość gwintu.

Śruby z łbem radełkowym wysokim

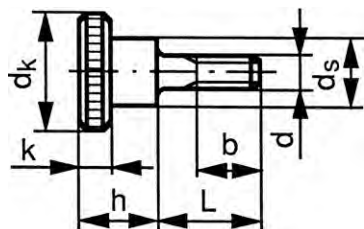

DIN 464

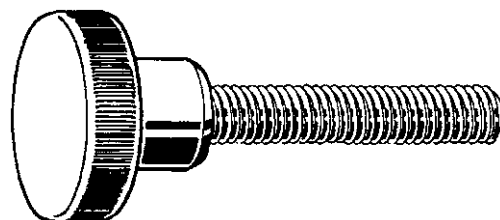

Informacje techniczne

d	b	d _k	d _s	h	k	P	Pelen gwint L ≤
M3	9	12	6	7.5	2.5	0.5	12
M4	12	16	8	9.5	3.5	0.7	16
M5	15	20	10	11.5	4	0.8	16
M6	18	24	12	15	5	1	20
M8	24	30	16	18	6	1.25	25
M10	30	36	20	23	8	1.5	30

Grupy katalogowe

Gwint	Materiał	Obróbka powierzchni	Kod	Strona
M	Stal automatowa	Ocynk.	16650	6-204
M	St.St. A1		51829	6-204
M	Mosiądz Cu3		47480	6-205

6

16650 Śruby z łbem radełkowym wysokim

F11G

Gwint Metryczny
 Materiał Stal automatowa
 Obróbka powierzchni Ocynkowane

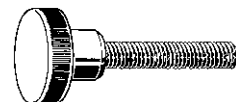

d x L	☒	Kod artykułu	d x L	☒	Kod artykułu	d x L	☒	Kod artykułu
M3X6	100	16650.030.006	M5X6	50	16650.050.006	M6X40	25	16650.060.040
M3X8	100	16650.030.008	M5X8	50	16650.050.008	M6X50	25	16650.060.050
M3X10	100	16650.030.010	M5X10	50	16650.050.010	M8X10	25	16650.080.010
M3X12	100	16650.030.012	M5X12	50	16650.050.012	M8X12	25	16650.080.012
M3X16	100	16650.030.016	M5X16	50	16650.050.016	M8X16	25	16650.080.016
M3X20	100	16650.030.020	M5X20	50	16650.050.020	M8X20	25	16650.080.020
M3X25	100	16650.030.025	M5X25	50	16650.050.025	M8X25	25	16650.080.025
M3X30	100	16650.030.030	M5X30	50	16650.050.030	M8X30	25	16650.080.030
M4X6	50	16650.040.006	M5X40	50	16650.050.040	M8X40	25	16650.080.040
M4X8	50	16650.040.008	M6X8	25	16650.060.008	M8X50	25	16650.080.050
M4X10	50	16650.040.010	M6X10	25	16650.060.010	M10X16	10	16650.100.016
M4X12	50	16650.040.012	M6X12	25	16650.060.012	M10X20	10	16650.100.020
M4X16	50	16650.040.016	M6X16	25	16650.060.016	M10X25	10	16650.100.025
M4X20	50	16650.040.020	M6X20	25	16650.060.020	M10X30	10	16650.100.030
M4X25	50	16650.040.025	M6X25	25	16650.060.025	M10X40	10	16650.100.040
M4X30	50	16650.040.030	M6X30	25	16650.060.030	M10X50	10	16650.100.050
M4X40	50	16650.040.040						

51829 Śruby z łbem radełkowym wysokim

R09A

Gwint Metryczny
 Materiał Stal nierdzewna A1

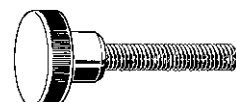

d x L	☒	Kod artykułu	d x L	☒	Kod artykułu	d x L	☒	Kod artykułu
M3X4*	50	51829.030.004	M4X8*	50	51829.040.008	M5X16*	25	51829.050.016
M3X5*	50	51829.030.005	M4X10*	50	51829.040.010	M5X18*	25	51829.050.018
M3X6*	50	51829.030.006	M4X12*	50	51829.040.012	M5X20*	25	51829.050.020
M3X8*	50	51829.030.008	M4X16*	50	51829.040.016	M6X8*	25	51829.060.008
M3X10*	50	51829.030.010	M4X20*	50	51829.040.020	M6X10*	25	51829.060.010
M3X12*	50	51829.030.012	M4X25*	50	51829.040.025	M6X12*	25	51829.060.012
M3X16*	50	51829.030.016	M5X6*	25	51829.050.006	M6X16*	25	51829.060.016
M3X20*	50	51829.030.020	M5X8*	25	51829.050.008	M6X20*	25	51829.060.020
M4X5*	50	51829.040.005	M5X10*	25	51829.050.010	M6X25*	25	51829.060.025
M4X6*	50	51829.040.006	M5X12*	25	51829.050.012			

51829 Śruby z łbem radełkowym wysokim

d x L	☒	Kod artykułu	d x L	☒	Kod artykułu
M8X12*	25	51829.080.012	M8X20*	25	51829.080.020
M8X16*	25	51829.080.016	M8X25*	25	51829.080.025

47480 Śruby z łbem radełkowym wysokim M11D

Gwint Metryczny
Materiał Mosiądz Cu3

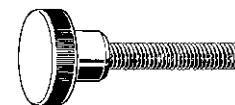

d x L	☒	Kod artykułu	d x L	☒	Kod artykułu	d x L	☒	Kod artykułu
M3X6	100	47480.030.006	M5X8	50	47480.050.008	M6X16	25	47480.060.016
M3X8	100	47480.030.008	M5X10	50	47480.050.010	M6X20	25	47480.060.020
M3X10	100	47480.030.010	M5X12	50	47480.050.012	M6X25	25	47480.060.025
M3X12	100	47480.030.012	M5X16	50	47480.050.016	M6X30	25	47480.060.030
M3X16	100	47480.030.016	M5X20	50	47480.050.020	M6X40	25	47480.060.040
M3X20	100	47480.030.020	M5X25	50	47480.050.025	M8X12	25	47480.080.012
M4X8	50	47480.040.008	M5X30	50	47480.050.030	M8X16	25	47480.080.016
M4X10	50	47480.040.010	M6X8	25	47480.060.008	M8X20	25	47480.080.020
M4X12	50	47480.040.012	M6X10	25	47480.060.010	M8X25	25	47480.080.025
M4X16	50	47480.040.016	M6X12	25	47480.060.012	M8X30	25	47480.080.030
M4X20	50	47480.040.020				M8X40	25	47480.080.040
M4X30	50	47480.040.030						

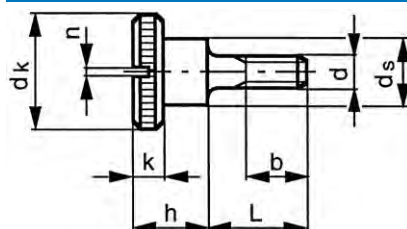
Śruby z łbem radełkowym wysokim z rowkiem
6

DIN 464 Sz

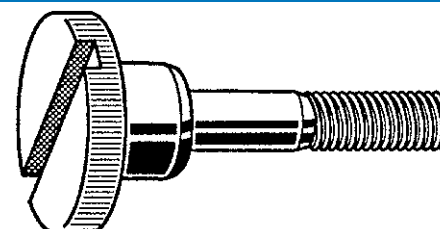
Informacje techniczne

d	b	dk	ds	h	k	n	P	Pelen gwint L ≤
M3	9	12	6	7.5	2.5	0.8	0.5	10
M4	12	16	8	9.5	3.5	1	0.7	16
M5	15	20	10	11.5	4	1.2	0.8	16
M6	18	24	12	15	5	1.6	1	20

51828 Śruby z łbem radełkowym wysokim z rowkiem R09A

Gwint Metryczny
Materiał Stal nierdzewna A1

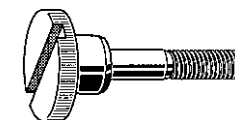

d x L	☒	Kod artykułu	d x L	☒	Kod artykułu	d x L	☒	Kod artykułu
M3X6	50	51828.030.006	M4X12	25	51828.040.012	M5X40	25	51828.050.040
M3X8	50	51828.030.008	M4X16	25	51828.040.016	M6X10	10	51828.060.010
M3X10	50	51828.030.010	M4X20	25	51828.040.020	M6X12	10	51828.060.012
M3X12*	50	51828.030.012	M4X30	25	51828.040.030	M6X16	10	51828.060.016
M3X16*	50	51828.030.016	M5X10	25	51828.050.010	M6X20	10	51828.060.020
M4X6*	50	51828.040.006	M5X12	25	51828.050.012	M6X25	10	51828.060.025
M4X8	25	51828.040.008	M5X16	25	51828.050.016	M6X30	10	51828.060.030
M4X10	25	51828.040.010	M5X20	25	51828.050.020			

Śruby z łbem radełkowym niskim

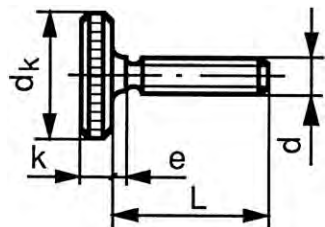

DIN 653

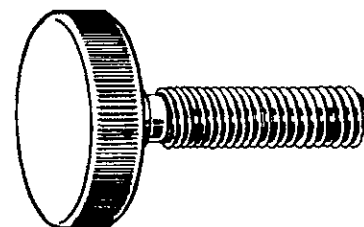

Informacje techniczne

d	d _k	e	k	P	Pełen gwint L ≤
M3	12	2	2.5	0.5	10
M4	16	3	3.5	0.7	16
M5	20	3	4	0.8	16
M6	24	4	5	1	16
M8	30	5	6	1.25	20
M10	36	6	8	1.5	25

Grupy katalogowe

Gwint	Materiał	Obróbka powierzchni	Kod	Strona
M	Stal automatowa	Ocynk.	16660	6-206
M	St.St. A1		51503	6-206
M	Mosiądz Cu3		47490	6-207

6

16660 Śruby z łbem radełkowym niskim

F11G

Gwint Metryczny
Materiał Stal automatowa
Obróbka powierzchni Ocynkowane

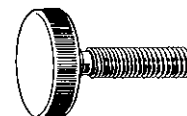

d x L	☒	Kod artykułu	d x L	☒	Kod artykułu	d x L	☒	Kod artykułu
M3X6	100	16660.030.006	M5X8	50	16660.050.008	M6X40	25	16660.060.040
M3X8	100	16660.030.008	M5X10	50	16660.050.010	M6X50	25	16660.060.050
M3X10	100	16660.030.010	M5X12	50	16660.050.012	M8X12	25	16660.080.012
M3X12	100	16660.030.012	M5X16	50	16660.050.016	M8X16	25	16660.080.016
M3X16	100	16660.030.016	M5X20	50	16660.050.020	M8X20	25	16660.080.020
M3X20	100	16660.030.020	M5X25	50	16660.050.025	M8X25	25	16660.080.025
M3X25	100	16660.030.025	M5X30	50	16660.050.030	M8X30	25	16660.080.030
M4X6	50	16660.040.006	M5X40	50	16660.050.040	M8X40	25	16660.080.040
M4X8	50	16660.040.008	M6X10	25	16660.060.010	M8X50	25	16660.080.050
M4X10	50	16660.040.010	M6X12	25	16660.060.012	M10X20	10	16660.100.020
M4X12	50	16660.040.012	M6X16	25	16660.060.016	M10X25	10	16660.100.025
M4X16	50	16660.040.016	M6X20	25	16660.060.020	M10X30	10	16660.100.030
M4X20	50	16660.040.020	M6X25	25	16660.060.025	M10X40	10	16660.100.040
M4X25	50	16660.040.025	M6X30	25	16660.060.030	M10X50	10	16660.100.050

51503 Śruby z łbem radełkowym niskim

R09A

Gwint Metryczny
Materiał Stal nierdzewna A1

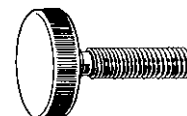

d x L	☒	Kod artykułu	d x L	☒	Kod artykułu	d x L	☒	Kod artykułu
M3X10*	50	51503.030.010	M5X10*	25	51503.050.010	M6X20*	25	51503.060.020
M3X12*	50	51503.030.012	M5X12*	25	51503.050.012	M6X25*	25	51503.060.025
M3X16*	50	51503.030.016	M5X16*	25	51503.050.016	M6X30*	25	51503.060.030
M4X8*	50	51503.040.008	M5X20*	25	51503.050.020	M8X12*	25	51503.080.012
M4X10*	50	51503.040.010	M6X10*	25	51503.060.010	M8X16*	25	51503.080.016
M4X12*	50	51503.040.012	M6X12*	25	51503.060.012	M8X20*	25	51503.080.020
M4X16*	50	51503.040.016	M6X16*	25	51503.060.016	M8X25*	25	51503.080.025
M4X20*	50	51503.040.020				M8X30*	25	51503.080.030
M4X25*	50	51503.040.025						

47490		Śruby z łbem radełkowym niskim		M11D	
Gwint	Metryczny				
Materiał	Mosiądz Cu3				

d x L	☒	Kod artykułu	d x L	☒	Kod artykułu	d x L	☒	Kod artykułu
M3X6	100	47490.030.006	M4X25	50	47490.040.025	M6X12	25	47490.060.012
M3X8	100	47490.030.008				M6X16	25	47490.060.016
M3X10	100	47490.030.010	M5X8	50	47490.050.008	M6X20	25	47490.060.020
M3X12	100	47490.030.012	M5X10	50	47490.050.010	M6X25	25	47490.060.025
M3X16	100	47490.030.016	M5X12	50	47490.050.012	M6X30	25	47490.060.030
M3X20	100	47490.030.020	M5X16	50	47490.050.016			
M4X8	50	47490.040.008	M5X20	50	47490.050.020	M8X16	25	47490.080.016
M4X10	50	47490.040.010	M5X25	50	47490.050.025	M8X20	25	47490.080.020
M4X12	50	47490.040.012	M5X30	50	47490.050.030	M8X25	25	47490.080.025
M4X16	50	47490.040.016	M6X10	25	47490.060.010	M8X30	25	47490.080.030
M4X20	50	47490.040.020				M8X40	25	47490.080.040

Śruby z łbem radełkowym

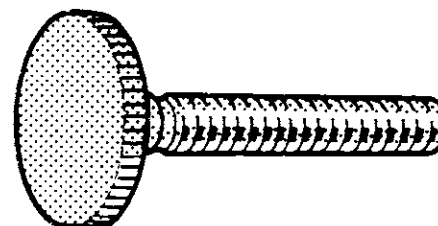
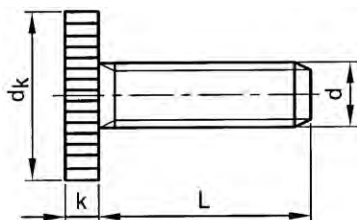

6

Informacje techniczne

d	d _k	k	P
M5	16	3.4	0.8
M6	16	3.4	1
M8	16	3.4	1.25

56230		Śruby z łbem radełkowym plastikowe		W02A	
Gwint	Metryczny				
Materiał	Plastik				
Klasa	PA 6.6				
Kolor	Biały				

d x L	☒	Kod artykułu	d x L	☒	Kod artykułu	d x L	☒	Kod artykułu
M5X30	100	56230.050.030	M6X16	50	56230.060.016	M8X16	25	56230.080.016
			M6X20	50	56230.060.020	M8X20	25	56230.080.020
M6X8	100	56230.060.008	M6X25	50	56230.060.025	M8X25	25	56230.080.025
M6X10	50	56230.060.010	M6X30	50	56230.060.030			

Śruby skrzydełkowe niskie model amerykański

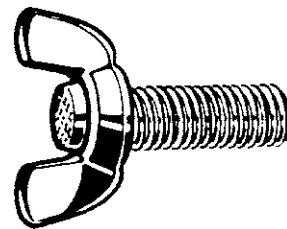
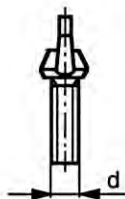
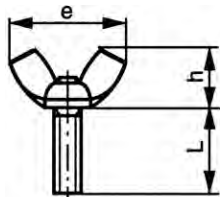

Informacje techniczne

d	e ≈	h ≈	P	d	e ≈	h ≈	P
M3	18.5	8.8	0.5	M8	30.3	14.8	1.25
M4	22	10.5	0.7	M10	35.3	17.3	1.5
M5	22	10.5	0.8	M12	47.4	22.3	1.75
M6	26.8	12.9	1				

Grupy katalogowe

Gwint	Gniazdo	Materiał	Kod	Strona
M	Skrzydełko	St.St. A2	51820	6-208
M	Skrzydełko	St.St. A4	55820	6-208

6

51820		Śruby skrzydełkowe niskie model amerykański		R09A
Gwint	Metryczny	Materiał	Stal nierdzewna A2	
				

d x L	☒	Kod artykułu	d x L	☒	Kod artykułu	d x L	☒	Kod artykułu
M3X10*	100	51820.030.010	M5X40*	50	51820.050.040	M8X45*	50	51820.080.045
M3X12*	100	51820.030.012	M5X45*	50	51820.050.045	M8X50*	50	51820.080.050
M3X16*	100	51820.030.016	M5X50*	50	51820.050.050	M8X60*	50	51820.080.060
M3X20*	100	51820.030.020						
M3X25*	100	51820.030.025	M6X10	25	51820.060.010	M10X16*	25	51820.100.016
			M6X12*	50	51820.060.012	M10X20	10	51820.100.020
M4X10*	100	51820.040.010	M6X15/16	25	51820.060.015	M10X25	10	51820.100.025
M4X12*	100	51820.040.012	M6X16	25	51820.060.016	M10X30	10	51820.100.030
M4X16	25	51820.040.016	M6X20	25	51820.060.020	M10X35*	25	51820.100.035
M4X20*	100	51820.040.020	M6X25	25	51820.060.025	M10X40	10	51820.100.040
M4X25*	100	51820.040.025	M6X30	25	51820.060.030	M10X50	10	51820.100.050
M4X30*	100	51820.040.030	M6X35*	50	51820.060.035	M10X60*	25	51820.100.060
M4X35*	100	51820.040.035	M6X40	25	51820.060.040			
M4X40*	100	51820.040.040	M6X45*	50	51820.060.045	M12X20*	25	51820.120.020
			M6X50*	50	51820.060.050	M12X25*	25	51820.120.025
M5X10	25	51820.050.010				M12X30*	25	51820.120.030
M5X12*	50	51820.050.012	M8X15/16	10	51820.080.015	M12X35*	25	51820.120.035
M5X15/16	25	51820.050.015	M8X20	10	51820.080.020	M12X40*	25	51820.120.040
M5X20	25	51820.050.020	M8X25	10	51820.080.025	M12X50*	25	51820.120.050
M5X25	25	51820.050.025	M8X30	10	51820.080.030	M12X60*	25	51820.120.060
M5X30	25	51820.050.030	M8X35*	50	51820.080.035			
M5X35*	50	51820.050.035	M8X40	10	51820.080.040			

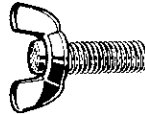
55820		Śruby skrzydełkowe niskie model amerykański		R49A
Gwint	Metryczny	Materiał	Stal nierdzewna A4	
				

d x L	☒	Kod artykułu	d x L	☒	Kod artykułu	d x L	☒	Kod artykułu
M3X12*	100	55820.030.012	M5X15/16	25	55820.050.015	M6X30	25	55820.060.030
M3X16*	100	55820.030.016	M5X20*	50	55820.050.020	M6X40	25	55820.060.040
M3X30*	100	55820.030.030	M5X25*	50	55820.050.025			
			M5X30*	50	55820.050.030	M8X15/16	10	55820.080.015
M4X10*	100	55820.040.010				M8X20	10	55820.080.020
M4X12*	100	55820.040.012	M6X10	25	55820.060.010	M8X25	10	55820.080.025
M4X16*	100	55820.040.016	M6X12*	50	55820.060.012	M8X30	10	55820.080.030
M4X20*	100	55820.040.020	M6X15/16	25	55820.060.015	M8X35*	50	55820.080.035
			M6X20	25	55820.060.020	M8X40	10	55820.080.040
M5X10	25	55820.050.010	M6X25	25	55820.060.025	M8X45*	50	55820.080.045
M5X12*	50	55820.050.012						

55820 Śruby skrzydełkowe niskie model amerykański								
d x L	☒	Kod artykułu	d x L	☒	Kod artykułu	d x L	☒	Kod artykułu
M8X50*	50	55820.080.050	M10X25	10	55820.100.025			
M8X55*	50	55820.080.055	M10X30	10	55820.100.030	M12X20*	25	55820.120.020
			M10X40	10	55820.100.040	M12X25*	25	55820.120.025
M10X20	10	55820.100.020	M10X45*	25	55820.100.045	M12X30*	25	55820.120.030

Śruby skrzydełkowe z okrągłymi skrzydełkami

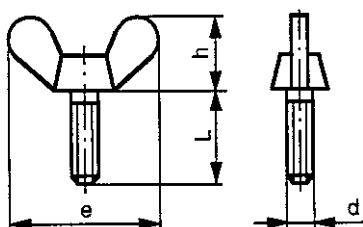

DIN 316
NEN 1624

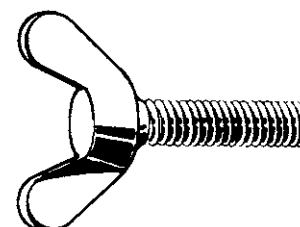

Informacje techniczne

d	e (maks.)	h (maks.)	P	d	e (maks.)	h (maks.)	P
M4	20	10.5	0.7	M10	51	25	1.5
M5	26	13	0.8	M12	65	33.5	1.75
M6	33	17	1	M16	73	37.5	2
M8	39	20	1.25				

Grupy katalogowe

Gwint	Gniazdo	Materiał	Obróbka powierzchni	Kod	Strona
M	Skrzydełko	CI	O cynk.	16210	6-209
M	Skrzydełko	St.St. A2		51812	6-209
M	Skrzydełko	Mosiądz		47530	6-210

6

16210 Śruby skrzydełkowe z okrągłymi skrzydełkami		F11G
Gwint	Metryczny	
Materiał	Żeliwo	
Obróbka powierzchni	O cynkowane	

d x L	☒	Kod artykułu	d x L	☒	Kod artykułu	d x L	☒	Kod artykułu
M4X10	200	16210.040.010	M6X30	100	16210.060.030	M10X60	20	16210.100.060
M4X16	200	16210.040.016	M6X40	100	16210.060.040	M10X70	20	16210.100.070
M4X20	200	16210.040.020	M6X50	100	16210.060.050	M10X80	20	16210.100.080
M4X25	200	16210.040.025						
M5X10	200	16210.050.010	M8X12	100	16210.080.012	M12X20	20	16210.120.020
M5X16	200	16210.050.016	M8X16	100	16210.080.016	M12X25	20	16210.120.025
M5X20	200	16210.050.020	M8X20	100	16210.080.020	M12X30	20	16210.120.030
M5X25	200	16210.050.025	M8X25	100	16210.080.025	M12X40	20	16210.120.040
M5X30	100	16210.050.030	M8X30	100	16210.080.030	M12X50	20	16210.120.050
M5X35	100	16210.050.035	M8X40	50	16210.080.040	M12X60	20	16210.120.060
M5X40	100	16210.050.040	M8X50	50	16210.080.050	M12X70	20	16210.120.070
M5X50	100	16210.050.050	M8X60	50	16210.080.060	M12X80	20	16210.120.080
M6X10	200	16210.060.010	M10X16	50	16210.100.016	M16X30	10	16210.160.030
M6X12	100	16210.060.012	M10X20	50	16210.100.020	M16X40	10	16210.160.040
M6X16	100	16210.060.016	M10X25	50	16210.100.025	M16X50	10	16210.160.050
M6X20	100	16210.060.020	M10X30	50	16210.100.030	M16X60	10	16210.160.060
M6X25	100	16210.060.025	M10X40	50	16210.100.040			
			M10X50	20	16210.100.050			

51812 Śruby skrzydełkowe z okrągłymi skrzydełkami		Q01A
Gwint	Metryczny	
Materiał	Stal nierdzewna A2	

d x L	☒	Kod artykułu	d x L	☒	Kod artykułu	d x L	☒	Kod artykułu
M6X25*	50	51812.060.025	M8X30*	25	51812.080.030	M10X30*	25	51812.100.030
M6X30*	50	51812.060.030				M10X50*	25	51812.100.050
			M10X25*	25	51812.100.025			

47530	Śruby skrzydełkowe z okrągłymi skrzydełkami		M11D
Gwint	Metryczny		
Materiał	Mosiądz		
			

d x L	☒	Kod artykułu	d x L	☒	Kod artykułu	d x L	☒	Kod artykułu
M5X12	100	47530.050.012	M6X25	100	47530.060.025	M8X30	25	47530.080.030
M5X16	100	47530.050.016	M6X30	100	47530.060.030	M8X40	25	47530.080.040
M5X20	100	47530.050.020	M6X40	100	47530.060.040	M8X50	25	47530.080.050
M5X25	100	47530.050.025						
M5X30	100	47530.050.030	M8X10	50	47530.080.010	M10X20	50	47530.100.020
			M8X12	50	47530.080.012	M10X25	50	47530.100.025
M6X10	100	47530.060.010	M8X16	50	47530.080.016	M10X30	25	47530.100.030
M6X12	100	47530.060.012	M8X20	50	47530.080.020	M10X40	25	47530.100.040
M6X16	100	47530.060.016	M8X25	50	47530.080.025	M10X50	25	47530.100.050
M6X20	100	47530.060.020						

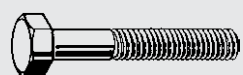

1 Śruby

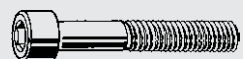

2 Produkty z gniazdem sześciokątnym



3 Nakrętki, nitonakrętki & wkładki



4 Pręty gwintowane & śruby dwustronne



5 Haki & śruby oczkowe



6 Wkręty

I Index



7 Podkładki & pierścienie uszczelniające typu “O-ring”



8 Kotwy, kołki, dyble



9 Nity, kołki & wpusty



10 Elementy łączące systemowe, meblowe & zabezpieczające



11 Zestawy

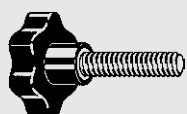

12 Części konstrukcyjne & części maszynowe

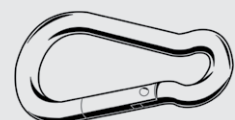

13 Przemysł morski

T Technologia łączenia

Index alfabetyczny

A				
ABA	do węży	opaska zaciskowa	12-7, 12-9/12-11, 12-18	
		mikro	12-16	
		mini	12-13	
		mocna	12-14	
		dwuoczkowy zacisk	12-17	
		elastyczny wkrętak do opasek	12-23	
		jednooczkowy zacisk	12-16	
		opaska zaciskowa mocna węża	12-15	
		wieszak na opaski asortyment zestaw	12-22	
		zacisk	12-21	
		z gumą	12-20	
	Akcesoria	mocujące akcesoria	MaxxFast	8-86
	Amecoil	do korpusu świec zapłonowych gwintownik	drobnozwojny	MF do wkładki gwintowej z drutu 3-144
		końcówka wylotowa	z trzpieniem metryczna	3-156/3-158
		maszynowy gwintownik	MF do wkładki gwintowej z drutu	3-144
		nadwymiarowy do wkładki gwintowej z drutu	3-143	
		UNC do wkładki gwintowej z drutu	3-145	
		UNF do wkładki gwintowej z drutu	3-145	
naprawczy zestaw			3-153	
		bardzo drobnozwojny	3-150, 3-151	
		BSW	3-152	
		metryczny	3-149	
	metryczny drobnozwojny	3-150		
	UNC	3-151		
	UNF	3-152		
transportowy łącznik			3-158	
trzcina	do odlamywania końcówek		3-159	
wielowymiarowe narzędzie montażowe	ręczne metryczne		3-154	
		metryczne kompletne	3-155, 3-156	
		metryczne z końcówką wylotową	3-155	
wkładka gwintowa z drutu	MEF		3-148	
	MEF do korpusów świec zapłonowych		3-148	
	metryczna		3-146	
	metryczna drobnozwojna		3-147	
	metryczna samozabezpieczająca		3-146	
	UNC		3-148	
	UNF		3-149	
	wyciągacz		3-159	
AMF	hakowy przegubowy zacisk		12-160	
		przegubowy pionowy zacisk	12-162	
		poziomy	12-161	
	pionowy przegubowy zacisk		12-152, 12-153	
	poziomy przegubowy zacisk		12-154/12-156	
	przeciwny przegubowy zacisk		12-157/12-159	
		przeciwzaczep do zacisków hakowych	12-163	
	Antywibracyjna podkładka GMT		12-70	
		Nord-Lock	7-98, 7-102, 7-103	
		sklejone 2 części	7-96/7-101	
	śruba GMT	12-71		
Antywi-bracyjne zamocowanie	metryczne		12-65/12-69	
Asortyment wieszak na opaski	MaxxFast		12-21	
	zestaw ABA		12-22	
Awab	do rur wydechowych	zacisk	12-24	
B				
Band-It	zacisków system		12-26/12-28	
Belka	zacisk Fischer		10-48	
Bez możliwości obrotu	rażka metryczna nieobrotowa		12-93	
Bez zaślepki	ustalająca podkładka	do wałków	7-131, 7-132	
Bezpieczeństwo	wkręt huślawko-gimnastyczny	metryczny	5-41	
		niemetryczny	5-40	
Blokada drzwi	zatrzask		13-127, 13-128	
Blokująca	podkładka sprężynowa		7-104, 7-105	
	talerzowa sprężyna		7-93, 7-94	
Boi	karabińczyk		13-16	
Bramkowy	hak		13-114	
BSF	sześciokątna nakrętka		3-28	
		z wkładką samozabezpieczającą	3-63	
		śruba	1-59	
BSP-R	stożkowa kulkowa ciśnieniowa smarownicza	niemetryczny	12-45	
BSW	dociskowy wkręt	wgłębiony koniec	z gniazdem sześciokątnym 2-90	
	gwintowany pręt		4-20	
	kolpakowa nakrętka	wysoka	3-99	
	naprawczy zestaw	Amecoil	3-152	
	skrzydełkowa nakrętka		3-106	
	śruby dwustronne		4-33	
	stożkowy leb śruba	z gniazdem sześciokątnym	2-50	
		z nacięciem prostym	6-27, 6-28	
	sześciokątna nakrętka		3-27, 3-28, 3-30	
		z wkładką samozabezpieczającą	3-63	
	śruba	1-58		
ucho do podnoszenia	śruba	5-9		
walcowy leb	śruba	z gniazdem sześciokątnym 2-32		
C				
Cardana	przegub	podwójny	12-49	
		pojedynczy	12-48	
Caterpillar	stopa ogniwa gęsienicy	śruba	1-87	
Ceownik	łącznik Fischer		10-49	

Ceownik	podkładka	Fischer		10-44
	szyna	Fischer		10-40
Chemiczna	kotwa	kapsuła	Fischer	8-82
			Spit	8-83
		wewnętrznie	Fischer	8-88
		gwintowana		
Chemicznie	pręt	Fischer		8-79
mocowany		MaxxFast		8-78
Chłodniczy	do przewódów rurowych	zacisk	Fischer	10-39
Chowana	rączka	metryczna	obrotowa	12-95
		ręczna	korba z gwintową tuleją	12-96
Chowana	pokrętko			12-109
rączka		dwuramienne		12-106
		pełne		12-108
	rączka	ręczna	korba	12-96
Ciągi	zacisk			10-60
kablowe				
Ciągly	zawias			13-105
Cylindryczna	nitonakrętka			3-128/3-130
Cylindryczne	nitonakrętka			3-129, 3-137
Czerpakowa	śruba	metryczna		1-82, 1-83
Części	zawlecza			3-177
zapasowe				
Czółenkowy	wpust			9-50, 9-51
Czołowy	zacisk	Lindapter		10-33
Czopem	dociskowy	metryczny		6-9
walcowym	wkręt			
D				
D	szekła			5-20, 5-21
Dachowe i	wkręty	z elastomerem	uszczelniającym	6-112
ścienne		SFS-Topform		6-111
		z końcem	SFS-Topform	6-112
		plaskim		
		z elastomeru	końcówką wiertła	6-115
Długi	trzonek	mocowanie	Fischer	8-31, 8-32
Do belki	klamra			10-57, 10-59
Do betonu	kotwa	Fischer		8-66/8-68
		MaxxFast		8-64, 8-65
	śruba	łeb	Powers	8-61
	kotwiąca	grzybkowy		
		łeb okrągły	Powers	8-61
		łeb stożkowy	Powers	8-62
		plaski		
		łeb	Powers	8-60
		sześciokątny		
	śruba ko-	łeb	Powers	8-60
	twiąca A4	sześciokątny		
	wkładka	Vemo		8-96, 8-97
		z płytką do	Vemo	8-96, 8-98
		wbijania		
		gwoździ		
Do bram	hak	niemetryczny	z 2 hakami oczkowymi	5-42
Do dachu i	wkręty	koniec	plaski	6-112
elewacji		koniec	stożkowy	6-113
Do el. pod-	kotwa	Fischer		8-54
wieszanych				
Do elewacji	śruba z	koniec	plaski	6-113
	podkładką	koniec	stożkowy	6-113
	śruby			6-114

			z podki	6-114
			wkręt gwint żebrowany	6-115
Do	Fischer			8-21, 8-22
gazobetonu				
	kotwa	Fischer		8-20
Do gniazdka	ślizgowa	oprawka		10-83
Do haka	uchwyt			13-128
Do kabli	zaciskowa	opaska	samoprzylepny	12-132, 12-133
			z pod- możliwością	12-127
			stawą do luzowania	
			mocowania	
			zestaw	12-123
	zaciskowa	opaska		12-121
	opaska			
		MaxxFast		12-120/12-122
		mocowanie		12-129
		MaxxFast		12-128
		Ty-Rap		12-122, 12-123
Do kołka	nakrętka	z gniazdem	sześciokątnym	10-93
ustalającego				
Do	podkładki	okrągłe		7-43
konstrukcji				
drewnianych				
			do konstrukcji drewnianych	7-43
Do konstruk-	mocowanie	Lindapter		10-21/10-24
cji stalowych				
Do korpusu	gwintownik	drobnoz-	MF do Amecoil	3-144
świec	zapłonowych	wojny	wkładki	
			gwintowej z	
			dru	
Do lin	kausza			13-57, 13-58
	przeplot			13-125
	ucinaki			13-56
	zacisk			13-35, 13-59
Do mocowa-	zacisk	Lindapter		10-31
nia poręczy				
Do nakrętek	śruba	metryczna	do rowków teowych	10-12
teowych	dwustronna			
Do	nitownica	ręczna		3-140
nitonakrętek				
	nitownica	w walizce		3-141
	ręczna			
Do nitowania	sprężysta	plytka		10-82
Do odla-	trzępię	Amecoil		3-159
mywania				
końcówek				
Do okien	wkręt z	kolor biały		6-104/6-106
	podkładką			
		kolor brązowy		6-104/6-106
		kolor naturalny		6-104/6-106
Do opasek	elastyczny	wkrętak	ABA	12-23
			MaxxFast	12-23
	narzędzie	MaxxFast		12-129
	ręczne			
Do	śruba	metryczna		10-105
oprawiania				
Do	narzędzie	Fischer		8-53
osadzania				
		MaxxFast		8-53
Do płyt	wkręt	z gniazdem	krzyżowym	6-198
gipsowo-kar-				
tonowych				
Do płyt g-k	kołek	Fischer		8-19
		MaxxFast		8-17
Do	chłodniczy	zacisk	Fischer	10-39
przewódów				
rurowych				

E

Elastyczna	podpora do maszyn		12-72
Elastyczny	wkrętak	do opasek ABA	12-23
		MaxxFast	12-23
Element	dystansowy		12-135, 12-148
	podpórka	Lindapter	10-25/10-27
F			
Falista	podatna podkładka		7-62
FESTAPLAN	uszczelniający	pierścienie	7-149, 7-150
Fibrowa	plaska	podkładka do aut	7-151
Fibrowa	uszczelniająca	podkładka	7-150
Fischer	belka	zacisk	10-48
	ceownik	łącznik	10-49
		podkładka	10-44
		szyna	10-40
	chemiczna	kotwa	8-82
		kapsuła	8-88
		wewnętrznie gwintowana	8-88
	chemicznie mocowany	pręt	8-79
	chłodniczy	do przewodów rurowych	10-39
		do zacisk	10-39
	długi	trzonek	8-31, 8-32
		mocowanie	8-31, 8-32
	do betonu	kotwa	8-66/8-68
	do el. podwieszanych	kotwa	8-54
	do gazobetonu		8-21, 8-22
		kotwa	8-20
	do ram	mocowanie	8-34/8-37
	instalacyjne	narzędzie	8-23, 8-76, 8-81
	instalacyjny	kątowy	10-45
		wspornik	10-46
	kątowy	wspornik	10-46
	kolek	do płyt g-k	8-19
		uniwersalny	8-13
	kolek do ścian		8-7, 8-9, 8-11
	kotwa		8-47
		rozporowa	8-46
		metryczna z mosiężnym stożkiem	8-46
	mocowania	uchylne	8-25
	mocowanie	regulowane	8-41
	narzędzie	do osadzania	8-53
	nasadka	do śrub	8-39
		do śruby mocującej ościeżnicy okiennej	8-39
	obejma		10-47
		siodłowa	10-36
	okienna	ościeżnica	8-39
		wkręt	8-39
	perforowana stalowa	opaska	10-52
	podwójny	łącznik	10-53, 10-54
	prostokątną	zaślepka	10-42
	przesuwna	nakrętka	10-43
	regulowana	śruba	8-40
	równoległy	łącznik	10-50
	rurowy	zacisk	10-38
	śruba	kotwa	8-72
	śrubowa	kotwa	8-75
	śrubowy	łącznik	10-54
	T-kształny	śruba	10-42, 10-45
	łeb		
	transportowa skrzynia		11-27
	tuleja	gwoździowa	8-26
	tulejkowa	kotwa	8-87
	tulejowa	kotwa	8-48

uniwersalny	kolek	uniwersalny	8-14
wbijana	kotwa		8-52
wbijany	kolek		8-28, 8-29
		z podkładką izolacyjną	8-30
wnękowe	mocowanie		8-15
		narzędzie	8-16
wspornik	ramię		10-41
wtryskowe	narzędzie		8-85
wysokiej wytrzymałości	kotwa	metryczna	8-73, 8-75
zacisk	wspornik		10-51
zawiasowy	rurowy	zacisk	10-37
zestaw	kaseta	kołki do ścian	8-8
żywiczna	masa		8-84
Floorfast	Lindapter		10-34
Flush Fit	Hollo-bolt	Lindapter	10-20
Fundamentowa	śruba	metryczna	8-89, 8-90
G			
Głęboka	podkładka	Lindapter	10-28
Główna klamra			10-60
GMT	podkładka	antywibracyjna	12-70
	śruba	antywibracyjna	12-71
	wbijana	zaślepka kwadratowa	12-69
Kratownice	zacisk	Lindapter	10-35
Grzybkowy łeb	nakrętka	metryczny z gniazdem sześciokątnym	10-95
	nit zrywalny		9-64/9-66, 9-70, 9-71, 9-73/9-75
		powiększony szerokokresowy	9-61, 9-71
		rozprężny	9-77
	śruba	M z gniazdem sześciokątnym	2-54, 2-55, 10-113
		metryczna	1-72, 1-73, 1-75
		metryczna z gniazdem sześciokątnym	10-96
		metryczna z sześciokątną nakrętką	1-76
		metryczna ze szpilką	10-111
	metryczne	samogwintu- REMFORM®	6-71
	krzyżowe	jące	
	gniazdo		
	metryczne z krótkim podsadzeniem		1-80
	metryczne z z podsadzeniem sześciokątną nakrętką		1-82
	UNC		1-77/1-79
		z gniazdem sześciokątnym	2-57
	UNF	z gniazdem sześciokątnym	2-58, 2-59
	śruba samo-gwintująca	z trójskrzydłowym wgłębieniem	10-123
	śruba z kołnierzem	M z gniazdem sześciokątnym	2-62
	wkręt	gniazdo SR samowierzący	6-140
		metryczny z nacięciem prostym	6-32, 6-33
		metryczny z wgłębieniem krzyżowym	6-55, 6-56
		metryczny z zaślepką	10-112
		samonacinające	10-118, 10-119
	wkręt samo-gwintujący	metryczny z gniazdem krzyżowym	6-103
Gumowa	nitonakrętka Rawlnut	z mosiężną tuleją gwintową	8-49
Gumowe	o-ringi		7-158
Gwiazdowy	rekojęść	metryczna	12-78, 12-79

Index alfabetyczny

Gwint calowy Whitworth'a, drobnozwojny	sześciokątna śruba		1-61
Gwint calowy Whitworth'a, zwykły	sześciokątna śruba		1-60
Gwint calowy, zunifikowany, drobnozwojny	stożkowa kulkowa ciśnieniowa smarownicza		12-46
Gwint równoległy G	sześciokątna nakrętka		3-41
Gwint rurowy	z gniazdem korek z walcowym kołnierzem		2-95
Gwint rurowy Whitwortha, walcowy	kulisty łeb kulkowa ciśnieniowa smarownicza		12-46
Gwint rurowy zewnętrzny, stożkowy	z gniazdem korek z gniazdem sześciokątnym		2-93
	z łbem 6-kątnym korek		2-98
		z walcowym kołnierzem	2-97, 2-98
Gwint trapezowy	gwintowany pręt		4-24, 4-25
		lewy gwint	4-24
	okrągła nakrętka		4-25
		lewy gwint	4-26
Gwintowa wkładka	Jacknut		3-121
	samonacinająca		3-172/3-174
		z gniazdem sześciokątnym	3-174, 3-175
Gwintowa wkładka	narzędzie		3-176/3-178
Gwintowa z drutu	wkładka MEF Amecoil		3-148
	MEF do korpusów świec zapłonowych Amecoil		3-146
	metryczna Amecoil		3-147
	metryczna Amecoil drobnozwojna		3-146
	metryczna Amecoil samozabezpieczająca		3-148
	UNC Amecoil		3-149
	UNF Amecoil		3-149
Gwintowana wkładka	z gniazdem sześciokątnym		10-90, 10-91
	z nacięciem prostym		10-91
Gwintowany pręt	BSW		4-20
	gwint trapezowy		4-24, 4-25
		lewy gwint	4-24
	ISO metryczne		4-5, 4-7
	metryczny		4-3/4-12
		lewy gwint	4-5, 4-6, 4-8, 4-9
		Permaglas	4-21
	metryczny ASTM A193		4-38
	metryczny drobnozwojny		4-13
	metryczny nadwymiarowy		4-7, 4-10, 4-11
		nadwymiarowy	4-5
	UNC		4-15/4-17

		ASTM A193		4-35
		UNF		4-18, 4-19
Gwintowany pręt	do szalowania			8-93
Gwintownik	do korpusu świec zapłonowych	drobnozwojny	MF do wkładki gwintowej z drutu	Amecoil 3-144
	maszynowy	MF do wkładki gwintowej z drutu	Amecoil	3-144
		nadwymiarowy	do wkładki gwintowej z drutu	Amecoil 3-143
		UNC	do wkładki gwintowej z drutu	Amecoil 3-145
		UNF	do wkładki gwintowej z drutu	Amecoil 3-145
Gwoździowa tuleja	Fischer			8-26
H				
Hak	bramkowy			13-114
	do bram	niemetryczny z 2 hakami oczkowymi		5-42
	do zaslon			13-121
	na płaszczce			13-115/13-117
	obrotowy			13-3
	oczkowy	metryczny		5-28
		niemetryczny		5-30/5-32
	pelikan			13-51, 13-52
	prosty hak	niemetryczny		5-34
			z łbem z wgłębieniem krzyżowym	5-35
	prosty, otwarty			13-120
	sufitowy	metryczny		5-29
		niemetryczny		5-32, 5-33
	w kształcie litery S			5-42
	wkręcany			13-118
	zatrząsk			5-26
	zatrząskowy			13-31
Hak elastyczny	wielozwojowy			13-123
Hak poślizgowy	z pierścieniem			13-38
Hak S-kształtny				13-119
Hak z gwintem				13-124
Hak zatrząskowy	z krętlikiem			13-23, 13-24
Hakowa kotwa	metryczna z hakiem o długości 100 mm			8-91, 8-92
	metryczna z hakiem o długości 50 mm			8-91
Hakowy przegubowy zacisk	przegubowy pionowy	AMF		12-160
	przegubowy poziomy	AMF		12-162
			AMF	12-161
Heco-Fix	stożkowy łeb wkręty do płyt wiórowych		z gniazdem krzyżowym	6-155
	stożkowy soczewkowy do płyt łeb wiórowych		z gniazdem krzyżowym	6-172
	walcowy soczewkowy do płyt łeb wiórowych		z gniazdem krzyżowym	6-169

Heco-Topix	stożkowy	wkręty do płyt wiórowych	z gniazdem sześciokarbowym	6-160, 6-162
	stożkowy	wkręt do drewna	z gniazdem sześciokarbowym	6-164
		wkręty do płyt wiórowych	z gniazdem krzyżowym	6-157
Heco-Unix Plus	stożkowy	wkręty do płyt wiórowych	z gniazdem krzyżowym	6-157
Heco-Unix Top	stożkowy	wkręty do płyt wiórowych	z gniazdem sześciokarbowym	6-160
High slip resistance	zacisk	Lindapter		10-24
Hole	stożkowy	wkręty do płyt wiórowych	z gniazdem krzyżowym	6-158
Hollo-bolt	Flush Fit	Lindapter		10-20
	leb stożkowy	Lindapter płaski		10-19
		sześciokątna Lindapter		10-17, 10-18
I				
Instalacyjne	narzędzie	Fischer		8-23, 8-76, 8-81
		Spit		8-54
Instalacyjny	kątowy	wspornik	Fischer	10-45
Izolacyjna	rukawa			12-148
	tulejka			12-146, 12-147
J				
Jacknut	wkładka	gwintowa		3-121
Jednooczkowy	zacisk	ABA		12-16
Jednostronnie zamknięty	rozprężny	nit	z zaślepką	9-67
Jednostronny	wkręt zabezpieczający	zabezpieczający	self-drilling	10-122
		Łeb stożkowy		10-122
K				
Kablowy	uchwyt			12-134
Kalei	wciskana	nakrętka	metryczna	3-94, 3-95
Kapsuła	chemiczna	kotwa	Fischer	8-82
			Spit	8-83
Karabińczyk				13-14, 13-15, 13-17, 13-19/13-23, 13-32/13-34
	boi			13-16
	podwójna blokada			13-25
	zakręcany			13-137
Karbowany kolek	kulisty	leb	pin	9-21, 9-22
	środkowa część	pin		9-20
	walcowy	pin		9-17, 9-18
			z prowadzeniem	9-13
	zbieżny	kolek		9-16
		pin		9-14, 9-15, 9-19
Kaseta	zestaw	kolki do ścian	Fischer	8-8
Kaseta typ S	zestaw	w kasetach stalowych		11-24
Kątowy	instalacyjny	wspornik	Fischer	10-45
		wspornik	Fischer	10-46
Kausza				5-27
	do lin			13-57, 13-58
Klamra	do belki			10-57, 10-59

Klamra do belek	połączenie			10-57, 10-58
	uniwersalna	uniwersalne		10-56
Klinowa	kotwa	Spit		8-69
	kwadratowa	podkładka	do ceownika	7-145, 7-146
			Peiner	1-93
			do dwuteownika	7-143, 7-144
			Peiner	1-93
Klucz dopasowany	Quick system			10-73
Kolek	do płyt g-k	Fischer		8-19
		MaxxFast		8-17
	rozporowy			8-43
	stożkowy			9-4
			z gwintem wewnętrznym	9-11
			z gwintem zewnętrznym	9-10
	uniwersalny	Fischer		8-13
		uniwersalne	Fischer	8-14
	walcowy			9-6, 9-7, 9-9, 9-10
			z gwintem wewnętrznym	9-12
	wbijany	Fischer		8-28, 8-29
		z podkładką izolacyjną	Fischer	8-30
	zbieżny	karbowany kolek		9-16
Kolek do ścian				8-5
	Fischer			8-7, 8-9, 8-11
	MaxxFast			8-4, 8-10, 8-12, 8-27
Kolki	rozporowe	MaxxFast		8-42
Kolki do ścian	zestaw	kaseta	Fischer	8-8
Kołnierz stożkowy	nitonakrętka			3-131/3-133, 3-138
Kołnierz walcowy	nitośruba			3-139
Kołnierzowa nakrętka	sześciokątna UNC	self-drilling		3-80
		z kołnierzem		3-79
		z wkładką niemetaliczną	self-drilling	3-81
		zębowana		3-78, 3-79, 3-82
Kołnierzowy	łeb	wkręt do drewna	MaxxFast	6-177
			do drewna	6-177
Kołnierzowy pierścień	zębowany	Dubo		7-112
Koło/kołpak	sześciokątna nakrętka	z kołnierzem Nord-Lock		3-83
Kołpak	ozdobny			12-39
Kołpakowa nakrętka	BSW	wysoka		3-99
Kołpakowa nakrętka	sześciokątna z wkładką niemetaliczną	self-drilling		3-102, 3-103
Kombi	śruba	metryczna z nacięciem prostym		6-35
Kompensatory	tolerancja			10-86
Końcówka	do ściągaczy linowych			13-71/13-74
		z łbem		13-75
	do zawalcowania			13-45, 13-46
	ściągacza linowego			13-50
	skręcana oczkowa			13-53, 13-54
	widełkowa	do zawalcowania		13-48, 13-49
Końcówka pręta	okrągła	z gwintem zewnętrznym		12-52
		lewy gwint		12-52
Końcówka wylotowa	z trzpieniem	metryczna	Amecoil	3-156/3-158
Konfirmat	wkręt	z gniazdem sześciokątnym		10-97

Index alfabetyczny

Konstrukcyj- na o dużej wytrzyma- łości	śruba	metryczna	Peiner	1-90
Kontaktowa	podatna	podkładka		7-82
	podkładka			7-107, 7-108
Korek	do rur	Vemo		8-99
	ochronna	zaślepka		12-151
	plastikowy			12-150
	z gniazdem	drobnozwojny z gniazdem sześciokątnym		2-92, 2-94
		gwint rurowy z walcowym kołnierzem		2-95
		gwint rurowy z gniazdem zewnętrznym, sześciokątnym stożkowy		2-93
	z łbem 6-kątnym	drobnozwojny z walcowym kołnierzem		2-96
		gwint rurowy zewnętrzny, stożkowy z walcowym kołnierzem		2-98
				2-97, 2-98
	zaślepiający			12-116
Koronowa	nakrętka	metryczna		3-86, 3-87
		niska		3-89
		metryczna drobnozwojna		3-88, 3-90
		niska		3-91
		UNF		3-92
Koszykowa	nakrętka	metryczna		3-119
Kotwa	chemiczna	kapsuła	Fischer Spit	8-82 8-83
		wewnętrznie gwintowana	Fischer	8-88
	do betonu	Fischer		8-66/8-68
		MaxxFast		8-64, 8-65
	do el. podwieszanych	Fischer		8-54
	do gazobetonu	Fischer		8-20
	Fischer			8-47
	hakowa	metryczna z hakiem o długości 100 mm		8-91, 8-92
		metryczna z hakiem o długości 50 mm		8-91
	klinowa	Spit		8-69
	pręt	metryczny		8-80
	rozporowa	metryczna z Fischer mosiężnym stożkiem		8-46
		metryczna z nakrętką		8-44
		Rawplug		8-43, 8-45, 8-46
	samowiercąca	do płyt gipsowo-kartonowych		8-18
	śruba	Fischer		8-72
	śrubowa	Fischer		8-75
		łeb okrągły Powers		8-56
		łeb stożkowy Powers płaski		8-55, 8-58
		łeb z nacięciem sześciokątny prostym	Powers	8-57
	tulejkowa	akcesoria	Fischer	8-87
	tulejowa	Fischer		8-48
	wbijana	Fischer		8-52
		MaxxFast		8-50, 8-51
		Spit		8-25
	wysokiej wytrzymałości	metryczna	Fischer	8-73, 8-75
			MaxxFast	8-70
Kotwa gwintowana	pręt	Spit		8-81
Krętlikowa	szekła			13-29, 13-30
Kryty	zawias			13-104, 13-105
Książkowa	nakrętka			10-102
	śruba			10-103, 10-104
Kula	techniczna			12-111/12-114
Kula masywna	z gwintem wewnętrznym			13-78, 13-79
Kulista	podkładka			10-9, 10-10
Kulisty łeb	karbowany kolek			9-21, 9-22
	kulkowa	gwint rurowy Whitwortha, walcowy ciśnieniowa smarownicza		12-46
		metryczne drobnozwojnym		12-44
	nit			9-31/9-33
	śruba	metryczna z gniazdem sześciokątnym		2-52, 2-53
		metryczny z nacięciem prostym		6-31, 6-32
	śruba do drewna	przewodzenie z kwadratowym gniazdem		10-127, 10-128
	śruba z kołnierzem walcowym	metryczna z gniazdem sześciokątnym		2-60, 2-61
	wkręt do drewna	z gniazdem krzyżowym		6-189, 6-190
		z nacięciem prostym		6-183, 6-184
Kulkowa ciśnieniowa smarownicza	kulisty łeb	gwint rurowy Whitwortha, walcowy		12-46
		metryczne drobnozwojnym		12-44
	stożkowa	BSP-R niemetryczny		12-45
		gwint calowy, zunifikowany, drobnozwojny		12-46
		MEF		12-45
		metryczna		12-42
		metryczna drobnozwojna		12-44
	wbijana	metryczna		12-43
	wkleśła	metryczna		12-43
Kulowy	przegub	M/MF z gwintem wewnętrznym lewym		12-47, 12-48
		M/MF z gwintem wewnętrznym prawym		12-47
	rękojeść	metryczna		12-76, 12-77
	uchwyt	metryczna z otworem stożkowym		12-77
Kulowy sworzeń	sworzeń			10-77
Kwadratowa klinowa	podkładka	do ceownika		7-145, 7-146
		Peiner		1-93
		do dwuteownika		7-143, 7-144
		Peiner		1-93
	nakrętka	metryczna		3-117, 3-118
		niska		3-116, 3-117
	podkładka			7-142, 7-143
Kwadratowa do zgrzewania	nakrętka	metryczna		3-112
Kwadratowe rurowa	zaślepka			10-106
	stopa ogniwa	nakrętka UNF		3-42
	gesienicy			
Kwadratowy łeb	śruba	metryczna ze czopem krótkim		1-84
	sworzeń	UNC ze czopem krótkim		1-85
Kwadratowym gniazdem	walcowy łeb z kwadratowym gniazdem	z kwadratowym gniazdem	MaxxFast	6-128
Łącząca nakrętka	okrągła	metryczna		3-124, 3-125

Łącząca tulejka	łącznik	Vemo		8-95
Łącznik	ceownik	Fischer		10-49
	łącząca tulejka	Vemo		8-95
	podwójny	talerzowy	Fischer	10-53, 10-54
	równoległy	Fischer		10-50
	śrubowy	Fischer		10-54
	transportowy	Amecoil		3-158
	wielokrotny			12-52
Łańcuch				13-136
Łeb grzybkowy	śruba kotwiąca	do betonu	Powers	8-61
Łeb kulisty	nitowkręt			9-22
Łeb młoteczkowy	śruba	z podsadzeniem kwadratowym		5-2, 5-3
Łeb okrągły	śruba kotwiąca	do betonu	Powers	8-61
	śrubowa	kotwa	Powers	8-56
Łeb pomniejszony	stożkowy łeb wkręty do płyt wiórowych	z gniazdem krzyżowym		6-159
Łeb stożkowy	jednostronny wkręt zabezpieczający	zabezpieczający	samonacinający	10-122
	wkręt	metryczny	do tworzyw	6-72
Łeb stożkowy płaski	Hollo-bolt	Lindapter		10-19
	śruba kotwiąca	metryczna	samogwintująca z gniazdem sześciokarbowym	6-68
		metryczny	z wgłębieniem krzyżowym	6-93
		z łbem stożkowym	samogwintująca	6-68
	śruba kotwiąca	do betonu	Powers	8-62
	śrubowa	kotwa	Powers	8-55, 8-58
	ttap®	wkręt	z gniazdem krzyżowym samowiercą	6-134, 6-135, 6-141
	wkręt	metryczna		10-115/10-117
		metryczny		6-50
		metryczny	z gniazdem sześciokarbowym	6-49
		samonacinające		10-123, 10-124, 10-126
		wgłębienie krzyżowe	samowiercą MaxxFast	6-131
	wkręt do drewna	z gniazdem krzyżowym		6-188/6-190
	wkręty do drewna	z gniazdem sześciokarbowym		6-178, 6-179
Łeb stożkowy ścięty	wkręt do drewna	z gniazdem krzyżowym		6-193, 6-194
		z gniazdem sześciokarbowym		6-195/6-197
Łeb sześciokątny	śruba kotwiąca	do betonu	Powers	8-60
	śruba kotwiąca A4	do betonu	Powers	8-60
	śrubowa	kotwa	z nacięciem prostym Powers	8-57
Łeb w kształcie T	śruba	metryczna		5-3
Lekki	osadczy	pierścień		7-137
Lewy gwint	gwintowany	pręt	gwint trapezowy	4-24
			metryczny	4-5, 4-6, 4-8, 4-9
	okrągła	końcówka pręta	z gwintem zewnętrznym	12-52
		nakrętka	gwint trapezowy	4-26

				plaska	z gwintem wewnętrznym		12-51
				sześciokątna nakrętka	metryczna		3-6, 3-7, 3-11, 3-12
				widelkowy przegub	z kolkiem sprężynującym		12-50
Możliwość podnoszenia dźwignia	zaciśkowa	metryczna					12-99, 12-100
				umożliwiająca podnoszenie			12-101, 12-102
					z gwintową końcówką		12-102
				podnośnik denny			13-112, 13-113
Lina				zabezpieczająca			13-66
Lindapter	czołowy	zaciśk					10-33
	do konstrukcji stalowych	mocowanie					10-21/10-24
	do mocowania poręczy	zaciśk					10-31
	Floorfast						10-34
	głęboka	podkładka					10-28
	Hollo-bolt	Flush Fit					10-20
		leb stożkowy płaski					10-19
		sześciokątna					10-17, 10-18
	podpórka	element					10-25/10-27
	regulowany	zaciśk z końcówką					10-30
	samoregulacyjny	zaciśk					10-29
	stopa belki	zaciśk					10-32
				ze śrubą dociskową i nakrętką			10-32
	zaciśk	grating					10-35
		high slip resistance					10-24
		wysokie tarcie					10-28
Lock washer	sprężysta	jednozwojowa podkładka					7-58
				z kwadratowymi końcami			7-50/7-52, 7-57, 7-58
Łożysko		ślizgowe					12-146
Łukowa		podatna podkładka					7-63/7-65
M							
Masa	żywiczna	Fischer					8-84
		MaxxFast					8-83, 8-84
Maszynowo nacinana	nakrętka	UNC					3-23
		UNF					3-26
Maszynowy gwintownik	MF do wkładki gwintowej z drutu	Amecoil					3-144
	nadwymiarowy	do wkładki gwintowej z drutu	Amecoil				3-143
	UNC	do wkładki gwintowej z drutu	Amecoil				3-145
	UNF	do wkładki gwintowej z drutu	Amecoil				3-145
MaxxFast	chemicznie mocowany	pręt					8-78
	do betonu	kotwa					8-64, 8-65
	do ram	mocowanie					8-32, 8-33
	do węży	opaska zaciskowa					12-6, 12-8, 12-10
		mini					12-12
	elastyczny	wkręta			do opasek		12-23
	kolek	do płyt g-k					8-17
	kolek do ścian						8-4, 8-10, 8-12, 8-27
	kolki	rozporowe					8-42
	kolnierzowy łeb	ttap®			wkręt do drewna		6-177
					timber		6-177
	łeb stożkowy płaski	ttap®			wkręt z gniazdem krzyżowym		6-134, 6-135, 6-141

Index alfabetyczny

MaxxFast	łeb stożkowy płaski	wkręt	wgłębienie krzyżowe	samowiercący	6-131
	mocujące	akcesoria			8-86
	narzędzie	do osadzania			8-53
	narzędzie ręczne	do opasek			12-129
	okienna	ościeżnica	wkręt		8-38
	stożkowy płaski łeb	ttap@	wkręt		6-151, 6-152, 6-164, 6-176
		wkręt do drewna	wgłębienie krzyżowe		6-149, 6-150
	sześciokątna śruba		samowiercący		6-135, 6-136
	walcowy łeb	kwadratowym gniazdem	z kwadratowym gniazdem	samowiercący	6-128
		ttap@	wkręt	samowiercący	6-126, 6-127
		wkręt	wgłębienie krzyżowe	samowiercący	6-119, 6-120
	walcowy soczewkowy łeb	ttap@	woodscrew		6-167, 6-168
		wkręt do drewna	wgłębienie krzyżowe		6-166
	wbijana	kotwa			8-50, 8-51
	wieszak	na opaski	asortyment		12-21
	wnętkowe	mocowanie			8-14
			narzędzie		8-16
	wtryskowe	narzędzie			8-85
	wysokiej wytrzymałości	kotwa	metryczna		8-70
	zacisk	z gumą			12-19
	zaciskowa opaska	do kabli	opaska		12-120/12-122
				mocowanie	12-128
		z możliwością luzowania	możliwość luzowania		12-126
	zestawy	w kasetach stalowych			11-23
	żywiczna	masa			8-83, 8-84
Metrowy prostokątny	wpust				9-49
Mikro	do węży	opaska zaciskowa	ABA		12-16
Mini	do węży	opaska zaciskowa	ABA		12-13
			MaxxFast		12-12
Mini kołnierz stożkowy	nitonakrętka				3-134, 3-135
		trzonek sześciokątny			3-135, 3-136
Mocna	do węży	opaska zaciskowa	ABA		12-14
		opaska	zaciskowa węża	ABA	12-15
Mocowania	uchylne	Fischer			8-25
Mocowanie	długi	trzonek	Fischer		8-31, 8-32
	do konstrukcji stalowych	Lindapter			10-21/10-24
	do ram	Fischer			8-34/8-37
		MaxxFast			8-32, 8-33
	regulowane				13-50, 13-51
		Fischer			8-41
	wnętkowe	Fischer			8-15
		MaxxFast			8-14
		narzędzie	Fischer		8-16

				MaxxFast	8-16
	zaciskowa opaska	do kabli	opaska		12-129
				MaxxFast	12-128
Mocujące	akcesoria			MaxxFast	8-86
Mostkowa	rączka				12-90, 12-91
				metryczna	12-91
				metryczna z mosiężną tuleją gwintową	12-90
Możliwość luzowania	zaciskowa opaska	do kabli	opaska	z podstawą do mocowania	12-127
				MaxxFast	12-126
Mudwing	okrągła powiększona	podkładka			7-44, 7-45
N					
Na opaski	wieszak	asortyment		MaxxFast	12-21
				zestaw ABA	12-22
Na płaszcz	hak				13-115/13-117
Naciągowa/rozciągowa	spiralna	sprężyna		z angielskim uchem	12-75
Naciskowa	spiralna	sprężyna			12-74
Nadwymiarowy	gwintowany pręt			metryczny nadwymiarowy	4-5
	maszynowy gwintownik		do wkładki gwintowej z drutu	Amecoil	3-143
Nakrętka	do kołka ustalającego		z gniazdem sześciokątnym		10-93
	do rowków teowych				10-5
	do szalowania				8-93
	do układów wydechowych				3-43
				samozabezpieczająca	3-42
	do zgrzewania			metryczna z kołnierzem gładkim	3-110
	dystansowa	2x wewnętrzny gwint			3-47
		gwint wewn. i zewn.			3-46
	grzybkowy łeb			metryczny z gniazdem sześciokątnym	10-95
	kołpakowa	BSW		wysoka	3-99
	koronowa	metryczna			3-86, 3-87
				niska	3-89
				metryczna drobnozwojna	3-88, 3-90
				niska	3-91
				UNF	3-92
	koszykowa			metryczna	3-119
	książkowa				10-102
	kwadratowa			metryczna	3-117, 3-118
				niska	3-116, 3-117
	kwadratowa do zgrzewania			metryczna	3-112
	maszynowo nacinana			UNC	3-23
				UNF	3-26
	metryczna				10-109
	okrągła			do kluczy do nakrętek okrągłych z wcięciami	3-123
				gwint trapezowy	4-25
				lewy gwint	4-26
				metryczna z nacięciem prostym	3-123, 3-124
				trapezowa	4-26
				z wkładką samozabezpieczającą niemetaliczną	3-126

Nakrętka	ostro metryczna	3-118
	zakończona	
	przedłużana metryczna	10-8
	przesuwana Fischer	10-43
	punktowe metryczna zgrzewanie	3-111
	radelkowana metryczna	3-115, 10-93
	niska	3-114, 3-115
	wysoka	3-113
	ściągnaczka for turnbuckle linowego	13-77
	skrzydełkowa BSW	3-106
	metryczna	3-108
	metryczna typ amerykański niski	3-103, 3-104
	metryczna z gwintową tuleją	12-88
	zaokrąglone skrzydełko	3-104, 3-105
	skrzydełkowa z kołnierzem walcowym	3-108
	stopa ognia gęśnicy	
	UNF kwadratowe	3-42
	niska	3-42
	wysoka	3-41
	stożkowa metryczna z nacięciem prostym	3-126
	sześciokątna	3-83
	BSF	3-28
	z wkładką samozabezpieczającą	3-63
	BSW	3-27, 3-28, 3-30
	z wkładką samozabezpieczającą	3-63
	drobnozwojna stalowa samozabezpieczająca	3-67
	drobnozwojna z wkładką niemetaliczną samozabezpieczająca	3-39, 3-52, 3-53
	gwint równoległy G	3-41
	izometryczna	3-8, 3-17/3-20, 3-44
	niska	3-33, 3-39
	koło/kołpak z kołnierzem Nord-Lock	3-83
	metryczna	3-6/3-14, 3-29/3-31, 3-38, 3-43/3-46, 4-63, 10-6, 10-7
	lewý gwint	3-6, 3-7, 3-11, 3-12
	niska	3-32/3-34
	Peiner	1-91
	samozabezpieczająca	3-65, 3-75, 3-76
	metryczna samozabezpieczająca aluminiowa	3-72
	metryczna do śrub dwustronnych	4-62
	metryczna do zbiorników ciśnieniowych	3-19
	metryczna drobnozwojna	3-15, 3-16, 3-53
	niska	3-35/3-37
	metryczna niska lewy gwint	3-33, 3-34
	metryczna nadwymiarowa	3-8, 3-9, 3-44
	niska	3-33
	metryczna stalowa samozabezpieczająca	3-66, 3-73
	Securit	3-75
	Snep	3-71, 3-72
	Stover	3-66
	metryczna stalowa nierdzewna samozabezpieczająca	3-64

	Snep	3-71
	metryczny ASTM A194 Gr. 2H	4-59
	MF lewy gwint	3-15, 3-16
	niska	3-36, 3-37
	Pal metryczna samozabezpieczająca	3-85
	UNC	3-21, 3-22, 3-57
	ASTM A194	4-57/4-59
	stalowa samozabezpieczająca	3-68, 3-69
	z wkładką samozabezpieczającą niemetaliczną	3-55/3-57, 3-59/3-61
	UNF	3-24, 3-25, 3-58
	stalowa samozabezpieczająca	3-70
	z wkładką samozabezpieczającą niemetaliczną	3-58, 3-59, 3-61, 3-62
	z kołnierzem	3-77
	samozabezpieczająca Ripp	3-74
	z wkładką samozabezpieczającą niemetaliczną	3-49/3-51, 3-54
	z ząbkowaną podkładką zabezpieczającą przed wypadnięciem po rozłączeniu	3-84
	sześciokątna do zgrzewania	3-109
	sześciokątny metryczny Permaglas	4-22
	szybkiego montażu	3-120
	tulejowa metryczna	10-101
	walcowy płaski łeb z gniazdem sześciokątnym	10-94
	wbijana metryczna do drewna	10-90
	wciskana metryczna Kalei	3-94, 3-95
	wygięta	3-107
	wypukła metryczna niska	3-101, 3-102
	wysoka	3-97/3-99
	z przyspawaną zaślepką	3-100
	z uchem	3-107
	metryczna	5-11, 5-12
	metryczna z oznaczeniem CE	5-11
	zrywalna metryczna	10-110
	Nakrętka okrągła metryczna	3-96
	wciskana	
	Nakrętka z sześciokątną metryczną kołnierzem walcowym	10-7, 10-8
	Napinająca dźwignia umożliwiająca podnoszenie z gwintową końcówką	12-98, 12-99
	Napinająca metryczna nakrętka	5-15
	metryczna rurowe	5-13
	metryczna sześciokątna	5-13
	metryczna z 2 hakami	5-18
	metryczna z 2 śrubami dwustronnymi	5-14
	metryczna z 2 uchami	5-17
	metryczna z 2 uchami płaskimi	5-19
	metryczna z hakami i uchem	5-15, 5-16
	Naprawczy zestaw Amecoil	3-153
	bardzo drobno- Amecoil nozwojny	3-150, 3-151

Index alfabetyczny

Naprawczy zestaw	BSW Amecoil	3-152
	metryczny Amecoil	3-149
	metryczny Amecoil	3-150
	drobnozwojny	
	UNC Amecoil	3-151
	UNF Amecoil	3-152
Narzędzia	do wkładek gwintowanych V-Coil	3-166/3-170
Narzędzie	do osadzania Fischer	8-53
	MaxxFast	8-53
	do wkrętów gniazdo samowierzących	6-147
	osadzające narzędzie samowierzący	6-146
	pneumatyczne urządzenie samowierzący	6-146
	wkrętak samowierzących	6-146
	gwintowa wkładka	3-176/3-178
	instalacyjne Fischer	8-23, 8-81
	narzędzie Fischer	8-76
	Spit	8-54
nitownica	ręczna	9-79
	pneumatyczna	9-80
ustalająca podkładka		7-130
	uchwyt	7-129
	uchwyt, magnetyczny	7-130
wnękowe	mocowanie Fischer	8-16
	MaxxFast	8-16
wtryskowe	Fischer	8-85
	MaxxFast	8-85
Narzędzie ręczne	do opasek MaxxFast	12-129
Nasadka	do śrub do śruby mocującej ościeżnicy okiennej Fischer	8-39
Nasadki	uszczelnianie wciskane	12-40
Niemetryczne stożkowe podkładki	ząbkowane zewnętrznie	7-69
Niemetryczny do bram	hak z 2 hakami oczkowymi	5-42
	prosty hak hak z łbem z wgłębieniem krzyżowym	5-35
	zestaw V-Coil	3-164, 3-165
Niska	koronowa nakrętka metryczna	3-89
	metryczna drobnozwojna	3-91
	kwadratowa nakrętka metryczna	3-116, 3-117
	radelkowana nakrętka metryczna	3-114, 3-115
	rękojeść metryczna do śrub, wkrętów i nakrętek z łbem sześciokątnym	12-84
	śruba metryczna	6-206, 6-207
	stopa ogniwą gęśienicy nakrętka UNF	3-42
	sześciokątna nakrętka izometryczna	3-33, 3-39
	metryczna	3-32/3-34
	metryczna drobnozwojna	3-35/3-37
metryczna lewy gwint	3-33, 3-34	
metryczna nadwymiarowa	3-33	
MF lewy gwint	3-36, 3-37	
wypukła nakrętka metryczna	3-101, 3-102	
Nit	kulisty łeb	9-31/9-33
	rozprężny jednostronnie zamknięty z zaślepką	9-67
	stożkowy łeb	9-34, 9-35
	wbijany	12-136
	wciskany	12-139
	wkręcany	12-137
	zapadkowy	12-138
Nit zrywalny	grzybkowy łeb	9-64/9-66, 9-70, 9-71, 9-73/9-75
	powiększony szerokokątesowy	9-61, 9-71
	rozprężny	9-77
	stożkowy	9-76
	stożkowy łeb	9-62/9-64, 9-72
	stożkowy płaski łeb	9-67
	wypukły łeb	9-55/9-59, 9-68, 9-69
	rozprężny	9-78
	Nitonakrętka cylindryczna	3-128/3-130
	cylindryczna	3-129, 3-137
kolnierz stożkowy	3-131/3-133, 3-138	
mini kolnierz stożkowy	3-134, 3-135	
trzonek sześciokątny	3-135, 3-136	
Nitonakrętka gumowa z mosiężną tuleją gwintową	8-49	
Rawlnut	Rawlplug	
Nitośruba	kolnierz walcowy	3-139
Nitowkręt	łeb kulisty	9-22
Nitownica	ręczna do nitonakrętek	3-140
	narzędzie	9-79
	pneumatyczna	9-80
	zestaw w walizce	9-80
Nitownica ręczna	w walizce	3-141
Nord-Lock	antywibracyjna podkładka	7-98, 7-102, 7-103
	sklejone 2 części	7-96/7-101
	sześciokątna nakrętka koło/kolpak z kolnierzem	3-83
Norma	zacisk	12-117, 12-118
Obejma	do rur pełna połowkowa	12-37, 12-38
	pełny połowa	12-33/12-36
	Fischer	10-47
	siodłowa Fischer	10-36
Obejmy rurowe	type A metryczny	12-30, 12-31
	type B metryczny	12-32
Obie części rurowy	zacisk Fischer	10-38
Obrotowy	hak	13-3
	obrotowy	13-3
	rękojeść przelotowe	12-79
	z gwintową końcówką z gwintową tuleją	12-80
		12-79, 12-80
Ochronna	zaśleпка do śrub, wkrętów i nakrętek z łbem sześciokątnym	1-98, 1-99
	korek	12-151
Ochronna podkładka		10-80
Ochronny odbojnik		12-143
Oczko ruchome	do przykręcania	13-129
Oczkowa	ósemka	13-33
	śruba metryczna	5-4, 5-5
	metryczna z gwintem na całej długości	5-6
Oczkowy	hak metryczny	5-28
	niemetryczny	5-30/5-32
Odbojnik	ochronny	12-143

Odbojnik	samoprzylepny			12-142
Oddzielnie	zaciskowe	regulowane		12-53
	łącze			
Odginana	podkładka			7-113/7-115, 7-117, 7-118
Odlewany	zawias			13-99, 13-100
		z gwintem		13-102, 13-103
Okienna	ościeżnica	wkręt	Fischer	8-39
			MaxxFast	8-38
Okragła	końcówka	z gwintem zewnętrznym		12-52
	pręta			
		lewy gwint		12-52
	łącząca	metryczna		3-124, 3-125
	nakrętka			
	nakrętka	do kluczy do nakrętek okrągłych z wcięciami		3-123
		gwint trapezowy		4-25
		lewy gwint		4-26
		metryczna z nacięciem prostym		3-123, 3-124
		trapezowa		4-26
		z wkładką samozabezpieczającą niemetaliczną		3-126
	nakrętka	metryczna		3-96
	wciskana			
	plaska	z gwintem wewnętrznym		12-51
		lewy gwint		12-51
	podkładka			7-5/7-9, 7-11, 7-12, 7-14/7-21, 7-29/7-33, 7-35/7-40, 10-11
		do konstrukcji drewnianej		7-40/7-42
		do sworzni		7-27/7-29
		Permaglas		4-23
		pod śruby z łbem walcowym		7-25, 7-26
		SAE		7-12, 7-13
		USS		7-10
		ze ścięciem		7-33, 7-34
	rurowa	zaślepka		10-105
Okragła powiększona	podkładka	Mudwing		7-44, 7-45
One way	owalny łeb stożkowy płaski	wkręt	samonacinające	10-127
Opaska	perforowana stalowa	Fischer		10-52
	zaciskowa	do kabli	samoprzylepny	12-132, 12-133
			z pod- możliwością mocowania	12-127
			zestaw	12-123
	zaciskowa opaska	do kabli		12-121
			MaxxFast	12-120/12-122
			mocowanie	12-129
			MaxxFast	12-128
			Ty-Rap	12-122, 12-123
		z okiem		12-124
		z tabliczką opisową		12-125
	zaciskowa węża	mocna	ABA	12-15
Opaska zaciskowa	do węży	ABA		12-7, 12-9/12-11, 12-18
			MaxxFast	12-6, 12-8, 12-10
		mikro	ABA	12-16
		mini	ABA	12-13
			MaxxFast	12-12
		mocna	ABA	12-14
	przewód	platik		12-130

Oporowy	pierścień	Dubo		7-111
Oprawka	ślizgowa	do gniazdka		10-83
		wprowadzana od przodu		10-85
O-ringi				7-152/7-157
	gumowe			7-158
Osadcza	plytka	do wałków		7-126
Osadczy	pierścień			7-135, 7-136
		do wałków		7-121, 7-127
		Dubo		7-110
		lekki		7-137
		wewnętrzny		7-124, 7-125
	zaciskowy	pierścień		7-133, 7-134
Ościeżnica	okienna	wkręt	Fischer	8-39
			MaxxFast	8-38
Ósemka	oczkowa			13-33
Ostro zakończona	nakrętka	metryczna		3-118
Owalny łeb stożkowy płaski	wkręt	samonacina-one way		10-127
		jące		
	wkręt do drewna	z gniazdem krzyżowym		6-191, 6-192
Ozdobny	kołpak			12-39
P				
Pal	sześciokątna nakrętka	metryczna	samozabezpieczająca	3-85
Pasowana śruba	sześciokątna metryczna z długim gwintem			1-71
Peiner	konstrukcyjna	śruba	metryczna	1-90
		na o dużej wytrzymałości		
	kwadratowa	klinowa	podkładka do ceownika do dwuteownika	1-93
				1-93
	podkładka			1-92
	sześciokątna nakrętka	metryczna		1-91
Pelikan	hak			13-51, 13-52
Pełna	obejma	do rur	pełny	12-37, 12-38
Pełne	pokrętło			12-107
		chowana rączka		12-108
Perforowana stalowa	opaska	Fischer		10-52
Permaglas	gwintowany	pręt	metryczny	4-21
	okragła	podkładka		4-23
	sześciokątny	nakrętka	metryczna	4-22
Phillips	wkręt	metryczna		6-33
Pięciogarny	uchwyt	metryczna		12-83
Pierścień				13-131/13-133
	oporowy	Dubo		7-111
	osadczy			7-135, 7-136
		do wałków		7-121, 7-127
		Dubo		7-110
		lekki		7-137
		wewnętrzny		7-124, 7-125
rozeta				10-98, 10-99, 12-143, 12-144
	uszczelniający			7-147/7-149
		FESTAPLAN		7-149, 7-150
	z drutu			13-68
	z gwoździem			13-133
	zaciskowy	osadczy		7-133, 7-134
	zgrzewany	do haka huśtawkowo-gimnastycznego		5-41
Pin	kulisty łeb	karbowany kolek		9-21, 9-22
	środkowa	karbowany kolek		9-20
		część		

Index alfabetyczny

	walcowy	karbowany kołek		9-17 , 9-18
		z prowadzeniem		9-13
	zbieżny	karbowany kołek		9-14 , 9-15 , 9-19
Pionowy	hakowy	przegubowy AMF zacisk		12-162
		przegubowy zacisk	AMF	12-152 , 12-153
Plaska	okrągła	z gwintem wewnętrznym		12-51
		lewy gwint		12-51
	podkładka			7-47/7-49
		do aut	fibrowa	7-151
Plaska napinająca	dźwignia	umożliwiająca podnoszenie		12-98
		z gwintową końcówką		12-98
Plaska stożkowa	śruba	metryczna z noskiem i nakrętką sześciokątną		1-81
Plaski koniec	dociskowy wkręt	Metryczny z nacięciem prostym		6-4 , 6-5
		metryczny drobnozwojny		2-81
		metryczny z gniazdem sześciokątnym		2-79 , 2-80
		UNC z gniazdem sześciokątnym		2-77 , 2-82 , 2-85 , 2-88 , 2-91
		UNF z gniazdem sześciokątnym		2-76 , 2-78
Plastikowy	korek			12-150
Platki	przewód	opaska zaciskowa		12-130
Płytki	osadczą	do wałków		7-126
Płytki sprężyste	do zgrzewania			10-82
Płytkowy łeb	śruba	metryczna		6-203
Pneumatyczna	nitownica	narzędzie		9-80
Podatna podkładka	dwuzwojowa			7-60
	falista			7-62
	kontaktowa			7-82
	lukowa			7-63/7-65
	stożkowa			7-61
Podkładka	antywibracyjna	GMT		12-70
		Nord-Lock		7-98 , 7-102 , 7-103
		sklejone 2 części	Nord-Lock	7-96/7-101
	blokująca	sprężynowa		7-104 , 7-105
	ceownik	Fischer		10-44
	do konstrukcji stalowych			7-22 , 7-23
	do śrub stożkowych			10-99 , 10-100
	do trójkąta dystansowego			13-80
	dystansowa			7-139/7-141
	głęboka	Lindapter		10-28
	kontaktowa			7-107 , 7-108
	kulista			10-9 , 10-10
	kwadratowa			7-142 , 7-143
		klinowa	do ceownika	7-145 , 7-146
			Peiner	1-93
		do dwuteownika		7-143 , 7-144
			Peiner	1-93
	ochronna podkładka			10-80
	odginana			7-113/7-115 , 7-117 , 7-118
	okrągła			7-5/7-9 , 7-11 , 7-12 , 7-14/7-21 , 7-29/7-33 , 7-35/7-40 , 10-11
		do konstrukcji drewnianej		7-40/7-42
		do sworzni		7-27/7-29
		Permaglas		4-23
		pod śruby z łbem walcowym		7-25 , 7-26
		SAE		7-12 , 7-13
		USS		7-10
		ze ścięciem		7-33 , 7-34
	okrągła powiększona			7-44 , 7-45
	Peiner			1-92
	plaska			7-47/7-49
		do aut	fibrowa	7-151
	samozabezpieczająca sprężysta			7-106
	sprężysta			7-55 , 7-56 , 7-59
		z kwadratowymi końcami		7-53 , 7-54 , 7-56 , 7-57
	stożkowa	sprężysta		7-89 , 7-90
	uszczelniająca			7-152
		z gumą		6-117 , 7-151
	uszczelniający	fibrowe		7-150
		z elastomerem uszczelniającym		6-116
	wklęsła podkładka	do śrub talerzowych		1-83
		z kolkiem sprężynującym powiększonym		7-23 , 7-24
		z kołnierzem		12-145
	zabezpieczająca			12-144
		z krawędzią		7-66
Podkładka zabezpieczająca	wachlarzowa	ząbkowana		7-68 , 7-72/7-74 , 7-77/7-81
	wachlarzowa	ząbkowana podkładka		7-70 , 7-71 , 7-75 , 7-76
Podkładki okrągłe	do konstrukcji drewnianych			7-43
	for wood constructions			7-43
Podnośnik denny				13-111
				13-112 , 13-113
Podpora do maszyn	elastyczna			12-72
Podpórka	element	Lindapter		10-25/10-27
Podwójna	zawlecza	przetyczka do śrub		9-42 , 9-43
Podwójna blokada	karabińczyk			13-25
Podwójny	cardana	przegub		12-49
	łącznik	talerzowy Fischer		10-53 , 10-54
Pojedyncza	zawlecza	sprężysta przetyczka do śrub		9-41
Pojedyncza	zawlecza			13-67
Pojedynczy	cardana	przegub		12-48
Pokrętło				12-104 , 12-105
	chowana rączka			12-109
		dwuramiennie		12-106
	dwuramiennie			12-106
	pełne			12-107
		chowana rączka		12-108
Płyty	do tylnej	śruba z gniazdem krzyżowym		6-107
Połączenie	klamra do belek			10-57 , 10-58
Polerowany	uchwyt płaski			13-134 , 13-135
Półkowa	obejma	do rur połowa		12-33/12-36
Poprzeczny	ustalający kołek	M z nacięciem prostym		10-97
Powers	śruba kotwiąca	do betonu	łeb grzybkowy	8-61
			łeb okrągły	8-61
			łeb stożkowy płaski	8-62
			łeb sześciokątny	8-60
	śruba kotwiąca A4	do betonu	łeb sześciokątny	8-60
	śrubowa kotwa		łeb okrągły	8-56
			łeb stożkowy płaski	8-55 , 8-58

Powers	śruba kotwiąca	leb z nacięciem sześciokątny prostym	8-57
Powiększony szeroko-zakresowy	grzybkowy leb	nit zrywalny	9-61, 9-71
Poziomy	hakowy	przegubowy AMF zacisk	12-161
		przegubowy zacisk AMF	12-154/12-156
Pręt	chemicznie mocowany	Fischer	8-79
		MaxxFast	8-78
	gwintowany	BSW	4-20
		gwint trapezowy	4-24, 4-25
		lewý gwint	4-24
		ISO metryczne	4-5, 4-7
		metryczny	4-3/4-12
		lewý gwint	4-5, 4-6, 4-8, 4-9
		Permaglas	4-21
		metryczny ASTM A193	4-38
		metryczny drobnozwojny	4-13
		metryczny nadwymiarowy	4-7, 4-10, 4-11
		nadwymiarowy	4-5
		UNC	4-15/4-17
		ASTM A193	4-35
		UNF	4-18, 4-19
	kotwa	metryczny	8-80
	kotwa gwintowana	Spit	8-81
Prostokątna	rurowa	zaślepka	10-106
Prostokątna	zaślepka	Fischer	10-42
Prosty hak	hak	niemetryczny	5-34
		z łbem z wgłębieniem krzyżowym	5-35
		metryczny	5-29
		niemetryczny	5-35
Prosty, otwarty	hak		13-120
Prowadzenie zapadka zamykająca zapadki			10-74
Przeciwna-krećka	UNC		3-40
Przeciw-sobny	przegubowy zacisk	AMF	12-157/12-159
Przeciw-zaczep	do zacisków hakowych	do zacisku przegubowego	AMF 12-163
Przedłużana nakrećka		metryczna	10-8
Przegub	cardana	podwójny	12-49
		pojedynczy	12-48
	kulowy	M/MF z gwintem wewnętrznym lewym	12-47, 12-48
		M/MF z gwintem wewnętrznym prawym	12-47
	widelkowy	z kołkiem sprężynującym	12-50
		ze sprężynującym kołkiem	12-50
Przegubowy	hakowy	zacisk AMF	12-160
	pionowy	zacisk AMF	12-152, 12-153
	poziomy	zacisk AMF	12-154/12-156
	przeciw-sobny	zacisk AMF	12-157/12-159
	zatrask		10-63
Przegubowy	hakowy	pionowy	AMF 12-162
	zacisk	poziomy	AMF 12-161
Przelotki			12-140
Przeplot	do lin		13-125
Przesuwana	nakrećka	Fischer	10-43

Przetyczka do śrub	zawleczka	podwójna	9-42, 9-43
Przewód	opaska zaciskowa	platik	12-130
Przykrywająca	zaślepka		6-110
Punktowe zgrzewanie	nakrećka	metryczna	3-111
Q			
Quick system	klucz dopasowany		10-73
R			
Rączka	bez możliwości obrotu	metryczna nieobrotowa	12-93
	chowana	metryczna obrotowa	12-95
	do wkręcania nasadek		12-93
	dźwignia przekładni	metryczna	12-97
	metryczna		12-92
	mostkowa		12-90, 12-91
		metryczna	12-91
		metryczna z mosiężną tuleją gwintową	12-90
	ręczna korba chowana	z gwintową tuleją	12-96
		chowana rączka	12-96
	z możliwością obrotu	metryczna obrotowe	12-94, 12-95
Radełkowana nakrećka		metryczna	3-115, 10-93
		niska	3-114, 3-115
		wysoka	3-113
	rękojeść	metryczna do śrub, wkrętów i nakretek z łbem sześciokątnym	12-84
		wysoka	12-84
	śruba	metryczna	6-207
		niska	6-206, 6-207
		wysoka	6-204, 6-205
		metryczna z nacięciem prostym	6-205
	uchwyt	metryczna z gwintową końcówką	12-85, 12-86
		metryczna z gwintową tuleją	12-86
Radełkowane rękojeść		metryczna z gwintową tuleją	12-87
Radełkowany rękojeść		metryczna do śrub z łbem z gniazdem sześciokątnym	12-85
Ramię	wspornik	Fischer	10-41
Rawłplug	nitonakrećka Rawlnut	gumowa z mosiężną tuleją gwintową	8-49
	rozporowa	kotwa	8-43, 8-45, 8-46
Ręczna	nitownica	do nitonakretek	3-140
	narzędzie		9-79
		pneumatyczna	9-80
		zestaw w walizce	9-80
Ręczna korba	rączka	chowana z gwintową tuleją	12-96
		chowana rączka	12-96
Ręczne narzędzie montażowe	wielowymiarowe	metryczne Amecoil	3-154
		metryczne kompletne	3-155, 3-156
		metryczna z końcówką wylotową	3-155
Regulowana śruba		Fischer	8-40

Index alfabetyczny

Regulowane mocowanie				13-50, 13-51
	Fischer			8-41
	zaciskowe	oddzielnie		12-53
Regulowany zacisk z końcówką	Lindapter			10-30
Rejestracyjne tablice	śruba	z łbem z wgłębieniem krzyżowym		6-107, 6-108
Rękojeść	gwiazdowa	metryczna		12-78, 12-79
	kulowa	metryczna		12-76, 12-77
	obrotowa	przelotowe		12-79
		z gwintową końcówką		12-80
		z gwintową tuleją		12-79, 12-80
	radelkowana	metryczna niska		12-84
		do śrub, wkrętów i nakrętek z łbem sześciokątnym		
		wysoka		12-84
	radelkowana	metryczna z gwintową tuleją		12-87
	radelkowana	metryczna do śrub z łbem z gniazdem sześciokątnym		12-85
	talerzowa	metryczna przelotowe		12-81
		metryczna z gwintową końcówką		12-81, 12-82
		metryczna z gwintową tuleją		12-81, 12-82
	trójkątna	z gwintową końcówką		12-82
	gwiazdowa	z gwintową tuleją		12-82, 12-83
REMFORM®	grzybkowy	wkręt	wgłębienie	samogwintujący
	łeb	metryczny	krzyżowe	6-71
	walcowy	wkręt	wgłębienie	samogwintujący
	soczewkowy	metryczny	krzyżowe	6-70
	łeb			
			metryczny	samogwintujący
			Torx®	6-71
Ripp	sześciokątna	nakrętka	z kołnierzem	samo zabezpieczająca
				3-74
	sześciokątna	śruba z kołnierzem	metryczna	samo zabezpieczająca
				1-62, 1-63
	walcowy	łeb	śruba z kołnierzem stożkowym	metryczny z gniazdem sześciokątnym
				2-63
Równoległy	łącznik	Fischer		10-50
Rozeta	pierścień			10-98, 10-99, 12-143, 12-144
Rozporowa	kotwa	metryczna z Fischer mosiężnym stożkiem		8-46
		metryczna z nakrętką		8-44
		Rawplug		8-43, 8-45, 8-46
Rozporowe	kołki	MaxxFast		8-42
Rozporowy	kołek			8-43
Rozprężny	grzybkowy	nit zrywalny		9-77
	łeb			
	jednostronnie zamknięty	nit z zaślepką		9-67
	wypukły	łeb	nit zrywalny	9-78
Ruchomy trzpień	sprężysty	gładkie wykonanie		12-59
		M z plastikową zawleczką		12-59
		metryczny z kulką		12-56
		metryczny ze szpilką		12-57, 12-58
Rurka	izolacyjna			12-148
Rurowa	zaśleпка	kwadratowa		10-106
		okrągła		10-105

			prostokątna		10-106
			stożkowa		10-107
Rurowa					3-48
Rurowy	zacisk				12-25
		obie części	Fischer		10-38
		zawiasowy	zacisk	Fischer	10-37
Ryglowe		zamknięcie			13-106
		zatrzaski			13-107, 13-108
S					
SAE	okrągła		podkładka		7-12, 7-13
Samogwintujące	grzybkowy	wkręty	metryczne	REMFORM®	6-71
	łeb		krzyżowe	gniazdo	
		łeb stożkowy	wkręty	metryczna z gniazdem sześciokątnym	6-68
		płaski		z łbem stożkowym	6-68
		stożkowy	łeb wkręty	metryczna z gniazdem krzyżowym	6-59
				metryczne	TAPTITE
				Torx®	2000®
				UNC	z gniazdem sześciokątnym
					6-61
	stożkowy	wkręty	metryczna z gniazdem		6-58
	soczewkowy		krzyżowym		
	łeb				
	sześciokątna	śruba z kołnierzem	metryczna	TAPTITE 2000®	6-63
	sześciokątny	wkręty	metryczny		6-60
	walcowy	śruba	M z gniazdem krzyżowym		6-57
	soczewkowy				
	łeb			M z łbem pomniejszonym	6-67
				M z łbem walcowym	6-66
				metryczny	REMFORM®
				krzyżowe	gniazdo
				metryczny	REMFORM®
				Torx®	6-71
				TAPTITE 2000®	6-65
Samonaci-nająca	gwintowa		wkładka		3-172/3-174
				z gniazdem sześciokątnym	3-174, 3-175
Samonaci-nające	grzybkowy	wkręty	z trójskrzydłowym		10-123
	łeb	zabezpieczające	wgłębieniem		
		wkręt			10-118, 10-119
		jednostronny wkręt	samogwintujący		10-122
			Łeb stożkowy		10-122
	łeb stożkowy	wkręt			10-123, 10-124, 10-126
	płaski				
	owalny	łeb	wkręt	jednostronnie wkręcany	10-127
	stożkowy				
	płaski				
	stożkowy	śruba samo-gwintująca	z gniazdem krzyżowym		10-125
	walcowy	łeb	śruba		10-120
			wkręt		10-120
				z 2 otworami	10-121
	walcowy	wkręt	z 2 otworami		10-126
	soczewkowy				
	łeb				
Samoprzylepny		odbojnik			12-142
	zaciskowa	do kabli	opaska		12-132, 12-133

Samoregula- cyjny zacisk	Lindapter			10-29
Samowier- cąca kotwa	do płyt gipsowo-kartonowych			8-18
Samowier- cąca do wkrętów	narzędzie osadzające narzędzie			6-146
	narzędzie samowiercą- cych			6-146
			pneumatyczne urządzenie	6-146
grzybkowy leb	wkręt		gniazdo SR	6-140
leb stożkowy plaski	ttap® wkręt		wkręt z gniazdem krzyżowym	6-134, 6-135, 6-141
			wkręt wgłębienie krzyżowe MaxxFast	6-131
stożkowy	wkręt		Torx®	6-143
			UNC Torx®	6-144
stożkowy leb śruba			z gniazdem krzyżowym skrzydełkami	6-145
	wkręt		z gniazdem krzyżowym ze skrzydełkami i sześciokarbowym gniazdem	6-132, 6-133 6-142
sześciokątna śruba			MaxxFast	6-135, 6-136
sześciokątny wkręt z kołnierzem walcowym				6-137, 6-138
walcowy leb kwadratowy gniazdem			z kwadratowym gniazdem MaxxFast	6-128
	śruba		z gniazdem krzyżowym	6-122/6-124
	ttap® wkręt		wkręt MaxxFast	6-126, 6-127
			wkręt wgłębienie krzyżowe MaxxFast	6-119, 6-120
			z gniazdem SR	6-129
			z kwadratowym gniazdem	6-130
Samowier- cących do wkrętów	narzędzie osadzające narzędzie		z gniazdem	6-147
	narzędzie samowiercą- cych		wkręta	6-146
Samozabez- pieczająca do układów wydechowych	nakrętka			3-42
okragła	nakrętka		z wkładką niemetaliczną	3-126
sześciokątna kołnierzowa nakrętka			UNC	3-80
			z wkładką niemetaliczną	3-81
	kolpakowa nakrętka		z wkładką niemetaliczną	3-102, 3-103
	nakrętka		BSF z wkładką niemetaliczną	3-63
			BSW z wkładką niemetaliczną	3-63
			drobnozwojna stalowa	3-67
			drobnozwojna z wkładką niemetaliczną	3-39, 3-52, 3-53
			metryczna	3-65, 3-75, 3-76
			metryczna Snep	3-72
			alumiowa	
			metryczna stalowa	3-66, 3-73
			Securit	3-75
			Snep	3-71, 3-72
			Stover	3-66
			metryczna stalowa nierdzewna	3-64
			Snep	3-71
	Pal		metryczna	3-85
	UNC		stalowa	3-68, 3-69
			z wkładką niemetaliczną	3-55/3-57, 3-59/3-61
	UNF		stalowa	3-70

				z wkładką niemetaliczną	3-58, 3-59, 3-61, 3-62
				z kołnierzem Ripp	3-74
				z wkładką niemetaliczną	3-49/3-51, 3-54
				z załkowaną podkładką zabezpieczającą przed wypadnięciem po rozłączeniu	3-84
sześciokątna śruba z kołnierzem			metryczna		1-64, 1-65
				Ripp	1-62, 1-63
walcowy leb	śruba z kołnierzem stożkowym		metryczny z gniazdem sześciokątnym	Ripp	2-63
Samozabez- pieczająca podkładka sprężysta					7-106
Ściągacz do lin					13-37, 13-39, 13-41/13-43
Ściągacz wahlivy			uniwersalny		13-69
Ściągacza linowego			końcówka		13-50
			nakrętka		13-77
Ściana pokryta płytami okładzinowymi (mur suchy)	śruba z gniazdem krzyżowym				6-199
Ścienny			trójkąt dystansowy		13-79
Securit	sześciokątna nakrętka		metryczna stalowa samozabezpieczająca		3-75
Security	korek		Torx		10-129
Seha	skrzydełkowa śruba z pod-sadzeniem		metryczna z sześciokątną nakrętka		1-80
SFS-Topform dachowe i ściennie	wkręty		z elastomerem uszczelniającym		6-111
			z końcem płaskim		6-112
Szekla			zatraskowa		13-26, 13-27
Siodłowa	obejma		Fischer		10-36
Skręcana oczkowa	końcówka				13-53, 13-54
Skrzydełkowa	nakrętka		BSW		3-106
			metryczna		3-108
			metryczna typ amerykański niski		3-103, 3-104
			metryczna z gwintową tuleją		12-88
			zaokrąglone skrzydełka		3-104, 3-105
	śruba		metryczna typ amerykański niski		6-208, 6-209
			metryczna z gwintową końcówką		12-88
			metryczna zaokrąglone skrzydełka		6-209, 6-210
	śruba z pod-sadzeniem		metryczna z Seha sześciokątną nakrętka		1-80
Skrzydełkowa z kołnierzem walcowym	nakrętka		metryczna		3-108
Skrzydełkowy uchwyt			metryczna		12-87
Skrzynia	transportowa		Fischer		11-27
Ślizgacz					12-141
Ślizgowa	oprawka		do gniazdka		10-83
Ślizgowe	łożysko				12-146
Snep	sześciokątna nakrętka		metryczna aluminiowa samozabezpieczająca		3-72
			metryczna stalowa samozabezpieczająca		3-71, 3-72

Index alfabetyczny

Snep sześciokątna	metryczna stalowa nierdzewna	self-zabezpieczająca	3-71
Spiralna naciągowa/rozciągowa	sprężyna naciskowa	z angielskim uchem	12-75
	sprężyna		12-74
Spit chemiczna	kotwa	kapsuła	8-83
	instalacyjne	narzędzie	8-54
	klinowa	kotwa	8-69
	kotwa	pręt	8-81
	gwintowana		
	wbijana	kotwa	8-25
Sprężyna blokująca	talerzowa		7-93, 7-94
	spiralna	naciągowa/rozciągowa	12-75
		naciskowa	12-74
	talerzowa		7-87, 7-88
		do napinania łożysk kulkowych	7-92
		do zastosowań krytycznych	7-83/7-85, 7-92
Sprężynowa blokująca	podkładka		7-104, 7-105
Sprężynujący wspornik			10-84
Sprężysta podkładka			7-55, 7-56, 7-59
		z kwadratowymi końcami	7-53, 7-54, 7-56, 7-57
	stożkowa	podkładka	7-89, 7-90
Sprężysta jednozwojowa podkładka	lock washer		7-58
		z kwadratowymi końcami	7-50/7-52, 7-57, 7-58
Sprężysta płytka	do nitowania		10-82
Sprężysta przetyczka do śrub	zawleczka	pojedyncza	9-41
Sprężyste trzpień	ruchomy	gładkie wykonanie	12-59
		M z plastikową zawleczką	12-59
		metryczny z kulką	12-56
		metryczny ze szpilką	12-57, 12-58
	walcowy kolek		9-24/9-26, 9-28/9-30
Środkowa część	karbowany kolek		9-20
Śruba antywibracyjna	GMT		12-71
	czepakowa	metryczna	1-82, 1-83
	do oprawiania	metryczna	10-105
	do rowków teowych	metryczna do rowków teowych	10-4
	do tylnej	plyty z gniazdem krzyżowym	6-107
	dwugwint	metryczna	5-36/5-39
	dwustronna	metryczna ze zredukowanym trzpieniem	4-61, 4-62
	fundamentowa	metryczna	8-89, 8-90
	grzybkowy łeb	M z gniazdem sześciokarbowym	2-54, 2-55, 10-113
		metryczna	1-72, 1-73, 1-75
		metryczna z gniazdem sześciokątnym	10-96
		metryczna z sześciokątną nakrętką	1-76
		metryczna ze szpilką	10-111
		metryczne samogwintu-REMFORM®	6-71
		krzyżowe jące	
		gniazdo	
		metryczne z krótkim podsadzeniem	1-80
		metryczne z podsadzeniem sześciokątną nakrętką	1-82
		UNC	1-77/1-79
		z gniazdem sześciokątnym	2-57
	UNF	z gniazdem sześciokątnym	2-58, 2-59
	kombi	metryczna z nacięciem prostym	6-35
	konstrukcyjna o dużej wytrzymałości	metryczna Peiner	1-90
	kotwa	Fischer	8-72
	książkowa		10-103, 10-104
	kulisty łeb	metryczna z gniazdem sześciokątnym	2-52, 2-53
		metryczny z nacięciem prostym	6-31, 6-32
	kwadratowy łeb	metryczna ze czopem krótkim	1-84
	łeb młoteczkowy	z podsadzeniem kwadratowym	5-2, 5-3
	łeb stożkowy płaski	metryczna samogwintujące z gniazdem sześciokarbowym	6-68
		metryczny z wgłębieniem krzyżowym	6-93
		z łbem samogwintujące stożkowym	6-68
	łeb w kształcie T	metryczna	5-3
	oczkowa	metryczna	5-4, 5-5
		metryczna z gwintem na całej długości	5-6
	płaska stożkowa	metryczna z noskiem i nakrętką sześciokątną	1-81
	plytkowy łeb	metryczna	6-203
	radełkowa	metryczna	6-207
		niska	6-206, 6-207
		wysoka	6-204, 6-205
		metryczna z nacięciem prostym	6-205
	regulowana	Fischer	8-40
	rejestracyjne tablice	z łbem z wgłębieniem krzyżowym	6-107, 6-108
	ściana pokryta płytami okładzinowymi (mur suchy)	z gniazdem krzyżowym	6-199
	skrzydełkowa	metryczna typ amerykański niski	6-208, 6-209
		metryczna z gwintową końcówką	12-88
		metryczna zaokrąglone skrzydełka	6-209, 6-210
	stopa ogniwa gęsienicy	Caterpillar	1-87
	stożkowa	metryczna z 2 otworami	10-117
		metryczna z gniazdem sześciokątnym	2-40/2-44
	stożkowy łeb BSW	z gniazdem sześciokątnym	2-50
		z nacięciem prostym	6-27, 6-28
		M z gniazdem sześciokarbowym	2-44, 2-45
		metryczna samogwintujące z gniazdem krzyżowym	6-59
		metryczne samogwintu-TAPTITE Torx® jące 2000®	6-64
		metryczny z wgłębieniem krzyżowym	6-44/6-48
	UNC	z gniazdem samogwintu-sześciokarbowym	6-61
		z gniazdem sześciokątnym	2-46, 2-47

Śruba	stożkowy łeb UNF z gniazdem sześciokątnym	2-49 , 2-50
	z gniazdem samowiercący krzyżowym skrzydełkami	6-145
stożkowy soczewkowy łeb	metryczna samogwintująca z gniazdem krzyżowym	6-58
	metryczny z wgłębieniem krzyżowym	6-94/6-97
sześciokątna	BSF	1-59
	BSW	1-58
	gwint calowy Whitworth'a, drobnzwojny	1-61
	izometryczna	1-8
	metryczna	1-3 , 1-5/1-7 , 1-10/1-12 , 1-14 , 1-16 , 1-17 , 1-36
	metryczna do zbiorników ciśnieniowych	1-12
	metryczna drobnzwojna	1-37 , 1-38
	metryczna nadwymiarowa	1-9
	metryczna z nacięciem prostym	1-35
	metryczna z pomniejszonym 6-kątem i czopem walcowym	1-86
	metryczna z sześciokątną nakrętką	1-18
	samowiercący MaxxFast	6-135 , 6-136
	UNC	1-42/1-44 , 1-46 , 1-47 , 1-49 , 1-50
	UNF	1-53 , 1-54 , 1-56 , 1-57
	zabezpieczająca	10-128
sześciokątna z kołnierzem	metryczna samozabezpieczająca z kołnierzem Ripp	1-64 , 1-65 , 1-62 , 1-63
sześciokątna z kołnierzem stożkowym	metryczna	1-66/1-69
	metryczna drobnzwojna	1-70
	metryczna ząbkowane	1-69
sześciokątny gwint calowy Whitworth'a, zwykły	metryczny samogwintujące	1-60 , 6-60
T-kształtne łeb	Fischer	10-42 , 10-45
ucho do podnoszenia	BSW	5-9
	metryczna	5-8 , 5-9
walcowy łeb	BSW z gniazdem sześciokątnym	2-32
	drobnzwojna z gniazdem sześciokątnym	2-20
	metryczna	2-18 , 2-19
	metryczna z 2 otworami	10-114
	metryczna z gniazdem sześciokątnym	2-16 , 2-17
	metryczna z gniazdem sześciokątnym	2-3/2-7 , 2-9 , 2-10 , 2-12 , 2-14 , 2-15
	metryczna z gwintem na całej długości	2-17/2-19
	metryczny z wgłębieniem krzyżowym	6-79/6-83
	do tarasów	6-82
	z końcem płaskim	6-83
	samonacinające	10-120
	UNC	2-26
	z gniazdem sześciokątnym	2-21/2-23 , 2-25 , 2-27
	UNF z gniazdem sześciokątnym	2-29/2-31
	z gniazdem samowiercący krzyżowym	6-122/6-124

walcowy niski łeb	metryczna z gniazdem sześciokątnym	2-33/2-35 , 2-37 , 2-38
walcowy płaski łeb	z gniazdem sześciokątnym	10-96
walcowy soczewkowy łeb	M z gniazdem krzyżowym	6-57
	M z łbem pomniejszonym	6-67
	M z łbem walcowym	6-66
	metryczny krzyżowe gniazdo	6-70
	metryczny Torx®	6-71
	TAPTITE 2000®	6-65
zabezpieczająca	metryczna drobnzwojna	12-61
	MF bez blokującego rowka	12-60
	MF z rowkiem blokującym	12-60
Śruba do drewna	kulisty łeb prowadzenie z kwadratowym gniazdem	10-127 , 10-128
Śruba dwustronna	do nakrętek teowych	10-12
	M z 2 sześciokątnymi nakrętkami	4-56
	UNC z 2 sześciokątnymi nakrętkami	4-40/4-42 , 4-45 , 4-47 , 4-50 , 4-51 , 4-53
Śruba kotwiąca	do betonu łeb grzybkowy	8-61
	łeb okrągły	8-61
	łeb stożkowy płaski	8-62
	łeb sześciokątny	8-60
Śruba kotwiąca A4	do betonu łeb sześciokątny	8-60
Śruba pasowana	stopniowany trzpień	2-65 , 2-68
	UNC	2-67
	z gniazdem sześciokątnym	2-67
Śruba samogwintująca	grzybkowy łeb	10-123
	samonacinające z trójskrzydłowym wgłębieniem	10-122
	łeb jednostronny	10-122
	łeb stożkowy	10-122
	stożkowy samonacinające z gniazdem krzyżowym	10-125
Śruba z kołnierzem	grzybkowy łeb	2-62
	sześciokątna metryczna	6-63
	samonacinające z gniazdem sześciokątnym	2-62
Śruba z kołnierzem stożkowym	walcowy łeb	2-63
	metryczny z gniazdem sześciokątnym	2-63
Śruba z kołnierzem walcowym	kulisty łeb	2-60 , 2-61
Śruba z łbem 6-kątnym	sześciokątna izometryczna	1-24
	metryczna	1-20/1-22 , 1-24 , 1-26 , 1-27 , 1-29 , 1-31/1-34
	metryczna do zbiorników ciśnieniowych	1-27
	metryczna drobnzwojna	1-39/1-41
	metryczna nadwymiarowa	1-25

Index alfabetyczny

Śruba z podkładką	do elewacji	koniec płaski	6-113
		koniec stożkowy	6-113
Śruba z sadzeniem	skrzydełkowa	metryczna z sześciokątną nakrętką	1-80
Śrubay	zaślepka	łeb z wgłębieniem krzyżowym	6-108
Śrubowa	kotwa	Fischer	8-75
		łeb okrągły Powers	8-56
		łeb stożkowy płaski Powers	8-55, 8-58
		łeb z nacięciem sześciokątny prostym Powers	8-57
Śrubowy	łącnik	Fischer	10-54
Śruby	do elewacji	flat point	6-114
		z podkl	6-114
Śruby dwustronne	BSW		4-33
	metryczne		4-27, 4-28, 4-30/4-32, 4-34
Śruby młoteczkowe	zestawy	do rowków teowych	10-14
Stalowa	perforowana opaska	Fischer	10-52
Stalowa lina			13-55
	zacisk		5-24, 5-25
Stopa belki	zacisk	Lindapter	10-32
		ze śrubą dociskową i nakrętką	10-32
Stopa ogniwa gęsienicy	nakrętka	UNF	3-42
		kwadratowe	3-42
		niska	3-42
		wysoka	3-41
	śruba	Caterpillar	1-87
Stopniowany trzpień	śruba pasowana	metryczna z gniazdem sześciokątnym	2-65, 2-68
		UNC	2-67
		z gniazdem sześciokątnym	2-67
Stover	sześciokątna nakrętka	metryczna stalowa samozabezpieczająca	3-66
Stożkowa	kulkowa ciśnieniowa smarownicza	BSP-R niemetryczny	12-45
		gwint całowy, zunifikowany, drobnozwojny	12-46
		MEF	12-45
		metryczna	12-42
		metryczna drobnozwojna	12-44
	nakrętka	metryczna z nacięciem prostym	3-126
	podatna podkładka		7-61
	rurowa	zaślepka	10-107
	sprężysta	podkładka	7-89, 7-90
	śruba	metryczna z 2 otworami	10-117
		metryczna z gniazdem sześciokątnym	2-40/2-44
Stożkowa zabezpieczająca sprężyna	system szybkiego montażu		10-81
Stożkowe podkładki	ząbkowane zewnętrznie	niemetryczne	7-69
Stożkowy soczewkowy łeb	wkręt	metryczny z nacięciem prostym	6-28/6-30
Stożkowy kołek			9-4
		z gwintem wewnętrznym	9-11

			z gwintem zewnętrznym	9-10
nit zrywalny				9-76
śruba samogwintująca	samonacina-jąca	z gniazdem krzyżowym		10-125
wkręt	Torx®	samowiercący		6-143
	UNC	Torx® samowiercący		6-144
wkręt do drewna		z gniazdem krzyżowym		6-187
		z nacięciem prostym		6-180, 6-181
wkręt samogwintujący		metryczny z gniazdem krzyżowym		6-87/6-90
		metryczny z gniazdem sześciokątnym		6-92
		metryczny z nacięciem prostym		6-75, 6-76
wkręty do płyt wiórowych		Sześciokarbowy		6-161
		z gniazdem sześciokątnym		6-160, 6-161
		Heco-Topix		6-160, 6-162
		Heco-Unix Top		6-160
Stożkowy koniec	dociskowy wkręt	M z nacięciem prostym		6-6, 6-7
		metryczny z gniazdem sześciokątnym		2-83, 2-84
Stożkowy łeb	nit			9-34, 9-35
	nit zrywalny			9-62/9-64, 9-72
śruba	BSW	z gniazdem sześciokątnym		2-50
		z nacięciem prostym		6-27, 6-28
		M z gniazdem sześciokątnym		2-44, 2-45
	metryczna	samogwintująca z gniazdem krzyżowym		6-59
	metryczne	samogwintu- Torx® jące 2000®		6-64
	metryczny	wgłębieniem krzyżowym		6-44/6-48
	UNC	z gniazdem samogwintu- sześciokarbowym jące		6-61
		z gniazdem sześciokątnym		2-46, 2-47
	UNF	z gniazdem sześciokątnym		2-49, 2-50
		z gniazdem samowiercący krzyżowym skrzydełkami		6-145
wkręt		metryczny z nacięciem prostym		6-22, 6-23, 6-25, 6-26
		z gniazdem krzyżowym samowiercący		6-132, 6-133
		ze skrzydełkami i sześciokątnym gniazdem		6-142
wkręt do drewna		z gniazdem Heco-Topix sześciokątnym		6-164
wkręty do płyt wiórowych		z gniazdem krzyżowym		6-154/6-156
		Heco-Fix		6-155
		Heco-Topix		6-157
		Heco-Unix Plus		6-157
		hole		6-158
		łeb pomniejszony		6-159
Stożkowy płaski łeb	nit zrywalny			9-67

Stożkowy płaski łeb	ttap®	wkręt	MaxxFast	6-151, 6-152, 6-164, 6-176	
		wkręt do drewna	wgłębienie krzyżowe	6-149, 6-150	
Stożkowy soczewkowy łeb	śruba	metryczna	samogwintująca	6-58	
			z gniazdem krzyżowym	6-94/6-97	
	wkręt	metryczny		6-102, 6-103	
		metryczny	z gniazdem sześciokarbowym	6-54, 6-55	
		metryczny	z nacięciem prostym	6-77	
		metryczny	z wgłębieniem krzyżowym	6-51/6-53	
	wkręt do drewna		z nacięciem prostym	6-186	
	wkręty do płyt wiórowych		z gniazdem krzyżowym	6-172	
			Heco-Fix	6-172	
	Strona informacyjna	Amecoil	wkładki gwintowe z drutu		3-142
Demu/Vemo		kotwy mocujące		8-94	
Fabory			zestawy asortymentowe w kasetach		11-2
			Fastclip System mocowania		10-55
			globalny partner w śrubach dwustronnych		4-36
			kule techniczne		12-110
			nity zrywalne		9-52
			nity zrywalne II		9-53
			nity zrywalne, nitonakrętki i nitośruby		3-127
			Quick System Elementy złączne ćwierć-obrotowe		10-75
			Quick System Zatrzaski przegubowe		10-61
			Quick System Zatrzaski zapadkowe		10-66
			Security Elementy złączne zabezpieczające		10-108
			Spedec Wkręty samowierzące		6-121
			wkładki gwintowe samonacinające		3-171
			wkładki gwintowe samonacinające II		3-179
		Fischer			8-6
Kalei			nakrętki wciskane	3-93	
Keepstock			Elementy wyposażenia	11-26	
Lindapter			połączeniach konstrukcji stalowych	10-16	
MaxxFast			zaprawy chemiczne do kotew	8-77	
			kotwy	8-3	
			nowe opaski zaciskowe	12-119	
			opaski zaciskowe do węży	12-5	
			wkręty do drewna	6-148	
			wkręty samowierzące	6-118	
			zestawy	11-13	
		Nord-Lock			7-95
		Peiner		Śruby konstrukcyjne o dużej wytrzymałości	1-88
		REMFORM®		Śruby samogwintujące do tworzyw	6-69
			Śruby dwustronne – pręty gwintowane - nakrętki sześciokątne	4-37	
			Śruby dwustronne ze zredukowanym trzpieniem	4-60	
TAPTITE			samogwintujące śruby i wkręty 2000®	6-62	
ttap®			napęd	6-125	
			Wkręty do płyt wiórowych	6-153	
Sufitowy hak			metryczny	5-29	
			niemetryczny	5-32, 5-33	
Sworzeń kulowy sworzeń				9-35, 13-64, 13-65	
				10-77	

	kwadratowy łeb	UNC	z czopem krótkim	1-85
			z łbem skrzydełkowym	10-76
			z nacięciem prostym	10-77
			z rowkiem z nacięciem prostym	10-76
System	zacisków	Band-It		12-26/12-28
System szybkiego montażu		stożkowa zabezpieczająca sprężyna		10-81
		ustalający pierścień		10-79
		uszczelniający pierścień		10-80
		zabezpieczająca podkładka		10-78
Szafka z szufladami	zestaw	w kasetach stalowych	akcesoria	11-24
Szeka				13-12
	D			5-20, 5-21
	krętlikowa			13-29, 13-30
	typ D			13-5/13-7, 13-10, 13-11
	wygięta			13-9
			ze śrubą z kołnierzem walcowym i przetyczką	5-22, 5-23
			zatrzaskowa	13-26, 13-27
Sześciokątna	Hollo-bolt	Lindapter		10-17, 10-18
	kołnierzowa nakrętka	UNC	samozabezpieczająca	3-80
			z kołnierzem	3-79
			z wkładką samozabezpieczającą niemetaliczną	3-81
			ząbkowana	3-78, 3-79, 3-82
	kołpakowa nakrętka	z wkładką niemetaliczną	samozabezpieczająca	3-102, 3-103
	nakrętka			3-83
	BSF			3-28
			z wkładką samozabezpieczającą niemetaliczną	3-63
	BSW			3-27, 3-28, 3-30
			z wkładką samozabezpieczającą niemetaliczną	3-63
	drobnozwojna stalowa			3-67
	drobnozwojna z wkładką niemetaliczną			3-39, 3-52, 3-53
	gwint równoległy G			3-41
	izometryczna			3-8, 3-17/3-20, 3-44
		niska		3-33, 3-39
	koło/kołpak		z kołnierzem Nord-Lock	3-83
	metryczna			3-6/3-14, 3-29/3-31, 3-38, 3-43/3-46, 4-63, 10-6, 10-7
		lewy gwint		3-6, 3-7, 3-11, 3-12
		niska		3-32/3-34
		Peiner		1-91
			samozabezpieczająca	3-65, 3-75, 3-76
	metryczna aluminiowa	samozabezpieczająca	Snep	3-72
	metryczna do śrub dwustronnych			4-62
	metryczna do zbiorników ciśnieniowych			3-19
	metryczna drobnozwojna			3-15, 3-16, 3-53
		niska		3-35/3-37
	metryczna lewy gwint	niska		3-33, 3-34
	metryczna nadwymiarowa			3-8, 3-9, 3-44
		niska		3-33
	metryczna stalowa		samozabezpieczająca	3-66, 3-73

Index alfabetyczny

Sześciokątna nakrętka	Securit				3-75
	Snep				3-71, 3-72
	Stover				3-66
metryczna stalowa nierdzewna	metryczna samozabezpieczająca				3-64
	Snep				3-71
metryczny ASTM A194 Gr. 2H					4-59
MF lewy gwint					3-15, 3-16
	niska				3-36, 3-37
Pal	metryczna samozabezpieczająca				3-85
UNC					3-21, 3-22, 3-57
	ASTM A194				4-57/4-59
	stalowa samozabezpieczająca				3-68, 3-69
	z wkładką samozaberniemetaliczną pieczająca				3-55/3-57, 3-59/3-61
UNF					3-24, 3-25, 3-58
	stalowa samozabezpieczająca				3-70
	z wkładką samozaberniemetaliczną pieczająca				3-58, 3-59, 3-61, 3-62
z kołnierzem					3-77
	samozabezpieczająca Ripp				3-74
z wkładką niemetaliczną	samozabezpieczająca				3-49/3-51, 3-54
z ząbkowaną podkładką zabezpieczającą przed wypadnięciem po rozłączeniu	samozabezpieczająca				3-84
nakrętka z kołnierzem walcowym	metryczna				10-7, 10-8
pasowana śruba	metryczna z długim gwintem				1-71
śruba	BSF				1-59
	BSW				1-58
	gwint calowy Whitworth'a, drobnozwojny				1-61
	izometryczna				1-8
	metryczna				1-3, 1-5/1-7, 1-10/1-12, 1-14, 1-16, 1-17, 1-36
	metryczna do zbiorników ciśnieniowych				1-12
	metryczna drobnozwojna				1-37, 1-38
	metryczna nadwymiarowa				1-9
	metryczna z nacięciem prostym				1-35
	metryczna z pomniejszonym 6-kątem i czopem walcowym				1-86
	metryczna z sześciokątną nakrętką				1-18
	samowiercą MaxxFast				6-135, 6-136
	UNC				1-42/1-44, 1-46, 1-47, 1-49, 1-50
	UNF				1-53, 1-54, 1-56, 1-57
	zabezpieczająca				10-128
śruba z kołnierzem	metryczna samogwintująca TAPTITE 2000®				6-63
śruba z łbem izometryczną 6-kątnym					1-24
	metryczna				1-20/1-22, 1-24, 1-26, 1-27, 1-29, 1-31/1-34
	metryczna do zbiorników ciśnieniowych				1-27
	metryczna drobnozwojna				1-39/1-41
	metryczna nadwymiarowa				1-25
zestaw do połączeń konstrukcyjnych	metryczna z sześciokątną nakrętką				1-97
Sześciokątna do zgrzewania	nakrętka metryczna				3-109
Sześciokątna z kołnierzem	śruba metryczna samozabezpieczająca				1-64, 1-65
	Ripp				1-62, 1-63
Sześciokątna z kołnierzem stożkowym	śruba metryczna				1-66/1-69
	metryczna drobnozwojna				1-70
	metryczna ząbkowane				1-69
Sześciokątny nakrętka	metryczna Permaglas				4-22
	śruba gwint calowy Whitworth'a, zwykły				1-60
	metryczna samogwintująca				6-60
wkręt do drewna					6-174
	z podkładką bitumiczną				6-176
	z podkładką nierdzewną ołowiowo-bitumiczną				6-174, 6-175
wkręt samogwintujący					6-100
	metryczny				6-98, 6-99
	metryczny z końcem płaskim				6-99
	metryczny z podkładką				6-100
wkręt z kołnierzem walcowym	zestaw do połączeń konstrukcyjnych M z sześciokątną nakrętką				1-95
Sześciokątny łeb	wkręt metryczny z gniazdem sześciokątkowym				6-43
Szpilka	do zgrzewania				10-130
Szybkiego montażu	nakrętka				3-120
Szyna	ceownik Fischer				10-40
Tablice rejestracyjne	wkręt z łbem z wgłębieniem krzyżowym				6-107, 6-108
Tablice rejestracyjne	wkręt z nacięciem prostym				6-109
Talerzowa	blokująca				7-93, 7-94
	rekojęść				12-81
	metryczna przelotowa				12-81, 12-82
	metryczna z gwintową końcówką				12-81, 12-82
	metryczna z gwintową tuleją				12-81, 12-82
	sprężyna				7-87, 7-88
	do napinania łożysk kulkowych				7-92
	do zastosowań krytycznych				7-83/7-85, 7-92
Talerzowy	podwójny łącznik Fischer				10-53, 10-54
TAPTITE 2000®	stożkowy łeb śruba metryczna samogwintująca				6-64
	sześciokątna śruba z kołnierzem				6-63
	walcowy soczewkowy łeb				6-65
Techniczna	kula				12-111/12-114
	wciskany zacisk				12-131
T-kształtny łeb	śruba Fischer				10-42, 10-45

Tolerancja kompensatory					10-86
Transportowa skrzynia Fischer					11-27
Transportowy łącznik Amecoil					3-158
Trapezowa okrągła nakrętka					4-26
Trójkąt ścienny dystansowy					13-79
Trójkątny rękojeść gwintową końcówką					12-82
gwiazdowy					
					12-82, 12-83
Trzonek długi mocowanie Fischer					8-31, 8-32
Trzonek nitonakrętka mini kolnierz stożkowy sześciokątny					3-135, 3-136
Trzpień do odla-mywania końcówek Amecoil					3-159
Trzyczęściowy zacisk					10-86
Ttap® kolnierzowy wkręt do leb drewna MaxxFast					6-177
			timber	MaxxFast	6-177
leb stożkowy wkręt płaski			z gniazdem krzyżowym	samowier-cący	6-134, 6-135, 6-141
stożkowy wkręt płaski leb			MaxxFast		6-151, 6-152, 6-164, 6-176
walcowy leb wkręt			samowier-cący	MaxxFast	6-126, 6-127
walcowy soczewkowy leb woodscrew			MaxxFast		6-167, 6-168
T-terminal					13-47
Tuleja do zaciskania gwoździowa Fischer					13-61, 8-26
Tulejka izolacyjna Vemo					12-73, 12-146, 12-147, 8-95
Tulejkowa kotwa akcesoria Fischer					8-87
Tulejowa kotwa nakrętka metryczna					8-48, 10-101
Typ D szekła					13-5/13-7, 13-10, 13-11
Ty-Rap zaciskowa opaska do kabli opaska					12-122, 12-123
U					
Ucho do podnoszenia śruba BSW					5-9
					5-8, 5-9
Uchwyt do haka kablowy					13-128, 12-134
kulowy metryczna z otworem stożkowym					12-77
pięciogar-bowy metryczny					12-83
radelkowana metryczna z gwintową końcówką					12-85, 12-86
metryczna z gwintową tuleją					12-86
skrzydełkowy metryczny					12-87
w kształcie t M z cynkowaną gwintową końcówką					12-89
M z mosiężną tuleją gwintową					12-89
Uchwyt płaski polerowany					13-134, 13-135
Uchylnie mocowania Fischer					8-25
Ucinaki do lin					13-56
Umożli-wiająca podnoszenie napinająca dźwignia					12-98
					12-99
					12-98
					12-98
					12-98

zaciskowa dźwignia	możliwość podnoszenia				12-101, 12-102
					12-102
UNC dociskowy wkręt	płaski koniec z gniazdem sześciokątnym				2-77, 2-82, 2-85, 2-88, 2-91
	wglębiony koniec z gniazdem sześciokątnym				2-74
grzybkowy leb	śruba				1-77/1-79
					2-57
gwintowany pręt					4-15/4-17
				ASTM A193	4-35
kwadratowy leb	sworzeń z czopem krótkim				1-85
maszynowo nacinana nakrętka					3-23
maszynowy gwintownik	do wkładki gwintowej z drutu Amecoil				3-145
naprawczy zestaw przeciwnakrętka				Amecoil	3-151, 3-40
śruba dwustronna	z 2 sześciokątnymi nakrętkami				4-40/4-42, 4-45, 4-47, 4-50, 4-51, 4-53
stopniowany trzpień	śruba pasowana				2-67
					2-67
					2-67
stożkowy leb	wkręt Torx® samowier-cący				6-144
stożkowy leb	śruba z gniazdem sześciokar-bowym			samogwintu-jące	6-61
					2-46, 2-47
sześciokątna kolnierzowa nakrętka	kolnierzowa nakrętka			samozabezpieczająca	3-80
					3-21, 3-22, 3-57
				ASTM A194	4-57/4-59
				stalowa samozabez-pieczająca	3-68, 3-69
				z wkładką samozabez-niemetaliczną pieczająca	3-55/3-57, 3-59/3-61
				śruba	1-42/1-44, 1-46, 1-47, 1-49, 1-50
walcowy leb	śruba				2-26
					2-21/2-23, 2-25, 2-27
wkładka	gwintowa z drutu Amecoil				3-148
UNF dociskowy wkręt	płaski koniec z gniazdem sześciokątnym				2-76, 2-78
grzybkowy leb	śruba z gniazdem sześciokątnym				2-58, 2-59
gwintowany pręt					4-18, 4-19
koronowa nakrętka					3-92
maszynowo nacinana nakrętka					3-26
maszynowy gwintownik	do wkładki gwintowej z drutu Amecoil				3-145
naprawczy zestaw stopa ogniwa gęsienicy	zestaw nakrętka kwadratowe			Amecoil	3-152, 3-42
				niska	3-42
				wysoka	3-41
stożkowy leb	śruba z gniazdem sześciokątnym				2-49, 2-50

Index alfabetyczny

UNF	sześciokątna nakrętka		3-24, 3-25, 3-58	
	stalowa	samozabezpieczająca	3-70	
	z wkładką	samozabezpieczająca	3-58, 3-59, 3-61, 3-62	
	niemetaliczną	pieczająca		
	śruba		1-53, 1-54, 1-56, 1-57	
	walcowy łeb	śruba z gniazdem sześciokątnym	2-29/2-31	
	wkładka	gwintowa z Amecoil drutu	3-149	
Uniwersalna	klamra do belek	uniwersalne	10-56	
Uniwersalny	kołek	uniwersalne Fischer	8-14	
	ściągnacz	wahliwy	13-69	
USS	okrągła	podkładka	7-10	
Ustalająca podkładka	bez zaślepki do wałków		7-131, 7-132	
	narzędzie		7-130	
	uchwyt		7-129	
	uchwyt, magnetyczny		7-130	
	z zaślepką	do wałków	7-128	
	z zaślepką stożkowe	do wałków	7-129	
Ustalający kołek	poprzeczny	M z nacięciem prostym	10-97	
Ustalający pierścień	system szybkiego montażu		10-79	
Uszczelniająca	podkładka		7-152	
	z gumą		6-117, 7-151	
Uszczelniający pierścień	pierścień		7-147/7-149	
	FESTAPLAN		7-149, 7-150	
	podkładka	fibrowe	7-150	
	z elastomerem uszczelniającym		6-116	
Uszczelniający pierścień	system szybkiego montażu		12-115	
Uszczelnianie wciskane	nasadki		10-80	
	nie wciskane		12-40	
V				
V-Coil	narzędzia do wkładek gwintowanych		3-166/3-170	
	zestaw	metryczny	3-163, 3-164	
		niemetryczny	3-164, 3-165	
	zestaw naprawczy do gwintów	do świec zapłonowych		3-162
		metryczna		3-160
		metryczna		3-160
		zestaw	niemetryczny	3-161, 3-162
Vemo	do betonu		8-96, 8-97	
		wkładka z płytką do wbijania gwoździ	8-96, 8-98	
	do rur	korek	8-99	
	łączyca tulejka	łączyca	8-95	
	tulejka		8-95	
W				
W kasetach stalowych	zestaw akcesoria		11-25	
	szafka z szufladami		11-24	
	kasetka typ S		11-24	
	zestawy stalowa		11-15	

	MaxxFast		11-23	
W kształcie litery S	hak		5-42	
W kształcie t uchwyt	M z cynkowaną gwintową końcówką		12-89	
	M z mosiężną tuleją gwintową		12-89	
W plastikowych kasetach	zestawy		11-4	
W walizce ręczna	nitownica	do nitonakrętek	3-141	
Wachlarzowa ząbkowana	podkładka zabezpieczająca		7-68, 7-72/7-74, 7-77/7-81	
	podkładka zabezpieczająca		7-70, 7-71, 7-75, 7-76	
Wachlarzowa ząbkowana podkładka	wypukła		7-67	
Walcowe	zamocowanie metryczne		12-62/12-65	
Walcowy kołek	karbowany kołek		9-17, 9-18	
	z prowadzeniem		9-13	
	kołek		9-6, 9-7, 9-9, 9-10	
	z gwintem wewnętrznym		9-12	
	wpust		9-47, 9-48	
Walcowy czop	dociskowy	metryczny	2-87	
	metryczny z gniazdem sześciokątnym		2-86, 2-87, 2-89	
Walcowy kołek	sprężysty		9-24/9-26, 9-28/9-30	
Walcowy leb	kwadratowym gniazdem	z kwadratowym gniazdem	MaxxFast	6-128
		śruba BSW	z gniazdem sześciokątnym	2-32
	drobnozwojna z gniazdem sześciokątnym			2-20
	metryczna			2-18, 2-19
	metryczna z 2 otworami			10-114
	metryczna z gniazdem sześciokarbowym			2-16, 2-17
	metryczna z gniazdem sześciokątnym			2-3/2-7, 2-9, 2-10, 2-12, 2-14, 2-15
	metryczna z gwintem na całej długości			2-17/2-19
	metryczny z wgłębieniem krzyżowym			6-79/6-83
	do tarasów			6-82
	z końcem płaskim			6-83
	samonacinające			10-120
UNC	z gniazdem sześciokątnym		2-26	
	z gniazdem sześciokątnym		2-21/2-23, 2-25, 2-27	
UNF	z gniazdem sześciokątnym		2-29/2-31	
	z gniazdem krzyżowym	samowiercący	6-122/6-124	
śruba z kołnierzem stożkowym	metryczny z gniazdem sześciokątnym	samozabezpieczająca	Ripp	2-63
ttap®	wkręt	samowiercący	MaxxFast	6-126, 6-127
	do tworzyw sztucznych			6-72
	M z nacięciem prostym z trzpieniem walcowym		6-34	
	metryczny		10-115	
	metryczne z łbem pomniejszonym		6-19	
	metryczne z łbem powiększonym		6-20	
	metryczny		6-101	

Walcowy łeb wkręt	metryczny z nacięciem prostym		6-16/6-18 , 6-73 , 6-74	
	z końcem płaskim		6-74	
	samonacinające		10-120	
	z 2 otworami		10-121	
	samowiercący z kwadratowym gniazdem		6-130	
włębienie krzyżowe	samowiercący	MaxxFast	6-119 , 6-120	
	z gniazdem samowiercący SR		6-129	
wkręt do drewna	z gniazdem sześciokarbowym		6-171	
wkręt samogwintujący	metryczny z gniazdem sześciokarbowym		6-84 , 6-85	
Walcowy niski łeb	śruba	metryczna z gniazdem sześciokątnym	2-33/2-35 , 2-37 , 2-38	
Walcowy płaski łeb	nakrętka	z gniazdem sześciokątnym	10-94	
	śruba	z gniazdem sześciokątnym	10-96	
	wkręt	metryczny z nacięciem prostym	6-11/6-15	
Walcowy soczewkowy łeb	śruba	M z gniazdem krzyżowym	6-57	
		M z łbem pomniejszonym	6-67	
		M z łbem walcowym	6-66	
	metryczny krzyżowy gniazdo	samogwintujące	REMFORM®	6-70
		samogwintujące	REMFORM®	6-71
	TAPTITE 2000®			6-65
		ttap®	woodscrew MaxxFast	6-167 , 6-168
wkręt	metryczny z gniazdem sześciokarbowym		6-41 , 6-42	
	metryczny z włębieniem krzyżowym		6-36/6-40	
	samonacina- z 2 otworami		10-126	
wkręt do drewna	włębienie krzyżowe	MaxxFast	6-166	
	z gniazdem krzyżowym		6-169	
wkręty do płyt wiórowych		Heco-Fix	6-169	
	z gniazdem sześciokarbowym		6-170	
Wbijana	kotwa	Fischer	8-52	
		MaxxFast	8-50 , 8-51	
		Spit	8-25	
	kulkowa ciśnieniowa smarownicza	metryczna	12-43	
	nakrętka	metryczna do drewna	10-90	
wkładka	z walcowym kołnierzem	10-92		
zaślepka kwadratowa	GMT	12-69		
Wbijany	kolek	Fischer	8-28 , 8-29	
		z podkładką Fischer izolacyjną	8-30	
	nit		12-136	
Wciskana	nakrętka	metryczna Kalei	3-94 , 3-95	
Wciskany	nit		12-139	
	zacisk		12-131	
Wewnętrznie chemiczna gwintowana	kotwa	Fischer	8-88	

Włębiony koniec	dociskowy wkręt	BSW	z gniazdem sześciokątnym	2-90	
		M	z nacięciem prostym	6-8	
		metryczny	drobnozwojny gniazdo sześciokątne	2-72	
		metryczny	gniazdo sześciokątne	2-76	
		metryczny	z gniazdem sześciokątnym	2-70 , 2-71	
UNC	z gniazdem sześciokątnym		2-74		
Widelkowa	końcówka	do zawalcowania		13-48 , 13-49	
Widelkowy	przegub	z kołkiem sprężynującym	lewy gwint	12-50	
		ze sprężynującym kołkiem		12-50	
Wielokrotny	łącnik			12-52	
Wielowymiarowe	ręczne narzędzie montażowe	metryczne	Amecoil	3-154	
		metryczne kompletne	Amecoil	3-155 , 3-156	
		metryczne z końcówką wylotową	Amecoil	3-155	
Wielozwojowy	hak elastyczny			13-123	
Wieszak	na opaski	zestaw	MaxxFast	12-21	
		zestaw	ABA	12-22	
Wkładka				10-87 , 10-88	
	do betonu	Vemo		8-96 , 8-97	
		z płytką do wbijania gwoździ	Vemo		8-96 , 8-98
	gwintowa	Jacknut			3-121
		samonacinająca			3-172/3-174
			z gniazdem sześciokątnym		3-174 , 3-175
	gwintowa z drutu	MEF	Amecoil		3-148
		MEF do korpusów świec zapłonowych	Amecoil		3-148
		metryczna	Amecoil		3-146
		metryczna	Amecoil		3-147
	metryczna drobnozwojna	Amecoil		3-146	
	metryczna samozabezpieczająca	Amecoil		3-148	
	UNC	Amecoil		3-148	
	UNF	Amecoil		3-149	
gwintowana	z gniazdem sześciokątnym			10-90 , 10-91	
	z nacięciem prostym			10-91	
wbijana	z walcowym kołnierzem			10-92	
wkręcana				10-89	
	z gniazdem sześciokątnym			10-92	
Wkłęsa	kulkowa ciśnieniowa smarownicza	metryczna		12-43	
Wkłęsa podkładka	podkładka	do śrub talerzowych		1-83	
Wkręcana	wkładka			10-89	
		z gniazdem sześciokątnym		10-92	
Wkręcany	hak			13-118	
	nit			12-137	
Wkręt	do płyt gipsowo-kartonowych	z gniazdem krzyżowym		6-198	

Index alfabetyczny

Wkręt	do tarasów	z gniazdem sześciokarbowym		6-165	
	do tylnej płyty	z gniazdem krzyżowym		6-139	
	dwugwintowy			13-76	
grzybkowy leń	gniazdo SR	samowiercący		6-140	
		metryczny z nacięciem prostym		6-32, 6-33	
		metryczny z wgłębieniem krzyżowym		6-55, 6-56	
		metryczny z zaślepką		10-112	
		samonacinające		10-118, 10-119	
konfirmat	z gniazdem sześciokątnym			10-97	
leń stożkowy	metryczny do tworzyw			6-72	
leń stożkowy	metryczna			10-115/10-117	
płaski	metryczny			6-50	
	metryczny z gniazdem sześciokarbowym			6-49	
	samonacinające			10-123, 10-124, 10-126	
	tmap®	z gniazdem krzyżowym	samowiercący	6-134, 6-135, 6-141	
	wgłębienie krzyżowe	samowiercący	MaxxFast	6-131	
	okienne	ościeżnica	Fischer		8-39
		MaxxFast		8-38	
owalny leń stożkowy	samonacina- one way	jące		10-127	
płaski	phillips	metryczna		6-33	
stożkowo soczewkowy leń	metryczny z nacięciem prostym			6-28/6-30	
stożkowy leń	Torx®	samowiercący		6-143	
	UNC	Torx®	samowiercący	6-144	
stożkowy leń	metryczny z nacięciem prostym			6-22, 6-23, 6-25, 6-26	
	z gniazdem krzyżowym	samowiercący		6-132, 6-133	
	ze skrzydełkami i sześciokarbowym gniazdem	samowiercący		6-142	
stożkowy płaski leń	tmap®	MaxxFast		6-151, 6-152, 6-164, 6-176	
stożkowy soczewkowy leń	metryczny			6-102, 6-103	
	metryczny z gniazdem sześciokarbowym			6-54, 6-55	
	metryczny z nacięciem prostym			6-77	
	metryczny z wgłębieniem krzyżowym			6-51/6-53	
sześciokątny leń	metryczny z gniazdem sześciokarbowym			6-43	
tablice rejestracyjne	z nacięciem prostym			6-109	
walcowy leń	do tworzyw sztucznych			6-72	
	M z nacięciem prostym walcowym			6-34	
	metryczna			10-115	
	metryczna z łbem pomniejszonym			6-19	
	metryczna z łbem powiększonym			6-20	
	metryczny			6-101	
	metryczny z nacięciem prostym			6-16/6-18, 6-73, 6-74	
		z końcem płaskim			6-74
	samonacinające			10-120	
		z 2 otworami			10-121
		samowiercący	z kwadratowym gniazdem		6-130
	tmap®	samowiercący	MaxxFast		6-126, 6-127
wgłębienie krzyżowe	samowiercący	MaxxFast		6-119, 6-120	
z gniazdem SR	samowiercący			6-129	
walcowy płaski leń	metryczny z nacięciem prostym			6-11/6-15	
walcowy soczewkowy leń	metryczny z gniazdem sześciokarbowym			6-41, 6-42	
	metryczny z wgłębieniem krzyżowym			6-36/6-40	
	samonacina- z 2 otworami	jące		10-126	
	zaśleпка leń	metryczny Torx®		6-109	
Wkręt do drewna	kolnierzowy leń	tmap®	MaxxFast	6-177	
		timber	MaxxFast	6-177	
kulisty leń	z gniazdem krzyżowym			6-189, 6-190	
	z nacięciem prostym			6-183, 6-184	
leń stożkowy płaski	z gniazdem krzyżowym			6-188/6-190	
leń stożkowy ścięty	z gniazdem krzyżowym			6-193, 6-194	
	z gniazdem sześciokarbowym			6-195/6-197	
owalny leń stożkowy płaski	z gniazdem krzyżowym			6-191, 6-192	
stożkowy leń	z gniazdem krzyżowym			6-187	
	z nacięciem prostym			6-180, 6-181	
stożkowy leń	z gniazdem sześciokarbowym	Heco-Topix		6-164	
stożkowy płaski leń	wgłębienie krzyżowe	MaxxFast		6-149, 6-150	
stożkowy soczewkowy leń	z nacięciem prostym			6-186	
sześciokątny				6-174	
	z podkładką bitumiczną			6-176	
	z podkładką nierdzewną ołowiowo-bitumiczną			6-174, 6-175	
walcowy leń	z gniazdem sześciokarbowym			6-171	
walcowy soczewkowy leń	wgłębienie krzyżowe	MaxxFast		6-166	
Wkręt gwint żebrowany	do elewacji			6-115	
Wkręt huśtawkowo-gimnastyczny	bezpieczeństwo	metryczny		5-41	
		niemetryczny		5-40	
Wkręt samogwintujący	grzybkowy leń	metryczny z gniazdem krzyżowym		6-103	
stożkowy leń	metryczny z gniazdem krzyżowym			6-87/6-90	
	metryczny z gniazdem sześciokarbowym			6-92	
	metryczny z nacięciem prostym			6-75, 6-76	
sześciokątny				6-100	
	metryczny			6-98, 6-99	
	metryczny z końcem płaskim			6-99	
	metryczny z podkładką			6-100	
walcowy leń	metryczny z gniazdem sześciokarbowym			6-84, 6-85	

Wkręt z kolnierzem walcowym	sześciokątny samowiercący		6-137 , 6-138
Wkręt z podkładką	do okien	kolor biały	6-104/6-106
		kolor brązowy	6-104/6-106
		kolor naturalny	6-104/6-106
Wkrętak	elastyczny	do opasek	ABA 12-23 MaxxFast 12-23
Wkręty	dachowe i ścienne	z elastomerem uszczelniającym	6-112
		SFS-Topform	6-111
		z końcem płaskim	SFS-Topform 6-112
		z elastomeru końcówką wiertła	6-115
	do dachu i elewacji	końiec płaski	6-112
		końiec stożkowy	6-113
Wkręty do drewna	leb stożkowy płaski	z gniazdem sześciokarbowym	6-178 , 6-179
		z łbem stożkowym	6-163
Wkręty do płyt wiórowych	stożkowy	Sześciokarbowy	6-161
		z gniazdem sześciokarbowym	6-160 , 6-161
		Heco-Topix	6-160 , 6-162
		Heco-Unix Top	6-160
	stożkowy leb	z gniazdem krzyżowym	6-154/6-156
		Heco-Fix	6-155
		Heco-Topix	6-157
		Heco-Unix Plus	6-157
		hole	6-158
		leb pomniejszony	6-159
	stożkowy soczewkowy leb	z gniazdem krzyżowym	6-172
		Heco-Fix	6-172
	walcowy soczewkowy leb	z gniazdem krzyżowym	6-169
		Heco-Fix	6-169
		z gniazdem sześciokarbowym	6-170
Wkręty samogwintu-jące	z łbem walcowym wypukłym z gniazdem kwadratowym	metryczny z gniazdem kwadratowym	6-86
Wnętkowe	mocowanie	Fischer	8-15
		MaxxFast	8-14
	narzędzie	Fischer	8-16
		MaxxFast	8-16
Woodscrew	walcowy soczewkowy leb	ttape® MaxxFast	6-167 , 6-168
Wprowadzana od przodu	oprawka		10-85
Wpust	czólenkowy		9-50 , 9-51
	metryczny prostokątny		9-49
	walcowy		9-47 , 9-48
	zbieżny wpust		9-51
Wspornik			13-122 , 13-123
	instalacyjny kątowy	Fischer	10-45
	kątowy	Fischer	10-46
	ramię	Fischer	10-41
	sprężynujący		10-84

	zacisk	Fischer		10-51
Wtryskowe	narzędzie	Fischer		8-85
		MaxxFast		8-85
Wtyczka	security	wewnętrzna		10-129
Wyciągacz	Amecoil			3-159
Wygięta	nakrętka			3-107
	szekła			13-9
		ze śrubą z kolnierzem walcowym i przetyczką		5-22 , 5-23
Wymienne wkładki	zaciskarka ręczna			13-62
Wypukła	nakrętka	metryczna niska		3-101 , 3-102
		wysoka		3-97/3-99
		z przyspawaną zaślepką		3-100
		wachlarzowa ząbkowana podkładka		7-67
Wypukły leb	nit zrywalny			9-55/9-59 , 9-68 , 9-69
		rozprężny		9-78
Wysoka	kołpakowa nakrętka	BSW		3-99
	rafeelkowana nakrętka	metryczna		3-113
	rękojeść	metryczna do śrub, wkrętów i nakrętek z łbem sześciokątnym		12-84
	śruba	metryczna		6-204 , 6-205
		metryczna z nacięciem prostym		6-205
	stopa ogniwa gęśienicy	nakrętka UNF		3-41
	wypukła nakrętka	metryczna		3-97/3-99
Wysokie tarcie	zacisk	Lindapter		10-28
Wysokiej wytrzymałości	kotwa	metryczna Fischer		8-73 , 8-75
		MaxxFast		8-70
Z				
Z drutu	pierścień			13-68
Z gniazdem	korek	drobnozwojny z gniazdem sześciokątnym		2-92 , 2-94
		gwint rurowy z walcowym kolnierzem		2-95
		gwint rurowy z gniazdem zewnętrznym, sześciokątnym stożkowy		2-93
Z gniazdem sześciokątnym	konfirmat	wkręt		10-97
Z gumą	zacisk	z gumą	MaxxFast	12-19
Z gwintem	zacisk linowy			13-78
	zawias	odlewany		13-102 , 13-103
Z gwintem wewnętrznym	kula masywna			13-78 , 13-79
Z gwoździem	pierścień			13-133
Z końcem płaskim	dachowe i ścienne	wkręty z elastomerem uszczelniającym	SFS-Topform	6-112
	walcowy leb	śruba	metryczny z wgłębieniem krzyżowym	6-83
		wkręt	metryczny z nacięciem prostym	6-74
Z krawędzią zabezpieczającą	podkładka			7-66
Z krętlikiem	hak zatraskowy			13-23 , 13-24
Z łbem	końcówka	do ściągaczy linowych		13-75
Z łbem 6-kątnym	korek	drobnozwojny z walcowym kolnierzem		2-96
		gwint rurowy zewnętrzny, stożkowy		2-98

Index alfabetyczny

Z łbem 6-kątnym	korrek	z walcowym kołnierzem		2-97, 2-98
Z łbem skrzydełkowym	sworzeń	z łbem skrzydełkowym		10-76
Z łbem stożkowym	wkręty do drewna	z gniazdem sześciokarbowym		6-163
Z łbem walcowym wypukłym z gniazdem kwadratowym	wkręty samogwintujące	metryczny z gniazdem kwadratowym		6-86
Z możliwością luzowania	zaciskowa opaska	możliwość luzowania	MaxxFast	12-126
Z możliwością obrotu	rączka	metryczna obrotowa		12-94, 12-95
Z pierścieniem	zawlecza			9-45
Z podszewką	grzybkowy łeb	śruba	metryczne z sześciokątną nakrętką	1-82
Z rowkiem	dociskowy wkręt	M z nacięciem prostym		6-9
	sworzeń	z nacięciem prostym		10-76
Z trzpieniem	końcówka wylotowa	metryczna	Amecoil	3-156/3-158
Z uchem	nakrętka			3-107
		metryczna		5-11, 5-12
		metryczna z oznaczeniem CE		5-11
Z zaślepką	ustalająca podkładka	do wałków		7-128
Z zaślepką stożkową	ustalająca podkładka	do wałków		7-129
Zabezpieczająca	lina			13-66
	podkładka			12-144
	śruba	metryczna drobnozwojna		12-61
		MF bez blokującego rowka		12-60
		MF z rowkiem blokującym		12-60
		sześciokątna śruba		10-128
		z krawędzią podkładka		7-66
Zabezpieczająca podkładka	system szybkiego montażu			10-78
Ząbkowane zewnętrznie	stożkowe podkładki	niemetryczne		7-69
Ząbkowany	kołnierzy pierścień	Dubo		7-112
Zacisk				7-132
	ABA			12-21
	belka	Fischer		10-48
	chłodniczy	do przewodów rurowych	Fischer	10-39
	ciągi kablowe			10-60
	czołowy	Lindapter		10-33
	do lin			13-35, 13-59
	do mocowania poręczy	Lindapter		10-31
	do rur wydechowych	Awab		12-24
	dwuoczkowy	ABA		12-17
	grating	Lindapter		10-35
	hakowy	przegubowy	AMF	12-160
	high slip resistance	Lindapter		10-24
	jednooczkowy	ABA		12-16
	Norma			12-117, 12-118
	pionowy	przegubowy	AMF	12-152, 12-153
	poziomy	przegubowy	AMF	12-154/12-156
	przeciwsobny	przegubowy	AMF	12-157/12-159
	rurowy			12-25
		obie części	Fischer	10-38
	samoregulacyjny	Lindapter		10-29
	stalowa lina			5-24, 5-25
	stopa belki	Lindapter		10-32
		ze śrubą dociskową i nakrętką	Lindapter	10-32
	trzyczęściowy			10-86
	wciskany	tie		12-131
	wspornik	Fischer		10-51
	wysokie tarcie	Lindapter		10-28
	z gumą	ABA		12-20
		MaxxFast		12-19
	zatrzaskowy			10-59
	zawiasowy	rurowy	Fischer	10-37
Zacisk linowy	z gwintem			13-78
Zacisk z końcówką	regulowany	Lindapter		10-30
Zaciskarka ręczna	wymienne wkładki			13-62
Zacisków	system	Band-It		12-26/12-28
Zaciskowa	do kabli	opaska	samoprzylepny	12-132, 12-133
			z podstawą do mocowania	12-127
			zestaw	12-123
Zaciskowa dźwignia	liftable	metryczna		12-99, 12-100
		umożliwiająca podnoszenie		12-101, 12-102
		z gwintową końcówką		12-102
		metryczna mocna		12-103, 12-104
Zaciskowa opaska	do kabli	opaska		12-121
			MaxxFast	12-120/12-122
			mocowanie	12-129
			MaxxFast	12-128
			Ty-Rap	12-122, 12-123
	opaska	z okiem		12-124
		z tabliczką opisową		12-125
	z możliwością luzowania	możliwość luzowania	MaxxFast	12-126
Zaciskowa węża	opaska	mocna	ABA	12-15
Zaciskowe łącze	regulowane	oddzielnie		12-53
Zaciskowy	osadczy	pierścień		7-133, 7-134
Zaczep				10-65
Zakręcany	karabińczyk			13-137
Zamknięcie				10-68
	ryglowe			13-106
Zamocowanie	walcowe	metryczne		12-62/12-65
Zamykająca	zaślepka			12-41
Zapadka	zatrzaskowa	akcesoria		10-73
Zapadka (1&3)				10-70, 10-71
Zapadka zamykająca	przewodzenie	zapadki		10-74
Zapadkowy	nit			12-138

Z

Zaślepiający korek				12-116
Zaślepka	do śrub z gniazdem sześciokątnym			2-91
	do wkrętów do łba wkrętu z gniazdem krzyżowym do płyt wiórowych			6-201
	do wkrętów z gniazdem			6-200
	do wkrętu do drewna z łbem sześciokątnym			6-201
ochronna	do śrub, wkrętów i nakrętek z łbem sześciokątnym			1-98, 1-99
	korek			12-151
prostokątną	Fischer			10-42
przykrywająca				6-110
rurowa	kwadratowa			10-106
	okrągła			10-105
	prostokątna			10-106
	stożkowa			10-107
	zamykająca			12-41
	zatrzaskowa			6-202
Zaślepka kwadratowa	wbijana	GMT		12-69
Zaślepka łeb śruba	z wgłębieniem krzyżowym			6-108
	wkręt	metryczny Torx®		6-109
Zasuwa				13-109, 13-110
Zatrząsk	blokada drzwi			13-127, 13-128
	hak			5-26
	przegubowy			10-63
Zatrząski	ryglowe			13-107, 13-108
Zatrząskowa	szekła			13-26, 13-27
	zapadka	akcesoria		10-73
	zaślepka			6-202
Zatrząskowy	hak			13-31
	zacisk			10-59
Zawias				12-55, 13-82, 13-83, 13-85/13-97
	ciągły			13-105
	do zgrzewania			12-54
	kryty			13-104, 13-105
	odlewany			13-99, 13-100
	z gwintem	odlewany		13-102, 13-103
Zawiasowy	rurowy	zacisk	Fischer	10-37
Zawlecza				9-37/9-40
	części zapasowe			3-177
	do rur			9-44
	pojedyncza			13-67
	przetyczka	podwójna		9-42, 9-43
	do śrub			
	sprężysta	pojedyncza		9-41
	przetyczka			
	do śrub			
	z pierścieniem			9-45
Zbieżny	karbowany			9-16
	kolek			9-14, 9-15, 9-19
Zbieżny	wpust			9-51
wpust				
Zestaw	kaseta	kolki do ścian	Fischer	8-8
	metryczny	V-Coil		3-163, 3-164
	naprawczy	Amecoil		3-153
		bardzo drobno- nozwojny	Amecoil	3-150, 3-151
		BSW	Amecoil	3-152
		metryczny	Amecoil	3-149
		metryczny	Amecoil	3-150
		drobno- wojny		

	UNC	Amecoil		3-151
	UNF	Amecoil		3-152
niemetryczny	V-Coil			3-164, 3-165
w kasetach	akcesoria			11-25
stalowych		szafka z szufladami		11-24
		kaseta typ S		11-24
zaciskowa	do kabli	opaska		12-123
Zestaw do połączeń konstrukcyjnych	sześciokątna metryczna z sześciokątną nakrętką			1-97
	sześciokątny M z sześciokątną nakrętką			1-95
Zestaw naprawczy do gwintów	do świec metryczna	V-Coil		3-160
	zapłonowych			
		V-Coil		3-162
	metryczna	V-Coil		3-160
Zestaw naprawczy do gwintów świec	niemetryczny V-Coil			3-161, 3-162
Zestaw w walizce	nitownica	ręczna		9-80
Zestawy	śruby młoteczkowe	do rowków teowych		10-14
	w kasetach stalowych	stalowa		11-15
		MaxxFast		11-23
	w plastikowych kasetach	plastikowe		11-4
Zgrzewany	pierścień	do haka huśtawkowo-gimnastycznego		5-41
Zrywalna	nakrętka	metryczna		10-110
Żywiczna	masa	Fischer		8-84
		MaxxFast		8-83

Index norm

ASME					
		- / 4168-5	7-134	1480	5-14, 5-15
B16.5	4-39	≈4168-6	2-51, 2-54	≈1480	5-15/5-19
B18.16.6	3-55, 3-57/3-61	≈4168-7	2-64, 2-68	1481	9-26
≈B18.17	3-103	4168-8	2-39	≈1481	9-29
≈B18.2.1	1-41, 1-52	≈4168-8	2-39	15237	1-82, 1-83
B18.2.2	4-57	4174	6-73, 6-75, 6-76, 6-98	1587 (1987)	3-97
≈B18.2.2	3-20, 3-23, 3-26, 3-40	4183	6-10, 6-16, 6-21, 6-28	≈1587 (1987)	3-97
B18.2.3.1M	1-2, 1-19	≈4183	6-10, 6-16, 6-21	1804 W	3-122
≈B18.2.3.1M	1-2, 1-19, 1-35	4219	6-6	186 B	5-2
≈B18.2.3.4M	1-66/1-68, 1-70	4235-1	9-46, 9-51	2093	7-85
B18.2.4.5M	3-32, 3-35	4235-2	9-50	2093 A	7-82
B18.21.1	7-9, 7-12, 7-52, 7-55, 7-56, 7-59, 7-69, 7-70, 7-74, 7-76	4278	5-7	≈2093 A/C	7-88
		4464 A	7-57	2093 B	7-83
		≈4464 A	7-57	2093 C	7-84
≈B18.21.1	7-36, 7-37, 7-46	4464 B	7-49	2095	12-74
B18.3	2-66	≈4464 B	7-49	2097	12-75
≈B18.3 (1936)	2-22, 2-28	≈450 (1958)	6-27, 6-31	2510 L/NF	4-61
≈B18.3 (1960)	2-21	4620	9-31, 9-33	2510 NF	4-62
B18.3.1M	2-2, 2-20	4882	4-39	≈313 (1956)	3-106
≈B18.3.1M	2-2, 2-17	≈4882	4-55	315	3-104
≈B18.3.3M	2-64, 2-68	4929-1	3-65	316	6-209
≈B18.3.4M	2-51, 2-54	4933	1-72	≈319 C	12-76
B18.3.6M	2-69, 2-78, 2-83, 2-86	4933/-	1-75, 1-81, 1-82	≈319 E	12-76
≈B18.3.6M	2-72, 2-76, 2-81	≈4933	1-80	≈319 M	12-77
B18.31.3	4-14, 4-17	7060	9-26	≈3404 A	12-44, 12-46
≈B18.3	2-45, 2-48, 2-73, 2-75, 2-77, 2-78, 2-82, 2-85, 2-88, 2-90	≈7060	9-29	≈3405 A	12-43
		≈7599	6-100	388-1C	12-104
B18.5.2.3M	1-72	DIN		404	6-33
B18.5.2.3M	1-77	≈580	5-7	417	6-9
B18.5.2.3M/-	1-75	≈582	5-10	427	6-8
B18.6.4	6-78	1 B	9-3	431 A	3-40
≈B18.6.4	6-84, 6-86	1052	7-43	432	7-117
B18.6.5M	6-98	11024	9-43	433	7-25
B18.6.7M	6-10, 6-16, 6-21, 6-28	≈11024	9-41, 9-42	≈433	7-25
≈B18.6.7M	6-10, 6-16, 6-21	125-1A	7-4	434	7-145
		125-1B	7-33	≈434	7-145
		126	7-11	435	7-143
		127 B	7-49	≈435	7-143
≈1083 (1965)	1-59, 1-61, 3-28	≈127 B	7-49	436	7-142
≈1768	1-41, 1-52, 3-20, 3-23, 3-92	128 A	7-64	43699	7-82
1769	4-57	≈128 A	7-64, 7-66	≈436	7-142
1804-2	9-5	137 A	7-63	438	6-7
2470	2-66	137 B	7-61	439 B (1987)	3-32, 3-35
≈2470	2-21, 2-32, 2-45, 2-48, 2-50, 2-73, 2-90	≈137 B	7-61	440 R	7-40
2485	10-4, 10-5	1434	9-35	≈440R	7-40
3673-2	7-125	1440	7-27	440V	7-42
3673-4	7-119, 7-122	1441	7-28	≈443	12-40
4168-1	2-2, 2-20	1470	9-13	444 B	5-4
≈4168-1	2-2, 2-17	1471	9-14	444 LB	5-6
4168-2	2-78	1472	9-15	462	7-116
≈4168-2	2-81	1473	9-17	463	7-114
4168-3	2-83	1474	9-18	464	6-204
4168-4	2-86	1475	9-20	464 Sz	6-205
4168-5	2-69	1476	9-21	466	3-113
≈4168-5	2-72, 2-76	1478	5-13	467	3-114
		≈1479	5-13	≈470	12-41
				471	7-119
				≈471	7-119
				472	7-122
				≈472	7-122
				479	1-84
				508	10-5
				529 A	8-89
				529 E	8-90
				≈5401	12-111
				546	3-123
				551	6-4
				553	6-6
				555 (1987)	3-31
				- / 555 (1987)	1-80
				557	3-117
				561	1-86
				562	3-116
				571	6-173
				≈571	6-173
				580	5-7
				≈580 (1957)	5-9
				582	5-10
				≈582 (1957)	5-12
				601/555 (1987)	1-18
				603	1-72
				603/555 (1987)	1-75
				≈603	1-74
				604/555 (1987)	1-81
				605/555 (1987)	1-82
				≈608	1-80
				609	1-71
				6319 C	10-9
				6319 D	10-9
				6325	9-8
				≈6325	9-9
				6330 B	10-6
				6331	10-7
				≈6331	10-7
				6334	3-43
				≈6336 K	12-78
				≈6336 L	12-78
				6340	10-11
				6379	10-12
				648 A	12-51
				648 B	12-50
				653	6-206
				660/124	9-31
				661/302	9-33
				6796	7-89
				6797 A	7-80
				6797 J	7-79
				≈6797 J	7-79
				≈6797A	7-80
				6798 A	7-77
				≈6798 A	7-77
				6798 J	7-73
				≈6798 J	7-73
				6798 V	7-68

6799	7-125	7971 C	6-73	917	3-101	IFI	
6880	9-49	7971 F	6-73	920	6-19	100/107	3-68, 3-69, 3-80
≈6880	9-49	7972 C	6-75	921	6-20		
6885 A	9-46	7973 C	6-76	923	6-34	ISO	
6887	9-51	7976 C	6-98	928	3-112	-8738	7-27
6888	9-50	7976 F	6-98	929	3-109	1051	9-31, 9-33
≈6900	6-35	7977	9-10	93	7-113	10512	3-52
6912	2-36	7978 A	9-11	931	1-2	10513	3-67
6917	1-93	7979 D	9-12	≈931 (1954)	1-58	10642	2-39
6918	1-93	7980	7-57	≈931	1-2	≈10642	2-39, 2-44
6921	1-66, 1-70	≈7980	7-57	933	1-19	≈10644	6-35
≈6921	1-67, 1-68	7981 C-H	6-78	≈933 (1954)	1-60	1207	6-10
6923 (1983)	3-76	≈7981 C	6-84, 6-86	≈933	1-19, 1-35	≈1207	6-10
≈6923	3-78	7981 C-Z	6-78	≈934 (1954)	3-27, 3-30	12240-4	12-50, 12-51
6926	3-81	7981 F-H	6-78	934 (1987)	3-5, 3-14	1234	9-36
≈6926	3-82	7982 C-H	6-87	≈934 (1987)	3-5, 3-29	13337	9-28
≈6928 C	6-100	≈7982 C	6-91, 6-93	935	3-88	14579	2-16
7	9-5	7982 C-Z	6-87	935-1	3-86	14580	6-43
705A/EN 27434	7-134	7983 C-H	6-94	936	3-38, 3-39	≈14581	6-49
≈705A/EN 27434	7-134	≈7983 C	6-102	937	3-90	14583	6-41
705A/ISO 4027	7-137	7983 C-Z	6-94	938	4-27	≈14584	6-54
(DIN 914)		7984	2-32	939	4-29	14585 C	6-84
≈705A/ISO 4027	7-134	7985-H	6-35	≈939 (1955)	4-33	14586 C	6-91
705A/ISO 4029	7-134	7985-Z	6-35	94	9-36	14587 C	6-102
≈71412 A/B/C	12-44/12-46	≈7985-Z	6-35	95	6-185	1479 C	6-98
≈71412	12-42	7989-1	7-22	950	12-105	1479 F	6-98
71752	12-49	7991	2-39	96	6-182	1481 C	6-73
71752 LH	12-49	≈7991	2-39, 2-44	960	1-36	1481 F	6-73
71802 CS	12-47	7993 A	7-126	961	1-39	1482 C	6-75
≈7337 A	9-68	7995-Z	6-190	963	6-21	1483 C	6-76
7343	9-23	7996-H	6-189	≈963	6-21	15480	6-137
≈7343	9-24	7996-Z	6-189	964	6-28	≈15480	6-135
7344	9-25	7997-Z	6-187	965-H	6-44	15481 H	6-122
7346	9-28	80701	3-107	≈965	6-44, 6-49	≈15481 H	6-119, 6-120
7349	7-23	80704	3-107	965-Z	6-44	≈15481	6-126/6-130
741/555 (1987)	5-24	808 D	12-49	966-H	6-51	15482 H	6-132
74361 C	7-61	808 E	12-48	≈966	6-54	≈15482 H	6-130
≈7500-1	6-64, 6-65	8140-1A	3-146, 3-147	966-Z	6-51	≈15482	6-134
≈7500	6-63	8140-1B	3-146	97	6-179	1580	6-16
7504 K	6-137	≈82101 A	5-19	976-1	4-12	≈1580	6-16
≈7504 K	6-135	835	4-34	976-1A	4-2	1617	3-101
7504 M-H	6-122	84	6-10	≈976-1	4-12	2009	6-21
≈7504 M-H	6-119, 6-120	≈84	6-10	979	3-89, 3-91	≈2009	6-21
≈7504 M	6-126/6-130	85	6-16	980V(1987)	3-65, 3-67	2010	6-28
7504 O-H	6-132	≈85	6-16	982	3-53	2338	9-5
≈7504 O-H	6-130	9021	7-38	≈982	3-53	2339 B	9-3
≈7504 O	6-134	906	2-92, 2-93	985 (1987)	3-48, 3-52	2342	2-83, 6-8
7513 A	6-60	908	2-94, 2-95	≈985 (1987)	3-48	299	10-4, 10-5
7516 AE-H	6-57	910	2-96, 2-97	986	3-102	3266	5-7
7516 DE-H	6-59	912	2-2, 2-20	988	7-137	3290	12-111
7516 EE-H	6-58	≈912	2-2, 2-17			3912	9-50
7603 A	7-146	913	2-78	EN		4014	1-2
7603 C	7-146	≈913	2-81	14399-4	1-89, 1-91	4014/4032	1-94
787	10-4	914	2-83	14399-6	1-92	≈4014	1-2
7965	10-91	915	2-86	15048	1-94, 1-96	4016/-	1-18
7967	3-84	916	2-69	≈1665	1-66/1-68, 1-70	4017	1-19
≈7967	3-84	≈916	2-72, 2-76			4017/4032	1-96

Index norm

≈4017	1-19, 1-35	8677/-	1-75	2252	6-185	≈2451	7-79
4026	2-78	≈8677	1-74	2253	6-187	2452	3-65, 3-67
≈4026	2-81	8734 A	9-8	2254	6-189	2453	7-77
4027	2-83	≈8734 A	9-9	2260	6-173	≈2453	7-77
4028	2-86	8735 A	9-12	2268	7-11	2454	7-73
4029	2-69	8736 A	9-11	2269 A	7-4	≈2454	7-73
≈4029	2-72, 2-76	8737	9-10	2269 B	7-33	2456	7-63
4032	3-17	8739	9-13	2270	7-25	2457	7-61
4035	3-39	8740	9-17	≈2270	7-25	≈2457	7-61
≈4126	1-67	8741	9-18	2272	7-145	2458	9-26
4161	3-76	8742	9-20	≈2272	7-145	≈2458	9-29
≈4161	3-78	8744	9-14	2273	7-143	2459	9-28
≈4162	1-66, 1-68, 1-70	8745	9-15	≈2273	7-143	2460	9-21
4762	2-2, 2-20	8746	9-21	2274	7-23	2462	9-10
≈4762	2-2, 2-17	8748	9-25	2275	7-40	2463	9-11
4766	6-4	8750	9-23	≈2275	7-40	2464	9-12
7040	3-48	≈8750	9-24	2276	7-38	2553	9-23
≈7040	3-48, 3-53	8752	9-26	2277	7-113	≈2553	9-24
7042	3-65	≈8752	9-29	2278	7-114	2554	9-25
7043	3-81	8765	1-36	2279	7-117	2601	9-13
7045-H	6-35	R 773	9-46	2281	9-5	2602	9-14
7045-Z	6-35	R 774	9-51	2282	9-8	2603	9-15
≈7045-Z	6-35			≈2282	9-9	2604	9-17
7046-1-H	6-44	NEN		2307	10-6	2605	9-18
≈7046-1	6-44	10 B	9-3	2308 C	10-9	2606	9-20
7046-1-Z	6-44	102/697	1-18	2308 D	10-9	303	1-72
7046-2-H	6-44	1197 B	7-49	2309	5-2	303/697	1-75
7046-2-Z	6-44	≈1197 B	7-49	2310 B	5-4, 5-6	5514	1-93
7047-H	6-51	1241	2-2, 2-20	≈2324 (1960)	3-106	5515	1-93
7047-Z	6-51	≈1241	2-2, 2-17	2328 A	8-89	697	3-31
7049 C-H	6-78	1486	6-7	2328 E	8-90	- / 697	1-80
≈7049 C	6-86	1487	6-4	2331	4-27	729	3-86, 3-88
7049 C-Z	6-78	1488	6-6	2332	4-29	≈964	5-19
7049 F-H	6-78	1555	1-2, 1-36	2334 B	3-32, 3-35		
7050 C-H	6-87	≈1555	1-2	≈2336 (1961)	1-58	NF	
≈7050 C	6-93	1560	3-5, 3-14	≈2337 (1961)	1-60	≈25-136	4-2, 4-12
7050 C-Z	6-87	≈1560	3-5, 3-29	≈2338 (1960)	3-27, 3-30	E21-301	10-4, 10-5
7051 C-H	6-94	1568	1-19, 1-39	2341	2-78	E22-163	7-119
7051 C-Z	6-94	≈1568	1-19, 1-35	≈2341	2-81	E22-165	7-122
≈7053 C	6-100	1570	7-64	2343	2-69	E25-104	7-85
7089	7-4, 7-31	≈1570	7-64, 7-66	≈2343	2-72, 2-76	≈E25-107	2-44
7090	7-33, 7-35	1601	2-32	- / 2343	7-134	E25-112	1-2
7091	7-11	1602	6-10	2344	2-86	≈E25-112	1-2
7092	7-25	≈1602	6-10	≈2346 (1962)	4-33	E25-114	1-19
≈7092	7-25	1603	6-16	≈2347 (1960)	5-9	≈E25-114	1-19
7093	7-32, 7-38	≈1603	6-16	≈2348 (1960)	5-12	E25-115-1/	1-18
7094	7-40	1618	3-97	2355/697	1-81	E25-402	
≈7094	7-40	≈1618	3-97	2359	2-39	E25-119-1	6-44
≈7379	2-64, 2-68	1624	6-209	≈2359	2-39	≈E25-119-1	6-44, 6-49
7380-1	2-51	1625	3-104	≈2369	4-2, 4-12	E25-119-2	6-44
≈7380-1	2-54	≈1779 A (1960)	6-31	2370	6-21	E25-120	6-51
7380-2	2-59	≈1780 A (1960)	6-27	≈2370	6-21	E25-123	6-21
≈7380-2	2-62	182	9-36	2371	6-28	≈E25-123	6-21
7434	6-6	1927	5-7	2430	9-46	E25-124	6-28
7436	6-7	1928	5-10	2450	7-80	E25-125	2-2, 2-20
8676	1-39	2250	6-179	≈2450	7-80	≈E25-125	2-2, 2-17
8677	1-72	2251	6-182	2451	7-79	≈E25-126	2-51, 2-54

E25-127	6-10	E25-405-1	3-32	E25-605	6-185	E27-182	2-86
≈E25-127	6-10	E25-406	3-76	E25-606	6-182	E27-183	2-69
E25-128	6-16	≈E25-406	3-78	E25-607	6-173	≈E27-183	2-72, 2-76
≈E25-128	6-16	≈E25-409	3-53	≈E25-654 C	6-84, 6-86	- / E27-183	7-134
E25-129	6-56	E25-410	3-65, 3-67	E25-656	6-87	≈E27-453	3-97
≈E25-129	6-32, 6-55	E25-412	3-48, 3-52	E25-656 C	6-87	E27-460	3-84
E25-133	1-86	≈E25-412	3-48	E25-657	6-94	≈E27-460	3-84
E25-134	1-84	E25-453	3-35	E25-657 C	6-94	E27-475	9-8, 9-12
E25-135	4-27, 4-29	E25-511	7-107	E25-658	6-78	≈E27-475	9-9
≈E25-137	1-35	E25-512	7-67	E25-658 C	6-78	E27-479	9-11
E25-151	1-39	E25-513	7-11, 7-14, 7-16, 7-18, 7-20, 7-38, 7-40	E25-660 C	6-75	E27-620	7-61
E25-152	1-36			E25-661 C	6-76	≈E27-620	7-61
E25-160	6-4	≈E25-513	7-14, 7-16, 7-18, 7-20, 7-40	E25-662 C	6-98	E27-624	7-77
E25-161	6-6			E25-662 F	6-98	≈E27-624	7-77
E25-163	6-7	E25-515	7-49	E25-663 C	6-73	E27-625	7-73
E25-401	3-5, 3-14	≈E25-515	7-49	E25-663 F	6-73	≈E27-625	7-73
≈E25-401	3-5, 3-29	E25-518	10-11	E25-774	9-36	≈E27-626	7-72
E25-402	3-31	E25-601	6-187	E27-180	2-78	E27-627	7-68
- / E25-402	1-75, 1-80/1-82	E25-603	6-189	≈E27-180	2-81		
E25-404	3-117	E25-604	6-179	E27-181	2-83		

Index grup

Grup	Strona	Grup	Strona	Grup	Strona	Grup	Strona	Grup	Strona	Grup	Strona
0		01580	3-33	07071	2-18	08750	1-12	12310	3-49	15900	12-152
01000	1-3	01586	3-33	07080	2-33	08760	1-27	12320	3-52	15905	12-153
01010	1-20	01587	3-39	07090	2-33	08781	3-19	12340	3-63	15910	12-154
01030	1-84	03000	1-59	07095	2-63	09561	8-44	12348	3-49	15915	12-156
01036	1-80	03010	1-61	07105	2-34	09610	8-43	12350	3-50	15916	12-155
01040	1-71	03060	3-28	07111	2-64	1		12352	3-52	15920	12-157
01049	1-65	03400	1-58	07116	2-67	11007	3-16	12400	3-63	15925	12-158
01050	1-64	03410	1-60	07117	2-68	11040	3-6	12410	3-50	15930	12-159
01055	1-65	03460	3-27	07141	2-59	11042	3-7	12422	3-53	15935	12-160
01060	1-36	03600	3-27	07150	2-51	11060	3-32	12450	3-50	15940	12-163
01061	1-37	04025	1-91	07151	2-52	11070	3-35	12460	3-81	15945	12-161
01070	1-39	04035	1-92	07160	2-4	11074	3-36	12470	3-74	15950	12-162
01071	1-39	04100	1-10	07165	2-16	11075	3-36	12471	3-74	16000	5-8
01098	1-86	04105	1-11	07170	2-5	11080	3-29	12474	3-74	16010	5-8
01100	3-6	04108	1-11	07200	2-32	11120	3-117	12479	3-83	16040	5-9
01104	3-17	04110	1-26	07212	2-21	11140	3-117	12480	3-96	16100	5-11
01110	3-6	04116	1-26	07250	2-30	11200	3-28	12530	3-85	16110	5-11
01120	3-15	04118	1-27	07260	2-25	11280	3-30	12531	3-85	16140	5-12
01130	3-15	04119	3-9	07290	2-54	11300	3-10	12600	3-54	16150	5-15
01149	3-76	04120	3-8	07400	2-40	11350	3-33	12662	3-54	16151	5-13
01150	3-75	04121	3-9	07407	2-41	11360	3-32	12858	3-65	16153	5-13
01155	3-76	04122	3-9	07450	2-44	11380	3-36	12880	3-66	16160	5-14
01200	1-5	04124	3-18	07470	2-39	11382	3-33	12910	3-66	16170	5-15
01210	1-21	04125	3-9	07560	2-49	11393	3-48	12912	3-67	16172	5-19
01220	1-6	04127	3-19	07600	2-50	11396	3-47	13000	3-75	16177	5-16
01222	1-94	04130	3-19	07620	2-95	11398	3-46	13100	3-71	16178	5-18
01226	1-7	04132	1-67	07640	2-94	11400	3-43	13190	3-73	16180	5-4
01230	1-22	04135	1-70	07650	2-93	11401	3-124	13200	3-72	16182	5-6
01232	1-96	04160	1-38	07660	2-92	11408	3-45	14000	3-112	16190	5-2
01236	1-24	04161	1-38	07670	2-97	11411	3-44	14020	3-109	16196	10-5
01240	1-37	04170	1-40	07680	2-96	11417	3-44	14100	10-90	16202	10-4
01241	1-37	04171	1-41	07760	2-91	11418	3-44	14110	10-90	16203	10-6
01250	1-40	04180	3-16	07800	2-83	11430	10-109	14200	3-111	16204	10-7
01251	1-40	04190	3-9	07810	2-79	11490	3-84	14210	3-111	16205	10-11
01256	1-66	04210	1-89	07812	2-81	11560	3-126	14230	3-110	16206	10-9
01258	1-69	04225	1-91	07820	2-86	11572	3-123	14410	10-91	16207	10-10
01300	3-7	04237	1-92	07840	2-69	11590	3-77	14439	10-90	16210	6-209
01301	3-17	04240	1-93	07850	2-70	11595	3-77	14440	10-91	16225	10-8
01310	3-7	04250	1-93	07852	2-72	11598	3-77	14441	10-96	16226	10-12
01320	3-7	04400	1-62	07860	2-79	11609	3-78	14442	10-96	16227	10-13
01321	3-18	04405	1-63	07890	2-76	11610	3-78	14443	10-93	16228	10-14
01325	3-6	04410	1-63	07930	2-70	11611	3-79	14444	10-92	16229	10-11
01326	3-7	06000	1-87	07940	2-90	11740	3-23	14445	10-93	16250	3-103
01330	3-15	06060	3-41	08070	1-81	11750	3-26	14446	10-92	16260	3-104
01336	3-8	06070	3-42	08100	3-31	11772	3-123	14450	10-97	16270	3-104
01337	3-18	06080	3-42	08110	3-31	11790	3-126	14451	10-97	16280	3-106
01340	3-15	07000	2-7	08200	1-18	11840	3-40	14456	10-94	16295	6-203
01400	1-8	07010	2-18	08206	1-82	12000	3-86	14457	10-95	16300	3-100
01405	1-95	07015	2-6	08250	1-75	12010	3-87	14483	10-94	16410	3-101
01410	1-24	07025	2-9	08260	1-80	12020	3-88	14484	10-95	16450	3-102
01415	1-97	07030	2-36	08280	6-173	12060	3-89	15000	3-94	16500	3-97
01420	1-9	07040	2-20	08290	6-201	12080	3-91	15010	3-95	16510	3-97
01430	1-25	07041	2-20	08310	1-72	12161	3-92	15020	3-95	16516	3-98
01500	3-8	07060	2-2	08320	1-72	12300	3-48	15060	3-94	16540	3-99
01510	3-18	07065	2-6	08420	1-76	12302	3-49	15070	3-95	16650	6-204
01560	3-8	07070	2-17	08450	6-174	12307	3-49	15080	3-95	16660	6-206

Grup	Strona	Grup	Strona	Grup	Strona	Grup	Strona	Grup	Strona	Grup	Strona
16680	3-113	20010	6-4	22082	4-41	24840	6-45	29346	6-170	30537	8-14
16690	3-114	20030	6-6	22090	4-42	24862	6-56	29349	6-157	30539	8-16
16711	5-20	20108	4-3	22100	4-38	24874	6-56	29353	6-157	30550	8-64
16713	5-20	20130	4-7	22180	4-35	24904	6-35	29360	6-160	30551	8-64
16715	5-23	20132	4-7	22190	4-35	24992	6-34	29367	6-171	30552	8-64
16717	5-23	20140	4-5	22200	4-59	25110	6-182	29370	6-157	30553	8-65
16728	5-25	20145	4-10	22280	4-57	25130	6-179	29375	6-160	30554	8-70
16733	5-26	20147	4-11	22290	4-57	25710	6-189	29385	6-158	30564	8-38
16812	5-21	20150	4-7	22320	4-45	25750	10-127	29390	6-201	30565	8-38
16813	5-20	20155	4-10	22330	4-47	25751	10-128	29440	6-155	30569	8-32
16817	5-22	20157	4-11	22380	4-58	25860	6-200	29570	6-107	30570	8-42
16829	5-24	20160	4-5	22382	4-58	25862	6-200	29580	6-139	30575	8-50
16831	5-27	20170	4-7	22383	4-58	26000	6-73	29581	6-139	30576	8-51
16833	5-26	20200	4-4	22384	4-58	26040	6-77	3		30577	8-50
17020	5-30	20220	4-6	22386	4-59	26080	6-98	30000	6-149	30579	8-53
17022	5-32	20230	4-6	22390	4-58	26100	6-74	30005	6-149	30580	8-84
17023	5-31	20232	4-6	22393	4-58	26180	6-99	30015	6-150	30581	8-83
17080	5-35	20235	4-13	22534	4-50	26200	6-79	30025	6-165	30585	8-78
17119	5-34	20240	4-20	22538	4-51	26210	6-80	30030	6-166	30595	8-85
17120	5-34	20252	4-20	22551	4-53	26220	6-88	30040	6-166	30596	8-86
17123	5-29	20300	4-5	22554	4-53	26240	6-96	30100	6-151	30650	12-6
17140	5-35	20302	4-5	23010	1-17	26300	6-83	30105	6-151	30660	12-8
17199	5-33	20330	4-10	23510	4-61	26400	6-80	30115	6-152	30664	12-10
17200	5-32	20360	4-13	23530	4-61	26402	6-80	30125	6-167	30666	12-19
17203	5-29	20372	4-10	23550	4-62	26432	6-89	30130	6-167	30667	12-12
17210	5-33	20376	4-6	23620	4-62	26450	6-95	30140	6-168	30668	12-21
17220	5-33	20380	4-5	23660	4-62	26452	6-95	30205	6-176	30669	12-23
17243	12-31	20395	4-11	24210	6-31	26456	6-103	30225	6-177	30900	12-120
17260	12-30	20410	4-11	24220	6-27	26501	6-84	30230	6-177	30901	12-120
17261	12-30	20420	8-93	24402	6-12	26521	6-91	30250	6-164	30902	12-121
17262	12-30	20430	8-93	24412	6-23	26600	6-73	30300	6-130	30903	12-126
17310	5-39	20460	4-24	24422	6-41	26620	6-75	30305	6-131	30904	12-126
17315	5-39	20464	4-24	24510	6-11	26640	6-76	30310	6-131	30905	12-122
17320	5-36	20466	4-24	24515	6-11	26660	6-78	30320	6-119	30906	12-129
17380	5-42	20470	4-25	24520	6-10	26670	6-79	30325	6-120	30907	12-129
17420	5-28	20474	4-26	24540	6-21	26680	6-87	30330	6-120	30908	12-128
17443	5-40	20476	4-25	24560	6-22	26690	6-88	30350	6-134	30950	11-23
17445	5-41	20478	4-26	24565	6-22	26700	6-94	30355	6-134	31100	6-138
17447	5-41	20610	8-91	24570	6-28	26760	6-79	30360	6-135	31120	6-123
17545	5-30	20620	8-91	24640	6-16	26770	6-88	30365	6-141	31140	6-133
17567	12-32	20630	8-91	24650	6-55	26780	6-95	30375	6-141	31230	6-137
17571	5-42	20640	8-91	24660	6-36	26820	6-130	30380	6-126	31235	6-137
17576	5-38	20650	8-91	24662	6-37	26910	10-122	30385	6-126	31250	6-123
17620	5-31	20660	8-92	24665	6-36	27010	6-60	30390	6-127	31255	6-122
17690	5-28	20661	8-92	24670	6-45	27100	6-57	30400	6-128	31256	6-132
17902	12-75	20663	8-80	24671	6-44	27160	6-59	30410	6-135	31260	6-132
17912	12-74	20710	8-89	24672	6-45	27180	6-58	30415	6-136	31282	6-145
18040	8-97	20750	8-90	24677	6-49	27410	9-22	30420	6-136	31290	6-61
18060	8-98	21500	4-29	24690	6-52	28100	6-100	30500	8-4	31305	6-198
18120	8-96	21510	4-30	24691	6-51	29240	6-154	30502	8-10	31310	6-199
18140	8-96	21515	4-30	24692	6-52	29242	6-155	30505	8-12	31411	6-143
18550	8-95	21520	4-30	24700	3-118	29243	6-159	30509	8-33	31416	6-143
18570	8-95	21540	4-33	24769	3-116	29248	6-155	30510	8-27	31426	6-144
18600	8-99	21560	4-27	24770	3-116	29310	6-160	30530	8-17	31445	6-140
2		22060	4-55	24800	6-37	29340	6-168	30531	8-17	31460	6-142
20000	6-7	22080	4-39	24810	6-37	29345	6-169	30532	8-17	31480	6-129

Index grup

Grup	Strona	Grup	Strona	Grup	Strona	Grup	Strona	Grup	Strona	Grup	Strona
31535	6-146	36050	7-124	37520	7-68	38212	7-39	38900	12-115	43080	12-7
31536	6-147	36200	7-126	37560	7-67	38220	7-39	38950	12-116	43081	12-7
31570	6-146	36215	7-127	37580	7-72	38230	7-41	38958	7-28	43110	12-20
31572	6-146	36230	7-131	37590	7-72	38240	7-40	39000	9-3	43111	12-20
31702	6-115	36233	7-128	37810	7-135	38250	7-25	39011	9-10	43115	12-21
31705	6-112	36239	7-129	37815	7-135	38270	7-22	39012	9-11	43213	12-117
31710	6-111	36250	7-129	37820	7-135	38280	7-22	39060	9-28	43214	12-118
31711	6-111	36251	7-130	37840	7-133	38300	7-142	39070	9-5	43241	12-25
31720	6-112	36252	7-130	37845	7-134	38310	7-142	39078	9-9	43246	12-24
31780	6-116	36265	7-132	37900	7-110	38320	7-142	39080	9-8	43270	12-26
31781	6-116	36270	7-89	37901	7-111	38400	7-44	39090	9-12	43271	12-27
31810	6-138	36273	7-89	37910	7-110	38401	7-45	39100	9-27	43272	12-27
31815	6-138	36300	7-83	37920	7-112	38410	7-44	39140	9-23	43273	12-27
31820	6-123	36302	7-84	37979	7-98	38420	7-23	39150	9-25	43274	12-27
31825	6-123	36303	7-85	37980	7-96	38430	7-24	39200	9-50	43275	12-28
31830	6-133	36307	7-86	37981	7-102	38435	7-24	39220	9-51	43276	12-28
31860	6-138	36325	7-93	37982	7-99	38438	7-24	39250	9-46	43279	12-27
31870	6-124	36326	7-94	37983	7-103	38490	7-145	39270	9-49	43280	12-26
31880	6-133	36390	7-105	37984	7-101	38495	7-145	39310	9-37	43295	12-122
32635	9-64	36395	7-104	37985	7-96	38500	7-145	39350	9-37	43299	12-123
32642	9-67	36396	7-105	37986	7-99	38520	7-143	39360	9-38	43310	12-123
33190	9-57	36397	7-105	37987	7-102	38540	7-144	39400	9-31	43317	12-121
33410	9-77	36411	7-105	37988	7-103	38583	7-140	39410	9-33	43323	12-124
33600	9-74	36420	7-106	38031	7-5	38585	7-140	39610	9-41	43324	12-125
33610	9-73	36425	7-106	38043	7-20	38590	7-141	39630	9-42	43325	12-125
33620	9-76	36450	7-91	38045	7-20	38600	7-139	39660	9-45	45008	2-43
33650	9-74	36460	7-92	38047	7-21	38602	7-140	39680	9-44	45010	1-33
33670	9-75	37000	7-50	38053	7-18	38650	7-113	39700	9-13	45070	4-9
33695	9-75	37020	7-50	38055	7-18	38670	7-118	39710	9-14	45080	3-12
33900	9-68	37024	7-51	38057	7-19	38684	7-116	39720	9-16	45110	3-51
34110	9-55	37025	7-51	38063	7-14	38690	7-115	39730	9-17	45140	10-99
34113	9-60	37030	7-50	38065	7-14	38740	7-12	39740	9-19	45150	7-30
34120	9-62	37060	7-51	38067	7-15	38760	7-27	39750	9-20	45180	7-29
34121	9-78	37070	7-66	38073	7-16	38793	7-151	39760	9-21	45184	7-8
34125	9-70	37080	7-64	38075	7-16	38796	7-151	39797	9-35	45191	7-147
34126	9-61	37092	7-65	38077	7-17	38801	7-152	4		45192	7-148
34128	9-72	37110	7-63	38080	7-6	38802	7-152	41000	11-3	45193	7-148
34130	9-57	37120	7-63	38081	7-5	38803	7-153	41010	11-14	45205	2-15
34140	9-63	37150	7-62	38089	7-7	38805	7-153	41020	11-24	45208	2-44
34150	9-59	37160	7-62	38100	7-5	38806	7-153	41030	11-24	45210	1-33
34180	9-58	37200	7-57	38125	7-7	38807	7-153	41040	11-24	45270	4-9
34184	9-64	37220	7-58	38130	7-5	38808	7-154	43010	12-9	45280	3-13
34185	9-69	37240	7-60	38131	7-31	38810	7-154	43011	12-9	45300	3-72
34186	9-59	37260	7-82	38133	7-31	38812	7-155	43019	12-11	45425	6-48
34190	9-56	37265	7-108	38140	7-6	38814	7-155	43020	12-10	45445	6-40
34200	9-63	37282	7-107	38143	7-6	38816	7-155	43024	12-14	45790	7-52
34205	9-71	37300	7-81	38152	7-6	38840	7-158	43025	12-18	45810	1-33
34250	9-71	37302	7-81	38157	7-6	38869	7-156	43026	12-18	45850	3-13
34310	9-56	37320	7-80	38160	7-33	38871	7-156	43030	12-23	45910	1-34
34320	9-65	37400	7-77	38180	7-34	38873	7-156	43033	12-15	45920	3-13
34330	9-66	37420	7-77	38190	7-34	38874	7-156	43055	12-22	45930	7-9
34350	9-66	37430	7-78	38200	7-11	38875	7-156	43062	12-13	45940	4-9
35145	9-79	37440	7-78	38205	7-11	38877	7-157	43063	12-13	46010	1-33
35146	9-80	37460	7-73	38209	7-38	38883	7-157	43065	12-16	46060	1-34
35760	9-79	37480	7-73	38210	7-38	38885	7-157	43074	12-16	46090	4-9
36000	7-121	37500	7-68	38211	7-39	38887	7-157	43076	12-17	46210	1-60

Grup	Strona	Grup	Strona	Grup	Strona	Grup	Strona	Grup	Strona	Grup	Strona
46290	4-20	50301	7-148	51102	10-6	51325	6-54	51540	7-114	51690	6-96
47000	3-13	50302	7-149	51104	10-7	51327	6-67	51546	10-100	51693	6-102
47030	3-34	50303	7-149	51106	3-44	51329	6-68	51550	7-64	51700	9-38
47050	3-13	50332	7-149	51108	3-77	51330	6-66	51551	7-62	51710	3-71
47100	3-28	50333	7-149	51109	3-29	51331	6-68	51552	7-139	51718	3-54
47170	3-26	50334	7-150	51110	6-23	51340	6-38	51554	7-139	51720	3-64
47195	3-45	50370	9-33	51111	6-23	51342	6-38	51555	7-141	51728	3-51
47220	2-98	50380	9-35	51112	3-83	51345	6-41	51556	7-140	51729	3-50
47300	3-102	50390	9-40	51113	3-125	51350	10-98	51557	7-141	51730	3-50
47340	3-98	50500	7-65	51119	3-79	51370	7-136	51560	9-4	51734	3-82
47360	3-99	50540	7-79	51120	6-12	51371	7-136	51572	10-119	51735	3-85
47480	6-205	50670	9-32	51121	6-12	51372	7-136	51573	10-124	51738	3-81
47490	6-207	50680	9-34	51122	6-43	51373	7-137	51574	10-116	51739	3-53
47500	3-113	50900	7-150	51128	3-119	51380	3-101	51577	7-42	51740	5-3
47510	3-114	51000	1-12	51140	6-16	51390	7-58	51578	10-115	51742	5-16
47511	3-115	51010	1-27	51160	3-16	51400	3-98	51580	9-6	51743	5-18
47530	6-210	51012	1-35	51162	3-11	51405	3-103	51582	9-18	51744	5-17
47550	3-105	51014	1-69	51166	3-37	51410	7-45	51583	9-19	51750	6-156
47560	3-105	51018	1-67	51170	4-26	51415	7-22	51585	9-15	51756	6-172
47570	3-106	51020	2-18	51178	3-112	51416	7-21	51586	9-16	51760	6-104
47711	10-104	51028	2-60	51180	3-109	51417	7-19	51588	10-123	51761	6-105
47715	10-104	51029	2-55	51182	3-110	51418	7-15	51589	9-21	51762	6-106
47720	10-103	51030	2-52	51183	3-111	51419	7-17	51590	7-41	51764	6-104
47750	10-103	51036	10-111	51190	10-129	51420	7-7	51591	10-114	51765	6-105
47780	10-102	51037	10-113	51200	3-41	51422	6-117	51592	10-117	51766	6-106
47790	10-102	51040	2-34	51207	6-19	51427	7-35	51593	10-120	51767	6-104
47796	10-101	51041	2-62	51208	6-20	51428	9-30	51594	10-125	51768	6-105
48020	6-14	51042	2-37	51209	6-34	51430	9-24	51595	10-121	51769	6-106
48040	6-18	51044	2-65	51210	6-29	51435	7-121	51596	10-125	51770	6-169
48170	6-25	51047	2-44	51212	10-101	51437	7-124	51597	10-126	51771	6-114
48180	6-30	51050	2-10	51215	6-32	51440	7-126	51598	10-120	51773	6-162
48210	6-31	51051	2-19	51220	3-87	51445	7-132	51599	10-118	51774	6-164
48220	6-27	51052	2-16	51221	3-38	51446	7-128	51600	6-74	51775	6-161
48520	6-15	51056	2-21	51222	3-39	51447	7-90	51620	6-75	51777	6-114
48530	6-18	51060	2-41	51224	3-89	51448	7-88	51640	6-77	51780	6-193
48550	6-26	51064	4-8	51225	3-90	51450	7-51	51650	6-99	51781	6-191
48570	6-30	51068	4-3	51230	2-87	51456	7-81	51651	6-101	51785	6-191
49210	6-184	51070	4-8	51240	2-80	51458	7-80	51652	6-108	51786	6-193
49230	6-181	51071	4-10	51250	2-84	51460	7-78	51653	6-109	51787	6-191
49250	6-186	51072	4-12	51260	2-71	51462	7-74	51660	6-81	51788	6-193
49310	6-184	51074	4-8	51270	4-31	51463	7-68	51661	6-82	51789	6-171
49330	6-181	51076	4-24	51280	4-28	51468	7-105	51663	6-86	51790	5-5
49350	6-186	51077	4-25	51281	5-38	51480	9-34	51664	6-84	51792	6-196
5		51080	3-10	51285	4-34	51490	9-31	51667	10-114	51793	6-195
50020	7-29	51081	3-19	51287	5-37	51500	1-73	51668	10-122	51794	6-197
50030	7-30	51082	3-10	51289	6-33	51501	1-74	51669	10-123	51795	6-195
50040	7-34	51088	3-118	51290	6-9	51503	6-206	51670	6-81	51796	6-197
50060	7-8	51089	3-11	51291	6-8	51505	1-82	51671	10-127	51797	6-195
50065	7-8	51090	3-34	51292	6-4	51506	1-83	51672	10-112	51798	6-72
50100	7-26	51092	3-36	51293	6-6	51520	7-65	51673	10-116	51799	6-115
50150	7-34	51093	3-34	51296	6-8	51530	7-39	51674	10-128	51800	3-105
50210	9-40	51095	3-116	51300	6-46	51531	7-32	51675	10-129	51801	6-72
50230	10-98	51097	10-110	51302	6-46	51532	7-24	51680	6-89	51810	3-103
50260	10-98	51098	3-124	51305	6-49	51533	7-43	51681	6-89	51812	6-209
50280	10-99	51100	3-10	51320	6-52	51534	7-27	51683	6-92	51820	6-208
50300	7-148	51101	3-45	51322	6-53	51535	7-29	51689	6-96	51828	6-205

Index grup

Grup	Strona	Grup	Strona	Grup	Strona	Grup	Strona	Grup	Strona	Grup	Strona
51829	6-204	53581	3-20	54155	13-26	54240	13-58	54509	13-90	54566	13-103
51830	3-113	54100	13-3	54156	13-27	54241	13-59	54511	13-92	54567	13-100
51840	3-114	54101	13-3	54157	13-22	54242	13-59	54512	13-93	54568	13-103
51843	6-194	54102	13-5	54158	13-29	54243	13-59	54513	13-85	54569	13-100
51844	6-192	54103	13-9	54159	13-29	54244	13-59	54514	13-82	54570	13-103
51845	6-194	54104	13-6	54160	13-30	54245	13-61	54515	13-82	54571	13-100
51846	6-192	54105	13-6	54161	13-30	54246	13-61	54516	13-85	54572	13-103
51847	6-194	54106	13-6	54162	13-30	54247	13-61	54517	13-82	54573	13-94
51848	6-192	54107	13-6	54163	13-30	54248	13-64	54518	13-90	54574	13-94
51849	6-197	54108	13-9	54164	13-31	54249	13-65	54519	13-93	54576	13-104
51850	6-196	54109	13-6	54165	13-32	54250	13-65	54520	13-90	54577	13-104
51851	6-197	54110	13-9	54166	13-34	54251	13-65	54521	13-90	54578	13-105
51852	6-196	54111	13-9	54167	13-32	54252	13-66	54522	13-94	54579	13-105
51860	6-183	54112	13-6	54168	13-33	54253	13-66	54523	13-87	54580	13-105
51864	6-93	54113	13-7	54169	13-33	54254	13-67	54524	13-90	54581	13-106
51866	6-189	54114	13-10	54170	13-33	54255	13-67	54525	13-91	54582	13-106
51870	6-180	54115	13-7	54171	13-35	54256	13-68	54526	13-88	54583	13-107
51874	6-188	54116	13-7	54200	13-37	54257	13-68	54527	13-85	54584	13-108
51876	6-187	54117	13-7	54201	13-37	54258	13-56	54528	13-85	54585	13-108
51878	6-178	54118	13-10	54202	13-37	54259	13-62	54529	13-91	54586	13-108
51880	6-185	54119	13-11	54203	13-38	54300	13-69	54530	13-85	54587	13-111
51886	6-190	54120	13-11	54204	13-39	54301	13-71	54531	13-83	54588	13-111
51890	6-176	54121	13-12	54206	13-41	54302	13-72	54532	13-83	54589	13-111
51891	6-112	54122	13-12	54207	13-41	54303	13-72	54533	13-83	54590	13-111
51892	6-113	54123	13-14	54208	13-41	54304	13-72	54534	13-91	54591	13-111
51893	6-113	54124	13-14	54209	13-41	54305	13-72	54535	13-95	54592	13-114
51894	6-113	54125	13-15	54210	13-44	54306	13-72	54536	13-95	54593	13-114
51900	6-174	54126	13-15	54211	13-45	54307	13-72	54537	13-86	54594	13-109
51908	7-143	54127	13-16	54212	13-45	54308	13-73	54538	13-94	54595	13-109
51910	7-115	54128	13-17	54213	13-45	54309	13-73	54539	13-83	54596	13-110
51914	7-118	54129	13-15	54214	13-45	54310	13-73	54540	13-86	54597	13-108
51920	7-146	54130	13-15	54215	13-45	54311	13-73	54541	13-96	54598	13-108
51922	7-144	54131	13-15	54216	13-46	54312	13-73	54542	13-96	54599	13-114
51930	7-25	54132	13-19	54217	13-47	54313	13-73	54543	13-96	54600	13-112
51935	10-10	54133	13-19	54218	13-47	54314	13-74	54544	13-86	54601	13-112
51936	10-10	54134	13-19	54219	13-48	54315	13-74	54545	13-86	54602	13-113
51940	5-8	54135	13-19	54220	13-48	54316	13-75	54546	13-97	54603	13-111
51941	5-8	54136	13-19	54221	13-48	54317	13-75	54547	13-88	54604	13-113
51950	5-11	54137	13-19	54222	13-50	54318	13-75	54548	13-88	54605	13-115
51951	5-11	54138	13-15	54223	13-49	54319	13-76	54549	13-99	54606	13-115
51961	2-92	54139	13-20	54224	13-49	54320	13-76	54550	13-102	54607	13-116
51962	2-93	54140	13-21	54225	13-50	54321	13-77	54551	13-99	54608	13-116
51964	2-95	54141	13-137	54226	13-51	54322	13-78	54552	13-102	54609	13-116
51965	2-96	54142	13-20	54227	13-51	54323	13-78	54553	13-99	54610	13-116
51966	2-97	54143	13-21	54228	13-52	54324	13-79	54554	13-102	54611	13-116
51970	9-41	54144	13-22	54229	13-53	54325	13-79	54555	13-99	54612	13-116
52420	7-8	54145	13-23	54230	13-53	54326	13-80	54556	13-102	54613	13-117
52451	7-52	54146	13-23	54231	13-54	54500	13-82	54557	13-99	54614	13-117
53080	3-11	54147	13-24	54232	13-55	54501	13-85	54558	13-102	54615	13-117
53162	3-12	54148	13-24	54233	13-55	54502	13-82	54559	13-99	54616	13-118
53460	7-79	54149	13-24	54234	13-55	54503	13-82	54560	13-102	54617	13-118
53510	1-16	54150	13-25	54235	13-55	54504	13-87	54561	13-100	54618	13-119
53520	1-31	54151	13-26	54236	13-55	54505	13-89	54562	13-103	54619	13-119
53521	1-32	54152	13-26	54237	13-57	54506	13-89	54563	13-100	54620	13-119
53570	2-14	54153	13-26	54238	13-57	54507	13-92	54564	13-103	54621	13-119
53580	3-12	54154	13-26	54239	13-57	54508	13-90	54565	13-100	54622	13-120

Grup	Strona	Grup	Strona	Grup	Strona	Grup	Strona	Grup	Strona	Grup	Strona
54623	13-121	55071	4-11	55402	3-98	55700	9-39	56290	3-108	56949	2-89
54624	13-121	55072	4-12	55410	7-45	55718	3-54	56300	7-8	56950	12-56
54625	13-122	55074	4-9	55415	7-23	55720	3-64	56310	7-9	56951	12-56
54626	13-122	55080	3-11	55416	7-21	55730	3-51	56320	7-26	56952	12-60
54627	13-123	55081	3-20	55417	7-19	55734	3-82	56330	7-40	56953	12-60
54628	13-123	55088	3-118	55418	7-15	55735	3-85	56332	7-40	56954	12-109
54629	13-124	55089	3-12	55419	7-17	55738	3-81	56410	6-15	56955	12-92
54630	13-125	55090	3-34	55420	7-7	55739	3-53	56420	6-18	56956	12-98
54631	13-125	55092	3-37	55425	7-32	55740	5-3	56440	6-26	56957	12-98
54632	13-127	55095	3-117	55426	7-34	55750	6-156	56460	6-33	56958	12-98
54633	13-127	55098	3-124	55427	7-35	55755	6-163	56480	10-105	56959	12-98
54634	13-127	55100	3-12	55436	7-97	55775	6-161	56610	6-202	56960	12-99
54635	13-127	55101	3-46	55437	7-97	55782	5-2	56660	1-98	56961	12-99
54636	13-127	55102	10-7	55438	7-98	55790	5-5	56661	1-99	56964	12-100
54637	13-127	55104	10-8	55443	7-93	55792	3-107	56662	1-99	56965	12-100
54638	13-128	55106	3-44	55447	7-90	55793	3-107	56672	12-130	56966	12-87
54639	13-128	55108	3-77	55450	7-51	55800	3-105	56680	12-143	56970	12-83
54640	13-128	55109	3-30	55453	7-100	55810	3-104	56690	12-144	56971	12-103
54641	13-129	55110	6-25	55454	7-101	55820	6-208	56710	12-145	56972	12-87
54642	13-129	55113	3-125	55456	7-100	55860	6-183	56730	12-84	56973	12-100
54643	13-131	55119	3-79	55460	7-78	55870	6-180	56735	12-84	56974	12-100
54644	13-131	55120	6-13	55462	7-74	55874	6-188	56740	12-85	56975	12-57
54645	13-132	55140	6-17	55463	7-97	55878	6-179	56760	12-146	56976	12-57
54646	13-132	55160	3-16	55464	7-98	55880	6-186	56767	12-147	56977	12-58
54647	13-132	55166	3-37	55465	7-100	55900	6-175	56770	12-144	56978	12-58
54648	13-132	55178	3-112	55466	7-101	55908	7-143	56772	12-148	56979	12-59
54649	13-132	55180	3-109	55490	9-32	55910	7-115	56780	12-149	56980	12-59
54650	13-132	55200	3-41	55500	1-73	55914	7-118	56783	12-150	56988	12-94
54651	13-133	55210	6-29	55501	1-75	55920	7-146	56790	10-107	57001	12-61
54652	13-133	55212	10-101	55505	1-83	55922	7-144	56792	10-105	57003	12-97
54653	13-133	55220	3-87	55506	1-83	55930	7-26	56795	10-106	57004	12-101
54654	13-134	55221	3-38	55510	9-48	55940	5-8	56797	10-106	57005	12-101
54655	13-134	55225	3-90	55512	9-49	55941	5-9	56799	12-143	57007	12-52
54656	13-135	55230	2-87	55516	9-51	55950	5-11	56800	12-147	57008	12-53
54701	13-136	55240	2-80	55520	7-65	55951	5-12	56806	12-146	57011	12-82
54702	13-136	55250	2-84	55530	7-39	55961	2-92	56818	12-137	57012	12-82
54703	13-137	55260	2-71	55531	7-33	55962	2-93	56819	12-136	57013	12-55
54704	13-42	55270	4-32	55532	7-24	55963	2-94	56824	12-139	57014	12-91
54705	13-43	55280	4-28	55533	7-43	55964	2-95	56830	12-138	57015	12-91
54706	13-43	55282	5-38	55534	7-28	55965	2-96	56832	12-133	57020	12-82
55000	1-14	55285	4-34	55540	7-114	55966	2-98	56833	12-129	57021	12-82
55010	1-29	55292	6-5	55551	7-62	55970	9-43	56834	12-127	57023	12-83
55012	1-36	55293	6-7	55561	6-165	56050	4-21	56835	12-132	57025	12-85
55018	1-68	55300	6-47	55577	7-42	56052	4-22	56837	12-134	57027	12-86
55020	2-19	55302	6-48	55580	9-7	56054	4-23	56839	12-135	57028	12-86
55025	2-61	55303	6-50	55590	7-41	56090	1-17	56840	12-131	57030	12-92
55030	2-53	55320	6-53	55651	6-101	56100	1-34	56843	12-141	57031	12-93
55032	2-55	55322	6-53	55660	6-83	56120	2-19	56890	12-142	57033	12-93
55040	2-35	55325	6-55	55661	6-82	56170	4-9	56901	12-104	57035	12-94
55042	2-38	55340	6-39	55664	6-85	56200	3-14	56914	12-76	57037	12-95
55047	2-45	55342	6-40	55680	6-90	56210	12-140	56915	12-77	57040	12-79
55050	2-12	55345	6-42	55681	6-90	56220	3-65	56916	12-76	57041	12-79
55060	2-42	55350	10-100	55683	6-92	56230	6-207	56921	12-79	57043	12-80
55067	4-13	55380	3-102	55689	6-97	56240	3-115	56922	12-78	57045	12-80
55068	4-4	55390	7-58	55690	6-97	56250	3-99	56931	12-86	57046	12-80
55070	4-8	55400	3-98	55693	6-103	56280	3-108	56940	12-105	57048	12-80

Index grup

Grup	Strona	Grup	Strona	Grup	Strona	Grup	Strona	Grup	Strona	Grup	Strona
57049	12-95	60319	10-56	61961	10-29	63240	8-15	64163	10-45	69526	3-129
57050	12-88	60321	10-56	61963	10-34	63243	8-85	64168	10-43	69670	3-141
57051	12-88	60323	10-60	62255	10-62	63248	8-16	64180	10-50	69685	3-140
57053	12-89	60325	10-59	62257	10-63	63252	8-84	64270	10-53	69975	3-139
57054	12-89	60331	10-60	62265	10-64	63260	8-24	64271	10-53	7	
57060	12-106	61015	10-21	62267	10-65	63261	8-19	64272	10-52	70520	8-59
57061	12-106	61020	10-21	62272	10-76	63270	8-14	64273	10-54	70521	8-60
57063	12-96	61035	10-21	62273	10-76	63276	8-13	64275	10-51	70522	8-61
57064	12-96	61040	10-22	62274	10-77	63277	8-13	64500	12-33	70523	8-61
57066	12-90	61055	10-22	62276	10-77	63298	8-31	64501	12-37	70524	8-62
57067	12-90	61060	10-22	62282	10-78	63300	8-20	64502	12-37	70525	8-57
57070	12-102	61115	10-22	62283	10-79	63309	8-21	64503	12-35	70526	8-58
57071	12-102	61120	10-22	62284	10-79	63310	8-22	64504	12-36	70527	8-55
57076	12-103	61135	10-23	62285	10-80	63312	8-23	64505	12-38	70528	8-55
57077	12-104	61140	10-23	62286	10-80	63313	8-23	64506	12-38	70529	8-55
57080	12-107	61155	10-23	62302	10-81	63320	8-52	64507	12-34	70530	8-56
57081	12-107	61165	10-23	62303	10-81	63321	8-52	65411	3-121	70531	8-56
57083	12-108	61170	10-23	62304	10-82	63322	8-53	65421	8-49	70532	8-56
57084	12-108	61180	10-24	62305	10-83	63323	8-72	65435	8-45	70615	8-83
57090	12-81	61265	10-28	62306	10-83	63324	8-67	65445	8-46	70636	8-81
57091	12-81	61290	10-30	62323	10-84	63325	8-68	65450	8-43	70646	8-81
57092	12-81	61300	10-30	62325	10-86	63328	8-66	66813	12-111	70665	8-25
57425	12-47	61317	10-32	62332	10-86	63400	8-46	66816	12-111	70880	8-18
57426	12-47	61355	10-32	62411	10-67	63410	8-47	66819	12-112	70882	8-18
57475	12-47	61390	10-32	62412	10-69	63421	8-73	66860	12-112	70927	8-69
57476	12-48	61415	10-25	62413	10-68	63422	8-74	66910	12-112	70967	8-54
57510	12-48	61420	10-25	62414	10-71	63428	8-54	66920	12-112	71010	3-149
57560	12-49	61430	10-26	62415	10-72	63445	8-75	66930	12-112	71020	3-150
57578	12-50	61435	10-26	62416	10-73	63500	10-36	66950	12-113	71021	3-150
57580	12-50	61440	10-26	62417	10-74	63560	8-39	66955	12-113	71030	3-152
57600	12-52	61450	10-24	63050	8-87	63562	8-39	66960	12-114	71040	3-151
57605	12-51	61515	10-25	63051	8-84	63590	8-39	66970	12-114	71050	3-152
57650	12-52	61530	10-25	63052	8-87	63600	8-41	66990	12-114	71090	3-153
57655	12-51	61555	10-26	63060	8-84	63601	8-40	67020	6-63	71110	3-146
57676	12-72	61570	10-27	63100	8-7	63611	8-28	67080	6-64	71120	3-147
57730	12-69	61615	10-25	63110	8-7	63615	8-29	67155	6-65	71121	3-147
57745	12-70	61630	10-26	63120	8-11	63616	8-29	67551	6-70	71130	3-149
57747	12-70	61650	10-27	63121	8-11	63617	8-30	67552	6-71	71140	3-148
57748	12-70	61670	10-27	63150	8-8	63690	8-76	67553	6-71	71210	3-146
57749	12-71	61810	10-28	63152	11-27	63691	8-85	69025	3-129	71310	3-143
57750	12-71	61850	10-33	63158	8-5	64010	10-87	69035	3-134	71320	3-144
57770	12-62	61860	10-32	63159	8-5	64030	10-88	69045	3-132	71330	3-145
57771	12-63	61936	10-31	63160	8-9	64050	10-87	69135	3-128	71340	3-145
57779	12-64	61937	10-31	63174	8-32	64100	10-37	69155	3-131	71410	3-143
57780	12-64	61938	10-31	63186	8-82	64108	10-38	69190	3-137	71510	3-154
57792	12-65	61939	10-31	63187	8-79	64122	10-39	69195	3-138	71550	3-172
57793	12-66	61941	10-34	63188	8-79	64130	10-40	69315	3-129	71551	3-174
57794	12-67	61942	10-35	63189	8-81	64132	10-42	69335	3-133	71552	3-173
57795	12-68	61944	10-17	63190	8-34	64134	10-41	69355	3-137	71554	3-174
57805	12-69	61945	10-18	63191	8-34	64136	10-46	69400	3-130	71556	3-175
57807	12-73	61946	10-18	63192	8-37	64140	10-47	69407	3-130	71560	3-173
6		61948	10-20	63195	8-35	64144	10-45	69435	3-134	71566	3-172
60311	10-57	61949	10-20	63196	8-36	64152	10-49	69440	3-136	71570	10-89
60313	10-57	61951	10-29	63223	8-26	64154	10-48	69445	3-135	71580	3-178
60315	10-58	61952	10-19	63226	8-48	64158	10-44	69450	3-135	71592	3-177
60317	10-59	61953	10-19	63227	8-88	64162	10-42	69525	3-132	71595	3-176

Grup	Strona	Grup	Strona	Grup	Strona	Grup	Strona	Grup	Strona	Grup	Strona
71597	3-177	72005	6-108	U01120	3-24	U08307	1-78	U37500	7-69	U51530	7-36
71610	3-155	72008	6-107	U01200	1-44	U08320	1-78	U37590	7-69	U51566	2-50
71620	3-155	72011	6-110	U01300	3-21	U12100	3-80	U38100	7-10	U51705	3-61
71640	3-156	72018	6-110	U01330	3-24	U12120	3-80	U38130	7-10	U51718	3-60
71710	3-156	72022	6-108	U04100	1-47	U12300	3-55	U38157	7-10	U51730	3-57
71711	3-157	72030	7-61	U04104	1-46	U12320	3-61	U38160	7-37	U51738	3-56
71720	3-157	72037	7-151	U04120	3-21	U12348	3-55	U38200	7-12	U51915	3-69
71730	3-158	72045	6-100	U04122	3-22	U12353	3-62	U38205	7-13	U51960	3-70
71740	3-157	72100	12-39	U04160	1-54	U12380	3-58	U38400	7-48	U53460	7-71
71760	3-160	72110	12-39	U04162	3-25	U12381	3-58	U38402	7-48	U53462	7-75
71762	3-163	72122	3-43	U04180	3-24	U12411	3-56	U38403	7-47	U55000	1-50
71764	3-162	72123	3-43	U04181	3-25	U12421	3-62	U38405	7-48	U55041	2-31
71766	3-161	72130	3-42	U04360	1-56	U12422	3-62	U43150	7-54	U55050	2-27
71768	3-161	72131	3-42	U07000	2-22	U12423	3-57	U50450	7-71	U55067	4-19
71770	3-161	72150	12-40	U07001	2-25	U12450	3-56	U50462	7-76	U55070	4-17
71772	3-162	72160	12-41	U07040	2-29	U12601	3-59	U51000	1-49	U55080	3-22
71774	3-164	72170	12-43	U07111	2-66	U12705	3-60	U51007	1-57	U55205	7-13
71776	3-165	72185	12-46	U07150	2-56	U12910	3-68	U51030	2-57	U55410	7-49
71778	3-165	72186	12-44	U07151	2-57	U12920	3-68	U51041	2-30	U55411	3-62
71780	3-165	72210	12-42	U07230	2-58	U12950	3-70	U51044	2-67	U55420	7-10
71782	3-166	72213	12-42	U07410	2-46	U12960	3-70	U51050	2-26	U55450	7-54
71784	3-167	72220	12-44	U07415	2-47	U20170	4-16	U51060	2-47	U55460	7-71
71786	3-168	72221	12-45	U07566	2-49	U20200	4-14	U51067	4-19	U55462	7-75
71788	3-160	72230	12-43	U07800	2-85	U20300	4-15	U51070	4-16	U55530	7-36
71790	3-164	72240	12-45	U07810	2-82	U20360	4-18	U51080	3-22	U55730	3-56
71792	3-169	72243	12-45	U07820	2-88	U20365	4-18	U51130	2-59	U55915	3-69
71794	3-169	72260	12-46	U07840	2-73	U37000	7-53	U51160	3-25		
71796	3-169	72293	3-120	U07845	2-90	U37020	7-53	U51205	7-13		
71798	3-170	72340	3-120	U07852	2-75	U37025	7-54	U51260	2-74		
71810	3-159	72350	3-119	U07890	2-77	U37060	7-53	U51261	2-76		
71860	3-159	8		U07891	2-78	U37170	7-56	U51390	7-59		
71910	3-151	87911	12-54	U08100	3-20	U37171	7-57	U51410	7-48		
71920	3-148	87916	12-54	U08110	3-21	U37180	7-55	U51411	3-62		
71930	3-144	U		U08160	3-24	U37183	7-56	U51420	7-10		
71940	3-155	U01000	1-43	U08161	3-24	U37200	7-59	U51422	3-59		
71950	3-158	U01060	1-52	U08200	1-41	U37320	7-76	U51450	7-54		
72000	6-109	U01062	1-53	U08210	1-42	U37321	7-76	U51460	7-70		
72002	6-109	U01080	1-85	U08300	1-77	U37420	7-70	U51462	7-75		
72004	9-67	U01100	3-21	U08305	1-78	U37480	7-75	U51500	1-79		

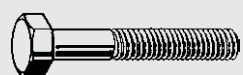

1 Śruby

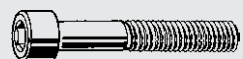

2 Produkty z gniazdem sześciokątnym



3 Nakrętki, nitonakrętki & wkładki



4 Pręty gwintowane & śruby dwustronne



5 Haki & śruby oczkowe



6 Wkręty

I Index



7 Podkładki & pierścienie uszczelniające typu “O-ring”



8 Kotwy, kołki, dyble

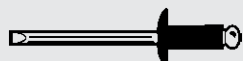

9 Nity, kołki & wpusty



10 Elementy łączne systemowe, meblowe & zabezpieczające



11 Zestawy

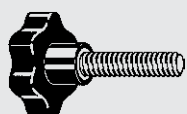

12 Części konstrukcyjne & części maszynowe

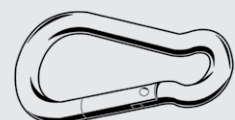

13 Przemysł morski

T Technologia łączenia

Podkładki & pierścienie uszczelniające typu "O-ring" 7

 Strona 7-4 DIN 125-1A Okrągłe	 Strona 7-9 ASME B18.21.1 USS niemetryczne	 Strona 7-11 DIN 126 Okrągłe	 Strona 7-12 ASME B18.21.1 SAE niemetryczne	 Strona 7-14 NF E25-513 Okrągłe, typ L
 Strona 7-16 NF E25-513 Powiększone, typ LL	 Strona 7-18 NF E25-513 Powiększone, typ M	 Strona 7-20 NF E25-513 Powiększone, typ Z	 Strona 7-22 DIN 7989-1 Do konstrukcji stalowych	 Strona 7-23 DIN 7349 Pogrubione
 Strona 7-25 DIN 433 Do wkrętów o łbach walcowych	 Strona 7-27 DIN 1440 Do sworzni	 Strona 7-28 DIN 1441 Do sworzni zgrubne	 Strona 7-29 Aluminiowe - Mosiężne	 Strona 7-30 Okrągłe, typ AG3
 Strona 7-31 ISO 7089 Okrągłe	 Strona 7-32 ISO 7093 Okrągłe	 Strona 7-33 DIN 125-1B Okrągłe	 Strona 7-35 ISO 7090 Okrągłe, ze ścięciem	 Strona 7-36 ASME ≈B18.21.1 Okrągłe, powiększone
 Strona 7-37 ASME ≈B18.21.1 Podkładki powiększone Stal	 Strona 7-38 DIN 9021 Podkładki powiększone 3xd	 Strona 7-40 DIN 440 R Powiększone do konstrukcji drewnianych	 Strona 7-42 DIN 440V Powiększone, do konstrukcji drewnianych	 Strona 7-43 DIN 1052 Powiększone do konstrukcji drewnianych
 Strona 7-44 Naprawcze	 Strona 7-46 ASME ≈ B18.21.1 Płaskie powiększone	 Strona 7-49 DIN 127 B Sprężyste	 Strona 7-52 ASME B18.21.1 Sprężyste	 Strona 7-55 ASME B18.21.1 Sprężyste typu ciężkiego
 Strona 7-56 ASME B18.21.1 Do wkrętów o łbach walcowych i kulistych	 Strona 7-57 DIN 7980 Do wkrętów o łbach walcowych i kulistych	 Strona 7-59 ASME B18.21.1 Do wkrętów o łbach walcowych i kulistych	 Strona 7-60 Dwuzwojowe	 Strona 7-61 DIN 74361 C Podkładki stożkowe sprężyste
 Strona 7-61 DIN 137 B Podatne faliste	 Strona 7-63 DIN 137 A Podatne łukowe	 Strona 7-64 DIN 128 A Sprężyste	 Strona 7-66 DIN ≈128 A Z krawędzią zabezpieczającą	 Strona 7-67 NF E25-512 Zabezpieczające, typ JZC
 Strona 7-68 DIN 6798 V Ząbkowane wachlarzowe	 Strona 7-69 ASME B18.21.1 Ząbkowane wachlarzowe	 Strona 7-69 ASME B18.21.1 Ząbkowane	 Strona 7-70 ASME B18.21.1 Ząbkowane	 Strona 7-72 NF ≈E27-626 Ząbkowane typ DD
 Strona 7-73 DIN 6798 J Ząbkowane typ J	 Strona 7-74 ASME B18.21.1 Ząbkowane wewnętrznie	 Strona 7-76 ASME B18.21.1 Ząbkowane typu ciężkiego	 Strona 7-77 DIN 6798 A Ząbkowane, typ A	 Strona 7-79 DIN 6797 J Ząbkowane, typ J

Podkładki & pierścienie uszczelniające typu "O-ring" 7

 Strona 7-80 DIN 6797 A Ząbkowane, typ A	 Strona 7-82 DIN 43699 Sprężyste	 Strona 7-82 DIN 2093 A Sprężyny talerzowe, typ B (średni)	 Strona 7-83 DIN 2093 B Sprężyny talerzowe, typ B (średni)	 Strona 7-84 DIN 2093 C Sprężyny talerzowe, typ C (lekki)
 Strona 7-85 DIN 2093 Zastosowanie uniwersalne	 Strona 7-88 DIN ≈2093 A/C Typ A, powiększone	 Strona 7-89 DIN 6796 Podatne stożkowe	 Strona 7-90 Sprężyny talerzowe do zastosowań krytycznych	 Strona 7-92 Sprężyny talerzowe
 Strona 7-93 Sprężyny talerzowe, typ M	 Strona 7-94 Sprężyny talerzowe, typ M	 Strona 7-96 NORD-LOCK	 Strona 7-98 NORD-LOCK, niemetryczne	 Strona 7-99 NORD-LOCK
 Strona 7-101 NORD-LOCK powiększone niemetryczne	 Strona 7-102 NORD-LOCK stożkowe	 Strona 7-102 NORD-LOCK stożkowe niemetryczne	 Strona 7-103 NORD-LOCK powiększone	 Strona 7-103 NORD-LOCK powiększone niemetryczne
 Strona 7-104 Zabezpieczające, typ S	 Strona 7-106 Zabezpieczające, typ VS	 Strona 7-107 NF E25-511 Zabezpieczające, typ M	 Strona 7-108 Zabezpieczające, typ P	 Strona 7-109 DUBO, podkładki zabezpieczające
 Strona 7-110 DUBO, pierścienie uszczelniające	 Strona 7-111 DUBO Pierścienie kołnierzowe	 Strona 7-113 DIN 93 Podkładki odginane	 Strona 7-114 DIN 463 Podkładki odginane	 Strona 7-116 DIN 462 Podkładki odginane z noskiem
 Strona 7-117 DIN 432 Podkładki odginane z noskiem	 Strona 7-119 DIN 471 Pierścienie osadcze, typ A	 Strona 7-122 DIN 472 Pierścienie osadcze, typ J	 Strona 7-125 DIN 6799 Płytki osadcze	 Strona 7-126 DIN 7993 A Pierścienie sprężynujące
 Strona 7-128 STARLOCK, typ A	 Strona 7-129 STARLOCK, typ 4A	 Strona 7-129 STARLOCK, narzędzie instalujące	 Strona 7-130 STARLOCK, narzędzie instalujące	 Strona 7-131 STARLOCK, podkładka ustalająca
 Strona 7-132 Zaciski do śrub i wałków typ SL	 Strona 7-133 Pierścienie osadcze zaciskowe	 Strona 7-134 Pierścienie osadcze zaciskowe	 Strona 7-134 DIN 705 Pierścienie osadcze	 Strona 7-137 DIN 705/ISO 4027 (DIN 914) Pierścienie osadcze
 Strona 7-137 DIN 988 Podkładki dystansowe	 Strona 7-142 DIN 436 Podkładki kwadratowe	 Strona 7-143 DIN 435 Podkładki klinowe do dwuteowników	 Strona 7-145 DIN 434 Podkładki klinowe do ceowników	 Strona 7-146 DIN 7603 A/C Podkładki uszczelniające

Podkładki & pierścienie uszczelniające typu "O-ring" 7

 <p>Strona 7-150</p> <p>Podkładki uszczelniające</p>	 <p>Strona 7-151</p> <p>Podkładki płaskie</p>	 <p>Strona 7-151</p> <p>Podkładki uszczelniające z gumą</p>	 <p>Strona 7-152</p> <p>Uszczelki gumowe</p>	 <p>Strona 7-158</p> <p>Uszczelki gumowe</p>
---	--	--	--	---

Podkładki okrągłe

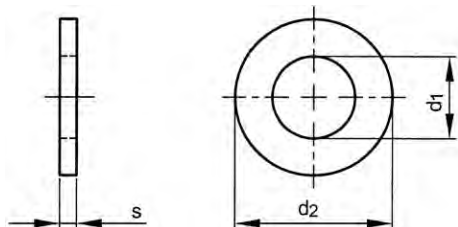

DIN 125-1A
ISO 7089
NEN 2269 A

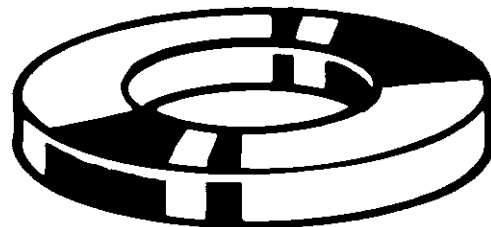

Informacje techniczne

Dla wymiaru nominalnego	d ₁	d ₂	s	Dla wymiaru nominalnego	d ₁	d ₂	s
M1 (#DIN)	1.1	3.2	0.3	M18	19	34	3
M1.2 (#DIN)	1.3	3.8	0.3	M20	21	37	3
M1.4 (#DIN)	1.5	3.8	0.3	M22	23	39	3
M1.6	1.7	4	0.3	M24	25	44	4
M1.7	1.8	4.5	0.3	M26 (#DIN)	27.3	49.5	3.8
M2	2.2	5	0.3	M27	28	50	4
M2.5	2.7	6	0.5	M30	31	56	4
M2.6	2.8	7	0.5	M33	34	60	5
M3	3.2	7	0.5	M36	37	66	5
M3.5	3.7	8	0.5	M39	40	72	6
M4	4.3	9	0.8	M42	43	78	7
M5	5.3	10	1	M45	46	85	7
M6	6.4	12	1.6	M48	50	92	8
M7	7.4	14	1.6	M50	52	92	8
M8	8.4	16	1.6	M52	54	98	8
M10	10.5	20	2	M56	58	105	9
M11 (#DIN)	12	24	2.5	M58 (#DIN)	60	110	9
M12	13	24	2.5	M60	62	110	9
M14	15	28	2.5	M64	66	115	9
M14.5 (#DIN)	14.5	22	2.2	M72 (#DIN)	74.3	123.7	9.75
M16	17	30	3				

- Podkładki okrągłe zgodn. z DIN 125-1 A z minimalną twardością 140HV.
- Z uwagi na niską wytrzymałość na ściskanie te podkładki okrągłe można stosować wyłącznie w połączeniu ze śrubami z klasą wytrzymałości < 8.8 tzn. z nakrętkami z klasą wytrzymałości < 8.

Grupy katalogowe

Material	Klasa	Obróbka powierzchni	Kod	Strona
St 140HV			38100	7-5
St 140HV		Ocynk.	38031	7-5
St 140HV		ZNTHP-NC6	38081	7-5
St 140HV		Ocynk.	38130	7-5
St 140HV		Ocynk.	Duże Opakowanie	7-6
St 140HV		Ocynk. żłt. pas.	38080	7-6
St 140HV		Ocynk. czrn. pas.	38143	7-6
St 140HV		Ocynk. gor.	38157	7-6
St 140HV		FLZNNC-NC6	38152	7-6
St 200HV		Ocynk.	38093	7-7
St 200HV		FLZNNC-NC6	38125	7-7
St.St. A2			51420	7-7
St.St. A4			55420	7-7
St.St. A5			52420	7-8
Al			45184	7-8
Mosiądz			50060	7-8
Mosiądz		Nikl.	50065	7-8
Plastik PA	PA 6.6		56300	7-8
Plastik PA	PA 6.6	Duże Opakowanie	56310	7-9
Ti			45930	7-9

38100 Podkładki okrągłe		L01A
Materiał	Stal 140HV	 
Obróbka powierzchni	Ocynkowane	

Dla wymiaru nominalnego	✉	Kod artykułu	Dla wymiaru nominalnego	✉	Kod artykułu	Dla wymiaru nominalnego	✉	Kod artykułu
M3	250	38100.030.001	M18	100	38100.180.001	M45	10	38100.450.001
M4	250	38100.040.001	M20	100	38100.200.001	M48	10	38100.480.001
M5	250	38100.050.001	M22	50	38100.220.001	M52	5	38100.520.001
M6	250	38100.060.001	M24	50	38100.240.001	M56	5	38100.560.001
M8	250	38100.080.001	M27	100	38100.270.001	M58	1	38100.580.001
M10	200	38100.100.001	M30	25	38100.300.001	M60	1	38100.600.001
M11	150	38100.110.001	M33	25	38100.330.001	M64	1	38100.640.001
M12	150	38100.120.001	M36	25	38100.360.001	M72	1	38100.720.001
M14	100	38100.140.001	M39	10	38100.390.001			
M16	100	38100.160.001	M42	10	38100.420.001			

38031 Podkładki okrągłe		L01A
Materiał	Stal 140HV	 
Obróbka powierzchni	Ocynkowane	

Dla wymiaru nominalnego	✉	Kod artykułu	Dla wymiaru nominalnego	✉	Kod artykułu	Dla wymiaru nominalnego	✉	Kod artykułu
M3	250	38031.030.001	M11	150	38031.110.001	M20	100	38031.200.001
M4	250	38031.040.001	M12	150	38031.120.001	M22	50	38031.220.001
M5	250	38031.050.001	M14	100	38031.140.001	M24	25	38031.240.001
M6	250	38031.060.001	M16	100	38031.160.001	M27	10	38031.270.001
M8	250	38031.080.001	M18	100	38031.180.001	M30	10	38031.300.001
M10	200	38031.100.001						

38081 Podkładki okrągłe		L95A
Materiał	Stal 140HV	 
Obróbka powierzchni	Ocynk, gruba pasywacja Cr ³⁺	

Dla wymiaru nominalnego	✉	Kod artykułu	Dla wymiaru nominalnego	✉	Kod artykułu	Dla wymiaru nominalnego	✉	Kod artykułu
M3	250	38081.030.001	M10	200	38081.100.001	M20	100	38081.200.001
M4	250	38081.040.001	M12	150	38081.120.001	M22	50	38081.220.001
M5	250	38081.050.001	M14	100	38081.140.001	M24	50	38081.240.001
M6	250	38081.060.001	M16	100	38081.160.001	M27	25	38081.270.001
M7	250	38081.070.001	M18	100	38081.180.001	M30	25	38081.300.001
M8	250	38081.080.001						

38130 Podkładki okrągłe		L01A
Materiał	Stal 140HV	 
Obróbka powierzchni	Ocynkowane	

Dla wymiaru nominalnego	✉	Kod artykułu	Dla wymiaru nominalnego	✉	Kod artykułu	Dla wymiaru nominalnego	✉	Kod artykułu
M1,6	500	38130.016.001	M11	150	38130.110.001	M33	25	38130.330.001
M2	500	38130.020.001	M12	150	38130.120.001	M36	25	38130.360.001
M2,5	500	38130.025.001	M14	100	38130.140.001	M39	10	38130.390.001
M2,6	500	38130.026.001	M16	100	38130.160.001	M42	10	38130.420.001
M3	250	38130.030.001	M18	100	38130.180.001	M45	10	38130.450.001
M4	250	38130.040.001	M20	100	38130.200.001	M48	10	38130.480.001
M5	250	38130.050.001	M22	50	38130.220.001	M52	5	38130.520.001
M6	250	38130.060.001	M24	50	38130.240.001	M56	5	38130.560.001
M7	250	38130.070.001	M26	50	38130.260.001	M60	5	38130.600.001
M8	250	38130.080.001	M27	25	38130.270.001	M64	5	38130.640.001
M10	200	38130.100.001	M30	25	38130.300.001			

38140 Podkładki okrągłe		L01A	
Materiał	Stal 140HV		
Obróbka powierzchni	Ocynkowane		

Dla wymiaru nominalnego	☒	Kod artykułu	Dla wymiaru nominalnego	☒	Kod artykułu	Dla wymiaru nominalnego	☒	Kod artykułu
M2		2500 38140.020.001	M6		2000 38140.060.001	M14		400 38140.140.001
M3		2500 38140.030.001	M8		2000 38140.080.001	M16		400 38140.160.001
M3,5		2500 38140.035.001	M10		1000 38140.100.001	M20		250 38140.200.001
M4		2500 38140.040.001	M11		500 38140.110.001	M24		250 38140.240.001
M5		2500 38140.050.001	M12		500 38140.120.001			

38080 Podkładki okrągłe		L01A	
Materiał	Stal 140HV		
Obróbka powierzchni	Ocynkowane, po żółtej pasywacji		

Dla wymiaru nominalnego	☒	Kod artykułu	Dla wymiaru nominalnego	☒	Kod artykułu	Dla wymiaru nominalnego	☒	Kod artykułu
M3		250 38080.030.001	M10		200 38080.100.001	M20		100 38080.200.001
M4		250 38080.040.001	M11		150 38080.110.001	M22		50 38080.220.001
M5		250 38080.050.001	M12		150 38080.120.001	M24		50 38080.240.001
M6		250 38080.060.001	M14		100 38080.140.001	M27		25 38080.270.001
M7		250 38080.070.001	M16		100 38080.160.001	M30		25 38080.300.001
M8		250 38080.080.001	M18		100 38080.180.001	M33		25 38080.330.001

38143 Podkładki okrągłe		L01A	
Materiał	Stal 140HV		
Obróbka powierzchni	Ocynkowane, po czarnej pasywacji		

Dla wymiaru nominalnego	☒	Kod artykułu	Dla wymiaru nominalnego	☒	Kod artykułu	Dla wymiaru nominalnego	☒	Kod artykułu
M3		250 38143.030.001	M8		250 38143.080.001	M16		100 38143.160.001
M4		250 38143.040.001	M10		200 38143.100.001	M20		100 38143.200.001
M5		250 38143.050.001	M12		150 38143.120.001			
M6		250 38143.060.001	M14		100 38143.140.001			

38157 Podkładki okrągłe		A08A	
Materiał	Stal 140HV		
Obróbka powierzchni	Ocynkowane na gorąco		

Dla wymiaru nominalnego	☒	Kod artykułu	Dla wymiaru nominalnego	☒	Kod artykułu	Dla wymiaru nominalnego	☒	Kod artykułu
M8		200 38157.080.001	M18		100 38157.180.001	M30		50 38157.300.001
M10		200 38157.100.001	M20		100 38157.200.001	M36		50 38157.360.001
M12		150 38157.120.001	M24		100 38157.240.001			
M16		100 38157.160.001	M27		50 38157.270.001			

38152 Podkładki okrągłe		L01A	
Materiał	Stal 140HV		
Obróbka powierzchni	Ocynk płatkowy bez Cr6+ wg ISO 10683 (f1Znnc)		

Dla wymiaru nominalnego	☒	Kod artykułu	Dla wymiaru nominalnego	☒	Kod artykułu	Dla wymiaru nominalnego	☒	Kod artykułu
M6		250 38152.060.001	M14		100 38152.140.001	M27		50 38152.270.001
M8		250 38152.080.001	M16		100 38152.160.001	M30		25 38152.300.001
M10		200 38152.100.001	M20		100 38152.200.001			
M12		150 38152.120.001	M24		50 38152.240.001			

7

38093 Podkładki okrągłe		L01A	
Materiał	Stal 200HV		
Obróbka powierzchni	Ocynkowane		

Dla wymiaru nominalnego	✉	Kod artykułu	Dla wymiaru nominalnego	✉	Kod artykułu	Dla wymiaru nominalnego	✉	Kod artykułu
M6	250	38093.060.001	M16	100	38093.160.001	M27	25	38093.270.001
M8	250	38093.080.001	M18	100	38093.180.001	M30	25	38093.300.001
M10	200	38093.100.001	M20	100	38093.200.001	M33	25	38093.330.001
M12	150	38093.120.001	M24	50	38093.240.001	M36	25	38093.360.001
M14	100	38093.140.001						

38125 Podkładki okrągłe		L01A	
Materiał	Stal 200HV		
Obróbka powierzchni	Ocynk płatkowy bez Cr6+ wg ISO 10683 (flZnnc)		

Dla wymiaru nominalnego	✉	Kod artykułu	Dla wymiaru nominalnego	✉	Kod artykułu	Dla wymiaru nominalnego	✉	Kod artykułu
M6	250	38125.060.001	M12	150	38125.120.001	M24	50	38125.240.001
M8	250	38125.080.001	M16	100	38125.160.001	M30	25	38125.300.001
M10	200	38125.100.001	M20	100	38125.200.001			

51420 Podkładki okrągłe		R05A	
Materiał	Stal nierdzewna A2		

Dla wymiaru nominalnego	✉	Kod artykułu	Dla wymiaru nominalnego	✉	Kod artykułu	Dla wymiaru nominalnego	✉	Kod artykułu
M1,2	200	51420.012.001	M7	500	51420.070.001	M27	50	51420.270.001
M1,6	200	51420.016.001	M8	500	51420.080.001	M30	50	51420.300.001
M1,7*	2000	51420.017.001	M10	500	51420.100.001	M33	50	51420.330.001
M2	200	51420.020.001	M12	500	51420.120.001	M36	50	51420.360.001
M2,5	200	51420.025.001	M14	200	51420.140.001	M39	25	51420.390.001
M3	500	51420.030.001	M16	200	51420.160.001	M40*	25	51420.400.001
M3,5	500	51420.035.001	M18	200	51420.180.001	M42	20	51420.420.001
M4	500	51420.040.001	M20	200	51420.200.001	M46*	10	51420.460.001
M5	500	51420.050.001	M22	100	51420.220.001	M50*	10	51420.500.001
M6	500	51420.060.001	M24	100	51420.240.001	M52	10	51420.520.001

55420 Podkładki okrągłe		R45A	
Materiał	Stal nierdzewna A4		

Dla wymiaru nominalnego	✉	Kod artykułu	Dla wymiaru nominalnego	✉	Kod artykułu	Dla wymiaru nominalnego	✉	Kod artykułu
M1,6	200	55420.016.001	M8	500	55420.080.001	M27	50	55420.270.001
M1,7*	2000	55420.017.001	M10	500	55420.100.001	M30	50	55420.300.001
M2	200	55420.020.001	M12	500	55420.120.001	M33	50	55420.330.001
M2,5	200	55420.025.001	M14	200	55420.140.001	M36	50	55420.360.001
M3	500	55420.030.001	M16	200	55420.160.001	M39*	25	55420.390.001
M3,5*	1000	55420.035.001	M18	200	55420.180.001	M42*	25	55420.420.001
M4	500	55420.040.001	M20	200	55420.200.001	M45	10	55420.450.001
M5	500	55420.050.001	M22	100	55420.220.001	M50*	10	55420.500.001
M6	500	55420.060.001	M24	100	55420.240.001	M52*	10	55420.520.001
M7	500	55420.070.001						

52420 Podkładki okrągłe		R45A						
Materiał	Stal nierdzewna A5							
Dla wymiaru nominalnego	☒	Kod artykułu	Dla wymiaru nominalnego	☒	Kod artykułu	Dla wymiaru nominalnego	☒	Kod artykułu
M6*	1000	52420.060.001	M12*	200	52420.120.001	M24*	100	52420.240.001
M8*	500	52420.080.001	M16*	200	52420.160.001	M27*	50	52420.270.001
M10*	500	52420.100.001	M20*	200	52420.200.001			

45184 Podkładki okrągłe		W010						
Materiał	Aluminium							
Dla wymiaru nominalnego	☒	Kod artykułu	Dla wymiaru nominalnego	☒	Kod artykułu	Dla wymiaru nominalnego	☒	Kod artykułu
M3	250	45184.030.001	M8	250	45184.080.001	M20	100	45184.200.001
M4	250	45184.040.001	M10	200	45184.100.001	M30	50	45184.300.001
M5	250	45184.050.001	M12	150	45184.120.001			
M6	250	45184.060.001	M16	100	45184.160.001			

50060 Podkładki okrągłe		M11F						
Materiał	Mosiądz							
Dla wymiaru nominalnego	☒	Kod artykułu	Dla wymiaru nominalnego	☒	Kod artykułu	Dla wymiaru nominalnego	☒	Kod artykułu
M3	250	50060.030.001	M8	250	50060.080.001	M16	100	50060.160.001
M4	250	50060.040.001	M10	100	50060.100.001	M18	50	50060.180.001
M5	250	50060.050.001	M12	100	50060.120.001	M20	50	50060.200.001
M6	250	50060.060.001	M14	100	50060.140.001	M24	50	50060.240.001
M7	250	50060.070.001						

50065 Podkładki okrągłe		M11F						
Materiał	Mosiądz							
Obróbka powierzchni	Nikiowane							
Dla wymiaru nominalnego	☒	Kod artykułu	Dla wymiaru nominalnego	☒	Kod artykułu	Dla wymiaru nominalnego	☒	Kod artykułu
M3	250	50065.030.001	M8	250	50065.080.001	M20	50	50065.200.001
M4	250	50065.040.001	M10	100	50065.100.001	M24	50	50065.240.001
M5	250	50065.050.001	M12	100	50065.120.001			
M6	250	50065.060.001	M16	100	50065.160.001			

56300 Podkładki okrągłe		W02A						
Materiał	Plastik Poliamid (nylon)							
Klasa	PA 6.6							
Dla wymiaru nominalnego	☒	Kod artykułu	Dla wymiaru nominalnego	☒	Kod artykułu	Dla wymiaru nominalnego	☒	Kod artykułu
M1,8	200	56300.018.001	M8	200	56300.080.001	M20	50	56300.200.001
M2	200	56300.020.001	M10	100	56300.100.001	M22	50	56300.220.001
M2,5	200	56300.025.001	M12	100	56300.120.001	M24	50	56300.240.001
M3	200	56300.030.001	M14	100	56300.140.001	M27	50	56300.270.001
M4	200	56300.040.001	M14,5	100	56300.145.001	M30	50	56300.300.001
M5	200	56300.050.001	M16	50	56300.160.001	M33	50	56300.330.001
M6	200	56300.060.001	M18	100	56300.180.001	M36	50	56300.360.001

7

56310 Podkładki okrągłe		W02A	
Materiał	Plastik Poliamid (nylon)		
Klasa	PA 6.6		
Dla wymiaru nominalnego	✉	Kod artykułu	Dla wymiaru nominalnego
M3	1000	56310.030.001	M8
M4	1000	56310.040.001	M10
M5	1000	56310.050.001	M12
M6	1000	56310.060.001	M14
			M16
			M20
			500
			500
			56310.160.001
			56310.200.001

45930 Podkładki okrągłe		W01A	
Materiał	Tytan Grade 2		
Dla wymiaru nominalnego	✉	Kod artykułu	Dla wymiaru nominalnego
M6	25	45930.060.001	M8
			M10
			25
			45930.080.001
			45930.100.001

- Tytan Grade 2 (numer materiału 3.7035) z wysokim procentem czystego tytanu zapewnia stabilność produktu i jego przydatność w bardzo korozyjnych środowiskach, w których nie znajdują zastosowania inne materiały, jak np. stal nierdzewna.
- Tytan Grade 2 jest również odpowiedni do innych zastosowań z lekkim obciążeniem.

Podkładki USS niemetryczne

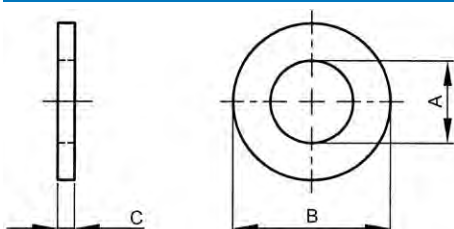

ASME B18.21.1

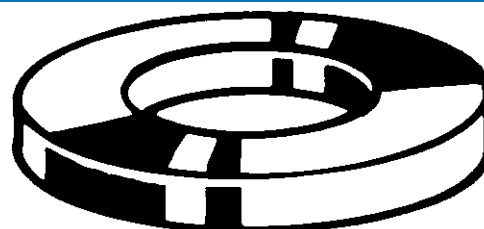

Informacje techniczne

Dla wymiaru nominalnego	A	B	C
1/4	0.312	0.734	0.065
5/16	0.375	0.875	0.083
3/8	0.438	1.000	0.083
7/16	0.500	1.250	0.083
1/2	0.562	1.375	0.109
9/16	0.625	1.469	0.109
5/8	0.688	1.750	0.134
3/4	0.812	2.000	0.148
7/8	0.938	2.250	0.165
1 Inch	1.062	2.500	0.165
1.1/8	1.250	2.750	0.165
1.1/4	1.375	3.000	0.165
1.3/8	1.500	3.250	0.180
1.1/2	1.625	3.500	0.180

Grupy katalogowe

Materiał	Obrobka powierzchni	Kod	Strona
St		U38100	7-10
St	Ocynk.	U38130	7-10
St	Ocynk. gor.	U38157	7-10
St.St. A2 (AISI304/18-8)		U51420	7-10
St.St. A4 (AISI316/18-10)		U55420	7-10

U38100		Podkładki USS niemetryczne				X09A		
Materiał		Stal						
Dla wymiaru nominalnego	☒	Kod artykułu	Dla wymiaru nominalnego	☒	Kod artykułu	Dla wymiaru nominalnego	☒	Kod artykułu
1/4*	100	U38100.025.0001	9/16*	25	U38100.056.0001	1.1/8*	5	U38100.112.0001
5/16*	100	U38100.031.0001	5/8*	25	U38100.062.0001	1.1/4*	5	U38100.125.0001
3/8*	100	U38100.037.0001	3/4*	20	U38100.075.0001	1.3/8*	5	U38100.137.0001
7/16*	50	U38100.043.0001	7/8*	10	U38100.087.0001	1.1/2*	5	U38100.150.0001
1/2*	50	U38100.050.0001	1 Inch*	5	U38100.100.0001			

U38130		Podkładki USS niemetryczne				X09A		
Materiał		Stal						
Obróbka powierzchni		Ocynkowane						
Dla wymiaru nominalnego	☒	Kod artykułu	Dla wymiaru nominalnego	☒	Kod artykułu	Dla wymiaru nominalnego	☒	Kod artykułu
1/4*	100	U38130.025.0001	9/16*	25	U38130.056.0001	1.1/8*	5	U38130.112.0001
5/16*	100	U38130.031.0001	5/8*	25	U38130.062.0001	1.1/4*	5	U38130.125.0001
3/8*	100	U38130.037.0001	3/4*	20	U38130.075.0001	1.3/8*	5	U38130.137.0001
7/16*	50	U38130.043.0001	7/8*	10	U38130.087.0001	1.1/2*	5	U38130.150.0001
1/2*	50	U38130.050.0001	1 Inch*	5	U38130.100.0001			

U38157		Podkładki USS niemetryczne				X09A		
Materiał		Stal						
Obróbka powierzchni		Ocynkowane na gorąco						
Dla wymiaru nominalnego	☒	Kod artykułu	Dla wymiaru nominalnego	☒	Kod artykułu	Dla wymiaru nominalnego	☒	Kod artykułu
1/4*	100	U38157.025.0001	9/16*	25	U38157.056.0001	1.1/8*	5	U38157.112.0001
5/16*	100	U38157.031.0001	5/8*	25	U38157.062.0001	1.1/4*	5	U38157.125.0001
3/8*	100	U38157.037.0001	3/4*	20	U38157.075.0001	1.3/8*	5	U38157.137.0001
7/16*	50	U38157.043.0001	7/8*	10	U38157.087.0001	1.1/2*	5	U38157.150.0001
1/2*	50	U38157.050.0001	1 Inch*	5	U38157.100.0001			

U51420		Podkładki USS niemetryczne				X15A		
Materiał		Stal nierdzewna A2 (AISI 304/18-8)						
Dla wymiaru nominalnego	☒	Kod artykułu	Dla wymiaru nominalnego	☒	Kod artykułu	Dla wymiaru nominalnego	☒	Kod artykułu
1/4*	50	U51420.025.0001	9/16*	25	U51420.056.0001	1.1/8*	5	U51420.112.0001
5/16*	50	U51420.031.0001	5/8*	25	U51420.062.0001	1.1/4*	5	U51420.125.0001
3/8*	50	U51420.037.0001	3/4*	20	U51420.075.0001	1.3/8*	5	U51420.137.0001
7/16*	25	U51420.043.0001	7/8*	5	U51420.087.0001	1.1/2*	5	U51420.150.0001
1/2*	25	U51420.050.0001	1 Inch*	5	U51420.100.0001			

U55420		Podkładki USS niemetryczne				X15A		
Materiał		Stal nierdzewna A4 (AISI 316/18-10)						
Dla wymiaru nominalnego	☒	Kod artykułu	Dla wymiaru nominalnego	☒	Kod artykułu	Dla wymiaru nominalnego	☒	Kod artykułu
1/4*	50	U55420.025.0001	1/2*	25	U55420.050.0001	1.1/8*	5	U55420.112.0001
5/16*	50	U55420.031.0001	5/8*	25	U55420.062.0001	1.1/4*	5	U55420.125.0001
3/8*	50	U55420.037.0001	7/8*	5	U55420.087.0001	1.3/8*	5	U55420.137.0001
7/16*	25	U55420.043.0001	1 Inch*	5	U55420.100.0001	1.1/2*	5	U55420.150.0001

Podkładki okrągłe

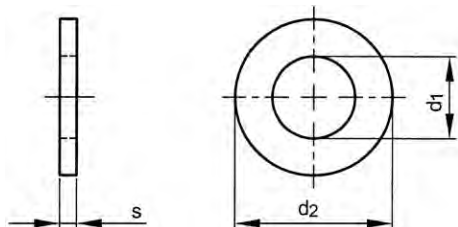

DIN 126
ISO 7091
NEN 2268
NF E25-513

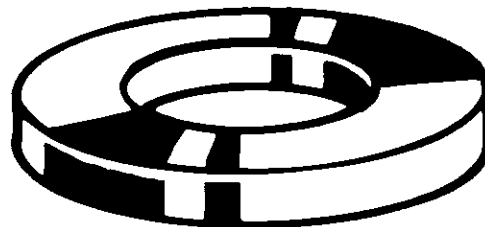

Informacje techniczne

Dla wymiaru nominalnego	d ₁	d ₂	s	Dla wymiaru nominalnego	d ₁	d ₂	s
M5	5.5	10	1	M33	36	60	5
M6	6.6	12	1.6	M36	39	66	5
M8	9	16	1.6	M39	42	72	6
M10	11	20	2	M42	45	78	7
M12	13.5	24	2.5	M45	48	85	7
M14	15.5	28	3	M48	52	92	8
M16	17.5	30	3	M52	56	98	8
M18	20	34	3	M56	62	105	9
M20	22	37	3	M60	66	110	9
M22	24	39	3	M64	70	115	9
M24	26	44	4	M72	78	125	10
M27	30	50	4	M80	86	140	12
M30	33	56	4	M90	96	160	12

Grupy katalogowe

Material	Obróbka powierzchni	Kod	Strona
St		38200	7-11
St	Ocynk.	38205	7-11
St	Ocynk. gor.	38740	7-12

38200 Podkładki okrągłe

L07G

Material Stal



Dla wymiaru nominalnego	☒	Kod artykułu	Dla wymiaru nominalnego	☒	Kod artykułu	Dla wymiaru nominalnego	☒	Kod artykułu
M5	1000	38200.050.001	M24	100	38200.240.001	M52	25	38200.520.001
M6	1000	38200.060.001	M27	100	38200.270.001	M56	25	38200.560.001
M8	1000	38200.080.001	M30	100	38200.300.001	M60	10	38200.600.001
M10	1000	38200.100.001	M33	100	38200.330.001	M64	10	38200.640.001
M12	500	38200.120.001	M36	100	38200.360.001	M72	10	38200.720.001
M14	250	38200.140.001	M39	50	38200.390.001	M80	5	38200.800.001
M16	250	38200.160.001	M42	50	38200.420.001	M90	5	38200.900.001
M20	200	38200.200.001	M45	25	38200.450.001			
M22	100	38200.220.001	M48	25	38200.480.001			

38205 Podkładki okrągłe

L07G

Material Stal
Obróbka powierzchni Ocynkowane



Dla wymiaru nominalnego	☒	Kod artykułu	Dla wymiaru nominalnego	☒	Kod artykułu	Dla wymiaru nominalnego	☒	Kod artykułu
M6	1000	38205.060.001	M18	200	38205.180.001	M30	100	38205.300.001
M8	1000	38205.080.001	M20	200	38205.200.001	M33	100	38205.330.001
M10	1000	38205.100.001	M22	200	38205.220.001	M36	100	38205.360.001
M12	500	38205.120.001	M24	100	38205.240.001	M39	50	38205.390.001
M14	100	38205.140.001	M27	100	38205.270.001	M52	10	38205.520.001
M16	250	38205.160.001						

38740	Podkładki okrągłe	A08G
Materiał	Stal	
Obróbka powierzchni	Ocynkowane na gorąco	

Dla wymiaru nominalnego	☒	Kod artykułu	Dla wymiaru nominalnego	☒	Kod artykułu	Dla wymiaru nominalnego	☒	Kod artykułu
M6	1000	38740.060.001	M22	100	38740.220.001	M42	50	38740.420.001
M8	1000	38740.080.001	M24	100	38740.240.001	M45	25	38740.450.001
M10	1000	38740.100.001	M27	100	38740.270.001	M48	25	38740.480.001
M12	500	38740.120.001	M30	100	38740.300.001	M52	25	38740.520.001
M14	100	38740.140.001	M33	100	38740.330.001	M56	25	38740.560.001
M16	250	38740.160.001	M36	100	38740.360.001	M60	10	38740.600.001
M18	250	38740.180.001	M39	50	38740.390.001	M64	10	38740.640.001
M20	200	38740.200.001						

Podkładki SAE niemetryczne

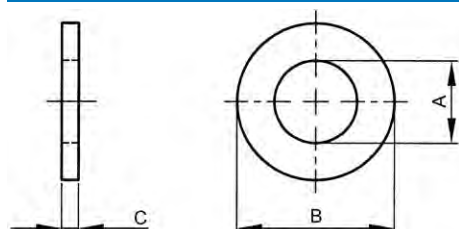

ASME B18.21.1

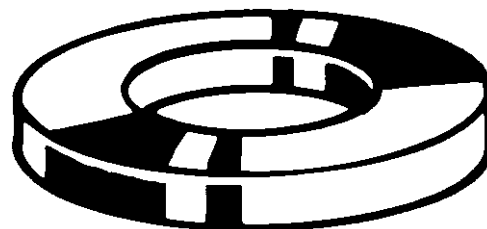

Informacje techniczne

Dla wymiaru nominalnego	A	B	C
1/4	0.281	0.625	0.065
5/16	0.344	0.688	0.065
3/8	0.406	0.812	0.065
7/16	0.469	0.922	0.065
1/2	0.531	1.062	0.095
9/16	0.594	1.156	0.095
5/8	0.656	1.312	0.095
3/4	0.812	1.469	0.134
7/8	0.938	1.750	0.134
1 Inch	1.062	2.000	0.134
1.1/8	1.250	2.250	0.134
1.1/4	1.375	2.500	0.165
1.3/8	1.500	2.750	0.165
1.1/2	1.625	3.000	0.165

Grupy katalogowe

Materiał	Obróbka powierzchni	Kod	Strona
St		U38200	7-12
St	Ocynk.	U38205	7-13
St.St. A2 (AISI304/18-8)		U51205	7-13
St.St. A4 (AISI316/18-10)		U55205	7-13

U38200	Podkładki SAE niemetryczne	X09A
Materiał	Stal	

Dla wymiaru nominalnego	☒	Kod artykułu	Dla wymiaru nominalnego	☒	Kod artykułu	Dla wymiaru nominalnego	☒	Kod artykułu
1/4*	100	U38200.025.0001	9/16*	25	U38200.056.0001	1.1/8*	5	U38200.112.0001
5/16*	100	U38200.031.0001	5/8*	25	U38200.062.0001	1.1/4*	5	U38200.125.0001
3/8*	100	U38200.037.0001	3/4*	20	U38200.075.0001	1.3/8*	5	U38200.137.0001
7/16*	50	U38200.043.0001	7/8*	10	U38200.087.0001	1.1/2*	5	U38200.150.0001
1/2*	50	U38200.050.0001	1 Inch*	5	U38200.100.0001			

U38205 Podkładki SAE niemetryczne		X09A
Materiał	Stal	
Obróbka powierzchni	Ocynkowane	

Dla wymiaru nominalnego	Kod artykułu	Dla wymiaru nominalnego	Kod artykułu	Dla wymiaru nominalnego	Kod artykułu
1/4*	100 U38205.025.0001	9/16*	25 U38205.056.0001	1.1/8*	5 U38205.112.0001
5/16*	100 U38205.031.0001	5/8*	25 U38205.062.0001	1.1/4*	5 U38205.125.0001
3/8*	100 U38205.037.0001	3/4*	20 U38205.075.0001	1.3/8*	5 U38205.137.0001
7/16*	50 U38205.043.0001	7/8*	10 U38205.087.0001	1.1/2*	5 U38205.150.0001
1/2*	50 U38205.050.0001	1 Inch*	5 U38205.100.0001		

U51205 Podkładki SAE niemetryczne		X15A
Materiał	Stal nierdzewna A2 (AISI 304/18-8)	

Dla wymiaru nominalnego	Kod artykułu	Dla wymiaru nominalnego	Kod artykułu	Dla wymiaru nominalnego	Kod artykułu
1/4*	50 U51205.025.0001	9/16*	25 U51205.056.0001	1.1/8*	5 U51205.112.0001
5/16*	50 U51205.031.0001	5/8*	25 U51205.062.0001	1.1/4*	5 U51205.125.0001
3/8*	50 U51205.037.0001	3/4*	20 U51205.075.0001	1.3/8*	5 U51205.137.0001
7/16*	25 U51205.043.0001	7/8*	5 U51205.087.0001	1.1/2*	5 U51205.150.0001
1/2*	25 U51205.050.0001	1 Inch*	5 U51205.100.0001		

U55205 Podkładki SAE niemetryczne		X15A
Materiał	Stal nierdzewna A4 (AISI 316/18-10)	

Dla wymiaru nominalnego	Kod artykułu	Dla wymiaru nominalnego	Kod artykułu	Dla wymiaru nominalnego	Kod artykułu
1/4*	50 U55205.025.0001	9/16*	25 U55205.056.0001	1.1/8*	5 U55205.112.0001
5/16*	50 U55205.031.0001	5/8*	25 U55205.062.0001	1.1/4*	5 U55205.125.0001
3/8*	50 U55205.037.0001	3/4*	20 U55205.075.0001	1.3/8*	5 U55205.137.0001
7/16*	25 U55205.043.0001	7/8*	5 U55205.087.0001	1.1/2*	5 U55205.150.0001
1/2*	25 U55205.050.0001	1 Inch*	5 U55205.100.0001		

Podkładki okrągłe, typ L

NF E25-513

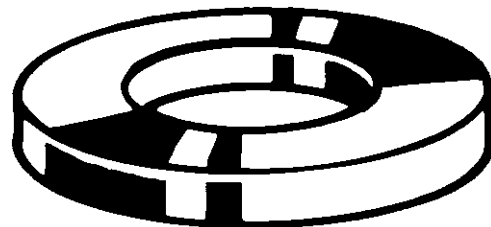
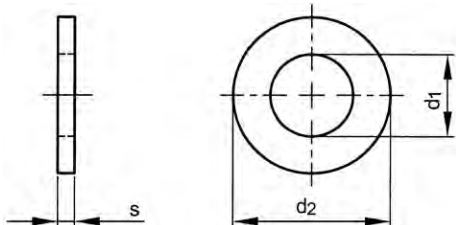

Informacje techniczne

Dla wymiaru nominalnego	d ₁ (min.)	d ₂ (maks.)	s	Dla wymiaru nominalnego	d ₁ (min.)	d ₂ (maks.)	s
M3	3.2	12	0.8	M14	15	36	2.5
M4	4.3	14	0.8	M16	17	40	3
M5	5.3	16	1	M18	19	45	3
M6	6.4	18	1.2	M20	21	50	3
M7	7.4	20	1.5	M22	23	55	3
M8	8.4	22	1.5	M24	25	60	4
M10	10.5	27	2	M27	28	65	4
M12	13	32	2.5	M30	31	70	4

Grupy katalogowe

Materiał	Obróbka powierzchni	Kod	Strona
St		38063	7-14
St	Ocynk.	38065	7-14
St	Ocynk. żłt. pas.	38067	7-15
St.St. A2		51418	7-15
St.St. A4		55418	7-15

38063 Podkładki okrągłe, typ L

L07G

Materiał Stal



Dla wymiaru nominalnego	☒	Kod artykułu	Dla wymiaru nominalnego	☒	Kod artykułu	Dla wymiaru nominalnego	☒	Kod artykułu
M3	500	38063.030.001	M10	200	38063.100.001	M20	100	38063.200.001
M4	500	38063.040.001	M12	200	38063.120.001	M22	100	38063.220.001
M5	500	38063.050.001	M14	200	38063.140.001	M24	100	38063.240.001
M6	500	38063.060.001	M16	100	38063.160.001	M27	100	38063.270.001
M7	250	38063.070.001	M18	100	38063.180.001	M30	100	38063.300.001
M8	250	38063.080.001						

38065 Podkładki okrągłe, typ L

L07G

Materiał Stal
Obróbka powierzchni Ocynkowane



Dla wymiaru nominalnego	☒	Kod artykułu	Dla wymiaru nominalnego	☒	Kod artykułu	Dla wymiaru nominalnego	☒	Kod artykułu
M3	500	38065.030.001	M10	200	38065.100.001	M20	100	38065.200.001
M4	500	38065.040.001	M12	200	38065.120.001	M22	100	38065.220.001
M5	500	38065.050.001	M14	200	38065.140.001	M24	100	38065.240.001
M6	500	38065.060.001	M16	100	38065.160.001	M27	100	38065.270.001
M7	250	38065.070.001	M18	100	38065.180.001	M30	100	38065.300.001
M8	250	38065.080.001						

38067	Podkładki okrągłe, typ L	L07G
Materiał	Stal	
Obróbka powierzchni	Ocynkowane, po żółtej pasywacji	

Dla wymiaru nominalnego	✉	Kod artykułu	Dla wymiaru nominalnego	✉	Kod artykułu	Dla wymiaru nominalnego	✉	Kod artykułu
M3	500	38067.030.001	M10	200	38067.100.001	M20	100	38067.200.001
M4	500	38067.040.001	M12	200	38067.120.001	M22	100	38067.220.001
M5	500	38067.050.001	M14	100	38067.140.001	M24	100	38067.240.001
M6	500	38067.060.001	M16	100	38067.160.001	M27	100	38067.270.001
M7	250	38067.070.001	M18	100	38067.180.001	M30	100	38067.300.001
M8	250	38067.080.001						

51418	Podkładki okrągłe, typ L	R05A
Materiał	Stal nierdzewna A2	
	NF ≈E25-513	

Dla wymiaru nominalnego	✉	Kod artykułu	Dla wymiaru nominalnego	✉	Kod artykułu	Dla wymiaru nominalnego	✉	Kod artykułu
M3	250	51418.030.001	M10	250	51418.100.001	M18	100	51418.180.001
M4	250	51418.040.001	M12	200	51418.120.001	M20	100	51418.200.001
M5	250	51418.050.001	M14	200	51418.140.001	M24	50	51418.240.001
M6	250	51418.060.001	M16	100	51418.160.001	M27	50	51418.270.001
M8	250	51418.080.001						

55418	Podkładki okrągłe, typ L	R45A
Materiał	Stal nierdzewna A4	
	NF ≈E25-513	

Dla wymiaru nominalnego	✉	Kod artykułu	Dla wymiaru nominalnego	✉	Kod artykułu	Dla wymiaru nominalnego	✉	Kod artykułu
M3	250	55418.030.001	M10	250	55418.100.001	M20	100	55418.200.001
M4	250	55418.040.001	M12	200	55418.120.001	M24	50	55418.240.001
M5	250	55418.050.001	M14	200	55418.140.001	M27	50	55418.270.001
M6	250	55418.060.001	M16	100	55418.160.001	M30	25	55418.300.001
M8	250	55418.080.001	M18	100	55418.180.001			

Podkładki okrągłe, typ LL

NF E25-513

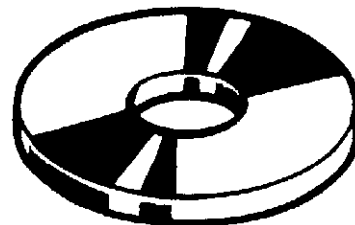
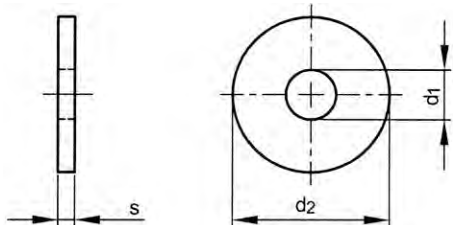

Informacje techniczne

Dla wymiaru nominalnego	d ₁ (min.)	d ₂ (maks.)	s	Dla wymiaru nominalnego	d ₁ (min.)	d ₂ (maks.)	s
M3	3.2	14	0.8	M14	15	45	2.5
M4	4.3	16	0.8	M16	17	50	3
M5	5.3	20	1	M18	19	55	3
M6	6.4	24	1.2	M20	21	60	3
M7	7.4	27	1.5	M22 (#NF)	23	65	3
M8	8.4	30	1.5	M24 (#NF)	25	70	4
M10	10.5	36	2	M27 (#NF)	28	78	4
M12	13	40	2.5	M30 (#NF)	31	80	4

Grupy katalogowe

Material	Obróbka powierzchni	Kod	Strona
St		38073	7-16
St	Ocynk.	38075	7-16
St	Ocynk. żłt. pas.	38077	7-17
St.St. A2		51419	7-17
St.St. A4		55419	7-17

38073 Podkładki okrągłe, typ LL

L07G

Material Stal



Dla wymiaru nominalnego	☒	Kod artykułu	Dla wymiaru nominalnego	☒	Kod artykułu	Dla wymiaru nominalnego	☒	Kod artykułu
M3	1000	38073.030.001	M10	200	38073.100.001	M20	100	38073.200.001
M4	500	38073.040.001	M12	200	38073.120.001	M22	100	38073.220.001
M5	500	38073.050.001	M14	100	38073.140.001	M24	100	38073.240.001
M6	250	38073.060.001	M16	100	38073.160.001	M27	100	38073.270.001
M7	250	38073.070.001	M18	100	38073.180.001	M30	100	38073.300.001
M8	250	38073.080.001						

38075 Podkładki okrągłe, typ LL

L07G

Material Stal
Obróbka powierzchni Ocynkowane



Dla wymiaru nominalnego	☒	Kod artykułu	Dla wymiaru nominalnego	☒	Kod artykułu	Dla wymiaru nominalnego	☒	Kod artykułu
M3	1000	38075.030.001	M10	200	38075.100.001	M20	100	38075.200.001
M4	500	38075.040.001	M12	200	38075.120.001	M22	100	38075.220.001
M5	500	38075.050.001	M14	100	38075.140.001	M24	100	38075.240.001
M6	250	38075.060.001	M16	100	38075.160.001	M27	100	38075.270.001
M7	250	38075.070.001	M18	100	38075.180.001	M30	100	38075.300.001
M8	250	38075.080.001						

38077	Podkładki okrągłe, typ LL	L07G
Materiał	Stal	
Obróbka powierzchni	Ocynkowane, po żółtej pasywacji	

Dla wymiaru nominalnego	✉	Kod artykułu	Dla wymiaru nominalnego	✉	Kod artykułu	Dla wymiaru nominalnego	✉	Kod artykułu
M3	1000	38077.030.001	M10	200	38077.100.001	M20	100	38077.200.001
M4	500	38077.040.001	M12	200	38077.120.001	M22	100	38077.220.001
M5	500	38077.050.001	M14	100	38077.140.001	M24	100	38077.240.001
M6	250	38077.060.001	M16	100	38077.160.001	M27	100	38077.270.001
M7	250	38077.070.001	M18	100	38077.180.001	M30	100	38077.300.001
M8	250	38077.080.001						

51419	Podkładki okrągłe, typ LL	R05A
Materiał	Stal nierdzewna A2	
	NF ≈E25-513	

Dla wymiaru nominalnego	✉	Kod artykułu	Dla wymiaru nominalnego	✉	Kod artykułu	Dla wymiaru nominalnego	✉	Kod artykułu
M3*	500	51419.030.001	M6	250	51419.060.001	M12	200	51419.120.001
M4	250	51419.040.001	M8	250	51419.080.001	M14	100	51419.140.001
M5	250	51419.050.001	M10	250	51419.100.001	M16	100	51419.160.001

55419	Podkładki okrągłe, typ LL	R45A
Materiał	Stal nierdzewna A4	
	NF ≈E25-513	

Dla wymiaru nominalnego	✉	Kod artykułu	Dla wymiaru nominalnego	✉	Kod artykułu	Dla wymiaru nominalnego	✉	Kod artykułu
M3*	500	55419.030.001	M6	250	55419.060.001	M12	200	55419.120.001
M4*	500	55419.040.001	M8	250	55419.080.001	M16*	50	55419.160.001
M5*	200	55419.050.001	M10	250	55419.100.001			

Podkładki okrągłe, typ M

NF E25-513

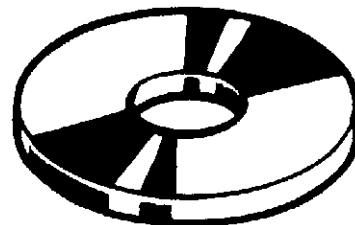
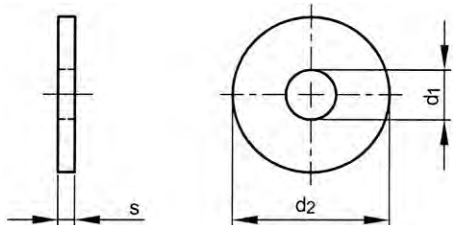



Informacje techniczne



Dla wymiaru nominalnego	d ₁ (min.)	d ₂ (maks.)	s	Dla wymiaru nominalnego	d ₁ (min.)	d ₂ (maks.)	s
M2	2.0	5.5	0.5	M20	21	40	3
M2.5 (#DIN)	2.7	7	0.5	M22	23	45	3
M3	3.2	8	0.8	M24	25	50	4
M4	4.3	10	0.8	M27	28	55	4
M5	5.3	12	1	M30	31	60	4
M6	6.4	14	1.2	M33	34	65	5
M7	7.4	16	1.5	M36	37	70	5
M8	8.4	18	1.5	M39	40	75	6
M10	10.5	22	2	M42	43	80	6
M12	13	27	2.5	M45	46	85	7
M14	15	30	2.5	M48	50	90	7
M16	17	32	3	M52	54	100	8
M18	19	36	3	M56 (#NF)	60	105	9

Grupy katalogowe

Materiał	Obróbka powierzchni	Kod	Strona
St		38053	7-18
St	Ocynk.	38055	7-18
St	Ocynk. żłt. pas.	38057	7-19
St.St. A2		51417	7-19
St.St. A4		55417	7-19

7

38053		Podkładki okrągłe, typ M				L07G		
Materiał	Stal							
Dla wymiaru nominalnego	☒	Kod artykułu	Dla wymiaru nominalnego	☒	Kod artykułu	Dla wymiaru nominalnego	☒	Kod artykułu
M3	500	38053.030.001	M14	200	38053.140.001	M33	100	38053.330.001
M4	500	38053.040.001	M16	100	38053.160.001	M36	100	38053.360.001
M5	500	38053.050.001	M18	100	38053.180.001	M39	100	38053.390.001
M6	500	38053.060.001	M20	100	38053.200.001	M42	100	38053.420.001
M7	250	38053.070.001	M22	100	38053.220.001	M45	100	38053.450.001
M8	250	38053.080.001	M24	100	38053.240.001	M48	25	38053.480.001
M10	200	38053.100.001	M27	100	38053.270.001	M52	25	38053.520.001
M12	200	38053.120.001	M30	100	38053.300.001	M56	25	38053.560.001

38055		Podkładki okrągłe, typ M				L07G		
Materiał	Stal							
Obróbka powierzchni	Ocynkowane							
Dla wymiaru nominalnego	☒	Kod artykułu	Dla wymiaru nominalnego	☒	Kod artykułu	Dla wymiaru nominalnego	☒	Kod artykułu
M3	500	38055.030.001	M12	200	38055.120.001	M27	100	38055.270.001
M4	500	38055.040.001	M14	200	38055.140.001	M30	100	38055.300.001
M5	500	38055.050.001	M16	100	38055.160.001	M33	100	38055.330.001
M6	500	38055.060.001	M18	100	38055.180.001	M36	100	38055.360.001
M7	250	38055.070.001	M20	100	38055.200.001	M39	100	38055.390.001
M8	250	38055.080.001	M22	100	38055.220.001	M42	100	38055.420.001
M10	200	38055.100.001	M24	100	38055.240.001	M45	100	38055.450.001

38057	Podkładki okrągłe, typ M	L07G
Materiał	Stal	
Obróbka powierzchni	Ocynkowane, po żółtej pasywacji	

Dla wymiaru nominalnego	✉	Kod artykułu	Dla wymiaru nominalnego	✉	Kod artykułu	Dla wymiaru nominalnego	✉	Kod artykułu
M3	500	38057.030.001	M14	200	38057.140.001	M30	100	38057.300.001
M4	500	38057.040.001	M16	100	38057.160.001	M33	100	38057.330.001
M5	500	38057.050.001	M18	100	38057.180.001	M36	100	38057.360.001
M6	500	38057.060.001	M20	100	38057.200.001	M39	100	38057.390.001
M7	250	38057.070.001	M22	100	38057.220.001	M42	100	38057.420.001
M8	250	38057.080.001	M24	100	38057.240.001	M45	100	38057.450.001
M10	200	38057.100.001	M27	100	38057.270.001	M48	50	38057.480.001
M12	200	38057.120.001						

51417	Podkładki okrągłe, typ M	R05A
Materiał	Stal nierdzewna A2	
	NF ≈E25-513	

Dla wymiaru nominalnego	✉	Kod artykułu	Dla wymiaru nominalnego	✉	Kod artykułu	Dla wymiaru nominalnego	✉	Kod artykułu
M2*	500	51417.020.001	M10	250	51417.100.001	M22	50	51417.220.001
M2,5	250	51417.025.001	M12	200	51417.120.001	M24	50	51417.240.001
M3	250	51417.030.001	M14	100	51417.140.001	M27	25	51417.270.001
M4	250	51417.040.001	M16	100	51417.160.001	M30	25	51417.300.001
M5	250	51417.050.001	M18	100	51417.180.001	M33	25	51417.330.001
M6	250	51417.060.001	M20	100	51417.200.001	M36	25	51417.360.001
M8	250	51417.080.001						

55417	Podkładki okrągłe, typ M	R45A
Materiał	Stal nierdzewna A4	
	NF ≈E25-513	

Dla wymiaru nominalnego	✉	Kod artykułu	Dla wymiaru nominalnego	✉	Kod artykułu	Dla wymiaru nominalnego	✉	Kod artykułu
M2*	500	55417.020.001	M10	250	55417.100.001	M22	50	55417.220.001
M2,5*	500	55417.025.001	M12	200	55417.120.001	M24	50	55417.240.001
M3	250	55417.030.001	M14	100	55417.140.001	M27	25	55417.270.001
M4	250	55417.040.001	M16	100	55417.160.001	M30	25	55417.300.001
M5	250	55417.050.001	M18	100	55417.180.001	M33	25	55417.330.001
M6	250	55417.060.001	M20	100	55417.200.001	M36	25	55417.360.001
M8	250	55417.080.001						

Podkładki okrągłe, typ Z

NF E25-513

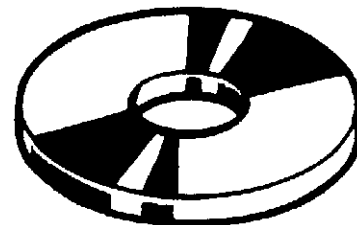
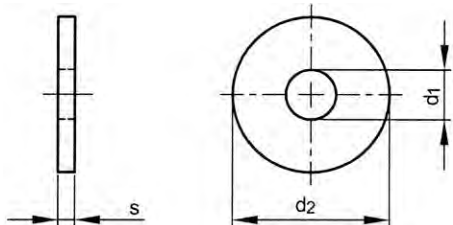

Informacje techniczne

Dla wymiaru nominalnego	d ₁ (min.)	d ₂ (maks.)	s	Dla wymiaru nominalnego	d ₁ (min.)	d ₂ (maks.)	s
M2	2.2	4	0.5	M12	13	24	2.5
M2.5	2.7	5	0.5	M14	15	27	2.5
M3	3.2	6	0.8	M16	17	30	3
M4	4.3	8	0.8	M18	19	32	3
M5	5.3	10	1	M20	21	36	3
M6	6.4	12	1.2	M22	23	40	3
M7	7.4	14	1.5	M24	25	45	4
M8	8.4	16	1.5	M27	28	48	4
M10	10.5	20	2	M30	31	52	4

Grupy katalogowe

Materiał	Obróbka powierzchni	Kod	Strona
St		38043	7-20
St	Ocynk.	38045	7-20
St	Ocynk. żłt. pas.	38047	7-21
St.St. A2		51416	7-21
St.St. A4		55416	7-21

38043 Podkładki okrągłe, typ Z

L07G

Materiał Stal



Dla wymiaru nominalnego	✉	Kod artykułu	Dla wymiaru nominalnego	✉	Kod artykułu	Dla wymiaru nominalnego	✉	Kod artykułu
M3	500	38043.030.001	M10	200	38043.100.001	M20	100	38043.200.001
M4	500	38043.040.001	M12	150	38043.120.001	M22	100	38043.220.001
M5	500	38043.050.001	M14	100	38043.140.001	M24	100	38043.240.001
M6	250	38043.060.001	M16	100	38043.160.001	M27	100	38043.270.001
M8	250	38043.080.001	M18	100	38043.180.001	M30	100	38043.300.001

38045 Podkładki okrągłe, typ Z

L07G

 Materiał Stal
 Obróbka powierzchni Ocynkowane

Dla wymiaru nominalnego	✉	Kod artykułu	Dla wymiaru nominalnego	✉	Kod artykułu	Dla wymiaru nominalnego	✉	Kod artykułu
M3	500	38045.030.001	M10	200	38045.100.001	M20	100	38045.200.001
M4	500	38045.040.001	M12	150	38045.120.001	M22	100	38045.220.001
M5	500	38045.050.001	M14	100	38045.140.001	M24	100	38045.240.001
M6	250	38045.060.001	M16	100	38045.160.001	M27	100	38045.270.001
M8	250	38045.080.001	M18	100	38045.180.001	M30	100	38045.300.001

38047	Podkładki okrągłe, typ Z	L07G
Materiał	Stal	
Obróbka powierzchni	Ocykowane, po żółtej pasywacji	

Dla wymiaru nominalnego	✉	Kod artykułu	Dla wymiaru nominalnego	✉	Kod artykułu	Dla wymiaru nominalnego	✉	Kod artykułu
M3	500	38047.030.001	M10	200	38047.100.001	M20	100	38047.200.001
M4	500	38047.040.001	M12	150	38047.120.001	M22	100	38047.220.001
M5	500	38047.050.001	M14	100	38047.140.001	M24	100	38047.240.001
M6	250	38047.060.001	M16	100	38047.160.001	M27	100	38047.270.001
M7	250	38047.070.001	M18	100	38047.180.001	M30	100	38047.300.001
M8	250	38047.080.001						

51416	Podkładki okrągłe, typ Z	R05A
Materiał	Stal nierdzewna A2	
	NF ≈E25-513	

Dla wymiaru nominalnego	✉	Kod artykułu	Dla wymiaru nominalnego	✉	Kod artykułu	Dla wymiaru nominalnego	✉	Kod artykułu
M2*	500	51416.020.001	M6	250	51416.060.001	M20	100	51416.200.001
M2,5*	500	51416.025.001	M8	250	51416.080.001	M24	50	51416.240.001
M3	250	51416.030.001	M10	200	51416.100.001	M27	25	51416.270.001
M4	250	51416.040.001	M12	200	51416.120.001	M30	25	51416.300.001
M5	250	51416.050.001	M16	100	51416.160.001			

55416	Podkładki okrągłe, typ Z	R45A
Materiał	Stal nierdzewna A4	
	NF ≈E25-513	

Dla wymiaru nominalnego	✉	Kod artykułu	Dla wymiaru nominalnego	✉	Kod artykułu	Dla wymiaru nominalnego	✉	Kod artykułu
M2*	500	55416.020.001	M6	250	55416.060.001	M16	100	55416.160.001
M2,5*	500	55416.025.001	M8	250	55416.080.001	M20	100	55416.200.001
M3	250	55416.030.001	M10	200	55416.100.001	M24	50	55416.240.001
M4	250	55416.040.001	M12	200	55416.120.001	M30	25	55416.300.001
M5	250	55416.050.001	M14*	50	55416.140.001			

Podkładki okrągłe do konstrukcji stalowych

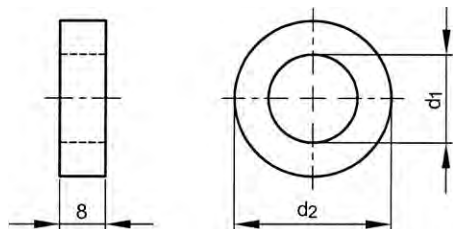

DIN 7989-1

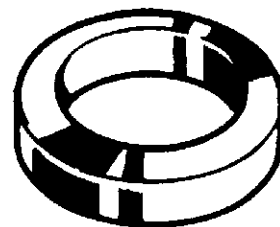

Informacje techniczne

Dla wymiaru nominalnego	d ₁	d ₂	Dla wymiaru nominalnego	d ₁	d ₂
M10	11	20	M24	26	44
M12	13.5	24	M27	30	50
M16	17.5	30	M30	33	56
M20	22	37	M33 (#DIN)	35	60
M22 (#DIN)	24	39	M36 (#DIN)	38	66

- Grubość 8 mm, nadaje się szczególnie do śrub z łbem sześciokątnym, do struktur stalowych, zgodn. z DIN 7990.

Grupy katalogowe

Materiał	Obróbka powierzchni	Kod	Strona
St	Ocyнк.	38280	7-22
St	Ocyнк. gor.	38270	7-22
St.St. A2		51415	7-22
St.St. A4		55415	7-23

38280 Podkładki okrągłe do konstrukcji stalowych

L07G

Materiał Stal
Obróbka powierzchni Ocyńkowane



Dla wymiaru nominalnego	☒	Kod artykułu	Dla wymiaru nominalnego	☒	Kod artykułu	Dla wymiaru nominalnego	☒	Kod artykułu
M10	500	38280.100.001	M20	100	38280.200.001	M30	50	38280.300.001
M12	500	38280.120.001	M24	100	38280.240.001	M33	25	38280.330.001
M16	250	38280.160.001	M27	50	38280.270.001	M36	25	38280.360.001

38270 Podkładki okrągłe do konstrukcji stalowych

A08G

Materiał Stal
Obróbka powierzchni Ocyńkowane na gorąco



Dla wymiaru nominalnego	☒	Kod artykułu	Dla wymiaru nominalnego	☒	Kod artykułu	Dla wymiaru nominalnego	☒	Kod artykułu
M10	500	38270.100.001	M20	100	38270.200.001	M30	50	38270.300.001
M12	500	38270.120.001	M24	100	38270.240.001	M36	50	38270.360.001
M16	250	38270.160.001	M27	50	38270.270.001			

51415 Podkładki okrągłe do konstrukcji stalowych

R05A

Materiał Stal nierdzewna A2



Dla wymiaru nominalnego	☒	Kod artykułu	Dla wymiaru nominalnego	☒	Kod artykułu	Dla wymiaru nominalnego	☒	Kod artykułu
M10*	50	51415.100.001	M20*	50	51415.200.001	M27*	25	51415.270.001
M12*	50	51415.120.001	M22*	50	51415.220.001	M30*	10	51415.300.001
M16*	50	51415.160.001	M24*	25	51415.240.001	M33*	10	51415.330.001

55415	Podkładki okrągłe do konstrukcji stalowych	R45A
Materiał	Stal nierdzewna A4	
		

Dla wymiaru nominalnego	☒	Kod artykułu	Dla wymiaru nominalnego	☒	Kod artykułu	Dla wymiaru nominalnego	☒	Kod artykułu
M10*	50	55415.100.001	M20*	50	55415.200.001	M27*	25	55415.270.001
M12*	50	55415.120.001	M22*	50	55415.220.001	M30*	10	55415.300.001
M16*	50	55415.160.001	M24*	25	55415.240.001			

Podkładki okrągłe zgrubne powiększone

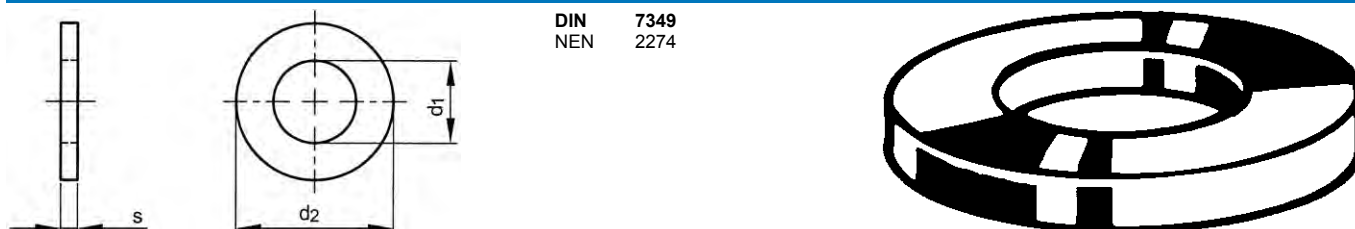

DIN 7349
NEN 2274

Informacje techniczne

Dla wymiaru nominalnego	d ₁	d ₂	s	Dla wymiaru nominalnego	d ₁	d ₂	s
M3	3.2	9	1	M16	17	40	6
M4	4.3	12	1.6	M18	19	44	8
M5	5.3	15	2	M20	21	44	8
M6	6.4	17	3	M22	23	50	8
M8	8.4	21	4	M24	25	50	10
M10	10.5	25	4	M27	28	60	10
M12	13	30	6	M30	31	68	10
M14	15	36	6				



- Te podkładki są stosowane w połączeniu z kołkami sprężystymi z rowkiem zgodn. z DIN 1481 (ISO 8752).



Grupy katalogowe



Materiał	Obróbka powierzchni	Kod	Strona
St		38420	7-23
St	Ocynk.	38430	7-24
St	Ocynk. żłt. pas.	38435	7-24
St	Ocynk. gor.	38438	7-24
St.St. A2		51532	7-24
St.St. A4		55532	7-24



38420	Podkładki okrągłe zgrubne powiększone	L07G
Materiał	Stal	
		



Dla wymiaru nominalnego	☒	Kod artykułu	Dla wymiaru nominalnego	☒	Kod artykułu	Dla wymiaru nominalnego	☒	Kod artykułu
M3	250	38420.030.001	M10	100	38420.100.001	M20	50	38420.200.001
M4	250	38420.040.001	M12	100	38420.120.001	M22	100	38420.220.001
M5	250	38420.050.001	M14	50	38420.140.001	M24	25	38420.240.001
M6	100	38420.060.001	M16	50	38420.160.001	M30	25	38420.300.001
M8	100	38420.080.001	M18	100	38420.180.001			

38430 Podkładki okrągłe zgrubne powiększone						L07G		
Materiał		Stal				 		
Obróbka powierzchni		Ocynkowane						
Dla wymiaru nominalnego	✉	Kod artykułu	Dla wymiaru nominalnego	✉	Kod artykułu	Dla wymiaru nominalnego	✉	Kod artykułu
M3	250	38430.030.001	M10	200	38430.100.001	M20	100	38430.200.001
M4	250	38430.040.001	M12	150	38430.120.001	M22	50	38430.220.001
M5	250	38430.050.001	M14	50	38430.140.001	M24	50	38430.240.001
M6	250	38430.060.001	M16	100	38430.160.001	M27	25	38430.270.001
M8	250	38430.080.001	M18	100	38430.180.001	M30	25	38430.300.001

38435 Podkładki okrągłe zgrubne powiększone						L07G		
Materiał		Stal				 		
Obróbka powierzchni		Ocynkowane, po żółtej pasywacji						
Dla wymiaru nominalnego	✉	Kod artykułu	Dla wymiaru nominalnego	✉	Kod artykułu	Dla wymiaru nominalnego	✉	Kod artykułu
M5	250	38435.050.001	M10	200	38435.100.001	M20	100	38435.200.001
M6	250	38435.060.001	M12	150	38435.120.001	M24	50	38435.240.001
M8	250	38435.080.001	M16	100	38435.160.001			

38438 Podkładki okrągłe zgrubne powiększone						L07G		
Materiał		Stal				 		
Obróbka powierzchni		Ocynkowane na gorąco						
Dla wymiaru nominalnego	✉	Kod artykułu	Dla wymiaru nominalnego	✉	Kod artykułu	Dla wymiaru nominalnego	✉	Kod artykułu
M5	250	38438.050.001	M12	150	38438.120.001	M22	50	38438.220.001
M6	250	38438.060.001	M16	100	38438.160.001	M24	50	38438.240.001
M8	250	38438.080.001	M18	100	38438.180.001	M30	50	38438.300.001
M10	200	38438.100.001	M20	100	38438.200.001			

51532 Podkładki okrągłe zgrubne powiększone						R09A		
Materiał		Stal nierdzewna A2				 		
Obróbka powierzchni								
Dla wymiaru nominalnego	✉	Kod artykułu	Dla wymiaru nominalnego	✉	Kod artykułu	Dla wymiaru nominalnego	✉	Kod artykułu
M3	100	51532.030.001	M10	100	51532.100.001	M18*	50	51532.180.001
M4	100	51532.040.001	M12	50	51532.120.001	M20	50	51532.200.001
M5	100	51532.050.001	M14*	100	51532.140.001	M22*	50	51532.220.001
M6	100	51532.060.001	M16	50	51532.160.001	M24*	50	51532.240.001
M8	100	51532.080.001						

55532 Podkładki okrągłe zgrubne powiększone						R49A		
Materiał		Stal nierdzewna A4				 		
Obróbka powierzchni								
Dla wymiaru nominalnego	✉	Kod artykułu	Dla wymiaru nominalnego	✉	Kod artykułu	Dla wymiaru nominalnego	✉	Kod artykułu
M3	100	55532.030.001	M8	100	55532.080.001	M16	50	55532.160.001
M4	100	55532.040.001	M10	100	55532.100.001	M20	50	55532.200.001
M5	100	55532.050.001	M12	50	55532.120.001	M22*	50	55532.220.001
M6	100	55532.060.001	M14*	100	55532.140.001	M24	50	55532.240.001

Podkładki do wkrętów o łbach walcowych i kulistych

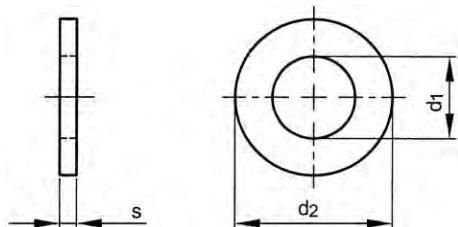

DIN 433
ISO 7092
NEN 2270

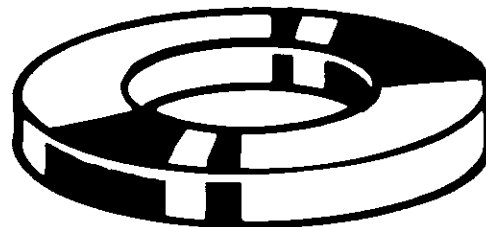

Informacje techniczne

Dla wymiaru nominalnego	d ₁	d ₂	s	Dla wymiaru nominalnego	d ₁	d ₂	s
M1.7	1.7	3.5	0.3	M6	6.4	11	1.6
M2.2	2.2	4.5	0.3	M8	8.4	15	1.6
M2	2.2	4.5	0.3	M10	10.5	18	1.6
M2.5	2.7	5.0	0.5	M12	13	20	2
M2.6 (#DIN)	2.7	5	0.5	M14	15	24	2.5
M3	3.2	6	0.5	M16	17	28	2.5
M3.5	3.7	7	0.5	M18	19	30	2.5
M4	4.3	8	0.5	M20	21	34	3
M5	5.3	9	1				

Grupy katalogowe

Material	Klasa	Obróbka powierzchni	Kolor	Kod	Strona
St		Ocynk.		38250	7-25
St.St. A2				51930	7-25
St.St. A4				55930	7-26
Mosiądz		Nikl.		50100	7-26
Plastik PA	PA 6.6		Biały	56320	7-26

38250 Podkładki do wkrętów o łbach walcowych i kulistych

L07G

Material Stal
Obróbka powierzchni Ocynkowane



Dla wymiaru nominalnego	☒	Kod artykułu	Dla wymiaru nominalnego	☒	Kod artykułu	Dla wymiaru nominalnego	☒	Kod artykułu
M2	500	38250.020.001	M6	250	38250.060.001	M14	100	38250.140.001
M2,6	500	38250.026.001	M8	200	38250.080.001	M16	100	38250.160.001
M3	250	38250.030.001	M10	200	38250.100.001	M18	100	38250.180.001
M4	250	38250.040.001	M12	100	38250.120.001	M20	100	38250.200.001
M5	250	38250.050.001						



51930 Podkładki do wkrętów o łbach walcowych i kulistych

R09A



Material Stal nierdzewna A2



Dla wymiaru nominalnego	☒	Kod artykułu	Dla wymiaru nominalnego	☒	Kod artykułu	Dla wymiaru nominalnego	☒	Kod artykułu
M1,7*	2000	51930.017.001	M5	500	51930.050.001	M14	100	51930.140.001
M2,5	500	51930.025.001	M6	500	51930.060.001	M16	100	51930.160.001
M3	500	51930.030.001	M8	200	51930.080.001	M18	100	51930.180.001
M3,5*	1000	51930.035.001	M10	200	51930.100.001	M20	100	51930.200.001
M4	500	51930.040.001	M12	100	51930.120.001			

55930	Podkładki do wkrętów o łbach walcowych i kulistych	R49A
Materiał	Stal nierdzewna A4	
		

Dla wymiaru nominalnego	☒	Kod artykułu	Dla wymiaru nominalnego	☒	Kod artykułu	Dla wymiaru nominalnego	☒	Kod artykułu
M2	100	55930.020.001	M5	500	55930.050.001	M14	100	55930.140.001
M2,5	100	55930.025.001	M6	500	55930.060.001	M16	100	55930.160.001
M3	500	55930.030.001	M8	200	55930.080.001	M18	100	55930.180.001
M3,5*	1000	55930.035.001	M10	200	55930.100.001	M20	100	55930.200.001
M4	500	55930.040.001	M12	100	55930.120.001			

50100	Podkładki do wkrętów o łbach walcowych i kulistych	M11F
Materiał	Mosiądz	
Obróbka powierzchni	Niklowane	

Dla wymiaru nominalnego	☒	Kod artykułu	Dla wymiaru nominalnego	☒	Kod artykułu	Dla wymiaru nominalnego	☒	Kod artykułu
M2	500	50100.020.001	M5	250	50100.050.001	M12	100	50100.120.001
M2,6	500	50100.026.001	M6	250	50100.060.001	M14	100	50100.140.001
M3	250	50100.030.001	M8	200	50100.080.001	M16	100	50100.160.001
M4	250	50100.040.001	M10	200	50100.100.001			

56320	Podkładki do wkrętów o łbach walcowych i kulistych	W02A		
Materiał	Plastik Poliamid (nylon)	DIN	≈433	
Klasa	PA 6.6	ISO	≈7092	
Kolor	Biały	NEN	≈2270	

Dla wymiaru nominalnego	☒	Kod artykułu	Dla wymiaru nominalnego	☒	Kod artykułu	Dla wymiaru nominalnego	☒	Kod artykułu
M3	200	56320.030.001	M5	200	56320.050.001	M8	200	56320.080.001
M4	200	56320.040.001	M6	200	56320.060.001	M10	100	56320.100.001

Podkładki okrągłe do sworzni

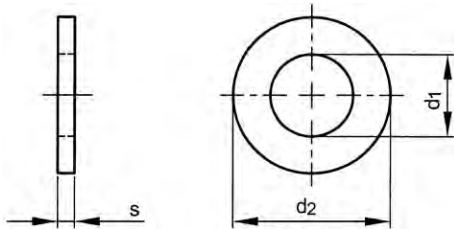

DIN 1440
ISO (8738)

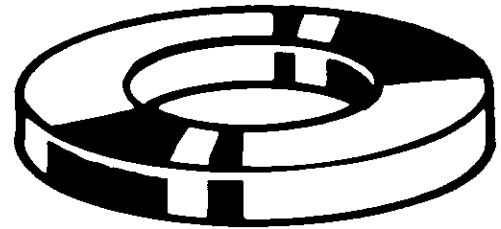

Informacje techniczne

Dla sworznia \varnothing	d_1 (H11)	d_2	s	Dla sworznia \varnothing	d_1 (H11)	d_2	s
3	3	6	0.8	20	20	32	4
4	4	8	0.8	22	22	34	4
5	5	10	0.8 (1)	23	23	36	4
6	6	12	1.6	24	24	38	4
7	7	14	1.6	25	25	40	4
8	8	16 (15)	2	26	26	40	5
10	10	20 (18)	2.5	27	27	40	5
12	12	25 (20)	3	28	28	42	5
13	13	25	3	30	30	45	5
14	14	28 (22)	3	32	32	50	5
16	16	28 (24)	3	35	35	52	6
18	18	30	4	40	40	58	6

- W zależności od dostępności może być dostarczone zgodn. z ISO 8738 z odpowiednimi wartościami określonymi w nawiasach.

Grupy katalogowe

Material	Obróbka powierzchni	Kod	Strona
St	Ocynk.	38760	7-27
St.St. A2		51534	7-27
St.St. A4		55534	7-28

38760 Podkładki okrągłe do sworzni

L07G

Material: Stal
Obróbka powierzchni: Ocynkowane



Dla sworznia \varnothing	☒	Kod artykułu	Dla sworznia \varnothing	☒	Kod artykułu	Dla sworznia \varnothing	☒	Kod artykułu
4MM	250	38760.040.001	14MM	150	38760.140.001	25MM	25	38760.250.001
5MM	250	38760.050.001	16MM	100	38760.160.001	26MM	25	38760.260.001
6MM	250	38760.060.001	18MM	100	38760.180.001	28MM	25	38760.280.001
8MM	250	38760.080.001	20MM	100	38760.200.001	30MM	25	38760.300.001
10MM	200	38760.100.001	22MM	50	38760.220.001			
12MM	150	38760.120.001	23MM	25	38760.230.001			

51534 Podkładki okrągłe do sworzni

R09A

Material: Stal nierdzewna A2



Dla sworznia \varnothing	☒	Kod artykułu	Dla sworznia \varnothing	☒	Kod artykułu	Dla sworznia \varnothing	☒	Kod artykułu
3MM*	500	51534.030.001	13MM*	100	51534.130.001	25MM*	50	51534.250.001
4MM	100	51534.040.001	14MM	50	51534.140.001	26MM*	50	51534.260.001
5MM	100	51534.050.001	16MM	50	51534.160.001	27MM*	50	51534.270.001
6MM	100	51534.060.001	18MM*	100	51534.180.001	28MM*	50	51534.280.001
7MM*	500	51534.070.001	20MM*	100	51534.200.001	30MM*	50	51534.300.001
8MM	100	51534.080.001	22MM*	100	51534.220.001	32MM*	50	51534.320.001
10MM	100	51534.100.001	23MM*	50	51534.230.001	35MM*	25	51534.350.001
12MM	100	51534.120.001	24MM*	50	51534.240.001	40MM*	25	51534.400.001

55534 Podkładki okrągłe do sworzni R45A

Materiał Stal nierdzewna A4

Dla sworznia \varnothing	☒	Kod artykułu	Dla sworznia \varnothing	☒	Kod artykułu	Dla sworznia \varnothing	☒	Kod artykułu
M3*	500	55534.030.001	M12*	200	55534.120.001	M24*	50	55534.240.001
M4*	500	55534.040.001	M13*	100	55534.130.001	M25*	50	55534.250.001
M5*	500	55534.050.001	M14*	100	55534.140.001	M26*	50	55534.260.001
M6*	500	55534.060.001	M16*	100	55534.160.001	M28*	50	55534.280.001
M7*	500	55534.070.001	M18*	100	55534.180.001	M30*	50	55534.300.001
M8*	200	55534.080.001	M20*	100	55534.200.001	M32*	50	55534.320.001
M10*	200	55534.100.001	M22*	100	55534.220.001			

Podkładki okrągłe do sworzni

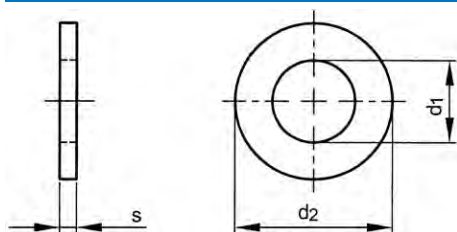

DIN 1441

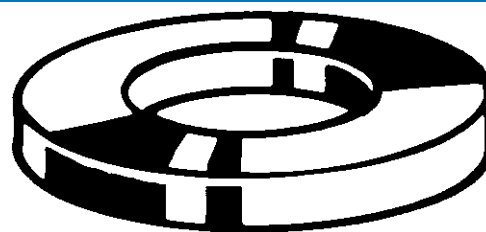

Informacje techniczne

Dla sworznia \varnothing	d_1	d_2	s	Dla sworznia \varnothing	d_1	d_2	s
5	5.5	10	0.8	24	25	38	4
6	7	12	1.6	25	26	40	4
7	8	14	1.6	26	27	40	5
8	9	16	2	28	29	42	5
10	11	20	2.5	30	31	45	5
12	13	25	3	33	34	50	5
13	13	25	3	36	37	52	6
14	15	28	3	40	41	58	6
16	17	28	3	50	51	68	8
18	19	30	4	60	62	80	9
20	21	32	4	70	72	95	10
22	23	34	4	75	78	100	10
23	24	36	4	80	82	110	12

Grupy katalogowe

Materiał	Kod	Strona
St	38958	7-28
St.St. A1	51535	7-29

38958 Podkładki okrągłe do sworzni L07G

Materiał Stal

Dla sworznia \varnothing	☒	Kod artykułu	Dla sworznia \varnothing	☒	Kod artykułu	Dla sworznia \varnothing	☒	Kod artykułu
12MM	500	38958.120.001	23MM	100	38958.230.001	40MM	100	38958.400.001
14MM	500	38958.140.001	25MM	100	38958.250.001	50MM	100	38958.500.001
16MM	500	38958.160.001	28MM	100	38958.280.001	60MM	25	38958.600.001
18MM	100	38958.180.001	30MM	100	38958.300.001	70MM	25	38958.700.001
20MM	100	38958.200.001	33MM	100	38958.330.001	75MM	25	38958.750.001
22MM	100	38958.220.001	36MM	100	38958.360.001	80MM	25	38958.800.001

51535	Podkładki okrągłe do sworzni	R05A
Materiał	Stal nierdzewna A1	

Dla sworznia \varnothing	☒	Kod artykułu	Dla sworznia \varnothing	☒	Kod artykułu	Dla sworznia \varnothing	☒	Kod artykułu
5MM*	200	51535.050.001	13MM*	100	51535.130.001	24MM*	50	51535.240.001
6MM*	100	51535.060.001	14MM*	100	51535.140.001	26MM*	25	51535.260.001
7MM*	100	51535.070.001	16MM*	100	51535.160.001	28MM*	25	51535.280.001
8MM*	100	51535.080.001	18MM*	50	51535.180.001	30MM*	25	51535.300.001
10MM*	100	51535.100.001	20MM*	50	51535.200.001			
12MM*	100	51535.120.001	22MM*	50	51535.220.001			

Podkładki okrągłe

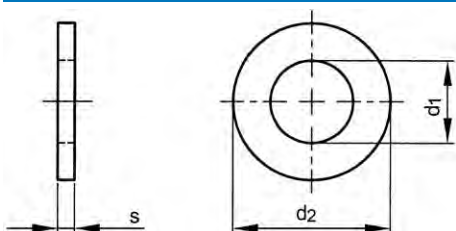

Informacje techniczne

Dla wymiaru nominalnego	d_1	d_2	s	Dla wymiaru nominalnego	d_1	d_2	s
M2	2.2	5.5	0.3	M10	10.3	22	1.5
M2.6	2.8	7	0.5	M12	13.2	28	2
M3	3.5	8	0.5	M14	14.8	31	2
M3.5	3.7	8	0.5	M16	16.5	34	2
M4	4.2	9	0.6	M20	21	40	2.5
M5	5.2	12	0.7	M22	22.8	46	2.5
M6	6.5	14	0.8	M24	26.5	52	3
M8	8.5	18	1.5				

Grupy katalogowe

Materiał	Obróbka powierzchni	Kod	Strona
Al		45180	7-29
Mosiądz	Nikl.	50020	7-29
Mosiądz	Nikl.	Duże Opakowanie	7-30

45180	Podkładki okrągłe	W01A
Materiał	Aluminium	

Dla wymiaru nominalnego	☒	Kod artykułu	Dla wymiaru nominalnego	☒	Kod artykułu	Dla wymiaru nominalnego	☒	Kod artykułu
M4	1000	45180.040.001	M8	250	45180.080.001	M16	100	45180.160.001
M5	1000	45180.050.001	M10	250	45180.100.001	M20	50	45180.200.001
M6	1000	45180.060.001	M12	100	45180.120.001			

50020	Podkładki okrągłe	M11F
Materiał	Mosiądz	
Obróbka powierzchni	Niklowane	

Dla wymiaru nominalnego	☒	Kod artykułu	Dla wymiaru nominalnego	☒	Kod artykułu	Dla wymiaru nominalnego	☒	Kod artykułu
M2	500	50020.020.001	M3,5	250	50020.035.001	M6	250	50020.060.001
M2,6	500	50020.026.001	M4	250	50020.040.001			
M3	250	50020.030.001	M5	250	50020.050.001			

50030	Podkładki okrągłe	M11F
Materiał	Mosiądz	
Obróbka powierzchni	Niklowane	
		

Dla wymiaru nominalnego	☒	Kod artykułu	Dla wymiaru nominalnego	☒	Kod artykułu	Dla wymiaru nominalnego	☒	Kod artykułu
M8	250	50030.080.001	M14	100	50030.140.001	M22	50	50030.220.001
M10	250	50030.100.001	M16	100	50030.160.001	M24	50	50030.240.001
M12	100	50030.120.001	M20	50	50030.200.001			

Podkładki okrągłe AG3

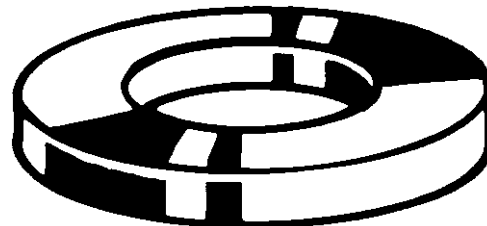
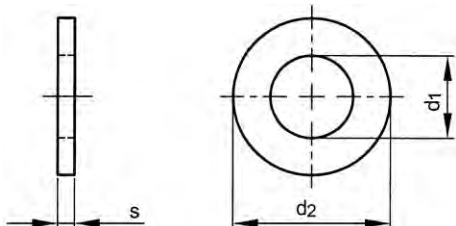

Informacje techniczne

Dla wymiaru nominalnego	d ₁	d ₂	s
M3	3.5	8	0.8
M4	4.5	10	0.8
M5	5.5	12	1
M6	6.25	14	1.2
M8	8.25	18	1.5
M10	10.25	22	2

45150	Plain washer Aluminum	W01A
Materiał	Aluminium Sopral A-G3	
Obróbka powierzchni	Anodyzowane	

Dla wymiaru nominalnego	☒	Kod artykułu	Dla wymiaru nominalnego	☒	Kod artykułu	Dla wymiaru nominalnego	☒	Kod artykułu
M3	500	45150.030.001	M5	500	45150.050.001	M8	250	45150.080.001
M4	500	45150.040.001	M6	500	45150.060.001	M10	200	45150.100.001

7

Podkładki płaskie 200HV

ISO 7089

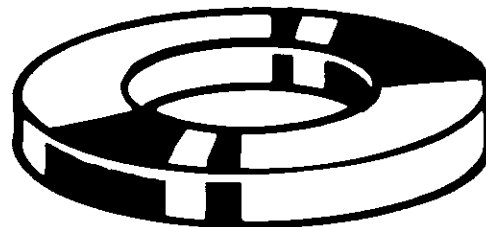
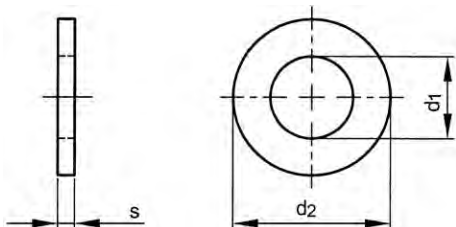

Informacje techniczne

Dla wymiaru nominalnego	d_1	d_2	s
M3	3.2	7	0.5
M4	4.3	9	0.8
M5	5.3	10	1
M6	6.4	12	1.6
M8	8.4	16	1.6
M10	10.5	20	2
M12	13	24	2.5
M14	15	28	2.5
M16	17	30	3
M18	19	34	3
M20	21	37	3
M22	23	39	3
M24	25	44	4
M27	28	50	4
M30	31	56	4
M33	34	60	5
M36	37	66	5
M39	42	72	6
M42	45	78	8
M45	48	85	8

Grupy katalogowe

Material	Obróbka powierzchni	Kod	Strona
St 200HV	Ocynk.	38131	7-31
St 200HV	Ocynk. gor.	38133	7-31
St.St. A4		55425	7-32

38131 Podkładki płaskie 200HV

L01A

Material: Stal 200HV
Obróbka powierzchni: Ocynkowane



Dla wymiaru nominalnego	☒	Kod artykułu	Dla wymiaru nominalnego	☒	Kod artykułu	Dla wymiaru nominalnego	☒	Kod artykułu
M10	500	38131.100.001	M20	100	38131.200.001	M30	50	38131.300.001
M12	500	38131.120.001	M24	50	38131.240.001	M36	50	38131.360.001
M16	250	38131.160.001	M27	50	38131.270.001			



38133 Podkładki płaskie 200HV

L01A

Material: Stal 200HV
Obróbka powierzchni: Ocynkowane na gorąco



Dla wymiaru nominalnego	☒	Kod artykułu	Dla wymiaru nominalnego	☒	Kod artykułu	Dla wymiaru nominalnego	☒	Kod artykułu
M10	500	38133.100.001	M20	100	38133.200.001	M30	50	38133.300.001
M12	500	38133.120.001	M24	50	38133.240.001	M36	50	38133.360.001
M16	250	38133.160.001	M27	50	38133.270.001			

55425	Podkładki płaskie 200 HV, A4	R45A
Materiał	Stal nierdzewna A4	 

Dla wymiaru nominalnego	☒	Kod artykułu	Dla wymiaru nominalnego	☒	Kod artykułu	Dla wymiaru nominalnego	☒	Kod artykułu
M3*	1000	55425.030.001	M14*	200	55425.140.001	M30*	50	55425.300.001
M4*	1000	55425.040.001	M16*	200	55425.160.001	M33*	25	55425.330.001
M5*	1000	55425.050.001	M18*	200	55425.180.001	M36*	25	55425.360.001
M6*	500	55425.060.001	M20*	200	55425.200.001	M39*	25	55425.390.001
M8*	500	55425.080.001	M22*	100	55425.220.001	M42*	25	55425.420.001
M10*	200	55425.100.001	M24*	100	55425.240.001	M45*	10	55425.450.001
M12*	200	55425.120.001	M27*	50	55425.270.001			

Podkładki płaskie





Informacje techniczne

Dla wymiaru nominalnego	d ₁	d ₂	s
M3	3.2	9	0.8
M3.5	3.7	11	0.8
M4	4.3	12	1
M5	5.3	15	1
M6	6.4	18	1.6
M8	8.4	24	2
M10	10.5	30	2.5
M12	13	37	3
M14	15	44	3
M16	17	50	3
M18	19	56	4
M20	21	60	4
M22	23	66	5
M24	25	72	5
M30	33	92	6

Grupy katalogowe

Materiał	Kod	Strona
St.St. A2	51531	7-32
St.St. A4	55531	7-33

51531	Podkładki płaskie	R05A
Materiał	Stal nierdzewna A2	 

Dla wymiaru nominalnego	☒	Kod artykułu	Dla wymiaru nominalnego	☒	Kod artykułu	Dla wymiaru nominalnego	☒	Kod artykułu
M3*	1000	51531.030.001	M8*	500	51531.080.001	M18*	50	51531.180.001
M3,5*	1000	51531.035.001	M10*	200	51531.100.001	M20*	50	51531.200.001
M4*	1000	51531.040.001	M12*	200	51531.120.001	M22*	50	51531.220.001
M5*	1000	51531.050.001	M14*	100	51531.140.001	M24*	25	51531.240.001
M6*	500	51531.060.001	M16*	100	51531.160.001	M30*	25	51531.300.001

55531	Podkładki płaskie	R45A
Materiał	Stal nierdzewna A4	
		 

Dla wymiaru nominalnego	☒	Kod artykułu	Dla wymiaru nominalnego	☒	Kod artykułu	Dla wymiaru nominalnego	☒	Kod artykułu
M3*	1000	55531.030.001	M10*	200	55531.100.001	M20*	50	55531.200.001
M4*	1000	55531.040.001	M12*	200	55531.120.001	M22*	50	55531.220.001
M5*	1000	55531.050.001	M14*	100	55531.140.001	M24*	25	55531.240.001
M6*	500	55531.060.001	M16*	100	55531.160.001	M30*	25	55531.300.001
M8*	500	55531.080.001	M18*	50	55531.180.001			

Podkładki okrągłe ścięte

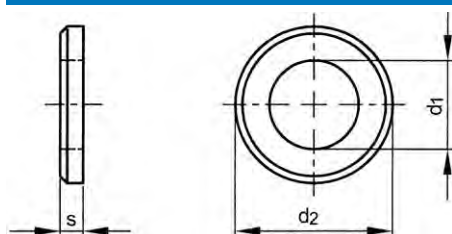

DIN 125-1B
ISO 7090
NEN 2269 B

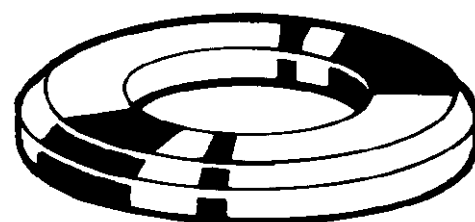

Informacje techniczne

Dla wymiaru nominalnego	d ₁	d ₂	s	Dla wymiaru nominalnego	d ₁	d ₂	s
M2.5	2.7	6	0.5	M24	25	44	4
M3	3.2	7	0.5	M27	28	50	4
M4	4.3	9	0.8	M30	31	56	4
M5	5.3	10	1	M33	34	60	5
M6	6.4	12	1.6	M36	37	66	5
M7	7.4	14	1.6	M39	40	72	6
M8	8.4	16	1.6	M42	43	78	7
M10	10.5	20	2	M45	46	85	7
M12	13	24	2.5	M48	50	92	8
M14	15	28	2.5	M52	54	98	8
M16	17	30	3	M56	58	105	9
M18	19	34	3	M60	62	110	9
M20	21	37	3	M64	66	115	9
M22	23	39	3				

Grupy katalogowe

Materiał	Obróbka powierzchni	Kod	Strona
St 140HV		38160	7-33
St 140HV	Ocyнк.	38180	7-34
St 140HV	Ocyнк.	Duże Opakowanie	7-34
St.St. A4		55426	7-34
Mosiądz		50040	7-34
Mosiądz	Nikl.	50150	7-34

38160	Podkładki okrągłe ścięte	L07G
Materiał	Stal 140HV	
		 

Dla wymiaru nominalnego	☒	Kod artykułu	Dla wymiaru nominalnego	☒	Kod artykułu	Dla wymiaru nominalnego	☒	Kod artykułu
M4	250	38160.040.001	M18	100	38160.180.001	M42	10	38160.420.001
M5	250	38160.050.001	M20	100	38160.200.001	M45	10	38160.450.001
M6	250	38160.060.001	M22	50	38160.220.001	M48	10	38160.480.001
M7	250	38160.070.001	M24	50	38160.240.001	M52	5	38160.520.001
M8	250	38160.080.001	M27	25	38160.270.001	M56	5	38160.560.001
M10	200	38160.100.001	M30	25	38160.300.001	M60	5	38160.600.001
M12	150	38160.120.001	M33	25	38160.330.001	M64	5	38160.640.001
M14	100	38160.140.001	M36	25	38160.360.001			
M16	100	38160.160.001	M39	10	38160.390.001			

38180 Podkładki okrągłe ścięte		L07G
Materiał	Stal 140HV	
Obróbka powierzchni	Ocynkowane	
		

Dla wymiaru nominalnego	☒	Kod artykułu	Dla wymiaru nominalnego	☒	Kod artykułu	Dla wymiaru nominalnego	☒	Kod artykułu
M4	250	38180.040.001	M18	100	38180.180.001	M42	10	38180.420.001
M5	250	38180.050.001	M20	100	38180.200.001	M45	10	38180.450.001
M6	250	38180.060.001	M22	50	38180.220.001	M48	10	38180.480.001
M7	250	38180.070.001	M24	50	38180.240.001	M52	5	38180.520.001
M8	250	38180.080.001	M27	25	38180.270.001	M56	5	38180.560.001
M10	200	38180.100.001	M30	25	38180.300.001	M60	5	38180.600.001
M12	150	38180.120.001	M33	25	38180.330.001	M64	5	38180.640.001
M14	100	38180.140.001	M36	25	38180.360.001			
M16	100	38180.160.001	M39	10	38180.390.001			

38190 Podkładki okrągłe ścięte		L07G
Materiał	Stal 140HV	
Obróbka powierzchni	Ocynkowane	
		

Dla wymiaru nominalnego	☒	Kod artykułu	Dla wymiaru nominalnego	☒	Kod artykułu	Dla wymiaru nominalnego	☒	Kod artykułu
M5	2500	38190.050.001	M8	2000	38190.080.001	M12	500	38190.120.001
M6	2000	38190.060.001	M10	1000	38190.100.001	M16	400	38190.160.001

55426 Podkładki okrągłe ścięte		R45A
Materiał	Stal nierdzewna A4	

Dla wymiaru nominalnego	☒	Kod artykułu	Dla wymiaru nominalnego	☒	Kod artykułu	Dla wymiaru nominalnego	☒	Kod artykułu
M5	250	55426.050.001	M12	200	55426.120.001	M27	25	55426.270.001
M6	250	55426.060.001	M16	100	55426.160.001	M30	25	55426.300.001
M8	250	55426.080.001	M20	100	55426.200.001			
M10	200	55426.100.001	M24	50	55426.240.001			

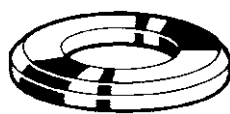
50040 Podkładki okrągłe ścięte		M11F
Materiał	Mosiądz	

Dla wymiaru nominalnego	☒	Kod artykułu	Dla wymiaru nominalnego	☒	Kod artykułu	Dla wymiaru nominalnego	☒	Kod artykułu
M3	250	50040.030.001	M10	100	50040.100.001	M20	50	50040.200.001
M4	250	50040.040.001	M12	100	50040.120.001	M22	50	50040.220.001
M5	250	50040.050.001	M14	100	50040.140.001	M24	50	50040.240.001
M6	250	50040.060.001	M16	100	50040.160.001	M27	50	50040.270.001
M7	250	50040.070.001	M18	100	50040.180.001	M30	25	50040.300.001
M8	250	50040.080.001						

50150 Podkładki okrągłe ścięte		M11F
Materiał	Mosiądz	
Obróbka powierzchni	Niklowane	
		

Dla wymiaru nominalnego	☒	Kod artykułu	Dla wymiaru nominalnego	☒	Kod artykułu	Dla wymiaru nominalnego	☒	Kod artykułu
M2,5	250	50150.025.001	M5	250	50150.050.001	M10	100	50150.100.001
M3	250	50150.030.001	M6	250	50150.060.001	M12	100	50150.120.001
M4	250	50150.040.001	M8	250	50150.080.001	M16	100	50150.160.001

7

Podkładki płaskie

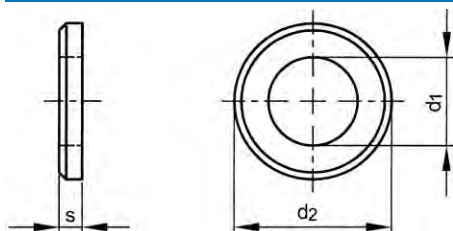

ISO 7090

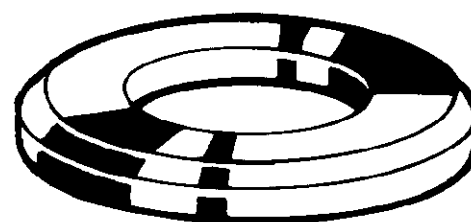

Informacje techniczne

Dla wymiaru nominalnego	d_1	d_2	s
M5	5.3	10	1
M6	6.4	12	1.6
M8	8.4	16	1.6
M10	10.5	20	2
M12	13	24	2.5
M14	15	28	2.5
M16	17	30	3
M18	19	34	3
M20	21	37	3
M22	23	39	3
M24	25	44	4
M27	28	50	4
M30	31	56	4
M33	34	60	5
M36	37	66	5

Grupy katalogowe

Material	Kod	Strona
St.St. A2	51427	7-35
St.St. A4	55427	7-35

51427	Podkładki płaskie	R05A
Material	Stal nierdzewna A2	
		

Dla wymiaru nominalnego	☒	Kod artykułu	Dla wymiaru nominalnego	☒	Kod artykułu	Dla wymiaru nominalnego	☒	Kod artykułu
M5*	200	51427.050.001	M14*	100	51427.140.001	M24*	50	51427.240.001
M6*	200	51427.060.001	M16*	100	51427.160.001	M27*	25	51427.270.001
M8*	200	51427.080.001	M18*	100	51427.180.001	M30*	25	51427.300.001
M10*	100	51427.100.001	M20*	50	51427.200.001	M33*	10	51427.330.001
M12*	100	51427.120.001	M22*	50	51427.220.001	M36*	10	51427.360.001

55427	Podkładki płaskie	R45A
Material	Stal nierdzewna A4	
		

Dla wymiaru nominalnego	☒	Kod artykułu	Dla wymiaru nominalnego	☒	Kod artykułu	Dla wymiaru nominalnego	☒	Kod artykułu
M5*	200	55427.050.001	M14*	100	55427.140.001	M22*	50	55427.220.001
M6*	200	55427.060.001	M16*	100	55427.160.001	M24*	50	55427.240.001
M8*	200	55427.080.001	M18*	100	55427.180.001	M27*	25	55427.270.001
M10*	100	55427.100.001	M20*	50	55427.200.001	M30*	25	55427.300.001
M12*	100	55427.120.001						

Podkładki powiększone, stal nierdzewna

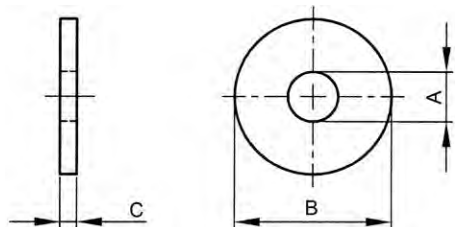

ASME ≈B18.21.1

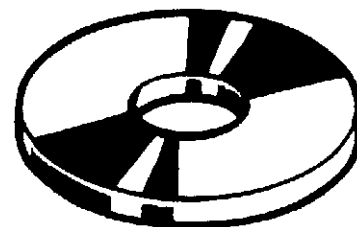

Informacje techniczne

Dla wymiaru nominalnego	A	B	C
U51530.013.0001 NO.6	0.1560	0.6250	0.0310
U51530.013.0002 NO.6	0.1560	0.5630	0.0470
U51530.019.0001 NO.10	0.2190	0.5000	0.0470
U51530.019.0002 NO.10	0.2190	0.6880	0.0470
U51530.025.0001 1/4	0.2810	0.5000	0.0470
U51530.025.0002 1/4	0.2810	0.5630	0.0650
U51530.025.0006 1/4	0.2850	1.2500	0.1250
U51530.031.0001 5/16	0.3480	0.6250	0.0650
U55530.013.0001 NO.6	0.1560	0.5630	0.0470
U55530.019.0002 NO.10	0.2190	0.6880	0.0470
U55530.025.0001 1/4	0.2810	0.5000	0.0470
U55530.025.0002 1/4	0.2810	0.5630	0.0650
U55530.031.0001 5/16	0.3480	0.6250	0.0650

Grupy katalogowe

Material	Kod	Strona
St.St. A2 (AISI304/18-8)	U51530	7-36
St.St. A4 (AISI316/18-10)	U55530	7-36

U51530 Podkładki powiększone, stal nierdzewna X15A

Material Stal nierdzewna A2 (AISI 304/18-8)



Dla wymiaru nominalnego	Kod artykułu	Dla wymiaru nominalnego	Kod artykułu	Dla wymiaru nominalnego	Kod artykułu
NO.6*	50 U51530.013.0001	NO.10*	50 U51530.019.0002	1/4*	50 U51530.025.0006
NO.6*	50 U51530.013.0002	1/4*	50 U51530.025.0001	5/16*	50 U51530.031.0001
NO.10*	50 U51530.019.0001	1/4*	50 U51530.025.0002		

U55530 Podkładki powiększone, stal nierdzewna X15A

Material Stal nierdzewna A4 (AISI 316/18-10)



Dla wymiaru nominalnego	Kod artykułu	Dla wymiaru nominalnego	Kod artykułu	Dla wymiaru nominalnego	Kod artykułu
NO.6*	50 U55530.013.0001	1/4*	50 U55530.025.0001	5/16*	50 U55530.031.0001
NO.10*	50 U55530.019.0002	1/4*	50 U55530.025.0002		

Podkładki powiększone niemetryczne

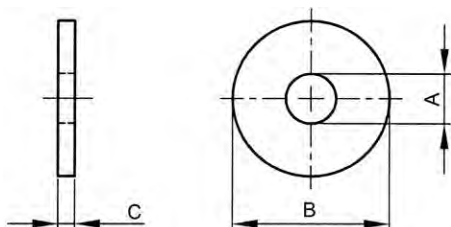

ASME ≈B18.21.1

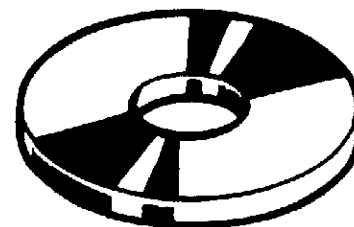

Informacje techniczne

Dla wymiaru nominalnego	A	B	C
U38160.013.0002 NO.6	0.1560	0.5630	0.0470
U38160.016.0001 NO.8	0.1880	0.7500	0.0470
U38160.019.0002 NO.10	0.2190	0.6880	0.0470
U38160.019.0008 NO.10	0.2190	1.0000	0.1250
U38160.019.0009 NO.10	0.2190	1.0000	0.2500
U38160.025.0001 1/4	0.2850	0.5000	0.0470
U38160.025.0002 1/4	0.2850	0.5630	0.0470
U38160.025.0008 1/4	0.2850	1.5000	0.1250
U38160.025.0009 1/4	0.2850	1.5000	0.2500
U38160.031.0001 5/16	0.3480	0.6250	0.0470
U38160.031.0008 5/16	0.3480	2.0000	0.1250
U38160.031.0009 5/16	0.3480	2.0000	0.2500
U38160.037.0005 3/8	0.4100	2.0000	0.1250
U38160.037.0006 3/8	0.4100	2.0000	0.2500
U38160.050.0003 1/2	0.5350	2.0000	0.1250
U38160.050.0004 1/2	0.5350	2.0000	0.2500
U38160.050.0006 1/2	0.5350	3.0000	0.2500
U38160.062.0001 5/8	0.6880	2.5000	0.1250
U38160.062.0002 5/8	0.6880	2.5000	0.2500
U38160.062.0003 5/8	0.6880	3.0000	0.2500
U38160.075.0001 3/4	0.7810	3.0000	0.1250
U38160.075.0002 3/4	0.7810	3.0000	0.2500
U38160.075.0003 3/4	0.7810	3.0000	0.3750
U38160.087.0001 7/8	0.9380	3.0000	0.2500
U38160.087.0002 7/8	0.9380	3.2500	0.1250
U38160.087.0003 7/8	0.9380	3.2500	0.2500
U38160.087.0004 7/8	0.9380	3.2500	0.3750
U38160.100.0001 1	1.0630	3.2500	0.2500
U38160.100.0002 1	1.0630	3.5000	0.1250
U38160.100.0003 1	1.0630	3.5000	0.2500
U38160.100.0004 1	1.0630	3.5000	0.3750
U38160.125.0001 1.1/4	1.3750	4.0000	0.5000

7

U38160 Podkładki powiększone niemetryczne		X09A
Materiał	Stal	 

Dla wymiaru nominalnego	✉	Kod artykułu	Dla wymiaru nominalnego	✉	Kod artykułu	Dla wymiaru nominalnego	✉	Kod artykułu
NO.6*	100	U38160.013.0002	5/16*	100	U38160.031.0009	3/4*	20	U38160.075.0003
NO.8*	100	U38160.016.0001	3/8*	100	U38160.037.0005	7/8*	10	U38160.087.0001
NO.10*	100	U38160.019.0002	3/8*	100	U38160.037.0006	7/8*	10	U38160.087.0002
NO.10*	100	U38160.019.0008	1/2*	50	U38160.050.0003	7/8*	10	U38160.087.0003
NO.10*	100	U38160.019.0009	1/2*	50	U38160.050.0004	7/8*	10	U38160.087.0004
1/4*	100	U38160.025.0001	1/2*	50	U38160.050.0006	1 Inch*	5	U38160.100.0001
1/4*	100	U38160.025.0002	5/8*	25	U38160.062.0001	1 Inch*	5	U38160.100.0002
1/4*	100	U38160.025.0008	5/8*	25	U38160.062.0002	1 Inch*	5	U38160.100.0003
1/4*	100	U38160.025.0009	5/8*	25	U38160.062.0003	1 Inch*	5	U38160.100.0004
5/16*	100	U38160.031.0001	3/4*	20	U38160.075.0001	1.1/4*	5	U38160.125.0001
5/16*	100	U38160.031.0008	3/4*	20	U38160.075.0002			

Podkładki okrągłe powiększone $\approx 3 \times d_1$

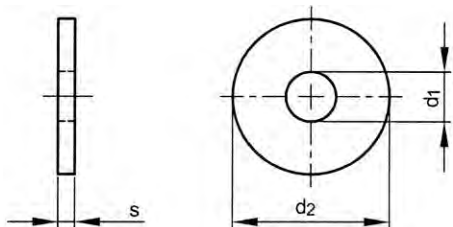

DIN 9021
ISO 7093
NEN 2276
NF E25-513

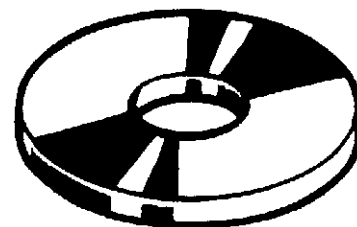

Informacje techniczne

Dla wymiaru nominalnego	d ₁ (min.)	d ₂ (maks.)	s	Dla wymiaru nominalnego	d ₁ (min.)	d ₂ (maks.)	s
M2 (#DIN)	2.2	7	0.8	M10	10.5	30	2.5
M2.5	2.7	8	0.8	M12	13	37	3
M3	3.2	9	0.8	M14	15	44	3
M3.5	3.7	11	0.8	M16	17	50	3
M4	4.3	12	1	M18	20	56	4
M5	5.3	15	1.2	M20	22	60	4
M6	6.4	18	1.6	M24	26	72	5
M7	7.4	22	2	M30	33	92	6
M8	8.4	24	2	M36	39	110	8

Grupy katalogowe

Materiał	Klasa	Obróbka powierzchni	Kolor	Kod	Strona
St				38209	7-38
St		Ocynk.		38210	7-38
St		Ocynk.	Duże Opakowanie	38220	7-39
St		Ocynk. żłt. pas.		38211	7-39
St		Ocynk. gor.		38212	7-39
St.St. A2				51530	7-39
St.St. A4				55530	7-39
Plastik PA	PA 6.6		Czarny	56332	7-40
Plastik PA	PA 6.6		Biały	56330	7-40

7

38209 Podkładki okrągłe powiększone $\approx 3 \times d_1$ L01A

Materiał Stal



Dla wymiaru nominalnego	Kod artykułu	Dla wymiaru nominalnego	Kod artykułu	Dla wymiaru nominalnego	Kod artykułu
M4 500	38209.040.001	M8 200	38209.080.001	M14 100	38209.140.001
M5 200	38209.050.001	M10 200	38209.100.001	M16 100	38209.160.001
M6 200	38209.060.001	M12 100	38209.120.001	M20 100	38209.200.001

38210 Podkładki okrągłe powiększone $\approx 3 \times d_1$ L01A

Materiał Stal
Obróbka powierzchni Ocynkowane



Dla wymiaru nominalnego	Kod artykułu	Dla wymiaru nominalnego	Kod artykułu	Dla wymiaru nominalnego	Kod artykułu
M3 250	38210.030.001	M7 250	38210.070.001	M16 100	38210.160.001
M3,5 250	38210.035.001	M8 250	38210.080.001	M18 100	38210.180.001
M4 250	38210.040.001	M10 200	38210.100.001	M20 100	38210.200.001
M5 250	38210.050.001	M12 200	38210.120.001	M24 100	38210.240.001
M6 250	38210.060.001	M14 100	38210.140.001	M30 50	38210.300.001

38220 Podkładki okrągłe powiększone ≈ 3 x d1		L01A
Materiał	Stal	
Obróbka powierzchni	Ocynkowane	

Dla wymiaru nominalnego	✉	Kod artykułu	Dla wymiaru nominalnego	✉	Kod artykułu	Dla wymiaru nominalnego	✉	Kod artykułu
M4	2500	38220.040.001	M7	2000	38220.070.001	M12	500	38220.120.001
M5	2500	38220.050.001	M8	1000	38220.080.001			
M6	2000	38220.060.001	M10	750	38220.100.001			

38211 Podkładki okrągłe powiększone ≈ 3 x d1		L01A
Materiał	Stal	
Obróbka powierzchni	Ocynkowane, po żółtej pasywacji	

Dla wymiaru nominalnego	✉	Kod artykułu	Dla wymiaru nominalnego	✉	Kod artykułu	Dla wymiaru nominalnego	✉	Kod artykułu
M3	250	38211.030.001	M7	250	38211.070.001	M14	100	38211.140.001
M4	250	38211.040.001	M8	250	38211.080.001	M16	100	38211.160.001
M5	250	38211.050.001	M10	200	38211.100.001	M20	100	38211.200.001
M6	250	38211.060.001	M12	200	38211.120.001	M24	100	38211.240.001

38212 Podkładki okrągłe powiększone ≈ 3 x d1		L01A
Materiał	Stal	
Obróbka powierzchni	Ocynkowane na gorąco	

Dla wymiaru nominalnego	✉	Kod artykułu	Dla wymiaru nominalnego	✉	Kod artykułu	Dla wymiaru nominalnego	✉	Kod artykułu
M8	200	38212.080.001	M16	100	38212.160.001	M30	25	38212.300.001
M10	200	38212.100.001	M20	100	38212.200.001			
M12	100	38212.120.001	M24	50	38212.240.001			

51530 Podkładki okrągłe powiększone ≈ 3 x d1		R05A
Materiał	Stal nierdzewna A2	

Dla wymiaru nominalnego	✉	Kod artykułu	Dla wymiaru nominalnego	✉	Kod artykułu	Dla wymiaru nominalnego	✉	Kod artykułu
M2*	1000	51530.020.001	M6	200	51530.060.001	M16	200	51530.160.001
M2,5*	1000	51530.025.001	M7*	500	51530.070.001	M18	200	51530.180.001
M3	200	51530.030.001	M8	200	51530.080.001	M20	200	51530.200.001
M3,5*	1000	51530.035.001	M10	200	51530.100.001	M24	25	51530.240.001
M4	200	51530.040.001	M12	200	51530.120.001	M30*	25	51530.300.001
M5	200	51530.050.001	M14	200	51530.140.001	M36*	10	51530.360.001

55530 Podkładki okrągłe powiększone ≈ 3 x d1		R45A
Materiał	Stal nierdzewna A4	

Dla wymiaru nominalnego	✉	Kod artykułu	Dla wymiaru nominalnego	✉	Kod artykułu	Dla wymiaru nominalnego	✉	Kod artykułu
M2*	1000	55530.020.001	M6	200	55530.060.001	M16	200	55530.160.001
M2,5*	1000	55530.025.001	M7*	500	55530.070.001	M18	50	55530.180.001
M3	200	55530.030.001	M8	200	55530.080.001	M20	200	55530.200.001
M3,5*	1000	55530.035.001	M10	200	55530.100.001	M24	25	55530.240.001
M4	200	55530.040.001	M12	200	55530.120.001	M30	25	55530.300.001
M5	200	55530.050.001	M14	200	55530.140.001			

56332 Podkładki okrągłe powiększone ≈ 3 x d1						W02A		
Materiał	Plastik Poliamid (nylon)							
Klasa	PA 6.6							
Kolor	Czarny							
Dla wymiaru nominalnego	✉	Kod artykułu	Dla wymiaru nominalnego	✉	Kod artykułu	Dla wymiaru nominalnego	✉	Kod artykułu
M3	200	56332.030.001	M6	200	56332.060.001	M12	100	56332.120.001
M4	200	56332.040.001	M8	200	56332.080.001			
M5	200	56332.050.001	M10	100	56332.100.001			

56330 Podkładki okrągłe powiększone ≈ 3 x d1						W02A		
Materiał	Plastik Poliamid (nylon)							
Klasa	PA 6.6							
Kolor	Biały							
Dla wymiaru nominalnego	✉	Kod artykułu	Dla wymiaru nominalnego	✉	Kod artykułu	Dla wymiaru nominalnego	✉	Kod artykułu
M3	200	56330.030.009	M6	200	56330.060.017	M10	100	56330.100.030
M4	200	56330.040.012	M6 (s=2)	200	56330.060.018	M12 (d2=40)	100	56330.120.040
M5	200	56330.050.015	M8	200	56330.080.025	M16	100	56330.160.050

Podkładki okrągłe do konstrukcji drewnianych

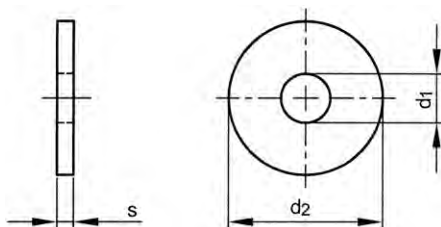

DIN 440 R
ISO 7094
NEN 2275
NF E25-513

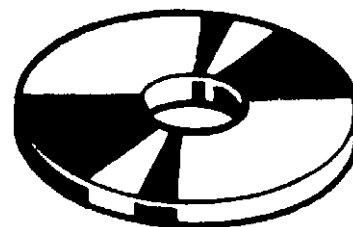

7

Informacje techniczne

Dla wymiaru nominalnego	d ₁	d ₂	s	Dla wymiaru nominalnego	d ₁	d ₂	s
M5	5.5	18	2	M16	17.5	56	5
M6	6.6	22	2	M20	22	72	6
M8	9	28	3	M22	24	80	6
M10	11	34	3	M24	26	85	6
M12	13.5	44	4	M27	30	98	6
M14	15.5	50	4	M30	33	105	6

Grupy katalogowe

Materiał	Obróbka powierzchni	Kod	Strona
St	Ocynk.	38240	7-40
St	Ocynk. gor.	38230	7-41
St.St. A2		51590	7-41
St.St. A4		55590	7-41

38240 Podkładki okrągłe do konstrukcji drewnianych						L07G		
Materiał	Stal							
Obróbka powierzchni	Ocynkowane							
Dla wymiaru nominalnego	✉	Kod artykułu	Dla wymiaru nominalnego	✉	Kod artykułu	Dla wymiaru nominalnego	✉	Kod artykułu
M5	100	38240.050.001	M12	100	38240.120.001	M27	25	38240.270.001
M6	100	38240.060.001	M16	100	38240.160.001	M30	25	38240.300.001
M8	100	38240.080.001	M20	50	38240.200.001			
M10	100	38240.100.001	M24	25	38240.240.001			



38230 Podkładki okrągłe do konstrukcji drewnianych		A08G
Materiał	Stal	
Obróbka powierzchni	Ocykowane na gorąco	

Dla wymiaru nominalnego	⊗	Kod artykułu	Dla wymiaru nominalnego	⊗	Kod artykułu	Dla wymiaru nominalnego	⊗	Kod artykułu
M5	100	38230.050.001	M12	100	38230.120.001	M27	25	38230.270.001
M6	100	38230.060.001	M16	100	38230.160.001	M30	25	38230.300.001
M8	100	38230.080.001	M20	50	38230.200.001			
M10	100	38230.100.001	M24	25	38230.240.001			

51590 Podkładki okrągłe do konstrukcji drewnianych		R09A
Materiał	Stal nierdzewna A2	
	DIN ≈440R ISO ≈7094 NEN ≈2275 NF ≈E25-513	

Dla wymiaru nominalnego	⊗	Kod artykułu	Dla wymiaru nominalnego	⊗	Kod artykułu	Dla wymiaru nominalnego	⊗	Kod artykułu
M5	50	51590.050.001	M12	50	51590.120.001	M22*	25	51590.220.001
M6	50	51590.060.001	M14*	50	51590.140.001	M24	10	51590.240.001
M8	50	51590.080.001	M16	50	51590.160.001			
M10	50	51590.100.001	M20	25	51590.200.001			

55590 Podkładki okrągłe do konstrukcji drewnianych		R49A
Materiał	Stal nierdzewna A4	
	DIN ≈440R ISO ≈7094 NEN ≈2275 NF ≈E25-513	

Dla wymiaru nominalnego	⊗	Kod artykułu	Dla wymiaru nominalnego	⊗	Kod artykułu	Dla wymiaru nominalnego	⊗	Kod artykułu
M5	50	55590.050.001	M10	50	55590.100.001	M20	25	55590.200.001
M6	50	55590.060.001	M12	50	55590.120.001	M22*	25	55590.220.001
M8	50	55590.080.001	M16	50	55590.160.001	M24	10	55590.240.001

Podkładki pod konstrukcje drewniane

DIN 440V

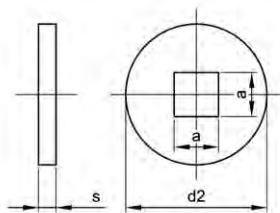

Informacje techniczne

Dla wymiaru nominalnego	a	d ₂	s
M5	5.5	18	2
M6	6.6	22	2
M8	9	28	3
M10	11	34	3
M12	14	44	4
M16	18	56	5
M20	22	72	6

Grupy katalogowe

Material	Kod	Strona
St.St. A2	51577	7-42
St.St. A4	55577	7-42

51577 Podkładki pod konstrukcje drewniane R09A

Material Stal nierdzewna A2



Dla wymiaru nominalnego	☒	Kod artykułu	Dla wymiaru nominalnego	☒	Kod artykułu	Dla wymiaru nominalnego	☒	Kod artykułu
M5*	100	51577.050.001	M10*	50	51577.100.001	M20*	25	51577.200.001
M6*	100	51577.060.001	M12*	50	51577.120.001			
M8*	100	51577.080.001	M16*	50	51577.160.001			

55577 Podkładki pod konstrukcje drewniane R49A

Material Stal nierdzewna A4



Dla wymiaru nominalnego	☒	Kod artykułu	Dla wymiaru nominalnego	☒	Kod artykułu	Dla wymiaru nominalnego	☒	Kod artykułu
M8*	100	55577.080.001	M10*	50	55577.100.001	M12*	50	55577.120.001

7

Podkładki okrągłe do konstrukcji drewnianych

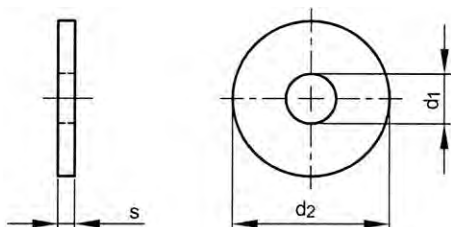

DIN 1052

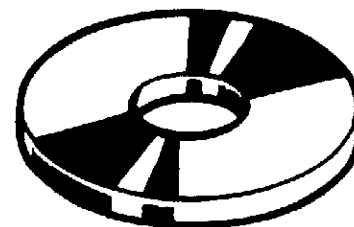

Informacje techniczne

d	d ₁	d ₂	s
M12	14	58	6
M16	18	68	6
M20	23	80	8
M22	25	92	8
M24	27	105	8

Grupy katalogowe

Material	Kod	Strona
St.St. A2	51533	7-43
St.St. A4	55533	7-43

51533 Podkładki okrągłe do konstrukcji drewnianych

R05A

Material Stal nierdzewna A2



d	☒	Kod artykułu	d	☒	Kod artykułu	d	☒	Kod artykułu
M12*	50	51533.120.001	M20*	25	51533.200.001	M24*	25	51533.240.001
M16*	50	51533.160.001	M22*	25	51533.220.001			

55533 Podkładki okrągłe do konstrukcji drewnianych

R45A

Material Stal nierdzewna A4



d	☒	Kod artykułu	d	☒	Kod artykułu	d	☒	Kod artykułu
M12*	50	55533.120.001	M20*	25	55533.200.001	M24*	25	55533.240.001
M16*	50	55533.160.001	M22*	25	55533.220.001			

Podkładki okrągłe powiększone

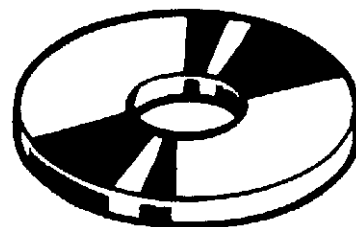
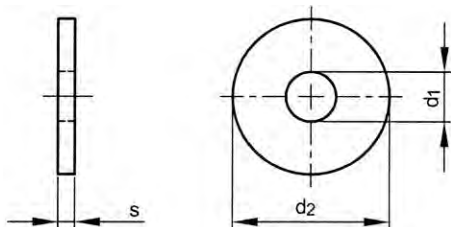

Informacje techniczne

Dla wymiaru nominalnego	d ₁	s	Dla wymiaru nominalnego	d ₁	s
M3	3.3	0.8	M14	14.5	2
M4	4.2	1.2	M16	16.5	2.5
M5	5.2	1.3	M17	17.2	2.5
M6	6.5	1.5	M20	20.2	2.5
M7	7.4	1.5	M22	24	4
M8	8.4	1.5	M24	25	4
M10	10.5	1.5	M27	28	4
M11	11.5	1.5	M30	32	4
M12	12.5	2			

Grupy katalogowe

Material	Obróbka powierzchni	Kod	Strona
St	Ocynk.	38400	7-44
St	Ocynk.	38410	7-44
St	Ocynk. żłt. pas.	38401	7-45
St.St. A2		51410	7-45
St.St. A4		55410	7-45

38400 Podkładki okrągłe powiększone

L01A

Material Stal
Obróbka powierzchni Ocynkowane



Dla wymiaru nominalnego x d ₂	⊗	Kod artykułu	Dla wymiaru nominalnego x d ₂	⊗	Kod artykułu	Dla wymiaru nominalnego x d ₂	⊗	Kod artykułu
M3X10	100	38400.030.010	M8X25	100	38400.080.025	M12X60	100	38400.120.060
M4X20	100	38400.040.020	M8X30	100	38400.080.030	M14X36	100	38400.140.036
M4X30	250	38400.040.030	M8X35	100	38400.080.035	M14X40	100	38400.140.040
M5X20	100	38400.050.020	M8X38	100	38400.080.038	M14X45	100	38400.140.045
M5X25	100	38400.050.025	M8X40	100	38400.080.040	M16X40	100	38400.160.040
M5X30	100	38400.050.030	M8X45	100	38400.080.045	M16X45	100	38400.160.045
M6X14	100	38400.060.014	M8X50	100	38400.080.050	M16X50	100	38400.160.050
M6X20	100	38400.060.020	M10X30	100	38400.100.030	M17X40	100	38400.170.040
M6X25	100	38400.060.025	M10X35	100	38400.100.035	M17X45	100	38400.170.045
M6X27	100	38400.060.027	M10X38	100	38400.100.038	M20X50	100	38400.200.050
M6X30	100	38400.060.030	M10X40	100	38400.100.040	M20X55	100	38400.200.055
M6X35	100	38400.060.035	M10X50	100	38400.100.050	M22X75	50	38400.220.075
M6X38	100	38400.060.038	M10X50(s=3)	100	38400.100.051	M24X80	50	38400.240.080
M6X40	100	38400.060.040	M10X60	100	38400.100.060	M24X85	50	38400.240.085
M7X20	100	38400.070.020	M11X35	100	38400.110.035	M27X85	25	38400.270.085
M7X25	100	38400.070.025	M12X30	100	38400.120.030	M30X95	25	38400.300.095
M7X30	100	38400.070.030	M12X36	100	38400.120.036			
M8X20	250	38400.080.020	M12X40	100	38400.120.040			

38410 Podkładki okrągłe powiększone

L01A

Material Stal
Obróbka powierzchni Ocynkowane



Dla wymiaru nominalnego x d ₂	⊗	Kod artykułu	Dla wymiaru nominalnego x d ₂	⊗	Kod artykułu	Dla wymiaru nominalnego x d ₂	⊗	Kod artykułu
M4X20	2000	38410.040.020	M6X25	700	38410.060.025	M8X30	700	38410.080.030
M5X20	1000	38410.050.020	M6X30	700	38410.060.030	M10X30	700	38410.100.030
M5X30	1000	38410.050.030	M8X25	700	38410.080.025			

38401	Podkładki okrągłe powiększone	L01A
Materiał	Stal	
Obróbka powierzchni	Ocykowane, po żółtej pasywacji	

Dla wymiaru nominalnego x d ₂	✉	Kod artykułu	Dla wymiaru nominalnego x d ₂	✉	Kod artykułu	Dla wymiaru nominalnego x d ₂	✉	Kod artykułu
M3X10	100	38401.030.010	M6X30	100	38401.060.030	M10X30	100	38401.100.030
M4X20	100	38401.040.020	M6X40	100	38401.060.040	M12X36	100	38401.120.036
M5X20	100	38401.050.020	M7X25	100	38401.070.025	M14X36	100	38401.140.036
M5X25	100	38401.050.025	M8X25	100	38401.080.025	M16X50	100	38401.160.050
M5X30	100	38401.050.030	M8X30	100	38401.080.030	M20X55	100	38401.200.055
M6X25	100	38401.060.025	M8X40	100	38401.080.040	M24X85	50	38401.240.085

51410	Podkładki okrągłe powiększone	R05A
Materiał	Stal nierdzewna A2	

Dla wymiaru nominalnego x d ₂	✉	Kod artykułu	Dla wymiaru nominalnego x d ₂	✉	Kod artykułu	Dla wymiaru nominalnego x d ₂	✉	Kod artykułu
M4X12*	500	51410.040.012	M6X40	200	51410.060.040	M10X30	200	51410.100.030
M4X15*	500	51410.040.015	M6X45*	200	51410.060.045	M10X35	200	51410.100.035
M4X20	200	51410.040.020	M6X50*	200	51410.060.050	M10X40	100	51410.100.040
M4X25*	200	51410.040.025	M6X55*	200	51410.060.055	M10X45*	200	51410.100.045
M5X15*	500	51410.050.015	M8X20	200	51410.080.020	M10X50*	200	51410.100.050
M5X20	200	51410.050.020	M8X25	200	51410.080.025	M12X30	200	51410.120.030
M5X25	200	51410.050.025	M8X30	200	51410.080.030	M12X35*	200	51410.120.035
M5X30*	200	51410.050.030	M8X35*	200	51410.080.035	M12X36	200	51410.120.036
M6X18	200	51410.060.018	M8X40	200	51410.080.040	M12X40*	200	51410.120.040
M6X20	200	51410.060.020	M8X45*	200	51410.080.045	M12X45*	200	51410.120.045
M6X25	200	51410.060.025	M8X50*	200	51410.080.050	M12X50*	200	51410.120.050
M6X30	200	51410.060.030	M8X55*	200	51410.080.055	M16X40	200	51410.160.040
M6X35*	200	51410.060.035	M10X25	200	51410.100.025	M16X50	200	51410.160.050

55410	Podkładki okrągłe powiększone	R45A
Materiał	Stal nierdzewna A4	

Dla wymiaru nominalnego x d ₂	✉	Kod artykułu	Dla wymiaru nominalnego x d ₂	✉	Kod artykułu	Dla wymiaru nominalnego x d ₂	✉	Kod artykułu
M4X12*	500	55410.040.012	M6X25	200	55410.060.025	M10X25*	200	55410.100.025
M4X15*	500	55410.040.015	M6X30	200	55410.060.030	M10X30X1,5	200	55410.100.030
M4X20	200	55410.040.020	M6X35*	200	55410.060.035	M10X35*	200	55410.100.035
M4X25*	200	55410.040.025	M6X40*	200	55410.060.040	M10X40*	200	55410.100.040
M5X15*	500	55410.050.015	M8X20	200	55410.080.020	M12X30	200	55410.120.030
M5X20	200	55410.050.020	M8X25	200	55410.080.025	M12X35*	200	55410.120.035
M5X24*	200	55410.050.025	M8X30	200	55410.080.030	M12X36	200	55410.120.036
M5X30*	200	55410.050.030	M8X35*	200	55410.080.035	M12X40*	200	55410.120.040
M6X20*	500	55410.060.020	M8X40*	200	55410.080.040	M16X40	200	55410.160.040

Podkładki powiększone niemetryczne

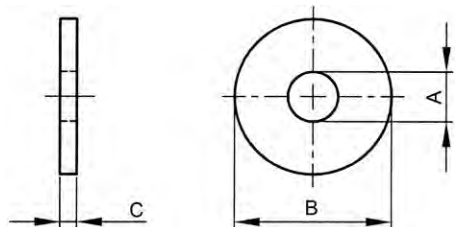

ASME ≈B18.21.1

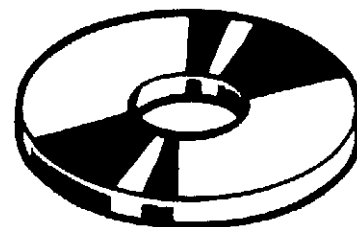

Informacje techniczne

Nr	A	B	C	Nr	A	B	C
U38400.006.0001 NO.0	0.063	0.125	0.031	U38402.016.0001 NO.8	0.188	0.438	0.049
U38400.006.0002 NO.0	0.063	0.188	0.031	U38402.018.0001 1/4	0.281	0.562	0.049
U38400.006.0003 NO.0	0.063	0.250	0.031	U38402.019.0001 NO.10	0.219	0.500	0.049
U38400.007.0001 NO.2	0.094	0.156	0.031	U38402.175.0001 1.3/4	1.875	4.000	0.180
U38400.007.0002 NO.2	0.094	0.219	0.031	U38402.200.0001 2 Inch	2.125	4.500	0.180
U38400.007.0003 NO.2	0.094	0.281	0.031	U38402.225.0001 2.1/4	2.375	4.750	0.220
U38400.008.0001 NO.2	0.094	0.188	0.031	U38402.250.0001 2.1/2	2.625	5.000	0.238
U38400.008.0002 NO.2	0.094	0.250	0.031	U38402.300.0001 3 Inch	3.125	5.500	0.284
U38400.008.0003 NO.2	0.094	0.344	0.031	U38403.011.0001 NO.4	0.125	0.313	0.078
U38400.011.0001 NO.2	0.094	0.250	0.016	U38403.013.0001 NO.6	0.156	0.375	0.078
U38400.011.0002 NO.4	0.125	0.250	0.047	U38403.016.0001 NO.8	0.188	0.438	0.078
U38400.011.0003 NO.4	0.125	0.313	0.031	U38403.019.0001 NO.8	0.188	0.500	0.094
U38400.011.0004 NO.4	0.125	0.375	0.047	U38403.025.0001 1/4	0.281	0.625	0.125
U38400.011.0005 NO.4	0.125	0.438	0.047	U38403.031.0001 5/16	0.344	0.750	0.125
U38400.013.0001 NO.6	0.156	0.375	0.049	U38403.037.0001 3/8	0.406	0.875	0.125
U38400.013.0002 NO.6	0.156	0.313	0.047	U38403.043.0001 7/16	0.469	1.000	0.125
U38400.013.0003 NO.6	0.156	0.438	0.047	U38403.050.0001 1/2	0.531	1.125	0.125
U38400.013.0004 NO.6	0.156	0.563	0.047	U38403.062.0001 5/8	0.656	1.375	0.125
U38400.016.0001 NO.8	0.188	0.438	0.049	U38403.075.0001 3/4	0.781	1.625	0.125
U38400.016.0002 NO.8	0.188	0.375	0.047	U38403.087.0001 7/8	0.906	1.750	0.156
U38400.016.0003 NO.8	0.188	0.500	0.047	U38403.100.0001 1 Inch	1.031	2.000	0.188
U38400.016.0004 NO.8	0.188	0.625	0.063	U38403.112.0001 1.1/8	1.156	2.250	0.219
U38400.016.0005 NO.10	0.219	0.375	0.047	U38403.125.0001 1.1/4	1.281	2.500	0.281
U38400.018.0001 1/4	0.281	0.562	0.049	U38405.025.0001 1/4	0.281	0.625	0.094
U38400.019.0001 NO.8	0.188	0.406	0.047	U38405.031.0001 5/16	0.344	0.688	0.094
U38400.019.0002 NO.8	0.188	0.563	0.047	U38405.037.0001 3/8	0.406	0.813	0.125
U38400.019.0003 NO.8	0.188	0.718	0.063	U38405.043.0001 7/16	0.469	0.906	0.125
U38400.019.0004 NO.10	0.219	0.500	0.049	U38405.056.0001 9/16	0.594	1.156	0.172
U38400.025.0001 1/4	0.281	0.500	0.063	U38405.062.0001 5/8	0.656	1.313	0.219
U38400.025.0002 1/4	0.281	0.718	0.063	U38405.075.0001 3/4	0.781	1.469	0.219
U38400.025.0003 1/4	0.281	1.000	0.063	U38405.087.0001 7/8	0.938	1.750	0.250
U38400.025.0004 5/16	0.344	0.750	0.063	U38405.100.0001 1 Inch	1.063	2.000	0.250
U38400.031.0001 5/16	0.344	0.625	0.063	U38405.112.0001 1.1/8	1.188	2.250	0.250
U38400.031.0002 5/16	0.344	0.875	0.063	U38405.125.0001 1.1/4	1.375	2.500	0.250
U38400.031.0003 5/16	0.344	1.125	0.063	U38405.137.0001 1.3/8	1.438	2.750	0.250
U38400.037.0001 3/8	0.406	0.718	0.063	U38405.150.0001 1.1/2	1.563	3.000	0.250
U38400.037.0002 3/8	0.406	1.000	0.063	U51410.006.0001 NO.0	0.063	0.125	0.016
U38400.037.0003 3/8	0.406	1.250	0.109	U51410.007.0001 NO.2	0.094	0.156	0.016
U38400.043.0001 7/16	0.469	0.875	0.063	U51410.008.0001 NO.2	0.094	0.188	0.031
U38400.043.0002 7/16	0.469	0.906	0.063	U51410.011.0001 NO.4	0.125	0.313	0.078
U38400.043.0003 7/16	0.469	1.125	0.063	U51410.011.0002 NO.4	0.125	0.250	0.063
U38400.043.0004 7/16	0.469	1.469	0.109	U51410.011.0003 NO.4	0.125	0.313	0.031
U38400.050.0001 1/2	0.531	1.000	0.063	U51410.013.0001 NO.6	0.156	0.375	0.049
U38400.050.0002 1/2	0.531	1.250	0.109	U51410.013.0002 NO.6	0.156	0.313	0.063
U38400.050.0003 1/2	0.531	1.750	0.109	U51410.013.0003 NO.6	0.156	0.375	0.031
U38400.056.0001 9/16	0.594	1.813	0.094	U51410.013.0004 NO.6	0.156	0.375	0.078
U38400.056.0002 5/8	0.625	1.500	0.109	U51410.016.0001 NO.6	0.156	0.375	0.063
U38400.075.0001 3/4	0.781	1.469	0.141	U51410.016.0002 NO.8	0.188	0.438	0.049
U38400.075.0002 3/4	0.781	1.500	0.141	U51410.016.0003 NO.8	0.188	0.438	0.078
U38400.075.0003 3/4	0.781	2.000	0.156	U51410.019.0001 NO.8	0.188	0.500	0.094
U38400.075.0004 3/4	0.813	2.000	0.156	U51410.019.0002 NO.10	0.219	0.500	0.049
U38400.112.0001 1.1/4	1.250	2.750	0.156	U51410.021.0001 1/4	0.281	0.562	0.065
U38400.125.0001 1.1/4	1.375	2.500	0.156	U51410.021.0002 1/4	0.281	0.500	0.047
U38400.137.0001 1.3/8	1.500	2.750	0.156	U51410.025.0001 1/4	0.281	0.500	0.078
U38400.137.0002 1.3/8	1.500	3.250	0.156	U51410.025.0002 1/4	0.281	0.625	0.047
U38400.150.0001 1.1/2	1.625	3.000	0.156	U51410.025.0003 1/4	0.281	0.625	0.125
U38402.013.0001 NO.6	0.156	0.375	0.049	U51410.025.0004 1/4	0.281	0.625	0.188

Informacje techniczne				Informacje techniczne			
Nr	A	B	C	Nr	A	B	C
U51410.025.0005 1/4	0.313	0.750	0.047	U51410.075.0004 3/4	0.781	1.625	0.250
U51410.031.0001 5/16	0.344	0.625	0.094	U51410.075.0005 3/4	0.781	1.750	0.078
U51410.031.0002 5/16	0.344	0.688	0.047	U51410.075.0006 3/4	0.781	1.750	0.109
U51410.031.0003 5/16	0.344	0.688	0.094	U51410.075.0007 3/4	0.781	2.000	0.125
U51410.031.0004 5/16	0.344	0.750	0.047	U51410.087.0001 7/8	0.906	1.750	0.156
U51410.031.0005 5/16	0.344	0.750	0.094	U51410.087.0002 7/8	0.906	1.750	0.250
U51410.031.0006 5/16	0.344	0.750	0.125	U51410.087.0003 7/8	0.938	2.000	0.094
U51410.031.0007 5/16	0.344	0.750	0.188	U51410.087.0004 7/8	0.938	2.000	0.109
U51410.031.0008 11/32	0.375	0.875	0.063	U51410.087.0005 7/8	0.938	2.250	0.141
U51410.037.0001 11/32	0.375	0.875	0.047	U51410.100.0001 1 Inch	1.031	2.000	0.188
U51410.037.0002 3/8	0.406	0.750	0.094	U51410.100.0002 1 Inch	1.031	2.000	0.250
U51410.037.0003 3/8	0.406	0.813	0.047	U51410.100.0003 1 Inch	1.031	2.000	0.281
U51410.037.0004 3/8	0.406	0.875	0.125	U51410.100.0004 1 Inch	1.063	2.000	0.109
U51410.037.0005 3/8	0.406	1.000	0.125	U51410.100.0005 1 Inch	1.063	2.500	0.141
U51410.037.0006 3/8	0.406	1.000	0.188	U51410.112.0001 1.1/8	1.156	2.250	0.219
U51410.037.0007 7/16	0.438	1.000	0.063	U51410.125.0001 1.1/4	1.281	2.500	0.281
U51410.043.0001 7/16	0.469	0.906	0.047	U55410.011.0001 NO.4	0.125	0.313	0.031
U51410.043.0002 7/16	0.469	0.906	0.125	U55410.016.0001 NO.6	0.156	0.375	0.031
U51410.043.0003 7/16	0.469	1.000	0.125	U55410.019.0001 NO.8	0.188	0.438	0.031
U51410.043.0004 7/16	0.469	1.000	0.188	U55410.019.0002 NO.10	0.219	0.500	0.049
U51410.043.0005 1/2	0.500	1.125	0.047	U55410.025.0001 1/4	0.281	0.625	0.047
U51410.043.0006 1/2	0.500	1.125	0.063	U55410.025.0002 1/4	0.313	0.750	0.047
U51410.043.0007 1/2	0.500	1.250	0.063	U55410.031.0001 5/16	0.344	0.688	0.047
U51410.050.0001 1/2	0.531	1.063	0.063	U55410.031.0002 5/16	0.344	0.750	0.047
U51410.050.0002 1/2	0.531	1.063	0.188	U55410.031.0003 11/32	0.375	0.875	0.063
U51410.050.0003 1/2	0.531	1.125	0.125	U55410.037.0001 11/32	0.375	0.875	0.047
U51410.050.0004 1/2	0.531	1.125	0.188	U55410.037.0002 3/8	0.406	0.813	0.047
U51410.050.0005 9/16	0.563	1.250	0.063	U55410.037.0003 7/16	0.438	1.000	0.063
U51410.050.0006 9/16	0.563	1.375	0.094	U55410.043.0001 7/16	0.469	0.906	0.047
U51410.056.0001 9/16	0.594	1.813	0.188	U55410.043.0002 1/2	0.500	1.250	0.063
U51410.056.0002 5/8	0.625	1.500	0.094	U55410.050.0001 1/2	0.531	1.063	0.063
U51410.062.0001 5/8	0.656	1.313	0.063	U55410.050.0002 9/16	0.563	1.250	0.063
U51410.062.0002 5/8	0.656	1.313	0.219	U55410.050.0003 9/16	0.563	1.375	0.094
U51410.062.0003 5/8	0.656	1.375	0.125	U55410.056.0001 5/8	0.625	1.500	0.094
U51410.062.0004 5/8	0.656	1.375	0.188	U55410.062.0001 5/8	0.656	1.313	0.063
U51410.062.0005 5/8	0.688	1.500	0.063	U55410.062.0002 5/8	0.688	1.500	0.078
U51410.062.0006 5/8	0.688	1.500	0.078	U55410.062.0003 5/8	0.688	1.750	0.109
U51410.062.0007 5/8	0.688	1.750	0.109	U55410.075.0001 3/4	0.781	1.500	0.109
U51410.075.0001 3/4	0.781	1.500	0.109	U55410.075.0002 3/4	0.781	2.000	0.125
U51410.075.0002 3/4	0.781	1.500	0.219	U55410.100.0001 1 Inch	1.063	2.000	0.109
U51410.075.0003 3/4	0.781	1.625	0.125	U55410.100.0002 1 Inch	1.063	2.500	0.141

7

Grupy katalogowe			
Material	Obrobka powierzchni	Kod	Strona
St		U38403	7-47
St Utwardzana powierzchniowo		U38402	7-48
St	Ocyнк.	U38400	7-48
St	Ocyнк. złt. pas.	U38405	7-48
St.St. A2 (AISI304/18-8)		U51410	7-48
St.St. A4 (AISI316/18-10)		U55410	7-49

U38403 Podkładki powiększone niemetryczne X09A

Material: Stal



Dla wymiaru nominalnego	⊗	Kod artykułu	Dla wymiaru nominalnego	⊗	Kod artykułu	Dla wymiaru nominalnego	⊗	Kod artykułu
NO.4*	100	U38403.011.0001	5/16*	100	U38403.031.0001	3/4*	20	U38403.075.0001
NO.6*	100	U38403.013.0001	3/8*	50	U38403.037.0001	7/8*	10	U38403.087.0001
NO.8*	100	U38403.016.0001	7/16*	50	U38403.043.0001	1 Inch*	5	U38403.100.0001
NO.10*	100	U38403.019.0001	1/2*	50	U38403.050.0001	1.1/8*	5	U38403.112.0001
1/4*	100	U38403.025.0001	5/8*	25	U38403.062.0001	1.1/4*	5	U38403.125.0001

U38402	Podkładki powiększone niemetryczne	X09A
Materiał	Stal Utwardzana powierzchniowo	

Dla wymiaru nominalnego	☒	Kod artykułu	Dla wymiaru nominalnego	☒	Kod artykułu	Dla wymiaru nominalnego	☒	Kod artykułu
NO.6*	100	U38402.013.0001	NO.10*	100	U38402.019.0001	2.1/4*	5	U38402.225.0001
NO.8*	100	U38402.016.0001	1.3/4*	5	U38402.175.0001	2.1/2*	5	U38402.250.0001
3/16*	100	U38402.018.0001	2 Inch*	5	U38402.200.0001	3 Inch*	5	U38402.300.0001

U38400	Podkładki powiększone niemetryczne	X09A
Materiał	Stal	
Obróbka powierzchni	Ocynkowane	

Dla wymiaru nominalnego	☒	Kod artykułu	Dla wymiaru nominalnego	☒	Kod artykułu	Dla wymiaru nominalnego	☒	Kod artykułu
NO.0*	100	U38400.006.0001	NO.8*	100	U38400.016.0002	7/16*	50	U38400.043.0001
NO.0*	100	U38400.006.0002	NO.8*	100	U38400.016.0003	7/16*	50	U38400.043.0002
NO.0*	100	U38400.006.0003	NO.8*	100	U38400.016.0004	7/16*	50	U38400.043.0003
NO.1*	100	U38400.007.0001	NO.8*	100	U38400.016.0005	7/16*	50	U38400.043.0004
NO.1*	100	U38400.007.0002	3/16*	100	U38400.018.0001	1/2*	50	U38400.050.0001
NO.1*	100	U38400.007.0003	NO.10*	100	U38400.019.0001	1/2*	50	U38400.050.0002
NO.2*	100	U38400.008.0001	NO.10*	100	U38400.019.0002	1/2*	50	U38400.050.0003
NO.2*	100	U38400.008.0002	NO.10*	100	U38400.019.0003	9/16*	25	U38400.056.0001
NO.2*	100	U38400.008.0003	NO.10*	100	U38400.019.0004	9/16*	25	U38400.056.0002
NO.2*	100	U38400.011.0001	1/4*	100	U38400.025.0001	3/4*	20	U38400.075.0001
NO.4*	100	U38400.011.0002	1/4*	100	U38400.025.0002	3/4*	20	U38400.075.0002
NO.4*	100	U38400.011.0003	1/4*	100	U38400.025.0003	3/4*	20	U38400.075.0003
NO.4*	100	U38400.011.0004	1/4*	100	U38400.025.0004	3/4*	20	U38400.075.0004
NO.4*	100	U38400.011.0005	5/16*	100	U38400.031.0001	1.1/8*	5	U38400.112.0001
NO.6*	100	U38400.013.0001	5/16*	100	U38400.031.0002	1.1/4*	5	U38400.125.0001
NO.6*	100	U38400.013.0002	5/16*	100	U38400.031.0003	1.3/8*	5	U38400.137.0001
NO.6*	100	U38400.013.0003	3/8*	100	U38400.037.0001	1.3/8*	5	U38400.137.0002
NO.6*	100	U38400.013.0004	3/8*	100	U38400.037.0002	1.1/2*	5	U38400.150.0001
NO.8*	100	U38400.016.0001	3/8*	100	U38400.037.0003			

U38405	Podkładki powiększone niemetryczne	X09A
Materiał	Stal	
Obróbka powierzchni	Ocynkowane, po żółtej pasywacji	

Dla wymiaru nominalnego	☒	Kod artykułu	Dla wymiaru nominalnego	☒	Kod artykułu	Dla wymiaru nominalnego	☒	Kod artykułu
1/4*	100	U38405.025.0001	5/8*	25	U38405.062.0001	1.1/8*	5	U38405.112.0001
5/16*	100	U38405.031.0001	3/4*	20	U38405.075.0001	1.1/4*	5	U38405.125.0001
3/8*	100	U38405.037.0001	7/8*	10	U38405.087.0001	1.3/8*	5	U38405.137.0001
7/16*	50	U38405.043.0001	1 Inch*	5	U38405.100.0001	1.1/2*	5	U38405.150.0001
9/16*	25	U38405.056.0001						

U51410	Podkładki powiększone niemetryczne	X15A
Materiał	Stal nierdzewna A2 (AISI 304/18-8)	

Dla wymiaru nominalnego	☒	Kod artykułu	Dla wymiaru nominalnego	☒	Kod artykułu	Dla wymiaru nominalnego	☒	Kod artykułu
NO.0*	50	U51410.006.0001	NO.8*	50	U51410.016.0003	5/16*	50	U51410.031.0003
NO.1*	50	U51410.007.0001	NO.10*	50	U51410.019.0001	5/16*	50	U51410.031.0004
NO.2*	50	U51410.008.0001	NO.10*	50	U51410.019.0002	5/16*	50	U51410.031.0005
NO.4*	50	U51410.011.0001	NO.12*	50	U51410.021.0001	5/16*	50	U51410.031.0006
NO.4*	50	U51410.011.0002	NO.12*	50	U51410.021.0002	5/16*	50	U51410.031.0007
NO.4*	50	U51410.011.0003	1/4*	50	U51410.025.0001	5/16*	50	U51410.031.0008
NO.6*	50	U51410.013.0001	1/4*	50	U51410.025.0002	3/8*	50	U51410.037.0001
NO.6*	50	U51410.013.0002	1/4*	50	U51410.025.0003	3/8*	50	U51410.037.0002
NO.6*	50	U51410.013.0003	1/4*	50	U51410.025.0004	3/8*	50	U51410.037.0003
NO.6*	50	U51410.013.0004	1/4*	50	U51410.025.0005	3/8*	50	U51410.037.0004
NO.8*	50	U51410.016.0001	5/16*	50	U51410.031.0001	3/8*	50	U51410.037.0005
NO.8*	50	U51410.016.0002	5/16*	50	U51410.031.0002	3/8*	50	U51410.037.0006

U51410 Podkładki powiększone niemetryczne								
Dla wymiaru nominalnego	☒	Kod artykułu	Dla wymiaru nominalnego	☒	Kod artykułu	Dla wymiaru nominalnego	☒	Kod artykułu
3/8*	50	U51410.037.0007	9/16*	25	U51410.056.0001	3/4*	20	U51410.075.0006
7/16*	25	U51410.043.0001	9/16*	25	U51410.056.0002	3/4*	20	U51410.075.0007
7/16*	25	U51410.043.0002	5/8*	25	U51410.062.0001	7/8*	5	U51410.087.0001
7/16*	25	U51410.043.0003	5/8*	25	U51410.062.0002	7/8*	5	U51410.087.0002
7/16*	25	U51410.043.0004	5/8*	25	U51410.062.0003	7/8*	5	U51410.087.0003
7/16*	25	U51410.043.0005	5/8*	25	U51410.062.0004	7/8*	5	U51410.087.0004
7/16*	25	U51410.043.0006	5/8*	25	U51410.062.0005	7/8*	5	U51410.087.0005
7/16*	25	U51410.043.0007	5/8*	25	U51410.062.0006	1 Inch*	5	U51410.100.0001
1/2*	25	U51410.050.0001	5/8*	25	U51410.062.0007	1 Inch*	5	U51410.100.0002
1/2*	25	U51410.050.0002	3/4*	20	U51410.075.0001	1 Inch*	5	U51410.100.0003
1/2*	25	U51410.050.0003	3/4*	20	U51410.075.0002	1 Inch*	5	U51410.100.0004
1/2*	25	U51410.050.0004	3/4*	20	U51410.075.0003	1 Inch*	5	U51410.100.0005
1/2*	25	U51410.050.0005	3/4*	20	U51410.075.0004	1.1/8*	5	U51410.112.0001
1/2*	25	U51410.050.0006	3/4*	20	U51410.075.0005	1.1/4*	5	U51410.125.0001

U55410 Podkładki powiększone niemetryczne		X15A
Materiał	Stal nierdzewna A4 (AISI 316/18-10)	

Dla wymiaru nominalnego	☒	Kod artykułu	Dla wymiaru nominalnego	☒	Kod artykułu	Dla wymiaru nominalnego	☒	Kod artykułu
NO.4*	50	U55410.011.0001	3/8*	50	U55410.037.0001	5/8*	25	U55410.062.0001
NO.8*	50	U55410.016.0001	3/8*	50	U55410.037.0002	5/8*	25	U55410.062.0002
NO.10*	50	U55410.019.0001	3/8*	50	U55410.037.0003	5/8*	25	U55410.062.0003
NO.10*	50	U55410.019.0002	7/16*	25	U55410.043.0001	3/4*	20	U55410.075.0001
1/4*	50	U55410.025.0001	7/16*	25	U55410.043.0002	3/4*	20	U55410.075.0002
1/4*	50	U55410.025.0002	1/2*	25	U55410.050.0001	1 Inch*	5	U55410.100.0001
5/16*	50	U55410.031.0001	1/2*	25	U55410.050.0002	1 Inch*	5	U55410.100.0002
5/16*	50	U55410.031.0002	1/2*	25	U55410.050.0003			
5/16*	50	U55410.031.0003	9/16*	25	U55410.056.0001			

Podkładki sprężyste jednozwojowe

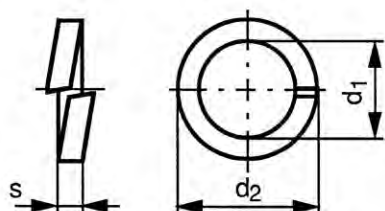

DIN 127 B
NEN 1197 B
NF E25-515
BS 4464 B

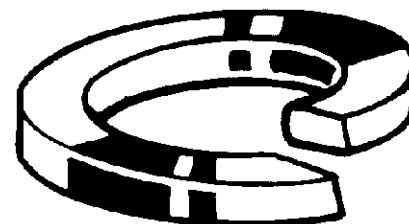

7

Informacje techniczne							
Dla wymiaru nominalnego	d ₁ (min.)	d ₂ (maks.)	s	Dla wymiaru nominalnego	d ₁ (min.)	d ₂ (maks.)	s
M2	2.1	4.4	0.5	M22	22.5	35.9	4
M2.3 (#DIN)	2.4	4.9	0.6	M24	24.5	40	5
M2.5	2.6	5.1	0.6	M27	27.5	43	5
M2.6 (#DIN)	2.7	5.2	0.6	M30	30.5	48.2	6
M3	3.1	6.2	0.8	M33 (#DIN)	33.5	55.2	6
M3.5	3.6	6.7	0.8	M36	36.5	58.2	6
M4	4.1	7.6	0.9	M39	39.5	61.2	6
M5	5.1	9.2	1.2	M42	42.5	68.2	7
M6	6.1	11.8	1.6	M45	45.5	71.2	7
M7	7.1	12.8	1.6	M48	49	75	7
M8	8.1	14.8	2	M52	53	83	8
M10	10.2	18.1	2.2	M56	57	87	8
M11 (#DIN)	11.2	18.2	2.2	M60	61	91	8
M12	12.2	21.1	2.5	M64	65	95	8
M14	14.2	24.1	3	M68	69	99	8
M16	16.2	27.4	3.5	M72	73	103	8
M18	18.2	29.4	3.5	M76 (#DIN)	77	107	8
M20	20.2	33.6	4				

- Podkładki sprężyste jednozwojowe zgodn. z DIN 127 B należy stosować w połączeniu z częściami złącznymi o klasie wytrzymałości ≤ 5.8, stosowanie przy obciążeniach dynamicznych jest niedozwolone.
- Do blokowania przy obciążeniach dynamicznych należy stosować podkładki z krawędzią blokującą i podkładki odporne na wibrację NORD-LOCK.
- W zależności od dostępności artykuły te mogą być dostarczone jako cynkowane, jak również powlekane mechanicznie.
- OSTRZEŻENIE: cynkowanie elektrolityczne tych produktów może wywołać kruchość wodorową.

Grupy katalogowe

Material	Obróbka powierzchni	Kod	Strona
Stal sprężynowa DIN267-26		37000	7-50
Stal sprężynowa DIN267-26	Ocynk.	37020	7-50
Stal sprężynowa DIN267-26	Ocynk.	Duże Opakowanie	7-50
Stal sprężynowa DIN267-26	Ocynk. żłt. pas.	37060	7-51
Stal sprężynowa DIN267-26	FLZNNC-NC6	37024	7-51
Stal sprężynowa DIN267-26	Ocynk. gor.	37025	7-51
St.St. A2		51450	7-51
St.St. A4		55450	7-51
St.St. A5		52451	7-52
Al P60		45790	7-52

37000 Podkładki sprężyste jednozwojowe L05A

Material	Stal sprężynowa DIN267-26		
-----------------	---------------------------	---	---

Dla wymiaru nominalnego	⊗	Kod artykułu	Dla wymiaru nominalnego	⊗	Kod artykułu	Dla wymiaru nominalnego	⊗	Kod artykułu
M3	250	37000.030.001	M16	100	37000.160.001	M42	10	37000.420.001
M3,5	250	37000.035.001	M18	100	37000.180.001	M45	10	37000.450.001
M4	250	37000.040.001	M20	100	37000.200.001	M48	10	37000.480.001
M5	250	37000.050.001	M22	50	37000.220.001	M52	10	37000.520.001
M6	250	37000.060.001	M24	50	37000.240.001	M56	5	37000.560.001
M7	250	37000.070.001	M27	25	37000.270.001	M60	5	37000.600.001
M8	200	37000.080.001	M30	25	37000.300.001	M64	5	37000.640.001
M10	200	37000.100.001	M33	25	37000.330.001	M68	5	37000.680.001
M11	150	37000.110.001	M36	25	37000.360.001	M72	5	37000.720.001
M12	150	37000.120.001	M39	10	37000.390.001	M76	5	37000.760.001
M14	100	37000.140.001						

37020 Podkładki sprężyste jednozwojowe L05A

Material	Stal sprężynowa DIN267-26		
Obróbka powierzchni	Ocynkowane		

Dla wymiaru nominalnego	⊗	Kod artykułu	Dla wymiaru nominalnego	⊗	Kod artykułu	Dla wymiaru nominalnego	⊗	Kod artykułu
M2	500	37020.020.001	M7	250	37020.070.001	M20	100	37020.200.001
M2,3	500	37020.023.001	M8	200	37020.080.001	M22	50	37020.220.001
M2,6	500	37020.026.001	M10	200	37020.100.001	M24	50	37020.240.001
M3	250	37020.030.001	M11	150	37020.110.001	M27	25	37020.270.001
M3,5	250	37020.035.001	M12	150	37020.120.001	M30	25	37020.300.001
M4	250	37020.040.001	M14	100	37020.140.001	M33	25	37020.330.001
M5	250	37020.050.001	M16	100	37020.160.001	M36	25	37020.360.001
M6	250	37020.060.001	M18	100	37020.180.001	M39	10	37020.390.001

37030 Podkładki sprężyste jednozwojowe L05A

Material	Stal sprężynowa DIN267-26		
Obróbka powierzchni	Ocynkowane		

Dla wymiaru nominalnego	⊗	Kod artykułu	Dla wymiaru nominalnego	⊗	Kod artykułu	Dla wymiaru nominalnego	⊗	Kod artykułu
M3	2500	37030.030.001	M8	2000	37030.080.001	M16	500	37030.160.001
M4	2500	37030.040.001	M10	1500	37030.100.001	M20	250	37030.200.001
M5	2500	37030.050.001	M12	1000	37030.120.001	M22	250	37030.220.001
M6	2000	37030.060.001	M14	500	37030.140.001	M24	250	37030.240.001

37060 Podkładki sprężyste jednozwojowe		L05A
Materiał	Stal sprężynowa DIN267-26	
Obróbka powierzchni	Ocykowane, po żółtej pasywacji	

Dla wymiaru nominalnego	☒	Kod artykułu	Dla wymiaru nominalnego	☒	Kod artykułu	Dla wymiaru nominalnego	☒	Kod artykułu
M3	250	37060.030.001	M8	200	37060.080.001	M18	100	37060.180.001
M4	250	37060.040.001	M10	200	37060.100.001	M20	100	37060.200.001
M5	250	37060.050.001	M12	150	37060.120.001	M22	50	37060.220.001
M6	250	37060.060.001	M14	100	37060.140.001	M24	50	37060.240.001
M7	250	37060.070.001	M16	100	37060.160.001			

37024 Podkładki sprężyste jednozwojowe		L05A
Materiał	Stal sprężynowa DIN267-26	
Obróbka powierzchni	Ocynek płatkowy bez Cr6+ wg ISO 10683 (fZnnc)	



Dla wymiaru nominalnego	☒	Kod artykułu	Dla wymiaru nominalnego	☒	Kod artykułu	Dla wymiaru nominalnego	☒	Kod artykułu
M6	250	37024.060.001	M12	150	37024.120.001	M24	50	37024.240.001
M8	200	37024.080.001	M16	100	37024.160.001	M30	25	37024.300.001
M10	200	37024.100.001	M20	100	37024.200.001			

37025 Podkładki sprężyste jednozwojowe		A08A
Materiał	Stal sprężynowa DIN267-26	
Obróbka powierzchni	Ocykowane na gorąco	



Dla wymiaru nominalnego	☒	Kod artykułu	Dla wymiaru nominalnego	☒	Kod artykułu	Dla wymiaru nominalnego	☒	Kod artykułu
M6	250	37025.060.001	M16	100	37025.160.001	M24	50	37025.240.001
M8	200	37025.080.001	M18	100	37025.180.001	M27	25	37025.270.001
M10	200	37025.100.001	M20	100	37025.200.001	M30	25	37025.300.001
M12	150	37025.120.001	M22	50	37025.220.001	M36	25	37025.360.001
M14	150	37025.140.001						

7

51450 Podkładki sprężyste jednozwojowe		R07A
Materiał	Stal nierdzewna A2	
	DIN ≈127 B NEN ≈1197 B NF ≈E25-515 BS ≈4464 B	



Dla wymiaru nominalnego	☒	Kod artykułu	Dla wymiaru nominalnego	☒	Kod artykułu	Dla wymiaru nominalnego	☒	Kod artykułu
M2	200	51450.020.001	M8	500	51450.080.001	M27	50	51450.270.001
M2,3	200	51450.023.001	M10	500	51450.100.001	M30	50	51450.300.001
M2,5	200	51450.025.001	M11	500	51450.110.001	M33	50	51450.330.001
M2,6	200	51450.026.001	M12	500	51450.120.001	M36	50	51450.360.001
M3	500	51450.030.001	M14	200	51450.140.001	M39*	25	51450.390.001
M3,5	500	51450.035.001	M16	200	51450.160.001	M42*	25	51450.420.001
M4	500	51450.040.001	M18	200	51450.180.001	M45*	25	51450.450.001
M5	500	51450.050.001	M20	200	51450.200.001	M48*	25	51450.480.001
M6	500	51450.060.001	M22	100	51450.220.001			
M7	500	51450.070.001	M24	100	51450.240.001			

• Informacje techniczne zgodne z DIN, z wyjątkiem materiału typu stal nierdzewna.

55450 Podkładki sprężyste jednozwojowe		R47A
Materiał	Stal nierdzewna A4	
	DIN ≈127 B NEN ≈1197 B NF ≈E25-515 BS ≈4464 B	



Dla wymiaru nominalnego	☒	Kod artykułu	Dla wymiaru nominalnego	☒	Kod artykułu	Dla wymiaru nominalnego	☒	Kod artykułu
M2	200	55450.020.001	M3	500	55450.030.001	M4	500	55450.040.001
M2,5	200	55450.025.001	M3,5*	1000	55450.035.001	M5	500	55450.050.001

55450 Podkładki sprężyste jednozwojowe					
Dla wymiaru nominalnego	☒	Kod artykułu	Dla wymiaru nominalnego	☒	Kod artykułu
M6	500	55450.060.001	M18	200	55450.180.001
M8	500	55450.080.001	M20	200	55450.200.001
M10	500	55450.100.001	M22	100	55450.220.001
M12	500	55450.120.001	M24	100	55450.240.001
M14	200	55450.140.001	M27	50	55450.270.001
M16	200	55450.160.001	M30	50	55450.300.001

• Informacje techniczne zgodne z DIN, z wyjątkiem materiału typu stal nierdzewna.

52451 Podkładki sprężyste jednozwojowe				R45A
Materiał	Stal nierdzewna A5		DIN	≈127 B
			NEN	≈1197 B
			NF	≈E25-515
			BS	≈4464 B

Dla wymiaru nominalnego	☒	Kod artykułu	Dla wymiaru nominalnego	☒	Kod artykułu
M8*	1000	52451.080.001	M10*	500	52451.100.001

45790 Podkładki sprężyste jednozwojowe				W01A
Materiał	Aluminium P60		DIN	≈127 B
			NEN	≈1197 B
			NF	≈E25-515
			BS	≈4464 B

Dla wymiaru nominalnego	☒	Kod artykułu	Dla wymiaru nominalnego	☒	Kod artykułu	Dla wymiaru nominalnego	☒	Kod artykułu
M6	250	45790.060.001	M10	200	45790.100.001	M14	100	45790.140.001
M8	200	45790.080.001	M12	150	45790.120.001	M16	100	45790.160.001

Podkładki sprężyste jednozwojowe

ASME B18.21.1

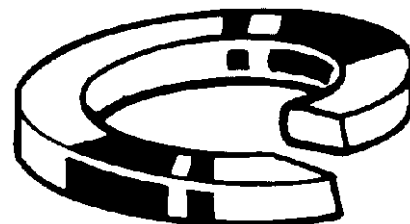
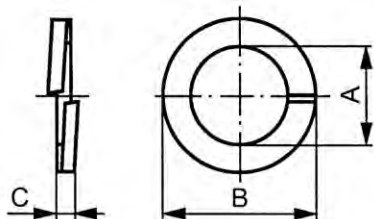

Informacje techniczne

Dla wymiaru nominalnego	A	B	T
No.2	0.088	0.172	0.02
No.3	0.101	0.195	0.025
No.4	0.114	0.209	0.025
No.5	0.127	0.236	0.031
No.6	0.141	0.25	0.031
No.8	0.167	0.293	0.040
No.10	0.193	0.334	0.047
No.12	0.22	0.377	0.056
1/4	0.252	0.487	0.062
5/16	0.314	0.583	0.078
3/8	0.377	0.68	0.094
7/16	0.44	0.77	0.109
1/2	0.502	0.869	0.125
9/16	0.564	0.965	0.141
5/8	0.628	1.073	0.156
3/4	0.753	1.265	0.188
7/8	0.878	1.459	0.219
1 Inch	1.003	1.656	0.25
1.1/8	1.129	1.847	0.281
1.1/4	1.254	2.036	0.312
1.3/8	1.379	2.219	0.344
1.1/2	1.504	2.419	0.375
1.5/8	1.633	2.553	0.359
1.3/4	1.758	2.679	0.389

Informacje techniczne			
Dla wymiaru nominalnego	A	B	T
1.7/8	1.883	2.811	0.422
2 Inch	2.008	2.936	0.422
2.1/2	2.512	3.471	0.44
3 Inch	3.012	4.074	0.458

Grupy katalogowe			
Material	Obróbka powierzchni	Kod	Strona
St		U37000	7-53
St	Ocynk.	U37020	7-53
St	Ocynk. żłt. pas.	U37060	7-53
St	Ocynk. gor.	U37025	7-54
St.St. A2 (AISI304/18-8)		U51450	7-54
St.St. A4 (AISI316/18-10)		U55450	7-54
Mosiądz SL		U43150	7-54

U37000 Podkładki sprężyste jednozwojowe		X09A
Material	Stal	
		

Dla wymiaru nominalnego	Kod artykułu	Dla wymiaru nominalnego	Kod artykułu	Dla wymiaru nominalnego	Kod artykułu
NO.2	100 U37000.008.0001	3/8*	50 U37000.037.0001	1.3/8*	5 U37000.137.0001
NO.3*	100 U37000.009.0001	7/16*	25 U37000.043.0001	1.1/2*	5 U37000.150.0001
NO.4*	100 U37000.011.0001	1/2*	25 U37000.050.0001	1.5/8*	5 U37000.162.0001
NO.5*	100 U37000.012.0001	9/16*	25 U37000.056.0001	1.3/4*	5 U37000.175.0001
NO.6*	100 U37000.013.0001	5/8*	10 U37000.062.0001	1.7/8*	5 U37000.187.0001
NO.8*	100 U37000.016.0001	3/4*	10 U37000.075.0001	2 Inch*	5 U37000.200.0001
NO.10*	100 U37000.019.0001	7/8*	5 U37000.087.0001	2.1/2*	5 U37000.250.0001
NO.12*	100 U37000.021.0001	1 Inch*	5 U37000.100.0001	3 Inch*	5 U37000.300.0001
1/4*	100 U37000.025.0001	1.1/8*	5 U37000.112.0001		
5/16*	100 U37000.031.0001	1.1/4*	5 U37000.125.0001		

U37020 Podkładki sprężyste jednozwojowe		X09A
Material	Stal	
Obróbka powierzchni	Ocynkowane	

Dla wymiaru nominalnego	Kod artykułu	Dla wymiaru nominalnego	Kod artykułu	Dla wymiaru nominalnego	Kod artykułu
NO.2*	100 U37020.008.0001	1/4*	100 U37020.025.0001	7/8*	5 U37020.087.0001
NO.3*	100 U37020.009.0001	5/16*	100 U37020.031.0001	1 Inch*	5 U37020.100.0001
NO.4*	100 U37020.011.0001	3/8*	50 U37020.037.0001	1.1/8*	5 U37020.112.0001
NO.5*	100 U37020.012.0001	7/16*	25 U37020.043.0001	1.1/4*	5 U37020.125.0001
NO.6*	100 U37020.013.0001	1/2*	25 U37020.050.0001	1.3/8*	5 U37020.137.0001
NO.8*	100 U37020.016.0001	9/16*	25 U37020.056.0001	1.1/2*	5 U37020.150.0001
NO.10*	100 U37020.019.0001	5/8*	10 U37020.062.0001	1.3/4*	5 U37020.175.0001
NO.12*	100 U37020.021.0001	3/4*	10 U37020.075.0001	2 Inch*	5 U37020.200.0001

U37060 Podkładki sprężyste jednozwojowe		X09A
Material	Stal	
Obróbka powierzchni	Ocynkowane, po żółtej pasywacji	

Dla wymiaru nominalnego	Kod artykułu	Dla wymiaru nominalnego	Kod artykułu	Dla wymiaru nominalnego	Kod artykułu
1/4*	100 U37060.025.0001	5/8*	10 U37060.062.0001	1.1/4*	5 U37060.125.0001
5/16*	100 U37060.031.0001	3/4*	10 U37060.075.0001	1.3/8*	5 U37060.137.0001
3/8*	50 U37060.037.0001	7/8*	5 U37060.087.0001	1.1/2*	5 U37060.150.0001
7/16*	25 U37060.043.0001	1 Inch*	5 U37060.100.0001	1.3/4*	5 U37060.175.0001
1/2*	25 U37060.050.0001	1.1/8*	5 U37060.112.0001	2 Inch*	5 U37060.200.0001
9/16*	25 U37060.056.0001				

U37025 Podkładki sprężyste jednozwojowe X09A



Materiał Stal
Obróbka powierzchni Ocynkowane na gorąco

Dla wymiaru nominalnego	☒	Kod artykułu	Dla wymiaru nominalnego	☒	Kod artykułu	Dla wymiaru nominalnego	☒	Kod artykułu
1/4*	100	U37025.025.0001	3/4*	10	U37025.075.0001	1.3/8*	5	U37025.137.0001
5/16*	100	U37025.031.0001	7/8*	5	U37025.087.0001	1.1/2*	5	U37025.150.0001
3/8*	50	U37025.037.0001	1 Inch*	5	U37025.100.0001	1.3/4*	5	U37025.175.0001
7/16*	25	U37025.043.0001	1.1/8*	5	U37025.112.0001	2 Inch*	5	U37025.200.0001
1/2*	25	U37025.050.0001	1.1/4*	5	U37025.125.0001	2.1/2*	5	U37025.250.0001
5/8*	10	U37025.062.0001						

U51450 Podkładki sprężyste jednozwojowe X15A

Materiał Stal nierdzewna A2 (AISI 304/18-8)

Dla wymiaru nominalnego	☒	Kod artykułu	Dla wymiaru nominalnego	☒	Kod artykułu	Dla wymiaru nominalnego	☒	Kod artykułu
NO.2*	50	U51450.008.0001	NO.12*	50	U51450.021.0001	5/8*	10	U51450.062.0001
NO.3*	50	U51450.009.0001	1/4*	50	U51450.025.0001	3/4*	5	U51450.075.0001
NO.4*	50	U51450.011.0001	5/16*	50	U51450.031.0001	7/8*	5	U51450.087.0001
NO.5*	50	U51450.012.0001	3/8*	50	U51450.037.0001	1 Inch*	5	U51450.100.0001
NO.6*	50	U51450.013.0001	7/16*	25	U51450.043.0001	1.1/8*	5	U51450.112.0001
NO.8*	50	U51450.016.0001	1/2*	10	U51450.050.0001	1.1/4*	5	U51450.125.0001
NO.10*	50	U51450.019.0001	9/16*	10	U51450.056.0001	1.1/2*	5	U51450.150.0001

U55450 Podkładki sprężyste jednozwojowe X15A

Materiał Stal nierdzewna A4 (AISI 316/18-10)



Dla wymiaru nominalnego	☒	Kod artykułu	Dla wymiaru nominalnego	☒	Kod artykułu	Dla wymiaru nominalnego	☒	Kod artykułu
NO.2*	50	U55450.008.0001	1/4*	50	U55450.025.0001	3/4*	5	U55450.075.0001
NO.3*	50	U55450.009.0001	5/16*	50	U55450.031.0001	7/8*	5	U55450.087.0001
NO.4*	50	U55450.011.0001	3/8*	50	U55450.037.0001	1 Inch*	5	U55450.100.0001
NO.6*	50	U55450.013.0001	7/16*	25	U55450.043.0001	1.1/8*	5	U55450.112.0001
NO.8*	50	U55450.016.0001	1/2*	10	U55450.050.0001	1.1/4*	5	U55450.125.0001
NO.10*	50	U55450.019.0001	9/16*	10	U55450.056.0001	1.1/2*	5	U55450.150.0001
NO.12*	50	U55450.021.0001	5/8*	10	U55450.062.0001			

U43150 Podkładki sprężyste jednozwojowe X09A

Materiał Brąz SL





Dla wymiaru nominalnego	☒	Kod artykułu	Dla wymiaru nominalnego	☒	Kod artykułu	Dla wymiaru nominalnego	☒	Kod artykułu
NO.4*	100	U43150.011.0001	1/4*	100	U43150.025.0001	5/8*	10	U43150.062.0001
NO.10*	100	U43150.019.0001	3/8*	50	U43150.037.0001			
NO.12*	100	U43150.021.0001	1/2*	25	U43150.050.0001			

7

Podkładki sprężyste, typ ciężki

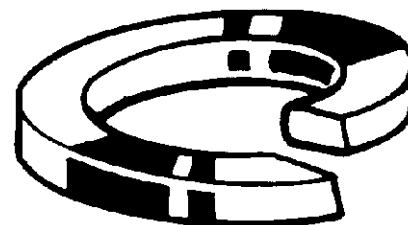
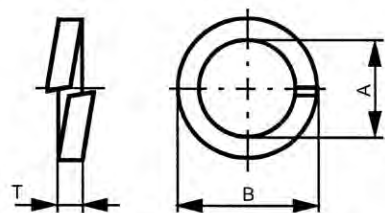
ASME B18.21.1



Informacje techniczne

Dla wymiaru nominalnego	A	B	T
No.2	0.088	0.182	0.025
No.3	0.101	0.209	0.031
No.4	0.114	0.223	0.031
No.5	0.127	0.252	0.040
No.6	0.141	0.266	0.040
No.8	0.167	0.307	0.047
No.10	0.193	0.350	0.056
No.12	0.220	0.391	0.063
1/4	0.252	0.489	0.077
5/16	0.314	0.593	0.097
3/8	0.377	0.688	0.115
7/16	0.440	0.784	0.133
1/2	0.502	0.879	0.151
9/16	0.564	0.975	0.170
5/8	0.628	1.087	0.189
3/4	0.753	1.285	0.226
7/8	0.878	1.489	0.266
1 Inch	1.003	1.700	0.306
1.1/8	1.129	1.903	0.345
1.1/4	1.254	2.104	0.384
1.3/8	1.379	2.301	0.422
1.1/2	1.504	2.491	0.458
1.5/8	1.633	2.694	0.458
1.3/4	1.758	2.82	0.458
2 Inch	2.008	3.144	0.496
2.1/4	2.262	3.398	0.496
2.1/2	2.512	3.648	0.496
3 Inch	3.012	4.160	0.526

Grupy katalogowe

Material	Obróbka powierzchni	Kod	Strona
St HV		U37180	7-55
St HV	Ocynk.	U37183	7-56



U37180 Podkładki sprężyste, typ ciężki

X09A

Material Stal HV



Dla wymiaru nominalnego	☒	Kod artykułu	Dla wymiaru nominalnego	☒	Kod artykułu	Dla wymiaru nominalnego	☒	Kod artykułu
NO.4*	100	U37180.011.0001	7/16*	25	U37180.043.0001	1.3/8*	5	U37180.137.0001
NO.5*	100	U37180.012.0001	1/2*	25	U37180.050.0001	1.1/2*	5	U37180.150.0001
NO.6*	100	U37180.013.0001	9/16*	25	U37180.056.0001	1.5/8*	5	U37180.162.0001
NO.8*	100	U37180.016.0001	5/8*	10	U37180.062.0001	1.3/4*	5	U37180.175.0001
NO.10*	100	U37180.019.0001	3/4*	10	U37180.075.0001	2 Inch*	5	U37180.200.0001
NO.12*	100	U37180.021.0001	7/8*	5	U37180.087.0001	2.1/4*	5	U37180.225.0001
1/4*	100	U37180.025.0001	1 Inch*	5	U37180.100.0001	2.1/2*	5	U37180.250.0001
5/16*	100	U37180.031.0001	1.1/8*	5	U37180.112.0001	3 Inch*	5	U37180.300.0001
3/8*	50	U37180.037.0001	1.1/4*	5	U37180.125.0001			

U37183	Podkładki sprężyste, typ ciężki	X09A
Materiał	Stal HV	
Obróbka powierzchni	Ocynkowane	
		

Dla wymiaru nominalnego	☒	Kod artykułu	Dla wymiaru nominalnego	☒	Kod artykułu	Dla wymiaru nominalnego	☒	Kod artykułu
NO.3*	100	U37183.009.0001	1/4*	100	U37183.025.0001	3/4*	10	U37183.075.0001
NO.4*	100	U37183.011.0001	5/16*	100	U37183.031.0001	7/8*	5	U37183.087.0001
NO.5*	100	U37183.012.0001	3/8*	50	U37183.037.0001	1 Inch*	5	U37183.100.0001
NO.6*	100	U37183.013.0001	7/16*	25	U37183.043.0001	1.1/8*	5	U37183.112.0001
NO.8*	100	U37183.016.0001	1/2*	25	U37183.050.0001	1.1/4*	5	U37183.125.0001
NO.10*	100	U37183.019.0001	9/16*	25	U37183.056.0001	1.3/8*	5	U37183.137.0001
NO.12*	100	U37183.021.0001	5/8*	10	U37183.062.0001	1.1/2*	5	U37183.150.0001

Podkładki sprężyste, typ ciężki

ASME B18.21.1

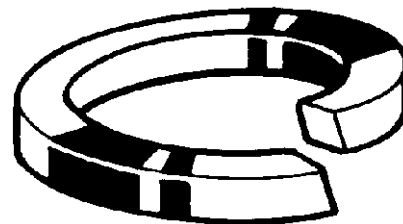
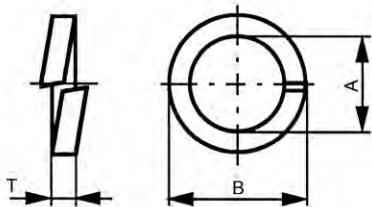



Informacje techniczne

Dla wymiaru nominalnego	A	B	T
No.4	0.114	0.253	0.034
No.6	0.141	0.314	0.045
No.8	0.167	0.375	0.057
No.10	0.193	0.434	0.068
No.12	0.220	0.497	0.080
1/4	0.252	0.533	0.084
5/16	0.314	0.619	0.108
3/8	0.377	0.738	0.123
7/16	0.440	0.836	0.143
1/2	0.502	0.935	0.162
9/16	0.564	1.035	0.182
5/8	0.628	1.151	0.202
3/4	0.753	1.355	0.241
7/8	0.878	1.571	0.285
1 Inch	1.003	1.794	0.330
1.1/8	1.129	2.013	0.375
1.1/4	1.254	2.222	0.417
1.1/2	1.504	2.627	0.496

Grupy katalogowe

Materiał	Obróbka powierzchni	Kod	Strona
St		U37170	7-56
St	Ocynk.	U37171	7-57

U37170	Podkładki sprężyste, typ ciężki	X09A
Materiał	Stal	
		

Dla wymiaru nominalnego	☒	Kod artykułu	Dla wymiaru nominalnego	☒	Kod artykułu	Dla wymiaru nominalnego	☒	Kod artykułu
NO.4*	100	U37170.011.0001	3/8*	50	U37170.037.0001	7/8*	5	U37170.087.0001
NO.6*	100	U37170.013.0001	7/16*	25	U37170.043.0001	1 Inch*	5	U37170.100.0001
NO.8*	100	U37170.016.0001	1/2*	25	U37170.050.0001	1.1/8*	5	U37170.112.0001
NO.10*	100	U37170.019.0001	9/16*	25	U37170.056.0001	1.1/4*	5	U37170.125.0001
1/4*	100	U37170.025.0001	5/8*	10	U37170.062.0001	1.1/2*	5	U37170.150.0001
5/16*	100	U37170.031.0001	3/4*	10	U37170.075.0001			

U37171	Podkładki sprężyste, typ ciężki	X09A
Materiał	Stal	
Obróbka powierzchni	Ocynkowane	

Dla wymiaru nominalnego	☒	Kod artykułu	Dla wymiaru nominalnego	☒	Kod artykułu	Dla wymiaru nominalnego	☒	Kod artykułu
NO.4*	100	U37171.011.0001	5/16*	100	U37171.031.0001	7/8*	5	U37171.087.0001
NO.6*	100	U37171.013.0001	3/8*	50	U37171.037.0001	1 Inch*	5	U37171.100.0001
NO.8*	100	U37171.016.0001	7/16*	25	U37171.043.0001	1.1/8*	5	U37171.112.0001
NO.10*	100	U37171.019.0001	9/16*	25	U37171.056.0001	1.1/4*	5	U37171.125.0001
NO.12*	100	U37171.021.0001	5/8*	10	U37171.062.0001	1.1/2*	5	U37171.150.0001
1/4*	100	U37171.025.0001	3/4*	10	U37171.075.0001			

Podkładki sprężyste jednozwojowe do wkrętów o łbach walcowych i kulistych

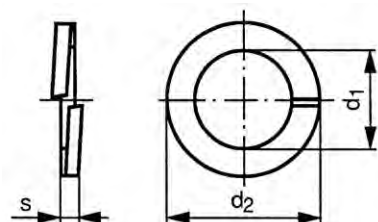

DIN 7980
BS 4464 A

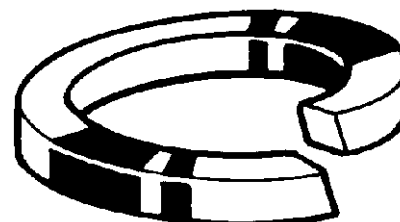

Informacje techniczne

Dla wymiaru nominalnego	d ₁ (min.)	d ₂ (maks.)	s	Dla wymiaru nominalnego	d ₁ (min.)	d ₂ (maks.)	s
M3	3.1	5.6	1	M16	16.2	24.4	3.5
M3.5	3.6	6.1	1	M18	18.2	26.4	3.5
M4	4.1	7	1.2	M20	20.2	30.6	4.5
M5	5.1	8.8	1.6	M22	22.5	32.9	4.5
M6	6.1	9.9	1.6	M24	24.5	35.9	5
M8	8.1	12.7	2	M27	27.5	38.9	5
M10	10.2	16	2.5	M30	30.5	44.1	6
M12	12.2	18	2.5	M36	36.5	52.2	7
M14	14.2	21.1	3				

Grupy katalogowe

Materiał	Obróbka powierzchni	Kod	Strona
Stal sprężynowa DIN267-26		37200	7-57
Stal sprężynowa DIN267-26	Ocynk.	37220	7-58
St.St. A2		51390	7-58
St.St. A4		55390	7-58



37200	Podkładki sprężyste jednozwojowe do wkrętów o łbach walcowych i kulistych	L07D
Materiał	Stal sprężynowa DIN267-26	

Dla wymiaru nominalnego	☒	Kod artykułu	Dla wymiaru nominalnego	☒	Kod artykułu	Dla wymiaru nominalnego	☒	Kod artykułu
M3	250	37200.030.001	M12	150	37200.120.001	M22	50	37200.220.001
M4	250	37200.040.001	M14	100	37200.140.001	M24	50	37200.240.001
M5	250	37200.050.001	M16	100	37200.160.001	M27	50	37200.270.001
M6	250	37200.060.001	M18	250	37200.180.001	M30	50	37200.300.001
M8	200	37200.080.001	M20	100	37200.200.001	M36	50	37200.360.001
M10	200	37200.100.001						

- Podkładki sprężyste jednozwojowe zgodn. z DIN 7980 należy stosować w połączeniu z częściami złącznymi o klasie wytrzymałości < 8.8, stosowanie przy obciążeniach dynamicznych jest niedozwolone
- Do blokowania przy obciążeniach dynamicznych należy stosować podkładki z krawędzią blokującą i podkładki odporne na wibrację NORD-LOCK.
- W zależności od dostępności artykuły te mogą być dostarczone jako cynkowane, jak również powlekane mechanicznie.
- Ostrzeżenie: cynkowanie elektrolityczne tych produktów może wywołać kruchość wodorową.

37220 Podkładki sprężyste jednozwojowe do wkrętów o łbach walcowych i kulistych L07D

Materiał Stal sprężynowa DIN267-26
Obróbka powierzchni Ocynkowane





Dla wymiaru nominalnego	✉	Kod artykułu	Dla wymiaru nominalnego	✉	Kod artykułu	Dla wymiaru nominalnego	✉	Kod artykułu
M3	250	37220.030.001	M10	200	37220.100.001	M22	50	37220.220.001
M4	250	37220.040.001	M12	150	37220.120.001	M24	50	37220.240.001
M5	250	37220.050.001	M14	100	37220.140.001	M27	50	37220.270.001
M6	250	37220.060.001	M16	100	37220.160.001	M30	50	37220.300.001
M8	200	37220.080.001	M20	100	37220.200.001			

- Podkładki sprężyste jednozwojowe zgodn. z DIN 7980 należy stosować w połączeniu z częściami złącznymi o klasie wytrzymałości < 8.8, stosowanie przy obciążeniach dynamicznych jest niedozwolone
- Do blokowania przy obciążeniach dynamicznych należy stosować podkładki z krawędzią blokującą i podkładki odporne na wibrację NORD-LOCK.
- W zależności od dostępności artykuły te mogą być dostarczone jako cynkowane, jak również powlekane mechanicznie.

51390 Podkładki sprężyste jednozwojowe do wkrętów o łbach walcowych i kulistych R09A

Materiał Stal nierdzewna A2
DIN ≈7980
BS ≈4464 A





Dla wymiaru nominalnego	✉	Kod artykułu	Dla wymiaru nominalnego	✉	Kod artykułu	Dla wymiaru nominalnego	✉	Kod artykułu
M3	250	51390.030.001	M8	250	51390.080.001	M18	100	51390.180.001
M3,5*	1000	51390.035.001	M10	200	51390.100.001	M20	100	51390.200.001
M4	250	51390.040.001	M12	200	51390.120.001	M24	50	51390.240.001
M5	250	51390.050.001	M14	100	51390.140.001	M27	50	51390.270.001
M6	250	51390.060.001	M16	100	51390.160.001	M30	50	51390.300.001

- Stosowanie przy obciążeniach dynamicznych jest niedozwolone.
- Do blokowania przy obciążeniach dynamicznych należy stosować podkładki odporne na wibrację NORD-LOCK.
- Typ stali austenicznej pozostaje w gestii producenta i może różnić się od typów stali podanych w DIN 267-11.

55390 Podkładki sprężyste jednozwojowe do wkrętów o łbach walcowych i kulistych R49A

Materiał Stal nierdzewna A4
DIN ≈7980
BS ≈4464 A





Dla wymiaru nominalnego	✉	Kod artykułu	Dla wymiaru nominalnego	✉	Kod artykułu	Dla wymiaru nominalnego	✉	Kod artykułu
M3	250	55390.030.001	M10	200	55390.100.001	M20	100	55390.200.001
M4	250	55390.040.001	M12	200	55390.120.001	M24	50	55390.240.001
M5	250	55390.050.001	M14	100	55390.140.001	M27	50	55390.270.001
M6	250	55390.060.001	M16	100	55390.160.001	M30	50	55390.300.001
M8	250	55390.080.001	M18	100	55390.180.001			

- Stosowanie przy obciążeniach dynamicznych jest niedozwolone.
- Do blokowania przy obciążeniach dynamicznych należy stosować podkładki odporne na wibrację NORD-LOCK.
- Typ stali austenicznej pozostaje w gestii producenta i może różnić się od typów stali podanych w DIN 267-11.

Podkładki sprężyste do śrub z gwintem niemetrycznym

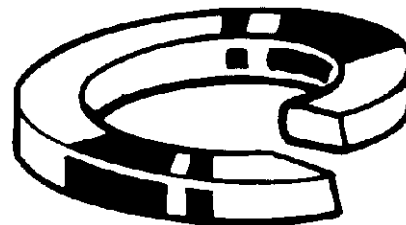
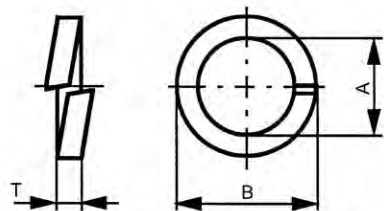
ASME B18.21.1



Informacje techniczne

Dla wymiaru nominalnego	A	B	T
No.4	0.114	0.173	0.022
No.5	0.127	0.202	0.030
No.6	0.141	0.216	0.03
No.8	0.167	0.267	0.047
No.10	0.193	0.294	0.047
1/4	0.252	0.363	0.078
5/16	0.314	0.457	0.093
3/8	0.377	0.550	0.125
7/16	0.440	0.644	0.140
1/2	0.502	0.733	0.172
5/8	0.628	0.917	0.203
3/4	0.753	1.105	0.218
7/8	0.878	1.291	0.234
1 Inch	1.003	1.478	0.250
1.1/4	1.254	1.790	0.313
1.1/2	1.504	2.159	0.375

Grupy katalogowe

Material	Kod	Strona
St	U37200	7-59
St.St. A2 (AISI304/18-8)	U51390	7-59

U37200 Podkładki sprężyste do śrub z gwintem niemetrycznym

X09A

Material Stal



Dla wymiaru nominalnego	☒	Kod artykułu	Dla wymiaru nominalnego	☒	Kod artykułu	Dla wymiaru nominalnego	☒	Kod artykułu
NO.4*	100	U37200.011.0001	5/16*	100	U37200.031.0001	3/4*	10	U37200.075.0001
NO.5*	100	U37200.012.0001	3/8*	50	U37200.037.0001	7/8*	5	U37200.087.0001
NO.6*	100	U37200.013.0001	7/16*	25	U37200.043.0001	1 Inch*	5	U37200.100.0001
NO.8*	100	U37200.016.0001	1/2*	25	U37200.050.0001	1.1/4*	5	U37200.125.0001
NO.10*	100	U37200.019.0001	5/8*	10	U37200.062.0001	1.1/2*	5	U37200.150.0001
1/4*	100	U37200.025.0001						

U51390 Podkładki sprężyste do śrub z gwintem niemetrycznym

X15A

Material Stal nierdzewna A2 (AISI 304/18-8)



Dla wymiaru nominalnego	☒	Kod artykułu	Dla wymiaru nominalnego	☒	Kod artykułu	Dla wymiaru nominalnego	☒	Kod artykułu
1/4	50	U51390.025.0001	3/8*	50	U51390.037.0001	7/16*	25	U51390.043.0001
5/16*	50	U51390.031.0001						

Podkładki sprężyste dwuzwojowe

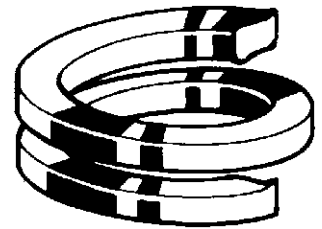
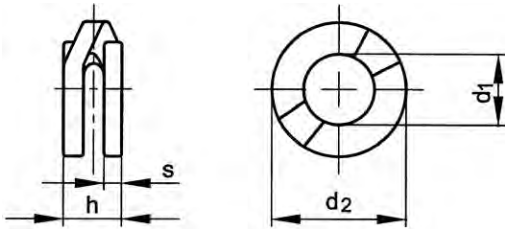

Informacje techniczne

Dla wymiaru nominalnego	d ₁	d ₂	h	s
M5	5.1	8.7	4.2	1.2
M6	6.1	11.1	5.6	1.6
M8	8.2	14.2	7	2
M10	10.2	17.2	7.7	2.2
M12	12.2	20.2	8.8	2.5
M16	16.2	26.2	12.3	3.5
M20	20.2	32.2	14	4
M22	22.5	34.5	14	4
M26	26.5	40.5	17.5	5

37240 Podkładki sprężyste dwuzwojowe

L07D

Material Stal sprężynowa



Dla wymiaru nominalnego	☒	Kod artykułu	Dla wymiaru nominalnego	☒	Kod artykułu	Dla wymiaru nominalnego	☒	Kod artykułu
M5	100	37240.050.001	M10	100	37240.100.001	M20	50	37240.200.001
M6	100	37240.060.001	M12	100	37240.120.001	M22	25	37240.220.001
M8	100	37240.080.001	M16	50	37240.160.001	M26	25	37240.260.001

- Ostrzeżenie: cynkowanie elektrolityczne tych produktów może wywołać kruchość wodorową.

Podkładki stożkowe sprężyste

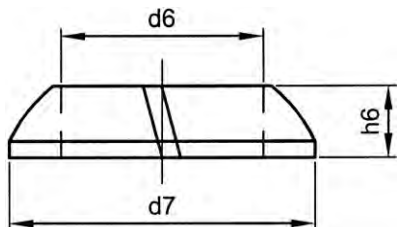

DIN 74361 C

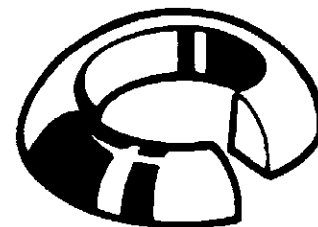

Informacje techniczne

d	d ₆	d ₇	h ₆	d	d ₆	d ₇	h ₆
M12	12.5	23	5	M18	18.5	29	7
M14	14.5	26	6	M20	20.5	34	8
M16 (#DIN)	17.5	27	7	M22	22.5	34	8

72030 Podkładki stożkowe sprężyste

Y92E

Materiał Stal sprężynowa DIN17221



d	☒	Kod artykułu	d	☒	Kod artykułu	d	☒	Kod artykułu
M12	50	72030.120.001	M16	50	72030.160.001	M20	25	72030.200.001
M14	50	72030.140.001	M18	25	72030.180.001	M22	25	72030.220.001

- Odpowiednie do śrub do kół.

Podkładki podatne faliste

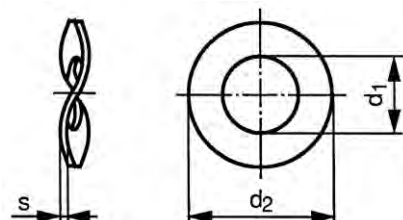

DIN 137 B
NEN 2457
NF E27-620

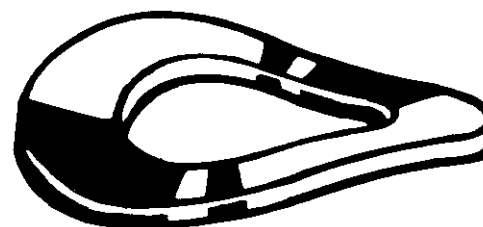

7

Informacje techniczne

Dla wymiaru nominalnego	d ₁	d ₂	s	Dla wymiaru nominalnego	d ₁	d ₂	s
M3	3.2	8	0.5	M12	13	24	1.2
M3.5	3.7	8	0.5	M14	15	28	1.6
M4	4.3	9	0.5	M16	17	30	1.6
M5	5.3	11	0.5	M18	19	34	1.6
M6	6.4	12	0.5	M20	21	36	1.6
M7	7.4	14	0.8	M22	23	40	1.8
M8	8.4	15	0.8	M24	25	44	1.8
M10	10.5	21	1	M27	28	50	2

Grupy katalogowe

Materiał	Obróbka powierzchni	Kod	Strona
Stal sprężynowa DIN267-26		37160	7-62
Stal sprężynowa DIN267-26	Ocynk. żłt. pas.	37150	7-62
St.St. A2		51551	7-62
St.St. A4		55551	7-62

37160	Podkładki podatne faliste	L07D
Materiał	Stal sprężynowa DIN267-26	

Dla wymiaru nominalnego	☒	Kod artykułu	Dla wymiaru nominalnego	☒	Kod artykułu	Dla wymiaru nominalnego	☒	Kod artykułu
M3	1000	37160.030.001	M8	1000	37160.080.001	M16	100	37160.160.001
M4	1000	37160.040.001	M10	500	37160.100.001	M20	100	37160.200.001
M5	1000	37160.050.001	M12	500	37160.120.001	M22	100	37160.220.001
M6	1000	37160.060.001	M14	100	37160.140.001	M24	100	37160.240.001
M7	1000	37160.070.001						

- Podkładki podatne faliste zgodn. z DIN 137 należy stosować w połączeniu z częściami złącznymi o klasie wytrzymałości < 5.8, stosowanie przy obciążeniach dynamicznych jest niedozwolone
- Są one przeznaczone do przeciwdziałania efektowi "luzu lub blokowania", który powoduje poluzowywanie się śrub i nakrętek (patrz DIN 267-26).
- Nie zapobiegają efektywnie poluzowywaniu się nakrętek pod zróżnicowanymi obciążeniami radialnymi, a są przeznaczone do stosowania z krótkimi śrubami poddanymi pchnięciom
- Do blokowania przy obciążeniach dynamicznych należy stosować podkładki z krawędzią blokującą i podkładki odporne na wibrację NORD-LOCK.
- Ostrzeżenie: cynkowanie elektrolityczne tych produktów może wywołać kruchość wodorową.

37150	Podkładki podatne faliste	L07D
Materiał	Stal sprężynowa DIN267-26	
Obróbka powierzchni	Ocynkowane, po żółtej pasywacji	

Dla wymiaru nominalnego	☒	Kod artykułu	Dla wymiaru nominalnego	☒	Kod artykułu	Dla wymiaru nominalnego	☒	Kod artykułu
M3	1000	37150.030.001	M7	1000	37150.070.001	M14	100	37150.140.001
M4	1000	37150.040.001	M8	1000	37150.080.001	M16	100	37150.160.001
M5	1000	37150.050.001	M10	500	37150.100.001			
M6	1000	37150.060.001	M12	500	37150.120.001			

- Podkładki podatne faliste zgodn. z DIN 137 należy stosować w połączeniu z częściami złącznymi o klasie wytrzymałości < 5.8, stosowanie przy obciążeniach dynamicznych jest niedozwolone
- Są one przeznaczone do przeciwdziałania efektowi "luzu lub blokowania", który powoduje poluzowywanie się śrub i nakrętek (patrz DIN 267-26).
- Nie zapobiegają efektywnie poluzowywaniu się nakrętek pod zróżnicowanymi obciążeniami radialnymi, a są przeznaczone do stosowania z krótkimi śrubami poddanymi pchnięciom
- Do blokowania przy obciążeniach dynamicznych należy stosować podkładki z krawędzią blokującą i podkładki odporne na wibrację NORD-LOCK.
- Ostrzeżenie: cynkowanie elektrolityczne tych produktów może wywołać kruchość wodorową.

7

51551	Podkładki podatne faliste	R09A
Materiał	Stal nierdzewna A2	DIN ≈137 B NEN ≈2457 NF ≈E27-620

Dla wymiaru nominalnego	☒	Kod artykułu	Dla wymiaru nominalnego	☒	Kod artykułu	Dla wymiaru nominalnego	☒	Kod artykułu
M3	200	51551.030.001	M8	200	51551.080.001	M18*	200	51551.180.001
M3,5*	1000	51551.035.001	M10	100	51551.100.001	M20	50	51551.200.001
M4	200	51551.040.001	M12	100	51551.120.001	M22*	100	51551.220.001
M5	200	51551.050.001	M14*	200	51551.140.001	M24	50	51551.240.001
M6	200	51551.060.001	M16	100	51551.160.001	M27*	100	51551.270.001
M7*	500	51551.070.001						

- Stosowanie przy obciążeniach dynamicznych jest niedozwolone.
- Do blokowania przy obciążeniach dynamicznych należy stosować podkładki odporne na wibrację NORD-LOCK.
- Typ stali austenicznej pozostaje w gestii producenta i może różnić się od typów stali podanych w DIN 267-11.

55551	Podkładki podatne faliste	R49A
Materiał	Stal nierdzewna A4	DIN ≈137 B NEN ≈2457 NF ≈E27-620

Dla wymiaru nominalnego	☒	Kod artykułu	Dla wymiaru nominalnego	☒	Kod artykułu	Dla wymiaru nominalnego	☒	Kod artykułu
M3*	1000	55551.030.001	M5*	1000	55551.050.001	M8*	500	55551.080.001
M4*	1000	55551.040.001	M6*	500	55551.060.001			

Podkładki podatne łukowe

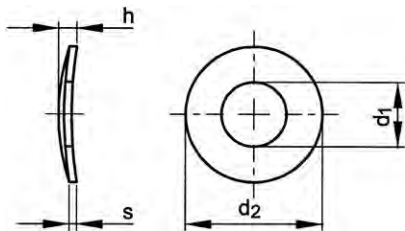

DIN 137 A
NEN 2456

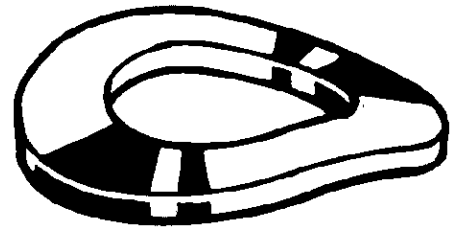

Informacje techniczne

Dla wymiaru nominalnego	d ₁	d ₂	h (max.)	s
M2	2.2	4.5	1	0.3
M2.3	2.5	5	1	0.3
M2.5 (≠DIN)	2.6	5	1	0.3
M2.6	2.8	5.5	1.1	0.3
M3	3.2	6	1.3	0.4
M3.5	3.7	7	1.4	0.4
M4	4.3	8	1.6	0.5
M5	5.3	10	1.8	0.5
M6	6.4	11	2.2	0.5
M7	7.4	12	2.4	0.5
M8	8.4	15	3.4	0.5
M10	10.5	18	4	0.8

- Podkładki sprężyste zgodn. z DIN 137 należy stosować w połączeniu z częściami złącznymi o klasie wytrzymałości < 5.8, stosowanie przy obciążeniach dynamicznych jest niedozwolone.
- Są one przeznaczone do przeciwdziałania efektowi "luzu lub blokowania", który powoduje poluzowywanie się śrub i nakrętek (patrz DIN 267-26).
- Nie zapobiegają efektywnie poluzowywaniu się nakrętek pod zróżnicowanymi obciążeniami radialnymi, i są przeznaczone do zastosowania z krótkimi śrubami poddanymi głównie pchnięciom.
- Do blokowania przy obciążeniach dynamicznych należy stosować podkładki z krawędzią blokującą i podkładki odporne na wibrację NORD-LOCK

Grupy katalogowe

Material	Obróbka powierzchni	Kod	Strona
Stal sprężynowa DIN267-26		37120	7-63
Stal sprężynowa DIN267-26	Ocynk. żłt. pas.	37110	7-63
St.St. A1		51550	7-64

37120 Podkładki podatne łukowe		L07D
Material	Stal sprężynowa DIN267-26	

Dla wymiaru nominalnego	☒	Kod artykułu	Dla wymiaru nominalnego	☒	Kod artykułu	Dla wymiaru nominalnego	☒	Kod artykułu
M2	500	37120.020.001	M3,5	500	37120.035.001	M7	500	37120.070.001
M2,3	500	37120.023.001	M4	500	37120.040.001	M8	500	37120.080.001
M2,6	500	37120.026.001	M5	500	37120.050.001	M10	200	37120.100.001
M3	500	37120.030.001	M6	500	37120.060.001			

- Ostrzeżenie: cynkowanie elektrolityczne tych produktów może wywołać kruchość wodorową.

37110 Podkładki podatne łukowe		L07D
Material	Stal sprężynowa DIN267-26	
Obróbka powierzchni	Ocynkowane, po żółtej pasywacji	

Dla wymiaru nominalnego	☒	Kod artykułu	Dla wymiaru nominalnego	☒	Kod artykułu	Dla wymiaru nominalnego	☒	Kod artykułu
M2	500	37110.020.001	M4	500	37110.040.001	M7	500	37110.070.001
M2,5	500	37110.025.001	M5	500	37110.050.001	M8	500	37110.080.001
M3	500	37110.030.001	M6	500	37110.060.001	M10	200	37110.100.001

- Ostrzeżenie: cynkowanie elektrolityczne tych produktów może wywołać kruchość wodorową.

51550	Podkładki podatne łukowe	R05A
Materiał	Stal nierdzewna A1	
		 

Dla wymiaru nominalnego	☒	Kod artykułu	Dla wymiaru nominalnego	☒	Kod artykułu	Dla wymiaru nominalnego	☒	Kod artykułu
M2*	1000	51550.020.001	M3,5*	1000	51550.035.001	M7*	500	51550.070.001
M2,3*	1000	51550.023.001	M4*	1000	51550.040.001	M8*	500	51550.080.001
M2,5*	1000	51550.025.001	M5*	1000	51550.050.001	M10*	500	51550.100.001
M3*	1000	51550.030.001	M6*	500	51550.060.001			

Podkładki podatne łukowe

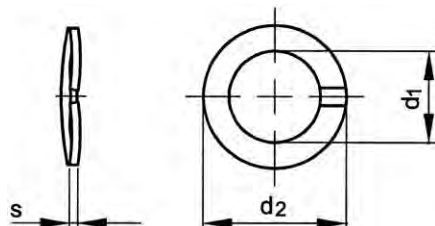

DIN 128 A
NEN 1570

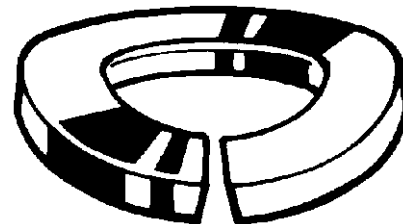

Informacje techniczne

Dla wymiaru nominalnego	d ₁ (min.)	d ₂ (maks.)	s	Dla wymiaru nominalnego	d ₁ (min.)	d ₂ (maks.)	s
M2	2.1	4.4	0.5	M14	14.2	24.1	2.4
M2.3 (#DIN)	2.4	4.9	0.6	M16	16.2	27.4	2.8
M2.5	2.6	5.1	0.6	M18	18.2	29.4	2.8
M2.6 (#DIN)	2.7	5.2	0.6	M20	20.2	33.6	3.2
M3	3.1	6.2	0.7	M22	22.5	35.9	3.2
M3.5	3.6	6.7	0.7	M24	24.5	40	4
M4	4.1	7.6	0.8	M27	27.5	43	4
M5	5.1	9.2	1	M30	30.5	48.2	6
M6	6.1	11.8	1.3	M33 (#DIN)	34	54.2	6
M7	7.1	12.7	1.3	M36	36.5	58.2	6
M8	8.1	14.8	1.6	M39 (#DIN)	39.5	59.2	6
M10	10.2	18.1	1.8	M42 (#DIN)	42.5	68.2	7
M11 (#DIN)	11.3	19.3	2.1	M45 (#DIN)	46.7	70.5	7
M12	12.2	21.1	2.1	M48 (#DIN)	49	75	7

Grupy katalogowe

Materiał	Obróbka powierzchni	Kod	Strona
Stal sprężynowa DIN267-26	Ocynk. mech.	37080	7-64
Stal sprężynowa DIN267-26	Ocynk. żłt. pas.	37092	7-65
St.St. A2		51520	7-65
St.St. A4		55520	7-65
Brąz fosforowy Cu4		50500	7-65

37080	Podkładki podatne łukowe	L07D
Materiał	Stal sprężynowa DIN267-26	
Obróbka powierzchni	Ocynkowane mechanicznie	
		 

Dla wymiaru nominalnego	☒	Kod artykułu	Dla wymiaru nominalnego	☒	Kod artykułu	Dla wymiaru nominalnego	☒	Kod artykułu
M2	500	37080.020.001	M8	200	37080.080.001	M24	50	37080.240.001
M2,5	500	37080.025.001	M10	200	37080.100.001	M27	25	37080.270.001
M2,6	500	37080.026.001	M11	150	37080.110.001	M30	25	37080.300.001
M3	250	37080.030.001	M12	150	37080.120.001	M33	25	37080.330.001
M3,5	250	37080.035.001	M14	100	37080.140.001	M36	25	37080.360.001
M4	250	37080.040.001	M16	100	37080.160.001	M39	10	37080.390.001
M5	250	37080.050.001	M18	100	37080.180.001	M42	10	37080.420.001
M6	250	37080.060.001	M20	100	37080.200.001	M45	10	37080.450.001
M7	250	37080.070.001	M22	50	37080.220.001	M48	10	37080.480.001

- Podkładki wielokrotnego użytku, nie powodujące uszkodzeń konstrukcji, nakrętki ani śruby.
- Przeznaczone do połączeń z częściami złącznymi o klasie wytrzymałości < 8.8. Stosowanie przy obciążeniach dynamicznych niedozwolone.
- Do blokowania przy obciążeniach dynamicznych należy stosować podkładki z krawędzią blokującą i podkładki odporne na wibrację NORD-LOCK.



37092 Podkładki podatne lukowe		L07D	
Materiał	Stal sprężynowa DIN267-26		
Obróbka powierzchni	Ocynkowane, po żółtej pasywacji		



Dla wymiaru nominalnego	Kod artykułu	Dla wymiaru nominalnego	Kod artykułu	Dla wymiaru nominalnego	Kod artykułu
M4	250 37092.040.001	M8	200 37092.080.001	M14	100 37092.140.001
M5	250 37092.050.001	M10	200 37092.100.001		
M6	250 37092.060.001	M12	150 37092.120.001		

- Podkładki wielokrotnego użytku, nie powodujące uszkodzeń konstrukcji, nakrętki ani śruby.
- Przeznaczone do połączeń z częściami złącznymi o klasie wytrzymałości < 8.8. Stosowanie przy obciążeniach dynamicznych niedozwolone.
- Do blokowania przy obciążeniach dynamicznych należy stosować podkładki z krawędzią blokującą i podkładki odporne na wibrację NORD-LOCK.



51520 Podkładki podatne lukowe		R09A	
Materiał	Stal nierdzewna A2	DIN	≈128 A
		NEN	≈1570

Dla wymiaru nominalnego	Kod artykułu	Dla wymiaru nominalnego	Kod artykułu	Dla wymiaru nominalnego	Kod artykułu
M2	100 51520.020.001	M6	250 51520.060.001	M18	100 51520.180.001
M2,5	100 51520.025.001	M8	200 51520.080.001	M20	100 51520.200.001
M2,6	100 51520.026.001	M10	200 51520.100.001	M22	50 51520.220.001
M3	250 51520.030.001	M12	150 51520.120.001	M24	50 51520.240.001
M3,5	250 51520.035.001	M14	100 51520.140.001	M30	25 51520.300.001
M4	250 51520.040.001	M16	100 51520.160.001	M36	25 51520.360.001
M5	250 51520.050.001				

- Wymiary różnią się nieznacznie od tych w DIN 128 A, te podkładki sprężyste mają niezgodną, "wzmocnioną" grubość, której efektem są znacząco poprawione charakterystyki sprężystości.
- Podkładki wielokrotnego użytku, nie powodujące uszkodzeń konstrukcji, nakrętki ani śruby.
- Stosowanie przy obciążeniach dynamicznych niedozwolone.
- Do blokowania przy obciążeniach dynamicznych należy stosować podkładki odporne na wibrację NORD-LOCK.
- Typ stali austenicznej pozostaje w gestii producenta i może różnić się od typów stali podanych w DIN 267-11.



55520 Podkładki podatne lukowe		R49A	
Materiał	Stal nierdzewna A4	DIN	≈128 A
		NEN	≈1570

Dla wymiaru nominalnego	Kod artykułu	Dla wymiaru nominalnego	Kod artykułu	Dla wymiaru nominalnego	Kod artykułu
M2*	1000 55520.020.001	M6	250 55520.060.001	M14*	250 55520.140.001
M2,5*	1000 55520.025.001	M8	200 55520.080.001	M16	100 55520.160.001
M3	250 55520.030.001	M10	200 55520.100.001	M20	100 55520.200.001
M4	250 55520.040.001	M12	150 55520.120.001	M24*	100 55520.240.001
M5	250 55520.050.001				

- Wymiary różnią się nieznacznie od tych w DIN 128 A, te podkładki sprężyste mają niezgodną, "wzmocnioną" grubość, której efektem są znacząco poprawione charakterystyki sprężystości.
- Podkładki wielokrotnego użytku, nie powodujące uszkodzeń konstrukcji, nakrętki ani śruby.
- Stosowanie przy obciążeniach dynamicznych niedozwolone.
- Do blokowania przy obciążeniach dynamicznych należy stosować podkładki odporne na wibrację NORD-LOCK.
- Typ stali austenicznej pozostaje w gestii producenta i może różnić się od typów stali podanych w DIN 267-11.

50500 Podkładki podatne lukowe		M11F	
Materiał	Brąz fosforowy Cu4	DIN	≈128 A
		NEN	≈1570

Dla wymiaru nominalnego	Kod artykułu	Dla wymiaru nominalnego	Kod artykułu	Dla wymiaru nominalnego	Kod artykułu
M2,6	500 50500.026.001	M6	250 50500.060.001	M16	100 50500.160.001
M3	250 50500.030.001	M8	200 50500.080.001	M18	100 50500.180.001
M4	250 50500.040.001	M10	200 50500.100.001	M20	100 50500.200.001
M5	250 50500.050.001	M12	150 50500.120.001		

- Wymiary różnią się nieznacznie od tych w DIN 128 A, te podkładki sprężyste mają niezgodną, "wzmocnioną" grubość, której efektem są znacząco poprawione charakterystyki sprężystości.

Podkładki podatne łukowe z krawędzią zabezpieczającą

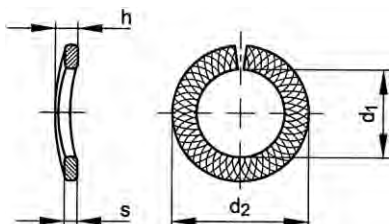

DIN ≈128 A
NEN ≈1570

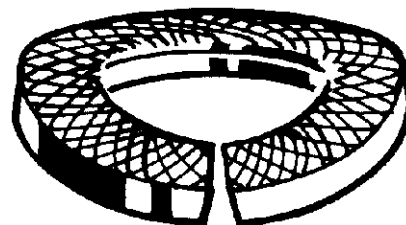

Informacje techniczne

Dla wymiaru nominalnego	d ₁	d ₂ (maks.)	s	Dla wymiaru nominalnego	d ₁	d ₂ (maks.)	s
M4	4.1	7.6	0.8	M16	16.2	27.4	2.8
M5	5.1	9.2	1	M18	18.2	29.4	2.8
M6	6.1	11.8	1.3	M20	20.2	33.6	3.2
M8	8.1	14.9	1.6	M22	22.5	35.9	3.2
M10	10.2	18.1	1.8	M24	24.5	40	4
M12	12.2	21.1	2.1	M27	27.5	43	4
M14	14.2	24.1	2.4	M30	30.5	48.2	6

Specjalne wytrzymałości podkładek z krawędzią zabezpieczającą FABORY:

- właściwe w połączeniu ze śrubą o łbie sześciokątnym, nakrętką sześciokątną, itd. o klasie własności ≤ 8.8
- wyprofilowana powierzchnia (patent) daje dobre zabezpieczenie przeciw własnościami luzującymi i zmniejsza stratę montażu z obciążeniem wstępnym
- wyrównanie luzu i ustawienie połączenia przez długie sprężynujące ugięcie
- posiada chropowatą powierzchnię, tak więc nadaje się do użytku z bardziej miękkimi materiałami i powierzchniami powlekanymi
- nadają się do ponownego użycia
- dostosowane do automatycznej instalacji
- niewrażliwe na temperaturę od -10°C do +300°C
- rozmiary i inne własności według normy DIN 128A
- proste zastosowanie w połączeniu z obecnie standardowymi elementami złącznymi
- również możliwe do zastosowania ze śrubami z łbem sześciokątnym, sześciokątnymi nakrętkami, itd. z gwintem lewozwojnym

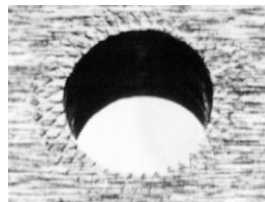
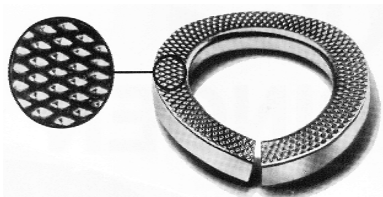

7

37070 Podkładki łukowe z krawędzią zabezpieczającą

L07D

Materiał Stal sprężynowa DIN267-26
Obróbka powierzchni Mechanicznie cynkowane, po żółtej pasywacji



Dla wymiaru nominalnego	☒	Kod artykułu	Dla wymiaru nominalnego	☒	Kod artykułu	Dla wymiaru nominalnego	☒	Kod artykułu
M4	250	37070.040.001	M12	150	37070.120.001	M22	50	37070.220.001
M5	250	37070.050.001	M14	100	37070.140.001	M24	50	37070.240.001
M6	250	37070.060.001	M16	100	37070.160.001	M27	25	37070.270.001
M8	200	37070.080.001	M18	100	37070.180.001	M30	25	37070.300.001
M10	200	37070.100.001	M20	100	37070.200.001			

Podkładki wachlarzowe ząbkowane wewnętrznie, powiększone, typ JZC

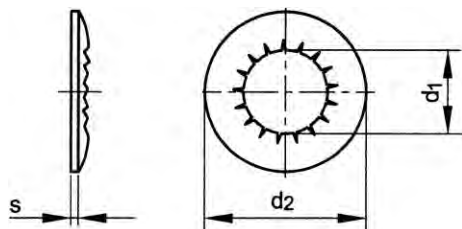



NF E25-512



Informacje techniczne

Dla wymiaru nominalnego	d ₁	d ₂	s	Dla wymiaru nominalnego	d ₁	d ₂	s
M3	3.2	8.7	0.5	M6	6.1	18.3	1
M4	4.3	11.2	0.6	M10	10.2	26.3	1.4
M5	5.1	16.2	1	M12	12.2	32.4	1.4

- Głównym celem podkładek wachlarzowych ząbkowanych jest umożliwienie przepływu prądu elektrycznego między elementami pokrytymi lakierem, środkami antykorozyjnymi lub podobnymi materiałami - wygięte końce podkładek przebijają powłokę podczas łączenia takich elementów. Tam, gdzie podkładki takie mają zapobiec luzowaniu się łączników o niskiej klasie wytrzymałości, ich efektywność powinna być sprawdzona dla danego zastosowania.
- Wewnętrzne ząbki i bardzo duża średnica zewnętrzna d₂, dodatkowa odporność przez formę kopuły.

37560	Podkładki wachlarzowe ząbkowane wewnętrznie, powiększone, typ JZC	L07D
Materiał	Stal sprężynowa	
		

Dla wymiaru nominalnego	☒	Kod artykułu	Dla wymiaru nominalnego	☒	Kod artykułu	Dla wymiaru nominalnego	☒	Kod artykułu
M3	1000	37560.030.001	M5	1000	37560.050.001	M10	100	37560.100.001
M4	1000	37560.040.001	M6	1000	37560.060.001	M12	100	37560.120.001

- Ostrzeżenie: cynkowanie elektrolityczne tych produktów może wywołać kruchość wodorową.

Podkładki stożkowe wachlarzowe ząbkowane zewnętrznie

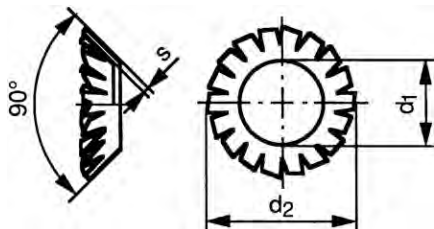

DIN 6798 V
NF E27-627

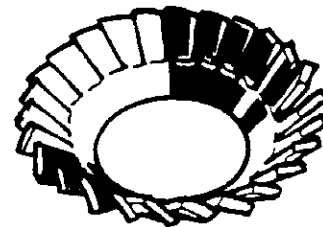

Informacje techniczne

Dla wymiaru nominalnego	d ₁	d ₂ ≈	s	Dla wymiaru nominalnego	d ₁	d ₂ ≈	s
M3	3.2	6	0.2	M10	10.5	19	0.5
M4	4.3	8	0.25	M12	13	23	0.5
M5	5.3	9.8	0.3	M14	15	26.2	0.6
M6	6.4	11.8	0.4	M16	17	30.2	0.6
M8	8.4	15.3	0.4				

- Głównym celem podkładek wachlarzowych ząbkowanych jest umożliwienie przepływu prądu elektrycznego między elementami pokrytymi lakierem, środkami antykorozyjnymi lub podobnymi materiałami, wygięte końce podkładek przebijają powłokę podczas łączenia takich elementów. Tam, gdzie podkładki takie mają zapobiec luzowaniu się części złącznych o niskiej klasie właściwości, ich efektywność powinna być sprawdzona dla danego zastosowania.
- Odpowiednie dla śrub i nakrętek o normalnej szerokości płaskich powierzchni.

Grupy katalogowe

Material	Obróbka powierzchni	Kod	Strona
Stal sprężynowa 350-425 HV10		37500	7-68
Stal sprężynowa 350-425 HV10	Ocynk.	37520	7-68
St.St. A2		51463	7-68

37500 Podkładki stożkowe wachlarzowe ząbkowane zewnętrznie L07D

Material Stal sprężynowa 350-425 HV10



Dla wymiaru nominalnego	Kod artykułu	Dla wymiaru nominalnego	Kod artykułu	Dla wymiaru nominalnego	Kod artykułu
M3	1000 37500.030.001	M6	1000 37500.060.001	M12	500 37500.120.001
M4	1000 37500.040.001	M8	1000 37500.080.001	M14	100 37500.140.001
M5	1000 37500.050.001	M10	1000 37500.100.001	M16	100 37500.160.001

- Ostrzeżenie: cynkowanie elektrolityczne tych produktów może wywołać kruchość wodorową.

37520 Podkładki stożkowe wachlarzowe ząbkowane zewnętrznie L07D

Material Stal sprężynowa 350-425 HV10
Obróbka powierzchni Ocynkowane



Dla wymiaru nominalnego	Kod artykułu	Dla wymiaru nominalnego	Kod artykułu	Dla wymiaru nominalnego	Kod artykułu
M4	1000 37520.040.001	M6	1000 37520.060.001	M10	1000 37520.100.001
M5	1000 37520.050.001	M8	1000 37520.080.001	M12	500 37520.120.001

- Ostrzeżenie: cynkowanie elektrolityczne tych produktów może wywołać kruchość wodorową.

51463 Podkładki stożkowe wachlarzowe ząbkowane zewnętrznie R09A

Material Stal nierdzewna A2



Dla wymiaru nominalnego	Kod artykułu	Dla wymiaru nominalnego	Kod artykułu	Dla wymiaru nominalnego	Kod artykułu
M3*	1000 51463.030.001	M6*	1000 51463.060.001	M12*	500 51463.120.001
M4*	1000 51463.040.001	M8*	500 51463.080.001	M16*	200 51463.160.001
M5*	1000 51463.050.001	M10*	500 51463.100.001		

Podkładki stożkowe ząbkowane zewnętrznie, niemetryczne

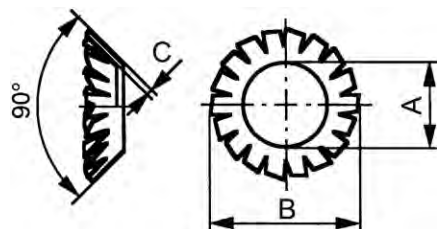

ASME B18.21.1

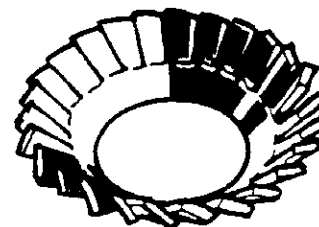

Informacje techniczne

Dla wymiaru nominalnego	A	B	C
No.6	0.140	0.289	0.017
No.8	0.167	0.322	0.017
No.10	0.195	0.354	0.020
No.12	0.220	0.421	0.020
1/4	0.255	0.454	0.020
5/16	0.318	0.599	0.023
3/8	0.383	0.765	0.028

U37500 Podkładki stożkowe ząbkowane zewnętrznie, niemetryczne

X09A

Materiał Stal sprężynowa
Obróbka powierzchni Ocynkowane



Dla wymiaru nominalnego	☒	Kod artykułu	Dla wymiaru nominalnego	☒	Kod artykułu	Dla wymiaru nominalnego	☒	Kod artykułu
NO.6*	100	U37500.013.0001	NO.12*	100	U37500.021.0001	3/8*	50	U37500.037.0001
NO.8*	100	U37500.016.0001	1/4*	100	U37500.025.0001			
NO.10*	100	U37500.019.0001	5/16*	100	U37500.031.0001			

Podkładki ząbkowane wewnętrznie i zewnętrznie, niemetryczne

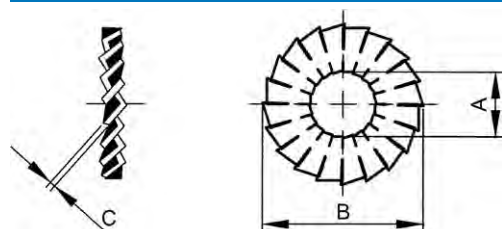

ASME B18.21.1

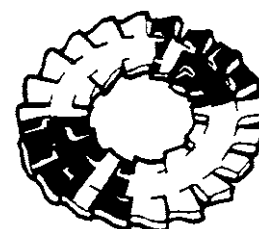

Informacje techniczne

Dla wymiaru nominalnego	A	B	C
No.4	0.115	0.510	0.017
No.6	0.141	0.610	0.023
No.8	0.168	0.690	0.028
No.10	0.195	0.740	0.032
1/4	0.256	0.965	0.037
5/16	0.320	1.045	0.042
3/8	0.384	1.130	0.042
1/2	0.512	1.3801	0.052

U37590 Podkładki ząbkowane wewnętrznie i zewnętrznie, niemetryczne

X09A

Materiał Stal sprężynowa
Obróbka powierzchni Ocynkowane

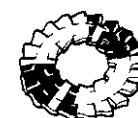

Dla wymiaru nominalnego	☒	Kod artykułu	Dla wymiaru nominalnego	☒	Kod artykułu	Dla wymiaru nominalnego	☒	Kod artykułu
NO.4*	100	U37590.011.0001	NO.10*	100	U37590.019.0001	3/8*	50	U37590.037.0001
NO.6*	100	U37590.013.0001	1/4*	100	U37590.025.0001	1/2*	25	U37590.050.0001
NO.8*	100	U37590.016.0001	5/16*	100	U37590.031.0001			

Podkładki ząbkowane zewnętrznie, niemetryczne

ASME B18.21.1

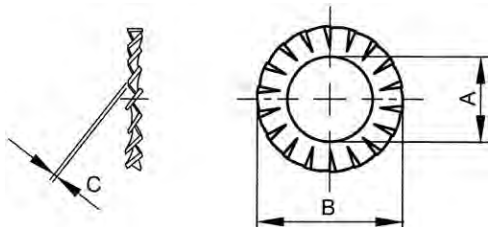

Informacje techniczne

Dla wymiaru nominalnego	A	B	C
No.3	0.102	0.220	0.01
No.4	0.115	0.245	0.012
No.5	0.129	0.270	0.014
No.6	0.141	0.305	0.016
No.8	0.168	0.365	0.018
No.10	0.195	0.395	0.018
No.12	0.221	0.460	0.020
1/4	0.256	0.494	0.023
5/16	0.320	0.588	0.028
3/8	0.384	0.670	0.032
7/16	0.448	0.740	0.032
1/2	0.513	0.880	0.037
9/16	0.576	0.960	0.037
5/8	0.641	1.045	0.042
3/4	0.768	1.22	0.047
7/8	0.897	1.380	0.052
1 Inch	1.025	1.59	0.059

Grupy katalogowe

Material	Kod	Strona
St	U37420	7-70
St.St. A2 (AISI304/18-8)	U51460	7-70
St.St. A4 (AISI316/18-10)	U55460	7-71
St.St. AISI410	U53460	7-71
Mosiądz PH	U50450	7-71

7

U37420 Podkładki ząbkowane zewnętrznie, niemetryczne

X09A

Material Stal



Dla wymiaru nominalnego	Kod artykułu	Dla wymiaru nominalnego	Kod artykułu	Dla wymiaru nominalnego	Kod artykułu
NO.4*	100 U37420.011.0001	1/4*	100 U37420.025.0001	9/16*	25 U37420.056.0001
NO.6*	100 U37420.013.0001	5/16*	100 U37420.031.0001	5/8*	10 U37420.062.0001
NO.8*	100 U37420.016.0001	3/8*	50 U37420.037.0001	3/4*	10 U37420.075.0001
NO.10*	100 U37420.019.0001	7/16*	25 U37420.043.0001	7/8*	5 U37420.087.0001
NO.12*	100 U37420.021.0001	1/2*	25 U37420.050.0001	1 Inch*	5 U37420.100.0001

U51460 Podkładki ząbkowane zewnętrznie, niemetryczne

X15A

Material Stal nierdzewna A2 (AISI 304/18-8)



Dla wymiaru nominalnego	Kod artykułu	Dla wymiaru nominalnego	Kod artykułu	Dla wymiaru nominalnego	Kod artykułu
NO.4*	50 U51460.011.0001	NO.10*	50 U51460.019.0001	3/8*	50 U51460.037.0001
NO.6*	50 U51460.013.0001	1/4*	50 U51460.025.0001	1/2*	10 U51460.050.0001
NO.8*	50 U51460.016.0001	5/16*	50 U51460.031.0001		

U55460 Podkładki ząbkowane zewnętrznie, niemetryczne				X15A				
Materiał		Stal nierdzewna A4 (AISI 316/18-10)						
Dla wymiaru nominalnego	✉	Kod artykułu	Dla wymiaru nominalnego	✉	Kod artykułu	Dla wymiaru nominalnego	✉	Kod artykułu
NO.3*	50	U55460.009.0001	NO.5*	50	U55460.012.0001	NO.8*	50	U55460.016.0001
NO.4*	50	U55460.011.0001	NO.6*	50	U55460.013.0001	NO.10*	50	U55460.019.0001

U53460 Podkładki ząbkowane zewnętrznie, niemetryczne				X15A				
Materiał		Stal nierdzewna AISI410						
Dla wymiaru nominalnego	✉	Kod artykułu	Dla wymiaru nominalnego	✉	Kod artykułu	Dla wymiaru nominalnego	✉	Kod artykułu
NO.4*	50	U53460.011.0001	1/4*	50	U53460.025.0001	1/2*	10	U53460.050.0001
NO.6*	50	U53460.013.0001	5/16*	50	U53460.031.0001	5/8*	10	U53460.062.0001
NO.8*	50	U53460.016.0001	3/8*	50	U53460.037.0001	3/4*	5	U53460.075.0001
NO.10*	50	U53460.019.0001	7/16*	25	U53460.043.0001			

U50450 Podkładki ząbkowane zewnętrznie, niemetryczne				X09A				
Materiał		Brąz PH						
Dla wymiaru nominalnego	✉	Kod artykułu	Dla wymiaru nominalnego	✉	Kod artykułu	Dla wymiaru nominalnego	✉	Kod artykułu
NO.4	100	U50450.011.0001	NO.10*	100	U50450.019.0001	3/8*	50	U50450.037.0001
NO.6*	100	U50450.013.0001	1/4*	100	U50450.025.0001	1/2*	25	U50450.050.0001
NO.8*	100	U50450.016.0001	5/16*	100	U50450.031.0001			

Podkładki ząbkowane zewnętrznie i wewnętrznie, typ DD

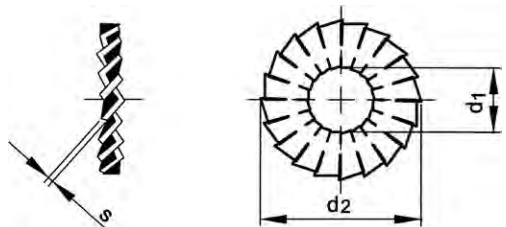

NF ≈E27-626

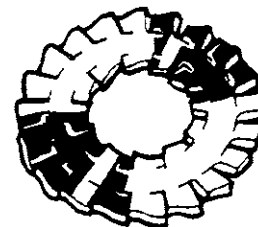

Informacje techniczne

Dla wymiaru nominalnego	d ₁	d ₂	s	Dla wymiaru nominalnego	d ₁	d ₂	s
M4	4.2	15.6	0.8	M10	10.3	26.1	1.1
M5	5.2	17.9	0.8	M12	12.3	30.3	1.2
M6	6.2	18.2	0.8	M16	16.5	36.1	1.4
M8	8.2	22.3	1				

- Głównym celem podkładek wachlarzowych ząbkowanych jest umożliwienie przepływu prądu elektrycznego między elementami pokrytymi lakierem, środkami antykorozyjnymi lub podobnymi materiałami, wygięte końce podkładek przebijają powłokę podczas łączenia takich elementów. Tam, gdzie podkładki takie mają zapobiec luzowaniu się części złącznych o niskiej klasie wytrzymałości, ich efektywność powinna być sprawdzona dla danego zastosowania.
- Ząbkowanie dwustronne i bardzo duża średnica zewnętrzna d₂. Zalecane dla otworów nadwymiarowych i wydłużonych, gdzie wymagana jest duża powierzchnia kontaktu i między częściami, aby chronić je przed przesuwaniem.

Grupy katalogowe

Materiał	Obróbka powierzchni	Kod	Strona
Stal sprężynowa		37580	7-72
Stal sprężynowa	Ocynk.	37590	7-72

37580 Podkładki ząbkowane zewnętrznie i wewnętrznie, typ DD L07D

Materiał Stal sprężynowa



Dla wymiaru nominalnego	Kod artykułu	Dla wymiaru nominalnego	Kod artykułu	Dla wymiaru nominalnego	Kod artykułu
M4	1000 37580.040.001	M8	500 37580.080.001	M16	100 37580.160.001
M5	1000 37580.050.001	M10	500 37580.100.001		
M6	500 37580.060.001	M12	100 37580.120.001		

- Ostrzeżenie: cynkowanie elektrolityczne tych produktów może wywołać kruchość wodorową.

37590 Podkładki ząbkowane zewnętrznie i wewnętrznie, typ DD L07D

Materiał Stal sprężynowa
Obróbka powierzchni Ocynkowane

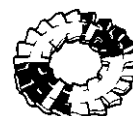

Dla wymiaru nominalnego	Kod artykułu	Dla wymiaru nominalnego	Kod artykułu	Dla wymiaru nominalnego	Kod artykułu
M4	1000 37590.040.001	M8	500 37590.080.001	M16	100 37590.160.001
M5	1000 37590.050.001	M10	500 37590.100.001		
M6	500 37590.060.001	M12	100 37590.120.001		

Podkładki wachlarzowe ząbkowane wewnętrznie

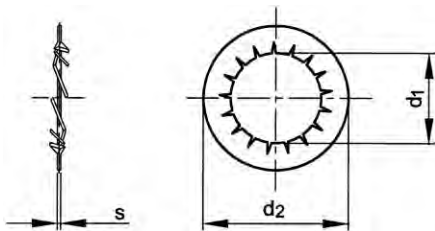

DIN 6798 J
NEN 2454
NF E27-625

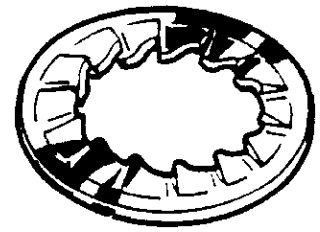

Informacje techniczne

Dla wymiaru nominalnego	d ₁	d ₂	s	Dla wymiaru nominalnego	d ₁	d ₂	s
M2	2.2	4.5	0.3	M8	8.4	15	0.8
M2.3 (#DIN)	2.5	5	0.4	M10	10.5	18	0.9
M2.5	2.7	5.5	0.4	M12	13	20.5	1
M3	3.2	6	0.4	M14	15	24	1
M3.5	3.7	7	0.5	M16	17	26	1.2
M4	4.3	8	0.5	M18	19	30	1.4
M5 (#DIN)	5.1	9	0.5	M20	21	33	1.4
M5	5.3	10	0.6	M22	23	36	1.5
M6	6.4	11	0.7	M24	25	38	1.5
M7	7.4	12.5	0.8	M27	28	44	1.6
M8 (#DIN)	8.2	14	0.8	M30	31	48	1.6

- Głównym celem podkładek zabezpieczających zębatach jest umożliwienie na przepływ prądu elektrycznego między elementami pokrytymi lakierem, środkami antykorozyjnymi lub podobnymi materiałami - wygięte końce podkładek przebijają powłokę podczas łączenia takich elementów. Tam, gdzie podkładki takie mają zapobiec luzowaniu się łączników z niskiej klasy wytrzymałości, należy sprawdzić ich efektywność dla danego zastosowania.
- Odpowiednie dla śrub i nakrętek z normalną szerokością płaskich powierzchni.

Grupy katalogowe

Materiał	Obróbka powierzchni	Kod	Strona
Stal sprężynowa 350-425 HV10		37460	7-73
Stal sprężynowa 350-425 HV10	Ocynk.	37480	7-73
St.St. A2		51462	7-74
St.St. A4		55462	7-74

37460 Podkładki wachlarzowe ząbkowane wewnętrznie

L07D

Materiał Stal sprężynowa 350-425 HV10



Dla wymiaru nominalnego	☒	Kod artykułu	Dla wymiaru nominalnego	☒	Kod artykułu	Dla wymiaru nominalnego	☒	Kod artykułu
M2	1000	37460.020.001	M7	1000	37460.070.001	M18	100	37460.180.001
M3	1000	37460.030.001	M8 (#DIN)	1000	37460.080.001	M20	100	37460.200.001
M3,5	1000	37460.035.001	M8	1000	37460.080.002	M22	100	37460.220.001
M4	1000	37460.040.001	M10	1000	37460.100.001	M24	100	37460.240.001
M5 (#DIN)	1000	37460.050.001	M12	1000	37460.120.001	M27	100	37460.270.001
M5	1000	37460.050.002	M14	500	37460.140.001	M30	100	37460.300.001
M6	1000	37460.060.001	M16	500	37460.160.001			

37480 Podkładki wachlarzowe ząbkowane wewnętrznie

L07D

Materiał Stal sprężynowa 350-425 HV10
Obróbka powierzchni Ocynkowane



Dla wymiaru nominalnego	☒	Kod artykułu	Dla wymiaru nominalnego	☒	Kod artykułu	Dla wymiaru nominalnego	☒	Kod artykułu
M2	1000	37480.020.001	M6	1000	37480.060.001	M14	500	37480.140.001
M2,5	1000	37480.025.001	M7	1000	37480.070.001	M16	500	37480.160.001
M3	1000	37480.030.001	M8 (#DIN)	1000	37480.080.001	M18	100	37480.180.001
M3,5	1000	37480.035.001	M8	1000	37480.080.002	M20	100	37480.200.001
M4	1000	37480.040.001	M10	1000	37480.100.001	M22	100	37480.220.001
M5 (#DIN)	1000	37480.050.001	M12	1000	37480.120.001	M24	100	37480.240.001
M5	1000	37480.050.002						

51462	Podkładki wachlarzowe ząbkowane wewnętrznie	R09A
Materiał	Stal nierdzewna A2	DIN ≈6798 J NEN ≈2454 NF ≈E27-625

Dla wymiaru nominalnego	⊗	Kod artykułu	Dla wymiaru nominalnego	⊗	Kod artykułu	Dla wymiaru nominalnego	⊗	Kod artykułu
M2,5	200	51462.025.001	M8	200	51462.080.001	M18	100	51462.180.001
M3	200	51462.030.001	M8 (#DIN)*	1000	51462.082.001	M20	100	51462.200.001
M4	200	51462.040.001	M10	100	51462.100.001	M22*	200	51462.220.001
M5	200	51462.050.001	M12	100	51462.120.001	M24	50	51462.240.001
M5 (#DIN)*	1000	51462.051.001	M14	100	51462.140.001	M27	50	51462.270.001
M6	200	51462.060.001	M16	100	51462.160.001	M30*	100	51462.300.001
M7*	1000	51462.070.001						

• Typ stali austenicznej pozostaje w gestii producenta i może różnić się od typów stali podanych w DIN 267-11.

55462	Podkładki wachlarzowe ząbkowane wewnętrznie	R49A
Materiał	Stal nierdzewna A4	DIN ≈6798 J NEN ≈2454 NF ≈E27-625

Dla wymiaru nominalnego	⊗	Kod artykułu	Dla wymiaru nominalnego	⊗	Kod artykułu	Dla wymiaru nominalnego	⊗	Kod artykułu
M2,3*	1000	55462.023.001	M8	200	55462.080.001	M18	100	55462.180.001
M3	200	55462.030.001	M8*	1000	55462.080.002	M20	100	55462.200.001
M4	200	55462.040.001	M8 (#DIN)*	1000	55462.082.001	M22*	200	55462.220.001
M5	200	55462.050.001	M10	100	55462.100.001	M24	50	55462.240.001
M5*	1000	55462.050.002	M12	100	55462.120.001	M27*	100	55462.270.001
M5 (#DIN)*	1000	55462.051.001	M14	100	55462.140.001	M30*	100	55462.300.001
M6	200	55462.060.001	M16	100	55462.160.001			

• Typ stali austenicznej pozostaje w gestii producenta i może różnić się od typów stali podanych w DIN 267-11.

Podkładki ząbkowane wewnętrznie, niemetryczne

7

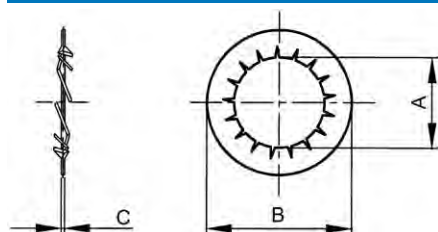

ASME B18.21.1

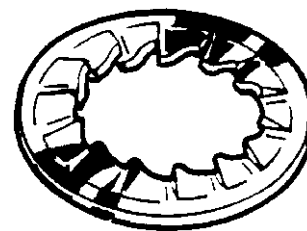

Informacje techniczne

Dla wymiaru nominalnego	A	B	C
No.2	0.089	0.172	0.010
No.3	0.102	0.215	0.010
No.4	0.115	0.245	0.012
No.6	0.141	0.275	0.016
No.8	0.168	0.325	0.018
No.10	0.195	0.365	0.018
No.12	0.221	0.394	0.020
1/4	0.256	0.460	0.023
5/16	0.320	0.594	0.028
3/8	0.384	0.670	0.032
7/16	0.448	0.740	0.032
1/2	0.512	0.867	0.037
9/16	0.576	0.957	0.037
5/8	0.640	1.045	0.042
3/4	0.769	1.220	0.047
7/8	0.894	1.364	0.052
1 Inch	1.019	1.590	0.059

Grupy katalogowe

Materiał	Obróbka powierzchni	Kod	Strona
St	Ocynek.	U37480	7-75

Grupy katalogowe

Material	Obróbka powierzchni	Kod	Strona
St.St. A2 (AISI304/18-8)		U51462	7-75
St.St. A4 (AISI316/18-10)		U55462	7-75
St.St. AISI410		U53462	7-75
Mosiądz PH		U50462	7-76

U37480 Podkładki ząbkowane wewnętrznie, niemetryczne X09A

Material: Stal
Obróbka powierzchni: Ocynkowane



Dla wymiaru nominalnego	Kod artykułu	Dla wymiaru nominalnego	Kod artykułu	Dla wymiaru nominalnego	Kod artykułu
NO.2*	100 U37480.008.0001	1/4*	100 U37480.025.0001	9/16*	25 U37480.056.0001
NO.4*	100 U37480.011.0001	5/16*	100 U37480.031.0001	5/8*	10 U37480.062.0001
NO.6*	100 U37480.013.0001	3/8*	50 U37480.037.0001	3/4*	10 U37480.075.0001
NO.8*	100 U37480.016.0001	7/16*	25 U37480.043.0001	7/8*	5 U37480.087.0001
NO.10*	100 U37480.019.0001	1/2*	25 U37480.050.0001	1 Inch*	5 U37480.100.0001
NO.12*	100 U37480.021.0001				

U51462 Podkładki ząbkowane wewnętrznie, niemetryczne X15A

Material: Stal nierdzewna A2 (AISI 304/18-8)



Dla wymiaru nominalnego	Kod artykułu	Dla wymiaru nominalnego	Kod artykułu	Dla wymiaru nominalnego	Kod artykułu
NO.4*	50 U51462.011.0001	1/4*	50 U51462.025.0001	9/16*	10 U51462.056.0001
NO.6*	50 U51462.013.0001	5/16*	50 U51462.031.0001	5/8*	10 U51462.062.0001
NO.8*	50 U51462.016.0001	3/8*	50 U51462.037.0001	3/4*	5 U51462.075.0001
NO.10*	50 U51462.019.0001	1/2*	10 U51462.050.0001		

U55462 Podkładki ząbkowane wewnętrznie, niemetryczne X15A

Material: Stal nierdzewna A4 (AISI 316/18-10)



Dla wymiaru nominalnego	Kod artykułu	Dla wymiaru nominalnego	Kod artykułu	Dla wymiaru nominalnego	Kod artykułu
NO.4*	50 U55462.011.0001	NO.10*	50 U55462.019.0001	3/8*	50 U55462.037.0001
NO.6*	50 U55462.013.0001	1/4*	50 U55462.025.0001		
NO.8*	50 U55462.016.0001	5/16*	50 U55462.031.0001		

U53462 Podkładki ząbkowane wewnętrznie, niemetryczne X15A

Material: Stal nierdzewna AISI410



Dla wymiaru nominalnego	Kod artykułu	Dla wymiaru nominalnego	Kod artykułu	Dla wymiaru nominalnego	Kod artykułu
NO.2*	50 U53462.008.0001	NO.10*	50 U53462.019.0001	7/16*	25 U53462.043.0001
NO.3*	50 U53462.009.0001	NO.12*	50 U53462.021.0001	1/2*	10 U53462.050.0001
NO.4*	50 U53462.011.0001	1/4*	50 U53462.025.0001	5/8*	10 U53462.062.0001
NO.6*	50 U53462.013.0001	5/16*	50 U53462.031.0001	3/4*	5 U53462.075.0001
NO.8*	50 U53462.016.0001	3/8*	50 U53462.037.0001		

U50462	Podkładki ząbkowane wewnętrznie, niemetryczne	X09A
Materiał	Brąz PH	
		 

Dla wymiaru nominalnego	☒	Kod artykułu	Dla wymiaru nominalnego	☒	Kod artykułu	Dla wymiaru nominalnego	☒	Kod artykułu
NO.2*	100	U50462.008.0001	NO.8*	100	U50462.016.0001	5/16*	100	U50462.031.0001
NO.4*	100	U50462.011.0001	NO.10*	100	U50462.019.0001	3/8*	50	U50462.037.0001
NO.6*	100	U50462.013.0001	1/4*	100	U50462.025.0001	1/2*	25	U50462.050.0001

Podkładki ząbkowane wewnętrznie, niemetryczne, typ ciężki

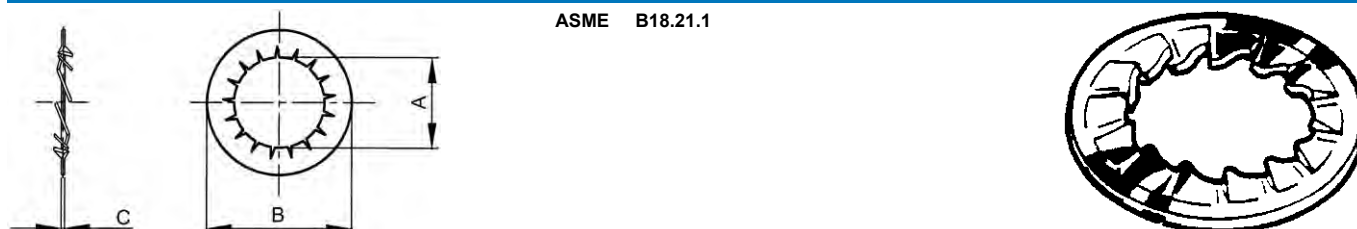

Informacje techniczne

Dla wymiaru nominalnego	A	B	C
1/4	0.256	0.500	0.035
5/16	0.320	0.590	0.040
3/8	0.384	0.700	0.042
1/2	0.512	0.880	0.055
5/8	0.640	1.100	0.059
3/4	0.768	1.240	0.070

Grupy katalogowe

Materiał	Obróbka powierzchni	Kod	Strona
Stal sprężynowa HV		U37320	7-76
Stal sprężynowa HV	Ocynk.	U37321	7-76

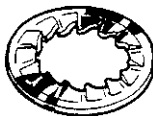
U37320	Podkładki ząbkowane wewnętrznie, niemetryczne, typ ciężki	X09A
Materiał	Stal sprężynowa HV	
		 

Dla wymiaru nominalnego	☒	Kod artykułu	Dla wymiaru nominalnego	☒	Kod artykułu	Dla wymiaru nominalnego	☒	Kod artykułu
1/4*	100	U37320.025.0001	3/8*	50	U37320.037.0001	5/8*	10	U37320.062.0001
5/16*	100	U37320.031.0001	1/2*	25	U37320.050.0001	3/4*	10	U37320.075.0001

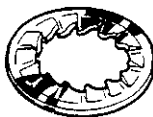
U37321	Podkładki ząbkowane wewnętrznie, niemetryczne, typ ciężki	X09A
Materiał	Stal sprężynowa HV	
Obróbka powierzchni	Ocynkowane	
		 

Dla wymiaru nominalnego	☒	Kod artykułu	Dla wymiaru nominalnego	☒	Kod artykułu	Dla wymiaru nominalnego	☒	Kod artykułu
1/4*	100	U37321.025.0001	3/8*	50	U37321.037.0001	5/8*	10	U37321.062.0001
5/16*	100	U37321.031.0001	1/2*	25	U37321.050.0001	3/4*	10	U37321.075.0001

Podkładki wachlarzowe ząbkowane zewnętrznie

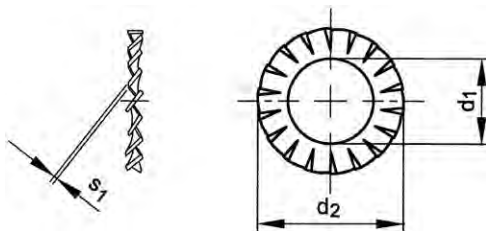

DIN 6798 A
NEN 2453
NF E27-624



Informacje techniczne

Dla wymiaru nominalnego	d ₁	d ₂	s ₁	Dla wymiaru nominalnego	d ₁	d ₂	s ₁
M2	2.2	4.5	0.3	M10	10.5	18	0.9
M2.5	2.7	5.5	0.4	M11 (≠DIN)	11.5	19.5	0.9
M2.6 (≠DIN)	2.8	5.5	0.4	M12	13	20.5	1
M3	3.2	6	0.4	M14	15	24	1
M3.5	3.7	7	0.5	M16	17	26	1.2
M4	4.3	8	0.5	M18	19	30	1.4
M5 (≠DIN)	5.1	9	0.5	M20	21	33	1.4
M5	5.3	10	0.6	M22	23	36	1.5
M6	6.4	11	0.7	M24	25	38	1.5
M7	7.4	12.5	0.8	M27	28	44	1.6
M8 (≠DIN)	8.2	14	0.8	M30	31	48	1.6
M8	8.4	15	0.8				

- Głównym celem podkładek wachlarzowych ząbkowanych jest umożliwienie przepływu prądu elektrycznego między elementami pokrytymi lakierem, środkami antykorozyjnymi lub podobnymi materiałami, wygięte końce podkładek przebijają powłokę podczas łączenia takich elementów. Tam, gdzie podkładki takie mają zapobiec luzowaniu się części złącznych o niskiej klasie wytrzymałości, ich efektywność powinna być sprawdzona dla danego zastosowania.
- Odpowiednie dla śrub i nakrętek o normalnej szerokości płaskich powierzchni.

Grupy katalogowe

Materiał	Obróbka powierzchni	Kod	Strona
Stal sprężynowa 350-425 HV10		37400	7-77
Stal sprężynowa 350-425 HV10	Ocynk.	37420	7-77
Stal sprężynowa 350-425 HV10	Ocynk. Duże Opakowanie	37430	7-78
Stal sprężynowa 350-425 HV10	Ocynk. żłt. pas.	37440	7-78
St.St. A2		51460	7-78
St.St. A4		55460	7-78
St.St. A5		53460	7-79
Brąz fosforowy Cu4		50540	7-79

7

37400 Podkładki wachlarzowe ząbkowane zewnętrznie		L07D
Materiał	Stal sprężynowa 350-425 HV10	
		
		

Dla wymiaru nominalnego	Kod artykułu	Dla wymiaru nominalnego	Kod artykułu	Dla wymiaru nominalnego	Kod artykułu
M2	1000 37400.020.001	M7	1000 37400.070.001	M18	100 37400.180.001
M3	1000 37400.030.001	M8 (≠DIN)	1000 37400.080.001	M20	100 37400.200.001
M3,5	1000 37400.035.001	M8	1000 37400.080.002	M22	100 37400.220.001
M4	1000 37400.040.001	M10	1000 37400.100.001	M24	100 37400.240.001
M5 (≠DIN)	1000 37400.050.001	M12	1000 37400.120.001	M27	100 37400.270.001
M5	1000 37400.050.002	M14	500 37400.140.001	M30	100 37400.300.001
M6	1000 37400.060.001	M16	500 37400.160.001		

- Ostrzeżenie: cynkowanie elektrolityczne tych produktów może wywołać kruchość wodorową.



37420 Podkładki wachlarzowe ząbkowane zewnętrznie		L07D
Materiał	Stal sprężynowa 350-425 HV10	
Obróbka powierzchni	Ocynkowane	
		
		

Dla wymiaru nominalnego	Kod artykułu	Dla wymiaru nominalnego	Kod artykułu	Dla wymiaru nominalnego	Kod artykułu
M2	200 37420.020.001	M3	200 37420.030.001	M4	200 37420.040.001
M2,5	200 37420.025.001	M3,5	200 37420.035.001	M5 (≠DIN)	200 37420.050.001

37420 Podkładki wachlarzowe ząbkowane zewnętrznie								
Dla wymiaru nominalnego	☒	Kod artykułu	Dla wymiaru nominalnego	☒	Kod artykułu	Dla wymiaru nominalnego	☒	Kod artykułu
M5	200	37420.050.002	M11	100	37420.110.001	M22	100	37420.220.001
M6	200	37420.060.001	M12	100	37420.120.001	M24	100	37420.240.001
M7	200	37420.070.001	M14	100	37420.140.001	M27	100	37420.270.001
M8 (#DIN)	200	37420.080.001	M16	100	37420.160.001	M30	50	37420.300.001
M8	200	37420.080.002	M18	100	37420.180.001			
M10	100	37420.100.001	M20	100	37420.200.001			

37430 Podkładki wachlarzowe ząbkowane zewnętrznie								L07D
Materiał		Stal sprężynowa 350-425 HV10						
Obróbka powierzchni		Ocynkowane						
								
Dla wymiaru nominalnego	☒	Kod artykułu	Dla wymiaru nominalnego	☒	Kod artykułu	Dla wymiaru nominalnego	☒	Kod artykułu
M2,5	10000	37430.025.001	M5 (#DIN)	10000	37430.050.001	M10	2000	37430.100.001
M3	10000	37430.030.001	M6	5000	37430.060.001	M12	2000	37430.120.001
M4	10000	37430.040.001	M8 (#DIN)	5000	37430.080.001			



37440 Podkładki wachlarzowe ząbkowane zewnętrznie								L07D
Materiał		Stal sprężynowa 350-425 HV10						
Obróbka powierzchni		Ocynkowane, po żółtej pasywacji						
Dla wymiaru nominalnego	☒	Kod artykułu	Dla wymiaru nominalnego	☒	Kod artykułu	Dla wymiaru nominalnego	☒	Kod artykułu
M3	200	37440.030.001	M8 (#DIN)	200	37440.080.001	M20	100	37440.200.001
M4	200	37440.040.001	M10	100	37440.100.001	M24	100	37440.240.001
M5 (#DIN)	200	37440.050.001	M12	100	37440.120.001			
M6	200	37440.060.001	M16	100	37440.160.001			

51460 Podkładki wachlarzowe ząbkowane zewnętrznie								R09A
Materiał		Stal nierdzewna A2		DIN	≈6798 A			
				NEN	≈2453			
				NF	≈E27-624			
								
Dla wymiaru nominalnego	☒	Kod artykułu	Dla wymiaru nominalnego	☒	Kod artykułu	Dla wymiaru nominalnego	☒	Kod artykułu
M2	200	51460.020.001	M6	200	51460.060.001	M16	100	51460.160.001
M2,5	200	51460.025.001	M7	200	51460.070.001	M18	100	51460.180.001
M2,6 (#DIN)	200	51460.026.001	M8	200	51460.080.001	M20	100	51460.200.001
M3	200	51460.030.001	M8 (#DIN)*	1000	51460.082.001	M22	50	51460.220.001
M3,5	200	51460.035.001	M10	100	51460.100.001	M24	50	51460.240.001
M4	200	51460.040.001	M12	100	51460.120.001	M27	50	51460.270.001
M5	200	51460.050.001	M14	100	51460.140.001	M30	25	51460.300.001
M5 (#DIN)*	1000	51460.051.001						



* Typ stali austenicznej jest pozostawiony do decyzji producenta, i może różnić się od typów stali podanych w DIN 267-11.

55460 Podkładki wachlarzowe ząbkowane zewnętrznie								R49A
Materiał		Stal nierdzewna A4		DIN	≈6798 A			
				NEN	≈2453			
				NF	≈E27-624			
								
Dla wymiaru nominalnego	☒	Kod artykułu	Dla wymiaru nominalnego	☒	Kod artykułu	Dla wymiaru nominalnego	☒	Kod artykułu
M2	200	55460.020.001	M5,1*	1000	55460.051.001	M16	100	55460.160.001
M2,5	200	55460.025.001	M6	200	55460.060.001	M18	100	55460.180.001
M2,6 (#DIN)	200	55460.026.001	M8	200	55460.080.001	M20	100	55460.200.001
M3	200	55460.030.001	M8 (#DIN)*	1000	55460.080.002	M22	50	55460.220.001
M3,5	200	55460.035.001	M8,2*	1000	55460.082.001	M24	50	55460.240.001
M4	200	55460.040.001	M10	100	55460.100.001	M27	50	55460.270.001
M5	200	55460.050.001	M12	100	55460.120.001	M30	25	55460.300.001
M5 (#DIN)*	1000	55460.050.002	M14	100	55460.140.001			

* Typ stali austenicznej jest pozostawiony do decyzji producenta, i może różnić się od typów stali podanych w DIN 267-11.

53460	Podkładki wachlarzowe ząbkowane zewnętrznie	R45A
Materiał	Stal nierdzewna A5	DIN ≈6798 A NEN ≈2453 NF ≈E27-624
		
		

Dla wymiaru nominalnego	Kod artykułu	Dla wymiaru nominalnego	Kod artykułu
M6*	1000 53460.060.001	M8*	1000 53460.080.001

50540	Podkładki wachlarzowe ząbkowane zewnętrznie	M11F
Materiał	Brąz fosforowy Cu4	DIN ≈6798 A NEN ≈2453 NF ≈E27-624
		
		

Dla wymiaru nominalnego	Kod artykułu	Dla wymiaru nominalnego	Kod artykułu	Dla wymiaru nominalnego	Kod artykułu
M2	200 50540.020.001	M4	200 50540.040.001	M10	100 50540.100.001
M2,5	200 50540.025.001	M5	200 50540.050.001	M12	100 50540.120.001
M3	200 50540.030.001	M6	200 50540.060.001		
M3,5	200 50540.035.001	M8	200 50540.080.001		

• Odpowiednie dla śrub i nakrętek z normalną szerokością płaskich powierzchni.

Podkładki sprężyste ząbkowane wewnętrznie

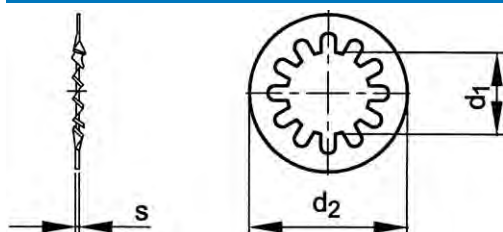

DIN 6797 J
NEN 2451





Informacje techniczne

Dla wymiaru nominalnego	d ₁	d ₂	s	Dla wymiaru nominalnego	d ₁	d ₂	s
M2	2.2	4.5	0.3	M10	10.5	18	0.9
M2.3 (#DIN)	2.5	5	0.4	M12	13	20.5	1
M2.5	2.7	5.5	0.4	M14	15	24	1
M2.7	2.7	5.5	0.4	M16	17	26	1.2
M3	3.2	6	0.4	M18	19	30	1.4
M4	4.3	8	0.5	M20	21	33	1.4
M5	5.3	10	0.6	M22	23	36	1.5
M6	6.4	11	0.7	M24	25	38	1.5
M7	7.4	12.5	0.8	M27	28	44	1.6
M8	8.4	15	0.8	M30	31	48	1.6

- Głównym celem podkładek sprężystych ząbkowanych jest umożliwienie przepływu prądu elektrycznego między elementami pokrytymi lakierem, środkami antykorozyjnymi lub podobnymi materiałami, wygięte końce podkładek przebijają powłokę podczas łączenia takich elementów. Tam, gdzie podkładki takie mają zapobiec luzowaniu się części złącznych o niskiej klasie wytrzymałości, ich efektywność powinna być sprawdzona dla danego zastosowania.
- Odpowiednie dla śrub i nakrętek z szerokością płaskich powierzchni niższą niż normalnie, oraz kiedy z uwagi na wygląd chce się aby zęby były od strony wewnętrznej.



Grupy katalogowe

Materiał	Kod	Strona
Stal sprężynowa 350-425 HV10	37320	7-80
St.St. A2	51458	7-80

37320	Podkładki sprężyste ząbkowane wewnętrznie	L07D
Materiał	Stal sprężynowa 350-425 HV10	 

Dla wymiaru nominalnego	☒	Kod artykułu	Dla wymiaru nominalnego	☒	Kod artykułu	Dla wymiaru nominalnego	☒	Kod artykułu
M3	500	37320.030.001	M6	250	37320.060.001	M12	200	37320.120.001
M4	500	37320.040.001	M8	200	37320.080.001	M16	100	37320.160.001
M5	250	37320.050.001	M10	200	37320.100.001	M20	100	37320.200.001

• Ostrzeżenie: cynkowanie elektrolityczne tych produktów może wywołać kruchość wodorową.

51458	Podkładki sprężyste ząbkowane wewnętrznie	R09A
Materiał	Stal nierdzewna A2	DIN ≈6797 J
		NEN ≈2451
		 

Dla wymiaru nominalnego	☒	Kod artykułu	Dla wymiaru nominalnego	☒	Kod artykułu	Dla wymiaru nominalnego	☒	Kod artykułu
M2*	1000	51458.020.001	M7*	1000	51458.070.001	M18*	200	51458.180.001
M2,3*	1000	51458.023.001	M8	200	51458.080.001	M20	100	51458.200.001
M3	200	51458.030.001	M8,2*	1000	51458.082.001	M22*	200	51458.220.001
M4	200	51458.040.001	M10	200	51458.100.001	M24*	200	51458.240.001
M5	200	51458.050.001	M12	100	51458.120.001	M27*	100	51458.270.001
M5,1*	1000	51458.051.001	M14	100	51458.140.001	M30*	100	51458.300.001
M6	200	51458.060.001	M16	100	51458.160.001			

• Typ stali austenicznej pozostaje w gestii producenta i może różnić się od typów stali podanych w DIN 267-11.

Podkładki sprężyste ząbkowane zewnętrznie

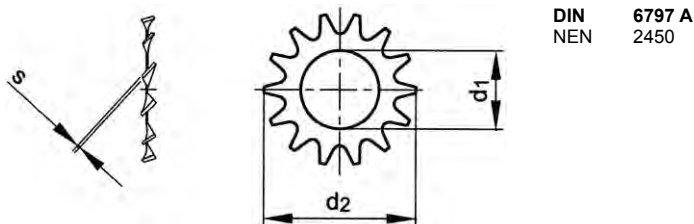

DIN 6797 A
NEN 2450

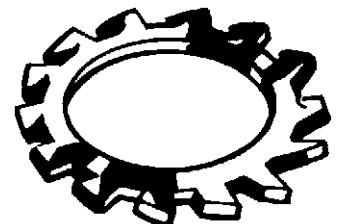

Informacje techniczne

Dla wymiaru nominalnego	d ₁	d ₂	s	Dla wymiaru nominalnego	d ₁	d ₂	s
M2	2.2	4.5	0.3	M10	10.5	18	0.9
M2.3 (#DIN)	2.5	5	0.4	M12	13	20.5	1
M2.5	2.7	5.5	0.4	M14	15	24	1
M3	3.2	6	0.4	M16	17	26	1.2
M3.5	3.7	7	0.5	M18	19	30	1.4
M4	4.3	8	0.5	M20	21	33	1.4
M5	5.3	10	0.6	M22	23	36	1.5
M6	6.4	11	0.7	M24	25	38	1.5
M7	7.4	12.5	0.8	M27	28	44	1.6
M8	8.4	15	0.8	M30	31	48	1.6

- Głównym celem podkładek sprężystych ząbkowanych jest umożliwienie przepływu prądu elektrycznego między elementami pokrytymi lakierem, środkami antykorozyjnymi lub podobnymi materiałami, wygięte końce podkładek przebijają powłokę podczas łączenia takich elementów. Tam, gdzie podkładki takie mają zapobiec luzowaniu się części złącznych o niskiej klasie wytrzymałości, ich efektywność powinna być sprawdzona dla danego zastosowania.
- Odpowiednie dla śrub i nakrętek o normalnej szerokości płaskich powierzchni.

Grupy katalogowe

Materiał	Obróbka powierzchni	Kod	Strona
Stal sprężynowa 350-425 HV10		37300	7-81
Stal sprężynowa 350-425 HV10	Ocynk.	37302	7-81
St.St. A2		51456	7-81



37300 Podkładki sprężyste ząbkowane zewnętrznie		L07D	
Materiał	Stal sprężynowa 350-425 HV10		
			
			

Dla wymiaru nominalnego	✉	Kod artykułu	Dla wymiaru nominalnego	✉	Kod artykułu	Dla wymiaru nominalnego	✉	Kod artykułu
M3	500	37300.030.001	M8	200	37300.080.001	M16	100	37300.160.001
M4	500	37300.040.001	M10	200	37300.100.001	M20	100	37300.200.001
M5	250	37300.050.001	M12	200	37300.120.001	M24	50	37300.240.001
M6	250	37300.060.001	M14	100	37300.140.001			

- Ostrzeżenie: cynkowanie elektrolityczne tych produktów może wywołać kruchość wodorową.

37302 Podkładki sprężyste ząbkowane zewnętrznie		L07D	
Materiał	Stal sprężynowa 350-425 HV10		
Obróbka powierzchni	Ocynkowane		
			
			

Dla wymiaru nominalnego	✉	Kod artykułu	Dla wymiaru nominalnego	✉	Kod artykułu	Dla wymiaru nominalnego	✉	Kod artykułu
M3	500	37302.030.001	M8	200	37302.080.001	M16	200	37302.160.001
M4	500	37302.040.001	M10	200	37302.100.001	M20	100	37302.200.001
M5	250	37302.050.001	M12	200	37302.120.001	M24	50	37302.240.001
M6	250	37302.060.001	M14	100	37302.140.001			

51456 Podkładki sprężyste ząbkowane zewnętrznie		R09A	
Materiał	Stal nierdzewna A2		DIN ≈6797A NEN ≈2450
			
			

Dla wymiaru nominalnego	✉	Kod artykułu	Dla wymiaru nominalnego	✉	Kod artykułu	Dla wymiaru nominalnego	✉	Kod artykułu
M2*	1000	51456.020.001	M7*	1000	51456.070.001	M18*	200	51456.180.001
M2,3*	1000	51456.023.001	M8	200	51456.080.001	M20	100	51456.200.001
M3	200	51456.030.001	M10	200	51456.100.001	M22*	200	51456.220.001
M4	200	51456.040.001	M12	100	51456.120.001	M24*	200	51456.240.001
M5	200	51456.050.001	M14*	500	51456.140.001	M27*	100	51456.270.001
M6	200	51456.060.001	M16	100	51456.160.001	M30*	100	51456.300.001

- Typ stali austenicznej pozostaje w gestii producenta i może różnić się od typów stali podanych w DIN 267-11.

Podkładki kontaktowe do urządzeń rozdzielczych

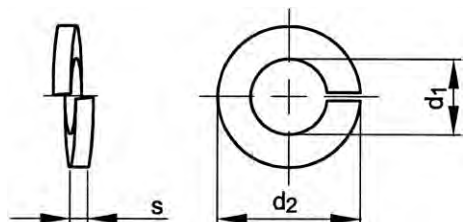

DIN 43699

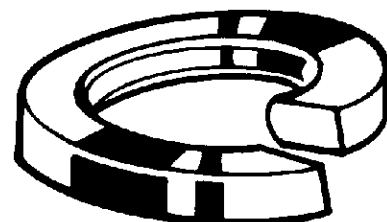

Informacje techniczne

Dla wymiaru nominalnego	d_1	d_2	s	Dla wymiaru nominalnego	d_1	d_2	s
M6 (#DIN)	6.1	12.1	2	M12	12.2	22.2	3.5
M8	8.2	15.2	2.2	M16	16.2	28.2	4
M10	10.2	18.2	2.5	M20	20.2	34.2	5

- W zależności od dostępności artykuły te mogą być dostarczone jako cynkowane, jak również powlekane mechanicznie.

37260 Podkładki kontaktowe do urządzeń rozdzielczych

L07D

Materiał Stal sprężynowa
Obróbka powierzchni Ocynkowane



Dla wymiaru nominalnego	☒	Kod artykułu	Dla wymiaru nominalnego	☒	Kod artykułu	Dla wymiaru nominalnego	☒	Kod artykułu
M6	250	37260.060.001	M10	200	37260.100.001	M16	100	37260.160.001
M8	200	37260.080.001	M12	150	37260.120.001	M20	100	37260.200.001

Sprężyny talerzowe do zastosowań krytycznych, typ A (powiększone)

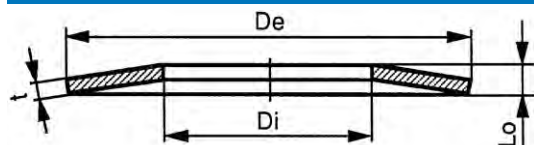

DIN 2093 A



Informacje techniczne

D_e (h12)	D_i (H12)	F	L_o	t	D_e (h12)	D_i (H12)	F	L_o	t
8	4.2	210	0.6	0.4	35.5	18.3	5190	2.8	2
10	5.2	329	0.75	0.5	40	20.4	6450	3.15	2.25
12.5	6.2	673	1	0.7	45	22.4	7720	3.5	2.5
14	7.2	813	1.1	0.8	50	25.4	12000	4.1	3
16	8.2	1000	1.25	0.9	56	28.5	11400	4.3	3
18	9.2	1250	1.4	1	63	31	15000	4.9	3.5
20	10.2	1530	1.55	1.1	71	36	20500	5.6	4
22.5	11.2	1950	1.75	1.25	80	41	33700	6.7	5
25	12.2	2910	2.05	1.5	90	46	31400	7	5
28	14.2	2850	2.15	1.5	100	51	48000	8.2	6
31.5	16.3	3900	2.45	1.75	112	57	43800	8.5	6

- Sprężyny talerzowe zgodn. z DIN 2093 są stosowane głównie tam, gdzie bezpieczeństwo jest najważniejsze. Podobne zastosowania można znaleźć, na przykład, w sprzęgłach bezpieczeństwa ograniczających moment obrotowy, w usztywniaczach przegubów oraz w zastosowaniach z ciągłym naciskiem tocznym. Dzięki odpowiedniemu łączeniu, np. nakładaniu na siebie podkładek sprężystych talerzowych można dokładnie ustalić elastyczność i/lub odchylenie. Specyfikacje techniczne podkładek sprężystych talerzowych w kwestii obciążenia statycznego i dynamicznego spełniają najwyższe oczekiwania. Przekraczają wymagania stawiane przez DIN 2093.
- Grupa materiałów 1: $t < 1,25$ ze stali Ck 75.
- Grupa materiałów 2: $1,25 \leq t \leq 6,0$ ze stali 50 Cr V4 (pęknięciem zmęczeniowym można tu w zasadzie zapobiec, ponieważ że podkładki mają krawędzie obrabiane maszynowo).
- F = Siła sprężyny w Newtonach przy odchyleniu $s \approx 0,75 h_0$ ($h_0 = L_0 - t$).
- Do obliczania parametrów podkładek sprężystych talerzowych, patrz DIN 2092.
- Na żądanie dostępne są szczegółowe dane techniczne.

36300	Sprężyny talerzowe do zastosowań krytycznych, typ A (powiększone)	L07C
Materiał	Stal Ck 75 Werkstoffnr. 1.1248	
Obróbka powierzchni	Fosfatowane	

$D_e \times D_i \times t$	☒	Kod artykułu	$D_e \times D_i \times t$	☒	Kod artykułu	$D_e \times D_i \times t$	☒	Kod artykułu
8X4,2X0,4MM	100	36300.084.004	25X12,2X1,5MM	50	36300.262.015	56X28,5X3MM	10	36300.588.030
10X5,2X0,5MM	100	36300.105.005	28X14,2X1,5MM	50	36300.294.015	63X31X3,5MM	5	36300.661.035
12,5X6,2X0,7MM	100	36300.131.007	31,5X16,3X1,75MM	50	36300.331.017	71X36X4MM	5	36300.746.040
14X7,2X0,8MM	100	36300.147.008	35,5X18,3X2MM	25	36300.373.020	80X41X5MM	1	36300.841.050
16X8,2X0,9MM	100	36300.168.009	40X20,4X2,25MM	25	36300.420.022	90X46X5MM	1	36300.946.050
18X9,2X1MM	100	36300.189.010	45X22,4X2,5MM	10	36300.472.025	100X51X6MM	1	36300.960.060
20X10,2X1,1MM	50	36300.210.011	50X25,4X3MM	10	36300.525.030	112X57X6MM	1	36300.968.060
22,5X11,2X1,25MM	50	36300.236.012						

Sprężyny talerzowe do zastosowań krytycznych

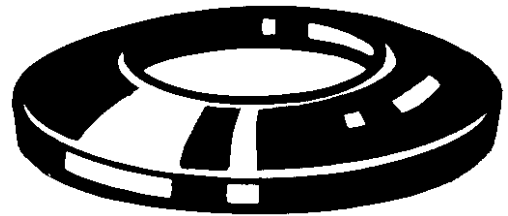
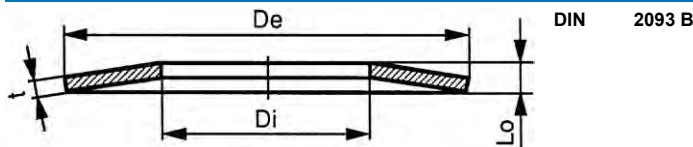

Informacje techniczne

D_e (h12)	D_i (H12)	F	L_o	t	D_e (h12)	D_i (H12)	F	L_o	t
8	4.2	119	0.55	0.3	35.5	18.3	1700	2.25	1.25
10	5.2	213	0.7	0.4	40	20.4	2620	2.65	1.5
12.5	6.2	291	0.85	0.5	45	22.4	3660	3.05	1.75
14	7.2	279	0.9	0.5	50	25.4	4760	3.4	2
16	8.2	412	1.05	0.6	56	28.5	4440	3.6	2
18	9.2	572	1.2	0.7	63	31	7180	4.25	2.5
20	10.2	745	1.35	0.8	71	36	6730	4.5	2.5
22.5	11.2	710	1.45	0.8	80	41	10500	5.3	3
25	12.2	868	1.6	0.9	90	46	14200	6	3.5
28	14.2	1110	1.8	1	100	51	13100	6.3	3.5
31.5	16.3	1920	2.15	1.25	112	57	17800	7.2	4

- Sprężyny talerzowe zgodn. z DIN 2093 są stosowane głównie tam, gdzie bezpieczeństwo jest najważniejsze. Podobne zastosowania można znaleźć, na przykład, w sprzęgłach bezpieczeństwa ograniczających moment obrotowy, w usztywniaczach przegubów oraz w zastosowaniach z ciągłym naciskiem tocznym. Dzięki odpowiedniemu łączeniu, np. nakładaniu na siebie podkładek sprężystych talerzowych można dokładnie ustalić elastyczność i/lub odchylenie. Specyfikacje techniczne podkładek sprężystych talerzowych w kwestii obciążenia statycznego i dynamicznego spełniają najwyższe oczekiwania. Przekraczają wymagania stawiane przez DIN 2093.
- Grupa materiałów 1: $t < 1,25$ ze stali C75S.
- Grupa materiałów 2: $1,25 \leq t \leq 6,0$ ze stali 51 Cr V4 (pęknięciom zmęczeniowym można tu w zasadzie zapobiec, ponieważ te podkłady mają krawędzie obrabiane maszynowo).
- F = Siła sprężyny w Newtonach przy odchyleniu $s \approx 0,75 h_0$ ($h_0 = L_0 - t$).
- Grubość znamionowa. Do obliczania parametrów podkładek sprężystych talerzowych, patrz DIN 2092.

Przykład zastosowania

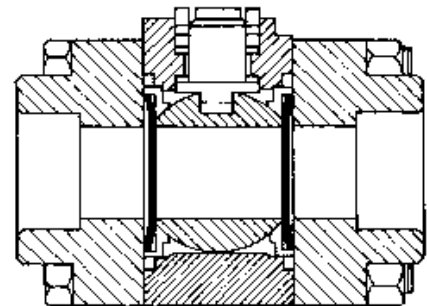

Zawór kulowy

36302 Sprężyny talerzowe do zastosowań krytycznych
L07C
Materiał Stal sprężynowa
Obróbka powierzchni Fosfatowane

$D_e \times D_i \times t$	☒	Kod artykułu	$D_e \times D_i \times t$	☒	Kod artykułu	$D_e \times D_i \times t$	☒	Kod artykułu
8X4,2X0,3MM	100	36302.084.003	25X12,2X0,9MM	50	36302.262.009	56X28,5X2MM	10	36302.588.020
10X5,2X0,4MM	100	36302.105.004	28X14,2X1MM	50	36302.294.010	63X31X2,5MM	5	36302.661.025
12,5X6,2X0,5MM	100	36302.131.005	31,5X16,3X1,25MM	50	36302.331.012	71X36X2,5MM	5	36302.746.025
14X7,2X0,5MM	100	36302.147.005	35,5X18,3X1,25MM	25	36302.373.012	80X41X3MM	1	36302.841.030
16X8,2X0,6MM	100	36302.168.006	40X20,4X1,5MM	25	36302.420.015	90X46X3,5MM	1	36302.946.035
18X9,2X0,7MM	100	36302.189.007	45X22,4X1,75MM	10	36302.472.017	100X51X3,5MM	1	36302.960.035
20X10,2X0,8MM	50	36302.210.008	50X25,4X2MM	10	36302.525.020	112X57X4MM	1	36302.968.040
22,5X11,2X0,8MM	50	36302.236.008						

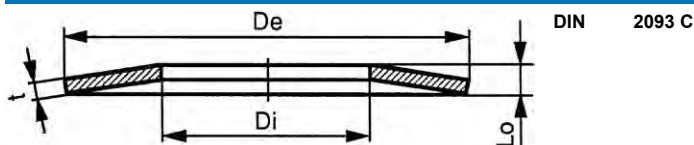
Sprężyny talerzowe do zastosowań krytycznych

DIN 2093 C

Informacje techniczne



D_e (h12)	D_i (H12)	F	L_o	t	D_e (h12)	D_i (H12)	F	L_o	t
8	4.2	39	0.45	0.2	40	20.4	1020	2.3	1
10	5.2	58	0.55	0.25	45	22.4	1890	2.85	1.25
12.5	6.2	152	0.8	0.35	50	25.4	1550	2.85	1.25
14	7.2	123	0.8	0.35	56	28.5	2620	3.45	1.5
16	8.2	155	0.9	0.4	63	31	4240	4.15	1.8
18	9.2	214	1.05	0.45	71	36	5140	4.6	2
20	10.2	254	1.15	0.5	80	41	6610	5.2	2.25
22.5	11.2	425	1.4	0.6	90	46	7680	5.7	2.5
25	12.2	601	1.6	0.7	100	51	8610	6.2	2.7
28	14.2	801	1.8	0.8	112	57	10500	6.9	3
31.5	16.3	687	1.85	0.8	125	64	15400	8	3.5
35.5	18.3	831	2.05	0.9					

- Sprężyny talerzowe zgodn. z DIN 2093 są stosowane głównie tam, gdzie bezpieczeństwo jest najważniejsze. Podobne zastosowania można znaleźć, na przykład, w sprzęgłach bezpieczeństwa ograniczających moment obrotowy, w usztywniaczach przegubów oraz w zastosowaniach z ciągłym naciskiem tocącym. Dzięki odpowiedniemu łączeniu, np. nakładaniu na siebie podkładek sprężystych talerzowych można dokładnie ustalić elastyczność i/lub odchylenie. Specyfikacje techniczne podkładek sprężystych talerzowych w kwestii obciążenia statycznego i dynamicznego spełniają najwyższe oczekiwania. Przekraczają wymagania stawiane przez DIN 2093.
- Grupa materiałów 1: $t < 1,25$ ze stali C75S.
- Grupa materiałów 2: $1,25 \leq t \leq 6,0$ ze stali 51 Cr V4 (pęknięciom zmęczeniowym można tu w zasadzie zapobiec, ponieważ te podkładki mają krawędzie obrabiane maszynowo).
- F = Siła sprężyny w Newtonach przy odchyleniu $s \approx 0,75 h_0$ ($h_0 = L_0 - t$).
- Do obliczania parametrów podkładek sprężystych talerzowych, patrz DIN 2092.

Przykład zastosowania



36303 Sprężyny talerzowe do zastosowań krytycznych, typ C (mniejsze) L07C

Materiał Stal sprężynowa
Obróbka powierzchni Fosfatowane

$D_e \times D_i \times t$	☒	Kod artykułu	$D_e \times D_i \times t$	☒	Kod artykułu	$D_e \times D_i \times t$	☒	Kod artykułu
8X4,2X0,2MM	100	36303.084.002	25X12,2X0,7MM	50	36303.262.007	63X31X1,8MM	5	36303.661.018
10X5,2X0,25MM	100	36303.105.002	28X14,2X0,8MM	50	36303.294.008	71X36X2MM	5	36303.746.020
12,5X6,2X0,35MM	100	36303.131.003	31,5X16,3X0,8MM	50	36303.331.008	80X41X2,25MM	1	36303.841.022
14X7,2X0,35MM	100	36303.147.003	35,5X18,3X0,9MM	25	36303.373.009	90X46X2,5MM	1	36303.946.025
16X8,2X0,4MM	100	36303.168.004	40X20,4X1MM	25	36303.420.010	100X51X2,7MM	1	36303.960.027
18X9,2X0,45MM	100	36303.189.004	45X22,4X1,25MM	10	36303.472.012	112X57X3MM	1	36303.968.030
20X10,2X0,5MM	50	36303.210.005	50X25,4X1,25MM	10	36303.525.012	125X64X3,5MM	1	36303.970.035
22,5X11,2X0,6MM	50	36303.236.006	56X28,5X1,5MM	10	36303.588.015			

Sprężyny talerzowe do zastosowań krytycznych

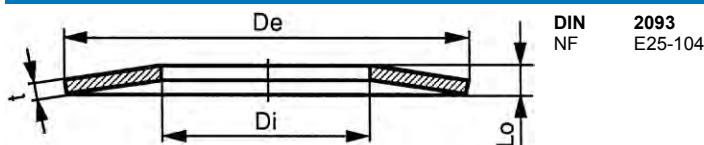

Informacje techniczne

D_e (h12)	D_i (H12)	F	L_o	t	Typ	D_e (h12)	D_i (H12)	F	L_o	t	Typ
6	3.2	119	0.45	0.3	-	18	6.2	139	1	0.4	-
8	3.2	26	0.4	0.2	-	18	6.2	245	1.1	0.5	-
8	3.2	104	0.55	0.3	-	18	6.2	400	1.2	0.6	-
8	3.2	185	0.6	0.4	-	18	6.2	552	1.25	0.7	-
8	3.2	357	0.7	0.5	-	18	6.2	725	1.3	0.8	-
8	4.2	39	0.45	0.2	C	18	8.2	265	1.1	0.5	-
8	4.2	118	0.55	0.3	B	18	8.2	596	1.25	0.7	-
8	4.2	209	0.6	0.4	A	18	8.2	782	1.3	0.8	-
10	3.2	98	0.65	0.3	-	18	8.2	1501	1.5	1	-
10	3.2	179	0.7	0.4	-	18	9.2	214	1.05	0.45	C
10	3.2	278	0.75	0.5	-	18	9.2	566	1.2	0.7	B
10	4.2	189	0.7	0.4	-	18	9.2	1253	1.4	1	A
10	4.2	294	0.75	0.5	-	20	8.2	412	1.3	0.6	-
10	5.2	58	0.55	0.25	C	20	8.2	568	1.35	0.7	-
10	5.2	209	0.7	0.4	B	20	8.2	751	1.4	0.8	-
10	5.2	325	0.75	0.5	A	20	8.2	953	1.45	0.9	-
12	4.2	178	0.8	0.4	-	20	8.2	1294	1.55	1	-
12	4.2	284	0.85	0.5	-	20	10.2	254	1.15	0.5	C
12	5.2	349	0.9	0.5	-	20	10.2	748	1.35	0.8	B
12	5.2	506	0.95	0.6	-	20	10.2	1049	1.45	0.9	-
12	6.2	326	0.85	0.5	-	20	10.2	1424	1.55	1	-
12	6.2	551	0.95	0.6	-	20	10.2	1520	1.55	1.1	A
12.5	5.2	272	0.85	0.5	-	20	10.2	2475	1.75	1.25	-
12.5	6.2	151	0.8	0.35	C	20	10.2	4255	2	1.5	-
12.5	6.2	293	0.85	0.5	B	22.5	11.2	425	1.4	0.6	C
12.5	6.2	659	1	0.7	A	22.5	11.2	707	1.45	0.8	B
14	7.2	123	0.8	0.35	C	22.5	11.2	1928	1.75	1.25	A
14	7.2	279	0.9	0.5	B	23	8.2	543	1.5	0.7	-
14	7.2	796	1.1	0.8	A	23	8.2	718	1.55	0.8	-
15	5.2	278	1	0.5	-	23	8.2	918	1.6	0.9	-
15	5.2	407	1.05	0.6	-	23	8.2	1239	1.7	1	-
15	5.2	555	1.1	0.7	-	23	10.2	1057	1.65	0.9	-
15	6.2	289	1	0.5	-	23	10.2	1315	1.7	1	-
15	6.2	423	1.05	0.6	-	23	12.2	2330	1.85	1.25	-
15	6.2	577	1.1	0.7	-	23	12.2	3295	2	1.5	-
15	8.2	665	1.1	0.7	-	25	12.2	569	1.6	0.7	C
15	8.2	982	1.2	0.8	-	25	12.2	862	1.6	0.9	B
16	8.2	154	0.9	0.4	C	25	12.2	1358	1.8	1	-
16	8.2	410	1.05	0.6	B	25	12.2	2213	1.95	1.25	-
16	8.2	1012	1.25	0.9	A	25	12.2	2924	2.05	1.5	A



Informacje techniczne						Informacje techniczne					
D _e (h12)	D _i (H12)	F	Lo	t	Typ	D _e (h12)	D _i (H12)	F	Lo	t	Typ
28	10.2	661	1.75	0.8	-	50	22.4	8505	3.9	2.5	-
28	10.2	1129	1.9	1	-	50	25.4	1549	2.85	1.25	C
28	10.2	1852	2.05	1.25	-	50	25.4	4760	3.4	2	B
28	10.2	2721	2.2	1.5	-	50	25.4	9058	3.9	2.5	-
28	12.2	1267	1.95	1	-	50	25.4	11970	4.1	3	A
28	12.2	2081	2.1	1.25	-	56	28.5	2621	3.45	1.5	C
28	12.2	3075	2.25	1.5	-	56	28.5	4436	3.6	2	B
28	14.2	801	1.8	0.8	C	56	28.5	11382	4.3	3	A
28	14.2	1107	1.8	1	B	60	20.4	7293	4.3	2.5	-
28	14.2	2238	2.1	1.25	-	60	20.4	11569	4.7	3	-
28	14.2	2839	2.15	1.5	A	60	25.4	8159	4.4	2.5	-
31.5	12.2	1170	2.1	1	-	60	25.4	11762	4.65	3	-
31.5	12.2	1805	2.2	1.25	-	60	30.5	9430	4.5	2.5	-
31.5	12.2	2690	2.35	1.5	-	60	30.5	13219	4.7	3	-
31.5	16.3	687	1.85	0.8	C	60	30.5	18143	5	3.5	-
31.5	16.3	1912	2.15	1.25	B	63	31	4236	4.15	1.8	C
31.5	16.3	3228	2.4	1.5	-	63	31	7185	4.25	2.5	B
31.5	16.3	3859	2.45	1.75	A	63	31	15017	4.9	3.5	A
31.5	16.3	6170	2.75	2	-	70	25.5	4435	4.5	2	-
34	12.2	1172	2.25	1	-	70	30.5	11420	5.1	3	-
34	12.2	1814	2.35	1.25	-	70	35.5	12281	5.1	3	-
34	12.2	2719	2.5	1.5	-	70	35.5	23923	5.8	4	-
34	14.2	1988	2.4	1.25	-	70	40.5	23338	5.6	4	-
34	14.2	2982	2.55	1.5	-	70	40.5	33653	6.2	5	-
34	16.3	3153	2.55	1.5	-	71	36	5141	4.6	2	C
34	16.3	5779	2.85	2	-	71	36	6722	4.5	2.5	B
35.5	18.3	832	2.05	0.9	C	71	36	20524	5.6	4	A
35.5	18.3	1698	2.5	1.25	B	80	31	10346	5.5	3	-
35.5	18.3	5184	2.8	2	A	80	36	11912	5.7	3	-
40	14.2	1779	2.65	1.25	-	80	36	21388	6.2	4	-
40	14.3	2544	2.75	1.5	-	80	41	6609	5.2	2.25	C
40	14.2	4766	3.05	2	-	80	41	10512	5.3	3	B
40	16.3	2748	2.8	1.5	-	80	41	22861	6.2	4	-
40	16.3	5166	3.1	2	-	80	41	33541	6.7	5	A
40	20.4	1016	2.3	1	C	90	46	7680	5.7	2.5	C
40	20.4	2620	2.65	1.5	B	90	46	14153	6	3.5	B
40	20.4	5698	3.1	2	-	90	46	31337	7	5	A
40	20.4	6497	3.15	2.25	A	100	41	20240	7.2	4	-
40	20.4	9384	3.45	2.5	-	100	51	8604	6.2	2.7	C
45	22.4	1890	2.85	1.25	C	100	51	13063	6.3	3.5	B
45	22.4	3644	3.05	1.75	B	100	51	36319	7.8	5	-
45	22.4	7712	3.5	2.5	A	100	51	47995	8.2	6	A
50	18.4	4564	3.5	2	-	112	57	17743	7.2	4	B
50	20.4	4685	3.5	2	-	112	57	43683	8.5	6	A
50	22.4	5219	3.6	2	-						

7

- Wymienione powyżej sprężyny talerzowe zgodn. z \approx DIN 2093 nadają się do zastosowań ogólnych. Dla bardziej krytycznych zastosowań zaleca się wybranie podkładek sprężystych talerzowych z grup artykułów 36300, 36302, 36303 i 36450.
- Grupa 1: $t < 1,25$ ze stali C67S.
- Grupa 2: $1,25 \leq t \leq 6,0$ ze stali 51 Cr V4 (krąwędzie tych podkładek sprężystych talerzowych nie są obrabiane maszynowo).
- F = Siła sprężyny w Newtonach przy odchyleniu $s \approx 0,75 h_0 (h_0 = L_0 - t)$.
- Typ A: wykonanie powiększone ($D_e/t \approx 18$).
- Typ B: wykonanie średnie ($D_e/t \approx 28$).
- Typ C: wykonanie mniejsze ($D_e/t \approx 40$).
- Jeżeli typ nie jest wymieniony, to dany wymiar nie jest unormowany przez DIN.
- Do obliczania parametrów podkładek sprężystych talerzowych, patrz DIN 2092.

36307 Sprężyny talerzowe do zastosowań krytycznych L07C

Materiał Stal sprężynowa
Obróbka powierzchni Fosfatowane

D _e x D _i x t	☒	Kod artykułu	D _e x D _i x t	☒	Kod artykułu	D _e x D _i x t	☒	Kod artykułu
6x3,2x0,3MM	100	36307.063.003	8x4,2x0,4MM	100	36307.084.004	10x5,2x0,5MM	100	36307.105.005
8x3,2x0,2MM	100	36307.083.002	10x3,2x0,4MM	100	36307.103.004	12x4,2x0,4MM	100	36307.124.004
8x3,2x0,3MM	100	36307.083.003	10x3,2x0,5MM	100	36307.103.005	12x4,2x0,5MM	100	36307.124.005
8x3,2x0,4MM	100	36307.083.004	10x4,2x0,4MM	100	36307.104.004	12x5,2x0,5MM	100	36307.125.005
8x3,2x0,5MM	100	36307.083.005	10x4,2x0,5MM	100	36307.104.005	12x5,2x0,6MM	100	36307.125.006
8x4,2x0,2MM	100	36307.084.002	10x5,2x0,25MM	100	36307.105.002	12x6,2x0,5MM	100	36307.126.005
8x4,2x0,3MM	100	36307.084.003	10x5,2x0,4MM	100	36307.105.004	12x6,2x0,6MM	100	36307.126.006

36307 Sprężyny talerzowe do zastosowań krytycznych								
$D_e \times D_i \times t$	☒	Kod artykułu	$D_e \times D_i \times t$	☒	Kod artykułu	$D_e \times D_i \times t$	☒	Kod artykułu
12,5X5,2X0,5	100	36307.130.005	23x10,2x0,9MM	50	36307.240.009	45x22,4x2,5MM	10	36307.472.025
12,5x6,2x0,35MM	100	36307.131.003	23x10,2x1MM	50	36307.240.010	50x18,4x2MM	10	36307.518.020
12,5x6,2x0,5MM	100	36307.131.005	23x12,2x1,25MM	50	36307.242.012	50x20,4x2MM	10	36307.520.020
12,5x6,2x0,7MM	100	36307.131.007	23x12,2x1,5MM	50	36307.242.015	50x22,4x2MM	10	36307.522.020
14X7,2x0,35MM	100	36307.147.003	25x12,2x0,7MM	50	36307.262.007	50x22,4x2,5MM	10	36307.522.025
14x7,2x0,5MM	100	36307.147.005	25x12,2x0,9MM	50	36307.262.009	50x25,4x1,25MM	10	36307.525.012
14x7,2x0,8MM	100	36307.147.008	25x12,2x1,25MM	50	36307.262.012	50x25,4x2MM	10	36307.525.020
15x5,2x0,5MM	100	36307.155.005	25x12,2x1,5MM	50	36307.262.015	50x25,4x2,5MM	10	36307.525.025
15x5,2x0,6MM	100	36307.155.006	28x10,2x0,8MM	50	36307.290.008	50x25,4x3MM	10	36307.525.030
15x5,2x0,7MM	100	36307.155.007	28x10,2x1MM	50	36307.290.010	56x28,5x1,5MM	10	36307.588.015
15x6,2x0,5MM	100	36307.156.005	28x10,2x1,25MM	50	36307.290.012	56x28,5x2MM	10	36307.588.020
15x6,2x0,6MM	100	36307.156.006	28x10,2x1,5MM	50	36307.290.015	56x28,5x3MM	10	36307.588.030
15x6,2x0,7MM	100	36307.156.007	28x12,2x1MM	50	36307.292.010	60X20,5X2,5	5	36307.620.025
15x8,2x0,7MM	100	36307.158.007	28x12,2x1,25MM	50	36307.292.012	60x25,4x2,5MM	5	36307.625.025
15x8,2x0,8MM	100	36307.158.008	28x12,2x1,5MM	50	36307.292.015	60x25,4x3MM	5	36307.625.030
16x8,2x0,4MM	100	36307.168.004	28x14,2x0,8MM	50	36307.294.008	60x30,5x2,5MM	5	36307.630.025
16x8,2x0,6MM	100	36307.168.006	28x14,2x1MM	50	36307.294.010	60x30,5x3MM	5	36307.630.030
16x8,2x0,9MM	100	36307.168.009	28x14,2x1,25MM	50	36307.294.012	60x30,5x3,5MM	5	36307.630.035
18x6,2x0,4MM	100	36307.186.004	28x14,2x1,5MM	50	36307.294.015	63x31x1,8MM	5	36307.661.018
18x6,2x0,5MM	100	36307.186.005	31,5x12,2x1MM	50	36307.327.010	63x31x2,5MM	5	36307.661.025
18x6,2x0,6MM	100	36307.186.006	31,5x12,2x1,25MM	50	36307.327.012	63x31x3,5MM	5	36307.661.035
18x6,2x0,7MM	100	36307.186.007	31,5x12,2x1,5MM	50	36307.327.015	70x25,5x2MM	5	36307.725.020
18x6,2x0,8MM	100	36307.186.008	31,5x16,3x0,8MM	50	36307.331.008	70x30,5x3MM	5	36307.730.030
18x8,2x0,6MM	100	36307.188.005	31,5x16,3x1,25MM	50	36307.331.012	70x35,5x3MM	5	36307.735.030
18x8,2x0,7MM	100	36307.188.007	31,5x16,3x1,5MM	50	36307.331.015	70x35,5x4MM	5	36307.735.040
18x8,2x0,8MM	100	36307.188.008	31,5x16,3x1,75MM	50	36307.331.017	70x40,5x4MM	5	36307.740.040
18x8,2x1MM	100	36307.188.010	31,5x16,3x2MM	50	36307.331.020	70x40,5x5MM	5	36307.740.050
18x9,2x0,45MM	100	36307.189.004	34x12,2x1MM	25	36307.352.010	71x36x2MM	5	36307.746.020
18x9,2x0,7MM	100	36307.189.007	34x12,2x1,25MM	25	36307.352.012	71x36x2,5MM	5	36307.746.025
18x9,2x1MM	100	36307.189.010	34x12,2x1,5MM	25	36307.352.015	71x36x4MM	5	36307.746.040
20x8,2x0,6MM	50	36307.208.006	34X1x,2x1,25MM	25	36307.354.012	80x31x3MM	1	36307.831.030
20x8,2x0,7MM	50	36307.208.007	34x14,2x1,5MM	25	36307.354.015	80x36x3MM	1	36307.836.030
20x8,2x0,8MM	50	36307.208.008	34x16,3x1,5MM	25	36307.356.015	80x36x4MM	1	36307.836.040
20x8,2x0,9MM	50	36307.208.009	34x16,3x2MM	25	36307.356.020	80x41x2,25MM	1	36307.841.022
20x8,2x1MM	50	36307.208.010	35,5x18,3x0,9M	25	36307.373.009	80x41x3MM	1	36307.841.030
20x10,2x0,5MM	50	36307.210.005	35,5x18,3x1,25MM	25	36307.373.012	80x41x4MM	1	36307.841.040
20x10,2x0,8MM	50	36307.210.008	35,5x18,3x2MM	25	36307.373.020	80x41x5MM	1	36307.841.050
20x10,2x0,9MM	50	36307.210.009	40x14,2x1,25MM	25	36307.414.012	90x46x2,5MM	1	36307.946.025
20x10,2x1MM	50	36307.210.010	40x14,3x1,5MM	25	36307.414.015	90x46x3,5MM	1	36307.946.035
20x10,2x1,1MM	50	36307.210.011	40x14,3x2MM	25	36307.414.020	90x46x5MM	1	36307.946.050
20x10,2x1,25MM	50	36307.210.012	40x16,3x1,5MM	25	36307.416.015	100x41x4MM	1	36307.960.004
20x10,2x1,5MM	50	36307.210.015	40x16,3x2MM	25	36307.416.020	100x51x2,7MM	1	36307.960.027
22,5x11,2x0,6MM	50	36307.236.006	40x20,4x1MM	25	36307.420.010	100x51x3,5MM	1	36307.960.035
22,5x11,2x0,8MM	50	36307.236.008	40x20,4x1,5MM	25	36307.420.015	100x51x5MM	1	36307.960.050
22,5x11,2x1,25MM	50	36307.236.012	40x20,4x2MM	25	36307.420.020	100x51x6MM	1	36307.960.060
23x8,2x0,7MM	50	36307.238.007	40x20,4x2,25MM	25	36307.420.022	112x57x4MM	1	36307.968.040
23x8,2x0,8MM	50	36307.238.008	40x20,4x2,5MM	25	36307.420.025	112x57x6MM	1	36307.968.060
23x8,2x0,9MM	50	36307.238.009	45x22,4x1,25MM	10	36307.472.012			
23x8,2x1MM	50	36307.238.010	45x22,4x1,75MM	10	36307.472.017			

Sprężyny talerzowe do krytycznych zastosowań

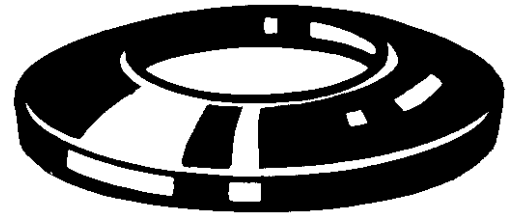
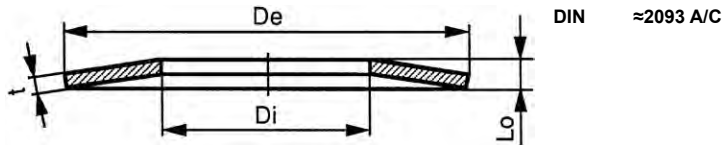

Informacje techniczne

D _e (h12)	D _i (H12)	F	Lo	t	D _e (h12)	D _i (H12)	F	Lo	t
8	4.2	192	0.6	0.4	28	14.2	2004	2.15	1.5
10	5.2	298	0.75	0.5	31.5	16.3	2745	2.3	1.75
12	5.2	350	0.9	0.5	35.5	18.3	4200	2.65	2
12-1	6.2	547	0.95	0.6	40	20.4	932	2.3	1
12.5	6.2	499	0.95	0.7	40	20.4	4630	2.95	2.25
14	7.2	730	1.1	0.8	45	22.4	5719	3.3	2.5
15	8.2	-	1.25	0.8	50	25.4	9212	3.85	3
16	8.2	928	1.25	0.9	56	28.5	9134	4.05	3
18	9.2	1149	1.4	1	71	36	16626	5.6	4
20	10.2	1394	1.55	1.1	80	41	25845	6.7	5
22.5	11.2	1402	1.75	1.25	100	51	37336	8.2	6
25	12.2	1931	1.9	1.5					

- Sprężyny talerzowe zgodn. z DIN 2093 A są stosowane głównie tam, gdzie bezpieczeństwo jest najważniejsze.
- Podobne zastosowania można znaleźć, na przykład, w sprzęgłach bezpieczeństwa ograniczających moment obrotowy, w usztywniaczach przegubów oraz w zastosowaniach z ciągłym naciskiem tocącym. Dzięki odpowiedniemu łączeniu, np. nakładaniu na siebie podkładek sprężystych talerzowych można dokładnie ustalić elastyczność i/lub odchylenie. Specyfikacje techniczne podkładek talerzowych w kwestii obciążenia statycznego i dynamicznego spełniają najwyższe oczekiwania. Obróbka cieplna nadaje tym podkładkom miedziano-brązowy kolor.
- D_e (h12) 8-10-12,5-14-16-18-20-22,5-25-28-31,5-40 X 12 CrNi 17 7 (Nr materiału 1.4310).
- D_i (h12) 35,5-50-56-71 X 35 CrMo 17 (Nr materiału 1.4122). De (h12) 45 X 7 CrNiAl 17 7 (Nr materiału 1.4568).
- D_e (h12) 80-100 X 22 CrMoV 12 1 (Nr materiału 1.4923).
- F = Siła sprężyny w Newtonach przy odchyleniu s = 0,75 h₀ (h₀ = L₀ - t).
- D_e (h12)=40, t=1
- UWAGA: standaryzowane zgodn. z ≈ DIN 2993 C: wykonanie "mniejsze".
- Do obliczania parametrów podkładek sprężystych talerzowych, patrz DIN 2092.

7

Przykłady zastosowania

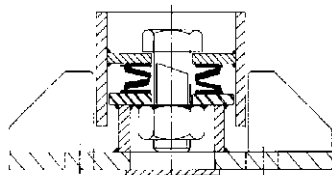

Amortyzacja wstrząsów

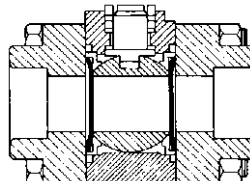

Zawór kulowy

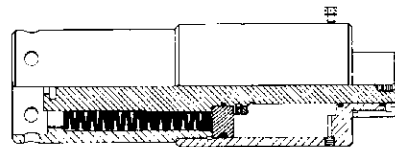

Wyłącznik zasilania

51448 Sprężyny talerzowe do krytycznych zastosowań

R09A

Materiał Stal nierdzewna



D _e x D _i x t	☒	Kod artykułu	D _e x D _i x t	☒	Kod artykułu	D _e x D _i x t	☒	Kod artykułu
8X3,2X0,5MM*	200	51448.083.005	16X8,2X0,6MM*	100	51448.168.006	28X14,2X1,0MM*	50	51448.294.010
8X4,2X0,3MM*	200	51448.084.003	16X8,2X0,9MM	50	51448.168.009	28X14,2X1,5MM	25	51448.294.015
8X4,2X0,4MM	50	51448.084.004	18X6,2X0,4MM*	100	51448.186.004	31,5X16,3X1,25MM*	50	51448.331.012
10X5,2X0,4MM*	200	51448.105.004	18X9,2X0,7MM*	100	51448.189.007	31,5X16,3X1,75MM	25	51448.331.017
10X5,2X0,5MM	50	51448.105.005	18X9,2X1,0MM	50	51448.189.010	35,5X18,3X1,25MM*	50	51448.373.012
12X4,2X0,4MM*	200	51448.124.004	20X8,2X0,5MM*	100	51448.208.005	35,5X18,3X2,0MM	10	51448.373.020
12X4,2X0,5MM*	200	51448.124.005	20X10,2X0,6MM*	100	51448.210.006	40X20,4X1,0MM	10	51448.420.010
12X5,2X0,5MM	50	51448.125.005	20X10,2X0,8MM*	100	51448.210.008	40X20,4X1,5MM*	25	51448.420.015
12X6,2X0,5MM*	200	51448.126.005	20X10,2X0,9MM*	100	51448.210.009	40X20,4X2,0MM*	25	51448.420.020
12,5X6,2X0,5MM*	200	51448.131.005	20X10,2X1,0MM*	100	51448.210.010	40X20,4X2,25MM	10	51448.420.022
12,5X6,2X0,7MM	50	51448.131.007	20X10,2X1,1MM	25	51448.210.011	45X22,4X2,5MM	5	51448.472.025
14X7,2X0,8MM	50	51448.147.008	22,5X11,2X1,25MM	25	51448.236.012	50X25,4X3,0MM	5	51448.520.030
15X8,2X0,8MM*	100	51448.158.008	25X12,2X0,9MM*	50	51448.262.009	56X28,5X3,0MM	5	51448.588.030
16X8,2X0,4MM*	100	51448.168.004	25X12,2X1,5MM	25	51448.262.015	71X36,0X4,0MM	1	51448.746.040

Podkładki podatne stożkowe

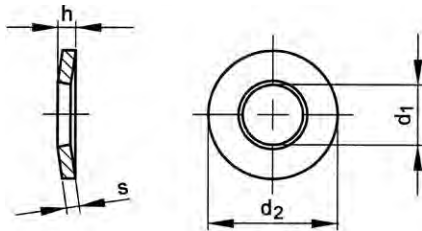

DIN 6796

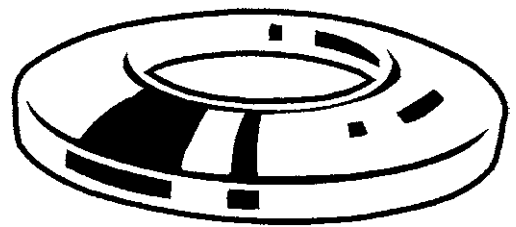

Informacje techniczne



Dla wymiaru nominalnego	d ₁ (H14)	d ₂ (h14)	h (max.)	s
M3	3.2	7	0.85	0.6
M4	4.3	9	1.3	1
M5	5.3	11	1.55	1.2
M6	6.4	14	2	1.5
M8	8.4	18	2.6	2
M10	10.5	23	3.2	2.5
M12	13	29	3.95	3
M14	15	35	4.65	3.5
M16	17	39	5.25	4
M18	19	42	5.8	4.5
M20	21	45	6.4	5
M22	23	49	7.05	5.5
M24	25	56	7.75	6
M30	31	70	9.2	7

- Podkładki podatne stożkowe zgodn. z DIN 6796 należy stosować w połączeniu z częściami złącznymi o klasie wytrzymałości 8.8 i 10.9, stosowanie przy obciążeniach dynamicznych jest niedozwolone.
- Do blokowania przy obciążeniach dynamicznych należy stosować podkładki z krawędzią blokującą i podkładki odporne na wibrację NORD-LOCK.

Grupy katalogowe

Materiał	Obróbka powierzchni	Kod	Strona
Stal sprężynowa DIN267-26		36270	7-89
Stal sprężynowa DIN267-26	Mech. ocynk. żółt. pas.	36273	7-89
St.St. A2		51447	7-90
St.St. A4		55447	7-90

7

36270 Podkładki podatne stożkowe		L07C
Materiał	Stal sprężynowa DIN267-26	
		
		

Dla wymiaru nominalnego	Kod artykułu	Dla wymiaru nominalnego	Kod artykułu	Dla wymiaru nominalnego	Kod artykułu
M4	100 36270.040.001	M10	100 36270.100.001	M20	50 36270.200.001
M5	100 36270.050.001	M12	100 36270.120.001	M22	25 36270.220.001
M6	100 36270.060.001	M14	50 36270.140.001	M24	25 36270.240.001
M8	100 36270.080.001	M16	50 36270.160.001		

- Ostrzeżenie: cynkowanie elektrolityczne tych produktów może wywołać kruchość wodorową.

36273 Podkładki podatne stożkowe		L07C
Materiał	Stal sprężynowa DIN267-26	
Obróbka powierzchni	Mechanicznie cynkowane, po żółtej pasywacji	
		

Dla wymiaru nominalnego	Kod artykułu	Dla wymiaru nominalnego	Kod artykułu	Dla wymiaru nominalnego	Kod artykułu
M3	100 36273.030.001	M8	100 36273.080.001	M16	50 36273.160.001
M4	100 36273.040.001	M10	100 36273.100.001	M20	50 36273.200.001
M5	100 36273.050.001	M12	100 36273.120.001	M24	25 36273.240.001
M6	100 36273.060.001	M14	50 36273.140.001		

51447	Podkładki podatne stożkowe	R05A
Materiał	Stal nierdzewna A2	

Dla wymiaru nominalnego	☒	Kod artykułu	Dla wymiaru nominalnego	☒	Kod artykułu	Dla wymiaru nominalnego	☒	Kod artykułu
M3*	500	51447.030.001	M10	200	51447.100.001	M18*	100	51447.180.001
M4	500	51447.040.001	M12	200	51447.120.001	M20*	100	51447.200.001
M5	500	51447.050.001	M14*	100	51447.140.001	M22*	50	51447.220.001
M6*	500	51447.060.001	M16*	100	51447.160.001	M24*	50	51447.240.001
M8	200	51447.080.001						

55447	Podkładki podatne stożkowe	R45A
Materiał	Stal nierdzewna A4	

Dla wymiaru nominalnego	☒	Kod artykułu	Dla wymiaru nominalnego	☒	Kod artykułu	Dla wymiaru nominalnego	☒	Kod artykułu
M3*	500	55447.030.001	M10*	200	55447.100.001	M18*	100	55447.180.001
M4*	500	55447.040.001	M12*	200	55447.120.001	M20*	100	55447.200.001
M5*	500	55447.050.001	M14*	100	55447.140.001	M22*	50	55447.220.001
M6	500	55447.060.001	M16*	100	55447.160.001	M24*	50	55447.240.001

Sprężyny talerzowe do zastosowań krytycznych

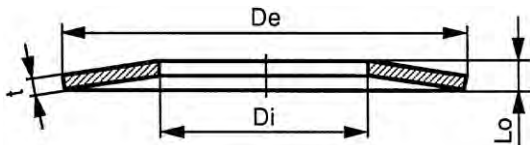

7

Informacje techniczne

D _e (h12)	D _i (H12)	F	Lo	t	D _e (h12)	D _i (H12)	F	Lo	t
8	3.2	104	0.55	0.3	18	8.2	265	1.1	0.5
8	3.2	186	0.6	0.4	18	8.2	596	1.25	0.7
8	3.2	357	0.7	0.5	18	8.2	783	1.3	0.8
10	3.2	98	0.65	0.3	18	8.2	1181	1.4	1
10	3.2	179	0.7	0.4	20	8.2	412	1.3	0.6
10	3.2	279	0.75	0.5	20	8.2	569	1.35	0.7
10	4.2	189	0.7	0.4	20	8.2	751	1.4	0.8
10	4.2	294	0.75	0.5	20	8.2	954	1.45	0.9
12	4.2	178	0.8	0.4	20	8.2	1294	1.55	1
12	4.2	284	0.85	0.5	20	10.2	1050	1.45	0.9
12	5.2	350	0.9	0.5	20	10.2	1425	1.55	1
12	5.2	506	0.95	0.6	20	10.2	2477	1.75	1.25
12	6.2	326	0.85	0.5	20	10.2	2521	1.8	1.5
12	6.2	552	0.95	0.6	23	8.2	544	1.5	0.7
12	5.2	272	0.85	0.5	23	8.2	719	1.55	0.8
15	5.2	176	0.95	0.4	23	8.2	919	1.6	0.9
15	5.2	278	1	0.5	23	10.2	1058	1.65	0.9
15	5.2	407	1.05	0.6	23	10.2	1315	1.7	1
15	5.2	555	1.1	0.7	23	12.2	2331	1.85	1.25
15	6.2	289	1	0.5	23	12.2	3297	2	1.5
15	6.2	424	1.05	0.6	25	12.2	2214	1.95	1.25
15	6.2	578	1.1	0.7	28	10.2	662	1.75	0.8
15	8.2	666	1.1	0.7	28	10.2	1130	1.9	1
15	8.2	982	1.2	0.8	28	10.2	1853	2.05	1.25
18	6.2	139	1	0.4	28	10.2	2723	2.2	1.5
18	6.2	245	1.1	0.5	28	12.2	3077	2.25	1.5
18	6.2	400	1.2	0.6	28	14.2	2240	2.1	1.25
18	6.2	553	1.25	0.7	31.5	12.2	1170	2.1	1
18	6.2	726	1.3	0.8	31.5	12.2	1800	2.2	1.25

Informacje techniczne					Informacje techniczne				
D _e (h12)	D _i (H12)	F	Lo	t	D _e (h12)	D _i (H12)	F	Lo	t
31.5	12.2	2697	2.35	1.5	60	20.4	7297	4.3	2.5
31.5	16.3	3230	2.4	1.5	60	25.4	8164	4.4	2.5
31.5	16.3	6173	2.75	2	60	25.4	11768	4.65	3
34	12.2	1172	2.25	1	60	30.5	9430	4.5	2.5
34	12.2	1815	2.35	1.25	60	30.5	13226	4.7	3
34	12.2	2721	2.5	1.5	60	30.5	18153	5	3.5
34	14.2	1989	2.4	1.25	70	25.5	4437	4.5	2
34	14.2	2984	2.55	1.5	70	30.5	11426	5.1	3
34	16.3	5783	2.85	2	70	35.5	12287	5.1	3
40	14.2	1778	2.65	1.25	70	40.5	23351	5.6	4
40	14.2	2542	2.75	1.5	70	40.5	33672	6.2	5
40	14.2	4763	3.05	2	80	31	10352	5.5	3
40	16.3	2749	2.8	1.5	80	36	11919	5.7	3
40	16.3	5169	3.1	2	80	36	21400	6.2	4
40	18.3	5956	3.15	2	80	41	22874	6.2	4
40	20.4	5701	3.1	2	100	41	20251	7.2	4
40	20.4	9390	3.45	2.5	100	51	36339	7.8	5
50	18.4	2603	3.5	1.5	125	51	44307	9.4	6
50	18.3	4567	3.5	2	125	61	50722	9.6	6
50	20.4	4687	3.5	2	150	61	45456	10.8	6
50	22.4	5222	3.6	2	150	81	89532	11.7	8
50	22.4	7919	3.85	2.5	200	92	137688	15.6	10
50	25.4	2512	3.1	1.5	200	112	195830	16.2	12
50	25.4	9063	3.9	2.5	250	127	383017	21.8	16

- Sprężyny talerzowe są stosowane głównie w zastosowaniach, gdzie bezpieczeństwo jest najważniejsze. Podobne zastosowania można znaleźć na przykład, w sprzęgłach bezpieczeństwa ograniczających moment obrotowy, w usztywniaczach przegubów oraz w zastosowaniach z ciągłym naciskiem tocącym. Dzięki odpowiedniemu łączeniu, np. nakładaniu na siebie podkładek sprężystych talerzowych można dokładnie ustalić elastyczność i/lub odchylenie. Specyfikacje techniczne tych podkładek sprężystych talerzowych w kwestii obciążenia statycznego i dynamicznego spełniają najwyższe oczekiwania. Przekraczają wymagania stawiane przez DIN 2093.
- Grupa materiałów 1: $t < 1,25$ ze stali Ck 67.
- Grupa materiałów 2: $1,25 \leq t \leq 6,0$ ze stali 50 Cr V4.
- Grupa materiałów 3: $6,0 > t \leq 14,0$ ze stali 50 Cr V4.
- Pęknięciom zmęczeniowym można w zasadzie zapobiec, ponieważ podkładki sprężyste talerzowe z grupy materiałów 2 i 3 mają krawędzie obrabiane maszynowo.
- F = Siła sprężyny w Newtonach przy odchyleniu $s \approx 0,75 h_0 (h_0 = L_0 - t)$.
- Do obliczania parametrów podkładek sprężystych talerzowych, patrz DIN 2092.
- Na żądanie dostępne są szczegółowe dane techniczne.

36450	Sprężyny talerzowe do zastosowań krytycznych	L07C
Materiał	Stal Ck 67 Werkstoffnr. 1.1231	
Obróbka powierzchni	Fosfatowane	
		

D _e x D _i x t	☒	Kod artykułu	D _e x D _i x t	☒	Kod artykułu	D _e x D _i x t	☒	Kod artykułu
8X3,2X0,3MM	100	36450.083.003	18X8,2X0,7MM	100	36450.188.007	31,5X16,3X1,5MM	50	36450.331.015
8X3,2X0,4MM	100	36450.083.004	18X8,2X0,8MM	100	36450.188.008	31,5X16,3X2,0MM	50	36450.331.020
8X3,2X0,5MM	100	36450.083.005	18X8,2X1,0MM	100	36450.188.010	34X12,2X1,0MM	25	36450.352.010
10X3,2X0,3MM	100	36450.103.003	20X8,2X0,6MM	50	36450.208.006	34X12,2X1,25MM	25	36450.352.012
10X3,2X0,4MM	100	36450.103.004	20X8,2X0,7MM	50	36450.208.007	34X12,2X1,5MM	25	36450.352.015
10X3,2X0,5MM	100	36450.103.005	20X8,2X0,8MM	50	36450.208.008	34X14,2X1,25MM	25	36450.354.012
10X4,2X0,4MM	100	36450.104.004	20X8,2X0,9MM	50	36450.208.009	34X14,2X1,5MM	25	36450.354.015
10X4,2X0,5MM	100	36450.104.005	20X8,2X1,0MM	50	36450.208.010	34X16,3X2,0MM	25	36450.356.020
12X4,2X0,4MM	100	36450.124.004	20X10,2X0,9MM	50	36450.210.009	40X14,2X1,25MM	25	36450.414.012
12X4,2X0,5MM	100	36450.124.005	20X10,2X1,0MM	50	36450.210.010	40X14,2X1,5MM	25	36450.414.015
12X5,2X0,5MM	100	36450.125.005	20X10,2X1,25MM	50	36450.210.012	40x14,2x2,0MM	25	36450.414.020
12X5,2X0,6MM	100	36450.125.006	20X10,2X1,5MM	50	36450.210.015	40X16,3X1,5MM	25	36450.416.015
12X6,2X0,5MM	100	36450.126.005	23X8,2X0,7MM	50	36450.238.007	40X16,3X2,0MM	25	36450.416.020
12X6,2X0,6MM	100	36450.126.006	23x8,2x0,8MM	50	36450.238.008	40X18,3X2,0MM	25	36450.418.020
15X5,2X0,4MM	100	36450.155.004	23X8,2X0,9MM	50	36450.238.009	40X20,4X2,0MM	25	36450.420.020
15X5,2X0,5MM	100	36450.155.005	23X10,2X0,9MM	50	36450.240.009	40X20,4X2,5MM	25	36450.420.025
15X5,2X0,6MM	100	36450.155.006	23X10,2X1,0MM	50	36450.240.010	50X18,4X1,5MM	25	36450.518.015
15X5,2X0,7MM	100	36450.155.007	23X12,2X1,25MM	50	36450.242.012	50X18,3X2,0MM	10	36450.518.020
15X6,2X0,5MM	100	36450.156.005	23X12,2X1,5MM	50	36450.242.015	50X20,4X2,0MM	10	36450.520.020
15X6,2X0,6MM	100	36450.156.006	25X12,2X1,25MM	50	36450.262.012	50X22,4X2,0MM	10	36450.522.020
15X6,2X0,7MM	100	36450.156.007	28X10,2X0,8MM	50	36450.290.008	50X22,4X2,5MM	10	36450.522.025
15X8,2X0,7MM	100	36450.158.007	28X10,2X1,0MM	50	36450.290.010	50X25,4X1,5MM	10	36450.525.015
15X8,2X0,8MM	100	36450.158.008	28X10,2X1,25MM	50	36450.290.012	50X25,4X2,5MM	10	36450.525.025
18X6,2X0,4MM	100	36450.186.004	28X10,2X1,5MM	50	36450.290.015	60X20,4X2,5MM	5	36450.620.025
18X6,2X0,5MM	100	36450.186.005	28X12,2X1,5MM	50	36450.292.015	60X25,4X2,5MM	5	36450.625.025
18X6,2X0,6MM	100	36450.186.006	28X14,2X1,25MM	50	36450.294.012	60X25,4X3,0MM	5	36450.625.030
18X6,2X0,7MM	100	36450.186.007	31,5X12,2X1,0MM	50	36450.327.010	60X30,5X2,5MM	5	36450.630.025
18X6,2X0,8MM	100	36450.186.008	31,5X12,2X1,25MM	50	36450.327.012	60X30,5X3,0MM	5	36450.630.030
18X8,2X0,5MM	100	36450.188.005	31,5X12,2X1,5MM	50	36450.327.015	60X30,5X3,5MM	5	36450.630.035

36450 Sprężyny talerzowe do zastosowań krytycznych

$D_e \times D_i \times t$	☒	Kod artykułu	$D_e \times D_i \times t$	☒	Kod artykułu	$D_e \times D_i \times t$	☒	Kod artykułu
70X25,5X2,0MM	5	36450.725.020	80X36,0X3,0MM	1	36450.836.030	125X61,0X6,0MM	1	36450.987.065
70X30,5X3,0MM	5	36450.730.030	80x36,0x4,0MM	1	36450.836.040	150X61,0X6,0MM	1	36450.992.060
70X35,5X3,0MM	5	36450.735.030	80X41,0X4,0MM	1	36450.841.040	150X81,0X8,0MM	1	36450.992.080
70X40,5X4,0MM	5	36450.740.040	100X41,0X4,0MM	1	36450.960.040	200X92,0X10,0MM	1	36450.997.100
70X40,5X5,0MM	5	36450.740.050	100X51,0X5,0MM	1	36450.982.050	200X112,0X12,0MM	1	36450.997.120
80X31,0X3,0MM	1	36450.831.030	125X51,0X6,0MM	1	36450.987.060	250X127,0X16,0MM	1	36450.999.160

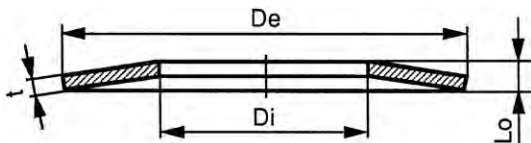
Sprężyny talerzowe do napinania łożysk kulkowych

Informacje techniczne

D_e (h12)	D_i (H12)	F	L_o	t	D_e (h12)	D_i (H12)	F	L_o	t
9.8	6.2	23	0.4	0.2	31.7	20.4	81	1.1	0.4
12.8	7.2	29	0.5	0.25	34.6	22.4	118	1.2	0.5
15.8	8.2	23	0.55	0.25	36.6	20.4	110	1.3	0.5
18.8	10.2	51	0.7	0.35	39.6	25.5	110	1.3	0.5
21.8	12.3	46	0.75	0.35	41.6	25.5	113	1.4	0.5
23.7	14.3	81	0.9	0.4	46.5	30.5	153	1.4	0.6
25.7	14.3	63	0.9	0.4	51.5	35.5	135	1.5	0.6
27.7	17.3	80	1	0.4	54.5	40.5	141	1.5	0.6
29.7	17.3	83	1.1	0.4	61.5	40.5	176	1.8	0.7

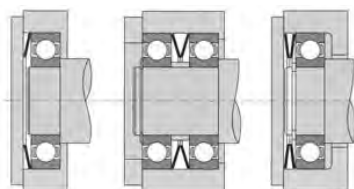
- F = Siła sprężyny w Newtonach przy odchyleniu $s \approx 0,75 h_0$ ($h_0 = L_0 - t$).
- Na żądanie dostępne są szczegółowe dane techniczne.

Przykład zastosowania

36460 Sprężyny talerzowe do napinania łożysk kulkowych
L07C

Materiał Stal
Obróbka powierzchni Fosfatowane

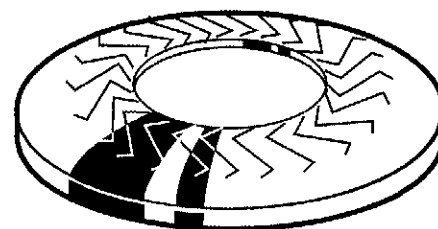
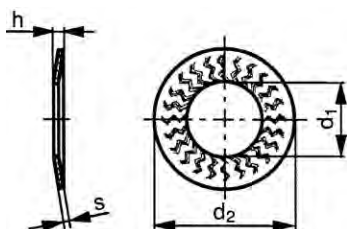

$D_e \times D_i \times t$	☒	Kod artykułu	$D_e \times D_i \times t$	☒	Kod artykułu	$D_e \times D_i \times t$	☒	Kod artykułu
9,8X6,2X0,2MM	100	36460.104.002	25,7X14,3X0,4MM	50	36460.271.004	39,6X25,5X0,5MM	25	36460.421.005
12,8X7,2X0,25MM	100	36460.135.002	27,7X17,3X0,4MM	50	36460.294.004	41,6X25,5X0,5MM	25	36460.441.005
15,8X8,2X0,25MM	100	36460.166.002	29,7X17,3X0,4MM	50	36460.314.004	46,5X30,5X0,6MM	25	36460.495.006
18,8X10,2X0,35MM	50	36460.198.003	31,7X20,4X0,4MM	25	36460.337.004	51,5X35,5X0,6MM	10	36460.550.006
21,8X12,3X0,35MM	50	36460.230.003	34,6X22,4X0,5MM	25	36460.368.005	54,5X40,5X0,6MM	10	36460.585.006
23,7X14,3X0,4MM	50	36460.251.004	36,6X20,4X0,5MM	25	36460.386.005	61,5X40,5X0,7MM	10	36460.655.007

Sprężyny talerzowe blokujące, typ M



Informacje techniczne

Dla wymiaru nominalnego	d ₁	d ₂	h	s
M4	4.1	10.2	1.5	1
M5	5.1	12.2	1.8	1.2
M6	6.1	14.2	2.2	1.4
M8	8.2	18.2	2.4	1.4
M10	10.2	22.25	2.75	1.6
M12	12.4	27.25	3.05	1.8
M14	14.4	30.25	3.5	2.4
M16	16.4	32.5	3.95	2.5

Grupy katalogowe

Material	Obróbka powierzchni	Kod	Strona
Stal sprężynowa 420-510 HV10	FLZNNC-NC6	36325	7-93
St.St. A4		55443	7-93

36325 Sprężyny talerzowe blokujące, typ M

L07C

Material Stal sprężynowa 420-510 HV10
Obróbka powierzchni O cynk platkowy bez Cr6+ wg ISO 10683 (flZnnc)



Dla wymiaru nominalnego	Kod artykułu	Dla wymiaru nominalnego	Kod artykułu	Dla wymiaru nominalnego	Kod artykułu
M5	250 36325.050.001	M10	200 36325.100.001	M16	100 36325.160.001
M6	250 36325.060.001	M12	150 36325.120.001		
M8	200 36325.080.001	M14	100 36325.140.001		

- Powlekanie powierzchniowe ISO 10683 cynkowanie platkowe eliminuje możliwości uszkodzenia, jakie może wywołać kruchość wodorowa.
- Podkładki sprężyste samozabezpieczające typ M, mogą być użyte z elementami złącznymi klasy ≤ 10.9

55443 Sprężyny talerzowe blokujące, typ M

R49A

Material Stal nierdzewna A4



Dla wymiaru nominalnego	Kod artykułu	Dla wymiaru nominalnego	Kod artykułu	Dla wymiaru nominalnego	Kod artykułu
M4	250 55443.040.001	M8	200 55443.080.001	M16	100 55443.160.001
M5	250 55443.050.001	M10	200 55443.100.001		
M6	250 55443.060.001	M12	100 55443.120.001		

- Podkładki sprężyste samozabezpieczające typ M, mogą być użyte z elementami złącznymi ze stali nierdzewnej A2/A4, do klasy 80.

Sprężyny talerzowe blokujące, typ Z

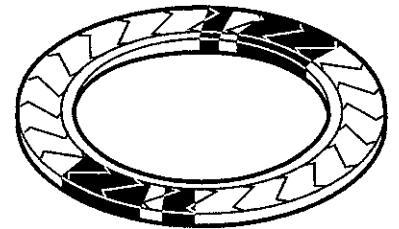
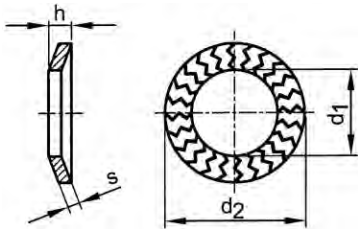

Informacje techniczne

Dla wymiaru nominalnego	d ₁	d ₂	h	s
M6	6.1	9.9	1.6	1.4
M8	8.2	12.7	1.7	1.4
M10	10.2	16.1	2	1.6
M12	12.4	18.3	2.2	1.8
M16	16.4	24.6	3.1	2.5

- SK podkładki sprężyste samozabezpieczające typ Z mogą być użyte ze śrubami z łbem imbusowym lub soczewkowym klasa ≤ 10.9.

36326	Sprężyny talerzowe blokujące, typ Z	L07C
Materiał	Stal sprężynowa 420-510 HV10	
Obróbka powierzchni	Ocynk płatkowy bez Cr6+ wg ISO 10683 (flZnnc)	

Dla wymiaru nominalnego	☒	Kod artykułu	Dla wymiaru nominalnego	☒	Kod artykułu	Dla wymiaru nominalnego	☒	Kod artykułu
M6	250	36326.060.001	M10	200	36326.100.001	M16	100	36326.160.001
M8	200	36326.080.001	M12	150	36326.120.001			

- Powlekanie powierzchniowe ISO 10683 cynkowanie płatkowe eliminuje możliwości uszkodzenia, jakie może wywołać kruchość wodorowa.

NORD-LOCK®

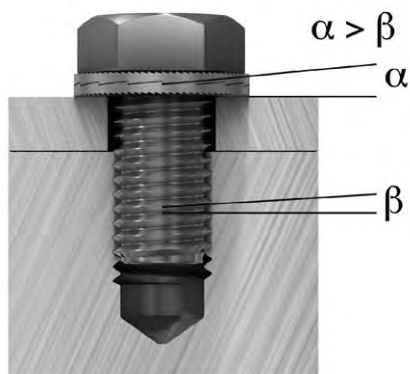

- Zabezpiecza przed samoczynnym luzowaniem wywołanym wibracjami i obciążeniami dynamicznymi.
- Technologia Nord-Lock oparta jest na zwiększeniu napięcia w śrubie.
- Możliwość wielokrotnego użycia.
- Szybki montaż i demontaż przy użyciu standardowych narzędzi.
- Podkładki pokryte płatkami cynku Delta Protekt® dla śrub o wymiarach M3-M130 / UNC 1/4"-1".
- Podkładki ze stali nierdzewnej dla śrub o wymiarach M3-M80 / UNC 1/4"-1".
- Podkładki ze stali nierdzewnej 254 SMO® dla śrub o wymiarach M3-M39 / UNC 1/4"-1".

Podkładki Nord-Lock są dostępne ze standardową oraz powiększoną średnicą zewnętrzną (sp).

- Podkładki sp zalecane są do otworów
- Powiększonych, elipsoidalnych oraz wykonanych w materiałach miękkich.
- Optymalny rezultat można uzyskać stosując podkładkę Nord-Lock "sp" razem z nakrętką lub śrubą kołnierkową.



Podkładki dostępne w następujących materiałach: stal, stal nierdzewna oraz stal nierdzewna 254 SMO®

Podkładki na zamówienie w następujących materiałach: stal nierdzewna INCONEL®/HASTELLOYS® C-276 oraz INCONEL®718



- Zapobiega odkręcaniu się śrub i nakrętek poddawanych wibracjom i obciążeniom dynamicznym.
- Zabezpiecza zarówno przed osadzeniem jak i relaksacją naprężeń.
- Jedno rozwiązanie do wszystkich zastosowań.
- Podkładki dostępne dla śrub o wymiarach M6-M20, ocynk płatkowy Delta Protekt®.
- Standardowa średnica zewnętrzna, powiększona średnica zewnętrzna (sp).

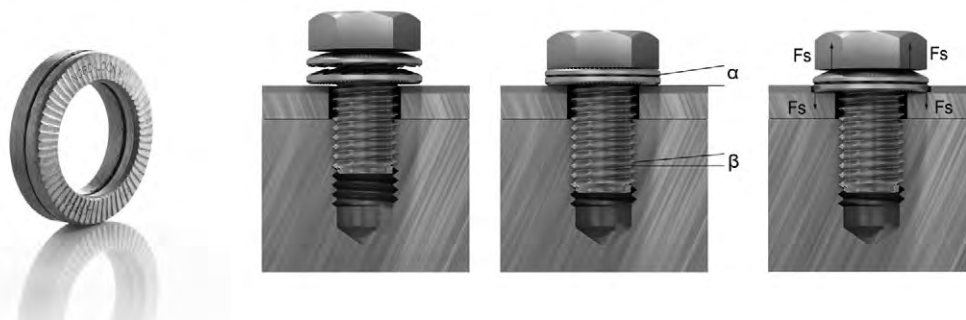

Podkładki Nord-Lock uzyskały liczne akceptacje / dopuszczenia techniczne i znalazły zastosowanie w niemal wszystkich gałęziach przemysłu na całym świecie: m.in. w energetyce, transporcie i kolejnictwie, górnictwie i przemyśle wydobywczym, budownictwie, przemyśle morskim w statkach i instalacjach nabrzeżnych, inżynierii lądowej, produkcji urządzeń wytwórczych, maszyn drogowych, leśnych i rolniczych.

Podkładki odporne na drgania, sklejone

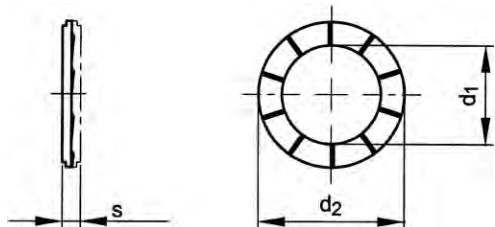

Informacje techniczne

Dla wymiaru nominalnego	d ₁	d ₂	s (Set)	Dla wymiaru nominalnego	d ₁	d ₂	s (Set)
M3	3.4	7	2.2	M18	19.5	29	3.4
M3.5	3.9	7.6	2.2	M20	21.4	30.7	3.4
M4	4.4	7.6	2.2	M22	23.4	34.5	3.4
M5	5.4	9	2.2	M24	25.3	39	3.4
M6	6.5	10.8	2.2	M27	28.4	42	6.8
M8	8.7	13.5	2.5	M30	31.4	47	6.8
M10	10.7	16.6	2.5	M33	34.4	48.5	6.8
M11	11.4	18.5	2.5	M36	37.4	55	6.8
M12	13	19.5	2.5	M39	40.4	58.5	6.8
M14	15.2	23	3.4	M42	43.2	63	6.8
M16	17	25.4	3.4				

- Informacje ogólne o podkładkach odpornych na wibracje NORD-LOCK, szukaj na stronie INFORMACYJNEJ.

Grupy katalogowe

Materiał	Obróbka powierzchni	Kod	Strona
St	Delta Pro	37980	7-96
St	Delta Pro	37985	7-96
St.St. A4		55437	7-97
St.St. A4		55436	7-97
St.St. 254 SMO®		55463	7-97

7

37980 NORD-LOCK podkładki klejone odporne na wibracje								NL1A
Materiał	Stal							
Obróbka powierzchni	Delta Protekt®							
Dla wymiaru nominalnego	☒	Kod artykułu	Dla wymiaru nominalnego	☒	Kod artykułu	Dla wymiaru nominalnego	☒	Kod artykułu
M3	200	37980.030.001	M11	200	37980.110.001	M24	100	37980.240.001
M3,5	200	37980.035.001	M12	200	37980.120.001	M27	50	37980.270.001
M4	200	37980.040.001	M14	100	37980.140.001	M30	50	37980.300.001
M5	200	37980.050.001	M16	100	37980.160.001	M33	25	37980.330.001
M6	200	37980.060.001	M18	100	37980.180.001	M36	25	37980.360.001
M8	200	37980.080.001	M20	100	37980.200.001	M39	25	37980.390.001
M10	200	37980.100.001	M22	100	37980.220.001	M42	25	37980.420.001

37985 NORD-LOCK podkładki klejone odporne na wibracje								NL3A
Materiał	Stal							
Obróbka powierzchni	Delta Protekt®							
Dla wymiaru nominalnego	☒	Kod artykułu	Dla wymiaru nominalnego	☒	Kod artykułu	Dla wymiaru nominalnego	☒	Kod artykułu
M6 (20PC)	1	37985.060.001	M10 (20PC)	1	37985.100.001	M16 (8PC)	1	37985.160.001
M8 (20PC)	1	37985.080.001	M12 (10PC)	1	37985.120.001	M20 (4PC)	1	37985.200.001

55437 NORD-LOCK Podkładki odporne na drgania, sklepane NL1A
Material Stal nierdzewna A4

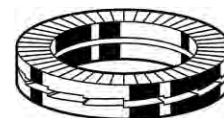
NORD-LOCK
Bolt securing system

Dla wymiaru nominalnego	✉	Kod artykułu	Dla wymiaru nominalnego	✉	Kod artykułu	Dla wymiaru nominalnego	✉	Kod artykułu
M3	200	55437.030.001	M11	200	55437.110.001	M24	100	55437.240.001
M3,5	200	55437.035.001	M12	200	55437.120.001	M27	50	55437.270.001
M4	200	55437.040.001	M14	100	55437.140.001	M30	50	55437.300.001
M5	200	55437.050.001	M16	100	55437.160.001	M33	25	55437.330.001
M6	200	55437.060.001	M18	100	55437.180.001	M36	25	55437.360.001
M8	200	55437.080.001	M20	100	55437.200.001	M39	25	55437.390.001
M10	200	55437.100.001	M22	100	55437.220.001	M42	25	55437.420.001

55436 NORD-LOCK Podkładki odporne na drgania, sklepane NL3A
Material Stal nierdzewna A4

NORD-LOCK
Bolt securing system



Dla wymiaru nominalnego	✉	Kod artykułu	Dla wymiaru nominalnego	✉	Kod artykułu	Dla wymiaru nominalnego	✉	Kod artykułu
M6 (10PC)	1	55436.060.001	M10 (10PC)	1	55436.100.001	M16 (4PC)	1	55436.160.001
M8 (10PC)	1	55436.080.001	M12 (6PC)	1	55436.120.001	M20 (3PC)	1	55436.200.001

55463 NORD-LOCK Podkładki odporne na drgania, sklepane NL1A
Material Stal nierdzewna 254 SMO®

NORD-LOCK
Bolt securing system

Dla wymiaru nominalnego	✉	Kod artykułu	Dla wymiaru nominalnego	✉	Kod artykułu	Dla wymiaru nominalnego	✉	Kod artykułu
M3	200	55463.030.001	M11	200	55463.110.001	M24	100	55463.240.001
M3,5	200	55463.035.001	M12	200	55463.120.001	M27	50	55463.270.001
M4	200	55463.040.001	M14	100	55463.140.001	M30	50	55463.300.001
M5	200	55463.050.001	M16	100	55463.160.001	M33	25	55463.330.001
M6	200	55463.060.001	M18	100	55463.180.001	M36	25	55463.360.001
M8	200	55463.080.001	M20	100	55463.200.001	M39	25	55463.390.001
M10	200	55463.100.001	M22	100	55463.220.001			

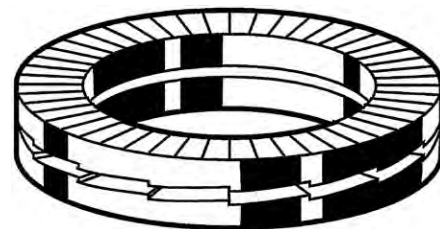
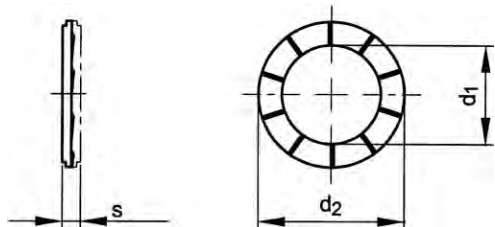
Podkładki odporne na drgania, niemetryczne



Informacje techniczne

Dla wymiaru nominalnego	d ₁	d ₂	s (Set)
1/4	0.28	0.65	2.3
3/8	0.41	0.65	2.5
1/2	0.53	0.77	2.5
3/4	0.79	1.21	3.4
1 Inch	1.1	1.54	3.4

Grupy katalogowe

Materiał	Obróbka powierzchni	Kod	Strona
St	Delta Pro	37979	7-98
St.St. A4		55438	7-98
St.St. 254 SMO®		55464	7-98

37979 NORD-LOCK podkładki klejone odporne na wibracje niemetryczne

NL1A

Materiał Stal
Obróbka powierzchni Delta Protekt®

NORD-LOCK
Bolt securing system



Dla wymiaru nominalnego	✉	Kod artykułu	Dla wymiaru nominalnego	✉	Kod artykułu	Dla wymiaru nominalnego	✉	Kod artykułu
1/4	200	37979.063.001	1/2	200	37979.127.001	1 Inch	100	37979.254.001
3/8	200	37979.096.001	3/4	100	37979.191.001			

55438 NORD-LOCK podkładki klejone odporne na wibracje niemetryczne

NL1A

Materiał Stal nierdzewna A4

NORD-LOCK
Bolt securing system



Dla wymiaru nominalnego	✉	Kod artykułu	Dla wymiaru nominalnego	✉	Kod artykułu	Dla wymiaru nominalnego	✉	Kod artykułu
1/4	200	55438.063.001	1/2	200	55438.127.001	1 Inch	100	55438.254.001
3/8	200	55438.096.001	3/4	100	55438.191.001			

55464 NORD-LOCK podkładki klejone odporne na wibracje

NL1A

Materiał Stal nierdzewna 254 SMO®

NORD-LOCK
Bolt securing system



Dla wymiaru nominalnego	✉	Kod artykułu	Dla wymiaru nominalnego	✉	Kod artykułu	Dla wymiaru nominalnego	✉	Kod artykułu
1/4	200	55464.063.001	1/2	200	55464.127.001	1 Inch	100	55464.254.001
3/8	200	55464.096.001	3/4	100	55464.191.001			

Podkładki odporne na wibracje, klejone, powiększone

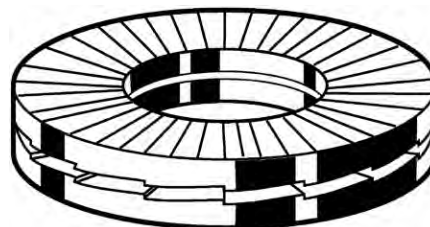
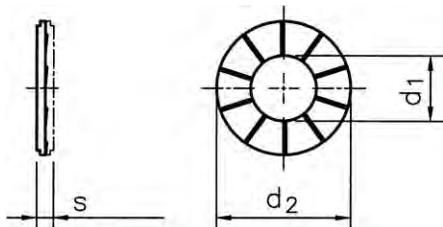

Informacje techniczne

Dla wymiaru nominalnego	d ₁	d ₂	s (Set)	Dla wymiaru nominalnego	d ₁	d ₂	s (Set)
M3.5	3.9	9	2.2	M18	19.5	34.5	3.4
M4	4.4	9	2.2	M20	21.4	39	3.4
M5	5.4	10.8	2.2	M22	23.4	42	4.6
M6	6.5	13.5	2.5	M24	25.3	48.5	4.6
M8	8.7	16.6	2.5	M27	28.4	48.5	5.8
M10	10.7	21	2.5	M30	31.4	58.5	6.6
M12	13	25.4	3.4	M33	34.4	58.5	6.6
M14	15.2	30.7	3.4	M36	37.4	63	6.6
M16	17	30.7	3.4				

- Informacje ogólne o podkładkach odpornych na wibracje NORD-LOCK, szukaj na stronie INFORMACYJNEJ.
- Podkładki odporne na wibrację o dużej średnicy zewnętrznej są zalecane dla otworów nadwymiarowych i wydłużonych, gdzie wymagana jest duża powierzchnia kontaktu

Grupy katalogowe

Material	Obróbka powierzchni	Kod	Strona
St	Delta Pro	pakowane po sztuce	37982
St	Delta Pro	Opakowanie zbiorcze	37986
St.St. A4			55453
St.St. A4		Opakowanie zbiorcze	55456
St.St. 254 SMO®			55465

37982 NORD-LOCK Podkładki odporne na drgania o dużej średnicy zewnętrznej, sklejone

NL1A

Material: Stal
Obróbka powierzchni: Delta Protekt®

NORD-LOCK
Bolt securing system



Dla wymiaru nominalnego x d ₂	☒	Kod artykułu	Dla wymiaru nominalnego x d ₂	☒	Kod artykułu	Dla wymiaru nominalnego x d ₂	☒	Kod artykułu
M3,5X9	200	37982.035.009	M12X25,4	100	37982.120.025	M24X48,5	50	37982.240.048
M4X9	200	37982.040.009	M14X30,7	100	37982.140.030	M27X48,5	25	37982.270.048
M5X10,8	200	37982.050.010	M16X30,7	100	37982.160.030	M30X58,5	25	37982.300.058
M6X13,5	200	37982.060.013	M18X34,5	100	37982.180.034	M33X58,5	25	37982.330.058
M8X16,6	200	37982.080.016	M20X39	100	37982.200.039	M36X63	25	37982.360.630
M10X21	200	37982.100.021	M22X42	50	37982.220.042			

- Ostrzeżenie: cynkowanie elektrolityczne tych produktów może wywołać kruchość wodorową.

37986 NORD-LOCK Podkładki odporne na drgania o dużej średnicy zewnętrznej, sklejone

NL3A

Material: Stal
Obróbka powierzchni: Delta Protekt®

NORD-LOCK
Bolt securing system



Dla wymiaru nominalnego x d ₂	☒	Kod artykułu	Dla wymiaru nominalnego x d ₂	☒	Kod artykułu	Dla wymiaru nominalnego x d ₂	☒	Kod artykułu
M6X13,5 (20PC)	1	37986.060.001	M10X21 (10PC)	1	37986.100.001	M16X30,7 (4PC)	1	37986.160.001
M8X16,6 (20PC)	1	37986.080.001	M12X25,4 (8PC)	1	37986.120.001	M20X39 (2PC)	1	37986.200.001

- Ostrzeżenie: cynkowanie elektrolityczne tych produktów może wywołać kruchość wodorową.

55453 **NORD-LOCK Podkładki odporne na drgania o zwiększonej średnicy zewnętrznej, sklejone** **NL1A**

Materiał Stal nierdzewna A4

NORD-LOCK
Bolt securing system

Dla wymiaru nominalnego x d ₂	☒	Kod artykułu	Dla wymiaru nominalnego x d ₂	☒	Kod artykułu	Dla wymiaru nominalnego x d ₂	☒	Kod artykułu
M3,5X9	200	55453.035.009	M10X21,0	200	55453.100.021	M20X39	100	55453.200.039
M4X9	200	55453.040.009	M12X25,4	100	55453.120.025	M22X42	50	55453.220.042
M5X10,8	200	55453.050.010	M14X30,7	100	55453.140.030	M24X48,5	50	55453.240.048
M6X13,5	200	55453.060.013	M16X30,7	100	55453.160.030	M27X48,5	25	55453.270.048
M8X16,6	200	55453.080.016	M18X34,5	100	55453.180.034	M30X58,5	25	55453.300.058

55456 **NORD-LOCK Podkładki odporne na drgania o zwiększonej średnicy zewnętrznej, sklejone** **NL3A**

Materiał Stal nierdzewna A4

NORD-LOCK
Bolt securing system

Dla wymiaru nominalnego x d ₂	☒	Kod artykułu	Dla wymiaru nominalnego x d ₂	☒	Kod artykułu	Dla wymiaru nominalnego x d ₂	☒	Kod artykułu
M6X13,5 (10PC)	1	55456.060.001	M10X21 (6PC)	1	55456.100.001	M16X30,7 (2PC)	1	55456.160.001
M8X16,6 (10PC)	1	55456.080.001	M12X25,4 (4PC)	1	55456.120.001	M20X39 (2PC)	1	55456.200.001

55465 **NORD-LOCK Podkładki odporne na drgania o zwiększonej średnicy zewnętrznej, sklejone** **NL1A**

Materiał Stal nierdzewna 254 SMO®

NORD-LOCK
Bolt securing system

Dla wymiaru nominalnego x d ₂	☒	Kod artykułu	Dla wymiaru nominalnego x d ₂	☒	Kod artykułu	Dla wymiaru nominalnego x d ₂	☒	Kod artykułu
M3,5X9	200	55465.035.009	M10X21,0	200	55465.100.021	M20X39,0	100	55465.200.039
M4X9	200	55465.040.009	M12X25,4	100	55465.120.025	M22X42,0	50	55465.220.042
M5X10,8	200	55465.050.010	M14X30,7	100	55465.140.030	M24X48,5	50	55465.240.048
M6X13,5	200	55465.060.013	M16X30,7	100	55465.160.030	M27X48,5	25	55465.270.048
M8X16,6	200	55465.080.016	M18X34,5	100	55465.180.034			

7

Podkładki odporne na wibracje niemetryczne powiększone

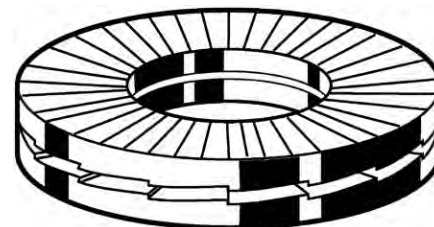
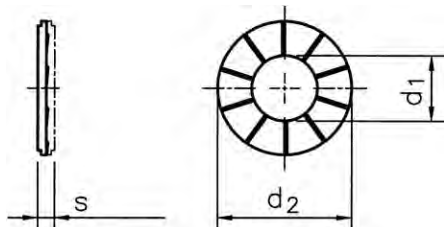

Informacje techniczne

Dla wymiaru nominalnego	d ₁	d ₂	s (Set)
1/4	0.28	0.53	2.5
3/8	0.41	0.83	2.5
1/2	0.53	1.00	3.4
3/4	0.79	1.54	3.4
1 Inch	1.1	1.91	5.6

Grupy katalogowe

Material	Obróbka powierzchni	Kod	Strona
St	Delta Pro	37984	7-101
St.St. A4		55454	7-101
St.St. 254 SMO®		55466	7-101

37984 NORD-LOCK podkładki klejone odporne na wibracje niemetryczne powiększone

NL1A

Material Stal
Obróbka powierzchni Delta Protekt®

NORD-LOCK
Bolt securing system



Dla wymiaru nominalnego x d ₂	Kod artykułu	Dla wymiaru nominalnego x d ₂	Kod artykułu	Dla wymiaru nominalnego x d ₂	Kod artykułu
1/4X13,5	200 37984.063.013	1/2X25,4	100 37984.127.025	1 InchX48,5	50 37984.254.048
3/8X21,0	200 37984.096.021	3/4X39,0	100 37984.191.039		

55454 NORD-LOCK podkładki klejone odporne na wibracje, powiększone niemetryczne

NL1A

Material Stal nierdzewna A4

NORD-LOCK
Bolt securing system



Dla wymiaru nominalnego x d ₂	Kod artykułu	Dla wymiaru nominalnego x d ₂	Kod artykułu	Dla wymiaru nominalnego x d ₂	Kod artykułu
1/4X13,5	200 55454.063.013	1/2X25,4	100 55454.127.025	1 InchX48,5	50 55454.254.048
3/8X21,0	200 55454.096.021	3/4X39,0	100 55454.191.039		

55466 NORD-LOCK podkładki klejone odporne na wibracje, powiększone niemetryczne

NL1A

Material Stal nierdzewna 254 SMO®

NORD-LOCK
Bolt securing system



Dla wymiaru nominalnego x d ₂	Kod artykułu	Dla wymiaru nominalnego x d ₂	Kod artykułu	Dla wymiaru nominalnego x d ₂	Kod artykułu
1/4X13,5	200 55466.063.013	1/2X25,4	100 55466.127.025	1 InchX48,5	50 55466.254.048
3/8X21,0	200 55466.096.021	3/4X39,0	100 55466.191.039		

Podkładki odporne na wibracje, stożkowe

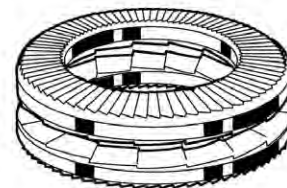
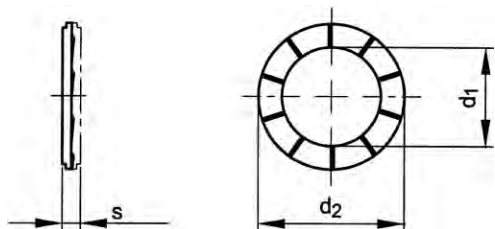

Informacje techniczne

Dla wymiaru nominalnego	d ₁	d ₂	s (Set)
M6	6.3	10.8	2.2
M8	8.4	13.5	2.3
M10	10.5	16.6	3
M12	12.5	19.5	3.5
M14	14.6	23.0	4.05
M16	16.6	25.4	4.8
M20	20.7	30.7	6.1

37981 NORD-LOCK Podkładki odporne na wibracje, stożkowe seria X

NL1A

Materiał Stal
Obróbka powierzchni Delta Protekt®



Dla wymiaru nominalnego	☒	Kod artykułu	Dla wymiaru nominalnego	☒	Kod artykułu	Dla wymiaru nominalnego	☒	Kod artykułu
M6	200	37981.060.001	M12	200	37981.120.001	M20	100	37981.200.001
M8	200	37981.080.001	M14	100	37981.140.001			
M10	200	37981.100.001	M16	100	37981.160.001			

Podkładki stożkowe klejone odporne na wibracje, niemetryczne

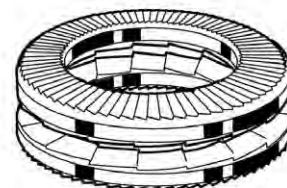
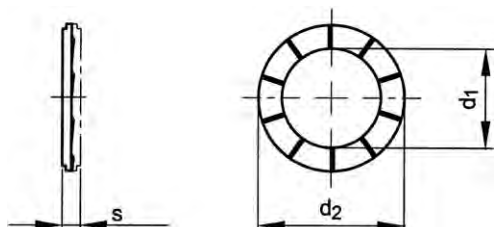

Informacje techniczne

Dla wymiaru nominalnego	d ₁	d ₂	s (Set)
1/4	6.7	11.5	0.069
3/8	10.0	16.6	0.106
1/2	13.2	19.5	0.142

37987 NORD-LOCK Podkładki odporne na wibracje, stożkowe niemetryczne seria X

NL1A

Materiał Stal
Obróbka powierzchni Delta Protekt®



Dla wymiaru nominalnego	☒	Kod artykułu	Dla wymiaru nominalnego	☒	Kod artykułu	Dla wymiaru nominalnego	☒	Kod artykułu
1/4	200	37987.063.001	3/8	200	37987.096.001	1/2	200	37987.127.001

Podkładki odporne na wibracje, stożkowe, powiększone, seria X

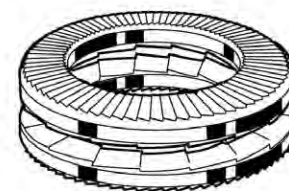
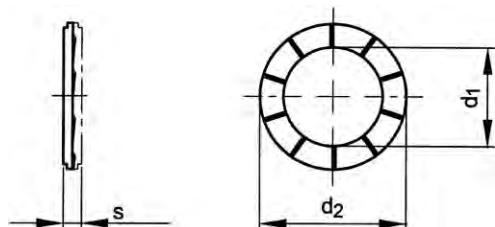

Informacje techniczne

Dla wymiaru nominalnego	d ₁	d ₂	s (Set)
M6	6.3	13.5	1.74
M8	8.4	16.6	2.3
M10	10.5	21.0	3.5
M12	12.5	25.4	4.2
M16	16.6	30.7	4.8
M20	20.7	39.0	5.63

37983 NORD-LOCK Podkładki odporne na wibracje, stożkowe, powiększone, seria X

NL1A

Materiał Stal
Obróbka powierzchni Delta Protekt®



Dla wymiaru nominalnego x d ₂	☒	Kod artykułu	Dla wymiaru nominalnego x d ₂	☒	Kod artykułu	Dla wymiaru nominalnego x d ₂	☒	Kod artykułu
M6X13,5	200	37983.060.013	M10X21	200	37983.100.021	M16X30,7	100	37983.160.030
M8X16,6	200	37983.080.016	M12X25,4	100	37983.120.025	M20X39	100	37983.200.039

Podkładki odporne na wibracje, stożkowe, powiększone, niemetryczne, seria X

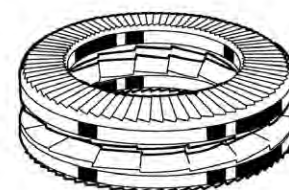
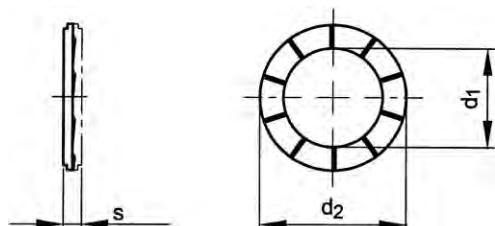

Informacje techniczne

Dla wymiaru nominalnego	d ₁	d ₂	s (Set)
3/8	10.0	21.0	0.138
1/2	13.2	25.4	0.165

37988 NORD-LOCK Podkładki odporne na wibracje, stożkowe, powiększone, niemetryczne, seria X

NL1A

Materiał Stal
Obróbka powierzchni Delta Protekt®



Dla wymiaru nominalnego x d ₂	☒	Kod artykułu	Dla wymiaru nominalnego x d ₂	☒	Kod artykułu
3/8X21	200	37988.096.021	1/2X25,4	100	37988.127.025

Podkładki sprężyste samozabezpieczające, typ S

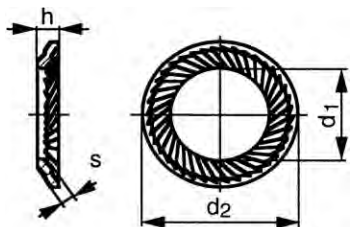

Informacje techniczne

Dla wymiaru nominalnego	d ₁ (H14)	d ₂ (h14)	h (max.)	s
M2.5	2.7	4.8	0.9	0.45
M3	3.2	5.5	0.9	0.4 (0.45)
M4	4.3	7	1	0.5
M5	5.3	8.5 (9)	1.1	0.6
M6	6.4	10	1.2	0.7
M8	8.4	13	1.4	0.8
M10	10.5	16	1.6	1
M12	13	18	1.7	1 (1.1)
M14	15	21 (22)	2	1.2
M16	17	24	2.1	1.2 (1.3)
M18	19	27	2.3	1.5
M20	21	30	2.5	1.5
M22	23	33	2.7	1.5
M24	25.6	36	2.9	1.8
M27	28.6	39	3.1	2
M30	31.6	45	3.6	2

Specjalne właściwości podkładek zabezpieczających typu S:

- kontakt najpierw na średnicy zewnętrznej, dający w rezultacie maksymalne działanie dźwigni
- wysokie zabezpieczenie wibracyjne z powodu kontaktu żeberkowego
- mogą być używane ze śrubami w klasie ≤ 8.8

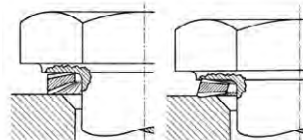

7

Grupy katalogowe

Material	Obróbka powierzchni	Kod	Strona	
Stal sprężynowa		36395	7-104	
Stal sprężynowa		36390	7-105	
Stal sprężynowa		Duże Opakowanie	36396	7-105
Stal sprężynowa	ZNTHP-NC6	36397	7-105	
Stal sprężynowa	ZNTHP-NC6	36411	7-105	
St.St. A2		51468	7-105	

36395 Podkładki sprężyste samozabezpieczające, typ S

L07A

Material Stal sprężynowa



Dla wymiaru nominalnego	☒	Kod artykułu	Dla wymiaru nominalnego	☒	Kod artykułu	Dla wymiaru nominalnego	☒	Kod artykułu
M3	500	36395.030.001	M6	500	36395.060.001	M12	250	36395.120.001
M4	500	36395.040.001	M8	250	36395.080.001	M14	100	36395.140.001
M5	500	36395.050.001	M10	250	36395.100.001	M16	100	36395.160.001

- Ostrzeżenie: cynkowanie elektrolityczne tych produktów może wywołać kruchość wodorową.

36390	Podkładki sprężyste samozabezpieczające, typ S	L07A
Materiał	Stal sprężynowa	
		 

Dla wymiaru nominalnego	✉	Kod artykułu	Dla wymiaru nominalnego	✉	Kod artykułu	Dla wymiaru nominalnego	✉	Kod artykułu
M18	100	36390.180.001	M22	50	36390.220.001	M27	50	36390.270.001
M20	100	36390.200.001	M24	50	36390.240.001	M30	50	36390.300.001

- Ostrzeżenie: cynkowanie elektrolityczne tych produktów może wywołać kruchość wodorową.

36396	Podkładki sprężyste samozabezpieczające, typ S	L07A
Materiał	Stal sprężynowa	
		 

Dla wymiaru nominalnego	✉	Kod artykułu	Dla wymiaru nominalnego	✉	Kod artykułu	Dla wymiaru nominalnego	✉	Kod artykułu
M3	2000	36396.030.001	M6	1000	36396.060.001	M12	500	36396.120.001
M4	1000	36396.040.001	M8	1000	36396.080.001	M14	500	36396.140.001
M5	1000	36396.050.001	M10	1000	36396.100.001	M16	500	36396.160.001

- Ostrzeżenie: cynkowanie elektrolityczne tych produktów może wywołać kruchość wodorową.



36397	Podkładki sprężyste samozabezpieczające, typ S	L07A
Materiał	Stal sprężynowa	
Obróbka powierzchni	Ocynek, gruba pasywacja Cr ³⁺	
		 

Dla wymiaru nominalnego	✉	Kod artykułu	Dla wymiaru nominalnego	✉	Kod artykułu	Dla wymiaru nominalnego	✉	Kod artykułu
M3	500	36397.030.001	M6	500	36397.060.001	M12	250	36397.120.001
M4	500	36397.040.001	M8	250	36397.080.001	M14	100	36397.140.001
M5	500	36397.050.001	M10	250	36397.100.001	M16	100	36397.160.001

- Ostrzeżenie: cynkowanie elektrolityczne tych produktów może wywołać kruchość wodorową.

36411	Podkładki sprężyste samozabezpieczające, typ S	L07A
Materiał	Stal sprężynowa	
Obróbka powierzchni	Ocynek, gruba pasywacja Cr ³⁺	
		 

Dla wymiaru nominalnego	✉	Kod artykułu	Dla wymiaru nominalnego	✉	Kod artykułu	Dla wymiaru nominalnego	✉	Kod artykułu
M18	100	36411.180.001	M22	50	36411.220.001	M27	50	36411.270.001
M20	100	36411.200.001	M24	50	36411.240.001	M30	50	36411.300.001

51468	Podkładki sprężyste samozabezpieczające, typ S	R09A
Materiał	Stal nierdzewna A2	
		 

Dla wymiaru nominalnego	✉	Kod artykułu	Dla wymiaru nominalnego	✉	Kod artykułu	Dla wymiaru nominalnego	✉	Kod artykułu
M2,5	500	51468.025.001	M8	250	51468.080.001	M16	100	51468.160.001
M3	500	51468.030.001	M10	250	51468.100.001	M20	50	51468.200.001
M4	500	51468.040.001	M12	250	51468.120.001	M24	50	51468.240.001
M5	500	51468.050.001	M14	100	51468.140.001	M30	50	51468.300.001
M6	500	51468.060.001						

Podkładki sprężyste samozabezpieczające, typ VS (pogrubione)

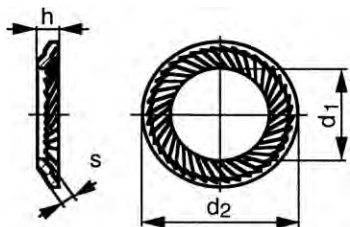

Informacje techniczne

Dla wymiaru nominalnego	d ₁ (H14)	d ₂ (h14)	h (max.)	s
M5	5.3	9	1.3	1
M6	6.4	10	1.4	1
M8	8.4	13	1.7	1.2
M10	10.5	16	2	1.5
M12	13	18	2.1	1.5
M14	15	22	2.2	1.5
M16	17	24	2.6	2
M20	21	30	2.8	2
M24	25.6	36	3.4	2.5
M30	31.6	45	3.8	2.5

Specjalne właściwości podkładek zabezpieczających typu VS:

- wzmocnione (zwiększona grubość) dające w rezultacie poprawione charakterystyki sprężyste
- kontakt najpierw na zewnętrznej średnicy, dający w rezultacie maksymalne działanie dźwigni
- wysokie bezpieczeństwo wibracyjne z powodu kontaktu żeberkowego
- mogą być używane ze śrubami o klasie wytrzymałości ≤ 10.9 i na powierzchniach hartowanych

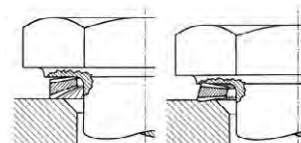

Grupy katalogowe

Materiał	Obróbka powierzchni	Kod	Strona
Stal sprężynowa		36420	7-106
Stal sprężynowa	ZNTHP-NC6	36425	7-106

7

36420	Podkładki sprężyste samozabezpieczające, typ VS (pogrubione)	L07A
Materiał	Stal sprężynowa	

Dla wymiaru nominalnego	☒	Kod artykułu	Dla wymiaru nominalnego	☒	Kod artykułu	Dla wymiaru nominalnego	☒	Kod artykułu
M5	500	36420.050.001	M12	250	36420.120.001	M24	50	36420.240.001
M6	500	36420.060.001	M14	100	36420.140.001	M30	50	36420.300.001
M8	250	36420.080.001	M16	100	36420.160.001			
M10	250	36420.100.001	M20	100	36420.200.001			

36425	Podkładki sprężyste samozabezpieczające, typ VS (pogrubione)	L07A
Materiał	Stal sprężynowa	
Obróbka powierzchni	O cynk, gruba pasywacja Cr ³⁺	

Dla wymiaru nominalnego	☒	Kod artykułu	Dla wymiaru nominalnego	☒	Kod artykułu	Dla wymiaru nominalnego	☒	Kod artykułu
M5	500	36425.050.001	M12	250	36425.120.001	M24	50	36425.240.001
M6	500	36425.060.001	M14	100	36425.140.001	M30	50	36425.300.001
M8	250	36425.080.001	M16	100	36425.160.001			
M10	250	36425.100.001	M20	100	36425.200.001			

Podkładki kontaktowe powiększone

NF E25-511

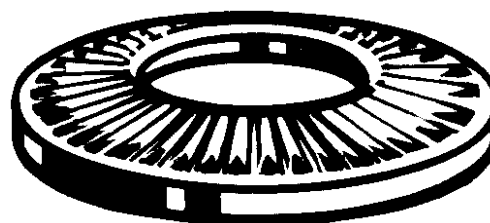
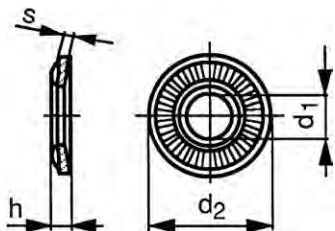

Informacje techniczne

Dla wymiaru nominalnego	d ₁ (H14)	d ₂ (js 15)	h (max.)	s
M3	3.1	8	1	0.6
M4	4.1	10	1.4	0.9
M5	5.1	12	1.8	1.1
M6	6.1	14	2.1	1.3
M7 (≠NF)	7.2	18	2.4	1.4
M8	8.2	18	2.35	1.4
M10	10.2	22	2.75	1.6
M12	12.4	27	3.1	1.8
M16	16.4	32	4.1	2.8
M20	20.5	40	4.9	3.2

Specjalne właściwości podkładek kontaktowych typu średniego:

- odpowiednie przy jednoczesnym użyciu jako podkładki blokujące i podkładki okrągłe z przewymiarowanymi lub wydłużonymi otworami
- bez uszkodzeń na powierzchni, wyjątkowe działanie zabezpieczające i wysoka elastyczność wyrównująca luz i ustawienie
- doskonale w kontakcie z urządzeniami elektrycznymi ze względu na nie przegrzewanie
- możliwe do zastosowania ze śrubami o klasie wytrzymałości ≤ 10.9

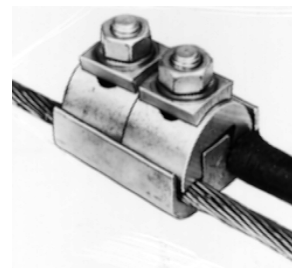

7

37282 Podkładki kontaktowe powiększone

L07D

Materiał Stal sprężynowa
Obróbka powierzchni Ocynk, gruba pasywacja Cr³⁺



Dla wymiaru nominalnego	☒	Kod artykułu	Dla wymiaru nominalnego	☒	Kod artykułu	Dla wymiaru nominalnego	☒	Kod artykułu
M3	200	37282.030.001	M6	100	37282.060.001	M12	100	37282.120.001
M4	200	37282.040.001	M8	100	37282.080.001	M16	100	37282.160.001
M5	100	37282.050.001	M10	100	37282.100.001	M20	100	37282.200.001

Podkładki kontaktowe

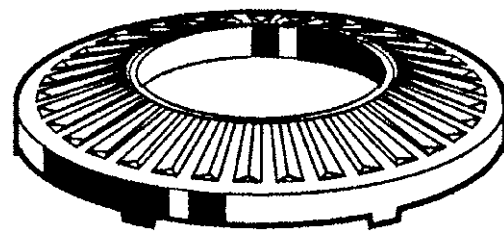
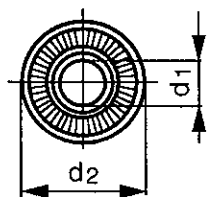
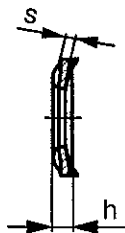

Informacje techniczne

Dla wymiaru nominalnego	d ₁ (H14)	d ₂ (js 15)	h (max.)	s
M4	4.1	8	1.15	0.8
M5	5.1	10	1.5	1
M6	6.1	12	1.8	1.2
M8	8.2	16	2.4	1.4
M10	10.2	20	2.6	1.6
M12	12.4	24	2.6	1.6

- Cechy szczególne podkładek zabezpieczających kontaktowych typ P:
- Odpowiednie do zastosowania jednocześnie jako podkładka blokująca i podkładka okrągła dla otworów nadwymiarowych lub wydłużonych.
- Nie uszkadzają powierzchni, bardzo dobrze blokują i są wysoce elastyczne w celu kompensacji luzu lub blokowania.
- Doskonały kontakt w urządzeniach elektrycznych zapobiega przegrzewaniu.
- Dostarczane z sześcioma ostrymi końcówkami (wysokość 0,3 mm), które wnikają w ewentualną warstwę lakieru i zapewniają doskonałe uziemienie.
- Nadaje się do śrub z klasy wytrzymałości ≤ 10.9.

37265 Podkładki kontaktowe, typ P

L07D

Materiał Stal sprężynowa
Obróbka powierzchni Ocynk, gruba pasywacja Cr³⁺



Dla wymiaru nominalnego	☒	Kod artykułu	Dla wymiaru nominalnego	☒	Kod artykułu	Dla wymiaru nominalnego	☒	Kod artykułu
M4	200	37265.040.001	M6	100	37265.060.001	M10	100	37265.100.001
M5	100	37265.050.001	M8	100	37265.080.001	M12	100	37265.120.001

DUBO Pierścienie uszczelniające

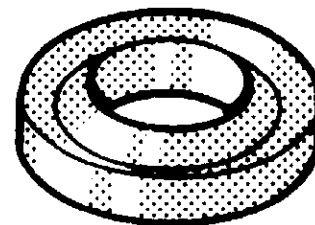
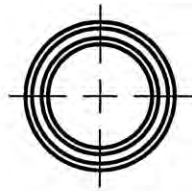
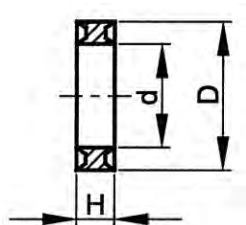

Informacje techniczne

Dla wymiaru nominalnego	d	D	H	Typ	V1 (min.)
M3	3.2	8	2.2	98/198	5
M4	4.15	9.5	2.6	99/199	6
M5	5.15	10.6	3	100/200	7
M6	6.2	12.7	3.5	101/201	8.5
M7	7.1	14.5	3.8	202	9
M8	8.1	16.2	4	102/203	10.5
M10	10.2	19.6	4.5	205	12.5
M12	12.2	23.6	5	207	14.5
M14	14.2	25.4	5.5	208	16.5
M16	16.2	29.4	6	211	19
M18	18.2	35.1	6.5	213	21.5
M20	20.3	35.7	7	215	23
M22	22.5	41.6	7.5	111/217	24.5
M24	24.3	41.6	8	219	26
M27	27.3	47.3	8.5	114/222	28.5
M30	30.2	53.1	8.5	115/225	30.5
M33	33.2	57.7	9	117/228	34
M36	36.2	63.5	10	119/231	38
M39	39.2	69.3	11	121/234	41
M45	45.2	80.8	16	125/240	51

Specjalne właściwości pierścieni uszczelniających DUBO:

- blokuje, ponieważ pierścień uszczelniający formuje sobie sześciokąt
- uszczelnia, ponieważ pierścień zostaje przyciśnięty do gwintu śruby i otworu
- zmniejsza hałas, ponieważ plastyczno-elastyczne zachowanie się pochłania drgania
- izoluje przed elektrolityczną korozją stykową dzięki połączeniu różnych materiałów
- odporny na temperaturę od -60°C do +120°C z obciążeniem statycznym i od -60°C do +80°C z obciążeniem dynamicznym

Dane montażowe/ przykład zastosowania

Bez wewnętrznego ząbkowania kołnierza pierścienia

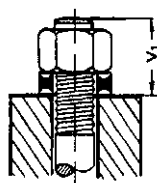

Przed zaciśnięciem

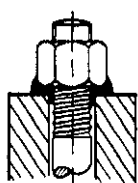

Po zaciśnięciu



Grupy katalogowe

Materiał	Klasa	Kolor	Kod	Strona
Plastik PA	6.6	Biały	37900	7-110
Plastik PA	6.6	Biały	37910	7-110

37900	DUBO Pierścienie uszczelniające do nakrętek i śrub z łbem sześciokątnym	W05C
Materiał	Plastik Poliamid (nylon)	
Klasa	6.6	
Kolor	Biały	

Dla wymiaru nominalnego	☒	Kod artykułu	Dla wymiaru nominalnego	☒	Kod artykułu	Dla wymiaru nominalnego	☒	Kod artykułu
M3	100	37900.030.001	M12	50	37900.120.001	M27	10	37900.270.001
M4	100	37900.040.001	M14	50	37900.140.001	M30	5	37900.300.001
M5	100	37900.050.001	M16	50	37900.160.001	M33	5	37900.330.001
M6	100	37900.060.001	M18	25	37900.180.001	M36	5	37900.360.001
M7	100	37900.070.001	M20	25	37900.200.001	M39	5	37900.390.001
M8	100	37900.080.001	M22	10	37900.220.001	M45	5	37900.450.001
M10	100	37900.100.001	M24	10	37900.240.001			

37910	DUBO Pierścienie uszczelniające do nakrętek i śrub z łbem sześciokątnym	W05C
Materiał	Plastik Poliamid (nylon)	
Klasa	6.6	
Kolor	Biały	

Dla wymiaru nominalnego	☒	Kod artykułu	Dla wymiaru nominalnego	☒	Kod artykułu	Dla wymiaru nominalnego	☒	Kod artykułu
M4	1000	37910.040.001	M8	1000	37910.080.001	M16	250	37910.160.001
M5	1000	37910.050.001	M10	1000	37910.100.001			
M6	1000	37910.060.001	M12	500	37910.120.001			

DUBO Pierścienie uszczelniające

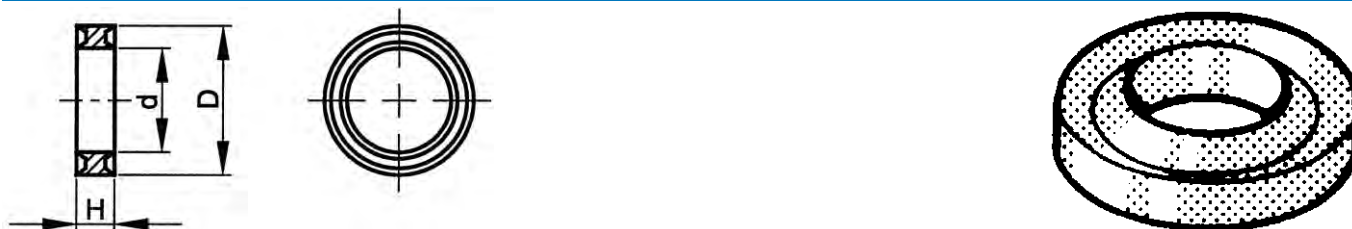

Informacje techniczne

Dla wymiaru nominalnego	d	D	H
M4	4.1	7.7	2
M5	5.15	9.8	3
M6	6.5	10.5	2.5
M8	8.1	14	3.3
M10	10.2	17	3.8
M12	12.2	19	4.4
M14	14.2	23	5.2
M16	16.2	25	5.6
M20	20.2	31.5	6.5

Specjalne właściwości pierścieni uszczelniających DUBO:

- blokuje, ponieważ pierścień uszczelniający formuje sobie sześciokąt
- uszczelnia, ponieważ pierścień zostaje przyciśnięty do gwintu śruby i otworu
- zmniejsza hałas, ponieważ plastyczno-elastyczne zachowanie się pochłania drgania
- izoluje przed elektrolityczną korozją stykową dzięki połączeniu różnych materiałów
- odporny na temperaturę od -60°C do +120°C z obciążeniem statycznym i od -60°C do +80°C z obciążeniem dynamicznym

Przykład zastosowania

Bez wewnętrznego ząbkowania kołnierza pierścienia

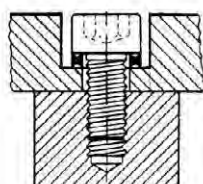

Przed zaciśnięciem

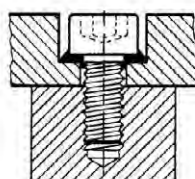

Po zaciśnięciu

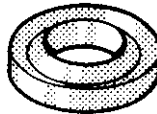

37901	DUBO Pierścienie uszczelniające do śrub z łbem walcowym	W05C
Materiał Klasa	Plastik Poliamid (nylon) 6	 

Dla wymiaru nominalnego	☒	Kod artykułu	Dla wymiaru nominalnego	☒	Kod artykułu	Dla wymiaru nominalnego	☒	Kod artykułu
M4	100	37901.040.001	M8	100	37901.080.001	M14	50	37901.140.001
M5	100	37901.050.001	M10	100	37901.100.001	M16	50	37901.160.001
M6	100	37901.060.001	M12	50	37901.120.001	M20	25	37901.200.001

Pierścienie kołnierzowe

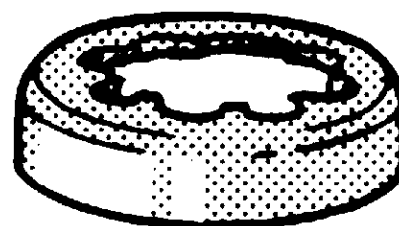
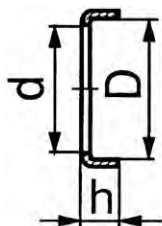

Informacje techniczne

Dla wymiaru nominalnego	d	D	h	V2
M4-M5	6.8	11.2	3.15	3.15
M6	9	13.2	4.15	9.25
M8	12	17.2	4.8	11.5
M10	13.5	21.3	5.7	13.5
M12	15.5	24.5	6	16
M16	21	31.25	6.75	20.75
M18-M20	26	37.5	7.25	23.25-24.75
3/4	27	39.5	7.25	24.75
M22-M24	30.5	44	8	26.5-28
M27	35	50.5	9	30.5
M30	40	56	10	-
M33	45	61	10.5	-
M36	50	67	11.05	-

Podkładki odginane jednołapkowe

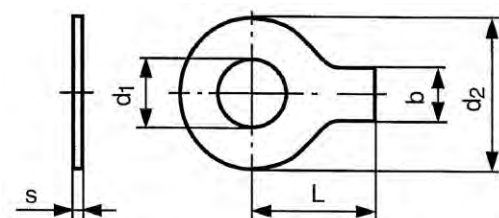

DIN 93
NEN 2277

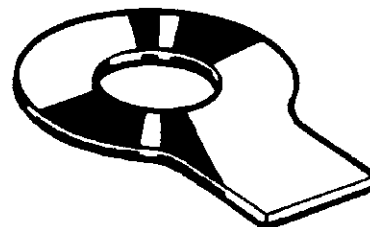

Informacje techniczne

Dla wymiaru nominalnego	b	d ₁	d ₂	L	s
M4	5	4.3	14	14	0.38
M5	6	5.3	17	16	0.5
M6	7	6.4	19	18	0.5
M8	8	8.4	22	20	0.75
M10	10	10.5	26	22	0.75
M12	12	13	30	28	1
M14	12	15	33	28	1
M16	15	17	36	32	1
M18	18	19	40	36	1
M20	18	21	42	36	1
M22	20	23	50	42	1
M24	20	25	50	42	1
M27	23	28	58	48	1.6
M30	26	31	63	52	1.6
M33	28	34	68	56	1.6
M36	30	37	75	60	1.6
M39	32	40	82	64	1.6
M42	35	43	88	70	1.6
M45	38	46	95	75	1.6
M48	40	50	100	80	1.6
M52	44	54	108	85	1.6

Przykład zastosowania

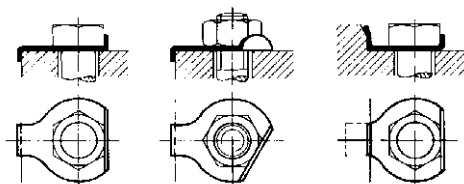

7

Grupy katalogowe

Material	Kod	Strona
St	38650	7-113
St.St. A2	51540	7-114
St.St. A4	55540	7-114

38650 Podkładki odginane jednołapkowe

L07J



Material Stal



Dla wymiaru nominalnego	☒	Kod artykułu	Dla wymiaru nominalnego	☒	Kod artykułu	Dla wymiaru nominalnego	☒	Kod artykułu
M6	100	38650.060.001	M20	50	38650.200.001	M39	10	38650.390.001
M8	100	38650.080.001	M22	50	38650.220.001	M42	10	38650.420.001
M10	100	38650.100.001	M24	25	38650.240.001	M45	10	38650.450.001
M12	100	38650.120.001	M27	25	38650.270.001	M48	10	38650.480.001
M14	100	38650.140.001	M30	10	38650.300.001	M52	10	38650.520.001
M16	100	38650.160.001	M33	10	38650.330.001			
M18	50	38650.180.001	M36	10	38650.360.001			

51540	Podkładki odginane jednołapkowe	R09A
Materiał	Stal nierdzewna A2	 

Dla wymiaru nominalnego	☒	Kod artykułu	Dla wymiaru nominalnego	☒	Kod artykułu	Dla wymiaru nominalnego	☒	Kod artykułu
M4*	500	51540.040.001	M14	100	51540.140.001	M24	25	51540.240.001
M5*	500	51540.050.001	M16	100	51540.160.001	M27	25	51540.270.001
M6	100	51540.060.001	M18*	200	51540.180.001	M30	10	51540.300.001
M8	100	51540.080.001	M20	50	51540.200.001	M36*	50	51540.360.001
M10	100	51540.100.001	M22*	100	51540.220.001	M39*	25	51540.390.001
M12	100	51540.120.001						

55540	Podkładki odginane jednołapkowe	R49A
Materiał	Stal nierdzewna A4	 

Dla wymiaru nominalnego	☒	Kod artykułu	Dla wymiaru nominalnego	☒	Kod artykułu	Dla wymiaru nominalnego	☒	Kod artykułu
M4*	500	55540.040.001	M14	100	55540.140.001	M27	25	55540.270.001
M5*	500	55540.050.001	M16	100	55540.160.001	M30	10	55540.300.001
M6	100	55540.060.001	M18*	200	55540.180.001	M33	10	55540.330.001
M8	100	55540.080.001	M20	50	55540.200.001	M36*	50	55540.360.001
M10	100	55540.100.001	M22	25	55540.220.001	M39*	25	55540.390.001
M12	100	55540.120.001	M24	25	55540.240.001			

Podkładki odginane dwułapkowe

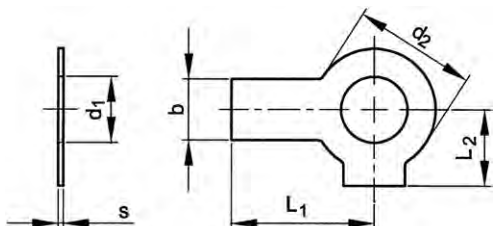

DIN 463
NEN 2278

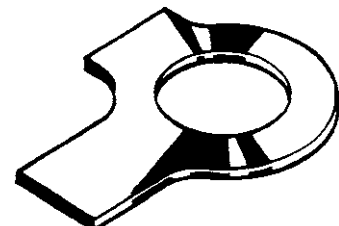

Informacje techniczne

Dla wymiaru nominalnego	b	d ₁	d ₂	L ₁	L ₂	s
M4	5	4.3	9	14	6.5	0.38
M5	6	5.3	10	16	8	0.5
M6	7	6.4	12.5	18	9	0.5
M8	8	8.4	17	20	11	0.75
M10	10	10.5	21	22	13	0.75
M12	12	13	24	28	15	1
M14	12	15	28	28	16	1
M16	15	17	30	32	18	1
M18	18	19	34	36	20	1
M20	18	21	37	36	21	1
M22	20	23	39	42	23	1
M24	20	25	44	42	25	1
M27	23	28	50	48	29	1.6
M30	26	31	56	52	32	1.6
M33	28	34	60	56	34	1.6
M36	30	37	66	60	38	1.6
M39	32	40	72	64	41	1.6
M42	35	43	78	70	44	1.6

Przykład zastosowania

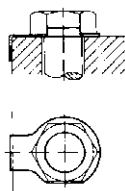

Grupy katalogowe

Material	Kod	Strona
St	38690	7-115
St.St. A2	51910	7-115
St.St. A4	55910	7-115

38690 Podkładki odginane dwułapkowe		L07J
Material	Stal	
		

Dla wymiaru nominalnego	☒	Kod artykułu	Dla wymiaru nominalnego	☒	Kod artykułu	Dla wymiaru nominalnego	☒	Kod artykułu
M6	100	38690.060.001	M18	50	38690.180.001	M30	10	38690.300.001
M8	100	38690.080.001	M20	50	38690.200.001	M33	10	38690.330.001
M10	100	38690.100.001	M22	25	38690.220.001	M36	10	38690.360.001
M12	100	38690.120.001	M24	25	38690.240.001	M39	10	38690.390.001
M14	100	38690.140.001	M27	25	38690.270.001	M42	10	38690.420.001
M16	100	38690.160.001						

51910 Podkładki odginane dwułapkowe		R09A
Material	Stal nierdzewna A2	
		

Dla wymiaru nominalnego	☒	Kod artykułu	Dla wymiaru nominalnego	☒	Kod artykułu	Dla wymiaru nominalnego	☒	Kod artykułu
M5*	100	51910.050.001	M16	50	51910.160.001	M27	25	51910.270.001
M6	100	51910.060.001	M18*	50	51910.180.001	M30	10	51910.300.001
M8	50	51910.080.001	M20	50	51910.200.001	M33	10	51910.330.001
M10	50	51910.100.001	M22*	25	51910.220.001	M36*	10	51910.360.001
M12	50	51910.120.001	M24	25	51910.240.001	M39*	10	51910.390.001
M14	50	51910.140.001						

55910 Podkładki odginane dwułapkowe		R49A
Material	Stal nierdzewna A4	
		

Dla wymiaru nominalnego	☒	Kod artykułu	Dla wymiaru nominalnego	☒	Kod artykułu	Dla wymiaru nominalnego	☒	Kod artykułu
M4*	100	55910.040.001	M14	50	55910.140.001	M27	25	55910.270.001
M5*	100	55910.050.001	M16	50	55910.160.001	M30	10	55910.300.001
M6	100	55910.060.001	M18*	50	55910.180.001	M33	10	55910.330.001
M8	50	55910.080.001	M20	50	55910.200.001	M36*	10	55910.360.001
M10	50	55910.100.001	M22*	25	55910.220.001	M39*	10	55910.390.001
M12	50	55910.120.001	M24	25	55910.240.001			

Podkładki odginane z noskiem wewnętrznym

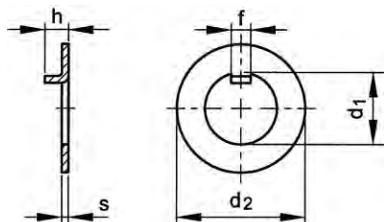

DIN 462

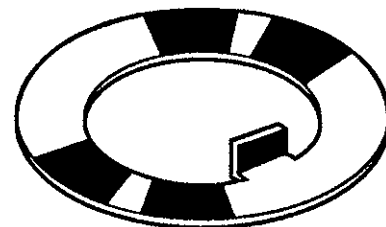

Informacje techniczne

d ₁ (H11)	d ₂ (h11)	f (C11)	h	n (H11)	s	t (maks.)
10	25	4	3	4	0.8	7.3
12	28	5	3	5	0.8	9.2
14	30	5	3	5	0.8	11.3
16	32	5	3	5	1	13.4
18	34	6	4	6	1	15.3
20	36	6	4	6	1	17.4
22	40	6	4	6	1	19.4
24	42	6	4	6	1	21.5
26	45	7	5	7	1	23.4
28	50	7	5	7	1	25.4
30	50	7	5	7	1.2	27.4
32	52	7	5	7	1.2	29.5
35	55	7	5	7	1.2	32.5
38	58	8	5	8	1.2	35.2
40	62	8	5	8	1.2	37.2
42	62	8	5	8	1.2	39.2
45	68	8	5	8	1.2	42.2
48	75	8	5	8	1.2	45.2
50	75	8	5	8	1.2	47.2
55	80	10	6	10	1.2	52.1
58	90	10	6	10	1.5	55.1
60	90	10	6	10	1.5	57.1
62	95	10	6	10	1.5	59.1
65	95	10	6	10	1.5	62.2
68	100	10	6	10	1.5	65.2
70	100	10	6	10	1.5	67.2
72	110	10	7	10	1.5	68.7
75	110	10	7	10	1.5	71.7
80	115	10	7	10	1.5	76.7
85	120	10	7	10	1.5	81.7
90	130	10	7	10	1.5	86.7
95	135	12	8	12	1.5	91.6
100	145	12	8	12	1.5	96.7

Przykład zastosowania/Dane montażowe

Nakrętka okrągła rowkowana do kluczy do nakrętek okrągłych z wcięciami według DIN 1804W

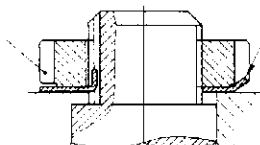

Podkładka odginana do wewnątrz według DIN 462

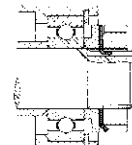
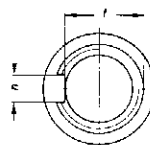

38684 Podkładki odginane z noskiem wewnętrznym

L07J

Materiał Stal
Obróbka powierzchni Ocynkowane



d ₁	☒	Kod artykułu	d ₁	☒	Kod artykułu	d ₁	☒	Kod artykułu
10MM	100	38684.100.001	20MM	50	38684.200.001	30MM	25	38684.300.001
12MM	100	38684.120.001	22MM	50	38684.220.001	32MM	25	38684.320.001
14MM	50	38684.140.001	24MM	25	38684.240.001	35MM	25	38684.350.001
16MM	50	38684.160.001	26MM	25	38684.260.001	38MM	25	38684.380.001
18MM	50	38684.180.001	28MM	25	38684.280.001	40MM	25	38684.400.001

38684 Podkładki odginane z noskiem wewnętrznym								
d_1	☒	Kod artykułu	d_1	☒	Kod artykułu	d_1	☒	Kod artykułu
42MM	25	38684.420.001	60MM	5	38684.600.001	75MM	5	38684.750.001
45MM	25	38684.450.001	62MM	5	38684.620.001	80MM	5	38684.800.001
48MM	25	38684.480.001	65MM	5	38684.650.001	85MM	5	38684.850.001
50MM	25	38684.500.001	68MM	5	38684.680.001	90MM	5	38684.900.001
55MM	25	38684.550.001	70MM	5	38684.700.001	95MM	5	38684.950.001
58MM	25	38684.580.001	72MM	5	38684.720.001	100MM	5	38684.982.001

Podkładki odginane z noskiem zewnętrznym

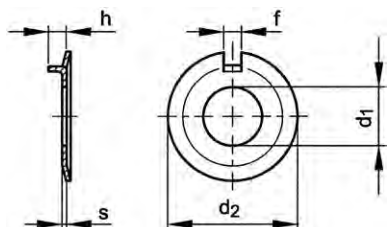

DIN 432
NEN 2279

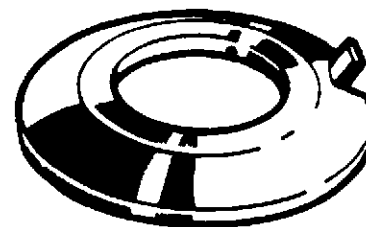

Informacje techniczne

Wymiar nominalny wałka d_1	d_1	d_2	f	$h \approx$	s
M4	4.3	14	2.5	2	0.4
M5	5.3	17	3.5	2.5	0.75
M6	6.4	19	3.5	3	0.75
M8	8.4	22	3.5	4	1
M10	10.5	26	4.5	4	1
M12	13	30	4.5	4.5	1.2
M14	15	33	4.5	4.5	1.2
M16	17	36	5.5	4.5	1.2
M18	19	40	6.5	4.5	1.2
M20	21	42	6.5	4.5	1.6
M22	23	50	7.5	6.5	1.6
M24	25	50	7.5	6.5	1.6
M27	28	58	8.5	9.5	1.6
M30	31	63	8.5	9.5	1.6
M33	34	68	9.5	9.5	1.6
M36	37	75	11	9.5	2
M39	40	82	11	11	2
M42	43	88	11	11	2
M45	46	95	13	12	2
M48	50	100	13	13	2
M52	54	105	13	13	2
M56	58	112	16	14	2.5
M60	62	118	16	13.5	2.5
M64	66	125	18	13.5	2.5

Przykład zastosowania

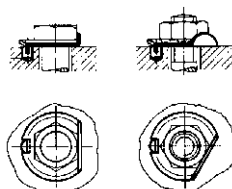

Grupy katalogowe

Material	Kod	Strona
St	38670	7-118
St.St. A2	51914	7-118
St.St. A4	55914	7-118

38670 Podkładki odginane z noskiem zewnętrznym **L07J**

Materiał Stal



Dla wymiaru nominalnego	✉	Kod artykułu	Dla wymiaru nominalnego	✉	Kod artykułu	Dla wymiaru nominalnego	✉	Kod artykułu
M6	100	38670.060.001	M22	50	38670.220.001	M42	10	38670.420.001
M8	100	38670.080.001	M24	25	38670.240.001	M45	10	38670.450.001
M10	100	38670.100.001	M27	25	38670.270.001	M48	10	38670.480.001
M12	100	38670.120.001	M30	10	38670.300.001	M52	10	38670.520.001
M14	100	38670.140.001	M33	10	38670.330.001	M56	5	38670.560.001
M16	100	38670.160.001	M36	10	38670.360.001	M60	5	38670.600.001
M18	50	38670.180.001	M39	10	38670.390.001	M64	5	38670.640.001
M20	50	38670.200.001						

51914 Podkładki odginane z noskiem zewnętrznym **R09A**

Materiał Stal nierdzewna A2



Dla wymiaru nominalnego	✉	Kod artykułu	Dla wymiaru nominalnego	✉	Kod artykułu	Dla wymiaru nominalnego	✉	Kod artykułu
M4*	100	51914.040.001	M14*	50	51914.140.001	M24*	25	51914.240.001
M5*	100	51914.050.001	M16*	50	51914.160.001	M27*	25	51914.270.001
M6*	100	51914.060.001	M18*	50	51914.180.001	M30*	25	51914.300.001
M8*	100	51914.080.001	M20*	50	51914.200.001	M33*	10	51914.330.001
M10*	100	51914.100.001	M22*	25	51914.220.001	M36*	10	51914.360.001

55914 Podkładki odginane z noskiem zewnętrznym **R49A**

Materiał Stal nierdzewna A4



Dla wymiaru nominalnego	✉	Kod artykułu	Dla wymiaru nominalnego	✉	Kod artykułu	Dla wymiaru nominalnego	✉	Kod artykułu
M5*	100	55914.050.001	M14*	50	55914.140.001	M22*	25	55914.220.001
M6*	100	55914.060.001	M16*	50	55914.160.001	M24*	25	55914.240.001
M8*	100	55914.080.001	M18*	50	55914.180.001	M27*	25	55914.270.001
M10*	100	55914.100.001	M20*	50	55914.200.001	M30*	25	55914.300.001
M12*	50	55914.120.001						

Pierścienie osadcze zewnętrzne, typ normalny

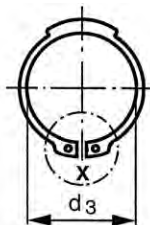

DIN 471
NF E22-163
BS 3673-4



Informacje techniczne

Wymiar nominalny wałka d_1	Pierścień d_3	Pierścień d_4	Pierścień s	Rowek d_2	Rowek m (H13)	Rowek n (min.)
3	2.7	7	0.4	2.8	0.5	0.3
4	3.7	8.6	0.4	3.8	0.5	0.3
5	4.7	10.3	0.6	4.8	0.7	0.3
6	5.6	11.7	0.7	5.7	0.8	0.5
7	6.5	13.5	0.8	6.7	0.9	0.5
8	7.4	14.7	0.8	7.6	0.9	0.6
9	8.4	16	1	8.6	1.1	0.6
10	9.3	17	1	9.6	1.1	0.6
11	10.2	18	1	10.5	1.1	0.8
12	11	19	1	11.5	1.1	0.8
13	11.9	20.2	1	12.4	1.1	0.9
14	12.9	21.4	1	13.4	1.1	0.9
15	13.8	22.6	1	14.3	1.1	1.1
16	14.7	23.8	1	15.2	1.1	1.2
17	15.7	25	1	16.2	1.1	1.2
18	16.5	26.2	1.2	17	1.3	1.5
19	17.5	27.2	1.2	18	1.3	1.5
20	18.5	28.4	1.2	19	1.3	1.5
21	19.5	29.6	1.2	20	1.3	1.5
22	20.5	30.8	1.2	21	1.3	1.5
23 (#DIN)	21.5	31	1.2	22	1.3	1.5
24	22.2	33.2	1.2	22.9	1.3	1.7
25	23.2	34.2	1.2	23.9	1.3	1.7
26	24.2	35.5	1.2	24.6	1.3	1.7
27 (#DIN)	24.9	35.4	1.2	25.9	1.3	2.1
28	25.9	37.9	1.5	26.6	1.6	2.1
29	26.9	39.1	1.5	27.6	1.6	2.1
30	27.9	40.5	1.5	28.6	1.6	2.1
31 (#DIN)	28.6	40.3	1.5	29.3	1.6	2.6
32	29.6	43	1.5	30.3	1.6	2.6
33 (#DIN)	30.5	43.4	1.5	31.3	1.6	2.6
34	31.5	45.4	1.5	32.3	1.6	2.6
35	32.2	46.8	1.5	33	1.6	3
36	33.2	47.8	1.75	34	1.85	3
37 (#DIN)	34.2	48	1.75	35	1.85	3
38	35.2	50.2	1.75	36	1.85	3
39 (#DIN)	36	50.2	1.75	37	1.85	3
40	36.5	52.6	1.75	37.5	1.85	3.8
42	38.5	55.7	1.75	39.5	1.85	3.8
44 (#DIN)	40.5	56	1.75	41.5	1.85	3.8
45	41.5	59.1	1.75	42.5	1.85	3.8
46	42.5	60.2	1.75	43.5	1.85	3.8
47 (#DIN)	43.5	61.3	1.75	44.5	1.85	3.8
48	44.5	62.5	1.75	45.5	1.85	3.8
50	45.8	64.5	2	47	2.15	4.5
52	47.8	66.7	2	49	2.15	4.5
54 (#DIN)	49.8	67	2	51	2.15	4.5
55	50.8	70.2	2	52	2.15	4.5
56	51.8	71.6	2	53	2.15	4.5
57 (#DIN)	52.8	70	2	54	2.15	4.5
58	53.8	73.6	2	55	2.15	4.5
60	55.8	75.6	2	57	2.15	4.5
62	57.8	77.8	2	59	2.15	4.5
63	58.8	79	2	60	2.15	4.5
65	60.8	81.4	2.5	62	2.65	4.5
67 (#DIN)	62.5	82	2.5	64	2.65	4.5
68	63.5	84.8	2.5	65	2.65	4.5

Informacje techniczne

Wymiar nominalny wałka d_1	Pierścień d_3	Pierścień d_4	Pierścień s	Rowek d_2	Rowek m (H13)	Rowek n (min.)
70	65.5	87	2.5	67	2.65	4.5
72	67.5	89.2	2.5	69	2.65	4.5
75	70.5	92.7	2.5	72	2.65	4.5
77 (#DIN)	72.5	94	2.5	74	2.65	4.5
78	73.5	96.1	2.5	75	2.65	4.5
80	74.5	98.1	2.5	76.5	2.65	5.3
82	76.5	100.3	2.5	78.5	2.65	5.3
85	79.5	103.3	3	81.5	3.15	5.3
87 (#DIN)	81.5	104	3	83.5	3.15	5.3
88	82.5	106.5	3	84.5	3.15	5.3
90	84.5	108.5	3	86.5	3.15	5.3
92 (#DIN)	86.5	111	3	88.5	3.15	5.3
95	89.5	114.8	3	91.5	3.15	5.3
97 (#DIN)	91.5	116	3	93.5	3.15	5.3
98 (#DIN)	92.5	117	3	94.5	3.15	5.3
100	94.5	120.2	3	96.5	3.15	5.3
105	98	125.8	4	101	4.15	6
110	103	131.2	4	106	4.15	6
115	108	137.3	4	111	4.15	6
120	113	143.1	4	116	4.15	6
125	118	149	4	121	4.15	6
130	123	154.4	4	126	4.15	6
135	128	159.8	4	131	4.15	6
140	133	165.2	4	136	4.15	6
145	138	170.6	4	141	4.15	6
150	142	177.3	4	145	4.15	7.5
155	146	182.3	4	150	4.15	7.5
160	151	188	4	155	4.15	7.5
165	155.5	193.4	4	160	4.15	7.5
170	160.5	198.4	4	165	4.15	7.5
175	165.5	203.4	4	170	4.15	7.5
180	170.5	210	4	175	4.15	7.5
185	175.5	215	4	180	4.15	7.5
190	180.5	220	4	185	4.15	7.5
195	185.5	225	4	190	4.15	7.5
200	190.5	230	4	195	4.15	7.5
210	198	240	5	204	5.15	9
220	208	250	5	214	5.15	9
230	218	260	5	224	5.15	9
240	228	270	5	234	5.15	9
250	238	280	5	244	5.15	9
260	245	294	5	252	5.15	12
270	255	304	5	262	5.15	12
280	265	314	5	272	5.15	12
290	275	324	5	282	5.15	12
300	285	334	5	292	5.15	12

- W zależności od dostępności może być dostarczony typ fosfatowany. Typ powiększony jest dostępny tylko na zamówienie.
- Ostrzeżenie: cynkowanie elektrolityczne tych produktów może wywołać kruchość wodorową.

Dane montażowe

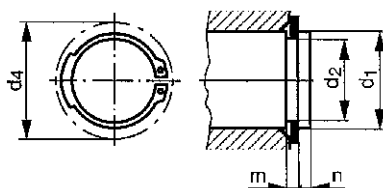

DETAIL X		
$d_1 \leq 9 \text{ mm.}$	$d_1 > 9 \leq 300 \text{ mm.} \textcircled{1}$	$d_1 \geq 170 \text{ mm.} \textcircled{1}$

$\textcircled{1}$ Zależy od producenta



Grupy katalogowe

Material	Kod	Strona
Stal sprężynowa	36000	7-121
St.St.	51435	7-121

36000	Pierścienie osadcze zewnętrzne, typ normalny	L07A
Materiał	Stal sprężynowa	
		

Wymiar nominalny wałka d ₁	☒	Kod artykułu	Wymiar nominalny wałka d ₁	☒	Kod artykułu	Wymiar nominalny wałka d ₁	☒	Kod artykułu
3MM	500	36000.003.001	38MM	100	36000.038.001	95MM	5	36000.095.001
4MM	500	36000.004.001	39MM	100	36000.039.001	97MM	5	36000.097.001
5MM	500	36000.005.001	40MM	50	36000.040.001	98MM	5	36000.098.001
6MM	500	36000.006.001	42MM	50	36000.042.001	100MM	5	36000.100.001
7MM	500	36000.007.001	44MM	50	36000.044.001	105MM	5	36000.105.001
8MM	250	36000.008.001	45MM	50	36000.045.001	110MM	5	36000.110.001
9MM	250	36000.009.001	46MM	50	36000.046.001	115MM	5	36000.115.001
10MM	250	36000.010.001	47MM	50	36000.047.001	120MM	5	36000.120.001
11MM	250	36000.011.001	48MM	50	36000.048.001	125MM	5	36000.125.001
12MM	250	36000.012.001	50MM	50	36000.050.001	130MM	5	36000.130.001
13MM	100	36000.013.001	52MM	50	36000.052.001	135MM	5	36000.135.001
14MM	100	36000.014.001	54MM	25	36000.054.001	140MM	5	36000.140.001
15MM	100	36000.015.001	55MM	25	36000.055.001	145MM	5	36000.145.001
16MM	100	36000.016.001	56MM	25	36000.056.001	150MM	3	36000.150.001
17MM	100	36000.017.001	57MM	25	36000.057.001	155MM	3	36000.155.001
18MM	100	36000.018.001	58MM	25	36000.058.001	160MM	3	36000.160.001
19MM	100	36000.019.001	60MM	25	36000.060.001	165MM	3	36000.165.001
20MM	100	36000.020.001	62MM	25	36000.062.001	170MM	3	36000.170.001
21MM	100	36000.021.001	63MM	25	36000.063.001	175MM	2	36000.175.001
22MM	100	36000.022.001	65MM	10	36000.065.001	180MM	2	36000.180.001
23MM	100	36000.023.001	67MM	10	36000.067.001	185MM	2	36000.185.001
24MM	100	36000.024.001	68MM	10	36000.068.001	190MM	2	36000.190.001
25MM	100	36000.025.001	70MM	10	36000.070.001	195MM	2	36000.195.001
26MM	100	36000.026.001	72MM	10	36000.072.001	200MM	2	36000.200.001
27MM	100	36000.027.001	75MM	10	36000.075.001	210MM	2	36000.210.001
28MM	100	36000.028.001	77MM	10	36000.077.001	220MM	2	36000.220.001
29MM	100	36000.029.001	78MM	10	36000.078.001	230MM	2	36000.230.001
30MM	100	36000.030.001	80MM	10	36000.080.001	240MM	2	36000.240.001
31MM	100	36000.031.001	82MM	10	36000.082.001	250MM	2	36000.250.001
32MM	100	36000.032.001	85MM	5	36000.085.001	260MM	2	36000.260.001
33MM	100	36000.033.001	87MM	5	36000.087.001	270MM	2	36000.270.001
34MM	100	36000.034.001	88MM	5	36000.088.001	280MM	2	36000.280.001
35MM	100	36000.035.001	90MM	5	36000.090.001	290MM	2	36000.290.001
36MM	100	36000.036.001	92MM	5	36000.092.001	300MM	2	36000.300.001
37MM	100	36000.037.001						

7

51435	Pierścienie osadcze zewnętrzne, typ normalny	R09A
Materiał	Stal nierdzewna	DIN ≈471
		
		

Wymiar nominalny wałka d ₁	☒	Kod artykułu	Wymiar nominalny wałka d ₁	☒	Kod artykułu	Wymiar nominalny wałka d ₁	☒	Kod artykułu
3MM*	200	51435.003.001	21MM	50	51435.021.001	45MM	10	51435.045.001
4MM	200	51435.004.001	22MM	50	51435.022.001	47MM	10	51435.047.001
5MM	200	51435.005.001	23MM	50	51435.023.001	48MM	10	51435.048.001
6MM	200	51435.006.001	24MM	50	51435.024.001	50MM	5	51435.050.001
7MM	200	51435.007.001	25MM	25	51435.025.001	52MM	5	51435.052.001
8MM	100	51435.008.001	26MM	25	51435.026.001	55MM	5	51435.055.001
9MM	100	51435.009.001	27MM	25	51435.027.001	60MM	5	51435.060.001
10MM	100	51435.010.001	28MM	25	51435.028.001	65MM	5	51435.065.001
11MM	100	51435.011.001	29MM*	50	51435.029.001	70MM	5	51435.070.001
12MM	100	51435.012.001	30MM	25	51435.030.001	75MM	5	51435.075.001
13MM	50	51435.013.001	32MM	25	51435.032.001	80MM	5	51435.080.001
14MM	50	51435.014.001	34MM	25	51435.034.001	85MM	1	51435.085.001
15MM	50	51435.015.001	35MM	25	51435.035.001	90MM	1	51435.090.001
16MM	50	51435.016.001	36MM	25	51435.036.001	95MM	1	51435.095.001
17MM	50	51435.017.001	38MM	25	51435.038.001	100MM	1	51435.100.001
18MM	50	51435.018.001	39MM*	25	51435.039.001	105MM*	10	51435.105.001
19MM	50	51435.019.001	40MM	10	51435.040.001	110MM*	10	51435.110.001
20MM	50	51435.020.001	42MM	10	51435.042.001	120MM*	10	51435.120.001

- Pierścienie osadcze ze stali nierdzewnej zrobione są ze stali martenzytowej.
- Przy montowaniu należy używać szczypiec montażowych ze śrubą w celu ograniczenia otwierania-zamykania pierścienia.
- Zalecane jest aby aplikować minimalne ilości na trzonku lub oprawie jeżeli aplikacja tego wymaga.
- Należy unikać kontaktu z płynami zawierającymi chlor aby zredukować możliwość wystąpienia pęknięcia korozyjnego.

Pierścienie osadcze wewnętrzne, typ normalny

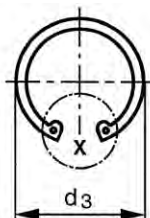

DIN 472
NF E22-165
BS 3673-4

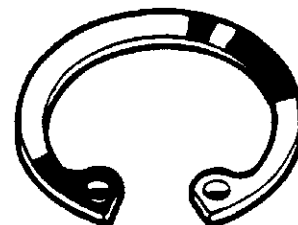

Informacje techniczne

Wymiar nominalny otworu d_1	Pierścień d_3	Pierścień d_4	Pierścień s	Rowek d_2	Rowek m (H13)	Rowek n (min.)
8	8.7	3	0.8	8.4	0.9	0.6
9	9.8	3.7	0.8	9.4	0.9	0.6
10	10.8	3.3	1	10.4	1.1	0.6
11	11.8	4.1	1	11.4	1.1	0.6
12	13	4.9	1	12.5	1.1	0.8
13	14.1	5.4	1	13.6	1.1	0.9
14	15.1	6.2	1	14.6	1.1	0.9
15	16.2	7.2	1	15.7	1.1	1.1
16	17.3	8	1	16.8	1.1	1.2
17	18.3	8.8	1	17.8	1.1	1.2
18	19.5	9.4	1	19	1.1	1.5
19	20.5	10.4	1	20	1.1	1.5
20	21.5	11.2	1	21	1.1	1.5
21	22.5	12.2	1	22	1.1	1.5
22	23.5	13.2	1	23	1.1	1.5
23 (#DIN)	24.6	15.4	1.2	24.1	1.3	1.7
24	25.9	14.8	1.2	25.2	1.3	1.8
25	26.9	15.5	1.2	26.2	1.3	1.8
26	27.9	16.1	1.2	27.2	1.3	1.8
27 (#DIN)	29.1	18.2	1.2	28.4	1.3	2.1
28	30.1	17.9	1.2	29.4	1.3	2.1
29 (#DIN)	31.1	19.6	1.2	30.4	1.3	2.1
30	32.1	19.9	1.2	31.4	1.3	2.1
31	33.4	20	1.2	32.7	1.3	2.6
32	34.4	20.6	1.2	33.7	1.3	2.6
33 (#DIN)	35.5	22.2	1.2	34.7	1.3	2.6
34	36.5	22.6	1.5	35.7	1.6	2.6
35	37.8	23.6	1.5	37	1.6	3
36	38.8	24.6	1.5	38	1.6	3
37	39.8	25.4	1.5	39	1.6	3
38	40.8	26.4	1.5	40	1.6	3
39 (#DIN)	42	28.6	1.5	41	1.6	3
40	43.5	27.8	1.75	42.5	1.85	3.8
41 (#DIN)	44.5	29	1.75	43.5	1.85	3.8
42	45.5	29.6	1.75	44.5	1.85	3.8
43 (#DIN)	46.5	-	1.75	45.5	1.85	3.8
44 (#DIN)	47.5	32	1.75	46.5	1.85	3.8
45	48.5	32	1.75	47.5	1.85	3.8
46 (#DIN)	49.5	34.6	1.75	48.5	1.85	3.8
47	50.5	33.5	1.75	49.5	1.85	3.8
48	51.5	34.5	1.75	50.5	1.85	3.8
50	54.2	36.3	2	53	2.15	4.5
52	56.2	37.9	2	55	2.15	4.5
53 (#DIN)	57.2	40	2	56	2.15	4.5
54	58.2	41	2	57	2.15	4.5
55	59.2	40.7	2	58	2.15	4.5
56	60.2	41.7	2	59	2.15	4.5
57 (#DIN)	61.2	44	2	60	2.15	4.5
58	62.2	43.5	2	61	2.15	4.5
60	64.2	44.7	2	63	2.15	4.5
62	66.2	46.7	2	65	2.15	4.5
63	67.2	47.7	2	66	2.15	4.5
64 (#DIN)	68.2	48.7	2	67	2.65	4.5
65	69.2	49	2.5	68	2.65	4.5
67 (#DIN)	71.5	52	2.5	70	2.65	4.5
68	72.5	51.6	2.5	71	2.65	4.5
70	74.5	53.6	2.5	73	2.65	4.5

Informacje techniczne						
Wymiar nominalny otworu d_1	Pierścień d_3	Pierścień d_4	Pierścień s	Rowek d_2	Rowek m (H13)	Rowek n (min.)
72	76.5	55.6	2.5	75	2.65	4.5
75	79.5	58.6	2.5	78	2.65	4.5
77 (#DIN)	81.5	62	2.5	80	2.65	4.5
78	82.5	60.1	2.5	81	2.65	4.5
80	85.5	62.1	2.5	83.5	2.65	5.3
82	87.5	64.1	2.5	85.5	2.65	5.3
85	90.5	66.9	3	88.5	3.15	5.3
87 (#DIN)	92.5	69.8	3	90.5	3.15	5.3
88	93.5	69.9	3	91.5	3.15	5.3
90	95.5	71.9	3	93.5	3.15	5.3
92	97.5	73.3	3	95.5	3.15	5.3
95	100.5	76.5	3	98.5	3.15	5.3
97 (#DIN)	102.5	79.4	3	100.5	3.15	5.3
98	103.5	79	3	101.5	3.15	5.3
100	105.5	80.6	3	103.5	3.15	5.3
102	108	82	4	106	4.15	6
105	112	85	4	109	4.15	6
108	115	88	4	112	4.15	6
110	117	88.2	4	114	4.15	6
112	119	90	4	116	4.15	6
115	122	93	4	119	4.15	6
117 (#DIN)	124	97	4	121	4.15	6
120	127	96.9	4	124	4.15	6
125	132	101.9	4	129	4.15	6
130	137	106.9	4	134	4.15	6
135	142	111.5	4	139	4.15	6
140	147	116.5	4	144	4.15	6
145	152	121	4	149	4.15	6
150	158	124.8	4	155	4.15	7.5
155	164	129.8	4	160	4.15	7.5
160	169	132.7	4	165	4.15	7.5
165	174.5	137.7	4	170	4.15	7.5
170	179.5	141.6	4	175	4.15	7.5
172 (#DIN)	181.5	-	4	177	4.15	7.5
175	184.5	146.6	4	180	4.15	7.5
180	189.5	150.2	4	185	4.15	7.5
185	194.5	155.2	4	190	4.15	7.5
188 (#DIN)	197.5	-	4	193	4.15	7.5
190	199.5	160.2	4	195	4.15	7.5
195	204.5	165.2	4	200	4.15	7.5
200	209.5	170.2	4	205	4.15	7.5
210	222	180.2	5	216	5.15	9
215 (#DIN)	227	-	5	221	5.15	9
220	232	190.2	5	226	5.15	9
225 (#DIN)	237	-	5	231	5.15	9
230	242	200.2	5	236	5.15	9
240	252	210.2	5	246	5.15	9
250	262	220.2	5	256	5.15	9
260	275	226	5	268	5.15	12
270 (#DIN)	285	-	5	278	5.15	12
275 (#DIN)	290	241	5	283	5.15	12
280	295	246	5	288	5.15	12
290	305	256	5	298	5.15	12
300	315	266	5	308	5.15	12

Dane montażowe

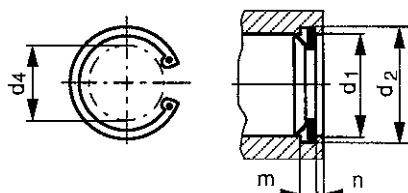

DETAIL X		
$d_1 \leq 300\text{mm.}$	$d_1 \geq 170\text{mm.}^{①}$	$d_1 \geq 25\text{mm.}^{①}$

① Zależy od producenta

Grupy katalogowe

Material	Kod	Strona
Stal sprężynowa EN 10132-4	36050	7-124
St.St.	51437	7-124

36050 Pierścienie osadcze wewnętrzne, typ normalny L07A

Material Stal sprężynowa EN 10132-4



Wymiar nominalny otworu d ₁	⊗	Kod artykułu	Wymiar nominalny otworu d ₁	⊗	Kod artykułu	Wymiar nominalny otworu d ₁	⊗	Kod artykułu
8MM	250	36050.008.001	45MM	50	36050.045.001	108MM	5	36050.108.001
9MM	250	36050.009.001	46MM	50	36050.046.001	110MM	5	36050.110.001
10MM	250	36050.010.001	47MM	50	36050.047.001	112MM	5	36050.112.001
11MM	250	36050.011.001	48MM	50	36050.048.001	115MM	5	36050.115.001
12MM	250	36050.012.001	50MM	50	36050.050.001	117MM	5	36050.117.001
13MM	100	36050.013.001	52MM	50	36050.052.001	120MM	5	36050.120.001
14MM	100	36050.014.001	53MM	25	36050.053.001	125MM	5	36050.125.001
15MM	100	36050.015.001	54MM	25	36050.054.001	130MM	5	36050.130.001
16MM	100	36050.016.001	55MM	25	36050.055.001	135MM	5	36050.135.001
17MM	100	36050.017.001	56MM	25	36050.056.001	140MM	5	36050.140.001
18MM	100	36050.018.001	57MM	25	36050.057.001	145MM	5	36050.145.001
19MM	100	36050.019.001	58MM	25	36050.058.001	150MM	3	36050.150.001
20MM	100	36050.020.001	60MM	25	36050.060.001	155MM	3	36050.155.001
21MM	100	36050.021.001	62MM	25	36050.062.001	160MM	3	36050.160.001
22MM	100	36050.022.001	63MM	25	36050.063.001	165MM	3	36050.165.001
23MM	100	36050.023.001	64MM	25	36050.064.001	170MM	3	36050.170.001
24MM	100	36050.024.001	65MM	10	36050.065.001	172MM	3	36050.172.001
25MM	100	36050.025.001	67MM	10	36050.067.001	175MM	2	36050.175.001
26MM	100	36050.026.001	68MM	10	36050.068.001	180MM	2	36050.180.001
27MM	100	36050.027.001	70MM	10	36050.070.001	185MM	2	36050.185.001
28MM	100	36050.028.001	72MM	10	36050.072.001	190MM	2	36050.190.001
29MM	100	36050.029.001	75MM	10	36050.075.001	195MM	2	36050.195.001
30MM	100	36050.030.001	77MM	10	36050.077.001	200MM	2	36050.200.001
31MM	100	36050.031.001	78MM	10	36050.078.001	210MM	2	36050.210.001
32MM	100	36050.032.001	80MM	10	36050.080.001	215MM	2	36050.215.001
33MM	100	36050.033.001	82MM	10	36050.082.001	220MM	2	36050.220.001
34MM	100	36050.034.001	85MM	5	36050.085.001	225MM	2	36050.225.001
35MM	100	36050.035.001	87MM	5	36050.087.001	230MM	2	36050.230.001
36MM	100	36050.036.001	88MM	5	36050.088.001	240MM	2	36050.240.001
37MM	100	36050.037.001	90MM	5	36050.090.001	250MM	2	36050.250.001
38MM	100	36050.038.001	92MM	5	36050.092.001	260MM	2	36050.260.001
39MM	100	36050.039.001	95MM	5	36050.095.001	270MM	2	36050.270.001
40MM	50	36050.040.001	97MM	5	36050.097.001	275MM	2	36050.275.001
41MM	50	36050.041.001	98MM	5	36050.098.001	280MM	2	36050.280.001
42MM	50	36050.042.001	100MM	5	36050.100.001	290MM	2	36050.290.001
43MM	50	36050.043.001	102MM	5	36050.102.001	300MM	2	36050.300.001
44MM	50	36050.044.001	105MM	5	36050.105.001			

- W zależności od dostępności może być dostarczony typ fosfatowany. Typ powiększony jest dostępny tylko na zamówienie.
- Ostrzeżenie: cynkowanie elektrolityczne tych produktów może spowodować kruchość wodorową.

51437 Pierścienie osadcze wewnętrzne, typ normalny R09A

Material Stal nierdzewna DIN ≈472



Wymiar nominalny otworu d ₁	⊗	Kod artykułu	Wymiar nominalny otworu d ₁	⊗	Kod artykułu	Wymiar nominalny otworu d ₁	⊗	Kod artykułu
8MM	100	51437.008.001	23MM	50	51437.023.001	38MM	25	51437.038.001
9MM	100	51437.009.001	24MM	50	51437.024.001	39MM	25	51437.039.001
10MM	100	51437.010.001	25MM	25	51437.025.001	40MM	10	51437.040.001
11MM	100	51437.011.001	26MM	25	51437.026.001	41MM*	25	51437.041.001
12MM	100	51437.012.001	27MM	25	51437.027.001	42MM	10	51437.042.001
13MM	50	51437.013.001	28MM	25	51437.028.001	43MM*	25	51437.043.001
14MM	50	51437.014.001	29MM	25	51437.029.001	44MM*	25	51437.044.001
15MM	50	51437.015.001	30MM	25	51437.030.001	45MM	10	51437.045.001
16MM	50	51437.016.001	31MM*	25	51437.031.001	47MM	10	51437.047.001
17MM	50	51437.017.001	32MM	25	51437.032.001	48MM	10	51437.048.001
18MM	50	51437.018.001	33MM	25	51437.033.001	50MM	5	51437.050.001
19MM	50	51437.019.001	34MM	25	51437.034.001	52MM	5	51437.052.001
20MM	50	51437.020.001	35MM	25	51437.035.001	55MM	5	51437.055.001
21MM	50	51437.021.001	36MM	25	51437.036.001	58MM	5	51437.058.001
22MM	50	51437.022.001	37MM	25	51437.037.001	60MM	5	51437.060.001

51437 Pierścienie osadcze wewnętrzne, typ normalny								
Wymiar nominalny otworu d_1	☒	Kod artykułu	Wymiar nominalny otworu d_1	☒	Kod artykułu	Wymiar nominalny otworu d_1	☒	Kod artykułu
62MM	5	51437.062.001	75MM	5	51437.075.001	100MM	1	51437.100.001
65MM	5	51437.065.001	80MM	5	51437.080.001	105MM*	10	51437.105.001
68MM	5	51437.068.001	85MM	1	51437.085.001	110MM*	10	51437.110.001
70MM	5	51437.070.001	90MM	1	51437.090.001	112MM*	10	51437.112.001
72MM	5	51437.072.001	95MM	1	51437.095.001	140MM*	10	51437.140.001

- Pierścienie osadcze ze stali nierdzewnej zrobione są ze stali martenzytowej.
- Przy montowaniu należy używać szczypliec montażowych ze śrubą w celu ograniczenia otwierania-zamykania pierścienia.
- Zalecane jest, aby aplikować minimalne ilości na trzonku lub oprawie jeżeli aplikacja tego wymaga.
- Należy unikać kontaktu z płynami zawierającymi chlor aby zredukować możliwość wystąpienia pęknięcia korozyjnego.

Płytki osadcze sprężynujące zewnętrzne

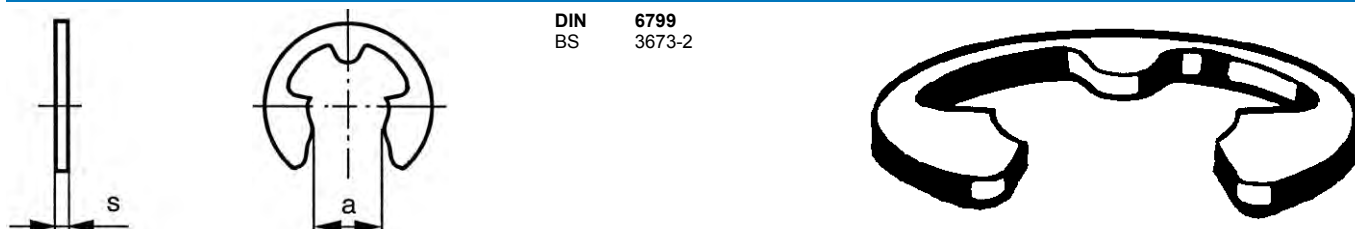

Informacje techniczne

Wymiar nominalny rowka d_2 (h11)	Pierścień a	Pierścień d_3 (maks.)	Pierścień s	Rowek m	Rowek n (min.)	Zakres d_1
1.2	1.01	3.25	0.3	0.34	0.6	1.4-2
1.5	1.28	4.25	0.4	0.44	0.8	2-2.5
1.9	1.61	4.8	0.5	0.54	1	2.5-3
2.3	1.94	6.3	0.6	0.64	1	3-4
3.2	2.7	7.3	0.6	0.64	1	4-5
4	3.34	9.3	0.7	0.74	1.2	5-7
5	4.11	11.3	0.7	0.74	1.2	6-8
6	5.26	12.3	0.7	0.74	1.2	7-9
7	5.84	14.3	0.9	0.94	1.5	8-11
8	6.52	16.3	1	1.05	1.8	9-12
9	7.63	18.8	1.1	1.15	2	10-14
10	8.32	20.4	1.2	1.25	2	11-15
12	10.45	23.4	1.3	1.35	2.5	13-18
15	12.61	29.4	1.5	1.55	3	16-24
19	15.92	37.6	1.75	1.8	3.5	20-31
24	21.88	44.6	2	2.05	4	25-38

- W zależności od dostępności może być dostarczony typ fosfatowany.

Dane montażowe

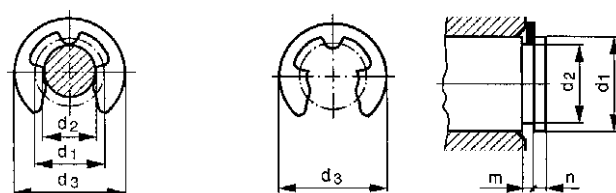



Grupy katalogowe

Material	Kod	Strona
Stal sprężynowa 460-580 HV	36200	7-126
St.St.	51440	7-126

36200 **Płytki osadcze sprężynujące zewnętrzne** **L07A**

Materiał Stal sprężynowa 460-580 HV

Wymiar nominalny rowka d ₂ (h11)	☒	Kod artykułu	Wymiar nominalny rowka d ₂ (h11)	☒	Kod artykułu	Wymiar nominalny rowka d ₂ (h11)	☒	Kod artykułu
1,2MM	500	36200.012.001	5MM	500	36200.050.001	10MM	250	36200.100.001
1,5MM	500	36200.015.001	6MM	500	36200.060.001	12MM	100	36200.120.001
1,9MM	500	36200.019.001	7MM	250	36200.070.001	15MM	100	36200.150.001
2,3MM	500	36200.023.001	8MM	250	36200.080.001	19MM	100	36200.190.001
3,2MM	500	36200.032.001	9MM	250	36200.090.001	24MM	100	36200.240.001
4MM	500	36200.040.001						

• Ostrzeżenie: cynkowanie elektrolityczne tych produktów może wywołać kruchość wodorową.

51440 **Płytki osadcze sprężynujące zewnętrzne** **R09A**

Materiał Stal nierdzewna



Wymiar nominalny rowka d ₂ (h11)	☒	Kod artykułu	Wymiar nominalny rowka d ₂ (h11)	☒	Kod artykułu	Wymiar nominalny rowka d ₂ (h11)	☒	Kod artykułu
1,2MM	500	51440.012.001	5MM	250	51440.050.001	10MM	100	51440.100.001
1,5MM	500	51440.015.001	6MM	250	51440.060.001	12MM	100	51440.120.001
1,9MM	500	51440.019.001	7MM	250	51440.070.001	15MM	100	51440.150.001
2,3MM	250	51440.023.001	8MM	250	51440.080.001	19MM	100	51440.190.001
3,2MM	250	51440.032.001	9MM	100	51440.090.001	24MM	100	51440.240.001
4MM	250	51440.040.001						

Pierścienie osadcze sprężynujące zewnętrzne

DIN 7993 A

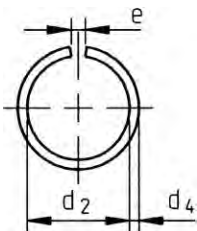

Informacje techniczne

Wymiar nominalny wałka d ₁	d ₂	d ₃	d ₄	e ≈	r
6	5.1	5.2	0.8	1	0.5
8	7.1	7.2	0.8	2	0.5
10	9.1	9.2	0.8	2	0.5
12	10.8	11	1	3	0.6
14	12.8	13	1	3	0.6
16	14.2	14.4	1.6	3	0.9
20	17.7	18	2	3	1.1
22	19.7	20	2	3	1.1
24	21.7	22	2	3	1.1
25	22.7	23	2	3	1.1
26	23.7	24	2	3	1.1
28	25.7	26	2	3	1.1
30	27.7	28	2	3	1.1
32	29.1	29.5	2.5	4	1.4
35	32.1	32.5	2.5	4	1.4
38	35.1	35.5	2.5	4	1.4
40	37.1	37.5	2.5	4	1.4
45	42	42.5	2.5	4	1.4
48	45	45.5	2.5	4	1.4
50	47	47.5	2.5	4	1.4
55	51.1	51.8	3.2	4	1.8
60	56.1	56.8	3.2	4	1.8
65	61.1	61.8	3.2	4	1.8
70	66	66.8	3.2	5	1.8
75	71	71.8	3.2	5	1.8

Informacje techniczne

Wymiar nominalny wałka d_1	d_2	d_3	d_4	$e \approx$	r
80	76	76.8	3.2	5	1.8
85	81	81.8	3.2	5	1.8
90	86	86.8	3.2	5	1.8
105	100.8	101.8	3.2	5	1.8
110	105.8	106.8	3.2	5	1.8
120	115.8	116.8	3.2	5	1.8

Kolejność montażu

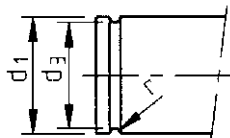

36215 Pierścienie osadcze sprężynujące zewnętrzne

L07A

Materiał Stal sprężynowa



Wymiar nominalny wałka d_1	☒	Kod artykułu	Wymiar nominalny wałka d_1	☒	Kod artykułu	Wymiar nominalny wałka d_1	☒	Kod artykułu
6MM	250	36215.006.001	28MM	100	36215.028.001	60MM	25	36215.060.001
8MM	100	36215.008.001	30MM	100	36215.030.001	65MM	10	36215.065.001
10MM	250	36215.010.001	32MM	100	36215.032.001	70MM	10	36215.070.001
12MM	250	36215.012.001	35MM	100	36215.035.001	75MM	10	36215.075.001
14MM	100	36215.014.001	38MM	100	36215.038.001	80MM	10	36215.080.001
16MM	100	36215.016.001	40MM	50	36215.040.001	85MM	5	36215.085.001
20MM	100	36215.020.001	45MM	50	36215.045.001	90MM	5	36215.090.001
22MM	100	36215.022.001	48MM	50	36215.048.001	105MM	5	36215.105.001
24MM	100	36215.024.001	50MM	50	36215.050.001	110MM	5	36215.110.001
25MM	100	36215.025.001	55MM	25	36215.055.001	120MM	5	36215.120.001
26MM	100	36215.026.001						

- Ostrzeżenie: cynkowanie elektrolityczne tych produktów może wywołać kruchość wodorową.

Podkładki ustalające zewnętrzne z zaślepką, typ A

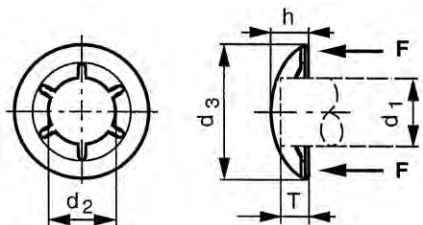

Informacje techniczne

Dla wałka d ₁ (h11)	d ₂ (maks.)	d ₃	F-1	h	T (maks.)
2	1.84	10.6	200	3	2.5
3	2.81	10.6	200	3	2.5
4	3.8	12.4	400	3.8	3
5	4.74	12.4	400	3.8	3
6	5.7	16.2	800	5	4
8	7.66	16.2	800	5	4
10	9.74	19.7	1 000	5.9	4.5
12	11.62	26	2 500	7.5	6
13	12.64	26	2 500	7.5	6
14	13.65	29.4	2 500	9	7
15	14.68	39.4	2 500	9	7
16	15.53	29.4	2 500	9	7
17	16.78	29.4	2 500	9	7
19	18.68	38.2	3 500	11.7	8.7
20	19.63	38.2	3 500	11.7	8.7
25	24.63	43.4	3 850	13.75	9.5

F-1 = dopuszczalne obciążenie w Newtonach (trzonek St 37).

Grupy katalogowe

Materiał	Obróbka powierzchni	Kod	Strona
Stal sprężynowa	Brązowany i pokostowany	36233	7-128
St.St.		51446	7-128

36233 Podkładki ustalające zewnętrzne z zaślepką, typ A

L07B

Materiał Stal sprężynowa
Obróbka powierzchni Brązowany i pokostowany



Dla wałka d ₁	☒	Kod artykułu	Dla wałka d ₁	☒	Kod artykułu	Dla wałka d ₁	☒	Kod artykułu
3MM	250	36233.030.001	6MM	250	36233.060.001	12MM	250	36233.120.001
4MM	250	36233.040.001	8MM	250	36233.080.001	16MM	100	36233.160.001
5MM	250	36233.050.001	10MM	250	36233.100.001	20MM	100	36233.200.001

51446 Podkładki ustalające zewnętrzne z zaślepką, typ A

R09A

Materiał Stal nierdzewna



Dla wałka d ₁	☒	Kod artykułu	Dla wałka d ₁	☒	Kod artykułu	Dla wałka d ₁	☒	Kod artykułu
3MM	100	51446.030.001	6MM	100	51446.060.001	12MM	100	51446.120.001
4MM	100	51446.040.001	8MM	100	51446.080.001	14MM	100	51446.140.001
5MM	100	51446.050.001	10MM	100	51446.100.001			

Podkładki ustalające zewnętrzne z zaślepką, typ 4A

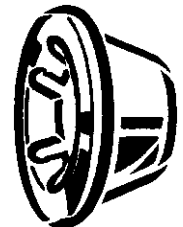
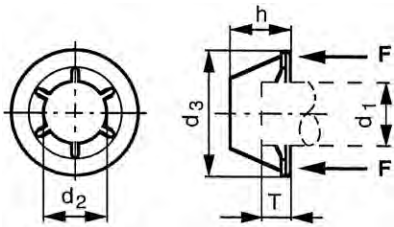

Informacje techniczne

Dla wałka d ₁ (h11)	4	5	6	8	10
d ₂ (maks.)	3.8	4.74	5.7	7.66	9.74
d ₃	12.3	12.3	16.2	16.2	19.7
F-1	400	400	800	800	1 000
h	5.7	5.7	7.2	7.2	8.1
T (maks.)	5.3	5.3	6.7	6.7	7.8

- F-1 = dopuszczalne obciążenie w Newtonach (trzonek St 37).

36239 Podkładki ustalające zewnętrzne z zaślepką, typ 4A

L07B

Materiał Stal sprężynowa
Obróbka powierzchni Brązowany i pokostowany



Dla wałka d1	☒	Kod artykułu	Dla wałka d1	☒	Kod artykułu	Dla wałka d1	☒	Kod artykułu
4MM	250	36239.040.001	6MM	250	36239.060.001	10MM	250	36239.100.001
5MM	250	36239.050.001	8MM	250	36239.080.001			

- Ostrzeżenie: cynkowanie elektrolityczne tych produktów może wywołać kruchość wodorową.

Narzędzia instalacyjne do podkładek ustalających, uchwyty

7



- Instalacja nasadkami magnetycznymi, grupa artykułów 36251 i 36252.

36250 Narzędzia instalacyjne do podkładek ustalających, uchwyt uniwersalny

L07B



Typ	☒	Kod artykułu
HANDLE	1	36250.001.770

Narzędzia instalacyjne do podkładek ustalających, nasadki magnetyczne



Grupy katalogowe

	Kod	Strona
Nasadka magnetyczna	36251	7-130
Nasadka magnetyczna	36252	7-130

36251 Narzędzia instalacyjne do podkładek ustalających, nasadki magnetyczne

L07B



Typ	☒	Kod artykułu	Typ	☒	Kod artykułu	Typ	☒	Kod artykułu
1,6-3,2MM	1	36251.016.032	9,0-11,0MM	1	36251.090.110	18,0-23,0MM	1	36251.180.230
4,0-5,0MM	1	36251.040.050	12,0-13,0MM	1	36251.120.130	24,0-25,0MM	1	36251.240.250
6,0-8,0MM	1	36251.060.080	14,0-17,0MM	1	36251.140.170			

- Odpowiednie do instalacji podkładek ustalających zewnętrznych bez zaślepki, wykonanych ze stali sprężynowej.
- Instalacja przy pomocy uchwytu, grupa artykułów 36250.
- Wałek 6,0-8,0 mm: odpowiedni również do podkładek ustalających zewnętrznych z zaślepką typu 4A, wykonanych ze stali sprężynowej i stali nierdzewnej: 4,0 mm - 5,0 mm.
- Wałek 6,0-8,0 mm: odpowiedni również do podkładek ustalających zewnętrznych z zaślepką typu 4A, wykonanych ze stali sprężynowej i stali nierdzewnej: 6,0 mm - 9,0 mm.
- Wałek 6,0-8,0 mm: odpowiedni również do podkładek ustalających zewnętrznych z zaślepką typu 4A, wykonanych ze stali sprężynowej i stali nierdzewnej: 10,0 mm - 11,0 mm.

36252 Narzędzia instalacyjne do podkładek ustalających, nasadki magnetyczne

L07B



Typ	☒	Kod artykułu	Typ	☒	Kod artykułu	Typ	☒	Kod artykułu
1,6-3,2MM	1	36252.016.032	9,0-11,0MM	1	36252.090.110	14,0-17,0MM	1	36252.140.170
4,0-5,0MM	1	36252.040.050	12,0-13,0MM	1	36252.120.130	18,0-22,0MM	1	36252.180.220
6,0-8,0MM	1	36252.060.080						

- Odpowiedni do instalacji podkładek ustalających zewnętrznych z zaślepką typu 4A, wykonanych ze stali sprężynowej i stali nierdzewnej.
- Instalacja przy pomocy rączki, grupa artykułów 36250.

7

Podkładki ustalające przelotowe

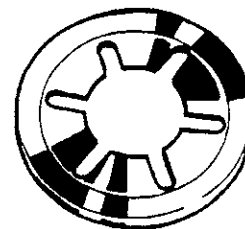
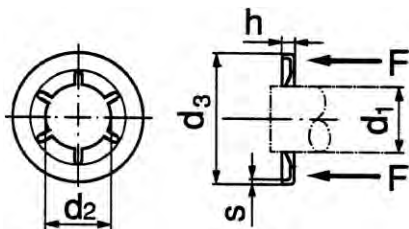

Informacje techniczne

Dł. wałka d ₁ (h11)	d ₂ (maks.)	d ₃	F-1	h	s
2	1.84	9.7	200	1.3	0.2
3	2.81	9.7	200	1.3	0.2
4	3.8	11.5	400	1.3	0.2
5	4.74	11.5	400	1.3	0.2
6	5.7	15.3	800	1.3	0.25
6.35	6.08	15.3	800	1.3	0.25
7	6.72	15.3	800	1.3	0.25
8	7.66	15.3	800	1.3	0.25
9	8.75	18.4	1 000	1.9	0.3
10	9.74	18.4	1 000	1.9	0.3
11	10.76	18.4	1 000	1.9	0.3
12	11.62	25	2 500	2.3	0.4
13	12.64	25	2 500	2.3	0.4
14	13.66	28.2	2 500	2.3	0.4
15	14.68	28.2	2 500	2.3	0.4
16	15.53	28.2	2 500	2.3	0.4
17	16.68	28.2	2 500	2.3	0.4
18	17.62	36.6	3 500	3	0.4
19	18.69	36.6	3 850	3	0.4
20	19.63	36.6	3 850	3	0.4
24	23.66	41.4	3 850	3.2	0.5
25	24.63	41.4	3 850	3.2	0.5

- F-1 = dopuszczalne obciążenie w Newtonach (trzonek St 37).

7

Grupy katalogowe

Material	Obróbka powierzchni	Kod	Strona
Stal sprężynowa	Brązowany i pokostowany	36230	7-131
St.St.		51445	7-132

36230 Podkładki ustalające przelotowe

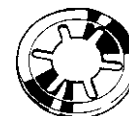

L07B

Material Stal sprężynowa
Obróbka powierzchni Brązowany i pokostowany



Dł. wałka d1	☒	Kod artykułu	Dł. wałka d1	☒	Kod artykułu	Dł. wałka d1	☒	Kod artykułu
2MM	500	36230.020.001	9MM	250	36230.090.001	16MM	100	36230.160.001
3MM	500	36230.030.001	10MM	250	36230.100.001	17MM	100	36230.170.001
4MM	500	36230.040.001	11MM	250	36230.110.001	18MM	100	36230.180.001
5MM	500	36230.050.001	12MM	250	36230.120.001	19MM	100	36230.190.001
6MM	500	36230.060.001	13MM	100	36230.130.001	20MM	100	36230.200.001
6,35MM	500	36230.063.501	14MM	100	36230.140.001	24MM	50	36230.240.001
7MM	250	36230.070.001	15MM	100	36230.150.001	25MM	50	36230.250.001
8MM	250	36230.080.001						

- Ostrzeżenie: cynkowanie elektrolityczne tych produktów może wywołać kruchość wodorową.

51445	Podkładki ustalające przelotowe	R09A
Materiał	Stal nierdzewna	
		

Dł. wałka d ₁	☒	Kod artykułu	Dł. wałka d ₁	☒	Kod artykułu	Dł. wałka d ₁	☒	Kod artykułu
3MM	100	51445.030.001	6MM	100	51445.060.001	10MM	100	51445.100.001
4MM	100	51445.040.001	8MM	100	51445.080.001	12MM	100	51445.120.001
5MM	100	51445.050.001						

Zaciski do śrub i wałków, typ SL

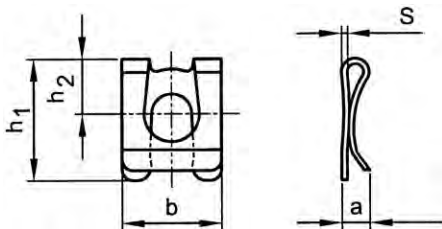



Informacje techniczne

Wymiar nominalny wałka d ₁	a	b	d ₂ (h11)	h ₁	h ₂	m	n	s	z
4	2.2	7	3.2	8.5	4	0.64	2	0.3	0.5
5	2.7	9	4	10.8	5	0.74	2.5	0.35	0.5
6	3.2	11	5	14	6	0.74	3	0.4	0.75
8	3.7	14	6	17.5	8	0.94	3.5	0.45	1
10	4.7	18	8	22	10	1.05	4.5	0.5	1
12	5.5	22	9	26	12	11.5	5	0.5	1.25
14	5.7	25	10	30	13.5	1.25	5.5	0.6	1.5
16	6.8	28	12	34.5	16	1.35	6	0.6	1.5

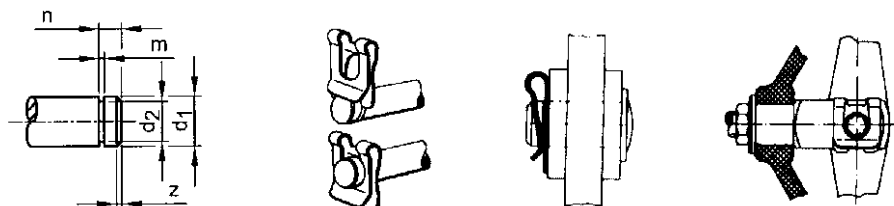
Dane montażowe / Przykład zastosowania



7

36265	Zaciski do śrub i wałków, typ SL	L07A
Materiał	Stal sprężynowa	
Obróbka powierzchni	Ocynkowane	

Wymiar nominalny wałka d ₁	☒	Kod artykułu	Wymiar nominalny wałka d ₁	☒	Kod artykułu	Wymiar nominalny wałka d ₁	☒	Kod artykułu
4MM	500	36265.040.001	8MM	200	36265.080.001	14MM	100	36265.140.001
5MM	500	36265.050.001	10MM	200	36265.100.001	16MM	100	36265.160.001
6MM	500	36265.060.001	12MM	200	36265.120.001			

Pierścienie osadcze zaciskowe

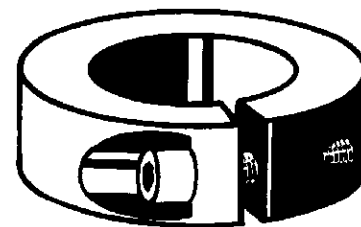
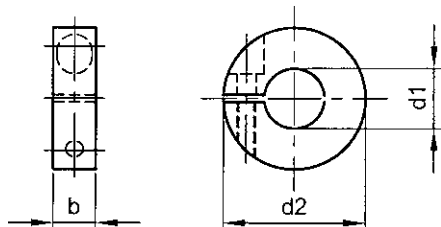

Informacje techniczne

d ₁	b	d ₂	Rozmiar śruby	d ₁	b	d ₂	Rozmiar śruby
8	10	25	M4x15	25	12	50	M5x20
10	10	32	M4x15	30	12	56	M5x20
12	10	32	M4x15	35	12	63	M5x20
15	12	40	M5x20	40	14	70	M6x20
16	12	40	M5x20	45	14	80	M6x20
20	12	45	M5x20	50	14	80	M6x20

- Cechy szczególne pierścieni osadczych zaciskowych:
- Prosty montaż, niskie obciążenie wałka.
- Prosty demontaż i możliwość precyzyjnego pozycjonowania.
- Wałek pozostaje nieuszkodzony z uwagi na brak deformacji metalu podczas dokręcania.
- Równy rozdział siły zaciskowej po całym obwodzie

37840 Pierścienie osadcze zaciskowe ze śrubą z łbem walcowym

L07F

Materiał Stal automatowa



d ₁ x d ₂ x b	☒	Kod artykułu	d ₁ x d ₂ x b	☒	Kod artykułu	d ₁ x d ₂ x b	☒	Kod artykułu
8X25X10MM	10	37840.080.001	16X40X12MM	5	37840.160.001	35X63X12MM	2	37840.350.001
10X32X10MM	10	37840.100.001	20X45X12MM	5	37840.200.001	40X70X14MM	2	37840.400.001
12X32X10MM	5	37840.120.001	25X50X12MM	5	37840.250.001	45X80X14MM	2	37840.450.001
15X40X12MM	5	37840.150.001	30X56X12MM	5	37840.300.001	50X80X14MM	2	37840.500.001

Pierścienie osadcze zaciskowe

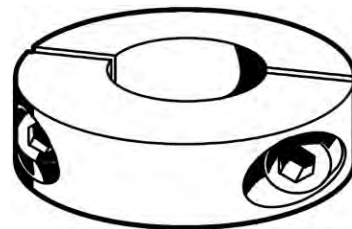
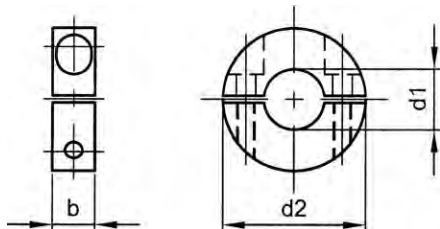

Informacje techniczne

d ₁ (H8)	b (j14)	d ₂ (H13)	d ₁ (H8)	b (j14)	d ₂ (H13)
8	10	25	25	12	50
10	10	332	30	12	56
12	10	32	35	12	63
15	12	40	40	14	70
16	12	40	45	14	80
20	12	45	50	14	80

37845 Pierścienie osadcze zaciskowe z dwoma śrubami z łbem walcowym

L07F

Materiał Stal automatowa



d ₁ x d ₂ x b	☒	Kod artykułu	d ₁ x d ₂ x b	☒	Kod artykułu	d ₁ x d ₂ x b	☒	Kod artykułu
8X25X10MM	10	37845.080.001	16X40X12MM	5	37845.160.001	35X63X12MM	2	37845.350.001
10X32X10MM	10	37845.100.001	20X45X12MM	5	37845.200.001	40X70X14MM	2	37845.400.001
12X32X10MM	5	37845.120.001	25X50X12MM	5	37845.250.001	45X80X14MM	2	37845.450.001
15X40X12MM	5	37845.150.001	30X56X12MM	5	37845.300.001	50X80X14MM	2	37845.500.001

Pierścień osadczy ze śrubą dociskową

DIN 705A

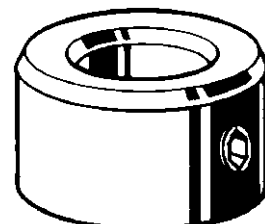
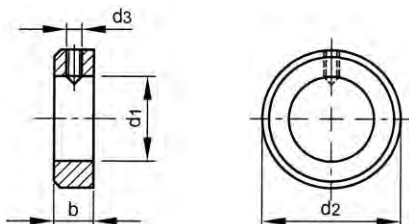

Informacje techniczne

d ₁ (H8)	b (js14)	d ₂ (h13)	d ₃	d ₁ (H8)	b (js14)	d ₂ (h13)	d ₃
3	5	7	M2	30	16	45	M8
4	5	8	M2.5	32	16	50	M8
5	6	10	M3	34 (#DIN)	16	50	M8
6	8	12	M4	35	16	56	M8
7	8	12	M4	36	16	56	M8
8	8	16	M4	38 (#DIN)	16	56	M8
9 (#DIN)	10	18	M5	40	18	63	M10
10	10	20	M5	42 (#DIN)	18	63	M10
11 (#DIN)	10	20	M5	45	18	70	M10
12	12	22	M6	48 (#DIN)	18	70	M10
13 (#DIN)	12	22	M6	50	18	80	M10
14	12	25	M6	55	18	80	M10
15	12	25	M6	56	18	80	M10
16	12	28	M6	58 (#DIN)	20	90	M10
18	14	32	M6	60	20	90	M10
20	14	32	M6	63	20	90	M10
22	14	36	M6	65	20	100	M10
24	16	40	M8	70	20	100	M10
25	16	40	M8	75	22	110	M12
26	16	40	M8	80	22	110	M12
28	16	45	M8				

Grupy katalogowe

Material	Obróbka powierzchni		Kod	Strona
Stal automatowa		z gniazd. 6-kał. ISO 4029	37810	7-135
Stal automatowa		z rowkiem EN 27434	37815	7-135
Stal automatowa	Ocynk.	z gniazd. 6-kał. ISO 4029	37820	7-135
St.St. A1		z gniazd. 6-kał. ISO 4029	51370	7-136
St.St. A1		z rowkiem EN 27434	51372	7-136
St.St. A2		z ISO 4027	51371	7-136

37810 Pierścienie osadcze ze śrubą dociskową z gniazdem sześciokątnym DIN 705A/ISO 4029 (DIN 916)

L07F

Material	Stal automatowa	DIN	705A/4029
		NEN	- /2343
		NF	- /E27-183
		BS	- /4168-5

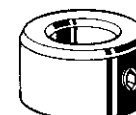

$d_1 \times d_2 \times b$	☒	Kod artykułu	$d_1 \times d_2 \times b$	☒	Kod artykułu	$d_1 \times d_2 \times b$	☒	Kod artykułu
3X7X5MM	50	37810.030.001	18X32X14MM	10	37810.180.001	42X63X18MM	5	37810.420.001
4X8X5MM	50	37810.040.001	20X32X14MM	10	37810.200.001	45X70X18MM	5	37810.450.001
5X10X6MM	50	37810.050.001	22X36X14MM	10	37810.220.001	48X70X18MM	5	37810.480.001
6X12X8MM	50	37810.060.001	24X40X16MM	10	37810.240.001	50X80X18MM	5	37810.500.001
7X12X8MM	50	37810.070.001	25X40X16MM	10	37810.250.001	55X80X18MM	1	37810.550.001
8X16X8MM	50	37810.080.001	26X40X16MM	10	37810.260.001	56X80X18MM	1	37810.560.001
9X18X10MM	25	37810.090.001	28X45X16MM	10	37810.280.001	58X90X20MM	1	37810.580.001
10X20X10MM	25	37810.100.001	30X45X16MM	10	37810.300.001	60X90X20MM	1	37810.600.001
11X20X10MM	25	37810.110.001	32X50X16MM	10	37810.320.001	63X90X20MM	1	37810.630.001
12X22X12MM	10	37810.120.001	34X50X16MM	5	37810.340.001	65X100X20MM	1	37810.650.001
13X22X12MM	10	37810.130.001	35X56X16MM	5	37810.350.001	70X100X20MM	1	37810.700.001
14X25X12MM	10	37810.140.001	36X56X16MM	5	37810.360.001	75X110X22MM	1	37810.750.001
15X25X12MM	10	37810.150.001	38X56X16MM	5	37810.380.001	80X110X22MM	1	37810.800.001
16X28X12MM	10	37810.160.001	40X63X18MM	5	37810.400.001			

37815 Pierścienie osadcze ze śrubą dociskową z rowkiem DIN 705A/EN 27434 (DIN 553)

L07F

Material	Stal automatowa	DIN	705A/27434
-----------------	-----------------	------------	-------------------



$d_1 \times d_2 \times b$	☒	Kod artykułu	$d_1 \times d_2 \times b$	☒	Kod artykułu	$d_1 \times d_2 \times b$	☒	Kod artykułu
3X7X5MM	50	37815.030.001	18X32X14MM	10	37815.180.001	40X63X18MM	5	37815.400.001
4X8X5MM	50	37815.040.001	20X32X14MM	10	37815.200.001	42X63X18MM	5	37815.420.001
5X10X6MM	50	37815.050.001	22X36X14MM	10	37815.220.001	45X70X18MM	5	37815.450.001
6X12X8MM	50	37815.060.001	24X40X16MM	10	37815.240.001	48X70X18MM	5	37815.480.001
7X12X8MM	50	37815.070.001	25X40X16MM	10	37815.250.001	50X80X18MM	5	37815.500.001
8X16X8MM	50	37815.080.001	26X40X16MM	10	37815.260.001	55X80X18MM	1	37815.550.001
9X18X10MM	25	37815.090.001	28X45X16MM	10	37815.280.001	58X90X20MM	1	37815.580.001
10X20X10MM	25	37815.100.001	30X45X16MM	10	37815.300.001	60X90X20MM	1	37815.600.001
11X20X10MM	25	37815.110.001	32X50X16MM	10	37815.320.001	63X90X20MM	1	37815.630.001
12X22X12MM	10	37815.120.001	34X50X16MM	5	37815.340.001	65X100X20MM	1	37815.650.001
14X25X12MM	10	37815.140.001	35X56X16MM	5	37815.350.001	70X100X20MM	1	37815.700.001
15X25X12MM	10	37815.150.001	36X56X16MM	5	37815.360.001	75X110X22MM	1	37815.750.001
16X28X12MM	10	37815.160.001	38X56X16MM	5	37815.380.001	80X110X22MM	1	37815.800.001

37820 Pierścienie osadcze ze śrubą dociskową z gniazdem sześciokątnym DIN 705A/ISO 4029 (DIN 916)

L07F

Material	Stal automatowa	DIN	705A/4029
Obróbka powierzchni	Ocynkowane	NEN	- /2343
		NF	- /E27-183
		BS	- /4168-5

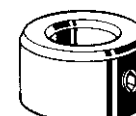

$d_1 \times d_2 \times b$	☒	Kod artykułu	$d_1 \times d_2 \times b$	☒	Kod artykułu	$d_1 \times d_2 \times b$	☒	Kod artykułu
5X10X6MM	50	37820.050.001	16X28X12MM	10	37820.160.001	30X45X16MM	10	37820.300.001
6X12X8MM	50	37820.060.001	18X32X14MM	10	37820.180.001	35X56X16MM	5	37820.350.001
8X16X8MM	50	37820.080.001	20X32X14MM	10	37820.200.001	40X63X18MM	5	37820.400.001
10X20X10MM	25	37820.100.001	22X36X14MM	10	37820.220.001	45X70X18MM	5	37820.450.001
12X22X12MM	10	37820.120.001	25X40X16MM	10	37820.250.001	50X80X18MM	5	37820.500.001
14X25X12MM	10	37820.140.001	26X40X16MM	10	37820.260.001	60X90X20MM	1	37820.600.001
15X25X12MM	10	37820.150.001	28X45X16MM	10	37820.280.001	70X100X20MM	1	37820.700.001

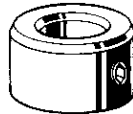
51370	Pierścienie osadcze ze śrubą dociskową z gniazdem sześciokątnym DIN 705A/ISO 4029 (DIN 916)	R09A
Materiał	Stal nierdzewna A1	DIN 705A/4029 NEN - /2343 NF - /E27-183 BS - /4168-5
		
		

d₁ x d₂ x b	☒	Kod artykułu	d₁ x d₂ x b	☒	Kod artykułu	d₁ x d₂ x b	☒	Kod artykułu
5X10X6MM	25	51370.050.001	16X28X12MM	5	51370.160.001	35X56X16MM	2	51370.350.001
6X12X8MM	25	51370.060.001	18X32X14MM	5	51370.180.001	36X56X16MM	1	51370.360.001
8X16X8MM	25	51370.080.001	20X32X14MM	5	51370.200.001	40X63X18MM	1	51370.400.001
10X20X10MM	10	51370.100.001	22X36X14MM	5	51370.220.001	45X70X18MM	1	51370.450.001
12X22X12MM	10	51370.120.001	25X40X16MM	5	51370.250.001	50X80X18MM	1	51370.500.001
14X25X12MM	10	51370.140.001	28X45X16MM	2	51370.280.001	60X90X20MM	1	51370.600.001
15X25X12MM	10	51370.150.001	30X45X16MM	2	51370.300.001			

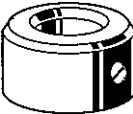
51372	Pierścienie osadcze ze śrubą dociskową z rowkiem DIN ≈705A/EN 27434 (DIN 553)	R09A
Materiał	Stal nierdzewna A1	DIN ≈705A/27434
		
		

d₁ x d₂ x b	☒	Kod artykułu	d₁ x d₂ x b	☒	Kod artykułu	d₁ x d₂ x b	☒	Kod artykułu
5X10X6MM	25	51372.050.001	16X28X12MM	5	51372.160.001	34X50X16MM	2	51372.340.001
6X12X8MM	25	51372.060.001	20X32X14MM	5	51372.200.001	35X56X16MM	2	51372.350.001
8X16X8MM	25	51372.080.001	24X40X16MM	5	51372.240.001	36X56X16MM	1	51372.360.001
9X18X10MM	10	51372.090.001	25X40X16MM	5	51372.250.001	38X56X16MM	1	51372.380.001
10X20X10MM	10	51372.100.001	26X40X16MM	5	51372.260.001	40X63X18MM	1	51372.400.001
11X20X10MM	10	51372.110.001	28X45X16MM	2	51372.280.001	45X70X18MM	1	51372.450.001
12X22X12MM	10	51372.120.001	30X45X16MM	2	51372.300.001	50X80X18MM	1	51372.500.001
15X25X12MM	10	51372.150.001	32X50X16MM	2	51372.320.001			

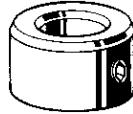
51371	Pierścienie osadcze ze śrubą dociskową z gniazdem sześciokątnym DIN ≈705A/ISO 4027 (DIN 914)	R09A
Materiał	Stal nierdzewna A2	DIN ≈705A/4027
		
		

d₁ x d₂ x b	☒	Kod artykułu	d₁ x d₂ x b	☒	Kod artykułu	d₁ x d₂ x b	☒	Kod artykułu
5X10X6MM*	100	51371.050.001	18X32X14MM*	25	51371.180.001	35X56X16MM*	10	51371.350.001
6X12X8MM*	100	51371.060.001	20X32X14MM*	25	51371.200.001	36X56X16MM*	10	51371.360.001
8X16X8MM*	100	51371.080.001	22X36X14MM*	25	51371.220.001	38X56X16MM*	10	51371.380.001
9X16X8MM*	100	51371.090.001	24X40X16MM*	25	51371.240.001	40X63X18MM*	10	51371.400.001
10X20X10MM*	50	51371.100.001	25X40X16MM*	25	51371.250.001	45X70X18MM*	5	51371.450.001
11X20X10MM*	50	51371.110.001	26X40X16MM*	25	51371.260.001	50X80X18MM*	5	51371.500.001
12X22X12MM*	50	51371.120.001	28X45X16MM*	25	51371.280.001	55X80X18MM*	5	51371.550.001
13X22X12MM*	50	51371.130.001	30X45X16MM*	25	51371.300.001	60X90X20MM*	5	51371.600.001
14X25X12MM*	50	51371.140.001	32X16X50MM*	10	51371.320.001	65X100X20MM*	5	51371.650.001
15X25X12MM*	50	51371.150.001	34X50X16MM*	10	51371.340.001	70X100X20MM*	5	51371.700.001
16X28X12MM	50	51371.160.001						

Pierścienie osadcze lekkie DIN 705A/2 x ISO 4027 (DIN 914)

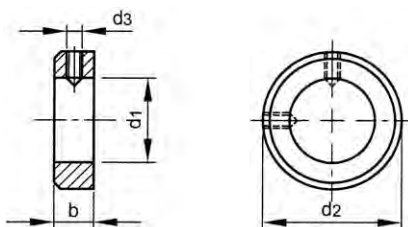

DIN 705A/4027 (914)

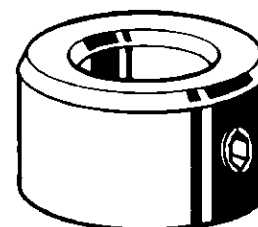

Informacje techniczne

d ₁ (H8)	b	d ₁	d ₂	d ₃
75	22	75	110	12
80	22	80	110	12
90	22	90	125	12

51373 Pierścienie osadcze ze śrubami w DIN914, M12x20

R09A

Materiał Stal nierdzewna A2
Klasa 50

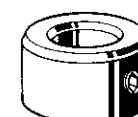

d ₁ x d ₂ x b	☒	Kod artykułu	d ₁ x d ₂ x b	☒	Kod artykułu	d ₁ x d ₂ x b	☒	Kod artykułu
75X110X22MM*	5	51373.750.001	80X110X22MM*	5	51373.800.001	90X125X22MM*	5	51373.900.001

Podkładki dystansowe

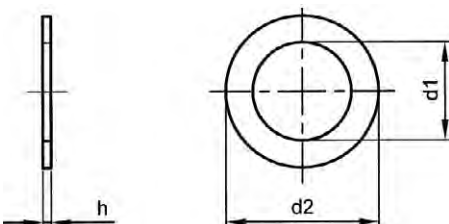

DIN 988



Informacje techniczne

d ₁ x d ₂	d ₁ (maks.)	d ₁ (min.)	d ₂ (maks.)	d ₂ (min.)
3x6	3.12	3.02	5.97	5.85
4x8	4.15	4.03	7.96	7.81
5x10	5.15	5.03	9.96	9.81
6x12	6.15	6.03	11.95	11.77
6x18 (#DIN)	6.15	6.03	17.95	17.77
7x13	7.15	7.04	12.95	12.77
8x14	8.19	8.04	13.95	13.77
8x20 (#DIN)	8.16	8.04	19.95	19.77
9x15	9.19	9.04	14.95	14.77
10x16	10.19	10.04	15.95	15.77
10x18 (#DIN)	10.19	10.04	15.95	17.77
10x22 (#DIN)	10.19	10.04	21.935	21.725
11x17	11.23	11.05	16.95	16.77
12x18	12.23	12.05	17.95	17.77
12x20 (#DIN)	12.23	12.05	19.935	19.725
12x24 (#DIN)	12.23	12.05	23.935	23.725
13x19	13.23	13.05	17.95	17.77
14x20	14.23	14.05	19.935	19.725
14x26 (#DIN)	14.23	14.03	25.935	25.725
15x21	15.23	15.05	20.935	20.725
16x22	16.23	16.05	21.935	21.725
16x26 (#DIN)	16.23	16.05	25.935	25.275
16x28 (#DIN)	16.23	16.05	27.935	27.275
17x24	17.23	17.05	23.935	23.725
18x25	18.23	18.05	24.935	24.725
18x30 (#DIN)	18.23	18.05	29.735	29.725
19x26	19.275	19.065	25.935	25.725
20x28	20.275	20.065	27.935	27.725

Informacje techniczne				
d ₁ x d ₂	d ₁ (maks.)	d ₁ (min.)	d ₂ (maks.)	d ₂ (min.)
20x32 (#DIN)	20.275	20.065	31.92	31.67
22x30	22.275	22.065	29.935	29.725
22x32	22.275	22.065	31.92	31.67
22x34 (#DIN)	22.275	22.065	33.92	33.67
24x36 (#DIN)	24.275	24.065	35.92	35.67
25x35	25.275	25.065	34.92	34.67
25x36	25.275	25.065	35.92	35.67
26x37	26.275	26.065	36.92	36.67
26x38 (#DIN)	26.275	26.065	37.92	37.67
28x40	28.275	28.065	39.92	39.67
30x35 (#DIN)	30.275	30.065	34.92	34.67
30x40 (#DIN)	30.275	30.065	39.92	39.67
30x42	30.275	30.065	41.92	41.67
32x44 (#DIN)	32.33	32.08	43.92	43.67
32x45	32.33	32.08	44.92	44.67
34x46 (#DIN)	34.33	34.08	45.92	45.67
35x45	35.33	35.08	44.92	44.67
36x45	36.33	36.08	44.92	44.67
36x48 (#DIN)	36.33	36.08	47.92	47.67
37x47	37.33	37.08	46.92	46.67
38x50 (#DIN)	38.33	38.08	49.92	49.67
40x50	40.33	40.08	49.92	49.67
40x52 (#DIN)	40.33	40.08	51.9	51.6
42x52	42.33	42.08	51.9	51.6
42x54 (#DIN)	43.33	42.08	53.9	53.6
44x56 (#DIN)	44.33	44.08	55.9	55.6
45x55	45.33	45.08	54.9	54.6
45x56	45.33	45.08	55.9	55.6
46x58 (#DIN)	46.33	46.08	57.9	57.6
48x60	48.33	48.08	59.9	59.6
50x62	50.33	50.08	61.9	61.6
50x63	50.33	50.08	62.9	62.6
52x65	52.4	52.1	64.9	64.6
55x68	55.4	55.1	67.9	67.6
56x68 (#DIN)	56.4	56.1	67.9	67.6
56x70	56.4	56.1	69.9	69.6
56x72	56.4	56.1	71.9	71.6
60x72 (#DIN)	60.4	60.1	71.9	71.6
60x75	60.4	60.1	74.9	74.6
63x80	63.4	63.1	79.9	79.6
65x80 (#DIN)	65.4	65.1	79.9	79.6
65x85	65.4	65.1	84.88	84.53
70x85 (#DIN)	70.4	70.1	84.88	84.53
70x90	70.4	70.1	89.88	89.53
75x90 (#DIN)	75.4	75.1	89.88	89.53
75x95	75.4	75.1	94.88	94.53
80x100	80.4	80.1	99.88	99.53
85x105	85.47	85.12	104.88	104.53
90x110	90.47	90.12	109.88	109.53
95x110 (#DIN)	95.47	95.12	109.88	109.53
100x120	100.47	100.12	119.88	119.53
100x125	100.47	100.12	124.855	124.455
105x125 (#DIN)	105.47	105.12	124.855	124.455
105x130	105.47	105.12	129.855	129.455
110x130 (#DIN)	110.47	110.12	129.855	129.455
110x140	110.47	110.12	139.855	139.455
120x140 (#DIN)	120.47	120.12	139.855	139.455
120x150	120.47	120.12	149.855	149.455
130x150 (#DIN)	130.545	130.145	149.855	149.455
130x160	130.545	130.145	159.855	159.455
140x170	140.545	140.145	169.855	169.455
150x180	150.545	150.145	179.855	179.455
160x180 (#DIN)	160.545	160.145	179.855	179.455
160x190	160.545	160.145	189.83	189.37
170x200	170.545	170.145	199.83	199.37
185x215 (#DIN)	185.47	185.12	214.83	214.37

Grupy katalogowe

Material		Kod	Strona
St 2 K 50 vlgs DIN1624	h=0,1mm	38600	7-139
St.St. A2	h=0,1mm	51552	7-139
St.St. A2	h=0,2mm	51554	7-139
St 2 K 50 vlgs DIN1624	h=0,25mm	38602	7-140
St 2 K 50 vlgs DIN1624	h=0,3mm	38583	7-140
St.St. A2	h=0,3mm	51556	7-140
St 2 K 50 vlgs DIN1624	h=0,5mm	38585	7-140
St.St. A2	h=0,5mm	51555	7-141
St 2 K 50 vlgs DIN1624	h=1,0mm	38590	7-141
St.St. A2	h=1,0mm	51557	7-141

38600 Podkładki dystansowe, grubość h=0,1 mm

L07H
Material Stal 2 K 50 vlgs DIN1624

d ₁ x d ₂	☒	Kod artykułu	d ₁ x d ₂	☒	Kod artykułu	d ₁ x d ₂	☒	Kod artykułu
8X14MM	100	38600.080.014	22X34MM	50	38600.220.034	42X52MM	25	38600.420.052
8X20MM	100	38600.080.020	24X36MM	50	38600.240.036	50X62MM	25	38600.500.062
10X16MM	100	38600.100.016	25X35MM	50	38600.250.035	56X70MM	25	38600.560.070
10X22MM	100	38600.100.022	26X38MM	50	38600.260.038	56X72MM	10	38600.560.072
12X18MM	100	38600.120.018	28X40MM	50	38600.280.040	63X80MM	25	38600.630.080
12X24MM	100	38600.120.024	30X35MM	50	38600.300.035	75X90MM	10	38600.750.090
14X26MM	100	38600.140.026	30X42MM	50	38600.300.042	80X100MM	10	38600.800.100
16X28MM	50	38600.160.028	32X44MM	25	38600.320.044	90X110MM	10	38600.900.110
17X24MM	50	38600.170.024	34X46MM	25	38600.340.046	105X125MM	10	38600.983.125
18X25MM	50	38600.180.025	36X48MM	25	38600.360.048	110X140MM	5	38600.984.140
18X30MM	50	38600.180.030	37X47MM	50	38600.370.047	120X140MM	10	38600.986.140
20X28MM	50	38600.200.028	38X50MM	25	38600.380.050	140X170MM	5	38600.990.170
20X32MM	50	38600.200.032	40X50MM	25	38600.400.050			

51552 Podkładki dystansowe, grubość h=0,1 mm

R05A
Material Stal nierdzewna A2

d ₁ x d ₂	☒	Kod artykułu	d ₁ x d ₂	☒	Kod artykułu	d ₁ x d ₂	☒	Kod artykułu
5X10MM*	100	51552.050.010	16X22MM*	100	51552.160.022	28X40MM*	100	51552.280.040
6X12MM	100	51552.060.012	20X28MM*	100	51552.200.028	30X42MM*	100	51552.300.042
10X16MM	100	51552.100.016	25X35MM*	100	51552.250.035	40X50MM*	100	51552.400.050
12X18MM	100	51552.120.018						



51554 Podkładki dystansowe, grubość h=0,2 mm

R05A
Material Stal nierdzewna A2



d ₁ x d ₂	☒	Kod artykułu	d ₁ x d ₂	☒	Kod artykułu	d ₁ x d ₂	☒	Kod artykułu
4X8MM	100	51554.040.008	11X17MM*	100	51554.110.017	15X21MM	100	51554.150.021
5X10MM*	100	51554.050.010	12X18MM*	100	51554.120.018	16X22MM*	100	51554.160.022
6X12MM	100	51554.060.012	13X19MM*	100	51554.130.019	20X28MM*	100	51554.200.028
8X14MM*	100	51554.080.014	14X20MM*	100	51554.140.020	25X35MM*	100	51554.250.035
10X16MM	100	51554.100.016						

38602	Podkładki dystansowe, grubość h=0,25 mm	L07H
Materiał	Stal 2 K 50 vlgs DIN1624	
		 

d ₁ x d ₂	☒	Kod artykułu	d ₁ x d ₂	☒	Kod artykułu	d ₁ x d ₂	☒	Kod artykułu
8X20MM	100	38602.080.020	18X30MM	50	38602.180.030	38X50MM	25	38602.380.050
10X16MM	100	38602.100.016	20X32MM	50	38602.200.032	42X54MM	25	38602.420.054
10X22MM	100	38602.100.022	22X34MM	50	38602.220.034	44X56MM	25	38602.440.056
12X20MM	100	38602.120.020	24X36MM	50	38602.240.036	46X58MM	25	38602.460.058
12X24MM	100	38602.120.024	26X38MM	50	38602.260.038	48X60MM	25	38602.480.060
14X26MM	100	38602.140.026	32X44MM	25	38602.320.044	50X62MM	25	38602.500.062
16X26MM	100	38602.160.026	34X46MM	25	38602.340.046	56X68MM	25	38602.560.068
16X28MM	50	38602.160.028	36X48MM	25	38602.360.048	60X72MM	25	38602.600.072

38583	Podkładki dystansowe, grubość h=0,3 mm	L07H
Materiał	Stal 2 K 50 vlgs DIN1624	
		 

d ₁ x d ₂	☒	Kod artykułu	d ₁ x d ₂	☒	Kod artykułu	d ₁ x d ₂	☒	Kod artykułu
3X6MM	100	38583.030.006	25X35MM	50	38583.250.035	65X80MM	10	38583.650.080
4X8MM	100	38583.040.008	25X36MM	50	38583.250.036	65X85MM	10	38583.650.085
5X10MM	100	38583.050.010	26X37MM	50	38583.260.037	70X90MM	10	38583.700.090
6X12MM	100	38583.060.012	28X40MM	50	38583.280.040	75X90MM	10	38583.750.090
8X14MM	100	38583.080.014	30X35MM	50	38583.300.035	80X100MM	10	38583.800.100
10X16MM	100	38583.100.016	30X42MM	50	38583.300.042	85X105MM	10	38583.850.105
12X18MM	100	38583.120.018	32X45MM	25	38583.320.045	90X110MM	10	38583.900.110
14X20MM	100	38583.140.020	35X45MM	25	38583.350.045	95X110MM	10	38583.950.110
15X21MM	100	38583.150.021	36X45MM	25	38583.360.045	100X120MM	10	38583.982.120
16X22MM	50	38583.160.022	37X47MM	25	38583.370.047	105X125MM	10	38583.983.125
17X24MM	50	38583.170.024	40X50MM	25	38583.400.050	110X130MM	10	38583.984.130
18X25MM	50	38583.180.025	42X52MM	25	38583.420.052	110X140MM	10	38583.984.140
19X26MM	50	38583.190.026	45X55MM	25	38583.450.055	130X160MM	10	38583.988.160
20X28MM	50	38583.200.028	50X62MM	25	38583.500.062	140X170MM	10	38583.990.170
22X30MM	50	38583.220.030	56X72MM	25	38583.560.072	160X180MM	10	38583.993.180
22X32MM	50	38583.220.032	60X75MM	25	38583.600.075	185X215MM	10	38583.996.215
24X36MM	50	38583.240.036	63X80MM	10	38583.630.080			

51556	Podkładki dystansowe, grubość h=0,3 mm	R05A
Materiał	Stal nierdzewna A2	
		 

d ₁ x d ₂	☒	Kod artykułu	d ₁ x d ₂	☒	Kod artykułu	d ₁ x d ₂	☒	Kod artykułu
5X10MM*	100	51556.050.010	14X20MM*	100	51556.140.020	17X24MM*	100	51556.170.024
6X12MM*	100	51556.060.012	16X22MM*	100	51556.160.022	20X28MM*	100	51556.200.028
12X18MM*	100	51556.120.018						

38585	Podkładki dystansowe, grubość h=0,5 mm	L07H
Materiał	Stal 2 K 50 vlgs DIN1624	
		 

d ₁ x d ₂	☒	Kod artykułu	d ₁ x d ₂	☒	Kod artykułu	d ₁ x d ₂	☒	Kod artykułu
3X6MM	100	38585.030.006	19X26MM	50	38585.190.026	40X50MM	25	38585.400.050
4X8MM	100	38585.040.008	20X28MM	50	38585.200.028	42X52MM	25	38585.420.052
5X10MM	100	38585.050.010	22X32MM	50	38585.220.032	45X55MM	10	38585.450.055
6X12MM	100	38585.060.012	25X35MM	50	38585.250.035	50X62MM	10	38585.500.062
8X14MM	100	38585.080.014	26X37MM	50	38585.260.037	56X72MM	10	38585.560.072
10X16MM	100	38585.100.016	28X40MM	50	38585.280.040	60X75MM	10	38585.600.075
12X18MM	100	38585.120.018	30X42MM	50	38585.300.042	63X80MM	10	38585.630.080
14X20MM	100	38585.140.020	32X45MM	25	38585.320.045	65X80MM	10	38585.650.080
16X22MM	50	38585.160.022	35X45MM	25	38585.350.045	70X85MM	10	38585.700.085
17X24MM	50	38585.170.024	36X45MM	25	38585.360.045	70X90MM	10	38585.700.090
18X25MM	50	38585.180.025	37X47MM	25	38585.370.047	75X90MM	10	38585.750.090

38585 Podkładki dystansowe, grubość h=0,5 mm								
d ₁ x d ₂	☒	Kod artykułu	d ₁ x d ₂	☒	Kod artykułu	d ₁ x d ₂	☒	Kod artykułu
80X100MM	10	38585.800.100	110X130MM	10	38585.984.130	140X170MM	5	38585.990.170
90X110MM	10	38585.900.110	110X140MM	10	38585.984.140	150X180MM	5	38585.992.180
100X120MM	10	38585.981.120	130X150MM	5	38585.988.150	160X180MM	5	38585.993.180
105X125MM	10	38585.983.125	130X160MM	5	38585.988.160			

51555 Podkładki dystansowe, grubość h=0,5 mm							
R05A							
Materiał		Stal nierdzewna A2					

d ₁ x d ₂	☒	Kod artykułu	d ₁ x d ₂	☒	Kod artykułu	d ₁ x d ₂	☒	Kod artykułu
4X8MM*	100	51555.040.008	14X20MM*	100	51555.140.020	25X35MM*	100	51555.250.035
5X10MM	100	51555.050.010	15X21MM	100	51555.150.021	28X40MM*	100	51555.280.040
6X12MM	100	51555.060.012	16X22MM*	100	51555.160.022	30X42MM*	100	51555.300.042
8X14MM	100	51555.080.014	17X24MM*	100	51555.170.024	35X45MM*	100	51555.350.045
10X16MM	100	51555.100.016	20X28MM*	100	51555.200.028	40X50MM*	100	51555.400.050
12X18MM	100	51555.120.018	22X30MM*	100	51555.220.030			

38590 Podkładki dystansowe, grubość h=1,0 mm							
L07H							
Materiał		Stal 2 K 50 vlgs DIN1624					

d ₁ x d ₂	☒	Kod artykułu	d ₁ x d ₂	☒	Kod artykułu	d ₁ x d ₂	☒	Kod artykułu
3X6MM	100	38590.030.006	16X22MM	50	38590.160.022	30X42MM	50	38590.300.042
4X8MM	100	38590.040.008	18X25MM	50	38590.180.025	32X45MM	25	38590.320.045
5X10MM	100	38590.050.010	20X28MM	50	38590.200.028	35X45MM	25	38590.350.045
6X12MM	100	38590.060.012	20X32MM	50	38590.200.032	36X45MM	25	38590.360.045
8X14MM	100	38590.080.014	22X32MM	50	38590.220.032	37X47MM	25	38590.370.047
10X16MM	100	38590.100.016	25X35MM	50	38590.250.035	40X50MM	25	38590.400.050
12X18MM	100	38590.120.018	26X37MM	50	38590.260.037	45X55MM	10	38590.450.055
12X24MM	100	38590.120.024	26X38MM	50	38590.260.038	50X62MM	10	38590.500.062
14X20MM	100	38590.140.020	28X40MM	50	38590.280.040	60X75MM	10	38590.600.075

51557 Podkładki dystansowe, grubość h=1,0mm							
R05A							
Materiał		Stal nierdzewna A2					

d ₁ x d ₂	☒	Kod artykułu	d ₁ x d ₂	☒	Kod artykułu	d ₁ x d ₂	☒	Kod artykułu
6X12MM*	100	51557.060.012	13X19MM*	100	51557.130.019	20X28MM	100	51557.200.028
8X14MM	100	51557.080.014	14X20MM*	100	51557.140.020	25X35MM*	100	51557.250.035
10X16MM	100	51557.100.016	15X21MM	100	51557.150.021	30X42MM*	100	51557.300.042
11X17MM*	100	51557.110.017	16X22MM	100	51557.160.022	35X45MM*	100	51557.350.045
12X18MM	100	51557.120.018	17X24MM*	100	51557.170.024			

Podkładki kwadratowe do konstrukcji drewnianych

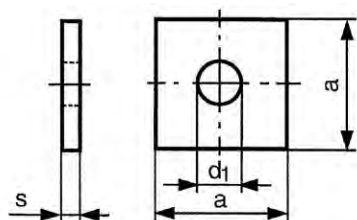

DIN 436

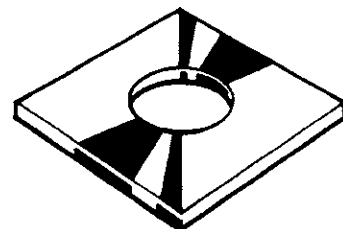

Informacje techniczne

Dla wymiaru nominalnego	a	d ₁	s	Dla wymiaru nominalnego	a	d ₁	s
M8 (#DIN)	30	9	3	M22	70	24	6
M10	30	11	3	M24	80	26	6
M12	40	13.5	4	M27	90	30	6
M16	50	17.5	5	M30	95	33	6
M20	60	22	5				

Grupy katalogowe

Materiał	Obróbka powierzchni	Kod	Strona
St		38300	7-142
St	Ocynk.	38310	7-142
St	Ocynk. gor.	38320	7-142
St.St. A2		51908	7-143
St.St. A4		55908	7-143

38300 Podkładki kwadratowe do konstrukcji drewnianych

L07G

Materiał Stal

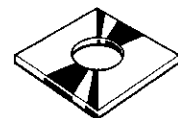

Dla wymiaru nominalnego	☒	Kod artykułu	Dla wymiaru nominalnego	☒	Kod artykułu	Dla wymiaru nominalnego	☒	Kod artykułu
M8	100	38300.080.001	M16	100	38300.160.001	M24	25	38300.240.001
M10	100	38300.100.001	M20	50	38300.200.001			
M12	100	38300.120.001	M22	50	38300.220.001			

38310 Podkładki kwadratowe do konstrukcji drewnianych

L07G

Materiał Stal
Obróbka powierzchni Ocynkowane



Dla wymiaru nominalnego	☒	Kod artykułu	Dla wymiaru nominalnego	☒	Kod artykułu	Dla wymiaru nominalnego	☒	Kod artykułu
M8	100	38310.080.001	M16	100	38310.160.001	M24	25	38310.240.001
M10	100	38310.100.001	M20	50	38310.200.001	M27	25	38310.270.001
M12	100	38310.120.001	M22	50	38310.220.001	M30	25	38310.300.001

38320 Podkładki kwadratowe do konstrukcji drewnianych

A08G

Materiał Stal
Obróbka powierzchni Ocynkowane na gorąco

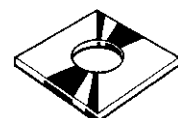

Dla wymiaru nominalnego	☒	Kod artykułu	Dla wymiaru nominalnego	☒	Kod artykułu	Dla wymiaru nominalnego	☒	Kod artykułu
M8	100	38320.080.001	M16	100	38320.160.001	M24	25	38320.240.001
M10	100	38320.100.001	M20	50	38320.200.001	M27	25	38320.270.001
M12	100	38320.120.001	M22	50	38320.220.001	M30	10	38320.300.001

51908	Podkładki kwadratowe do konstrukcji drewnianych	R09A
Materiał	Stal nierdzewna A2	DIN ≈436

Dla wymiaru nominalnego	✉	Kod artykułu	Dla wymiaru nominalnego	✉	Kod artykułu	Dla wymiaru nominalnego	✉	Kod artykułu
M10	100	51908.100.001	M16	100	51908.160.001	M24	25	51908.240.001
M12	100	51908.120.001	M20	50	51908.200.001			

55908	Podkładki kwadratowe do konstrukcji drewnianych	R49A
Materiał	Stal nierdzewna A4	DIN ≈436

Dla wymiaru nominalnego	✉	Kod artykułu	Dla wymiaru nominalnego	✉	Kod artykułu	Dla wymiaru nominalnego	✉	Kod artykułu
M10	100	55908.100.001	M16	100	55908.160.001	M24	25	55908.240.001
M12	100	55908.120.001	M20	50	55908.200.001			

Podkładki klinowe 14% do dwuteowników

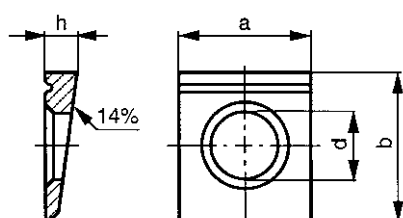

DIN 435
NEN 2273

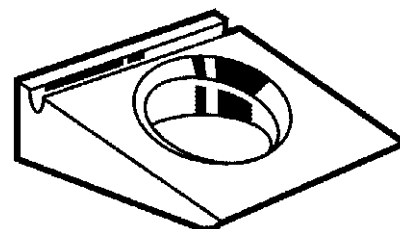

Informacje techniczne

Dla wymiaru nominalnego	a	b	d	h	Dla wymiaru nominalnego	a	b	d	h
M8	22	22	9	4.6	M22	44	50	24	10
M10	22	22	11	4.6	M24	56	56	26	10.8
M12	26	30	13.5	6.2	M27	56	56	30	10.8
M16	32	36	17.5	7.5	M30 (#DIN)	62	62	33	11.7
M20	40	44	22	9.2	M33 (#DIN)	68	68	36	11.7

Grupy katalogowe

Materiał	Obróbka powierzchni	Kod	Strona
St 100-250 HV10		38520	7-143
St 100-250 HV10	Ocynk. gor.	38540	7-144
St.St. A2		51922	7-144
St.St. A4		55922	7-144

38520	Podkładki klinowe 14% do dwuteowników	L07G
Materiał	Stal 100-250 HV10	



Dla wymiaru nominalnego	✉	Kod artykułu	Dla wymiaru nominalnego	✉	Kod artykułu	Dla wymiaru nominalnego	✉	Kod artykułu
M8	100	38520.080.001	M16	100	38520.160.001	M24	25	38520.240.001
M10	100	38520.100.001	M20	50	38520.200.001			
M12	100	38520.120.001	M22	50	38520.220.001			

38540	Podkładki klinowe 14% do dwuteowników	A08G
Materiał	Stal 100-250 HV10	
Obróbka powierzchni	Ocynkowane na gorąco	
		

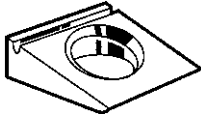
Dla wymiaru nominalnego	☒	Kod artykułu	Dla wymiaru nominalnego	☒	Kod artykułu	Dla wymiaru nominalnego	☒	Kod artykułu
M8	100	38540.080.001	M20	50	38540.200.001	M30	10	38540.300.001
M10	100	38540.100.001	M22	50	38540.220.001	M33	10	38540.330.001
M12	100	38540.120.001	M24	25	38540.240.001			
M16	100	38540.160.001	M27	25	38540.270.001			

51922	Podkładki klinowe 14% do dwuteowników	R09A
Materiał	Stal nierdzewna A2	
		

Dla wymiaru nominalnego	☒	Kod artykułu	Dla wymiaru nominalnego	☒	Kod artykułu	Dla wymiaru nominalnego	☒	Kod artykułu
M8	50	51922.080.001	M16	50	51922.160.001	M24*	10	51922.240.001
M10	50	51922.100.001	M20*	25	51922.200.001			
M12	50	51922.120.001	M22*	10	51922.220.001			

55922	Podkładki klinowe 14% do dwuteowników	R49A
Materiał	Stal nierdzewna A4	
		

Dla wymiaru nominalnego	☒	Kod artykułu	Dla wymiaru nominalnego	☒	Kod artykułu	Dla wymiaru nominalnego	☒	Kod artykułu
M8*	50	55922.080.001	M16	50	55922.160.001	M24*	10	55922.240.001
M10	50	55922.100.001	M20*	25	55922.200.001			
M12	50	55922.120.001	M22*	10	55922.220.001			

Podkładki klinowe 8% do ceowników

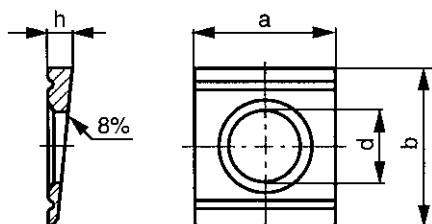

DIN 434
NEN 2272

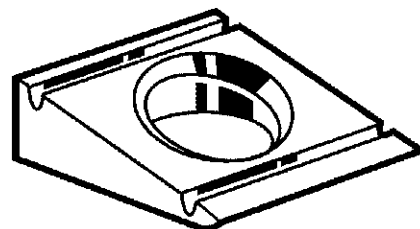

Informacje techniczne

Dla wymiaru nominalnego	a	b	d	h	Dla wymiaru nominalnego	a	b	d	h
M8	22	22	9	3.8	M22	44	50	24	8
M10	22	22	11	3.8	M24	56	56	26	8.5
M12	26	30	13.5	4.9	M27	56	56	30	8.5
M14 (#DIN)	26.2	30.1	16.3	5.5	M30 (#DIN)	56	56	33	8.5
M16	32	36	17.5	5.9	M33 (#DIN)	56	56	36	8.5
M20	40	44	22	7					

Grupy katalogowe

Material	Obróbka powierzchni	Kod	Strona
St 100-250 HV10		38500	7-145
St 100-250 HV10	Ocynk.	38495	7-145
St 100-250 HV10	Ocynk. gor.	38490	7-145
St.St. A2		51920	7-146
St.St. A4		55920	7-146

38500 Podkładki klinowe 8% do ceowników

L07G

Material Stal 100-250 HV10

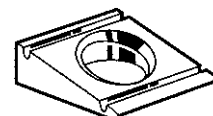

Dla wymiaru nominalnego	Kod artykułu	Dla wymiaru nominalnego	Kod artykułu	Dla wymiaru nominalnego	Kod artykułu
M8	100 38500.080.001	M16	100 38500.160.001	M27	25 38500.270.001
M10	100 38500.100.001	M20	50 38500.200.001	M30	10 38500.300.001
M12	100 38500.120.001	M22	50 38500.220.001	M33	10 38500.330.001
M14	100 38500.140.001	M24	25 38500.240.001		

38495 Podkładki klinowe 8% do ceowników

L07G

Material Stal 100-250 HV10
Obróbka powierzchni Ocynkowane

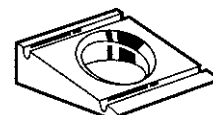

Dla wymiaru nominalnego	Kod artykułu	Dla wymiaru nominalnego	Kod artykułu	Dla wymiaru nominalnego	Kod artykułu
M8	200 38495.080.001	M12	100 38495.120.001	M20	50 38495.200.001
M10	200 38495.100.001	M16	100 38495.160.001	M24	50 38495.240.001

38490 Podkładki klinowe 8% do ceowników

A08G

Material Stal 100-250 HV10
Obróbka powierzchni Ocynkowane na gorąco

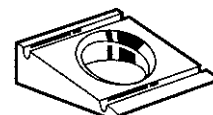

Dla wymiaru nominalnego	Kod artykułu	Dla wymiaru nominalnego	Kod artykułu	Dla wymiaru nominalnego	Kod artykułu
M8	100 38490.080.001	M20	50 38490.200.001	M30	10 38490.300.001
M10	100 38490.100.001	M22	50 38490.220.001	M33	10 38490.330.001
M12	100 38490.120.001	M24	25 38490.240.001		
M16	100 38490.160.001	M27	25 38490.270.001		

51920	Podkładki klinowe 8% do ceowników	R09A
Materiał	Stal nierdzewna A2	DIN ≈434 NEN ≈2272

Dla wymiaru nominalnego	☒	Kod artykułu	Dla wymiaru nominalnego	☒	Kod artykułu	Dla wymiaru nominalnego	☒	Kod artykułu
M8	50	51920.080.001	M16	50	51920.160.001	M24*	10	51920.240.001
M10	50	51920.100.001	M20	25	51920.200.001			
M12	50	51920.120.001	M22*	10	51920.220.001			

55920	Podkładki klinowe 8% do ceowników	R49A
Materiał	Stal nierdzewna A4	DIN ≈434 NEN ≈2272

Dla wymiaru nominalnego	☒	Kod artykułu	Dla wymiaru nominalnego	☒	Kod artykułu	Dla wymiaru nominalnego	☒	Kod artykułu
M8	50	55920.080.001	M16	50	55920.160.001	M24*	10	55920.240.001
M10	50	55920.100.001	M20	25	55920.200.001	M30*	10	55920.300.001
M12	50	55920.120.001	M22*	10	55920.220.001			

Podkładki uszczelniające

DIN 7603 A/C

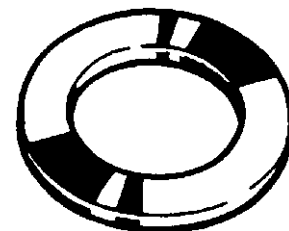
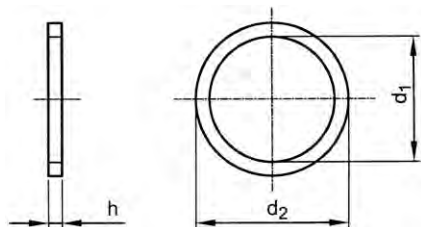

7

Informacje techniczne

d ₁ x d ₂ x h	d ₁	d ₂	d ₁ x d ₂ x h	d ₁	d ₂
4x8x1	4.2	7.9	12x15.5x1.5	12.2	15.4
5x7.5x1	5.2	7.9	12x16x1 (#DIN)	12.2	15.9
5x9x1	5.2	8.9	12x16x1.5	12.2	15.9
5x9x1.5	5.2	8.9	12x16x2	12.2	15.9
5x10x1 (#DIN)	5.2	9.9	12x17x1.5	12.2	16.9
6x10x1	6.2	9.9	12x18x1.5	12.2	17.9
6x10x1.5	6.2	9.9	12x18x2	12.2	17.9
6x12x1 (#DIN)	6.2	11.9	12x20x1.5 (#DIN)	12.2	19.9
6x12x1.5 (#DIN)	6.2	11.9	12.5x20x1.5 (#DIN)	12.7	19.9
6.5x9.5x1	6.7	9.4	13x18x1.5 (#DIN)	13.2	17.9
7x10x1 (#DIN)	7.2	9.9	13x18x2 (#DIN)	13.2	17.9
7x15x2 (#DIN)	7.1	14.9	14x18x1 (#DIN)	14.2	17.9
8x11.5x1	8.2	11.4	14x18x1.5	14.2	17.9
8x11.5x1.5	8.2	11.4	14x18x2	14.2	17.9
8x12x1	8.2	11.9	14x18x2 (#DIN)	14.2	17.9
8x12x1.5	8.2	11.9	14x20x1 (#DIN)	14.2	19.9
8x13x1	8.2	12.9	14x20x1.5	14.2	19.9
8x14x1	8.2	13.9	14x20x2	14.2	19.9
8x14x1.5	8.2	13.9	14x20x2 (#DIN)	14.2	19.9
9x14x1 (#DIN)	9.2	13.9	14x22x1.5 (#DIN)	14.2	21.9
9x14x1.5 (#DIN)	9.2	13.9	15x19x1.5	15.2	18.9
10x13.5x1	10.2	13.4	15x20x1 (#DIN)	15.2	19.9
10x13.5x1.5	10.2	13.4	15x20x1.5 (#DIN)	15.2	19.9
10x14x1	10.2	13.9	15x20x2 (#DIN)	15.2	19.9
10x14x1.5	10.2	13.9	16x20x1.5	16.2	19.9
10x15x1	10.2	14.9	16x20x2	16.2	19.9
10x16x1	10.2	15.9	16x20x2 (#DIN)	16.2	19.9
10x16x1.5	10.2	15.9	16x21x2 (#DIN)	16.2	20.9
10x19x2 (#DIN)	10.2	18.9	16x22x1.5	16.2	21.9
10x20x1.5 (#DIN)	10.2	19.9	16x22x2	16.2	21.9
10.5x17x1.5 (#DIN)	10.7	16.9	16x22x2 (#DIN)	16.2	21.9
11x17x1.5 (#DIN)	11.2	16.9	16.5x24x2 (#DIN)	16.7	23.9

Informacje techniczne			Informacje techniczne		
d ₁ x d ₂ x h	d ₁	d ₂	d ₁ x d ₂ x h	d ₁	d ₂
17x21x1.5	17.2	20.9	26x32x2.5	26.3	31.9
17x21x2	17.2	20.9	26x33x2 (#DIN)	26.3	32.9
17x22x1.5 (#DIN)	17.2	21.9	26x34x2	26.3	33.9
17x23x1.5	17.2	22.9	26x34x2.5	26.3	33.9
17x23x2	17.2	22.9	27x32x2	27.3	31.9
17x24x2 (#DIN)	17.2	23.9	27x32x2.5	27.3	31.9
17.5x25x2 (#DIN)	17.7	24.9	28x33x1 (#DIN)	28.3	32.9
18x22x1.5	18.2	21.9	28x34x2 (#DIN)	28.3	33.9
18x22x2	18.2	21.9	28x34x2.5 (#DIN)	28.3	33.9
18x24x1.5	18.2	23.9	30x36x2	30.3	35.9
18x24x2	18.2	23.9	30x36x2.5	30.3	35.9
18x24x2 (#DIN)	18.2	23.9	30x38x2	30.3	37.9
19x26x2 (#DIN)	19.2	25.9	30x38x2.5	30.3	37.9
20x24x1.5	20.2	23.9	32x38x2	32.3	37.9
20x24x2	20.2	23.9	32x38x2.5	32.3	37.9
20x24x2 (#DIN)	20.2	23.9	32x40x2	32.3	39.9
20x26x1.5	20.2	25.9	33x39x2	33.3	38.9
20x26x2	20.2	25.9	33x39x2.5	33.3	38.9
21x26x1.5	21.2	25.9	35x41x2	35.3	40.9
21x26x2	21.2	25.9	35x41x2.5	35.3	40.9
21x26x2 (#DIN)	21.2	25.9	35x45x2 (#DIN)	35.3	44.9
21x28x1.5 (#DIN)	21.2	27.9	36x42x2	36.3	41.9
21x28x2 (#DIN)	21.2	27.9	36x42x2.5	36.3	41.9
22x26x2 (#DIN)	22.2	25.9	38x44x2	38.3	43.9
22x27x1.5	22.2	26.9	38x44x2.5	38.3	43.9
22x27x2	22.2	26.9	40x47x2	40.3	46.9
22x29x1.5	22.2	28.9	40x47x2.5	40.3	46.9
22x29x2	22.2	28.9	42x49x2	42.3	48.9
22x29x2 (#DIN)	22.2	28.9	42x49x2.5	42.3	48.9
24x29x2	24.3	28.9	45x52x2	44.3	51.9
24x29x2.5	24.3	28.9	45x52x2.5 (#DIN)	45.3	51.9
24x30x2 (#DIN)	24.3	29.9	48x55x2	48.3	54.9
24x30x2.5 (#DIN)	24.3	29.9	48x55x2.5	48.3	54.9
24x32x2	24.3	31.9	50x57x2	50.2	56.9
24x32x2.5	24.3	31.9	60x68x2.5	60.5	67.8
26x31x2	26.3	30.9	75x84x2.5	75.5	83.8
26x32x2	26.3	31.9	90x100x2.5	90.5	99.8

Grupy katalogowe

Material	Kod	Strona	
Al 99F11	h=1,0mm	45191	7-147
Al 99F11	h=1,5mm	45192	7-148
Al 99F11	h=2,0mm	45193	7-148
Miedź	h=1,0mm	50300	7-148
Miedź	h=1,5mm	50301	7-148
Miedź	h=2,0mm	50302	7-149
Miedź	h=2,5mm	50303	7-149
Cu/FESTAPLAN	h=1,5mm	50332	7-149
Cu/FESTAPLAN	h=2,0mm	50333	7-149
Cu/FESTAPLAN	h=2,5mm	50334	7-150

45191 Pierścienie uszczelniające, h=1 mm, twardość HB 32-45

W01D

Material Aluminium 99F11 DIN 7603 A



d ₁ x d ₂	☒	Kod artykułu	d ₁ x d ₂	☒	Kod artykułu	d ₁ x d ₂	☒	Kod artykułu
4X8MM	100	45191.040.008	6,5X9,5MM	100	45191.065.009	8X14MM	100	45191.080.014
5X7,5MM	100	45191.050.007	8X11,5MM	100	45191.080.011	10X13,5MM	100	45191.100.013
5X9MM	100	45191.050.009	8X12MM	100	45191.080.012	10X14MM	100	45191.100.014
6X10MM	100	45191.060.010	8X13MM	100	45191.080.013	10X16MM	100	45191.100.016
6X12MM (#DIN)	100	45191.060.012						

Nadaje się do połączeń rurowych i korków wkręcanych.

45192	Pierścienie uszczelniające, h=1,5 mm, twardość HB 32-45	W01D
Materiał	Aluminium 99F11	DIN 7603 A



$d_1 \times d_2$	☒	Kod artykułu	$d_1 \times d_2$	☒	Kod artykułu	$d_1 \times d_2$	☒	Kod artykułu
12X15,5MM	100	45192.120.015	15X19MM	100	45192.150.019	18X24MM	100	45192.180.024
12X16MM	100	45192.120.016	16X20MM	100	45192.160.020	20X24MM	50	45192.200.024
12X17MM	100	45192.120.017	16X22MM	100	45192.160.022	20X26MM	50	45192.200.026
12X18MM	100	45192.120.018	17X21MM	100	45192.170.021	21X28MM (≠DIN)	50	45192.210.028
13X18MM (≠DIN)	100	45192.130.018	17X23MM	100	45192.170.023	22X27MM	50	45192.220.027
14X18MM	100	45192.140.018	18X22MM	100	45192.180.022	22X29MM	50	45192.220.029
14X20MM	100	45192.140.020						

Nadaje się do połączeń rurowych i korków wkręcanych.



45193	Pierścienie uszczelniające, h=2 mm, twardość HB 32-45	W01D
Materiał	Aluminium 99F11	DIN 7603 A



$d_1 \times d_2$	☒	Kod artykułu	$d_1 \times d_2$	☒	Kod artykułu	$d_1 \times d_2$	☒	Kod artykułu
24X29MM	50	45193.240.029	28X34MM (≠DIN)	10	45193.280.034	40X47MM	10	45193.400.047
24X30MM (≠DIN)	50	45193.240.030	30X36MM	10	45193.300.036	42X49MM	10	45193.420.049
26X31MM	50	45193.260.031	30X38MM	10	45193.300.038	48X55MM	10	45193.480.055
26X32MM	50	45193.260.032	32X38MM	10	45193.320.038	50X57MM	10	45193.500.057
26X34MM	10	45193.260.034	33X39MM	10	45193.330.039			
27X32MM	10	45193.270.032	35X41MM	10	45193.350.041			

Nadaje się do połączeń rurowych i korków wkręcanych.

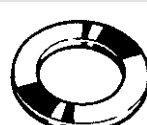

50300	Pierścienie uszczelniające, h=1 mm	M03A
Materiał	Miedź	DIN 7603 A

$d_1 \times d_2$	☒	Kod artykułu	$d_1 \times d_2$	☒	Kod artykułu	$d_1 \times d_2$	☒	Kod artykułu
5X10MM (≠DIN)	100	50300.050.010	8X14MM	100	50300.080.014	14X18MM (≠DIN)	50	50300.140.018
6X10MM	100	50300.060.010	9X14MM (≠DIN)	100	50300.090.014	14X20MM (≠DIN)	50	50300.140.020
6X12MM	100	50300.060.012	10X14MM	100	50300.100.014	15X20MM (≠DIN)	50	50300.150.020
6,5X9,5MM	100	50300.065.009	10X15MM	100	50300.100.015	28X33MM	100	50300.280.033
7X10MM (≠DIN)	100	50300.070.010	10X16MM	100	50300.100.016			
8X12MM	100	50300.080.012	12X16MM (≠DIN)	50	50300.120.016			



Nadaje się do połączeń rurowych i korków wkręcanych.

50301	Pierścienie uszczelniające, h=1,5 mm	M03A
Materiał	Miedź	DIN 7603 A



$d_1 \times d_2$	☒	Kod artykułu	$d_1 \times d_2$	☒	Kod artykułu	$d_1 \times d_2$	☒	Kod artykułu
6X10MM	100	50301.060.010	12X18MM	50	50301.120.018	17X21MM	50	50301.170.021
8X14MM	100	50301.080.014	12X20MM (≠DIN)	50	50301.120.020	17X22MM (≠DIN)	50	50301.170.022
9X14MM (≠DIN)	100	50301.090.014	12,5X20MM (≠DIN)	50	50301.125.020	18X22MM	25	50301.180.022
10X14MM	100	50301.100.014	13X18MM (≠DIN)	50	50301.130.018	18X24MM	25	50301.180.024
10X16MM	100	50301.100.016	14X18MM	50	50301.140.018	20X24MM	25	50301.200.024
10X20MM (≠DIN)	100	50301.100.020	14X20MM	50	50301.140.020	20X26MM	25	50301.200.026
10,5X17MM (≠DIN)	100	50301.105.017	14X22MM (≠DIN)	50	50301.140.022	21X26MM	25	50301.210.026
11X17MM (≠DIN)	100	50301.110.017	15X20MM (≠DIN)	50	50301.150.020	21X28MM (≠DIN)	25	50301.210.028
12X16MM	50	50301.120.016	16X20MM	50	50301.160.020	22X27MM	25	50301.220.027
12X17MM	50	50301.120.017	16X22MM	50	50301.160.022	22X29MM	25	50301.220.029

Nadaje się do połączeń rurowych i korków wkręcanych.

50302	Pierścienie uszczelniające, h=2 mm			M03A
Materiał	Miedź	DIN	7603 A	
				



d ₁ x d ₂	☒	Kod artykułu	d ₁ x d ₂	☒	Kod artykułu	d ₁ x d ₂	☒	Kod artykułu
7,1X15MM (#DIN)	100	50302.071.015	19X26MM (#DIN)	25	50302.190.026	28X34MM (#DIN)	10	50302.280.034
10X19MM (#DIN)	100	50302.100.019	20X24MM (#DIN)	25	50302.200.024	30X36MM	10	50302.300.036
13X18MM (#DIN)	50	50302.130.018	21X26MM (#DIN)	25	50302.210.026	30X38MM	10	50302.300.038
14X18MM (#DIN)	50	50302.140.018	21X28MM (#DIN)	25	50302.210.028	32X38MM	10	50302.320.038
14X20MM (#DIN)	50	50302.140.020	22X26MM (#DIN)	25	50302.220.026	32X40MM	10	50302.320.040
15X20MM (#DIN)	50	50302.150.020	22X29MM (#DIN)	25	50302.220.029	33X39MM	10	50302.330.039
16X20MM (#DIN)	50	50302.160.020	24X30MM (#DIN)	25	50302.240.030	35X45MM (#DIN)	10	50302.350.045
16X21MM (#DIN)	50	50302.160.021	24X32MM	25	50302.240.032	36X42MM	10	50302.360.042
16X22MM (#DIN)	50	50302.160.022	26X31MM	10	50302.260.031	38X44MM	10	50302.380.044
16,5X24MM (#DIN)	25	50302.165.024	26X32MM	10	50302.260.032	40X47MM	10	50302.400.047
17X24MM (#DIN)	25	50302.170.024	26X33MM (#DIN)	10	50302.260.033	45X52MM	10	50302.450.052
17,5X25MM (#DIN)	25	50302.175.025	26X34MM	10	50302.260.034	50X57MM	10	50302.500.057
18X24MM (#DIN)	25	50302.180.024						

Nadaje się do połączeń rurowych i korków wkręcanych.

50303	Pierścienie uszczelniające, h=2,5 mm			M03A
Materiał	Miedź	DIN	7603 A	
				



d ₁ x d ₂	☒	Kod artykułu	d ₁ x d ₂	☒	Kod artykułu	d ₁ x d ₂	☒	Kod artykułu
60X68MM	10	50303.600.068	75X84MM	10	50303.750.084	90X100MM	10	50303.900.100

Nadaje się do połączeń rurowych i korków wkręcanych.

50332	Pierścienie uszczelniające FESTAPLAN, h=1,5 mm			M03A
Materiał	Miedź/FESTAPLAN	DIN	7603 C	
				



d ₁ x d ₂	☒	Kod artykułu	d ₁ x d ₂	☒	Kod artykułu	d ₁ x d ₂	☒	Kod artykułu
5X9MM	100	50332.050.009	8X11,5MM	100	50332.080.011	10X13,5MM	100	50332.100.013
6X10MM	100	50332.060.010	8X12MM	100	50332.080.012	10X14MM	100	50332.100.014
6X12MM (#DIN)	100	50332.060.012	8X14MM	100	50332.080.014	10X16MM	100	50332.100.016

Włókna mineralne o nazwie handlowej FESTAPLAN. Odpowiednie do zastosowań w temperaturze maks. 180°C.

50333	Pierścienie uszczelniające FESTAPLAN, h=2 mm			M03A
Materiał	Miedź/FESTAPLAN	DIN	7603 C	
				

d ₁ x d ₂	☒	Kod artykułu	d ₁ x d ₂	☒	Kod artykułu	d ₁ x d ₂	☒	Kod artykułu
12X16MM	100	50333.120.016	16X22MM	100	50333.160.022	20X26MM	50	50333.200.026
12X18MM	100	50333.120.018	17X21MM	100	50333.170.021	21X26MM	50	50333.210.026
13X18MM (#DIN)	100	50333.130.018	17X23MM	100	50333.170.023	22X27MM	50	50333.220.027
14X18MM	100	50333.140.018	18X22MM	100	50333.180.022	22X29MM	50	50333.220.029
14X20MM	100	50333.140.020	18X24MM	50	50333.180.024			
16X20MM	100	50333.160.020	20X24MM	50	50333.200.024			

Włókna mineralne o nazwie handlowej FESTAPLAN. Odpowiednie do zastosowań w temperaturze maks. 180°C.

50334	Pierścienie uszczelniające FESTAPLAN, h=2,5 mm	M03A
Materiał	Miedź/FESTAPLAN	DIN 7603 C
		 

$d_1 \times d_2$	☒	Kod artykułu	$d_1 \times d_2$	☒	Kod artykułu	$d_1 \times d_2$	☒	Kod artykułu
24X29MM	25	50334.240.029	28X34MM (#DIN)	25	50334.280.034	36X42MM	25	50334.360.042
24X30MM (#DIN)	25	50334.240.030	30X36MM	25	50334.300.036	38X44MM	25	50334.380.044
24X32MM	25	50334.240.032	30X38MM	25	50334.300.038	40X47MM	25	50334.400.047
26X32MM	25	50334.260.032	32X38MM	25	50334.320.038	42X49MM	25	50334.420.049
26X34MM	25	50334.260.034	33X39MM	25	50334.330.039	45X52MM (#DIN)	10	50334.450.052
27X32MM	25	50334.270.032	35X41MM	25	50334.350.041	48X55MM	10	50334.480.055

Włókna mineralne o nazwie handlowej FESTAPLAN. Odpowiednie do zastosowań w temperaturze maks. 180°C.

Pierścienie uszczelniające

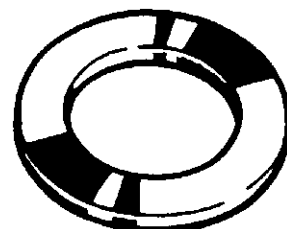
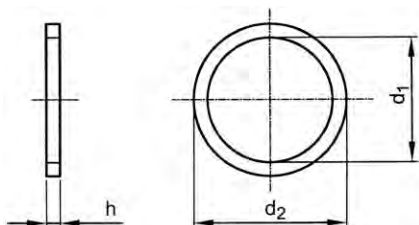



50900	Pierścienie uszczelniające h=1mm	W05C
Materiał	Włókno wulkanizowane Vf3110 DIN 737	
		

$d_1 \times d_2$	☒	Kod artykułu	$d_1 \times d_2$	☒	Kod artykułu	$d_1 \times d_2$	☒	Kod artykułu
3X5MM	200	50900.030.005	8,5X14MM	200	50900.085.014	18X24MM	100	50900.180.024
3,5X6MM	200	50900.035.006	9X14MM	200	50900.090.014	19X23MM	100	50900.190.023
4X6,5MM	200	50900.040.006	9,5X14MM	200	50900.095.014	20X24MM	100	50900.200.024
4,5X8MM	200	50900.045.008	10X14MM	200	50900.100.014	22X26MM	50	50900.220.026
5X8MM	200	50900.050.008	10,5X17MM	200	50900.105.017	24X28MM	50	50900.240.028
5X10MM	200	50900.050.010	11X17MM	200	50900.110.017	25X34MM	50	50900.250.034
5,5X9MM	200	50900.055.009	12X16MM	200	50900.120.016	26X33MM	50	50900.260.033
6X9MM	200	50900.060.009	12,5X18MM	100	50900.125.018	28X40MM	50	50900.280.040
6X10MM	200	50900.060.010	13X18MM	100	50900.130.018	30X42MM	50	50900.300.042
6X12MM	200	50900.060.012	14X18MM	100	50900.140.018	32X44MM	25	50900.320.044
6,5X10MM	200	50900.065.010	15X19MM	100	50900.150.019	34X46MM	25	50900.340.046
7X10MM	200	50900.070.010	16X20MM	100	50900.160.020	36X48MM	25	50900.360.048
8X12MM	200	50900.080.012	16X21MM	100	50900.160.021	38X50MM	25	50900.380.050
8X16MM	200	50900.080.016	17X22MM	100	50900.170.022	40X52MM	25	50900.400.052

7

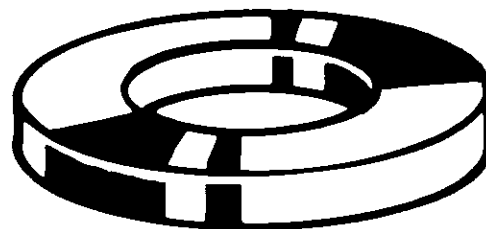
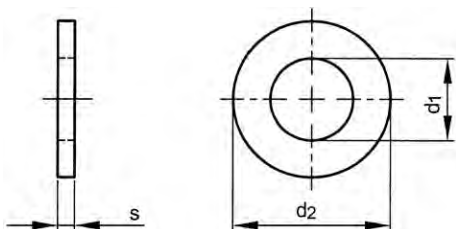
Podkładki płaskie



72037	Podkładki płaskie	Y92E
Materiał	Włókno wulkanizowane	

$d_1 \times d_2 \times s$	☒	Kod artykułu	$d_1 \times d_2 \times s$	☒	Kod artykułu
12X24X2MM	25	72037.120.020	18X28X2MM	25	72037.180.020

Podkładki uszczelniające z wkładką gumową, samocentrujące

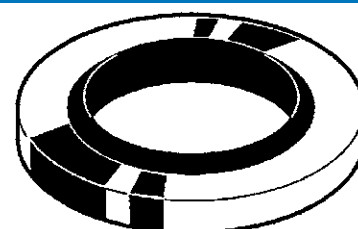
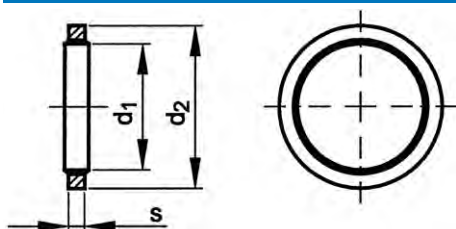

- Cechy szczególne podkładek uszczelniających z gumą:
- Nadają się zwłaszcza do połączeń śrubowych, połączeń rurowych, połączeń węzowych, etc.
- Krawędź uszczelniająca z kauczuku nitylowego jest odporna na olej mineralny, wodę, gaz i wiele innych czynników.

Grupy katalogowe

Materiał	Obróbka powierzchni	Kod	Strona
St	Ocynk.	38793	7-151
St	Ocynk.	38796	7-151

38793	Podkładki uszczelniające z wkładką gumową, samocentrujące	L07G
Materiał	Stal	
Obróbka powierzchni	Ocynkowane	

$d_1 \times d_2 \times s$	☒	Kod artykułu	$d_1 \times d_2 \times s$	☒	Kod artykułu	$d_1 \times d_2 \times s$	☒	Kod artykułu
4,5X7X1MM	100	38793.052.100	12,7X18X1,5MM	100	38793.145.150	22,7X30X2MM	25	38793.257.200
5,7X10X1MM	100	38793.067.100	12,7X20X1,5MM	100	38793.147.150	24,7X32X2MM	25	38793.279.200
6,7X11X1MM	100	38793.078.100	14,7X22X1,5MM	50	38793.169.150	26,7X35X2MM	25	38793.302.200
7,1X12X1MM	100	38793.083.100	16,7X24X1,5MM	50	38793.191.150	27,2X36X2MM	25	38793.308.200
8,7X16X1MM	100	38793.103.100	18,7X26X1,5MM	50	38793.213.150	28,7X37X2MM	25	38793.324.200
10,7X18X1,5MM	100	38793.125.150	20,7X28X1,5MM	50	38793.235.150	31X39X2MM	10	38793.349.200

38796	Podkładki uszczelniające z wkładką gumową, samocentrujące	L07G
Materiał	Stal	
Obróbka powierzchni	Ocynkowane	

$d_1 \times d_2 \times s$	☒	Kod artykułu	$d_1 \times d_2 \times s$	☒	Kod artykułu	$d_1 \times d_2 \times s$	☒	Kod artykułu
13,34X6,99X1,22	50	38796.000.010	23,8X17,28X2,03	25	38796.000.016	36,58X29,33X2,34	10	38796.000.021
13,34X8,31X1,22	50	38796.000.011	26,92X19,69X2,34	25	38796.000.017	41,4X32,64X3,25	10	38796.000.022
15,88X10,37X2,03	50	38796.000.012	28,58X21,54X2,34	10	38796.000.018	42,8X33,89X3,25	10	38796.000.023
20,57X13,74X2,03	50	38796.000.014	31,75X23,49X2,34	10	38796.000.019	47,75X38,96X3,25	10	38796.000.025
25,4X16,51X2,03	25	38796.000.015	34,93X27,05X2,34	10	38796.000.020	52,38X42,93X3,25	10	38796.000.026

38796 Podkładki uszczelniające z wkładką gumową, samocentrujące

$d_1 \times d_2 \times s$	☒	Kod artykułu	$d_1 \times d_2 \times s$	☒	Kod artykułu
69,85X54,89X3,25	10	38796.000.027	15,9X10,5X2,1	10	38796.000.221

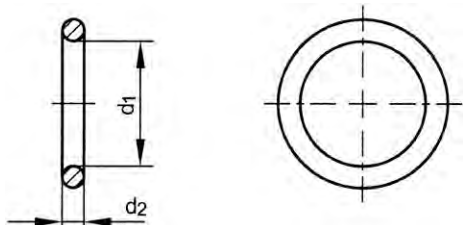
Pierścienie uszczelniające o przekroju okrągłym

• d_1 = średnica wewnętrzna.

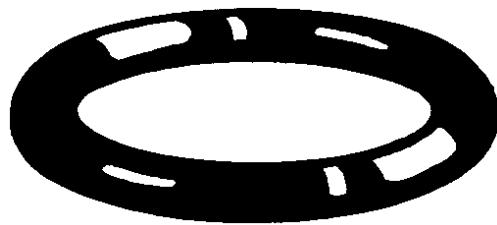
Grupy katalogowe

Material	Kolor	Kod	Strona	
Guma NBR 70° Shore A	d2=1,5mm	Czarny	38801	7-152
Guma NBR 70° Shore A	d2=1,6mm	Czarny	38802	7-152
Guma NBR 70° Shore A	d2=1,78mm	Czarny	38803	7-153
Guma NBR 70° Shore A	d2=2,0mm	Czarny	38805	7-153
Guma NBR 70° Shore A	d2=2,4mm	Czarny	38806	7-153
Guma NBR 70° Shore A	d2=2,5mm	Czarny	38807	7-153
Guma NBR 70° Shore A	d2=2,62mm	Czarny	38808	7-154
Guma NBR 70° Shore A	d2=3,0mm	Czarny	38810	7-154
Guma NBR 70° Shore A	d2=3,53mm	Czarny	38812	7-155
Guma NBR 70° Shore A	d2=4,0mm	Czarny	38814	7-155
Guma NBR 70° Shore A	d2=5,0mm	Czarny	38816	7-155
Guma FPM 80° Shore	d2=1,6mm	Czarny	38869	7-156
Guma FPM 80° Shore	d2=1,78mm	Czarny	38871	7-156
Guma FPM 80° Shore	d2=1,9mm	Czarny	38873	7-156
Guma FPM 80° Shore	d2=2,0mm	Czarny	38874	7-156
Guma FPM 80° Shore	d2=2,4mm	Czarny	38875	7-156
Guma FPM 80° Shore	d2=2,62mm	Czarny	38877	7-157
Guma FPM 80° Shore	d2=3,53mm	Czarny	38883	7-157
Guma FPM 80° Shore	d2=4,0mm	Czarny	38885	7-157
Guma FPM 80° Shore	d2=5,0mm	Czarny	38887	7-157

7

38801 Pierścienie uszczelniające o przekroju okrągłym, d2=1,5 mm

W05A

Material Guma NBR 70° Shore A
Kolor Czarny



d_1	☒	Kod artykułu	d_1	☒	Kod artykułu	d_1	☒	Kod artykułu
3,0MM	50	38801.003.001	7,0MM	50	38801.007.001	9,0MM	50	38801.009.001
5,0MM	50	38801.005.001	7,5MM	50	38801.007.501	35,0MM	10	38801.035.001
6,0MM	50	38801.006.001	8,0MM	50	38801.008.001			

38802 Pierścienie uszczelniające o przekroju okrągłym, d2=1,6 mm

W05A

Material Guma NBR 70° Shore A
Kolor Czarny



d_1	☒	Kod artykułu	d_1	☒	Kod artykułu	d_1	☒	Kod artykułu
3,1MM	50	38802.003.101	12,1MM	25	38802.012.101	21,1MM	25	38802.021.101
4,1MM	50	38802.004.101	13,1MM	25	38802.013.101	22,1MM	10	38802.022.101
5,1MM	50	38802.005.101	14,1MM	25	38802.014.101	25,1MM	10	38802.025.101
6,1MM	50	38802.006.101	15,1MM	25	38802.015.101	27,1MM	10	38802.027.101
7,1MM	50	38802.007.101	16,1MM	25	38802.016.101	29,1MM	10	38802.029.101
8,1MM	50	38802.008.101	17,1MM	25	38802.017.101	32,1MM	10	38802.032.101
9,1MM	50	38802.009.101	18,1MM	25	38802.018.101	35,1MM	10	38802.035.101
10,1MM	25	38802.010.101	19,1MM	25	38802.019.101	37,1MM	10	38802.037.101
11,1MM	25	38802.011.101	20,1MM	25	38802.020.101			

38803 Pierścienie uszczelniające o przekroju okrągłym, d2=1,78 mm W05A

Materiał Guma NBR 70° Shore A
Kolor Czarny



d ₁	☒	Kod artykułu	d ₁	☒	Kod artykułu	d ₁	☒	Kod artykułu
1,78-AS 004	50	38803.001.781	10,82-AS 013	50	38803.010.821	34,65-AS 028	10	38803.034.651
2,57-AS 005	50	38803.002.571	11,11MM	50	38803.011.111	36,27MM	10	38803.036.271
2,90-AS 006	50	38803.002.901	12,42-AS 014	50	38803.012.421	37,82-AS 029	10	38803.037.821
3,17MM	50	38803.003.171	14,00-AS 015	50	38803.014.001	41,00-AS 030	10	38803.041.001
3,68-AS 007	50	38803.003.681	15,60-AS 016	25	38803.015.601	44,17-AS 031	10	38803.044.171
3,69-AS 007	50	38803.003.691	17,16-AS 017	25	38803.017.161	47,37-AS 032	10	38803.047.371
4,48-AS 008	50	38803.004.481	18,77-AS 018	25	38803.018.771	50,52-AS 033	10	38803.050.521
4,76MM	50	38803.004.761	20,35-AS 019	25	38803.020.351	53,67-AS 034	5	38803.053.671
5,28-AS 009	50	38803.005.281	21,95-AS 020	25	38803.021.951	56,87-AS 035	5	38803.056.871
6,07-AS 010	50	38803.006.071	25,12-AS 022	10	38803.025.121	60,04MM	5	38803.060.041
6,35MM	50	38803.006.351	26,70-AS 023	10	38803.026.701	63,22-AS 037	5	38803.063.221
6,75MM	50	38803.006.751	28,30-AS 024	10	38803.028.301	66,40-AS 038	5	38803.066.401
7,66-AS 011	50	38803.007.661	29,87-AS 025	10	38803.029.871	69,57-AS 039	5	38803.069.571
7,94MM	50	38803.007.941	31,47-AS 026	10	38803.031.471	72,76-AS 040	5	38803.072.761
8,73MM	50	38803.008.731	33,05-AS 027	10	38803.033.051	82,28-AS 042	5	38803.082.281
9,25-AS 012	50	38803.009.251						

38805 Pierścienie uszczelniające o przekroju okrągłym, d2=2,0 mm W05A

Materiał Guma NBR 70° Shore A
Kolor Czarny



d ₁	☒	Kod artykułu	d ₁	☒	Kod artykułu	d ₁	☒	Kod artykułu
4,0MM	50	38805.004.001	18,0MM	25	38805.018.001	36,0MM	10	38805.036.001
5,0MM	50	38805.005.001	19,0MM	25	38805.019.001	37,0MM	10	38805.037.001
5,5MM	50	38805.005.501	20,0MM	10	38805.020.001	38,0MM	10	38805.038.001
6,0MM	50	38805.006.001	21,0MM	10	38805.021.001	40,0MM	10	38805.040.001
7,0MM	50	38805.007.001	22,0MM	10	38805.022.001	42,0MM	10	38805.042.001
8,0MM	50	38805.008.001	23,0MM	10	38805.023.001	43,0MM	10	38805.043.001
9,0MM	50	38805.009.001	24,0MM	10	38805.024.001	45,0MM	10	38805.045.001
10,0MM	50	38805.010.001	25,0MM	10	38805.025.001	46,0MM	10	38805.046.001
11,0MM	50	38805.011.001	26,0MM	10	38805.026.001	47,0MM	10	38805.047.001
12,0MM	50	38805.012.001	27,0MM	10	38805.027.001	50,0MM	10	38805.050.001
13,0MM	25	38805.013.001	28,0MM	10	38805.028.001	53,0MM	5	38805.053.001
14,0MM	25	38805.014.001	30,0MM	10	38805.030.001	55,0MM	5	38805.055.001
15,0MM	25	38805.015.001	32,0MM	10	38805.032.001	56,0MM	5	38805.056.001
16,0MM	25	38805.016.001	33,0MM	10	38805.033.001	58,0MM	5	38805.058.001
17,0MM	25	38805.017.001	35,0MM	10	38805.035.001			

38806 Pierścienie uszczelniające o przekroju okrągłym, d2=2,4 mm W05A

Materiał Guma NBR 70° Shore A
Kolor Czarny



d ₁	☒	Kod artykułu	d ₁	☒	Kod artykułu	d ₁	☒	Kod artykułu
5,3MM	50	38806.005.301	9,3MM	50	38806.009.301	14,3MM	25	38806.014.301
6,3MM	50	38806.006.301	10,3MM	50	38806.010.301	16,3MM	25	38806.016.301
7,3MM	50	38806.007.301	11,3MM	50	38806.011.301	17,3MM	25	38806.017.301
8,0MM	50	38806.008.001	12,3MM	50	38806.012.301	20,3MM	25	38806.020.301
8,3MM	50	38806.008.301	13,3MM	50	38806.013.301	25,3MM	25	38806.025.301

38807 Pierścienie uszczelniające o przekroju okrągłym, d2=2,5 mm W05A

Materiał Guma NBR 70° Shore A
Kolor Czarny



d ₁	☒	Kod artykułu	d ₁	☒	Kod artykułu	d ₁	☒	Kod artykułu
5,0MM	50	38807.005.001	8,0MM	50	38807.008.001	11,0MM	50	38807.011.001
6,0MM	50	38807.006.001	9,0MM	50	38807.009.001	12,0MM	50	38807.012.001
7,0MM	50	38807.007.001	10,0MM	50	38807.010.001	13,0MM	50	38807.013.001

38807 Pierścienie uszczelniające o przekroju okrągłym, d2=2,5 mm								
d ₁	☒	Kod artykułu	d ₁	☒	Kod artykułu	d ₁	☒	Kod artykułu
14,0MM	25	38807.014.001	23,0MM	10	38807.023.001	32,0MM	10	38807.032.001
15,0MM	25	38807.015.001	24,0MM	10	38807.024.001	35,0MM	10	38807.035.001
16,0MM	25	38807.016.001	25,0MM	10	38807.025.001	36,0MM	10	38807.036.001
17,0MM	25	38807.017.001	26,0MM	10	38807.026.001	38,0MM	10	38807.038.001
18,0MM	10	38807.018.001	27,0MM	10	38807.027.001	39,0MM	10	38807.039.001
19,0MM	10	38807.019.001	28,0MM	10	38807.028.001	40,0MM	10	38807.040.001
20,0MM	10	38807.020.001	29,0MM	10	38807.029.001	44,0MM	10	38807.044.001
21,0MM	10	38807.021.001	30,0MM	10	38807.030.001			
22,0MM	10	38807.022.001	31,0MM	10	38807.031.001			

38808 Pierścienie uszczelniające o przekroju okrągłym, d2=2,62 mm		W05A
Materiał	Guma NBR 70° Shore A	
Kolor	Czarny	

d ₁	☒	Kod artykułu	d ₁	☒	Kod artykułu	d ₁	☒	Kod artykułu
9,19-AS 110	50	38808.009.191	22,22MM	10	38808.022.221	50,47-AS 136	5	38808.050.471
9,92MM	50	38808.009.921	23,47-AS 119	10	38808.023.471	52,07-AS 137	5	38808.052.071
10,78-AS 111	50	38808.010.781	23,81MM	10	38808.023.811	55,25-AS 139	5	38808.055.251
11,91MM	50	38808.011.911	25,07-AS 120	10	38808.025.071	56,82-AS 140	5	38808.056.821
12,37-AS 112	50	38808.012.371	26,64MM	10	38808.026.641	58,42-AS 141	5	38808.058.421
12,70MM	50	38808.012.701	29,82-AS 123	10	38808.029.821	60,00-AS 142	5	38808.060.001
13,10MM	25	38808.013.101	31,42-AS 124	10	38808.031.421	61,60-AS 143	5	38808.061.601
13,95-AS 113	25	38808.013.951	33,00-AS 125	10	38808.033.001	63,17-AS 144	5	38808.063.171
15,08MM	25	38808.015.081	34,59-AS 126	10	38808.034.591	64,77-AS 145	5	38808.064.771
15,54-AS 114	25	38808.015.541	36,17-AS 127	10	38808.036.171	67,95-AS 147	5	38808.067.951
15,88MM	25	38808.015.881	37,77-AS 128	10	38808.037.771	69,52-AS 148	5	38808.069.521
17,13-AS 115	25	38808.017.131	39,34-AS 129	10	38808.039.341	71,12-AS 149	5	38808.071.121
17,86MM	25	38808.017.861	40,95-AS 130	10	38808.040.951	74,30MM	5	38808.074.301
18,72-AS 116	25	38808.018.721	44,12-AS 132	10	38808.044.121	80,60MM	5	38808.080.601
20,29-AS 117	10	38808.020.291	45,69-AS 133	10	38808.045.691	82,22-AS 152	5	38808.082.221
20,63MM	10	38808.020.631	47,29-AS 134	10	38808.047.291	83,80MM	5	38808.083.801
21,89-AS 118	10	38808.021.891	48,90-AS 135	10	38808.048.901	94,93MM	5	38808.094.931

38810 Pierścienie uszczelniające o przekroju okrągłym, d2=3,0 mm		W05A
Materiał	Guma NBR 70° Shore A	
Kolor	Czarny	

d ₁	☒	Kod artykułu	d ₁	☒	Kod artykułu	d ₁	☒	Kod artykułu
5,0MM	50	38810.005.001	26,0MM	10	38810.026.001	52,0MM	5	38810.052.001
6,0MM	50	38810.006.001	26,2MM	10	38810.026.201	54,5MM	5	38810.054.501
7,0MM	50	38810.007.001	27,0MM	10	38810.027.001	56,0MM	5	38810.056.001
8,0MM	50	38810.008.001	28,0MM	10	38810.028.001	58,0MM	5	38810.058.001
9,0MM	50	38810.009.001	29,0MM	10	38810.029.001	59,0MM	5	38810.059.001
10,0MM	50	38810.010.001	30,0MM	10	38810.030.001	62,0MM	5	38810.062.001
11,0MM	50	38810.011.001	31,0MM	10	38810.031.001	64,5MM	5	38810.064.501
12,0MM	50	38810.012.001	32,0MM	10	38810.032.001	66,0MM	5	38810.066.001
13,0MM	50	38810.013.001	33,0MM	10	38810.033.001	72,0MM	5	38810.072.001
14,0MM	25	38810.014.001	34,0MM	10	38810.034.001	74,5MM	5	38810.074.501
15,0MM	25	38810.015.001	35,0MM	10	38810.035.001	78,0MM	5	38810.078.001
16,0MM	25	38810.016.001	36,0MM	10	38810.036.001	79,5MM	5	38810.079.501
17,0MM	25	38810.017.001	37,0MM	10	38810.037.001	84,5MM	5	38810.084.501
18,0MM	25	38810.018.001	38,0MM	10	38810.038.001	89,5MM	5	38810.089.501
19,0MM	25	38810.019.001	39,0MM	10	38810.039.001	108,0MM	5	38810.108.001
20,0MM	25	38810.020.001	40,0MM	10	38810.040.001	119,5MM	5	38810.119.501
20,2MM	10	38810.020.201	41,0MM	10	38810.041.001	175,0MM	5	38810.175.001
21,0MM	10	38810.021.001	42,0MM	10	38810.042.001	180,0MM	5	38810.180.001
22,0MM	10	38810.022.001	43,0MM	10	38810.043.001	195,0MM	5	38810.195.001
22,2MM	10	38810.022.201	44,0MM	10	38810.044.001	210,0MM	5	38810.210.001
23,0MM	10	38810.023.001	45,0MM	10	38810.045.001	220,0MM	5	38810.220.001
24,0MM	10	38810.024.001	46,0MM	10	38810.046.001	245,0MM	5	38810.245.001
24,2MM	10	38810.024.201	47,0MM	10	38810.047.001	250,0MM	5	38810.250.001
25,0MM	10	38810.025.001	48,0MM	10	38810.048.001	300,0MM	5	38810.300.001

38812	Pierścienie uszczelniające o przekroju okrągłym, d2=3,53 mm	W05A
Materiał	Guma NBR 70° Shore A	
Kolor	Czarny	

d ₁	☒	Kod artykułu	d ₁	☒	Kod artykułu	d ₁	☒	Kod artykułu
18,64-AS 210	25	38812.018.641	44,45MM	10	38812.044.451	72,62-AS 233	5	38812.072.621
20,22-AS 211	10	38812.020.221	46,04MM	10	38812.046.041	74,60MM	5	38812.074.601
21,82-AS 212	10	38812.021.821	47,22-AS 225	10	38812.047.221	78,97-AS 235	5	38812.078.971
23,40-AS 213	10	38812.023.401	49,21MM	10	38812.049.211	82,14-AS 236	5	38812.082.141
24,99-AS 214	10	38812.024.991	50,40MM	5	38812.050.401	85,32-AS 237	5	38812.085.321
25,80MM	10	38812.025.801	50,80-AS 226	5	38812.050.801	91,67-AS 238	5	38812.091.671
26,58-AS 215	10	38812.026.581	52,39MM	5	38812.052.391	94,84-AS 240	5	38812.094.841
28,17-AS 216	10	38812.028.171	53,57-AS 227	5	38812.053.571	98,02-AS 241	5	38812.098.021
29,75-AS 217	10	38812.029.751	53,98MM	5	38812.053.981	101,20-AS 242	5	38812.101.201
31,34-AS 218	10	38812.031.341	55,56MM	5	38812.055.561	104,37-AS 243	5	38812.104.371
32,92-AS 219	10	38812.032.941	57,15MM	5	38812.057.151	107,54-AS 244	5	38812.107.541
34,52-AS 220	10	38812.034.521	58,74MM	5	38812.058.741	110,72-AS 245	5	38812.110.721
36,10-AS 221	10	38812.036.101	59,92-AS 229	5	38812.059.921	117,07-AS 247	5	38812.117.071
37,69-AS 222	10	38812.037.691	60,33MM	5	38812.060.331	123,42-AS 249	5	38812.123.421
39,69MM	10	38812.039.691	66,27-AS 231	5	38812.066.271	132,94-AS 252	5	38812.132.941
40,87-AS 223	10	38812.040.871	68,26MM	5	38812.068.261	136,12-AS 253	5	38812.136.121
41,28MM	10	38812.041.281	69,44-AS 232	5	38812.069.441	142,47-AS 255	5	38812.142.471
42,86MM	10	38812.042.861	69,85MM	5	38812.069.851	151,99-AS 258	5	38812.151.991
44,04-AS 224	10	38812.044.041	71,44MM	5	38812.071.441			

38814	Pierścienie uszczelniające o przekroju okrągłym, d2=4,0 mm	W05A
Materiał	Guma NBR 70° Shore A	
Kolor	Czarny	

d ₁	☒	Kod artykułu	d ₁	☒	Kod artykułu	d ₁	☒	Kod artykułu
9,0MM	50	38814.009.001	30,0MM	10	38814.030.001	55,0MM	5	38814.055.001
10,0MM	50	38814.010.001	32,0MM	10	38814.032.001	58,0MM	5	38814.058.001
12,0MM	25	38814.012.001	34,0MM	10	38814.034.001	59,0MM	5	38814.059.001
14,0MM	25	38814.014.001	35,0MM	10	38814.035.001	60,0MM	5	38814.060.001
16,0MM	25	38814.016.001	36,0MM	10	38814.036.001	64,0MM	5	38814.064.001
18,0MM	25	38814.018.001	38,0MM	10	38814.038.001	65,0MM	5	38814.065.001
19,0MM	25	38814.019.001	40,0MM	10	38814.040.001	66,0MM	5	38814.066.001
20,0MM	25	38814.020.001	42,0MM	10	38814.042.001	70,0MM	5	38814.070.001
21,0MM	25	38814.021.001	43,0MM	10	38814.043.001	72,0MM	5	38814.072.001
22,0MM	25	38814.022.001	44,0MM	10	38814.044.001	75,0MM	5	38814.075.001
23,0MM	25	38814.023.001	48,0MM	10	38814.048.001	78,0MM	5	38814.078.001
24,0MM	25	38814.024.001	49,0MM	10	38814.049.001	80,0MM	5	38814.080.001
25,0MM	10	38814.025.001	50,0MM	10	38814.050.001	87,0MM	5	38814.087.001
26,0MM	10	38814.026.001	52,0MM	5	38814.052.001	125,0MM	5	38814.125.001
28,0MM	10	38814.028.001						

38816	Pierścienie uszczelniające o przekroju okrągłym, d2=5,0 mm	W05A
Materiał	Guma NBR 70° Shore A	
Kolor	Czarny	

d ₁	☒	Kod artykułu	d ₁	☒	Kod artykułu	d ₁	☒	Kod artykułu
12,0MM	25	38816.012.001	22,0MM	10	38816.022.001	45,0MM	10	38816.045.001
15,0MM	25	38816.015.001	23,0MM	10	38816.023.001	48,0MM	10	38816.048.001
16,0MM	25	38816.016.001	25,0MM	10	38816.025.001	50,0MM	10	38816.050.001
17,0MM	25	38816.017.001	27,0MM	10	38816.027.001	55,0MM	5	38816.055.001
18,0MM	25	38816.018.001	30,0MM	10	38816.030.001	65,0MM	5	38816.065.001
19,0MM	25	38816.019.001	35,0MM	10	38816.035.001	70,0MM	5	38816.070.001
20,0MM	10	38816.020.001	40,0MM	10	38816.040.001	75,0MM	5	38816.075.001
21,0MM	10	38816.021.001						

38869 Pierścienie uszczelniające o przekroju okrągłym (Viton), d2=1,6 mm W07A

Materiał Guma FPM 80° Shore
Kolor Czarny



d ₁	☒	Kod artykułu	d ₁	☒	Kod artykułu	d ₁	☒	Kod artykułu
2,2MM	50	38869.002.201	4,7MM	50	38869.004.701	10,1MM	25	38869.010.101
2,8MM	50	38869.002.801	5,1MM	50	38869.005.101	11,1MM	25	38869.011.101
3,1MM	50	38869.003.101	6,1MM	50	38869.006.101	12,1MM	25	38869.012.101
3,7MM	50	38869.003.701	7,1MM	50	38869.007.101	13,1MM	25	38869.013.101
4,1MM	50	38869.004.101	9,1MM	50	38869.009.101			

38871 Pierścienie uszczelniające o przekroju okrągłym (Viton), d2=1,78 mm W07A

Materiał Guma FPM 80° Shore
Kolor Czarny



d ₁	☒	Kod artykułu	d ₁	☒	Kod artykułu	d ₁	☒	Kod artykułu
2,90-AS 006	50	38871.002.901	6,07-AS 010	50	38871.006.071	12,42-AS 014	25	38871.012.421
3,69-AS 007	50	38871.003.691	7,65MM	50	38871.007.651	14,00MM	25	38871.014.001
4,48-AS 008	50	38871.004.481	9,25-AS 012	50	38871.009.251	15,60-AS 016	25	38871.015.601
5,28-AS 009	50	38871.005.281	10,82-AS 013	25	38871.010.821	17,17MM	25	38871.017.171

38873 Pierścienie uszczelniające o przekroju okrągłym (Viton), d2=1,9 mm W07A

Materiał Guma FPM 80° Shore
Kolor Czarny



d ₁	☒	Kod artykułu	d ₁	☒	Kod artykułu	d ₁	☒	Kod artykułu
2,4MM	50	38873.002.401	4,2MM	50	38873.004.201	7,2MM	50	38873.007.201
2,6MM	50	38873.002.601	4,9MM	50	38873.004.901	8,9MM	50	38873.008.901
3,4MM	50	38873.003.401	5,7MM	50	38873.005.701			

38874 Pierścienie o przekroju okrągłym (Viton), d2=2,0 mm W07A

Materiał Guma FPM 80° Shore
Kolor Czarny



d ₁	☒	Kod artykułu	d ₁	☒	Kod artykułu	d ₁	☒	Kod artykułu
4,0MM	50	38874.004.001	10,0MM	25	38874.010.001	16,0MM	25	38874.016.001
6,0MM	50	38874.006.001	12,0MM	25	38874.012.001	18,0MM	25	38874.018.001
8,0MM	50	38874.008.001	14,0MM	25	38874.014.001	20,0MM	10	38874.020.001

38875 Pierścienie uszczelniające o przekroju okrągłym (Viton), d2=2,4 mm W07A

Materiał Guma FPM 80° Shore
Kolor Czarny



d ₁	☒	Kod artykułu	d ₁	☒	Kod artykułu	d ₁	☒	Kod artykułu
3,3MM	50	38875.003.301	8,3MM	50	38875.008.301	12,3MM	50	38875.012.301
4,3MM	50	38875.004.301	9,3MM	50	38875.009.301	13,3MM	25	38875.013.301
5,3MM	50	38875.005.301	10,3MM	25	38875.010.301	14,3MM	25	38875.014.301
6,3MM	50	38875.006.301	11,3MM	25	38875.011.301	15,3MM	25	38875.015.301
7,3MM	50	38875.007.301						

7

38877 Pierścienie uszczelniające o przekroju okrągłym (Viton), d2=2,62 mm W07A

Materiał Guma FPM 80° Shore
Kolor Czarny



d_1	☒	Kod artykułu	d_1	☒	Kod artykułu	d_1	☒	Kod artykułu
9,20MM	50	38877.009.201	15,54-AS 114	25	38877.015.541	20,30MM	10	38877.020.301
10,78-AS 111	25	38877.010.781	17,12MM	25	38877.017.121	21,90MM	10	38877.021.901
12,37-AS 112	25	38877.012.371	18,72-AS 116	25	38877.018.721	23,47-AS 119	10	38877.023.471
13,95-AS 113	25	38877.013.951						

38883 Pierścienie uszczelniające o przekroju okrągłym (Viton), d2=3,53 mm W07A

Materiał Guma FPM 80° Shore
Kolor Czarny



d_1	☒	Kod artykułu	d_1	☒	Kod artykułu	d_1	☒	Kod artykułu
18,64-AS 210	25	38883.018.641	26,57MM	10	38883.026.571	34,52-AS 220	10	38883.034.521
20,22-AS 211	10	38883.020.221	28,17-AS 216	10	38883.028.171	36,09MM	10	38883.036.091
21,82-AS 212	10	38883.021.821	29,74MM	10	38883.029.741	37,69MM	10	38883.037.691
23,39MM	10	38883.023.391	31,34-AS 218	10	38883.031.341	40,87-AS 223	10	38883.040.871
24,99-AS 214	10	38883.024.991	32,92MM	10	38883.032.921			

38885 Pierścienie uszczelniające o przekroju okrągłym (Viton), d2=4,0 mm W07A

Materiał Guma FPM 80° Shore
Kolor Czarny



d_1	☒	Kod artykułu	d_1	☒	Kod artykułu	d_1	☒	Kod artykułu
30,0MM	10	38885.030.001	34,0MM	10	38885.034.001	38,0MM	10	38885.038.001
32,0MM	10	38885.032.001	35,0MM	10	38885.035.001	40,0MM	10	38885.040.001

38887 Pierścienie uszczelniające o przekroju okrągłym (Viton), d2=5,0 mm W07A

Materiał Guma FPM 80° Shore
Kolor Czarny



d_1	☒	Kod artykułu	d_1	☒	Kod artykułu	d_1	☒	Kod artykułu
35,0MM	10	38887.035.001	45,0MM	10	38887.045.001	50,0MM	10	38887.050.001
40,0MM	10	38887.040.001						

Uszczelki gumowe

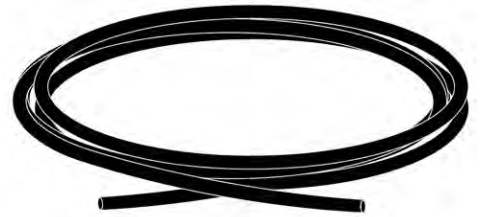
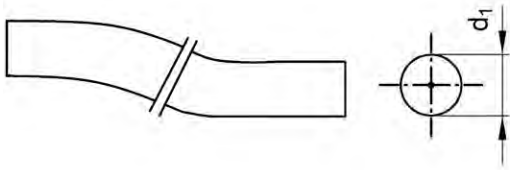

38840	Uszczelka gumowa 2m	W05A
Materiał	Guma NBR 70° Shore A	
Kolor	Czarny	

d_1	☒	Kod artykułu	d_1	☒	Kod artykułu	d_1	☒	Kod artykułu
1,78	1	38840.001.781	3,53	1	38840.003.531	5,7	1	38840.005.701
2,0	1	38840.002.001	4,0	1	38840.004.001	6,0	1	38840.006.001
2,40	1	38840.002.401	5,0	1	38840.005.001	6,99	1	38840.006.991
3,0	1	38840.003.001	5,34	1	38840.005.341	8,0	1	38840.008.001

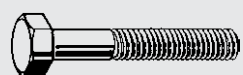

1 Śruby



2 Produkty z gniazdem sześciokątnym



3 Nakrętki, nitonakrętki & wkładki



4 Pręty gwintowane & śruby dwustronne



5 Haki & śruby oczkowe



6 Wkręty

I Index



7 Podkładki & pierścienie uszczelniające typu “O-ring”



8 Kotwy, kołki, dyble



9 Nity, kołki & wpusty



10 Elementy łączące systemowe, meblowe & zabezpieczające

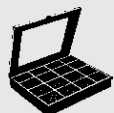

11 Zestawy

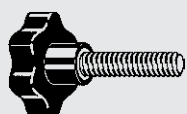



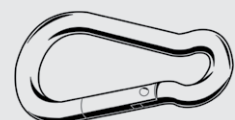



12 Części konstrukcyjne & części maszynowe





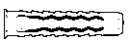













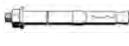

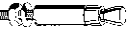
13 Przemysł morski

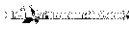
T Technologia łączenia

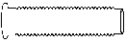
Kotwy, kołki, dyble 8

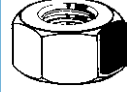
 Strona 8-4 MAXXFAST UniFast	 Strona 8-4 Kołki nylonowe	 Strona 8-7 FISCHER Typ S	 Strona 8-8 FISCHER Zestawy	 Strona 8-9 FISCHER Typ MS
 Strona 8-10 MAXXFAST MultiFast	 Strona 8-10 FISCHER Typ SX	 Strona 8-12 MAXXFAST 4Fast	 Strona 8-12 FISCHER Typ UX/UX-R	 Strona 8-13 FISCHER Uniwersalny typ FU
 Strona 8-14 Mocowania wnąkowe	 Strona 8-15 FISCHER Typ HM/HMS	 Strona 8-16 Narzędzia instalacyjne	 Strona 8-17 MAXXFAST kołki do płyt kartonowo-gipsowych	 Strona 8-18 SPIT Driva
 Strona 8-19 FISCHER Typ GK/GKS	 Strona 8-20 FISCHER Typ GB	 Strona 8-21 FISCHER Typ FTP, stal	 Strona 8-22 FISCHER Typ FTP, plastik	 Strona 8-23 FISCHER Narzędzia instalacyjne FTP
 Strona 8-24 Kołki przechylne	 Strona 8-25 SPIT Typ SDA	 Strona 8-26 FISCHER Typ FNH	 Strona 8-27 MAXXFAST HammerFast	 Strona 8-28 FISCHER Typ N-Z
 Strona 8-29 FISCHER Typ N-FZ	 Strona 8-30 FISCHER Typ N-D	 Strona 8-31 FISCHER Typ SXS	 Strona 8-32 MAXXFAST Kotwy do mocowania ram	 Strona 8-33 MAXXFAST Kotwy do mocowania ram nylon
 Strona 8-33 FISCHER Typ F-S	 Strona 8-34 FISCHER Typ F-M	 Strona 8-35 FISCHER Typ FUR-T	 Strona 8-36 FISCHER Typ FUR-SS	 Strona 8-37 FISCHER Typ SXR-T
 Strona 8-38 Śruby do mocowania ościeżnic okiennych	 Strona 8-39 FISCHER Nasadki	 Strona 8-40 FISCHER Typ JS	 Strona 8-41 FISCHER Typ S/J/S	 Strona 8-42 MAXXFAST Kołki rozporowe
 Strona 8-42 Kołki rozporowe	 Strona 8-43 Kołki rozporowe	 Strona 8-44 Kotwy rozporowe bez śruby stal nierdzewna	 Strona 8-44 Kołki rozporowe	 Strona 8-45 Kołki rozporowe
 Strona 8-46 FISCHER Typ M	 Strona 8-47 FISCHER Typ PA	 Strona 8-48 FISCHER Typ FSA-S	 Strona 8-49 RAWLNUT	 Strona 8-50 MAXXFAST Kotwy do wbijania

Kotwy, kołki, dyble⁸

 Strona 8-51 Kotwy rozporowe	 Strona 8-53 Narzędzie do osadzania	 Strona 8-54 Narzędzia instalacyjne SA	 Strona 8-54 FISCHER Typ FH Y	 Strona 8-55 Kotwy śrubowe WALLD OG
 Strona 8-56 Kotwy śrubowe WALLD OG	 Strona 8-57 Kotwy śrubowe TAPH	 Strona 8-58 Kotwy śrubowe TAPC	 Strona 8-59 Kotwy śrubowe BT	 Strona 8-60 Kotwy śrubowe A4 BT
 Strona 8-61 Wkręt kotwiący BT	 Strona 8-61 Kotwy śrubowe BT	 Strona 8-62 Kotwy śrubowe BT	 Strona 8-63 MAXXFAST ThruFast- ThruMaxx	 Strona 8-65 Kotwy EXA
 Strona 8-66 FISCHER Typ FBN	 Strona 8-68 SPIT Typ FIX 3	 Strona 8-69 MAXXFAST Kotwy wysokosprawne	 Strona 8-71 FISCHER Typ FAZ	 Strona 8-72 FISCHER Typ FH-B
 Strona 8-74 FISCHER Typ FH-S	 Strona 8-75 FISCHER Typ FZA	 Strona 8-76 FISCHER Narzędzia instalacyjne	 Strona 8-78 MAXXFAST Pręty	 Strona 8-79 FISCHER Typ RGM
 Strona 8-80 Pręty gwintowane	 Strona 8-80 SPIT Typ Maxima	 Strona 8-81 FISCHER Narzędzia instalacyjne	 Strona 8-82 Kapsuły	 Strona 8-83 Zaprawy chemiczne
 Strona 8-85 Narzędzia instalacyjne	 Strona 8-86 MAXXFAST Kotwienie	 Strona 8-87 FISCHER Kotwa tulejkowa	 Strona 8-88 FISCHER Typ RG MI	 Strona 8-89 DIN 529 A Śruba fundamentowa typ A
 Strona 8-90 DIN 529 E Śruba fundamentowa typ E	 Strona 8-90 Kotwy z hakiem 50 lub 100 mm	 Strona 8-93 Do szalowania	 Strona 8-93 Do szalowania	 Strona 8-95 VEMO Typ 1550
 Strona 8-95 VEMO Typ 1551	 Strona 8-96 VEMO Typ 1140	 Strona 8-96 VEMO Typ 1130	 Strona 8-97 VEMO Typ 995G	 Strona 8-98 VEMO Typ 1036
 Strona 8-99 VEMO Typ 2244				

MaxxFast - Nowy asortyment wysokiej jakości kotew

MaxxFast wprowadza pełny asortyment wysokiej jakości produktów to kotwienia. Asortyment ten obejmuje kołki nylonowe, kołki wbijane oraz kotwy. Te wysokiej jakości produkty spełnią Twoje potrzeby dla najbardziej wymagających zastosowań.

Kołki i kotwy

Nasze kołki nylonowe UniFast posiadają niewielki kołnierz zapobiegający przechodzeniu przez materiał. Kołek nylonowy MultiFast może być stosowany do niemal każdego materiału konstrukcyjnego. Kołek typu 4Fast o 4-stronnym rozpięciu umożliwia bardzo mocne zakotwienie. Kołek wbijany HammerFast jest bardzo łatwy w użyciu i jednocześnie skraca czas montażu.

- Kołek do płyt gipsowo-kartonowych
- Kotwa wkręcana z narzędziem montażowym
- Kołek rozporowy
- Kotwa do ram
- Tuleja kotwiąca z narzędziem montażowym

Śruby kotwiące

Kotwy ThruFast, ocynkowane i ze stali A2, są doskonałym rozwiązaniem dla ogólnych zamocowań. Certyfikowane kotwy ThruMaxx ETA7 odpowiadają wymaganiom Europejskiej Organizacji ds. Oceny Technicznej i wykonane są ze stali ocynkowanej oraz A4. Gwarantują one optymalną siłę i stabilność mocowania.

Również: ProMaxx ETA opcja 1. Te wysokiej jakości produkty spełniają oczekiwania przy najbardziej wymagających zastosowaniach.

- THRUMAXX ETA7 stal ocynkowana
- THRUMAXX ETA7 stal nierdzewna A4
- PROMAXX ETA1 stal ocynkowana
- THRUFAST stal ocynkowana
- THRUFAST stal nierdzewna A2



Kołki do ścian UniFast

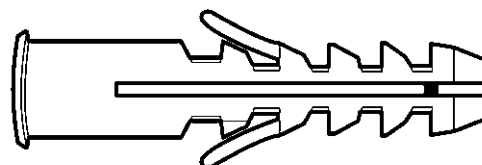
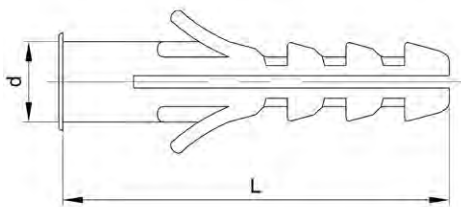

Informacje techniczne

d	5	6	7	8	10	12
Głębokość wiercenia (min.)	35	40	40	50	60	70
L	25	30	30	40	50	60
Wiertło \varnothing	5	6	7	8	10	12
Zastosowanie w połączeniu z:						
\varnothing wkrętów do płyty wiórowej	2.5-4	3.5-4	4-4.5	4.5-6	6-8	8-10
Siła wyciągająca dla wkrętów do drewna w kN						
Beton \geq C20/25	0.42	0.64	0.76	0.90	1.80	2.10
Cegła \geq Mz12	0.36	0.50	0.64	0.80	0.88	0.90

30500 MAXXFAST Kołki do ścian UniFast

MF40

Materiał Plastik Nylon (poliamid)
Kolor Szary

MAXXFAST
PROFESSIONAL HARDWARE



d	⊠	Kod artykułu	d	⊠	Kod artykułu	d	⊠	Kod artykułu
5MM	100	30500.050.001	7MM	100	30500.070.001	10MM	50	30500.100.001
6MM	100	30500.060.001	8MM	100	30500.080.001	12MM	25	30500.120.001

- Tylko pełne opakowania.

Kołki do ścian

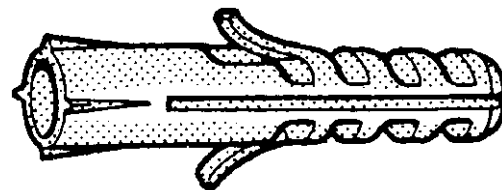
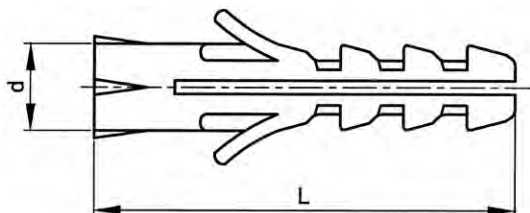

8

Informacje techniczne

d	4	5	6	7	8	10	12	14
Głębokość wiercenia (min.)	25	35	40	45	55	70	80	100
L	20	25	30	37	40	50	60	80
Wiertło \varnothing	4	5	6	7	8	10	12	14
Zastosowanie w połączeniu z:								
Drewnowkręty z łbem sześciokątnym \varnothing	2-3	3-4.5	4.5-5	4.5-5.5	5-6	6-8	8-10	10-12

Kolejność montażu

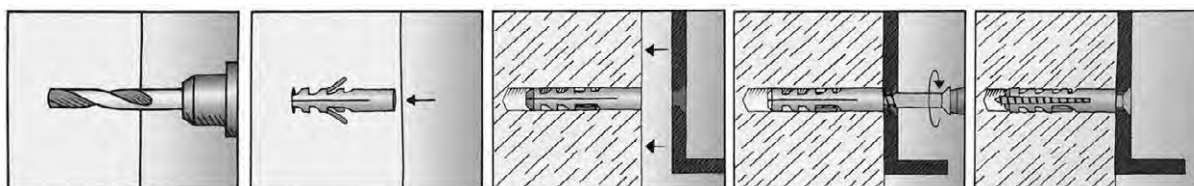

Grupy katalogowe

Materiał	Kolor	Kod	Strona
Plastik Nylon	Szary	63158	8-5

Grupy katalogowe

Material	Kolor	Kod	Strona
Plastik Nylon	Duże Opakowanie	Szary	63159

63158 Kołki do ścian N05A

Material Plastik Nylon (poliamid)
Kolor Szary

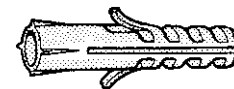

d	☒	Kod artykułu	d	☒	Kod artykułu	d	☒	Kod artykułu
4MM	200	63158.040.001	7MM	100	63158.070.001	12MM	25	63158.120.001
5MM	100	63158.050.001	8MM	100	63158.080.001	14MM	20	63158.140.001
6MM	100	63158.060.001	10MM	50	63158.100.001			

63159 Kołki do ścian N05A

Material Plastik Nylon (poliamid)
Kolor Szary



d	☒	Kod artykułu	d	☒	Kod artykułu	d	☒	Kod artykułu
5MM	1000	63159.050.001	8MM	250	63159.080.001	12MM	100	63159.120.001
6MM	500	63159.060.001	10MM	200	63159.100.001			



fischer

8

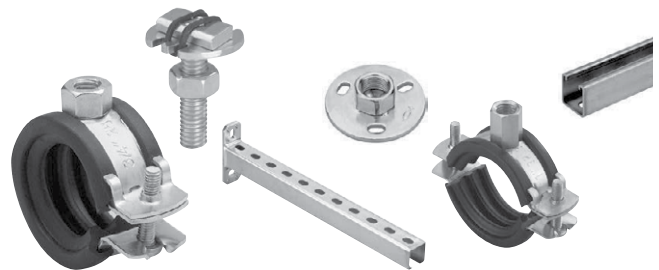

Kołki do ścian, typ S

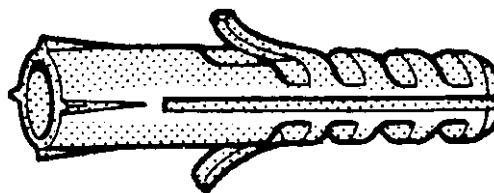
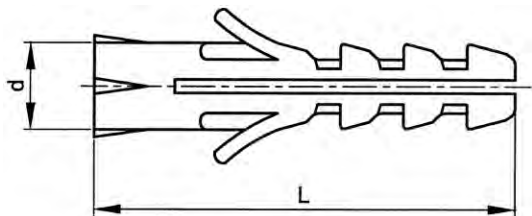

Informacje techniczne

Typ	S4	S5	S6	S7	S8	S10	S12	S14	S16	S20
d	4	5	6	7	8	10	12	14	16	20
Głębokość wiercenia (min.)	25	35	40	40	55	70	80	90	100	120
L	20	25	30	30	40	50	60	75	80	90
Wiertło \varnothing	4	5	6	7	8	10	12	14	16	20
Zastosowanie w połączeniu z:										
Wkręty do drewna i płyt wiórowych	2-3	3-4	4-5	4-5.5	4.5-6	6-8	8-10	10-12	12 -1/2"	16
Dopuszczalne obciążenie w kN										
Beton komórkowy \geq PB4. PP4 (G4)	-	-	0.05	-	0.07	0.16	0.28	0.40	-	-
Beton \geq C20/25	0.16	0.28	0.40	-	0.60	1.10	1.50	1.85	2.26	3.88
Cegła silikatowa \geq KS12	0.14	0.24	0.28	-	0.55	-	-	-	-	-
Cegła \geq Mz12	0.14	0.24	0.28	-	0.50	-	-	-	-	-

- Dopuszczalne obciążenie w kN przy największej możliwej średnicy wkręta (wartości wytluszczone) i prawidłowym zamontowaniu kołka do ścian w powierzchni wspierającej.
- Dopuszczalne obciążenie zawiera współczynnik bezpieczeństwa 7.

Kolejność montażu

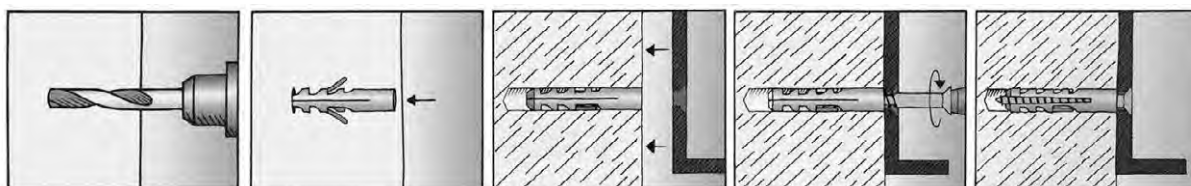

Grupy katalogowe

Materiał	Kolor	Kod	Strona
Plastik Nylon	Szary	63100	8-7
Plastik Nylon	Szary	63110	8-7

63100 FISCHER Kołki do ścian, typ S

N01A

Materiał Plastik Nylon (poliamid)
Kolor Szary

fischer innovative solutions

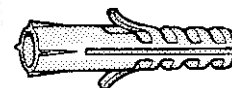

Typ	☒	Kod artykułu	Typ	☒	Kod artykułu	Typ	☒	Kod artykułu
S 4	200	63100.040.001	S 8	100	63100.080.001	S 14	20	63100.140.001
S 5	100	63100.050.001	S 10	50	63100.100.001	S 16	10	63100.160.001
S 6	100	63100.060.001	S 12	25	63100.120.001	S 20	5	63100.200.001
S 7	100	63100.070.001						

63110 FISCHER Kołki do ścian, typ S

N01A

Materiał Plastik Nylon (poliamid)
Kolor Szary

fischer innovative solutions

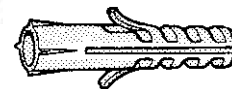

Typ	☒	Kod artykułu	Typ	☒	Kod artykułu	Typ	☒	Kod artykułu
S 5	1000	63110.050.001	S 6	500	63110.060.001	S 8	250	63110.080.001

Zestawy kołków do ścian w kasetach



Kolejność montażu

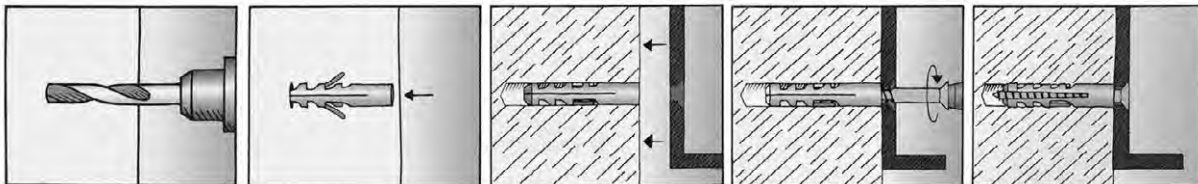

63150 FISCHER Kołki do ścian, sortowane typ S

N03B



Typ

Kaseta S-5/6/8



Kod artykułu

1 [63150.568.001](#)

- Zapakowane w czerwonej plastikowej kasetę z przejrzystym okienkiem.
- Zawartość:
- 100 nylonowych kołków do ścian typ S 5
- 100 nylonowych kołków do ścian typ S 6
- 100 nylonowych kołków do ścian typ S 8



Kołki do ścian, typ MS

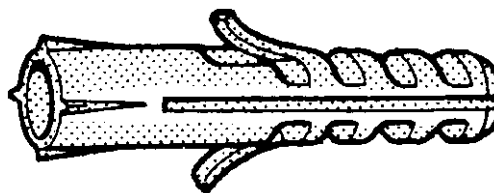
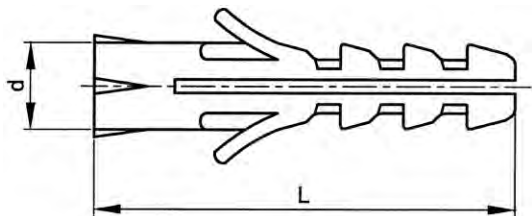

Informacje techniczne

Typ	M6-S	M8-S	M10-S	M12-S
d	8	10	14	16
Głębokość wiercenia (min.)	55	70	90	100
L	40	50	70	80
Wiertło ϕ	8	10	14	16
Dopuszczalne obciążenie w kN				
Beton \geq C20/25	0.30	0.54	0.66	1.06
Cegła Mz12	0.24	0.33	0.46	0.79
Cegła silikatowa \geq KS12	0.24	0.33	0.43	0.71

- Kołek do ścian typ MS nadaje się do stosowania z elementami złącznymi z gwintem metrycznym.
- Dopuszczalne obciążenie zawiera współczynnik bezpieczeństwa 7.

Kolejność montażu

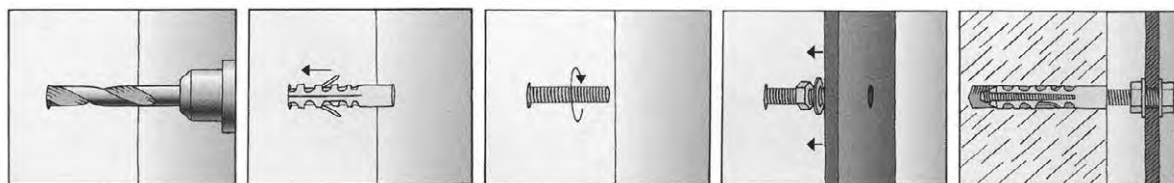

63160 FISCHER Kołki do ścian, typ MS

N03B

Gwint: Metryczny
 Materiał: Plastik Nylon (poliamid)
 Kolor: Beż

fischer
 innovative solutions

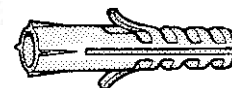

Typ	☒	Kod artykułu	Typ	☒	Kod artykułu	Typ	☒	Kod artykułu
M6 S	100	63160.060.001	M10 S	20	63160.100.001	M12 S	10	63160.120.001
M8 S	50	63160.080.001						

Kołki do ścian MultiFast

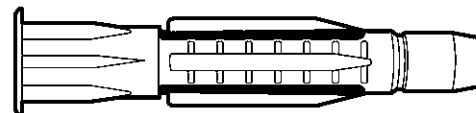
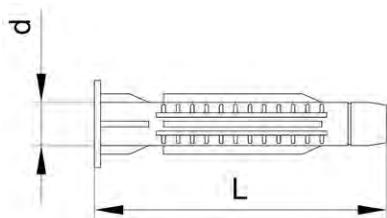

Informacje techniczne

d	6	8	10
Głębokość wiercenia (min.)	45	60	70
L	35	50	60
Wiertło \varnothing	6	8	10
Zastosowanie w połączeniu z:			
\varnothing wkrętów do płyty wiórowej	4	4.5	5
Siła wyciągająca dla wkrętów do drewna w kN			
Beton \geq C20/25	0.65	0.80	0.95
Cegła \geq Mz12	0.20	0.32	0.38

30502 MAXXFAST Kołki do ścian MultiFast

MF50

Materiał: Plastik Nylon (poliamid)
Kolor: Szary

MAXXFAST
PROFESSIONAL HARDWARE



d	☒	Kod artykułu	d	☒	Kod artykułu	d	☒	Kod artykułu
6MM	100	30502.060.001	8MM	100	30502.080.001	10MM	50	30502.100.001

- Tylko pełne opakowania.

Kołki do ścian, typ SX/SX-L

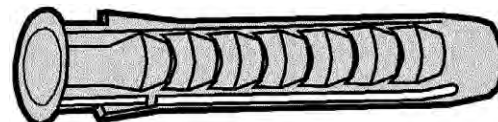
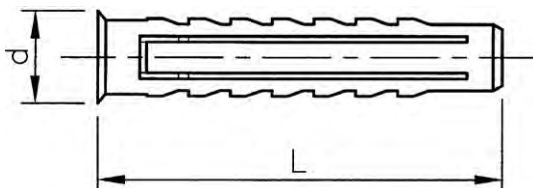

8

Informacje techniczne

Typ	SX 4	SX 5	SX 6	SX 6-L	SX 8	SX 8-L	SX 10	SX 12	SX 14	SX 16
d	4	5	6	6	8	8	10	12	14	16
Głębokość wiercenia (min.)	25	35	40	60	50	75	70	80	90	100
L	20	25	30	50	40	65	50	60	70	80
Wiertło \varnothing	4	5	6	6	8	8	10	12	14	16
Zastosowanie w połączeniu z:										
\varnothing wkrętów do płyty wiórowej	2-3	3-4	4-5	4-5	4.5-6	4.5-6	6-8	8-10	10-12	12-1/2"
Dopuszczalne obciążenie w kN										
Beton komórkowy \geq G2	-	0.03	0.03	0.03	0.04	0.04	0.09	0.14	0.31	0.31
Beton komórkowy \geq G4	-	0.09	0.09	0.09	0.14	0.14	0.29	0.44	0.49	0.49
Beton \geq C20/25	-	0.29	0.7	0.7	0.71	0.71	1.21	1.71	2.01	2.01
Cegła silikatowa \geq KS12	-	0.29	0.5	0.5	0.6	0.6	1.21	1.71	2.01	2.01
Cegła \geq Mz12	-	0.23	0.31	0.31	0.59	0.59	0.64	0.71	0.8	0.8
Pusta cegła silikatowa KSL12	-	0.17	0.3	0.3	0.33	0.33	0.29	0.35	0.31	0.31
Wentylacja kamienna \geq Hlz12. $\rho \geq 1.0 \text{ kg/dm}^3$	-	0.07	0.07	0.07	0.17	0.17	0.17	0.26	0.44	0.44

- Dopuszczalne obciążenie w kN przy największej możliwej średnicy wkrętu, (wartości wytluszczone) i prawidłowym zamontowaniu kołka do ścian w powierzchni wspierającej.
- Zaleca się wzięcie współczynnika bezpieczeństwa ≥ 5 . Przy stosowaniu wkrętów do płyty wiórowej, wartości te należy zmniejszyć o 30%.
- Z uwagi na możliwe różnice w jakości złącza, wartości te stosują się tylko do operacji montowania w cegle.

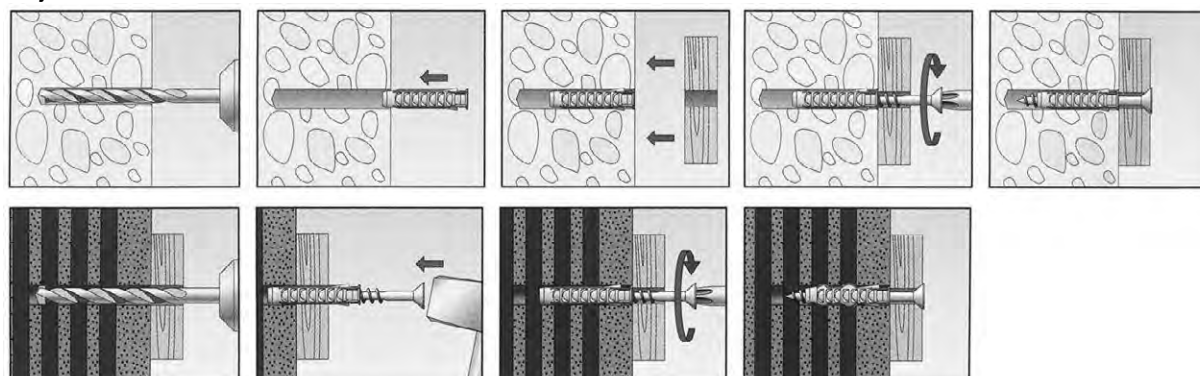
Kolejność montażu

Grupy katalogowe

Material		Kolor	Kod	Strona
Plastik Nylon	SX	Szary	63120	8-11
Plastik Nylon	SX-L	Szary	63121	8-11

63120 FISCHER Kołki do ścian, typ SX
N01A

Material Plastik Nylon (poliamid)
Kolor Szary

fischer innovative solutions



Typ	☒	Kod artykułu	Typ	☒	Kod artykułu	Typ	☒	Kod artykułu
SX4	200	63120.040.001	SX8	100	63120.080.001	SX14	20	63120.140.001
SX5	100	63120.050.001	SX10	50	63120.100.001	SX16	10	63120.160.001
SX6	100	63120.060.001	SX12	25	63120.120.001			

63121 FISCHER Kołki do ścian, typ SX-L
N01A

Material Plastik Nylon (poliamid)
Kolor Szary

fischer innovative solutions



Typ	☒	Kod artykułu	Typ	☒	Kod artykułu
SXL6	100	63121.060.002	SXL8	50	63121.080.002

Kołki do ścian 4Fast

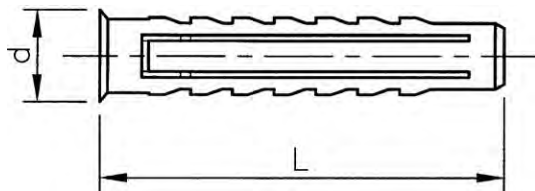

Informacje techniczne

d	5	6	8	10	12
Głębokość wiercenia (min.)	30	50	50	60	70
L	25	30	40	50	60
Wiertło \varnothing	5	6	8	10	12
Zastosowanie w połączeniu z:					
\varnothing wkrętów do płyty wiórowej	4	4.5	5	6	10
Siła wyciągająca dla wkrętów do drewna w kN					
Beton \geq C20/25	0.80	1.10	1.20	1.86	2.60
Cegła \geq Mz12	0.46	0.90	1.00	1.10	1.20

30505 MAXXFAST Kołki do ścian 4Fast

MF40

Materiał Plastik Nylon (poliamid)
Kolor Szary

MAXXFAST
PROFESSIONAL HARDWARE

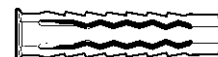

d	☒	Kod artykułu	d	☒	Kod artykułu	d	☒	Kod artykułu
5MM	100	30505.050.001	8MM	100	30505.080.001	12MM	25	30505.120.001
6MM	100	30505.060.001	10MM	50	30505.100.001			

- Tylko pełne opakowania.

Kołki uniwersalne, typ UX/UX-R

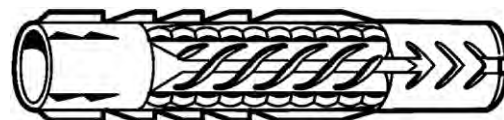
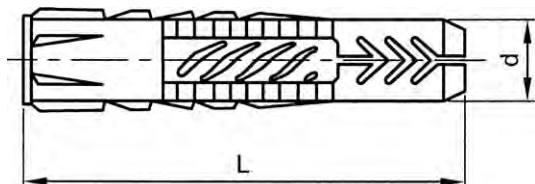

8

Informacje techniczne

Typ	UX (R) 6	UX (R) 8	UX (R) 10	UX 12	UX 14
Grubość materiału (min.)	9.5	9.5	12.5	-	-
Głębokość wiercenia (min.)	45	60	75	85	95
L	35	50	60	70	75
Wiertło \varnothing	6	8	10	12	14
Zastosowanie w połączeniu z:					
Wkręty do drewna i płyt wiórowych	4-5	4.5-6	6-8	8-10	10-12
Dopuszczalne obciążenie w kN					
Beton komórkowy \geq PB4. PP4 (G4)	0.2	0.3	0.4	0.6	0.7
Cegła \geq Mz12	0.2	0.3	0.5	0.7	0.8
Okladzina tynkowa 12.5mm	0.1	0.1	0.1	-	-
Okladzina tynkowa \geq 2x12.5mm	0.15	0.15	0.15	-	-
Pusta cegła silikatowa KSL12	0.4	0.5	0.6	0.8	0.8
Wentylacja kamienna Hlz12	0.2	0.2	0.2	0.3	4

- Dopuszczalne obciążenie w kN przy największej możliwej średnicy wkręta (wartości wytłuszczone) i prawidłowym zamontowaniu kołka do ścian w powierzchni wspierającej.
- Dopuszczalne obciążenie zawiera współczynnik bezpieczeństwa 7.

Grupy katalogowe

Materiał		Kod	Strona
Plastik	UX	63276	8-13
Plastik	UX-R	63277	8-13

63276 FISCHER Kołki uniwersalne, typ UX				N03A				
Material		Plastik						
Typ	☒	Kod artykułu	Typ	☒	Kod artykułu	Typ	☒	Kod artykułu
UX 6	100	63276.060.001	UX 10	50	63276.100.001	UX 14	20	63276.140.001
UX 8	100	63276.080.001	UX 12	25	63276.120.001			

63277 FISCHER Kołki uniwersalne, typ UX-R				N03A				
Material		Plastik						
Typ	☒	Kod artykułu	Typ	☒	Kod artykułu	Typ	☒	Kod artykułu
6 UX-R	100	63277.060.001	8 UX-R	100	63277.080.001	10 UX-R	50	63277.100.001

Kołki do ścian, uniwersalne, typ FU

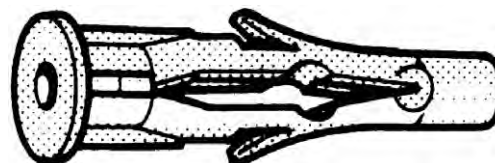
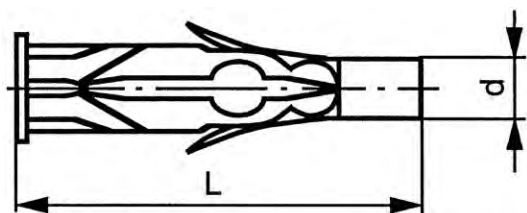

Informacje techniczne

Typ	FU 6x35	FU 6x45	FU 8x50	FU 10x60
d	6	6	8	10
Grubość materiału (min.)	6	6	6	6
Głębokość wiercenia (min.)	45	55	60	70
L	35	45	50	60
Wiertło \varnothing	6	6	8	10
Zastosowanie w połączeniu z:				
Wkręty do drewna i płyt wiórowych	3-3.5	3-3.5	4-4.5	5-6
Siła wyciągająca dla wkrętów do drewna/				
Beton komórkowy PB2. PP2 (G2)	0.03	0.03	0.09	0.13
Beton komórkowy PB4. PP4 (G4)	0.13	0.13	0.22	0.27
Cegła Mz12	0.26	0.26	0.50	0.78
Cegła silikatowa KS12	0.25	0.25	0.50	0.78
Okładzina tynkowa 10mm	-/0.4	-/0.4	-/0.45	-/0.45
Pusta cegła silikatowa KSL6	-	-	-	-
Płyta wiórowa 10mm	-	-	-	-
Siła wyciągająca z betonu C20/25	0.28	0.28	0.57	0.86
Wentylacja kamienna Hlz12	-	-	-	-
Żwir pumekowy V2	0.10	0.10	0.21	0.22

- Dopuszczalne obciążenie w kN przy największej możliwej średnicy wkręta (wartości wytłuszczone) i prawidłowym zamontowaniu kołka do ścian w powierzchni wspierającej.
- Dopuszczalne obciążenie zawiera współczynnik bezpieczeństwa 7.

Kolejność montażu

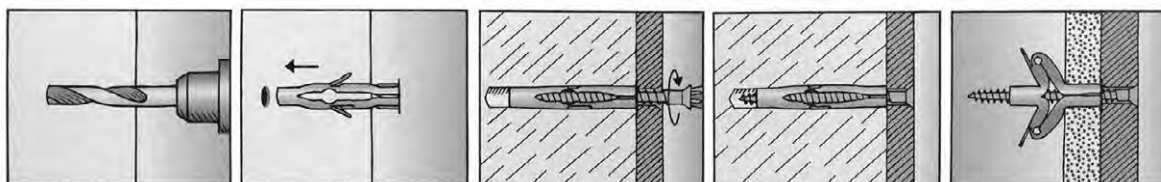

63270	FISCHER Kołki do ścian, uniwersalne, typ FU	N03A
Materiał	Plastik Nylon (poliamid)	
Kolor	Szary	

Typ	☒	Kod artykułu	Typ	☒	Kod artykułu	Typ	☒	Kod artykułu
FU 6X35	50	63270.060.035	FU 8X50	50	63270.080.050	FU 10X60	25	63270.100.060
FU 6X45	50	63270.060.045						

Mocowania wężkowe MAXXFAST

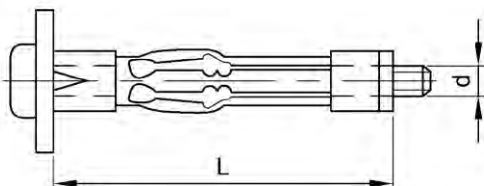

Informacje techniczne

d x L	Długość śruby	Grubość armatury	Głębokość wgłębienia (min.)	Siła wyciągająca w N	Wiertło ø
M4x21	28	1-4	26	-	8
M4x34	41	3-9	39	-	8
M4x40	47	8-15	46	300	8
M4x47	54	16-21	53	300	8
M4x60	67	32-38	66	500	8
M5x37	43.5	5-13	46	250	10
M5x53	60	5-16	59	500	10
M5x66	74	16-32	72	900	10
M5x81	89	32-45	89	900	10
M6x37	45	5-13	46	200	12
M6x53	60	5-16	59	300	12
M6x66	74	16-32	72	800	12
M6x81	88	32-45	89	800	12

- Siła wyciągająca dla maksymalnej grubości płyty.

30537	MAXXFAST H-Fast mocowania wężkowe Pozidriv	MF4A
Gwint	Metryczny	
Materiał	Stal	
Obróbka powierzchni	Ocynkowane	

d x L	☒	Kod artykułu	d x L	☒	Kod artykułu	d x L	☒	Kod artykułu
M4X21	50	30537.040.021	M5X37	50	30537.050.037	M6X37	50	30537.060.037
M4X34	50	30537.040.032	M5X53	50	30537.050.052	M6X53	50	30537.060.052
M4X40	50	30537.040.038	M5X66	50	30537.050.065	M6X66	50	30537.060.065
M4X47	50	30537.040.046	M5X81	50	30537.050.080	M6X81	50	30537.060.080
M4X60	50	30537.040.059						

Mocowania wężkowe, typ HM/HM-S

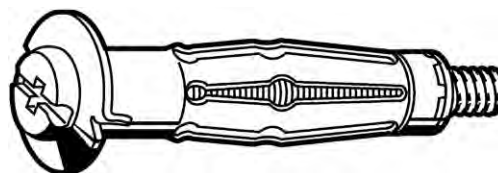
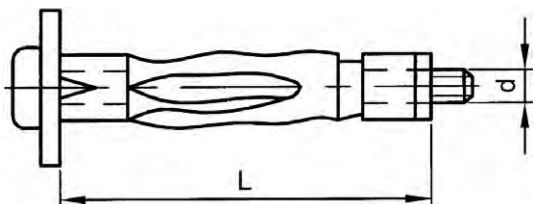

Informacje techniczne

Typ	d	Grubość części strukturalnej (maks.)	Grubość materiału (maks.)	Głębokość wiercenia (min.)	L	Rozmiar śruby	Wiertło ø
HM 4x32	M4	-	3-13	42	32	M4	8
HM 4x32 S	M4	15-25	3-13	40	32	M4X40	8
HM 4x45 S	M4	12-21	16-23	55	45	M4x52	8
HM 4x46 S	M4	23	5-18	56	46	M4x52	8
HM 4x60 S	M4	12-21	31-40	60	60	M4X65	8
HM 5x37 S	M5	8-17	6-15	45	37	M5X45	10
HM 5x52 S	M5	10-24	7-21	58	52	M5X58	10
HM 5x65 S	M5	12-26	20-34	71	65	M5X71	10
HM 6x37	M6	-	6-15	47	37	M6	12
HM 6x37 S	M6	12-21	6-15	45	37	M6X45	12
HM 6x52 S	M6	14-28	7-21	58	52	M6X58	12
HM 6x65 S	M6	≤ 24	20-34	70	65	M6X70	12
HM 6x80	M6	-	38-50	90	80	M6	12
HM 6x80 S	M6	16-34	32-50	88	80	M6X88	12
HM 8x55 SS	M8	≤ 24	10-21	60	55	M8X60	12

- HM4x32/ HM5x37/ HM6x37/ HM6x80 dostarczane bez śruby.
- HM8x55SS ze śrubą z łbem sześciokątnym. Montaż tylko przy pomocy profesjonalnych szczypiec HM Z 1.

Kolejność montażu

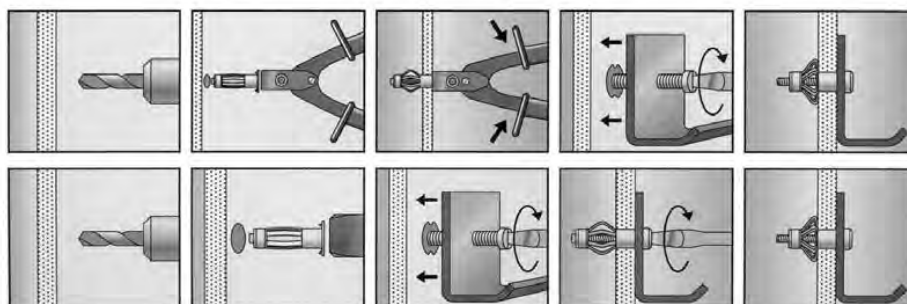

8

63240 FISCHER Mocowania wężkowe, typ HM/HM-S

N03A

Gwint Metryczny
Materiał Stal
Obróbka powierzchni O cynkowane

fischer innovative solutions

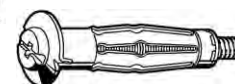

Typ	☒	Kod artykułu	Typ	☒	Kod artykułu	Typ	☒	Kod artykułu
HM4X32S	50	63240.040.132	HM5X37S	50	63240.050.137	HM6X52S	50	63240.060.152
HM4X45S	50	63240.040.145	HM5X52S	50	63240.050.152	HM6X65S	50	63240.060.165
HM4X54S	50	63240.040.154	HM5X65S	50	63240.050.165	HM6X80S	50	63240.060.180
HM4X60S	50	63240.040.160	HM6X37S	50	63240.060.137	HM8X55S	50	63240.080.155

Narzędzia instalacyjne do mocowań wnąkowych

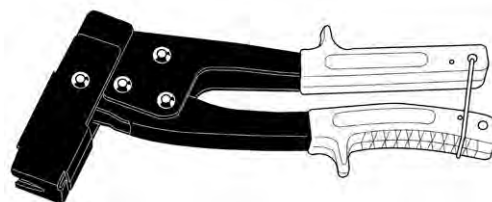

Grupy katalogowe

Kod	Strona
30539	8-16
63248	8-16

30539 MAXXFAST Narzędzia instalacyjne MFNA

MAXXFAST
PROFESSIONAL HARDWARE



Typ	Kod artykułu
HA-FAST	1 30539.000.005

63248 FISCHER Narzędzia instalacyjne N03A

fischer
innovative solutions



Typ	Kod artykułu	
HMZ 2	1 63248.000.100	<ul style="list-style-type: none"> Szczypce dla majsterkowiczów Odpowiednie do instalacji mocowań wnąkowych FISCHER
HMZ 1	1 63248.000.105	<ul style="list-style-type: none"> Szczypce profesjonalne Odpowiednie do instalacji mocowań wnąkowych FISCHER



Kołki do płyt kartonowo-gipsowych

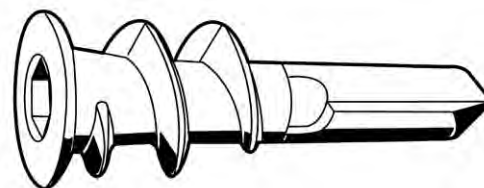
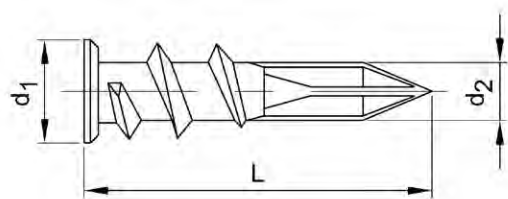

Informacje techniczne

d ₁ x L	d ₂	Grubość materiału	Głębokość wgniecenia (min.)	Nr wgniecenia krzyżowego	Rozmiar śruby
15x33	6	9-16	30	2	4.5x35
13x29	6	9-16	25	2	4.2x30
13x37	6	9-16	25	2	4.2x50

Grupy katalogowe

Gniazdo	Materiał	Obróbka powierzchni	Kod	Strona
Phillips	Plastik Nylon		30530	8-17
Phillips	Stal	Ocynk.	30531	8-17
Phillips	Zamac 3		30532	8-17

30530 MAXXFAST Kołki do płyt kartonowo-gipsowych

MF4A

Materiał Plastik Nylon (poliamid)

MAXXFAST
PROFESSIONAL HARDWARE

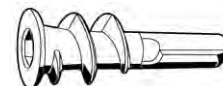

d₁ x L **Kod artykułu**
15X33MM 50 [30530.120.001](#)

30531 MAXXFAST Kołki do płyt kartonowo-gipsowych

MF4A

Materiał Stal
Obróbka powierzchni Ocynkowane

MAXXFAST
PROFESSIONAL HARDWARE

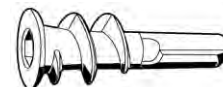

d₁ x L **Kod artykułu**
13X29MM 50 [30531.015.029](#)

30532 MAXXFAST Kołki do płyt kartonowo-gipsowych

MF4A

Materiał Zamac 3

MAXXFAST
PROFESSIONAL HARDWARE

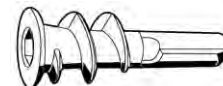

d₁ x L **Kod artykułu**
13X37MM 50 [30532.060.037](#)

Kotwy samowierzące do płyt kartonowo-gipsowych

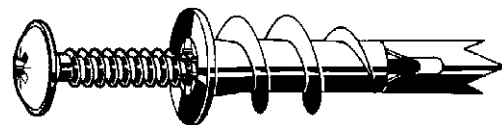
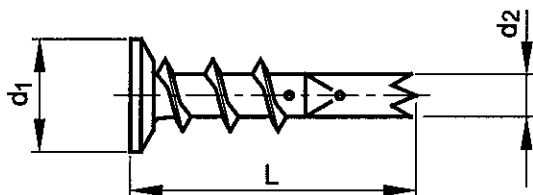

Informacje techniczne

Typ	TP 12	TP 12-PLUS	TF 27
Wytrzymałość na ścinanie min. w kN	0.18	0.28	0.18
d ₁	14	16	14
d ₂	8	15.5	8
Grubość materiału (min.)	10	10-13	10
L	31	39	31
Nr Pozidriv (Z)	2	2	2
Rozmiar śruby	4.5x35	4.5x45	4.5x50
Zakres	0-12	0-12	12-27

Kolejność montażu

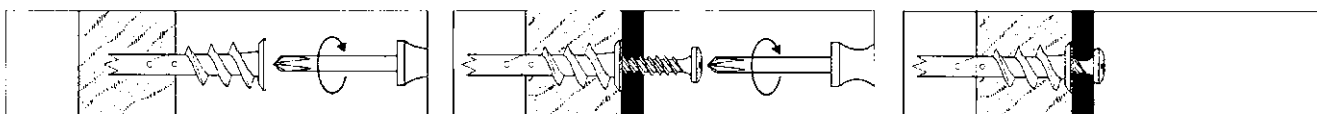

Grupy katalogowe

Materiał	Obróbka powierzchni	Kod	Strona
Zamac 3	Ocynk.	70880	8-18
Zamac 3	Ocynk. PLUS	70882	8-18

70880 DRIVA Kotwy samowierzące do płyt kartonowo-gipsowych

N05A

Materiał Zamac 3
Obróbka powierzchni Ocynkowane



Typ	Kod artykułu	Typ	Kod artykułu
TP 12	100 70880.120.001	TF 27	100 70880.270.001

- DRIVA kotwy samowierzące są wykonane ze stopu cynku Zamac 3, typ TP 12, z cynkowanymi wkrętami do tylnych paneli i typ TF 27 z cynkowanymi śrubami z łbem stożkowym.
- Podane wartości nadają się, odpowiednio, do płyty kartonowo-gipsowej 10 mm, płyty kartonowo-gipsowej 13 mm i betonu komórkowego (6 mm nawiercony wstępnie).
- Dopuszczalne obciążenie (Nrec/Vrec) obejmuje współczynnik bezpieczeństwa 5 przy obciążeniu ostatecznym.

70882 DRIVA Kotwy samowierzące do płyt kartonowo-gipsowych

N05A

Materiał Zamac 3
Obróbka powierzchni Ocynkowane



Typ	Kod artykułu
TP 12-PLUS	100 70882.120.001

- DRIVA PLUS kotwy samowierzące są wykonane ze stopu cynku Zamac 3. Dostarczane z wkrętami cynkowanymi opracowanymi specjalnie do kotew samowierzących DRIVA PLUS.
- Dopuszczalne obciążenie (Nrec/Vrec) obejmuje współczynnik bezpieczeństwa 5 przy obciążeniu ostatecznym

Mocowania do płyt kartonowo-gipsowych, typ GK/GKS

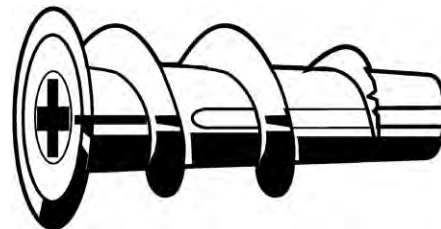

Informacje techniczne

Typ	GK	GKS
Głębokość wgłębienia (min.)	25	25
L	22	22
Zakres uchwytu	-	13
Ø Śruby	4-5	4.5x35
Dopuszczalne obciążenie w kN		
Okładzina tynkowa 9.5mm	0.07	0.07
Okładzina tynkowa 12.5mm	0.08	0.08
Okładzina tynkowa ≥ 2x12.5mm	0.11	0.11

- GKS dostarczane z narzędziem instalacyjnym i śrubami do płyt kartonowo-gipsowych.
- GK Min. długość śruby = długość zatyczki 22 mm + grubość elementu budowlanego.
- Dopuszczalne obciążenie w kN dotyczy kołków o określonej średnicy.

Kolejność montażu

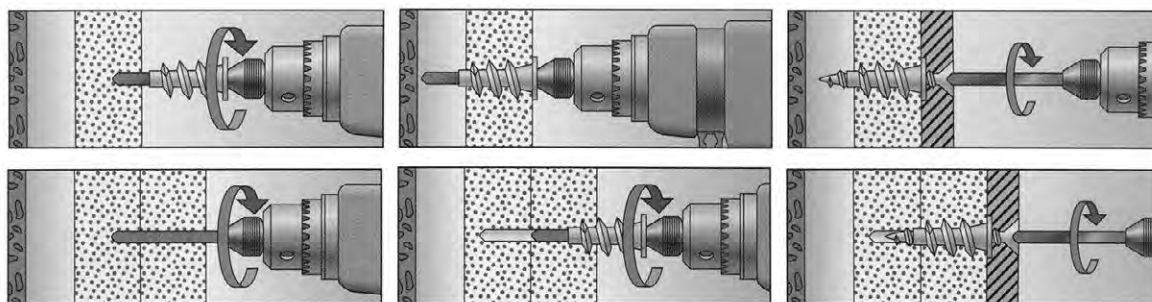

63261 FISCHER Mocowania do płyt kartonowo-gipsowych, typ GK/GKS

N03A

Materiał Plastik Nylon (poliamid)
Kolor Szary

fischer
innovative solutions

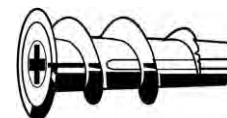

Typ	☒	Kod artykułu	Typ	☒	Kod artykułu
GK 4,0X35	100	63261.040.035	GKS 4,5X35	50	63261.045.035

Kotwy do gazobetonu GB

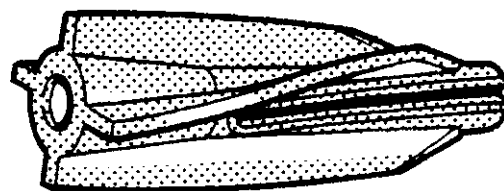
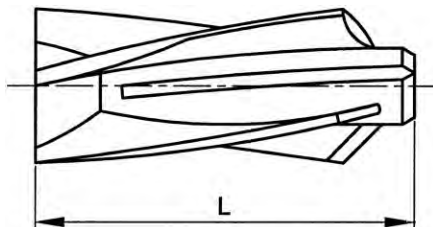

Informacje techniczne

Typ	GB8	GB10	GB14
Głębokość wiercenia (min.)	60	65	90
L	50	55	75
Wiertło \varnothing	8	10	14
Zastosowanie w połączeniu z:			
\varnothing Śruby	5	7	10
Dopuszczalne obciążenie w kN			
Beton komórkowy \geq P3.3 (GB3.3)	0.3	0.5	0.8
Beton komórkowy \geq P4.4 (GB4.4)	0.4	0.6	0.9
Beton komórkowy \geq PB2. PP2 (G2)	0.20	0.25	0.40
Beton komórkowy \geq PB3.3 (GB3.3)*	0.3	0.5	0.3
Beton komórkowy \geq PB4. PP4 (G4)	0.4	0.6	0.9

- Dopuszczalne obciążenia odnoszą się do wkrętów bezpiecznych Fischer.
 - Do prac projektowych należy rozważyć całość konstrukcji.
- *Strefa naprężeń stropów z betonu komórkowego i paneli sufitowych zgodnie z DIN4223.

Kolejność montażu

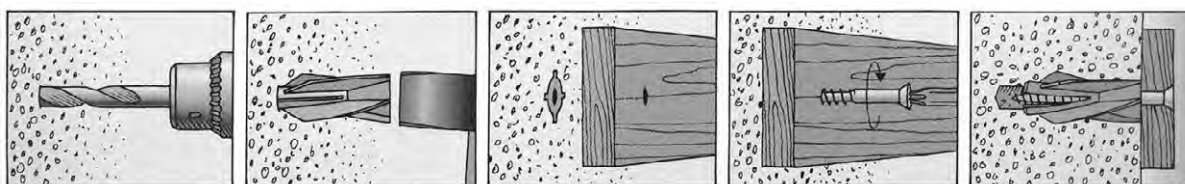

63300 FISCHER Kotwy blokujące skręt, typ GB

N03B

Materiał Plastik Nylon (poliamid)
Kolor Szary

fischer
innovative solutions



Typ	☒	Kod artykułu	Typ	☒	Kod artykułu	Typ	☒	Kod artykułu
GB 8	25	63300.080.001	GB 10	20	63300.100.001	GB 14	10	63300.140.001

Turbo kołek do gazobetonu FTP

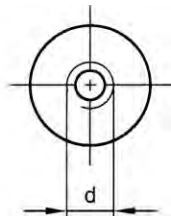
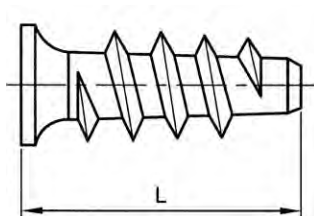

Informacje techniczne

Typ	M6	M8	M10
Głębokość wierzonego otworu do najgłębszego punktu	60	70	80
Głębokość wkręcania (maks.)	20	25	30
L	50	60	70
Wiertło \varnothing	8 - (10)	10 - (12)	12 - (14)
Zastosowanie w połączeniu z:			
\varnothing Śruby	M6	M8	M10
Dopuszczalne obciążenie w kN			
Beton komórkowy PB2. PP2 ($\geq 2.5 \text{ N/mm}_2$)	0.30	0.45	0.60
Beton komórkowy PB4. PP4 ($\geq 5.0 \text{ N/mm}_2$)	0.50	0.65	0.70
Beton komórkowy PB6. PP6 ($\geq 7.5 \text{ N/mm}_2$)	0.7	0.8	0.9
Płyta gipsowo-kartonowa	-	0.45	0.65

- Dopuszczalne obciążenia tylko dla wkrętów o wyspecyfikowanych średnicach.
- Współczynnik bezpieczeństwa 5.
- Średnica wiertła dla gazobetonu klasy $\geq 5,0 \text{ N/mm}^2$.

63309 FISCHER Turbo kołek do gazobetonu FTP		N03A
Materiał	Stal	

Typ	☒	Kod artykułu	Typ	☒	Kod artykułu	Typ	☒	Kod artykułu
M6	25	63309.060.001	M8	25	63309.080.001	M10	25	63309.100.001

- Narzędzia. Patrz: kolejne strony.

Turbo kołek do gazobetonu FTP

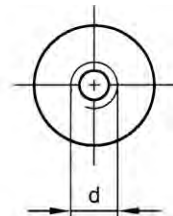
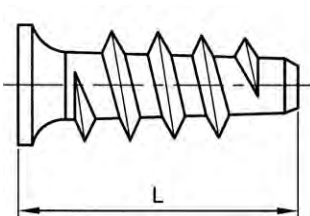

Informacje techniczne

Typ	K4	K6	K8	K10
Głębokość wierconego otworu do najgłębszego punktu	60	60	70	80
Głębokość wkręcania (maks.)	35	40	45	50
L	50	50	60	70
Wiertło \varnothing	8 - (10)	8 - (10)	10 - (12)	12 - (14)
Wkręty do drewna \varnothing	4-4.5	5-6	7-8	9-10
Zastosowanie w połączeniu z:				
\varnothing Śruby	M4	M5-6	M8	M8-10
Dopuszczalne obciążenie w kN				
Beton komórkowy PB2. PP2 ($\geq 2.5 \text{ N/mm}_2$)	0.15	0.20	0.30	0.40
Beton komórkowy PB4. PP4 ($\geq 5.0 \text{ N/mm}_2$)	0.25	0.30	0.40	0.50
Płyta gipsowo-kartonowa	-	-	0.29	0.54

- Dopuszczalne obciążenia tylko dla wkrętów o wyspecyfikowanych średnicach.
- Współczynnik bezpieczeństwa 5.
- Średnica wiertła dla gazobetonu klasy $\geq 5,0 \text{ N/mm}^2$.

63310 FISCHER Turbo kołek do gazobetonu FTP		N03A
Materiał	Plastik	

Typ	☒	Kod artykułu	Typ	☒	Kod artykułu	Typ	☒	Kod artykułu
K4	25	63310.040.001	K8	25	63310.080.001	K10	10	63310.100.001
K6	25	63310.060.001						

- Narzędzia. Patrz: kolejne strony.

Narzędzie instalacyjne turbo kotew FTP



Grupy katalogowe

Material	Kod	Strona
St	63312	8-23
Plastik	63313	8-23

63312 FISCHER Narzędzia instalacyjne turbo kotew FTP ze stali N03A

Material Stal

fischer 
innovative solutions



Typ	✉	Kod artykułu	Typ	✉	Kod artykułu	Typ	✉	Kod artykułu
EM6	1	63312.060.001	EM8	1	63312.080.001	EM10	1	63312.100.001

63313 FISCHER Narzędzia instalacyjne turbo kotew FTP z plastiku N03A

Material Plastik

fischer 
innovative solutions



Typ	✉	Kod artykułu	Typ	✉	Kod artykułu	Typ	✉	Kod artykułu
EK4/6	1	63313.040.001	EK8	1	63313.080.001	EK10	1	63313.100.001

Kołki uchylnie

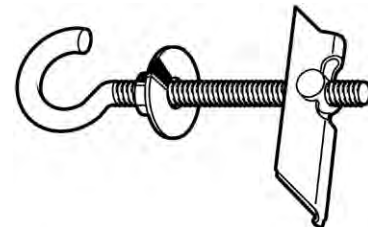

Informacje techniczne

Typ	Do śruby	Grubość materiału (min.)	Głębokość wgłębienia (min.)	L	N _{rec}	Wiertło ø
K 54	4MM	65	58	125	-	10
KD 3	M3X90	65	27	95	0.45	12
KD 4	M4X100	69	34	105	0.90	14
KD 5	M5X100	63	70	100	2.20	16
KD 6	M6X100	63	70	100	2.80	16
KD 8	M8X100	55	75	100	4.30	20
KDH 3	M3X80	51	27	105	0.07	12
KDH 4	M4X80	35	34	95	0.13	14
KDH 5	M5X90	60	70	130	0.30	16
KDH 8	M8X100	55	75	130	1.40	20

- N_{rec} = Zalecane obciążenie w kN.
- Współczynnik bezpieczeństwa.
- Patrz katalog FISCHER.

63260 FISCHER Kołki uchylnie, typ K

N03B

Obróbka powierzchni O cynkowane

fischer
innovative solutions

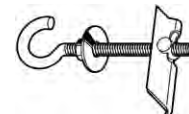

Typ	☒	Kod artykułu
K-54	25	63260.000.054
KD-3	50	63260.001.003
KD-4	25	63260.001.004
KD-5	25	63260.001.005
KD-6	25	63260.001.006
KD-8	20	63260.001.008
KDH-3	25	63260.002.003

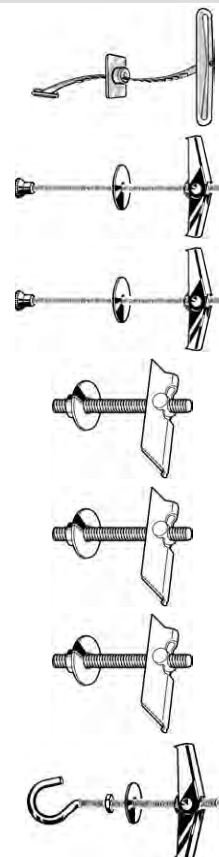

63260 FISCHER Kołki uchylnie, typ K ←

Typ	☒	Kod artykułu
KDH-4	25	63260.002.004
KDH-5	20	63260.002.005
KDH-8	20	63260.002.008

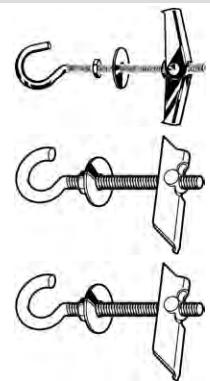

- KD & KDH= Stal.
- K= Plastikowe.

Kotwy do wbijania, typ SDA



Informacje techniczne

Typ	SDA 6
d ₁	5.8
d ₂	15
Głębokość wiercenia (min.)	40
k	2.5
L	35
Wiertło ø	6
Zakres uchwytu (maks.)	4.5
Dopuszczalne obciążenie w kN	
Beton ≥ C20/25	0.5

- Obciążenia są ważne w strefie nacisku.

Kolejność montażu

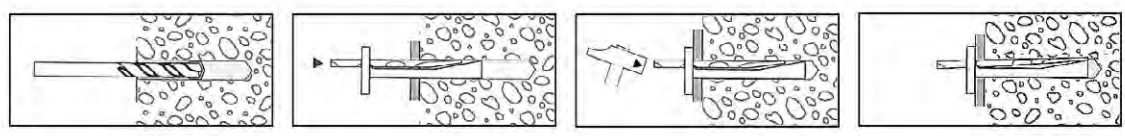

70665 SPIT Kotwy do wbijania, typ SDA P03A

Materiał Stal
Obróbka powierzchni Ocynkowane, po żółtej pasywacji

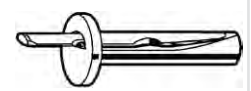

Typ	☒	Kod artykułu
SDA 6	100	70665.060.001

Tulejki do gwoździ, typ FNH

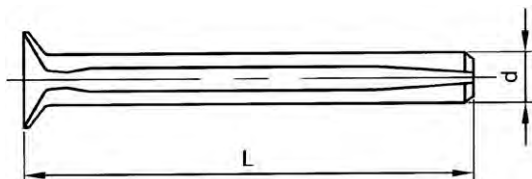

Informacje techniczne

Typ	FNH 5/50	FNH 6/40	FNH 6/50	FNH 6/60	FNH 6/80	FNH 8/70	FNH 8/90	FNH 8/110	FNH 8/130	FNH 8/150
d	5	6	6	6	6	8	8	8	8	8
Efektywna głębokość kotwienia (h_{ef})	20	30	30	30	30	40	40	40	40	40
Głębokość wiercenia (min.)	60	50	60	70	90	80	100	120	140	160
L	50	40	50	60	80	70	90	110	130	150
Wiertło \varnothing	5	6	6	6	6	8	8	8	8	8
Zakres uchwytu (maks.)	30	10	20	30	50	30	50	70	90	110
Dopuszczalne obciążenie w kN										
Beton \geq C20/25	0.10	0.35	0.35	0.35	0.35	0.60	0.60	0.60	0.60	0.60

- Powłokanie powierzchniowe DACROMET® eliminuje możliwości uszkodzenia, jakie może wywołać kruchość wodorowa.
- Głębokość wiercenia (min.) do mocowania na wylot.
- Obciążenia w kN ważne dla zastosowań niestrukturalnych.
- Współczynnik bezpieczeństwa 4.

Kolejność montażu

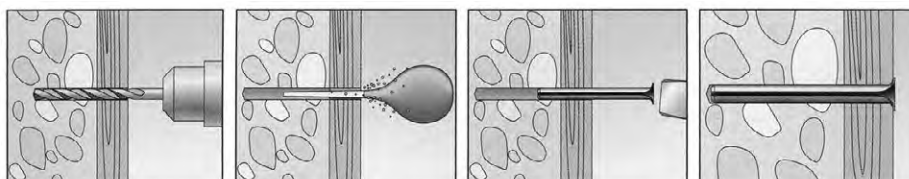

63223 FISCHER Tulejki do gwoździ, typ FNH

N03A

Materiał Stal
Obróbka powierzchni Dacromet 500 LC Grade A

fischer
innovative solutions



Typ	☒	Kod artykułu	Typ	☒	Kod artykułu	Typ	☒	Kod artykułu
FNH 5/50	100	63223.050.050	FNH 6/80	100	63223.060.080	FNH 8/110	50	63223.080.110
FNH 6/40	100	63223.060.040	FNH 8/70	100	63223.080.070	FNH 8/130	100	63223.080.130
FNH 6/50	100	63223.060.050	FNH 8/90	50	63223.080.090	FNH 8/150	50	63223.080.150
FNH 6/60	100	63223.060.060						

Kołki do ścian HammerFast

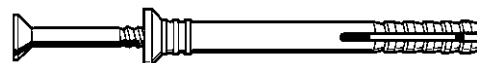
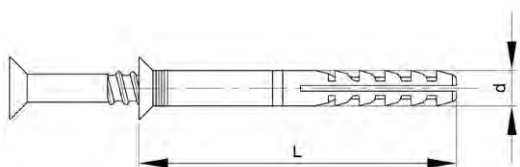

Informacje techniczne

d x L	5x30	5x35	5x50	6x40	6x50	6x60	8x60	8x80	8x100	8x120
Głębokość wiercenia (min.)	50	55	70	60	70	80	80	100	120	140
Wiertło \varnothing	5	5	5	6	6	6	8	8	8	8
Zakres	5	10	25	10	20	30	20	40	60	80
Dopuszczalne obciążenie w kN										
Beton \geq C20/25	0.32	0.32	0.32	0.36	0.36	0.36	0.44	0.44	0.44	0.44
Cegła \geq Mz12	0.20	0.20	0.20	0.28	0.28	0.28	0.36	0.36	0.36	0.36

- Obciążenia w kN ważne dla wkręto-gwoździ o odpowiedniej średnicy.
- Współczynnik bezpieczeństwa 5.

30510 MAXXFAST Kołki do ścian HammerFast

MF50

Materiał Plastik Nylon (poliamid)
Obróbka powierzchni Ocynkowane
Kolor Szary

MAXXFAST
PROFESSIONAL HARDWARE



d x L	☒	Kod artykułu	d x L	☒	Kod artykułu	d x L	☒	Kod artykułu
5X30MM	100	30510.050.030	6X50MM	100	30510.060.050	8X80MM	50	30510.080.080
5X35MM	100	30510.050.035	6X60MM	100	30510.060.060	8X100MM	50	30510.080.100
5X50MM	100	30510.050.050	8X60MM	100	30510.080.060	8X120MM	50	30510.080.120
6X40MM	100	30510.060.040						

- Tylko pełne opakowania.

Kołki mocujące wbijane, typ N-Z

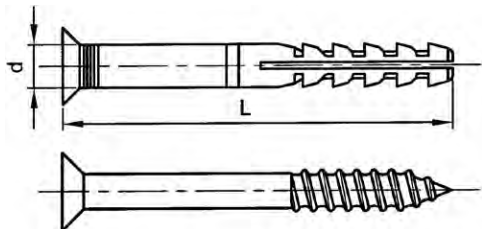

Informacje techniczne

Typ	N5x 30 Z	N5x 40 Z	N5x 50 Z	N6x 40 Z	N6x 60 Z	N6x 80 Z	N8x 60 Z	N8x 80 Z	N8x 100 Z	N8x 120 Z	N10x 100 Z	N10x 135 Z	N10x 160 Z
d	5	5	5	6	6	6	8	8	8	8	10	10	10
Głębokość wiercenia (min.)	45	55	65	55	75	95	75	95	115	135	115	150	175
L	30	40	50	40	60	80	60	80	100	120	100	135	160
Wiertło \varnothing	5	5	5	6	6	6	8	8	8	8	10	10	10
Wymiary gwóźdźnia	3.5x38	3.5x48	3.5x58	4x48	4x64	4x88	5x65	5x85	5x105	5x120	7x110	7x145	7x170
Zakres uchwytu (maks.)	5	15	25	10	30	50	20	40	60	80	50	85	110
Dopuszczalne obciążenie w kN													
Beton komórkowy \geq PB2. PP2 (G2)	0.03	0.03	0.03	0.04	0.04	0.04	0.05	0.05	0.05	0.05	0.1	0.1	0.1
Beton komórkowy \geq PB4. PP4 (G4)	0.5	0.5	0.5	0.65	0.65	0.65	0.8	0.8	0.8	0.8	1.2	1.2	1.2
Cegła Mz12	0.14	0.14	0.14	0.18	0.18	0.18	0.24	0.24	0.24	0.24	0.3	0.3	0.3
Cegła silikatowa KS12	0.14	0.14	0.14	0.17	0.17	0.17	0.24	0.24	0.24	0.24	0.33	0.33	0.33
Siła wyciągająca z betonu C20/25	0.16	0.16	0.16	0.2	0.2	0.2	0.27	0.27	0.27	0.27	0.33	0.33	0.33
Żwir pumeksowy V4	0.05	0.05	0.05	0.12	0.12	0.12	0.15	0.15	0.15	0.15	0.16	0.16	0.16

- Obciążenia w kN ważne dla gwóźdźni o odpowiedniej średnicy.
- Współczynnik bezpieczeństwa 4
- Z montowanym wstępnie gwóźdźniem pasywacja na żółto lub gwóźdźniem z łbem z wgłębieniem krzyżowym Pozidriv (Z), stal nierdzewna A2.

Kolejność montażu

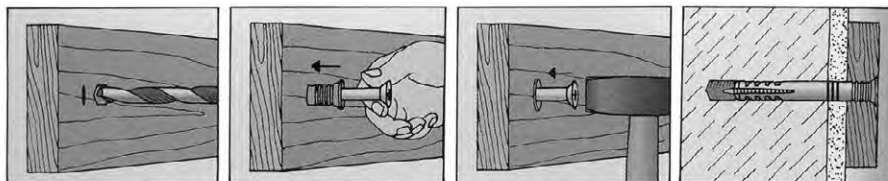

8

Grupy katalogowe

Materiał	Obróbka powierzchni	Kolor	Kod	Strona
Plastik Nylon	Ocynk.	Różny	63611	8-28
Plastik Nylon		Szary	63616	8-29

63611 FISCHER Kołki mocujące wbijane, typ N-Z

N03C

Materiał Plastik Nylon (poliamid)
 Obróbka powierzchni Ocynkowane
 Kolor Różny

fischer
 innovative solutions



Typ	☒	Kod artykułu	Typ	☒	Kod artykułu	Typ	☒	Kod artykułu
N5X30MM	100	63611.050.030	N5X50MM Białe	100	63611.050.511	N8X100MM	50	63611.080.100
N5X30MM Brązowy	100	63611.050.031	N6X40MM	50	63611.060.040	N8X120MM	50	63611.080.120
N5X40MM Brązowy	100	63611.050.040	N6X60MM	50	63611.060.060	N10X100MM	50	63611.100.100
N5X40MM	100	63611.050.041	N6X80MM	50	63611.060.080	N10X135MM	50	63611.100.135
N5X50MM	100	63611.050.050	N8X60MM	50	63611.080.060	N10X160MM	50	63611.100.160
N5X40MM Białe	100	63611.050.411	N8X80MM	50	63611.080.080			

63616	FISCHER Kołki mocujące wbijane, typ N-Z	N03C
Materiał Kolor	Plastik Nylon (poliamid) Szary	

Typ	☒	Kod artykułu	Typ	☒	Kod artykułu	Typ	☒	Kod artykułu
5X30MM	100	63616.050.030	6X60MM	50	63616.060.060	8X80MM	50	63616.080.080
6X40MM	50	63616.060.040	8X60MM	50	63616.080.060	8X100MM	50	63616.080.100

Kołki mocujące wbijane, typ N-FZ

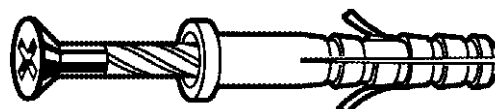
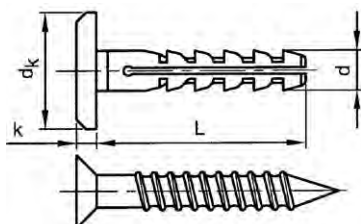

Informacje techniczne

Typ	N6x40 FZ	N8x40 FZ
d	6	8
dk	13	20
Głębokość wiercenia (min.)	55	55
L	40	40
Wiertło \varnothing	6	8
Wymiary gwoździa	4x48	5x45
Zakres uchwytu (maks.)	7	0.5
Dopuszczalne obciążenie w kN		
Beton komórkowy G2	0.04	0.05
Beton komórkowy G4	0.10	0.13
Cegła Mz12	0.18	0.24
Cegła silikatowa KS12	0.17	0.24
Siła wyciągająca z betonu C20/25	0.20	0.27
Żwir pumekсовy V4	0.12	0.15

- Obciążenia w kN ważne dla gwoździ o odpowiedniej średnicy.
- Współczynnik bezpieczeństwa 4.

Kolejność montażu

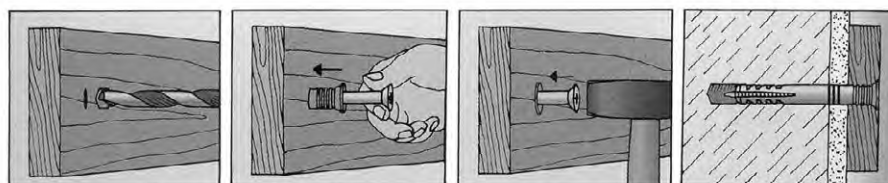

63615	FISCHER Kołki mocujące wbijane, typ N-FZ	N03C
Materiał Kolor	Plastik Nylon (poliamid) Szary	

Typ	☒	Kod artykułu	Typ	☒	Kod artykułu
N 6X40 FZ	50	63615.060.040	N 8X40 FZ	50	63615.080.040

Kołki mocujące wbijane, typ N-D

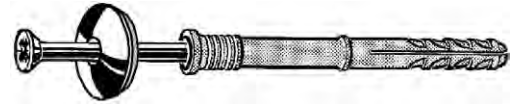
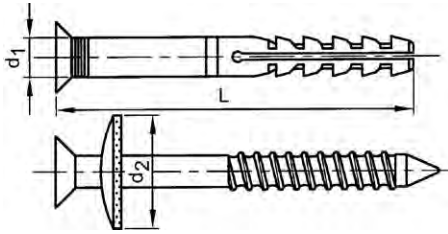

Informacje techniczne

Typ	N6x40 D	N6x60 D
d ₁	6	6
d ₂	19	19
Efektywna głębokość kotwiczenia (h _{ef})	30	30
Głębokość wiercenia (min.)	55	75
L	40	60
Wiertło ø	6	6
Wymiary gwoźdźa	4x48	4x64
Zakres uchwytu (maks.)	10	30
Dopuszczalne obciążenie w kN		
Beton komórkowy PB2. PP2 (G2)	0.04	0.04
Beton komórkowy PB4. PP4 (G4)	0.1	0.1
Cegła Mz12	0.18	0.18
Cegła silikatowa KS12	0.17	0.17
Siła wyciągająca z betonu C20/25	0.2	0.2
Żwir pumekсовy V4	0.12	0.12

- Obciążenia w kN ważne dla gwoździ o odpowiedniej średnicy.
- Współczynnik bezpieczeństwa 4.

63617 FISCHER Kołki mocujące wbijane, typ N-D

N03C

Materiał Plastik Nylon (poliamid)
Kolor Szary

fischer
innovative solutions



Typ	☒	Kod artykułu	Typ	☒	Kod artykułu
6X40MM	50	63617.060.040	6X60MM	50	63617.060.060

- Z zamontowanym wstępnie gwoździem ze stali nierdzewnej A2 z wgłębieniem krzyżowym Pozidriv (Z) i podkładką izolacyjną ze stali nierdzewnej A2 i elastomeru.

Mocowania z długim trzonkiem, typ SXS

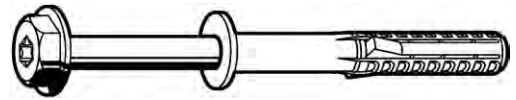
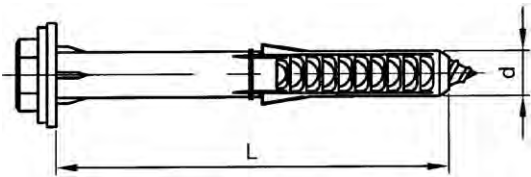

Informacje techniczne

Typ	SX10x80 T	SX10x100 T	SX10x140 T	SX10x160 T	SXS 10x60 F US A4	SXS 10x80 F US A4	SXS 10x100 F US A4	SXS 10x120 F US A4	SXS 10x140 F US A4	SXS 10x160 F US A4
d	10	10	10	10	10	10	10	10	10	10
Głębokość wiercenia (min.)	90	110	150	170	70	90	110	130	150	170
L	80	100	140	160	60	80	100	120	140	160
Nasadka	No.40	No.40	No.40	No.40	No.40	No.40	No.40	No.40	No.40	No.40
Rozmiar śruby	7x87	7X107	7X147	7x167	7x69	7x89	7x109	7x129	7x149	7x169
Wiertło ø	10	10	10	10	10	10	10	10	10	10
Zakres uchwytu (maks.)	30	50	90	110	10	30	50	70	90	110
Dopuszczalne obciążenie w kN										
Beton ≥ C16/20	2	2	2	2	2	2	2	2	2	2

- Dopuszczalne obciążenie dla pojedynczej kotwy w mocowaniach wielopunktowych, niestrukturalnych zastosowaniach w normalnym betonie.
- Do obliczeń kombinacji naprężeń, obciążeń, momentów zginających oraz zastosowań krańcowych zobacz w aprobacie technicznej.

Kolejność montażu

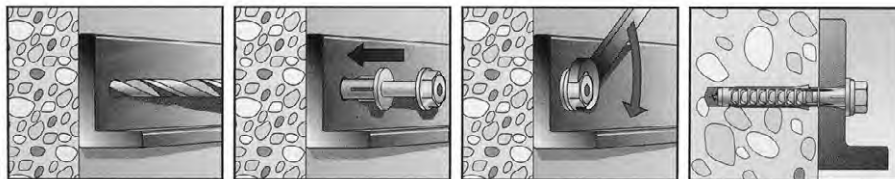

Grupy katalogowe

Material		Kolor	Kod	Strona
Plastik	SXS-T	Szary	63298	8-31
Plastik	SXS-F US A4	Szary	63174	8-32

63298 FISCHER Mocowania z długim trzonkiem, typ SXS-T

N03A

Material Plastik
Kolor Szary

fischer
innovative solutions



Kolejność montażu

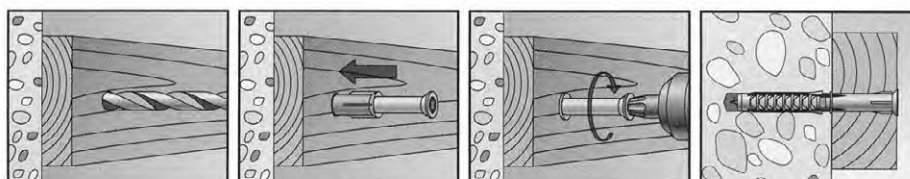

Typ	☒	Kod artykułu	Typ	☒	Kod artykułu	Typ	☒	Kod artykułu
SXS 10X80T	50	63298.100.080	SXS 10X140T	50	63298.100.140	SXS 10X160T	50	63298.100.160
SXS 10X100T	50	63298.100.100						

- Z zamontowaną wstępnie śrubą ze stali cynkowej z łbem stożkowym z wgłębieniem sześciokątowym.

63174 FISCHER Mocowania z długim trzonkiem, typ SXS-F US A4 **N03A**

Materiał Plastik
Kolor Szary

fischer
innovative solutions

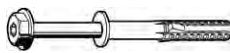

Typ	☒	Kod artykułu	Typ	☒	Kod artykułu	Typ	☒	Kod artykułu
10X60	50	63174.100.060	10X100	50	63174.100.100	10X140	50	63174.100.140
10X80	50	63174.100.080	10X120	50	63174.100.120	10X160	50	63174.100.160

- Połączenie z kołnierzem $\varnothing 18 \times 2$ mm, z zamontowaną wstępnie śrubą ze stali nierdzewnej z łbem sześciokątnym A4 z wgłębieniem sześciokątnym i ze zintegrowaną podkładką.

Kotwy do mocowania ram

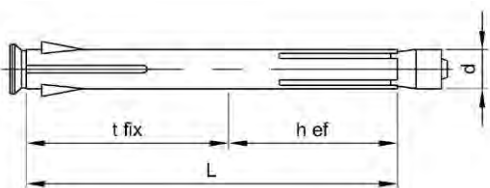

Informacje techniczne

d x L	10x72	10x92	10x112	10x132	10x152	10x182
Efektowna głębokość kotwienia (h_{ef})	40	40	40	40	40	40
Głębokość wiercenia (min.)	60	60	60	60	60	60
Siła wyciągająca w kN	1.7	1.7	1.7	1.7	1.7	1.7
Siła ścinająca w N	500	500	500	500	500	500
Wiertło \varnothing	10	10	10	10	10	10
Grubość armatury ($t_{fix,max}$)	40	60	80	100	120	150
\varnothing łba nitu	13	13	13	13	13	13
\varnothing Śruby	M6	M6	M6	M6	M6	M6

30569 MAXXFAST Kotwy do mocowania ram **MF4A**

Materiał Stal
Obróbka powierzchni Ocynkowane

MAXXFAST
PROFESSIONAL HARDWARE





d x L	☒	Kod artykułu	d x L	☒	Kod artykułu	d x L	☒	Kod artykułu
10X72	50	30569.060.072	10X112	50	30569.060.112	10X152	50	30569.060.152
10X92	50	30569.060.092	10X132	50	30569.060.132	10X182	50	30569.060.182

Kotwy do mocowania ram nylon

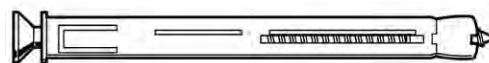
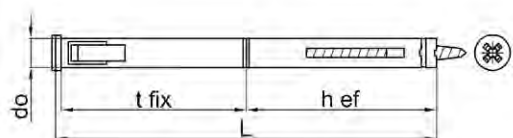

Informacje techniczne

$d_o \times L$	8x80	8x100	8x120	8x140	10x100	10x120	10x140	10x165
Efektywna głębokość kotwiczenia (h_{ef})	40	40	40	40	50	50	50	50
Głębokość wiercenia (min.)	55	55	55	55	55	55	55	55
Siła wyciągająca w N	560	560	560	560	960	960	960	960
Siła ścinająca w N	160	160	160	160	240	240	240	240
T_{inst}	4	4	4	4	4	4	4	4
Wiertło \varnothing	8	8	8	8	10	10	10	10
Grubość armatury ($t_{fix,max}$)	30	50	70	90	40	60	80	105
\varnothing łba nitu	10	10	10	10	12	12	12	12

- T_{inst} = Moment obrotowy dokręcania w Nm.

30509 MAXXFAST Kotwy do mocowania ram nylon

MF5A

Materiał Plastik Nylon (poliamid)

MAXXFAST
PROFESSIONAL HARDWARE



Wierci $\varnothing \times L$	☒	Kod artykułu	Wierci $\varnothing \times L$	☒	Kod artykułu	Wierci $\varnothing \times L$	☒	Kod artykułu
8X80	50	30509.080.080	8X140	50	30509.080.140	10X120	50	30509.100.120
8X100	50	30509.080.100				10X140	50	30509.100.140
8X120	50	30509.080.120	10X100	50	30509.100.100	10X165	50	30509.100.165

Śruby do mocowania ram, typ F-S

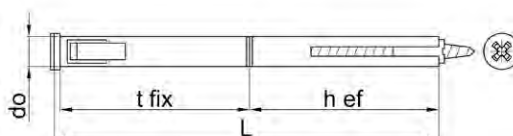

Informacje techniczne

Typ	d_o	h_{ef}	L	Min. t_d	t_{fix}
F 10 S 75	10	50	75	90	15
F 10 S 100	10	50	100	115	40
F 10 S 120	10	50	120	135	60
F 10 S 140	10	50	140	155	80
F 10 S 165	10	50	165	180	105

- d_o = Nominalna średnica bitu
- Min. t_d = Zalecana głębokość wiercenia
- h_{ef} = Efektywna głębokość kotwiczenia
- t_{fix} = Zakres uchwytu

Kolejność montażu

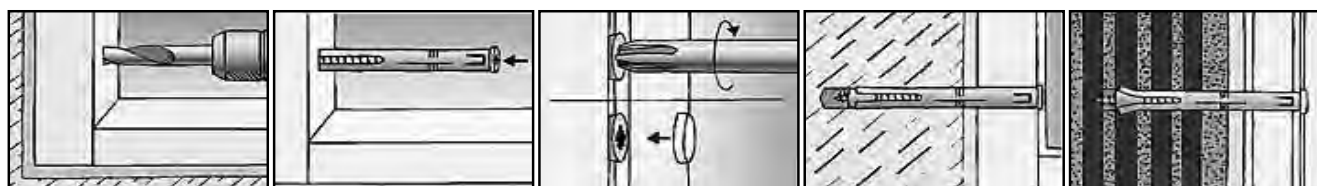

63191	FISCHER Śruby do mocowania ram, typ F-S	N03A
Materiał	Plastik Nylon (poliamid)	
Kolor	Szary	

Typ	☒	Kod artykułu	Typ	☒	Kod artykułu	Typ	☒	Kod artykułu
F 10 S 75	50	63191.100.075	F 10 S 120	50	63191.100.120	F 10 S 165	50	63191.100.165
F 10 S 100	50	63191.100.100	F 10 S 140	50	63191.100.140			

Kotwy do mocowania ram, typ F-M

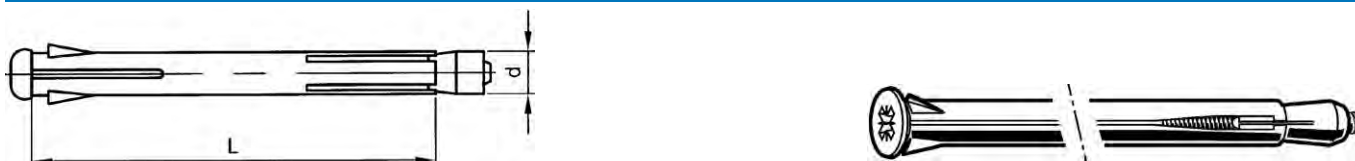

Informacje techniczne

Typ	F 8 M 72	F 8 M 92	F 8 M 112	F 8 M 132	F 10 M 72	F 10 M 92	F 10 M 112	F 10 M 132	F 10 M 152	F 10 M 182	F 10 M 202
d	8	8	8	8	10	10	10	10	10	10	10
Efektowna głębokość kotwienia (h_{ef})	30	30	30	30	30	30	30	30	30	30	30
Głębokość wiercenia (min.)	90	110	130	150	90	110	130	150	170	200	220
L	72	92	112	132	72	92	112	132	152	182	202
Wierćło ø	8	8	8	8	10	10	10	10	10	10	10
Zakres uchwytu (maks.)	42	62	82	102	42	62	82	102	122	152	172
Dopuszczalne obciążenie w kN											
Beton ≥ C20/25	-	-	-	-	1.38	1.38	1.38	1.38	1.38	1.38	1.38
Cegła silikatowa ≥ KS12	-	-	-	-	1.28	1.28	1.28	1.28	1.28	1.28	1.28
Cegła ≥ Mz12	-	-	-	-	1.28	1.28	1.28	1.28	1.28	1.28	1.28
Pusta cegła silikatowa ≥ KSL6	-	-	-	-	0.55	0.55	0.55	0.55	0.55	0.55	0.55
Żwir pumeksowy ≥ V2	-	-	-	-	0.48	0.48	0.48	0.48	0.48	0.48	0.48

- Dopuszczalne obciążenie pojedynczej kotwy w wielokrotnych mocowaniach dla zastosowań nie konstrukcyjnych.
- Współczynnik bezpieczeństwa 4.
- Ocynkowany aluminiowy rękaw ze stalowa, ocynkowaną śrubą z napędem Pozidriv (Z).

8

Kolejność montażu

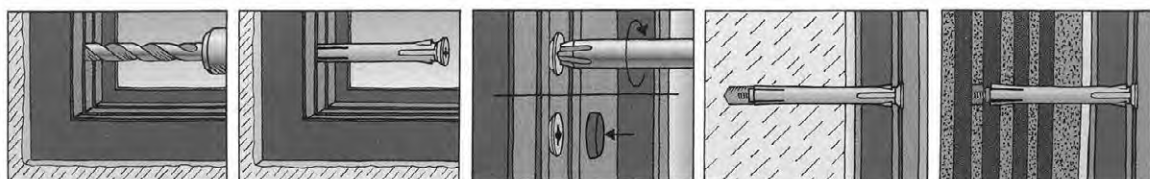

63190	FISCHER Kotwy do mocowania ram, typ F-M	N03A
Materiał	Stal	

Typ	☒	Kod artykułu	Typ	☒	Kod artykułu	Typ	☒	Kod artykułu
F 8 M 72	100	63190.080.072	F 10 M 72	100	63190.100.072	F 10 M 152	100	63190.100.152
F 8 M 92	100	63190.080.092	F 10 M 92	100	63190.100.092	F 10 M 182	50	63190.100.182
F 8 M 112	100	63190.080.112	F 10 M 112	100	63190.100.112	F 10 M 202	50	63190.100.202
F 8 M 132	100	63190.080.132	F 10 M 132	100	63190.100.132			

- F 8 M: Łeb grzybkowy
- F 10 M: Łeb stożkowy płaski

Śruby do mocowania ram, typ FUR-T

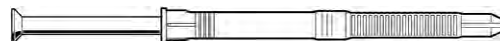
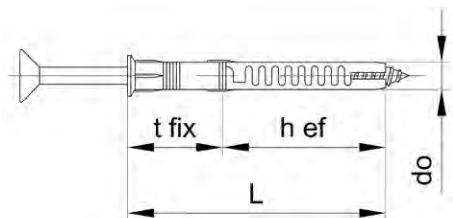

Informacje techniczne

$d_o \times L$	8x100	8x120	10x100	10x115	10x135
h_{ef}	70	70	70	70	70
Min. t_d	110	130	110	125	145
Nasadka	T30	T30	T40	T40	T40
S	10	10	13	13	13
t_{fix}	30	50	30	45	65
Dopuszczalne obciążenie w kN					
Beton \geq C12/15	-	-	1.8	1.8	1.8

- d_o = Nominalna średnica bitu
- Min. t_d = Zalecana głębokość wiercenia
- h_{ef} = Efektywna głębokość kotwienia
- t_{fix} = Zakres uchwytu
- Dopuszczalne obciążenie pojedynczej kotwy w wielokrotnych mocowaniach dla zastosowań nie konstrukcyjnych w normalnym betonie.
- Do obliczeń kombinacji naprężeń, obciążeń, momentów zginających oraz zastosowań krańcowych zobacz w aprobacie technicznej.

Kolejność montażu

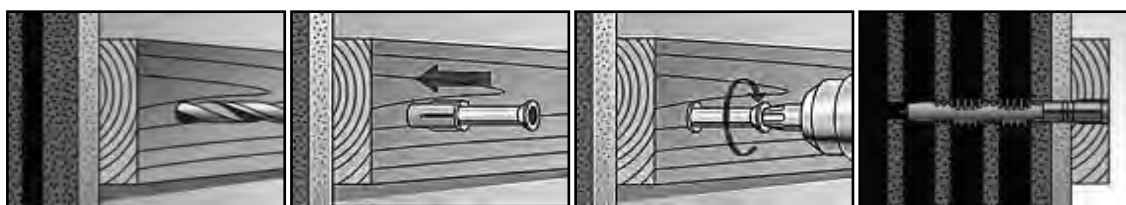

63195 FISCHER Śruby do mocowania ram, typ FUR-T

N03A

Materiał: Plastik Nylon (poliamid)
Kolor: Szary

fischer
innovative solutions



Wiercić $\phi \times L$	☒	Kod artykułu	Wiercić $\phi \times L$	☒	Kod artykułu	Wiercić $\phi \times L$	☒	Kod artykułu
8X100MM	50	63195.080.100	10X100MM	50	63195.100.100	10X135MM	50	63195.100.135
8X120MM	50	63195.080.120	10X115MM	50	63195.100.115			

Śruby do mocowania ram, typ FUR-SS

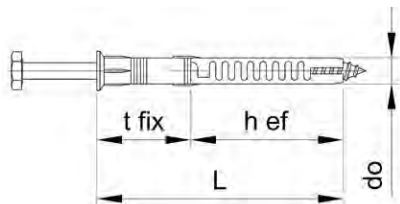

Informacje techniczne

$d_o \times L$	h_{ef}	Min. t_d	t_{fix}
8x80	70	90	10
8x100	70	110	30
8x120	70	130	50
10x80	70	90	10
10x100	70	110	30
10x115	70	125	45
10x135	70	145	65
10x160	70	170	90
10x185	70	195	115
10x200	70	210	130
10x230	70	240	160

- d_o = Nominalna średnica bitu
- Min. t_d = Zalecana głębokość wiercenia
- h_{ef} = Efektywna głębokość kotwowania
- t_{fix} = Zakres uchwytu

Kolejność montażu

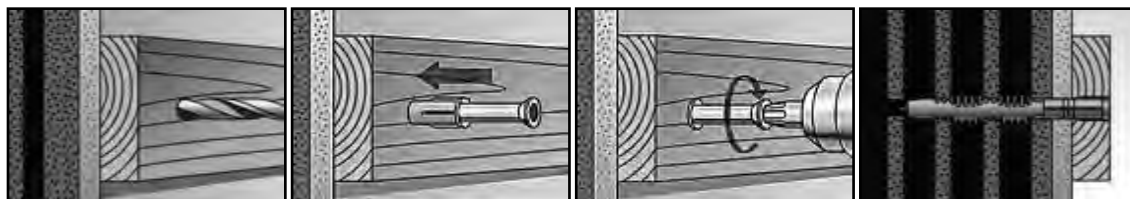

63196 FISCHER Śruby do mocowania ram, typ FUR-SS

N03A

Materiał Plastik Nylon (poliamid)
Kolor Szary

fischer
innovative solutions



$d_o \times L$	☒	Kod artykułu	$d_o \times L$	☒	Kod artykułu	$d_o \times L$	☒	Kod artykułu
8X80MM	50	63196.080.080	10X80MM	50	63196.100.080	10X160MM	50	63196.100.160
8X100MM	50	63196.080.100	10X100MM	50	63196.100.100	10X185MM	50	63196.100.185
8X120MM	50	63196.080.120	10X115MM	50	63196.100.115	10X200MM	50	63196.100.200
			10X135MM	50	63196.100.135	10X230MM	50	63196.100.230

Śruby do mocowania ram, typ SXR-T

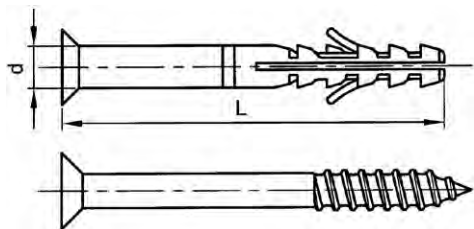

Informacje techniczne

$d_o \times L$	8x60	8x80	8x100	8x120	10x80	10x100	10x120	10x140	10x160
h_{ef}	50	50	50	50	50	50	50	50	50
Min. t_d	70	90	110	130	90	110	130	150	170
Nasadka	T30	T30	T30	T30	T40	T40	T40	T40	T40
t_{fix}	10	30	50	70	30	50	70	90	110
Dopuszczalne obciążenie w kN									
Beton \geq C12/15	1.20	1.20	1.20	1.20	1.98	1.98	1.98	1.98	1.98
Cegła silikatowa \geq KS12	0.71	0.71	0.71	0.71	0.86	0.86	0.86	0.86	0.86
Cegła \geq Mz12	0.57	0.57	0.57	0.57	0.57	0.57	0.57	0.57	0.57
Pusta cegła silikatowa KSL12	0.57	0.57	0.57	0.57	0.57	0.57	0.57	0.57	0.57
Wentylacja kamienna Hlz12	0.17	0.17	0.17	0.17	0.26	0.26	0.26	0.26	0.26
Żwir pumeksowy \geq V2	-	-	-	-	0.71	0.71	0.71	0.71	0.71

- d = Nominalna średnica bitu.
- Min. t_d = Zalecana głębokość wiercenia.
- h_{ef} = Efektywna głębokość kotwienia.
- t_{fix} = zakres uchwytu.
- Dopuszczalne obciążenie pojedynczej kotwy w wielokrotnych mocowaniach dla zastosowań niekonstrukcyjnych
- Dopuszczalne obciążenie zawiera współczynnik bezpieczeństwa 1,4
- Do obliczeń kombinacji naprężeń, obciążeń, momentów zginających oraz zastosowań krańcowych zobacz w aprobacie technicznej.

Kolejność montażu

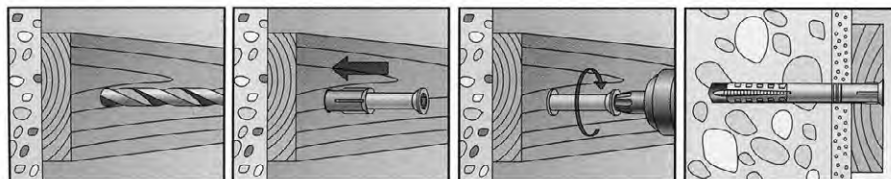

63192 FISCHER Kotwy do mocowania ram, typ SXR-T

N03A

Materiał Plastik Nylon (poliamid)
Kolor Szary

fischer
innovative solutions



Wierci ϕ x L	☒	Kod artykułu	Wierci ϕ x L	☒	Kod artykułu	Wierci ϕ x L	☒	Kod artykułu
8X60MM	50	63192.080.060	8X120MM	50	63192.080.120	10X120MM	50	63192.100.120
8X80MM	50	63192.080.080	10X80MM	50	63192.100.080	10X140MM	50	63192.100.140
8X100MM	50	63192.080.100	10X100MM	50	63192.100.100	10X160MM	50	63192.100.160

Śruby do mocowania ościeżnic okiennych

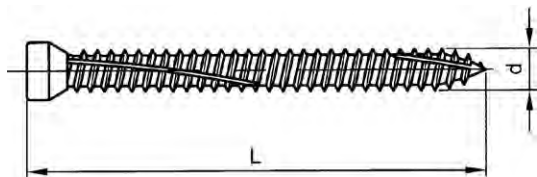

Informacje techniczne

Typ	L	Wiertło \varnothing
7.5x72	72	6
7.5x92	92	6
7.5x112	112	6
7.5X132	132	6
7.5X152	152	6
7.5X182	182	6
7.5X212	212	6

- Odpowiednie do betonu, litej cegły, cegieł silikatowych, cegieł perforowanych, perforowanych cegieł silikatowych, pustaków, lekkiego pumeksu, betonu napowietrzanego, naturalnego kamienia etc.

Kolejność montażu

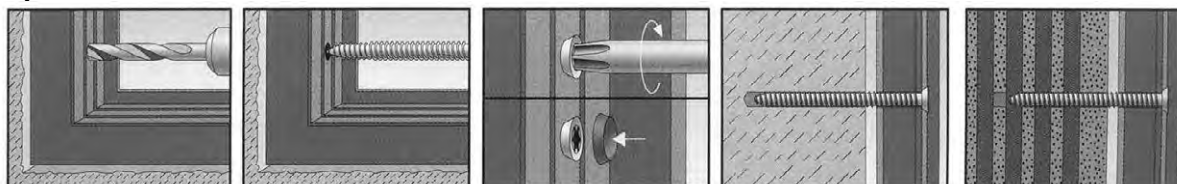

Grupy katalogowe

Gniazdo	Materiał	Obróbka powierzchni	Kod	Strona
Sześciokarbony	Stal	Ocynk.	30564	8-38
Sześciokarbony	Stal	Ocynk.	30565	8-38
Torx®	Stal	Ocynk.	FFSZ 63560	8-39
Torx®	Stal	Ocynk.	FFS 63562	8-39

8

30564 MAXXFAST Śruby do mocowania ościeżnic okiennych - Head 11,5/Sześciokarbony 30 MF4A

Materiał: Stal
Obróbka powierzchni: Ocynkowane

MAXXFAST
PROFESSIONAL HARDWARE

d x L	⊠	Kod artykułu	d x L	⊠	Kod artykułu	d x L	⊠	Kod artykułu
7,5X72MM	100	30564.075.072	7,5X132MM	100	30564.075.132	7,5X182MM	100	30564.075.182
7,5X92MM	100	30564.075.092	7,5X152MM	100	30564.075.152	7,5X212MM	100	30564.075.212
7,5X112MM	100	30564.075.112						

30565 MAXXFAST Śruby do mocowania ościeżnic okiennych - Head 7,5/Sześciokarbony 25 MF5A



Materiał: Stal
Obróbka powierzchni: Ocynkowane

MAXXFAST
PROFESSIONAL HARDWARE

d x L	⊠	Kod artykułu	d x L	⊠	Kod artykułu	d x L	⊠	Kod artykułu
7,5X72MM	100	30565.075.072	7,5X112MM	100	30565.075.112	7,5X132MM	100	30565.075.132
7,5X92MM	100	30565.075.092						

63560 FISCHER Śruby do mocowania ościeżnic okiennych, typ FFSZ - Head 7,5/TX 25 N03A

Materiał: Stal
Obróbka powierzchni: Ocynkowane



 



Typ	☒	Kod artykułu	Typ	☒	Kod artykułu	Typ	☒	Kod artykułu
FFSZ 7,5X72	100	63560.075.072	FFSZ 7,5X112	100	63560.075.112	FFSZ 7,5X152	100	63560.075.152
FFSZ 7,5X92	100	63560.075.092	FFSZ 7,5X132	100	63560.075.132	FFSZ 7,5X212	100	63560.075.212

63562 FISCHER Śruby do mocowania ościeżnic okiennych, typ FFS - Head 11,5/TX 30 N03A

Materiał: Stal
Obróbka powierzchni: Ocynkowane



Typ	☒	Kod artykułu	Typ	☒	Kod artykułu	Typ	☒	Kod artykułu
FFS 7,5X72	100	63562.075.072	FFS 7,5X132	100	63562.075.132	FFS 7,5X182	100	63562.075.182
FFS 7,5X92	100	63562.075.092	FFS 7,5X152	100	63562.075.152	FFS 7,5X212	100	63562.075.212
FFS 7,5X112	100	63562.075.112						



Nasadki na śruby mocujące ościeżnice okienne, typ FSS A

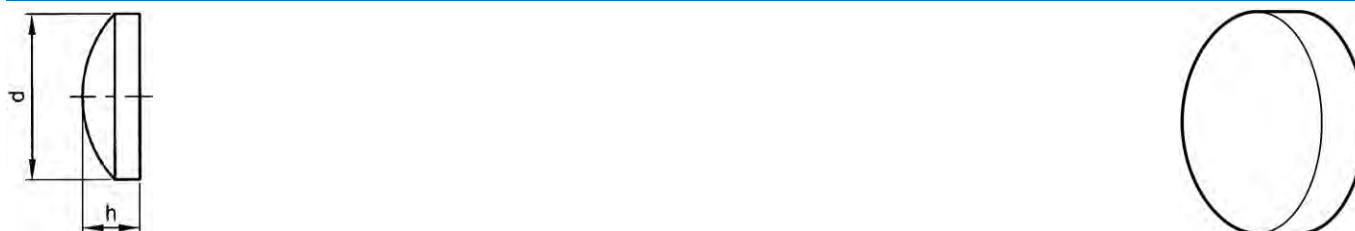

Informacje techniczne		
Typ	d	h
FSS A-W	15	4
FSS A-BR	15	4

63590 FISCHER Nasadki na śruby mocujące ościeżnice okienne, typ FSS A N03A

Materiał: Plastik Poliamid (nylon)
Klasa: 6
Kolor: Różny

Typ	☒	Kod artykułu	Typ	☒	Kod artykułu
Biały	100	63590.000.011	Ciemny brązowy	100	63590.000.019

Śruby regulowane, typ JS

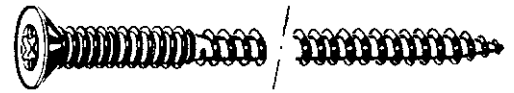

Informacje techniczne

Typ	JS 6x110
Grubość drewna (maks.)	25
Głębokość montażu (min.)	30
Głębokość wiercenia (min.)	50-110
Nasadka	T40
Regulacja bezstopniowa	0-55
Wiertło \varnothing	5

Kolejność montażu

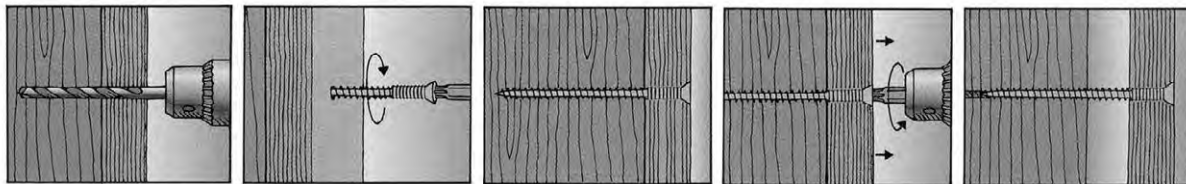

63601 FISCHER Śruby regulowane, typ JS

N03B

Materiał Stal
Obróbka powierzchni Ocynkowane

fischer
innovative solutions

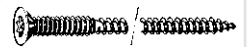

Typ Kod artykułu
JS 6X110MM 50 [63601.060.110](#)

Mocowania regulowane, typ S10J75S

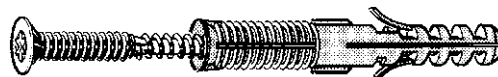

Informacje techniczne

Typ	S10J75S
Długość zatyczki	75
Grubość drewna (maks.)	25
Głębokość montażu (min.)	50
Głębokość wiercenia (min.)	115
Nasadka	T40
Regulacja bezstopniowa	0-30
Wiertło \varnothing	10

- Mocowania regulowane typu S10J75S do montażu drewna na kamieniu.
- Z regulowaną śrubą typu JS 6 x 110, ze stali cynkowanej.

Kolejność montażu

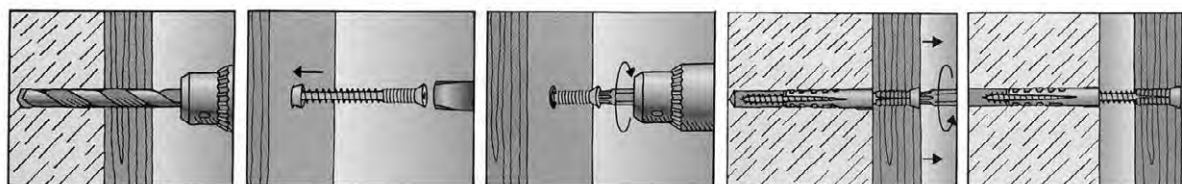

63600 FISCHER Mocowania regulowane, typ S10J75S

N03A

Materiał Plastik Nylon (poliamid)
Kolor Szary

fischer
innovative solutions



Typ	Kod artykułu
S 10-J 75 S	50 63600.060.110

Kołki rozporowe

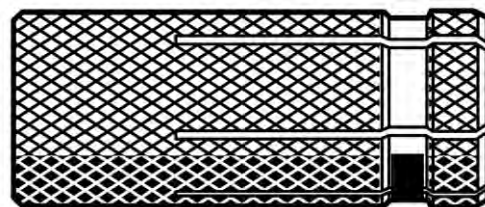
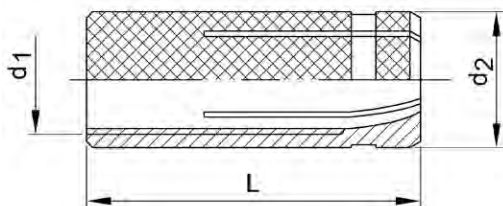

Informacje techniczne

d_1	M4	M5	M6	M8	M10	M12
d_2	5	6	8	10	12	15
Długość kołka (min.)	20	22	28	33	40	45
h_{ef}	16	18	23	28	34	38
L	16	18	23	28	34	38
Minimalna grubość podpory betonowej ($h_{min.}$)	25	30	35	40	45	50
Siła wyciągająca w N	600	700	1000	1500	2100	3200

- h_{ef} = Efektywna głębokość kotwienia.

30570	MAXXFAST Kołki rozporowe	MF5A
Gwint	Metryczny	
Materiał	Mosiądz	

d_1	☒	Kod artykułu	d_1	☒	Kod artykułu	d_1	☒	Kod artykułu
M4	50	30570.040.001	M6	50	30570.060.001	M10	25	30570.100.001
M5	50	30570.050.001	M8	25	30570.080.001	M12	25	30570.120.001

Kołki rozporowe

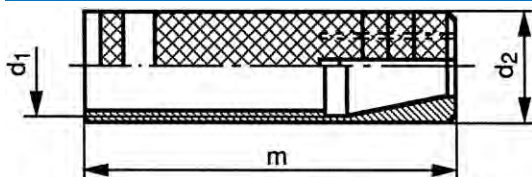

8

Informacje techniczne

d_1	M4	M5	M6	M8	M10	M12
d_2	5	6	7.5	10	12	15.5
m	16	20	24	30	34	40
P	0.7	0.8	1	1.25	1.5	1.75
Wiertło \varnothing	5.5	6.5	8	11	13	18
Siła wyciągająca w kN						
Beton \geq C20/25	0.25	0.4	0.65	1.1	1.6	2.2
Kamień \geq 15 N/mm ²	0.2	0.35	0.55	0.9	1.3	1.6

- Długość wiercenia = część mocująca + warstwa powłoki + długość zatyczki + 10 mm
- Długość śruby = część mocująca + warstwa powłoki + długość zatyczki.
- Zaleca się przyjęcie marginesu bezpieczeństwa.

Specjalne właściwości korków rozprężnych:

- dostarczane w stożkowym kształcie od wewnętrznej strony, rozprężające się jednakowo na ścianie otworu podczas zacieśniania
- zastosowanie do montowania przy pomocy osprzętu do otworów
- mogą być stosowane w betonie, kamieniu, ceglach, płytkach; kafelkach; pustakach i masywnym drewnie
- odporne na korozję
- odporne na temperatury do +200°C

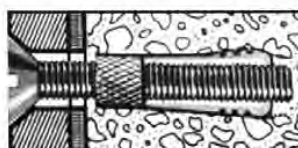
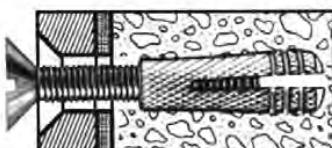

09610		Kołki rozporowe				N07A	
Gwint	Metryczny						
Materiał	Mosiądz						

d₁ x m	☒	Kod artykułu	d₁ x m	☒	Kod artykułu	d₁ x m	☒	Kod artykułu
M4X16	50	09610.040.016	M6X24	50	09610.060.024	M10X34	25	09610.100.034
M5X20	50	09610.050.020	M8X30	25	09610.080.030	M12X40	25	09610.120.040

Kołki rozporowe

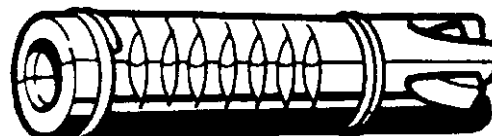
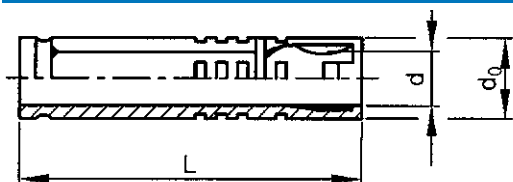

Informacje techniczne

d	M6	M8	M10	M12	M16
C_{min.}	53	60	75	90	143
d_f	6.5	9	11	13	17
d_o	12	14	16	20	25
f_s	-	-	-	-	-
h_{ef}	45	50	60	75	115
h_{min}	100	100	100	100	142.5
h_o	50	55	65	85	125
k_N	3.33	4.17	6.67	8.89	22.2
L	45	50	60	75	115
S_{min.}	35	40	50	60	95
t_{fix} (maks.)	-	-	-	-	-
T_{inst}	6.5	15	27	50	120

- **d_o** = Znamionowa średnica końcówki wiertła.
- **T_{inst}** = Moment obrotowy dokręcania w Nm.
- **d_f** = Średnica otworu w armaturze.
- **h_{min}** = Minimalna grubość podpory betonowej.
- **h_o** = Zalecana głębokość wiercenia.
- **k_N** = Zakładanym obciążeniem jest kN, beton niespękany.
- **h_{ef}** = Efektywna głębokość kotwienia.
- **S_{min.}** = Minimalny odstęp.
- **C_{min.}** = Minimalna odległość krawędzi.

65450		Kołki rozporowe				N61A	
Gwint	Metryczny						
Materiał	Stal						
Klasa	5.8						
Obróbka powierzchni	Ocynkowane						

d	☒	Kod artykułu	d	☒	Kod artykułu	d	☒	Kod artykułu
M6	100	65450.060.001	M10	100	65450.100.001	M16	25	65450.160.001
M8	100	65450.080.001	M12	50	65450.120.001			

Kotwy rozporowe nierdzewne

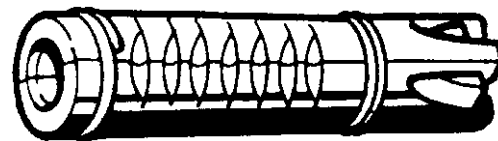
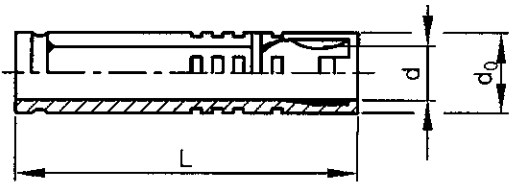

Informacje techniczne

Typ	d	d _d	d _o	k _N	L	T _{inst}
M6 (rvs)	M6	40	10	5.7	40	10
M8 (rvs)	M8	50	14	9.3	50	25
M10 (rvs)	M10	60	16	21.5	60	50
M12 (rvs)	M12	80	20	28.4	80	85

- d_n = Nominalna średnica bitu.
- d_o = Głębokość osadzenia.
- d_f = Średnica kotwy.
- k_N = Designload is k_N, Non-cracked concrete.
- T_{inst} = moment dokręcania w Nm.

09561 Kotwy rozporowe nierdzewne

P01A

Gwint Metryczny
Material Stal nierdzewna A4



d x L	☒	Kod artykułu	d x L	☒	Kod artykułu	d x L	☒	Kod artykułu
M6X40	50	09561.060.040	M10X60	25	09561.100.060	M12X80	10	09561.120.080
M8X50	50	09561.080.050						

Kotki rozporowe

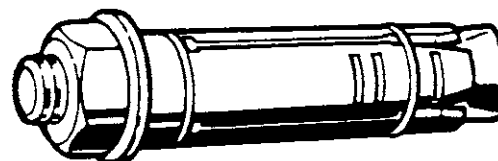
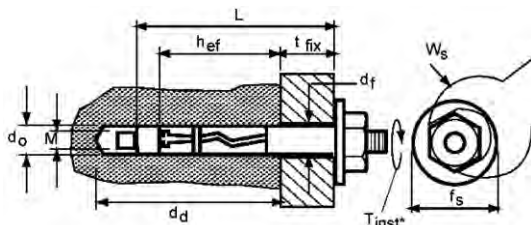

8

Informacje techniczne

d x t _{fix}	M6x10	M6x25	M6x60	M8x10	M8x25	M8x60	M10x15	M10x30	M10x60	M12x15	M12x30	M12x75	M16x15	M16x35
C _{min}	53	53	53	60	60	60	75	75	75	90	90	90	143	143
d	M6	M6	M6	M8	M8	M8	M10	M10	M10	M12	M12	M12	M16	M16
d _f	6.5	6.5	6.5	9	9	9	11	11	11	13	13	13	17	17
d _o	12	12	12	14	14	14	16	16	16	20	20	20	25	25
f _s	12.5	12.5	12.5	17	17	17	21	21	21	24	24	24	30	30
h _{ef}	45	45	45	50	50	50	60	60	60	80	80	80	120	120
h _{min}	100	100	100	100	100	100	100	100	100	100	100	100	142.5	142.5
h _o	50	50	50	55	55	55	65	65	65	85	85	85	125	125
k _N	3.33	3.33	3.33	4.17	4.17	4.17	6.67	6.67	6.67	8.89	8.89	8.89	22.2	22.2
L	65	80	115	75	90	125	90	105	135	110	125	170	150	170
s	10	10	10	13	13	13	17	17	17	19	19	19	24	24
S _{min}	35	35	35	40	40	40	50	50	50	60	60	60	95	95
t _{fix} (maks.)	10	25	60	10	25	60	15	30	60	15	30	75	15	35
T _{inst}	6.5	6.5	6.5	15	15	15	27	27	27	50	50	50	120	120

- d_n = Znamionowa średnica końcówki wiertła.
- f_s = średnica łba.
- s (W_s) = Szerokością powierzchni.
- T_{inst} = Moment obrotowy dokręcania w Nm.
- d_f = Średnica otworu w armaturze.
- h_{min} = Minimalna grubość podpory betonowej.
- d_o (h_o) = Zalecana głębokość wiercenia.
- t_{fix} = Grubość armatury.
- h_{ef} = Efektywna głębokość kotwiczenia.
- S_{min} = Minimalny odstęp.
- C_{min} = Minimalna odległość krawędzi.

65435	Kołki rozporowe	N61A
Gwint	Metryczny	
Materiał	Stal	
Klasa	5.8	
Obróbka powierzchni	Ocynkowane	



Końcowe obliczenia powinny być zgodne z pełnym Europejskim Zatwierdzeniem Technicznym (ETA), zatwierdzenie to jest również dostępne na żądanie.

$d \times t_{fix}$	☒	Kod artykułu	$d \times t_{fix}$	☒	Kod artykułu	$d \times t_{fix}$	☒	Kod artykułu
M6X10	50	65435.060.010	M8X60	50	65435.080.060	M12X15	25	65435.120.015
M6X25	50	65435.060.025	M10X15	50	65435.100.015	M12X30	25	65435.120.030
M6X60	50	65435.060.060	M10X30	50	65435.100.030	M12X75	25	65435.120.075
M8X10	50	65435.080.010	M10X60	50	65435.100.060	M16X15	10	65435.160.015
M8X25	50	65435.080.025				M16X35	10	65435.160.035

Kołki rozporowe

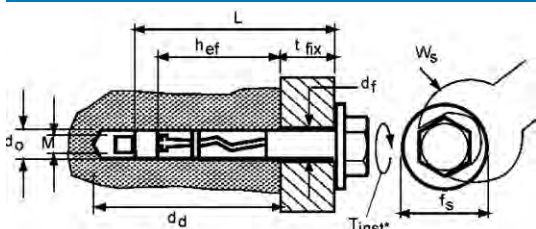

Informacje techniczne

$d \times t_{fix}$	M6x10	M6x25	M6x40	M8x10	M8x25	M8x40	M10x10	M10x25	M10x50	M10x75	M12x10	M12x40	M12x60	M16x15	M16x30	M16x60
C_{min}	53	53	53	60	60	60	75	75	75	75	90	90	90	143	143	143
d	M6	M6	M6	M8	M8	M8	M10	M10	M10	M10	M12	M12	M12	M16	M16	M16
d_f	6.5	6.5	6.5	9	9	9	11	11	11	11	13	13	13	17	17	17
d_o	12	12	12	14	14	14	16	16	16	16	20	20	20	25	25	25
f_s	12.5	12.5	12.5	17	17	17	21	21	21	21	24	24	24	30	30	30
h_{ef}	45	45	45	50	50	50	60	60	60	60	80	80	80	120	120	120
h_{min}	100	100	100	100	100	100	100	100	100	100	100	100	100	142.5	142.5	142.5
h_o	50	50	50	55	55	55	65	65	65	65	85	85	85	125	125	125
k_N	3.33	3.33	3.33	4.17	4.17	4.17	6.67	6.67	6.67	6.67	8.89	8.89	8.89	22.2	22.2	22.2
L	55	70	85	65	80	95	75	90	115	140	90	120	140	135	150	180
s	10	10	10	13	13	13	17	17	17	17	19	19	19	24	24	24
S_{min}	35	35	35	40	40	40	50	50	50	50	60	60	60	95	95	95
t_{fix} (maks.)	10	25	40	10	25	40	10	25	50	75	10	40	60	15	30	60
T_{inst}	6.5	6.5	6.5	15	15	15	27	27	27	27	50	50	50	120	120	120

- d_o = Znamionowa średnica końcówki wiertła.
- f_s = średnica łba.
- s (W_s) = Szerokością powierzchni.
- T_{inst} = Moment obrotowy dokręcania w Nm.
- d_f = Średnica otworu w armaturze.
- h_{min} = Minimalna grubość podpory betonowej.
- d_d (h_o) = Zalecana głębokość wiercenia.
- t_{fix} = Grubość armatury.
- h_{ef} = Efektywna głębokość kotwienia.
- S_{min} = Minimalny odstęp.
- C_{min} = Minimalna odległość krawędzi.

65445	Kołki rozporowe	N61A
Gwint	Metryczny	
Materiał	Stal	
Klasa	5.8	



Końcowe obliczenia powinny być zgodne z pełnym Europejskim Zatwierdzeniem Technicznym (ETA),
zatwierdzenie to jest również dostępne na żądanie.

$d \times t_{fix}$	☒	Kod artykułu	$d \times t_{fix}$	☒	Kod artykułu	$d \times t_{fix}$	☒	Kod artykułu
M6X10	50	65445.060.010	M10X10	50	65445.100.010	M12X40	25	65445.120.040
M6X25	50	65445.060.025	M10X25	50	65445.100.025	M12X60	25	65445.120.060
M6X40	50	65445.060.040	M10X50	50	65445.100.050	M16X15	10	65445.160.015
M8X10	50	65445.080.010	M10X75	50	65445.100.075	M16X30	10	65445.160.030
M8X25	50	65445.080.025	M12X10	25	65445.120.010	M16X60	10	65445.160.060
M8X40	50	65445.080.040						

Kotwy rozporowe z mosiężnym stożkiem, typ M

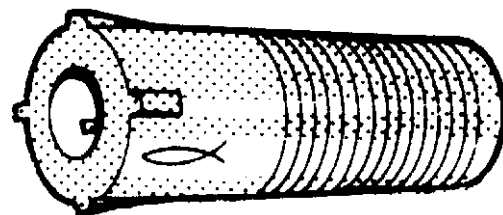
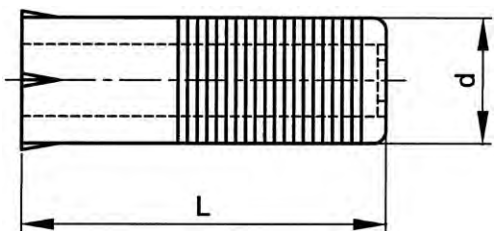

Informacje techniczne

Typ	M5	M6	M8	M10	M12
d	10	12	16	20	24
Głębokość wiercenia (min.)	45	50	65	80	90
L	35	40	50	60	70
T_{inst}	4	7	16	32	54
Wiertło \varnothing	10	12	16	20	24
Siła wyciągająca w kN					
Beton \geq C20/25	1.1	1.8	2.6	4.4	5.0

- **T_{inst}** = Moment obrotowy dokręcania w Nm.
- Dopuszczalne obciążenie pojedynczej kotwy dla śrub maszynowych odpowiedniej średnicy.
- Współczynnik bezpieczeństwa 5.

Kolejność montażu

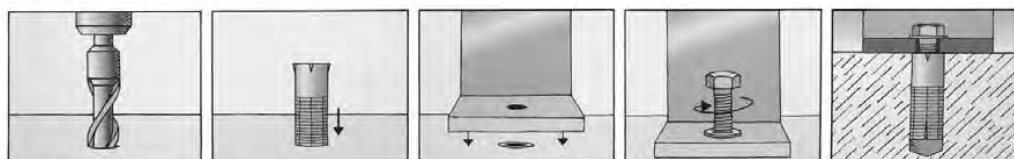

63400	FISCHER Kotwy rozporowe z mosiężnym stożkiem, typ M	N03B
Gwint	Metryczny	
Materiał	Tworzywo sztuczne wzmocnione włóknem szklanym	

Typ	☒	Kod artykułu	Typ	☒	Kod artykułu	Typ	☒	Kod artykułu
M5	50	63400.050.001	M8	20	63400.080.001	M12	5	63400.120.001
M6	50	63400.060.001	M10	10	63400.100.001			

Kotwy, typ PA

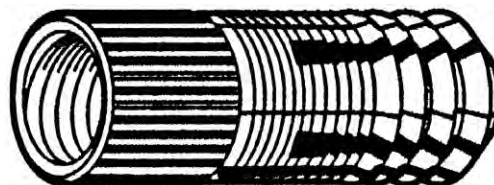
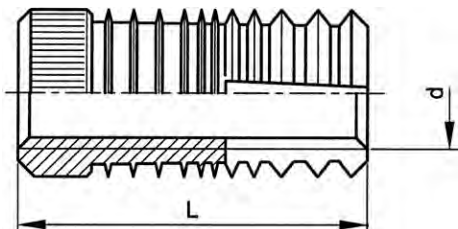

Informacje techniczne

Typ	PA 4 M6/7,5	PA 4 M6/13,5	PA 4 M8/25	PA 4 M10/25
d	M6	M6	M8	M10
Głębokość montażu (min.)	7.5	13.5	25.0	25.0
Głębokość wiercenia (min.)	7.5	13.5	25.0	25.0
L	7.5	13.5	25	25
P	1.00	1.00	1.25	1.50
Wiertło \varnothing	8	8	10	12
Wiertło \varnothing w konstrukcji	7.5	7.5	9.5	11.5
Dopuszczalne obciążenie w kN				
Cegła Mz12	-	0.80	1.95	2.30
Drewno bukowe	0.5	1.0	-	-
Plastik	0.75	2.00	-	-
Płyta włórowa	0.2	0.4	-	-
Sosna	0.18	0.38	-	-

- Długość śruby min. = długość zatyczki + grubość elementu mocowanego.
- Dopuszczalne obciążenie pojedynczej kotwy dla śrub maszynowych odpowiedniej średnicy..
- Współczynnik bezpieczeństwa 4.

Kolejność montażu

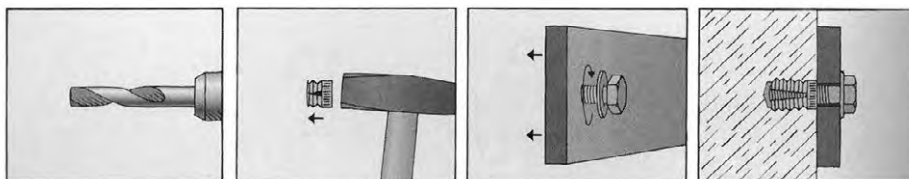

63410 FISCHER Kotwy, typ PA 4

N03A

Gwint Metryczny
Materiał Mosiądz

fischer
innovative solutions

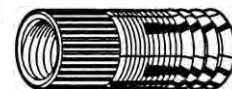

Typ	☒	Kod artykułu	Typ	☒	Kod artykułu	Typ	☒	Kod artykułu
PA4 M6X7,5	200	63410.060.007	PA4 M8X25	50	63410.080.025	PA4 M10X25	25	63410.100.025
PA4 M6X13,5	100	63410.060.013						

Kotwa tulejowa typ FSA-S

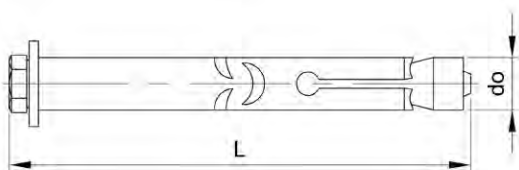

Informacje techniczne

Typ	FSA 8/15 S	FSA 8/40 S	FSA 8/65 S	FSA 10/10 S	FSA 10/35 S	FSA 10/60 S	FSA 12/10 S	FSA 12/25 S	FSA 12/50 S
d_o	8	8	8	10	10	10	12	12	12
h_{ef}	35	35	35	40	40	40	50	50	50
L	59	84	109	60	86	110	70	85	110
Min. t_d	65	90	115	65	90	115	75	90	115
t_{fix}	15	40	65	10	35	60	10	25	50

Dopuszczalne obciążenie w kN

Beton \geq C20/25	5.2	5.2	5.2	12.9	12.9	12.9	25.7	25.7	25.7
---------------------	-----	-----	-----	------	------	------	------	------	------

- d_o = Znamionowa średnica końcówki wiertła
- t_{fix} = Grubość armatury
- h_{ef} = Efektywna głębokość kotwienia
- Min. t_d = Zalecana głębokość wiercenia
- Dopuszczalne obciążenie jest ważne dla jednej kotwy, przy zarysowanym betonie (strefa rozciągania) z klasą betonu \geq C20/25.

Kolejność montażu

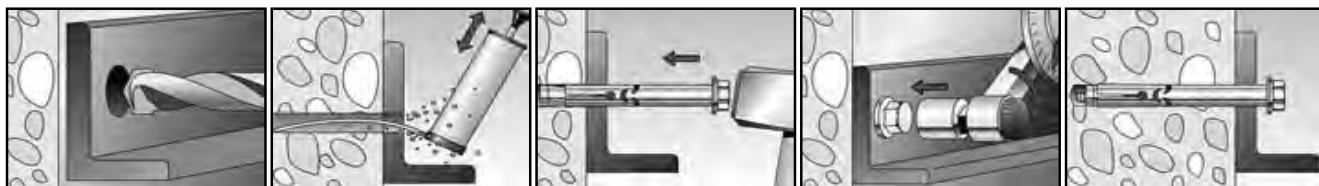

63226 FISCHER Kotwa tulejowa typ FSA-S

N03A

Gwint Metryczny
 Materiał Stal
 Obróbka powierzchni Ocynkowane

fischer
 innovative solutions



Typ	☒	Kod artykułu	Typ	☒	Kod artykułu	Typ	☒	Kod artykułu
FSA 8/15 S	50	63226.080.015	FSA 10/10 S	20	63226.100.010	FSA 12/10 S	20	63226.120.010
FSA 8/40 S	50	63226.080.040	FSA 10/35 S	20	63226.100.035	FSA 12/25 S	20	63226.120.025
FSA 8/65 S	50	63226.080.065	FSA 10/60 S	20	63226.100.060	FSA 12/50 S	20	63226.120.050

Nitonakrętki gumowe z mosięzną tuleją z gwintem

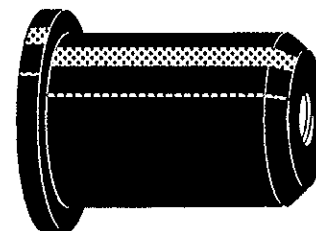
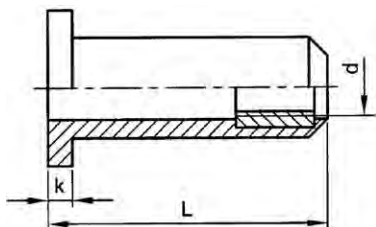

Informacje techniczne

d x L	k	Wiertło \varnothing	Zakres uchwytu (maks.)
M4x12.6	1.4	8	0 - 4
M4x24	1.4	8	6 - 14
M5x14	1.3	10	0 - 5
M5x25	1.3	10	8 - 16
M5x38	1.3	10	20 - 30
M6x15	1.3	13	0 - 3
M6x25	2	13	6 - 13
M6x35	1.3	13	11 - 23
M8x27.9	5	16	4 - 10
M8x30	1.2	18	6 - 15
M8x50	2	18	15 - 39
M10x55	1.3	20	20 - 36
M12x75	1.3	24	30 - 50

65421 RAWLNUT gumowe z mosięzną tuleją z gwintem

N61B

Gwint
Materiał

Metryczny
Guma

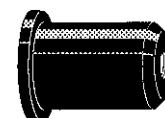

d x L	☒	Kod artykułu	d x L	☒	Kod artykułu	d x L	☒	Kod artykułu
M4X12,6	50	65421.040.011	M6X15	50	65421.060.015	M8X30	50	65421.080.031
M4X24	50	65421.040.024	M6X25	50	65421.060.025	M8X50	50	65421.080.050
M5X14	50	65421.050.014	M6X35	50	65421.060.035	M10X55	25	65421.100.055
M5X25	50	65421.050.025	M8X27,9	50	65421.080.030	M12X75	20	65421.120.075
M5X38	50	65421.050.038						

Kotwy do wbijania

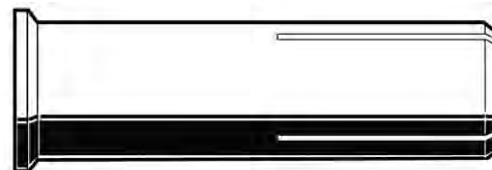
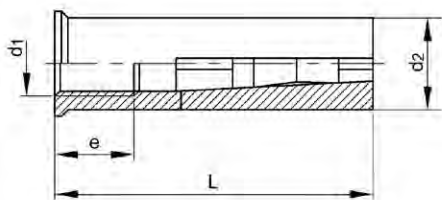

Informacje techniczne

d_1	M6	M8	M10	M12	M16	M20
$C_{min.}$	105	105	140	175	230	280
d_0	8	10	12	15	20	25
d_w	7	9	12	14	18	22
e (maks.)	10	13	17	21	27	34
e (min.)	6	8	10	12	16	20
h_1	27	33	43	54	70	86
h_c	100	100	100	100	130	160
L	25	30	40	50	65	80
N_{rec}	2.08	2.74	3.57	5.87	8.73	11.94
$S_{min.}$	60	90	80	100	130	160
T_{inst}	4	11	17	38	60	120

- d_1 = Znamionowa średnica końcówki wiertła
- d_0 = Średnica otworu w armaturze
- h_1 = Głębokość wierconego otworu do najgłębszego punktu
- h_c = Minimalna grubość podpory betonowej
- e = Długość gwintu śruby
- $S_{min.}$ = Minimalny odstęp
- $C_{min.}$ = Minimalna odległość krawędzi
- N_{rec} = Zalecane obciążenie w kN
- T_{inst} = Moment obrotowy dokręcania w Nm
- Dopuszczalne obciążenie (N_{rec}) jest ważne dla jednej kotwy, przy niepękniętym betonie (strefa nacisku) z klasą betonu C20/25, w tym częściowy współczynnik bezpieczeństwa $\gamma_f = 1,4$ i jeżeli $S_{min.}$ i $C_{min.}$ są wzięte pod uwagę.

Grupy katalogowe

Gwint	Materiał	Obróbka powierzchni	Kod	Strona
M	St	Ocynk.	30577	8-50
M	St	Ocynk. żłt. pas.	30575	8-50
M	St.St. A4		30576	8-51

30577 MAXXFAST Kotwy do wbijania DC-MAXX

MF5A

Gwint Metryczny
Materiał Stal
Obróbka powierzchni Ocynkowane

MAXXFAST
PROFESSIONAL HARDWARE



d_1	☒	Kod artykułu	d_1	☒	Kod artykułu	d_1	☒	Kod artykułu
M6	100	30577.060.001	M10	50	30577.100.001	M12 Diamond cut*	10	30577.120.002
M8	100	30577.080.001	M12	25	30577.120.001	M16	25	30577.160.001

*Do specjalnych maszyn do cięcia diamentowego.

30575 MAXXFAST Kotwy do wbijania D-MAXX

MF5A

Gwint Metryczny
Materiał Stal
Obróbka powierzchni Ocynkowane, po żółtej pasywacji

MAXXFAST
PROFESSIONAL HARDWARE



d_1	☒	Kod artykułu	d_1	☒	Kod artykułu	d_1	☒	Kod artykułu
M6	100	30575.060.001	M10	50	30575.100.001	M16	25	30575.160.001
M8	100	30575.080.001	M12	25	30575.120.001	M20	10	30575.200.001

30576 MAXXFAST Kotwy do wbijania D-MAXX		MF5A	
Gwint	Metryczny	MAXXFAST PROFESSIONAL HARDWARE	
Materiał	Stal nierdzewna A4		

d_1	☒	Kod artykułu	d_1	☒	Kod artykułu	d_1	☒	Kod artykułu
M6	100	30576.060.001	M10	50	30576.100.001	M16	25	30576.160.001
M8	100	30576.080.001	M12	25	30576.120.001	M20	10	30576.200.001

Kotwy do wbijania

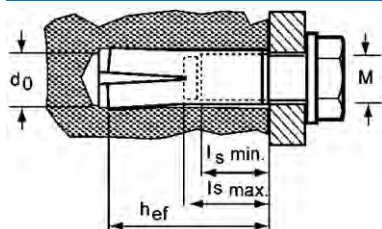

Informacje techniczne

Typ	d	d _o	h _{ef}	k _N	L	l _s (maks.)	l _s min.	t	T _{inst}
EA II M6	M6	8	30	4	30	13	6	32	4
EA II M8	M8	10	30	4	30	13	8	33	8
EA II M10	M10	12	40	6.1	40	17	10	43	15
EA II M12	M12	15	50	8.5	50	22	12	54	35
EA II M16	M16	20	65	12.6	65	28	16	70	60
EA II M20	M20	25	80	17.2	80	34	20	85	120

- d = Nominalna średnica wiertła.
- t = Zalecana głębokość wiercenia.
- L (h_{ef}) = Efektywna głębokość kotwienia.
- l_{s min.} = Głębokość wkręcania min.
- l_{s max.} = Głębokość wkręcania max.
- k_N = Nośność w kN w połączeniu ze śrubami klasy 8.8 & A4-70.
- T_{inst} = Moment obrotowy dokręcania w Nm.
- Instalować narzędziem typu EWA H (wąski koniec) w korpus kotwy (grupa artykułów 63322).
- Do m.in. sufitów powieszonych lekkich
- Więcej informacji technicznych dostępnych na żądanie.

Kolejność montażu

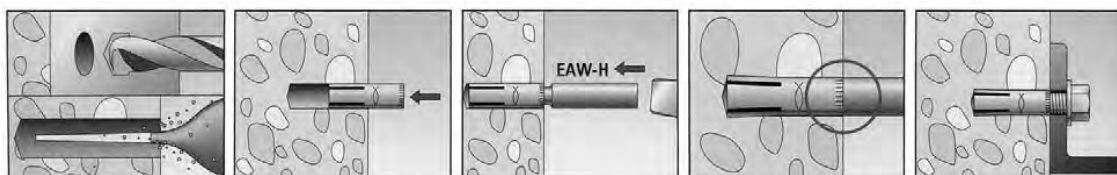

Grupy katalogowe

Gwint	Materiał	Obróbka powierzchni	Kod	Strona
M	St	Ocyнк.	63320	8-52
M	St.St. A4		63321	8-52

63320	FISCHER Kotwy typ EA II	N03A
Gwint	Metryczny	
Materiał	Stal	
Obróbka powierzchni	Ocynkowane	



Końcowe obliczenia powinny być zgodne z pełnym Europejskim Zatwierdzeniem Technicznym (ETA),
zatwierdzenie to jest również dostępne na żądanie.

Typ	✉	Kod artykułu	Typ	✉	Kod artykułu	Typ	✉	Kod artykułu
EA II M6 (EV)	100	63320.060.001	EA II M12 (EV)	25	63320.120.001	EA II M16 (EV)	20	63320.160.001
EA II M8 (EV)	100	63320.080.001	EA II M12 D (EV)	25	63320.120.005	EA II M20 (EV)	10	63320.200.001
EA II M10 (EV)	50	63320.100.001						

63321	FISCHER Kotwy typ EA II	N03A
Gwint	Metryczny	
Materiał	Stal nierdzewna A4	



Końcowe obliczenia powinny być zgodne z pełnym Europejskim Zatwierdzeniem Technicznym (ETA),
zatwierdzenie to jest również dostępne na żądanie.

Typ	✉	Kod artykułu	Typ	✉	Kod artykułu	Typ	✉	Kod artykułu
EA II M6 A4	100	63321.060.001	EA II M10 A4	50	63321.100.001	EA II M16 A4	20	63321.160.001
EA II M8 A4	100	63321.080.001	EA II M12 A4	25	63321.120.001	EA II M20 A4	20	63321.200.001

Narzędzia do osadzania

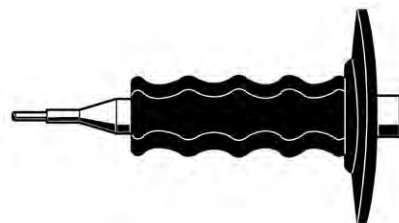

Grupy katalogowe

Material	Obróbka powierzchni	Kod	Strona
St		30579	8-53
St	Ocynk.	63322	8-53

30579 MAXXFAST Narzędzia do osadzania MF5A

Material	Stal		

Wymiary	⊗	Kod artykułu	Wymiary	⊗	Kod artykułu	Wymiary	⊗	Kod artykułu
M6	1	30579.060.001	M10	1	30579.100.001	M16	1	30579.160.001
M8	1	30579.080.001	M12	1	30579.120.001	M20	1	30579.200.001



63322 FISCHER Narzędzia do osadzania N03A

Material	Stal		
Obróbka powierzchni	Ocynkowane		

Typ	⊗	Kod artykułu	Typ	⊗	Kod artykułu	Typ	⊗	Kod artykułu
EAW H 6 PLUS	1	63322.060.001	EAW H 10 PLUS	1	63322.100.001	EAW H 16 PLUS	1	63322.160.001
EAW H 8 PLUS	1	63322.080.001	EAW H 12 PLUS	1	63322.120.001	EAW H 20 PLUS	1	63322.200.001

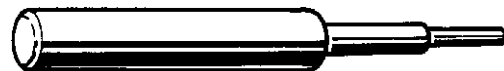
Narzędzia instalacyjne do wbijania kotew rozporowych SA



70967	SPIT Narzędzia instalacyjne do wbijania kotew rozporowych	P03C
Materiał	Stal	 

Typ	☒	Kod artykułu	Typ	☒	Kod artykułu	Typ	☒	Kod artykułu
S 6	1	70967.000.006	S 10	1	70967.000.010	S 12	1	70967.000.012
S 8	1	70967.000.008						

Kotwa do płyt kanałowych typ FHY

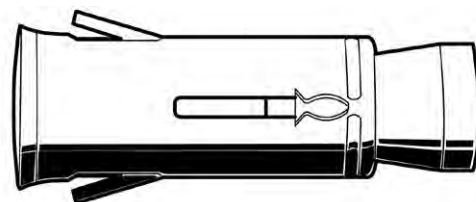
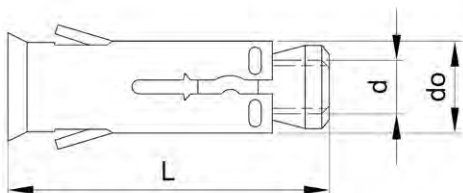





Informacje techniczne

Typ / d	FHY M6	FHY M8	FHY M10
d_o	10	12	16
Grubość części strukturalnej (min.)	40	40	40
h_{ef}	30	35	40
L	37	43	52
Min. t_d	50	60	65
T_{inst}	10	10	20
Dopuszczalne obciążenie w kN			
Beton \geq C45/55	2	2	3

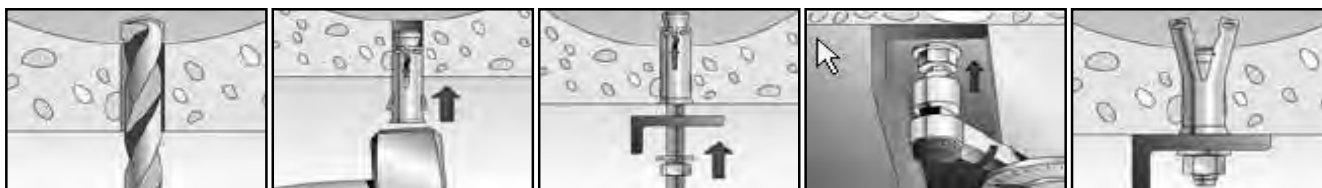
- d_o = Znamionowa średnica końcówki wiertła.
- Min. t_d = Zalecana głębokość wiercenia.
- h_{ef} = Efektywna głębokość kotwienia.
- T_{inst} = moment dokręcania w Nm. (screws for class 5.8 or A4-70).
- Dopuszczalne obciążenie dla pojedynczej kotwy w betonie sprężonym, płyty kanałowe.
- Dokładne dane dla naprężeń, momentów gnących, itp - patrz aproba techniczna.

Kolejność montażu



63428	FISCHER Kotwa do płyt kanałowych typ FHY	N03A
Gwint	Metryczny	
Materiał	Stal	
Obróbka powierzchni	Ocynkowane	

Typ / d	☒	Kod artykułu	Typ / d	☒	Kod artykułu	Typ / d	☒	Kod artykułu
FHY M6	50	63428.060.001	FHY M8	25	63428.080.001	FHY M10	20	63428.100.001

Kotwienie śrubowy łeb stożkowy płaski

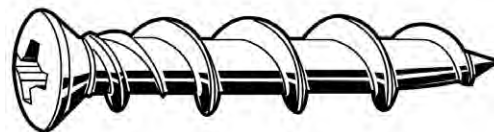
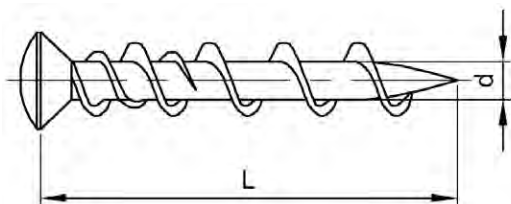

Informacje techniczne

d x L	d _o	h _o	L	Nr Torx®	Nr wgłębienia krzyżowego	N _{rec}	t _{fix}
5x32	5	35	32	-	2	0.3	3
5x50	5	35	50	25	-	0.3	21
5x70	5	35	70	25	-	0.3	41

- d = Znamionowa średnica końcówki wiertła.
- h_o = Głębokość wiercenia.
- N_{rec} = Zalecane obciążenie w kN w betonie.
- t_{fix} = Grubość armatury.

Grupy katalogowe

Gniazdo	Materiał	Obróbka powierzchni	Kod	Strona
Phillips	St	Ocynk.	70527	8-55
Phillips	St	Ocynk.	Łeb biały probablybest	8-55
Torx®	St	Ocynk.	70529	8-55

70527 Kotwy śrubowe łeb stożkowy płaski Phillips, typu WALLDOG

P05A

Materiał Stal
Obróbka powierzchni Ocynkowane



d x L **Kod artykułu**
5X32MM 100 [70527.050.032](#)

- Tylko pełne opakowania.

70528 Kotwy śrubowe łeb stożkowy płaski Phillips, typu WALLDOG white head

P05A

Materiał Stal
Obróbka powierzchni Ocynkowane



d x L **Kod artykułu**
5X32MM 100 [70528.050.032](#)

- Tylko pełne opakowania.

70529 Kotwy śrubowe łeb stożkowy płaski Torx®, typu WALLDOG

P05A

Materiał Stal
Obróbka powierzchni Ocynkowane



d x L **Kod artykułu** **d x L** **Kod artykułu**
5X50MM 100 [70529.050.050](#) 5X70MM 100 [70529.050.070](#)

- Tylko pełne opakowania.

Kotwy śrubowe łeb okrągły

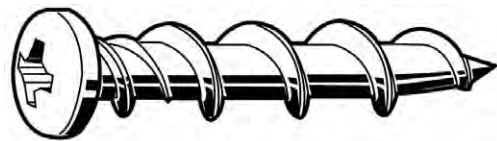
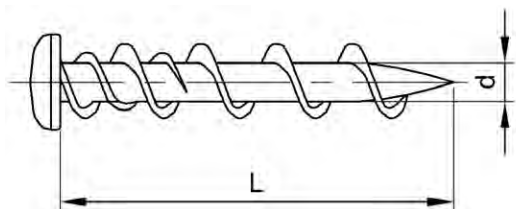

Informacje techniczne

d x L	d	L	Nr Torx®	Nr wgłębienia krzyżowego	N _{rec}	f _{fix}
5x32	5	32	-	2	0.3	3
5x50	5	50	25	-	0.3	21
5x70	5	70	25	-	0.3	41

- N_{rec} = Zalecane obciążenie w kN
- f_{fix} = Grubość armatury

Grupy katalogowe

Gniazdo	Materiał	Obróbka powierzchni	Kod	Strona
Phillips	St	Ocynk.	70530	8-56
Phillips	St	Ocynk.	Łeb biały probablybest 70531	8-56
Torx®	St	Ocynk.	70532	8-56

70530 Kotwy śrubowe łeb okrągły Phillips, typu WALLDOG

P05A

Materiał Stal
Obróbka powierzchni Ocynkowane



d x L Kod artykułu
5X32MM 100 [70530.050.032](#)

- Tylko pełne opakowania.

70531 Kotwy śrubowe łeb okrągły Phillips, typu WALLDOG white head

P05A

Materiał Stal
Obróbka powierzchni Ocynkowane



d x L Kod artykułu
5X32MM 100 [70531.050.032](#)

- Tylko pełne opakowania.

70532 Kotwy śrubowe łeb okrągły Torx® typu WALLDOG

P05A

Materiał Stal
Obróbka powierzchni Ocynkowane



d x L Kod artykułu d x L Kod artykułu
5X50MM 100 [70532.050.050](#) 5X70MM 100 [70532.050.070](#)

- Tylko pełne opakowania.

Kotwy śrubowe łeb sześciokątny, typu TAPH

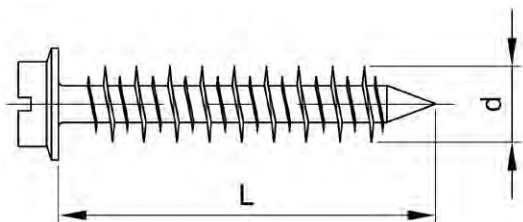

Informacje techniczne

d x L	d _o	L	N _{rec}	s	t _{fix}
4.8x32	4.0	32	0.5	1/4	7
4.8x45	4.0	45	0.5	1/4	20
4.8x57	4.0	57	0.5	1/4	32
6.3x32	4.8	32	0.5	5/16-8MM	7
6.3x45	4.8	45	0.5	5/16-8MM	20
6.3x57	4.8	57	0.5	5/16-8MM	32
6.3x70	4.8	70	0.5	5/16-8MM	45
6.3x82	4.8	82	0.5	5/16-8MM	57

- d_o = Znamionowa średnica końcówki wiertła.
- h_o = Głębokość wiercenia.
- N_{rec} = Zalecane obciążenie w kN w betonie.
- t_{rec} = Grubość armatury.
- s = Szerokością powierzchni.

70525 Kotwy śrubowe łeb sześciokątny, typu TAPH

P05A

Materiał Stal
Obróbka powierzchni Perma-Seal



d x L	☒	Kod artykułu	d x L	☒	Kod artykułu	d x L	☒	Kod artykułu
4,8X32MM	100	70525.048.032	6,3X32MM	100	70525.063.032	6,3X57MM	100	70525.063.057
4,8X45MM	100	70525.048.045	6,3X45MM	100	70525.063.045	6,3X70MM	100	70525.063.070
4,8X57MM	100	70525.048.057				6,3X82MM	100	70525.063.082

Kotwy śrubowe łeb stożkowy płaski, typu TAPC

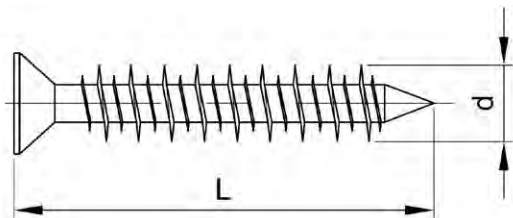

Informacje techniczne

d x L	d _o	L	Nr wgłębienia krzyżowego	N _{rec}	t _{fix}
4.8x32	4.0	32	2	0.5	7
4.8x45	4.0	45	2	0.5	20
4.8x57	4.0	57	2	0.5	32
4.8x70	4.0	70	2	0.5	45
4.8x82	4.0	82	2	0.5	57
4.8x100	4.0	100	2	0.5	75
6.3x32	4.8	32	3	0.5	7
6.3x45	4.8	45	3	0.5	20
6.3x57	4.8	57	3	0.5	32
6.3x70	4.8	70	3	0.5	45
6.3x82	4.8	82	3	0.5	57
6.3x100	4.8	100	3	0.5	75
6.3x125	4.8	125	3	0.5	100

- d_o = Znamionowa średnica końcówki wiertła.
- N_{rec} = Zalecane obciążenie w kN.
- t_{fix} = Grubość armatury.

70526 Kotwy śrubowe łeb stożkowy płaski, typu TAPC

P05A

Materiał Stal
Obróbka powierzchni Perma-Seal



d x L	☒	Kod artykułu	d x L	☒	Kod artykułu	d x L	☒	Kod artykułu
4,8X32MM	100	70526.048.032	4,8X100MM	100	70526.048.100	6,3X70MM	100	70526.063.070
4,8X45MM	100	70526.048.045	6,3X32MM	100	70526.063.032	6,3X82MM	100	70526.063.082
4,8X57MM	100	70526.048.057	6,3X45MM	100	70526.063.045	6,3X100MM	100	70526.063.100
4,8X82MM	100	70526.048.082	6,3X57MM	100	70526.063.057	6,3X125MM	100	70526.063.125

Wkręt kotwiący łeb sześciokątny, typu BT

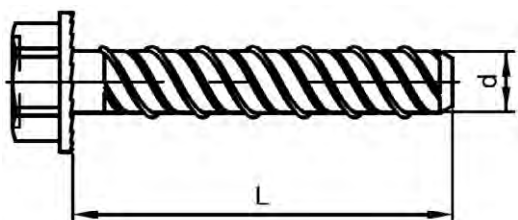

Informacje techniczne

Typ	d	L	N _{rec}	s	t _{fix}
BT550	5	50	1.5	7	15
BT650	6	50	1.5	10	15
BT680	6	80	1.9	10	35
BT6100	6	100	1.9	10	55
BT6120	6	120	1.9	10	75
BT6140	6	140	1.9	10	95
BT850	8	50	1.9	13	5
BT875	8	75	3.3	13	10
BT8100	8	100	3.3	13	35
BT1060	10	60	2.6	17	5
BT1075	10	75	2.6	17	20
BT10100	10	100	2.6/4.1	17	45/25
BT10110	10	110	2.6/4.1	17	55/35
BT10120	10	120	2.6/4.1	17	65/45
BT10140	10	140	2.6/4.1	17	85/65
BT10160	10	160	2.6/4.1	17	105/85
BT10200	10	200	2.6/4.1	17	145/125
BT10240	10	240	2.6/4.1	17	185/165
BT10280	10	280	2.6/4.1	17	225/205
BT10320	10	320	2.6/4.1	17	265/245
BT1275	12	75	4.1	19	5
BT12100	12	100	4.1/5.4	19	30/15
BT12150	12	150	4.1/5.4	19	80/65
BT12200	12	200	4.1/5.4	19	130/115
BT16100	16	100	6.3	23	20
BT16150	16	150	6.3/9.9	23	70/40
BT16200	16	200	6.3/9.9	23	120/90
BT16240	16	240	6.3/9.9	23	160/130
BT16280	16	280	6.3/9.9	23	200/170
BT16320	16	320	6.3/9.9	23	240/120

- d = Znamionowa średnica końcówki wiertła.
- N_{rec} = Zalecane obciążenie w kN.
- s = Szerokością powierzchni.
- t_{fix} = Grubość armatury.

70520 Wkręt kotwiący łeb sześciokątny, typu BT

P05A

Materiał Stal
Obróbka powierzchni O cynkowane

Powers
FASTENING INNOVATIONS



Końcowe obliczenia powinny być zgodne z pełnym Europejskim Zatwierdzeniem Technicznym (ETA),
zatwierdzenie to jest również dostępne na żądanie.

d x L	☒	Kod artykułu	d x L	☒	Kod artykułu	d x L	☒	Kod artykułu
BT 5X50	100	70520.050.050	BT 8X50	50	70520.080.050	BT 10X100	50	70520.100.100
BT 6X50	100	70520.060.050	BT 8X75	50	70520.080.075	BT 10X110	25	70520.100.110
BT 6X80	50	70520.060.080	BT 8X100	50	70520.080.100	BT 10X120	25	70520.100.120
BT 6X100	100	70520.060.100	BT 10X60	50	70520.100.060	BT 10X140	25	70520.100.140
BT 6X120	100	70520.060.120	BT 10X75	50	70520.100.075	BT 10X160	20	70520.100.160
BT 6X140	50	70520.060.140						

70520 Wkręt kotwiący łeb sześciokątny, typu BT

d x L	☒	Kod artykułu	d x L	☒	Kod artykułu	d x L	☒	Kod artykułu
BT 10X200	20	70520.100.200	BT 12X150	20	70520.120.150	BT 16X240	10	70520.160.240
BT 10X240	20	70520.100.240	BT 12X200	20	70520.120.200	BT 16X280	10	70520.160.280
BT 10X280	20	70520.100.280	BT 16X100	20	70520.160.100	BT 16X320	10	70520.160.320
BT 12X75	25	70520.120.075	BT 16X150	10	70520.160.150			
BT 12X100	25	70520.120.100	BT 16X200	10	70520.160.200			

• ETA1=BT10/BT12/BT16

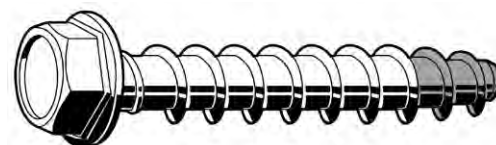
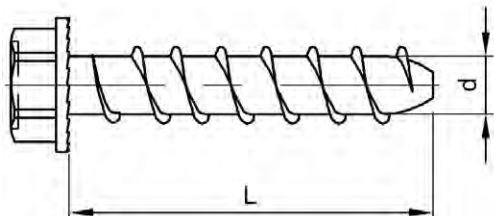
Wkręt kotwiący A4 łeb sześciokątny, typu BT

Informacje techniczne

Typ	d	L	N _{rec}	s	t _{fix}
BT645	6	45	1.7	10	1
BT660	6	60	2	10	5
BT875	8	75	2.3	13	10
BT895	8	95	2.3	13	30
BT1085	10	85	4.1	17	5
BT10100	10	100	4.1	17	20

- d = Znamionowa średnica końcówki wiertła.
- N_{rec} = Zalecane obciążenie w kN dla nie spękanego betonu.
- s = Szerokość powierzchni.
- t_{fix} = Grubość armatury.

70521 Wkręt kotwiący A4 łeb sześciokątny, typu BT
P05A
Materiał Stal nierdzewna A4

d x L	☒	Kod artykułu	d x L	☒	Kod artykułu	d x L	☒	Kod artykułu
6X45MM	100	70521.060.045	8/10X75MM	50	70521.080.075	10/5X85MM	50	70521.100.085
6/5X60MM	100	70521.060.060	8/30X95MM	50	70521.080.095	10/20X100MM	50	70521.100.100

Wkręt kotwiący łeb okrągły, typu BT

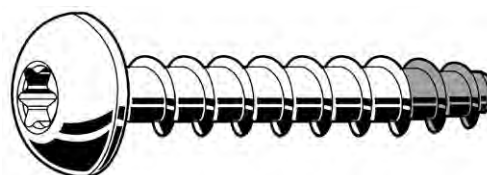
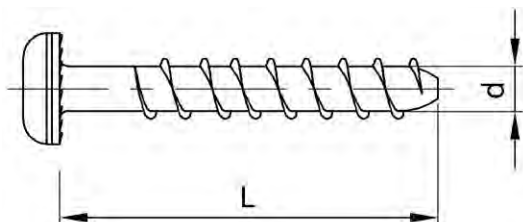

Informacje techniczne

Typ	L	Nr Torx®	N _{rec}	t _{fix}
BT645	45	40	1.5	10
BT650	50	40	1.5	15

- d = Znamionowa średnica końcówki wiertła.
- N_{rec} = Zalecane obciążenie w kN.
- t_{fix} = Grubość armatury.

70522 Wkręt kotwiący łeb okrągły, typu BT

P05A

Materiał Stal
Obróbka powierzchni O cynkowane



d x L	Kod artykułu	d x L	Kod artykułu
6X45MM	100 70522.060.045	6X50MM	100 70522.060.050

Wkręt kotwiący łeb grzybkowy, typu BT

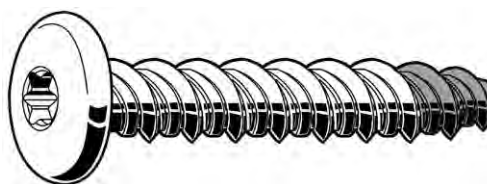
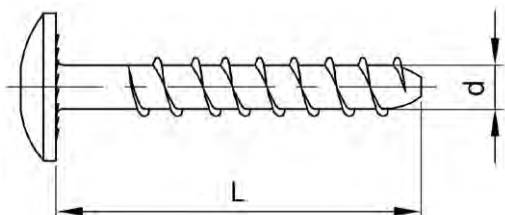

Informacje techniczne

Typ	d	L	Nr Torx®	N _{rec}	t _{fix}
BT640	6	40	30	1.2	10
BT650	6	50	30	1.5	15
BT665	6	65	30	1.9	20

- N_{rec} = Zalecane obciążenie w kN dla nie spękanego betonu.
- t_{fix} = Grubość armatury

70523 Wkręt kotwiący łeb grzybkowy, typu BT

P05A

Materiał Stal
Obróbka powierzchni O cynkowane



d x L	Kod artykułu	d x L	Kod artykułu	d x L	Kod artykułu
6X40MM	100 70523.060.040	6X50MM	100 70523.060.050	6X65MM	100 70523.060.065

Wkręt kotwiący łeb stożkowy płaski, typu BT

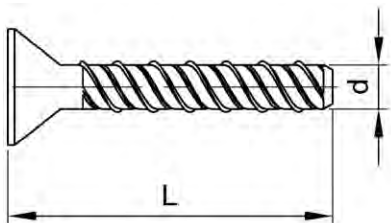

Informacje techniczne

Typ	d	L	Nasadka	N_{rec}	s	t_{fix}
BT650	6	50	T40	1.5	-	15
BT675	6	75	T40	1.5	-	40
BT850	8	50	T40	1.9	-	5
BT875	8	75	-	3.3	6	10
BT8100	8	100	-	3.3	6	35
BT1060	10	60	-	2.6	6	5
BT1075	10	75	-	2.6	8	20
BT10100	10	100	-	2.6/4.1	8	45/25
BT1275	12	75	-	4.1	10	5
BT12100	12	100	-	4.1/5.4	10	30/15
BT12150	12	150	-	4.1/5.4	10	80/65

- d = Znamionowa średnica końcówki wiertła.
- N_{rec} = Zalecane obciążenie w kN dla nie spękanego betonu.
- s = Szerokość powierzchni.
- t_{fix} = Grubość armatury.

70524 Wkręt kotwiący łeb stożkowy płaski, typu BT

P05A

Materiał Stal
Obróbka powierzchni O cynkowane



Końcowe obliczenia powinny być zgodne z pełnym Europejskim Zatwierdzeniem Technicznym (ETA),
zatwierdzenie to jest również dostępne na żądanie.

d x L	☒	Kod artykułu	d x L	☒	Kod artykułu	d x L	☒	Kod artykułu
6X50MM	100	70524.060.050	8X100MM	50	70524.080.100	12X75MM	25	70524.120.075
6X75MM	50	70524.060.075	10X60MM	50	70524.100.060	12X100MM	25	70524.120.100
8X50MM	50	70524.080.050	10X75MM	50	70524.100.075	12X150MM	20	70524.120.150
8X75MM	50	70524.080.075	10X100MM	50	70524.100.100			

- ETA1=BT10/BT12

Kotwy budowlane ThruFast - ThruMaxx

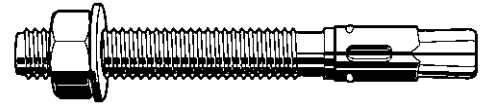
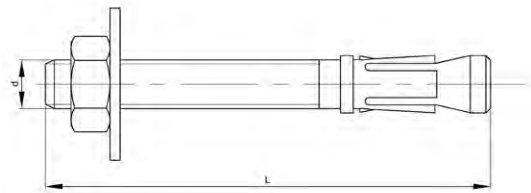

Informacje techniczne

Typ	C _{cr} N	d	d _f	d _o	h (nom.)	h ₁	h _{ef}	L	N _{rec}	s	S _{cr} N	t _{fix} (maks.)	T _{inst}	ø podkładki
6x60	60	M6	7	6	49.5	55	40	60	4.29	10	120	2	7	12
6x70	60	M6	7	6	49.5	55	40	70	3.93	10	120	12	7	12
6x80	60	M6	7	6	49.5	55	40	80	3.93	10	120	22	7	12
6x80 (A2-A4)	60	M6	7	6	49.5	55	40	80	4.29	10	120	22	7	12
6x90	60	M6	7	6	49.5	55	40	90	3.93	10	120	32	7	12
6x100	60	M6	7	6	49.5	55	40	100	3.93	10	120	42	7	12
6x120	60	M6	7	6	49.5	55	40	120	3.93	10	120	62	7	12
6x140	60	M6	7	6	49.5	55	40	140	3.93	10	120	82	7	12
8x75	72	M8	9	8	59.5	65	48	75	5.71	13	144	5	20	16
8x90	72	M8	9	8	59.5	65	48	90	5.71	13	144	20	20	16
8x115	72	M8	9	8	59.5	65	48	115	5.71	13	144	45	20	16
8x130	72	M8	9	8	59.5	65	48	130	5.71	13	144	60	20	16
8x155	72	M8	9	8	59.5	65	48	155	5.71	13	144	85	20	16
10x70	83	M10	12	10	53.5	60	42	70	5.43	17	165	5	35	20
10x90	83	M10	12	10	66.5	75	55	90	6.35	17	165	10	35	20
10x120	83	M10	12	10	66.5	75	55	120	6.35	17	165	40	35	20
10x150	83	M10	12	10	66.5	75	55	150	6.35	17	165	70	35	20
10x170	83	M10	12	10	66.5	75	55	170	6.35	17	165	90	35	20
12x75	98	M12	14	12	55	60	43	75	5.64	19	195	5	60	24
12x90	98	M12	14	12	77	85	65	90	8.84	19	195	5	60	24
12x110	98	M12	14	12	77	85	65	110	9.92	19	195	18	60	24
12x140	98	M12	14	12	77	85	65	140	9.92	19	195	48	60	24
12x160	98	M12	14	12	77	85	65	160	9.92	19	195	68	60	24
12x180	98	M12	14	12	77	85	65	180	9.92	19	195	88	60	24
14x120	113	M14	16	14	91	100	75	120	11.91	22	225	12	90	28
14x145	113	M14	16	14	91	100	75	145	11.91	22	225	37	90	28
14x170	113	M14	16	14	91	100	75	170	11.91	22	225	62	90	28
16x90	126	M16	18	16	69	75	49	90	6.86	24	252	4	120	30
16x125	126	M16	18	16	103.5	110	84	125	13.89	24	252	3	120	30
16x145	126	M16	18	16	103.5	110	84	145	13.89	24	252	23	120	30
16x170	126	M16	18	16	103.5	110	84	170	13.89	24	252	48	120	30
16x220	126	M16	18	16	103.5	110	84	220	13.89	24	252	98	120	30
20x120	155	M20	22	20	93	105	71	120	11.96	30	309	5	240	37
20x170	155	M20	22	20	125	135	103	170	19.84	30	309	23	240	37
20x220	155	M20	22	20	125	135	103	220	19.84	30	309	73	240	37

- d = Znamionowa średnica końcówki wiertła
- s = Szerokością powierzchni
- ring ø = Średnica pierścienia
- d_f = Średnica otworu w armaturze
- h₁ = Zalecana głębokość wiercenia
- h(nom) = Minimalna głębokość wiercenia
- h_{ef} = Efektywna głębokość kotwienia
- S_{cr}N = Odstęp
- C_{cr}N = Odległość krawędzi
- t_{fix}(max) = Grubość armatury
- T_{inst} = Moment obrotowy dokręcania w Nm
- N_{rec} = Zalecane obciążenie w kN
- Dopuszczalne obciążenie jest ważne dla jednej kotwy, przy niepekniętym betonie (strefa nacisku) z klasą betonu C20/25, w tym częściowy współczynnik bezpieczeństwa γ_r= 1,4 i jeżeli S_{cr} N i C_{cr} N są wzięte pod uwagę.

Kolejność montażu



Grupy katalogowe

Gwint	Materiał	Obróbka powierzchni	Kod	Strona
M	St	Ocynk.	30550	8-64
M	St.St. A2		30552	8-64
M	St	Ocynk.	ETA-7	8-64
M	St.St. A4		ETA-7	8-65

30550 MAXXFAST Kotwy budowlane ThruFast MF50

Gwint: Metryczny
 Materiał: Stal
 Obróbka powierzchni: Ocynkowane

MAXXFAST
PROFESSIONAL HARDWARE

Typ	☒	Kod artykułu	Typ	☒	Kod artykułu	Typ	☒	Kod artykułu
6X70	200	30550.060.070	8X155	50	30550.080.155	12X180	25	30550.120.180
6X80	200	30550.060.080	10X70	100	30550.100.070	14X120	25	30550.140.120
6X90	200	30550.060.090	10X90	100	30550.100.090	14X145	25	30550.140.145
6X100	200	30550.060.100	10X120	50	30550.100.120	14X170	20	30550.140.170
6X120	100	30550.060.120	10X150	50	30550.100.150	16X125	25	30550.160.125
6X140	100	30550.060.140	12X75	50	30550.120.075	16X145	25	30550.160.145
8X75	100	30550.080.075	12X110	50	30550.120.110	16X170	10	30550.160.170
8X90	100	30550.080.090	12X140	25	30550.120.140	16X220	10	30550.160.220
8X115	100	30550.080.115	12X160	25	30550.120.160	20X170	10	30550.200.170
8X130	100	30550.080.130						

• Tylko pełne opakowania.

30552 MAXXFAST Kotwy budowlane ThruFast MF50

Gwint: Metryczny
 Materiał: Stal nierdzewna A2

MAXXFAST
PROFESSIONAL HARDWARE



Typ	☒	Kod artykułu	Typ	☒	Kod artykułu	Typ	☒	Kod artykułu
6X60	200	30552.060.060	10X120	50	30552.100.120	16X145	25	30552.160.145
6X80	200	30552.060.080	10X150	50	30552.100.150	16X170	10	30552.160.170
8X75	100	30552.080.075	12X90	50	30552.120.090	20X120	10	30552.200.120
8X90	100	30552.080.090	12X110	50	30552.120.110	20X170	10	30552.200.170
8X115	100	30552.080.115	12X140	25	30552.120.140	20X220	10	30552.200.220
10X90	100	30552.100.090	16X90	25	30552.160.090			

• Tylko pełne opakowania.

30551 MAXXFAST Kotwy budowlane ThruFast MF50

Gwint: Metryczny
 Materiał: Stal
 Obróbka powierzchni: Ocynkowane

MAXXFAST
PROFESSIONAL HARDWARE





Końcowe obliczenia powinny być zgodne z pełnym Europejskim Zatwierdzeniem Technicznym (ETA),
 zatwierdzenie to jest również dostępne na żądanie.

Typ	☒	Kod artykułu	Typ	☒	Kod artykułu	Typ	☒	Kod artykułu
6X70	200	30551.060.070	8X130	100	30551.080.130	12X180	25	30551.120.180
6X80	200	30551.060.080	8X155	50	30551.080.155	14X120	25	30551.140.120
6X90	200	30551.060.090	10X90	100	30551.100.090	14X145	25	30551.140.145
6X100	200	30551.060.100	10X120	50	30551.100.120	14X170	20	30551.140.170
6X120	100	30551.060.120	10X150	50	30551.100.150	16X125	25	30551.160.125
6X140	100	30551.060.140	10X170	50	30551.100.170	16X145	25	30551.160.145
8X75	100	30551.080.075	12X110	50	30551.120.110	16X170	10	30551.160.170
8X90	100	30551.080.090	12X140	25	30551.120.140	20X170	10	30551.200.170
8X115	100	30551.080.115	12X160	25	30551.120.160			

• Tylko pełne opakowania.

30553	MAXXFAST Kotwy budowlane ThruFast	MF50
Gwint	Metryczny	
Materiał	Stal nierdzewna A4	



Końcowe obliczenia powinny być zgodne z pełnym Europejskim Zatwierdzeniem Technicznym (ETA), zatwierdzenie to jest również dostępne na żądanie.

Typ	☒	Kod artykułu	Typ	☒	Kod artykułu	Typ	☒	Kod artykułu
6X60	200	30553.060.060	10X90	100	30553.100.090	12X140	25	30553.120.140
6X80	200	30553.060.080	10X120	50	30553.100.120	16X145	25	30553.160.145
8X75	100	30553.080.075	10X150	50	30553.100.150	16X170	10	30553.160.170
8X90	100	30553.080.090	12X90	50	30553.120.090	20X170	10	30553.200.170
8X115	100	30553.080.115	12X110	50	30553.120.110	20X220	10	30553.200.220

• Tylko pełne opakowania.

Kotwa EXA

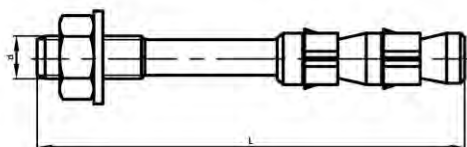

Informacje techniczne

d	d	d _o	h _{ef}	k _N	L	Min. t _d	s	t _{fix}
8/5	M8	8	47	4.1	60	60	13	5
8/15	M8	8	47	4.1	65	60	13	15
10/5	M10	10	49	6.3	70	65	17	5
10/15	M10	10	49	6.3	92	65	17	15
10/45	M10	10	49	6.3	122	65	17	45
12/5	M12	12	67	9.9	80	85	19	5
12/15	M12	12	67	9.9	116	85	19	15
12/55	M12	12	67	9.9	156	85	19	55
16/10	M16	16	85	16.7	110	110	24	10
16/30	M16	16	85	16.7	153	110	24	30

- **d** = Znamionowa średnica końcówki wiertła.
- **Min. td** = Zalecana głębokość wiercenia.
- **h_{ef}** = Efektywna głębokość kotwienia.
- **t_{ef}** = Grubość armatury.
- **k_N** = Zakładanym obciążeniem jest k_N, beton niespękany.
- Dopuszczalne obciążenie obowiązuje dla pojedynczej kotwy, dla betonu spękanego (strefa rozciągana) w klasie C20/25 włączając częściowo współczynnik bezpieczeństwa γ_f = 1,4 oraz gdy SCR, N i Ccr nie są przekroczone.
- Do ostatecznych kalkulacji niezbędne jest wzięcie pod uwagę pełnej aprobaty European Technical Approval (ETA), która jest dostępna na żądanie.

Kolejność montażu

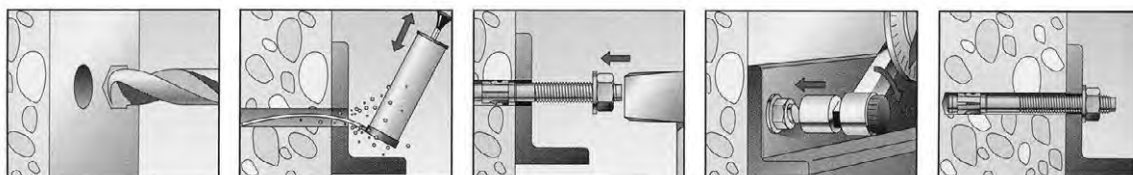

Materiał Stal
Obróbka powierzchni Ocynkowane

fischer
 innovative solutions



Typ	☒	Kod artykułu	Typ	☒	Kod artykułu	Typ	☒	Kod artykułu
8/5 (8X60)	50	63328.008.005	10/45 (10X122)	50	63328.010.045	12/55 (12X156)	25	63328.012.055
8/15 (8X65)	50	63328.008.015	12/5 (12X80)	25	63328.012.005	16/10 (16X110)	20	63328.016.010
10/5 (10X70)	50	63328.010.005	12/15 (12X116)	25	63328.012.015	16/30 (16X153)	10	63328.016.030
10/15 (10X92)	50	63328.010.015						

Kotwy, typ FBN

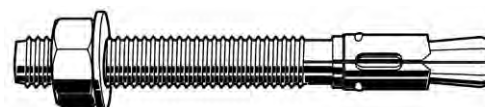
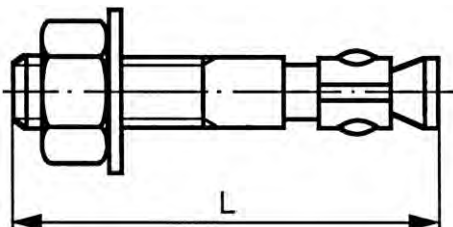

Informacje techniczne

Typ	d	d _o	h _{ef}	k _N	L	Min. t _d	t _{fix}	ø podkładki
FBN II 6/5	M6	6	30	1.5	50	45	5	12X1.6
FBN II 6/10	M6	6	30	1.5	55	50	10	12X1.6
FBN II 6/30	M6	6	30	1.5	75	70	30	12X1.6
FBN II 8/5	M8	8	40	2.9-6.1	66	61	5	16X1.6
FBN II 8/10	M8	8	40	2.9-6.1	71	66	10	16X1.6
FBN II 8/20	M8	8	40	2.9-6.1	81	76	20	16X1.6
FBN II 8/30	M8	8	40	2.9-6.1	91	86	30	16X1.6
FBN II 8/50	M8	8	40	2.9-6.1	111	106	50	16X1.6
FBN II 8/70	M8	8	40	2.9-6.1	131	126	70	16X1.6
FBN II 8/100	M8	8	40	2.9-6.1	161	156	100	16X1.6
FBN II 8/5 K	M8	8	30	2.9-6.1	56	51	5	16X1.6
FBN II 8/10 K	M8	8	30	2.9-6.1	61	56	10	16X1.6
FBN II 8/30 K	M8	8	30	2.9-6.1	81	76	30	16X1.6
FBN II 10/10	M10	10	50	6.1-8.5	86	78	10	20X2
FBN II 10/20	M10	10	50	6.1-8.5	96	88	20	20X2
FBN II 10/30	M10	10	50	6.1-8.5	106	98	30	20X2
FBN II 10/50	M10	10	50	6.1-8.5	126	118	50	20X2
FBN II 10/70	M10	10	50	6.1-8.5	146	138	70	20X2
FBN II 10/100	M10	10	50	6.1-8.5	176	168	100	20X2
FBN II 10/140	M10	10	50	6.1-8.5	216	208	140	20X2
FBN II 10/160	M10	10	50	6.1-8.5	236	228	160	20X2
FBN II 10/5 K	M10	10	40	6.1-8.5	71	63	5	20X2
FBN II 10/10 K	M10	10	40	6.1-8.5	76	68	10	20X2
FBN II 10/30 K	M10	10	40	6.1-8.5	96	88	30	20X2
FBN II 12/10	M12	12	65	8.5-12.6	106	95	10	24X2.5
FBN II 12/20	M12	12	65	8.5-12.6	116	105	20	24X2.5
FBN II 12/30	M12	12	65	8.5-12.6	126	115	30	24X2.5
FBN II 12/50	M12	12	65	8.5-12.6	146	135	50	24X2.5
FBN II 12/80	M12	12	65	8.5-12.6	176	165	80	24X2.5
FBN II 12/100	M12	12	65	8.5-12.6	196	185	100	24X2.5
FBN II 12/120	M12	12	65	8.5-12.6	216	205	120	24X2.5
FBN II 12/140	M12	12	65	8.5-12.6	236	225	140	24X2.5
FBN II 12/160	M12	12	65	8.5-12.6	256	245	160	24X2.5
FBN II 12/5 K	M12	12	50	8.5-12.6	86	75	5	24X2.5
FBN II 12/10 K	M12	12	50	8.5-12.6	91	80	10	24X2.5
FBN II 12/30 K	M12	12	50	8.5-12.6	111	100	30	24X2.5
FBN II 16/10	M16	16	80	12.6-17.2	130	114	10	30X3
FBN II 16/25	M16	16	80	12.6-17.2	145	129	25	30X3
FBN II 16/50	M16	16	80	12.6-17.2	170	154	50	30X3
FBN II 16/80	M16	16	80	12.6-17.2	200	184	80	30X3
FBN II 16/100	M16	16	80	12.6-17.2	220	204	100	30X3
FBN II 16/140	M16	16	80	12.6-17.2	260	244	140	30X3
FBN II 16/160	M16	16	80	12.6-17.2	280	264	160	30X3
FBN II 16/200	M16	16	80	12.6-17.2	320	304	200	30X3

Informacje techniczne								
Typ	d	d _o	h _{ef}	k _N	L	Min. t _d	t _{fix}	ø podkładki
FBN II 16/15 K	M16	16	65	12.6-17.2	120	104	15	30X3
FBN II 16/25 K	M16	16	65	12.6-17.2	130	114	25	30X3
FBN II 20/30	M20	20	105	17.2-25.8	184	165	30	37X3
FBN II 20/60	M20	20	105	17.2-25.8	214	195	60	37X3
FBN II 20/80	M20	20	105	17.2-25.8	234	215	80	37X3
FBN II 20/120	M20	20	105	17.2-25.8	274	255	120	37X3
FBN II 20/10 K	M20	20	80	17.2-25.8	139	120	10	37X3

- d_o = Znamionowa średnica końcówki wiertła
- t_o = Grubość armatury
- t_{fix} = Efektywna głębokość kotwienia
- h_{ef} = Efektywna głębokość kotwienia
- Min. t_d = Zalecana głębokość wiercenia
- k_N = Obciążenia w kN
- Dopuszczalne obciążenie jest ważne dla jednej kotwy, przy pękniętym betonie (strefa rozciągania) z klasą betonu C20/25, w tym częściowy współczynnik bezpieczeństwa $\gamma_T = 1,4$ i jeżeli S_{gr}, N i C_{gr}, N są wzięte pod uwagę.
- Kiedy mają miejsce zmniejszenie odstępów i odległości krawędzi, należy przeprowadzić ponowne obliczenie sił przy pomocy podręcznika technicznego lub oprogramowania do obliczeń, dostępnych na żądanie.
- Końcowe obliczenia powinny być zgodne z pełnym Europejskim Zatwierdzeniem Technicznym (ETA), zatwierdzenie to jest również dostępne na żądanie.

Kolejność montażu

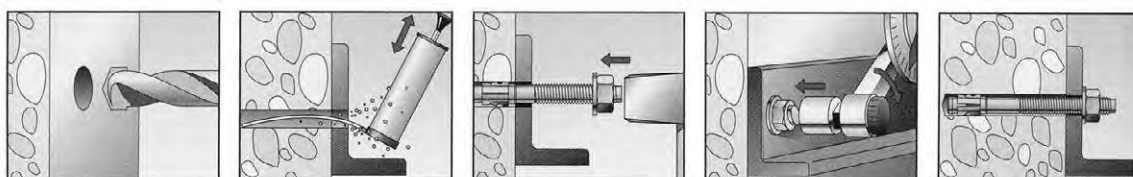

Grupy katalogowe

Gwint	Materiał	Obróbka powierzchni	Kod	Strona
M	St	O cynk.	63324	8-67
M	St.St. A4		63325	8-68

63324 FISCHER Kotwy typ FBN II

N03A

Gwint: Metryczny
Materiał: Stal
Obróbka powierzchni: O cynkowane

fischer
innovative solutions

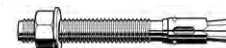

Końcowe obliczenia powinny być zgodne z pełnym Europejskim Zatwierdzeniem Technicznym (ETA), zatwierdzenie to jest również dostępne na żądanie.

Typ	✉	Kod artykułu	Typ	✉	Kod artykułu	Typ	✉	Kod artykułu
6/5 (6x50)	100	63324.060.005	10/70 (10X146)	20	63324.100.070	12/10 K (12X91)	20	63324.121.010
6/10 (6x55)	100	63324.060.010	10/100 (10X176)	20	63324.100.100	12/30 K (12X111)	20	63324.121.030
6/30 (6x75)	100	63324.060.030	10/140 (10X216)	20	63324.100.140	16/25 (16X145)	10	63324.160.025
8/5 (8X66)	50	63324.080.005	10/160 (10X236)	20	63324.100.160	16/50 (16X170)	10	63324.160.050
8/10 (8X71)	50	63324.080.010	10/5 K (10X71)	50	63324.101.005	16/80 (16X200)	10	63324.160.080
8/20 (8X81)	50	63324.080.020	10/10 K (10X76)	50	63324.101.010	16/100 (16X220)	10	63324.160.100
8/30 (8X91)	50	63324.080.030	12/10 (12X106)	20	63324.120.010	16/140 (16X260)	10	63324.160.140
8/50 (8X111)	50	63324.080.050	12/20 (12X116)	20	63324.120.020	16/160 (16X280)	10	63324.160.160
8/70 (8X131)	20	63324.080.070	12/30 (12X126)	20	63324.120.030	16/200 (16X320)	10	63324.160.200
8/100 (8X161)	20	63324.080.100	12/50 (12X146)	20	63324.120.050	16/15 K (16X120)	10	63324.161.015
8/5 K (8X56)	50	63324.081.005	12/80 (12X176)	20	63324.120.080	16/25 K (16X130)	10	63324.161.025
8/10 K (8X61)	50	63324.081.010	12/100 (12X196)	20	63324.120.100	20/30 (20X184)	10	63324.200.030
10/10 (10X86)	50	63324.100.010	12/120 (12X216)	20	63324.120.120	20/60 (20X214)	10	63324.200.060
10/20 (10X96)	50	63324.100.020	12/140 (12X236)	20	63324.120.140	20/80 (20X234)	10	63324.200.080
10/30 (10X106)	50	63324.100.030	12/160 (12X256)	20	63324.120.160	20/120 (20X274)	10	63324.200.120
10/50 (10X126)	20	63324.100.050	12/5 K (12X86)	20	63324.121.005	20/10 K (20X139)	10	63324.201.010

Gwint Metryczny
Materiał Stal nierdzewna A4

fischer
innovative solutions

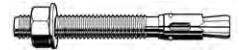

Końcowe obliczenia powinny być zgodne z pełnym Europejskim Zatwierdzeniem Technicznym (ETA),
zatwierdzenie to jest również dostępne na żądanie.

Typ	☒	Kod artykułu	Typ	☒	Kod artykułu	Typ	☒	Kod artykułu
6/10 (6X55)	100	63325.060.010	10/30 (10X106)	50	63325.100.030	12/100 (12X196)	20	63325.120.100
6/30 (6X75)	100	63325.060.030	10/50 (10X126)	20	63325.100.050	16/10 (16X130)	10	63325.160.010
8/10 (8X71)	50	63325.080.010	10/100 (10X176)	20	63325.100.100	16/25 (16X145)	10	63325.160.025
8/30 (8X91)	50	63325.080.030	12/20 (12X116)	20	63325.120.020	16/50 (16X170)	10	63325.160.050
8/50 (8X111)	50	63325.080.050	12/30 (12X126)	20	63325.120.030			
10/20 (10X96)	50	63325.100.020	12/50 (12X146)	20	63325.120.050			

Kotwy klinowe

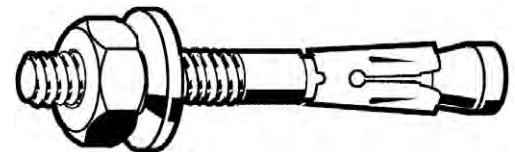
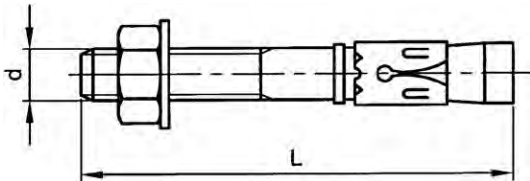

Informacje techniczne

Typ	C _{cr} N	C _{min}	d	d _f	d _o	h _{ef}	h _{min}	h _o	Kod	L	N	S _{cr} N	S _{min}	t _{fix}	T _{inst}
8-20	72-55	60-55	M8	9	8	48-35	100	65-52	C	70	3.0-2.0	144-155	50-45	7-20	15
8-40	72-55	60-55	M8	9	8	48-35	100	65-52	E	90	3.0-2.0	144-105	50-45	27-40	15
8-80	72-55	60-55	M8	9	8	48-35	100	65-52	H	130	3.0-2.0	144-105	50-45	67-80	15
10-15	78-75	75-65	M10	12	10	52-42	104-100	72-62	C	76.2	4.0-3.0	156-125	65-55	5-15	30
10-35	78-75	75-65	M10	12	10	52-42	104-100	72-62	E	96.2	4.0-3.0	156-126	65-55	25-35	30
10-80	78-75	75-65	M10	12	10	52-42	104-100	72-62	I	141.2	4.0-3.0	156-126	65-55	70-80	30
12-25	102-100	100-90	M12	14	12	68-50	136-100	93-75	E	100	6.6-5.3	204-150	100-75	8-25	50
12-65	102-100	100-90	M12	14	12	68-50	136-100	93-75	I	140	6.6-5.3	204-105	100-75	48-65	50
12-105	102-100	100-90	M12	14	12	68-50	136-100	93-75	L	180	6.6-5.3	204-150	100-75	88-105	50
12-145	102-100	100-90	M12	14	12	68-50	136-100	93-75	O	220	6.6-5.3	204-150	100-75	128-145	50
16-30	129-100	100-105	M16	18	16	86-64	172-128	117-95	G	125	13.2-8.3	258-192	100-90	8-30	100
16-75	129-100	100-105	M16	18	16	86-64	172-128	117-95	K	170	13.2-8.3	258-192	100-90	53-75	100
20-50	150-115	115-125	M20	22	20	100-74	200-148	136-110	J	160	9.9-9.9	300-222	100-105	25-50	160
20-105	150-115	115-125	M20	22	20	100-74	200-148	136-110	J	215	9.9-9.9	300-222	100-105	80-105	160

- Kod = Kod literowy oznaczenia.
- d_o = Znamionowa średnica końcówki wiertła.
- T_{inst} = Moment obrotowy dokręcania w Nm.
- d_f = Średnica otworu w armaturze.
- h_{min} = Minimalna grubość podpory betonowej.
- h_o = Zalecana głębokość wiercenia.
- t_{fix} = Grubość armatury.
- h_{ef} = Efektywna głębokość kotwienia.
- S_{cr} N = Odstęp.
- C_{cr} N = Odległość krawędzi.
- S_{min} = Minimalny odstęp.
- C_{min} = Minimalna odległość krawędzi.
- N = Dopuszczalne obciążenie w kN.
- Dopuszczalne obciążenie jest ważne dla jednej kotwy, przy niepełnym betonie (strefa nacisku) z klasą betonu C20/25, w tym częściowy współczynnik bezpieczeństwa γ_f = 1,4 i jeżeli S_{cr} N i C_{cr} N są wzięte pod uwagę.
- Kiedy mają miejsce zmniejszenie odstępu i odległości krawędzi, należy przeprowadzić ponowne obliczenie sił przy pomocy podręcznika technicznego lub oprogramowania do obliczeń, dostępnych na żądanie.
- Końcowe obliczenia powinny być zgodne z pełnym Europejskim Zatwierdzeniem Technicznym (ETA), zatwierdzenie to jest również dostępne na żądanie.

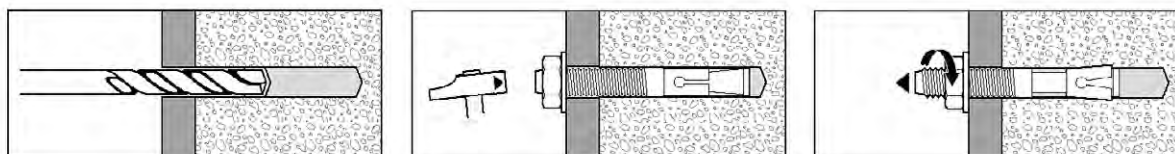
Kolejność montażu

70927 Kotwy klinowe Spit FIX 3
P03A
Materiał Stal
Obróbka powierzchni Ocynkowane

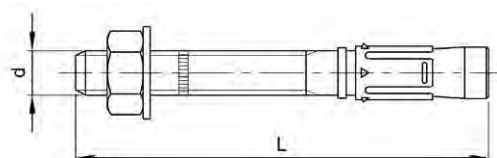
Typ	☒	Kod artykułu	Typ	☒	Kod artykułu	Typ	☒	Kod artykułu
M8X20	100	70927.080.020	M12X25	25	70927.120.025	M16X30	20	70927.160.030
M8X40	50	70927.080.040	M12X65	25	70927.120.065	M16X75	10	70927.160.075
M10X15	50	70927.100.015	M12X105	25	70927.120.105	M20X50	10	70927.200.050
M10X35	50	70927.100.035	M12X145	20	70927.120.145	M20X105	10	70927.200.105
M10X80	25	70927.100.080						

Kotwy klinowe Promaxx

Informacje techniczne

d x L	C _{cr} N	C _{min.}	d _f	d _o	h (nom.)	h ₁	h _{ef}	Kod	N _{rec}	s	S _{cr} N	S _{min.}	f _{fix} (maks.)	T _{inst}	ø podkładki
M8x75	72	75	9	8	55	60	48	C	3.57	13	144	75	9	20	16
M8x95	72	75	9	8	55	60	48	E	3.57	13	144	75	29	20	16
M8x115	72	75	9	8	55	60	48	G	3.57	13	144	75	49	20	16
M10x90	90	90	12	10	68	75	60	E	4.76	17	150	90	10	40	20
M10x105	90	90	12	10	68	75	60	F	4.76	17	150	90	25	40	20
M10x115	90	90	12	10	68	75	60	G	4.76	17	150	90	35	40	20
M10x135	90	90	12	10	68	75	60	H	4.76	17	150	90	55	40	20
M10x165	90	90	12	10	68	75	60	J	4.76	17	150	90	85	40	20
M10x185	90	90	12	10	68	75	60	L	4.76	17	150	90	105	40	20
M12x110	105	105	14	12	80	85	70	F	6.35	19	175	105	14	60	24
M12x120	105	105	14	12	80	85	70	G	6.35	19	175	105	24	60	24
M12x130	105	105	14	12	80	85	70	H	6.35	19	175	105	34	60	24
M12x150	105	105	14	12	80	85	70	I	6.35	19	175	105	54	60	24
M12x180	105	105	14	12	80	85	70	L	6.35	19	175	105	84	60	24
M12x200	105	105	14	12	80	85	70	M	6.35	19	175	105	104	60	24
M16x145	128	130	18	16	97	105	85	I	13.89	24	213	130	28	100	30
M16x175	128	130	18	16	97	105	85	K	13.89	24	213	130	58	100	30
M16x220	128	130	18	16	97	105	85	O	13.89	24	213	130	103	100	30
M16x250	128	130	18	16	97	105	85	Q	13.89	24	213	130	133	100	30
M20x170	150	150	22	20	114	125	100	K	15.87	30	250	150	32	200	37
M20x200	150	150	22	20	114	125	100	O	15.87	30	250	150	82	200	37

- Kod = Kod literowy oznaczenia
- d_o = Znamionowa średnica końcówki wiertła
- d_p = Średnica otworu w armaturze
- h_i = Głębokość wierconego otworu do najgłębszego punktu
- h_{nom} = Minimalna głębokość wiercenia
- h_{ef} = Efektywna głębokość kotwienia
- $t_{fix}(max)$ = Grubość armatury
- s = Szerokością powierzchni
- $ring \ \varnothing$ = Średnica pierścienia
- $S_{cr, N}$ = Odstęp
- $C_{cr, N}$ = Odległość krawędzi
- $S_{cr, min}$ = Minimalny odstęp
- $C_{cr, min}$ = Minimalna odległość krawędzi
- N_{min} = Zalecane obciążenie w kN
- T_{inst} = Moment obrotowy dokręcania w Nm
- Dopuszczalne obciążenie (N_{rec}) jest ważne dla jednej kotwy, przy niepękniętym betonie (strefa nacisku) z klasą betonu C20/25, w tym częściowy współczynnik bezpieczeństwa $\gamma_r = 1,4$ i jeżeli $S_{cr, N}$ i $C_{cr, N}$ są wzięte pod uwagę.
- Przy ograniczonym rozstawie czy odległości od krawędzi powinna nastąpić rekalkulacja sił przy użyciu przewodnika technicznego, dostępny na żądanie.
- Końcowe obliczenia powinny być zgodne z pełnym Europejskim Zatwierdzeniem Technicznym (ETA), zatwierdzenie to jest również dostępne na żądanie.



Końcowe obliczenia powinny być zgodne z pełnym Europejskim Zatwierdzeniem Technicznym (ETA), zatwierdzenie to jest również dostępne na żądanie.

30554 MAXXFAST Kotwy wysokosprawne		MF4A
Gwint	Metryczny	
Materiał	Stal	
Obróbka powierzchni	Ocynkowane	

d x L	☒	Kod artykułu	d x L	☒	Kod artykułu	d x L	☒	Kod artykułu
M8X75	50	30554.080.075	M10X165	25	30554.100.165	M12X200	25	30554.120.200
M8X95	50	30554.080.095	M10X185	25	30554.100.185	M16X145	10	30554.160.145
M8X115	50	30554.080.115	M12X110	25	30554.120.110	M16X175	10	30554.160.175
M10X90	50	30554.100.090	M12X120	25	30554.120.120	M16X220	10	30554.160.220
M10X105	25	30554.100.105	M12X130	25	30554.120.130	M16X250	10	30554.160.250
M10X115	25	30554.100.115	M12X150	25	30554.120.150	M20X170	10	30554.200.170
M10X135	25	30554.100.135	M12X180	25	30554.120.180	M20X200	10	30554.200.200

Kotwy fundamentowe typ FAZ

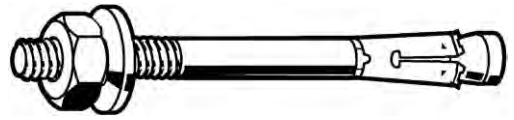
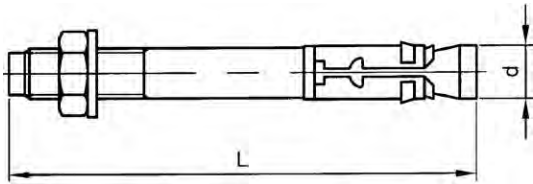

Informacje techniczne

Typ	d	d _o	h _{ef}	k _N	L	Min. t _d	s	t _{fix}	ø podkładki
FAZ II 8/10	M8	8	45	2.4	77	75	13	10	16X1.6
FAZ II 8/30	M8	8	45	2.4	97	95	13	30	16X1.6
FAZ II 8/50	M8	8	45	2.4	117	115	13	50	16X1.6
FAZ II 8/100	M8	8	45	2.4	167	165	13	100	16X1.6
FAZ II 8/150	M8	8	45	2.4	217	215	13	150	16X1.6
FAZ II 10/10	M10	10	60	4.3	95	90	17	10	20X2
FAZ II 10/20	M10	10	60	4.3	105	100	17	20	20X2
FAZ II 10/30	M10	10	60	4.3	115	110	17	30	20X2
FAZ II 10/50	M10	10	60	4.3	135	130	17	50	20X2
FAZ II 10/80	M10	10	60	4.3	165	160	17	80	20X2
FAZ II 10/100	M10	10	60	4.3	185	180	17	100	20X2
FAZ II 10/150	M10	10	60	4.3	235	230	17	150	20X2
FAZ II 12/10	M12	12	70	7.6	110	105	19	10	24X2.5
FAZ II 12/20	M12	12	70	7.6	120	115	19	20	24X2.5
FAZ II 12/30	M12	12	70	7.6	130	125	19	30	24X2.5
FAZ II 12/50	M12	12	70	7.6	180	145	19	50	24X2.5
FAZ II 12/80	M12	12	70	7.6	180	175	19	80	24X2.5
FAZ II 12/100	M12	12	70	7.6	200	195	19	100	24X2.5
FAZ II 12/150	M12	12	70	7.6	250	245	19	150	24X2.5
FAZ II 12/200	M12	12	70	7.6	300	295	19	200	24X2.5
FAZ II 16/25	M16	16	85	13.4	150	140	24	25	30X3
FAZ II 16/50	M16	16	85	13.4	175	165	24	50	30X3
FAZ II 16/100	M16	16	85	13.4	225	215	24	100	30X3
FAZ II 16/150	M16	16	85	13.4	275	265	24	150	30X3
FAZ II 16/200	M16	16	85	13.4	325	315	24	200	30X3
FAZ II 16/250	M16	16	85	13.4	375	365	24	250	30X3
FAZ II 16/300	M16	16	85	13.4	425	415	24	300	30X3
FAZ II 20/30	M20	20	100	17.1	170	155	30	30	37X3
FAZ II 20/60	M20	20	100	17.1	200	185	30	60	37X3
FAZ II 20/150	M20	20	100	17.1	290	275	30	150	37X3
FAZ II 24/30	M24	24	125	24.0	204	185	36	30	44X4
FAZ II 24/60	M24	24	125	24.0	234	215	36	60	44X4

- **d** = Znamionowa średnica końcówki wiertła
- **Min. t_d** = Zalecana głębokość wiercenia
- **h_{ef}** = Efektywna głębokość kotwienia
- **t_{fix}** = Grubość armatury
- **s** = Szerokością powierzchni
- **k_N** = Obciążenia w kN
- Dopuszczalne obciążenie jest ważne dla jednej kotwy, przy pękniętym betonie (strefa rozciągania) z klasą betonu C20/25, w tym częściowy współczynnik bezpieczeństwa $\gamma_f = 1,4$ i jeżeli $S_{gr, N}$ i $C_{gr, N}$ są wzięte pod uwagę.
- Końcowe obliczenia powinny być zgodne z pełnym Europejskim Zatwierdzeniem Technicznym (ETA), zatwierdzenie to jest również dostępne na żądanie.

Kolejność montażu

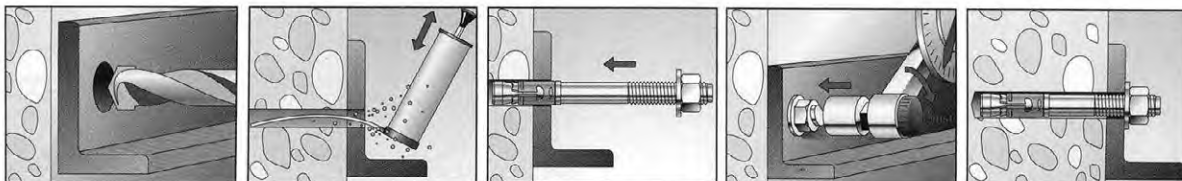

Gwint Metryczny
 Materiał Stal
 Obróbka powierzchni Ocynkowane

fischer
 innovative solutions



Końcowe obliczenia powinny być zgodne z pełnym Europejskim Zatwierdzeniem Technicznym (ETA),
 zatwierdzenie to jest również dostępne na żądanie.

Typ	☒	Kod artykułu	Typ	☒	Kod artykułu	Typ	☒	Kod artykułu
FAZII8/10	50	63323.080.010	FAZII10/100	20	63323.100.100	FAZII16/50	10	63323.160.050
FAZII8/30	50	63323.080.030	FAZII12/10	20	63323.120.010	FAZII16/100	10	63323.160.100
FAZII8/50	50	63323.080.050	FAZII12/20	20	63323.120.020	FAZII16/200	10	63323.160.200
FAZII8/100	25	63323.080.100	FAZII12/30	20	63323.120.030	FAZII16/250	10	63323.160.250
FAZII10/10	50	63323.100.010	FAZII12/50	20	63323.120.050	FAZII16/300	10	63323.160.300
FAZII10/20	25	63323.100.020	FAZII12/80	20	63323.120.080	FAZII20/30	5	63323.200.030
FAZII10/30	25	63323.100.030	FAZII12/100	20	63323.120.100	FAZII20/60	5	63323.200.060
FAZII10/50	20	63323.100.050	FAZII12/200	10	63323.120.200	FAZII24/30	5	63323.240.030
FAZII10/80	20	63323.100.080	FAZII16/25	10	63323.160.025	FAZII24/60	5	63323.240.060

Kotwy wysokosprawne, typ FH-B

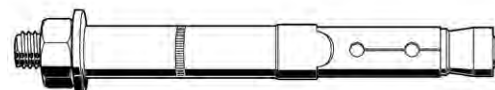
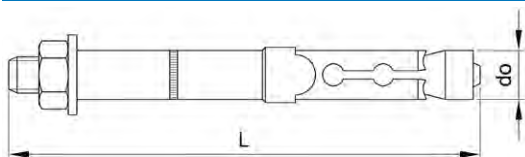

Informacje techniczne

Typ	d	d _o	h _{ef}	k _N	L	Min. t _d	s	t _{fix}	ø podkładki
FH II 10/10 B	M6	10	50	2.0	85	80	10	10	18X1.6
FH II 10/25 B	M6	10	50	2.0	100	95	10	25	18X1.6
FH II 10/50 B	M6	10	50	2.0	125	120	10	50	18X1.6
FH II 12/10 B	M8	12	60	5.7	90	90	12	10	22X2.5
FH II 12/25 B	M8	12	60	5.7	105	105	13	25	22X2.5
FH II 12/50 B	M8	12	60	5.7	130	130	13	50	22X2.5
FH II 12/100 B	M8	12	60	5.7	184	190	13	100	22X2.5
FH II 15/10 B	M10	15	70	7.6	110	100	17	10	25X3
FH II 15/25 B	M10	15	70	7.6	125	115	17	25	25X3
FH II 15/50 B	M10	15	70	7.6	150	140	17	50	25X3
FH II 15/100 B	M10	15	70	7.6	200	190	17	100	25X3
FH II 18/25 B	M12	18	80	11.9	135	130	19	25	30X3
FH II 18/50 B	M12	18	80	11.9	160	155	19	50	30X3
FH II 18/100 B	M12	18	80	11.9	214	205	19	100	30X3
FH II 24/25 B	M16	24	100	17.1	167	150	24	25	40X5
FH II 24/50 B	M16	24	100	17.1	195	175	24	50	40X5
FH II 24/100 B	M16	24	100	17.1	242	225	24	100	40X5

- d = Znamionowa średnica końcówki wiertła
- Min. t_d = Zalecana głębokość wiercenia
- h_{ef} = Efektywna głębokość kotwienia
- t_{fix} = Grubość armatury
- s = Szerokością powierzchni
- k_N = Obciążenia w kN
- Dopuszczalne obciążenie jest ważne dla jednej kotwy, przy pęknięciu betonie (strefa rozciągania) z klasą betonu C20/25, w tym częściowy współczynnik bezpieczeństwa γ_f= 1,4 i jeżeli S_{gr}, N i C_{gr}, N są wzięte pod uwagę.
- Kiedy mają miejsce zmniejszenie odstępów i odległości krawędzi, należy przeprowadzić ponowne obliczenie sił przy pomocy podręcznika technicznego lub oprogramowania do obliczeń, dostępnych na żądanie.
- Końcowe obliczenia powinny być zgodne z pełnym Europejskim Zatwierdzeniem Technicznym (ETA), zatwierdzenie to jest również dostępne na żądanie.

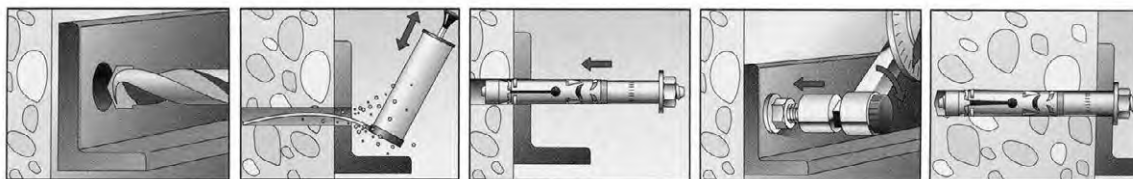
Kolejność montażu

63421 FISCHER Kotwy o wysokiej wytrzymałości typ FH II-B		N03A
Gwint	Metryczny	
Materiał	Stal	
Obróbka powierzchni	Ocynkowane	



Końcowe obliczenia powinny być zgodne z pełnym Europejskim Zatwierdzeniem Technicznym (ETA),
zatwierdzenie to jest również dostępne na żądanie.

Typ	☒	Kod artykułu	Typ	☒	Kod artykułu	Typ	☒	Kod artykułu
FH II 10/10 B	50	63421.100.011	FH II 12/100 B	25	63421.120.100	FH II 18/50 B	20	63421.180.050
FH II 10/25 B	50	63421.100.026	FH II 15/10 B	25	63421.150.010	FH II 18/100 B	10	63421.180.100
FH II 10/50 B	50	63421.100.051	FH II 15/25 B	25	63421.150.025	FH II 24/25 B	10	63421.240.025
FH II 12/10 B	50	63421.120.010	FH II 15/50 B	25	63421.150.050	FH II 24/50 B	10	63421.240.050
FH II 12/25 B	50	63421.120.025	FH II 15/100 B	20	63421.150.100	FH II 24/100 B	5	63421.240.100
FH II 12/50 B	25	63421.120.050	FH II 18/25 B	20	63421.180.025			

Kotwy wysokosprawne, typ FH-S

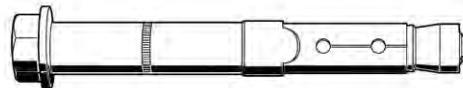
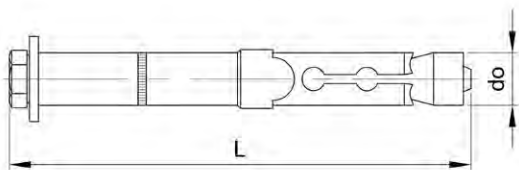

Informacje techniczne

Typ	d	d ₀	h _{ef}	k _N	L	Min. t _d	s	t _{fix}	Ø podkładki
FH II 10/10 S	M6	10	50	2.0	84	85	10	10	18X1.6
FH II 10/25 S	M6	10	50	2.0	99	100	10	25	18X1.6
FH II 10/50 S	M6	10	50	2.0	124	125	10	50	18X1.6
FH II 12/10 S	M8	12	60	5.7	90	90	13	10	22X2.5
FH II 12/25 S	M8	12	60	5.7	105	105	13	25	22X2.5
FH II 12/50 S	M8	12	60	5.7	130	130	13	50	22X2.5
FH II 15/10 S	M10	15	70	7.6	106	100	17	10	25X3
FH II 15/25 S	M10	15	70	7.6	121	115	17	25	25X3
FH II 15/50 S	M10	15	70	7.6	146	140	17	50	25X3
FH II 18/10 S	M12	18	80	11.9	118	115	19	10	30X3
FH II 18/25 S	M12	18	80	11.9	132	130	19	25	30X3
FH II 18/50 S	M12	18	80	11.9	157	155	19	50	30X3
FH II 24/25 S	M16	24	100	17.1	160	150	24	25	40X5
FH II 24/50 S	M16	24	100	17.1	185	175	24	50	40X5

- d = Znamionowa średnica końcówki wiertła
- Min. t_d = Zalecana głębokość wiercenia
- h_{ef} = Efektywna głębokość kotwienia
- t_{fix} = Grubość armatury
- s = Szerokością powierzchni
- k_N = Obciążenia w kN
- Dopuszczalne obciążenie jest ważne dla jednej kotwy, przy pękniętym betonie (strefa rozciągania) z klasą betonu C20/25, w tym częściowy współczynnik bezpieczeństwa γ_f = 1.4 i jeżeli S_{cr}, N i C_{cr}, N są wzięte pod uwagę.
- Kiedy mają miejsce zmniejszenia odstępu i odległości krawędzi, należy przeprowadzić ponowne obliczenie sił przy pomocy podręcznika technicznego lub oprogramowania do obliczeń, dostępnych na żądanie.
- Końcowe obliczenia powinny być zgodne z pełnym Europejskim Zatwierdzeniem Technicznym (ETA), zatwierdzenie to jest również dostępne na żądanie.

Kolejność montażu

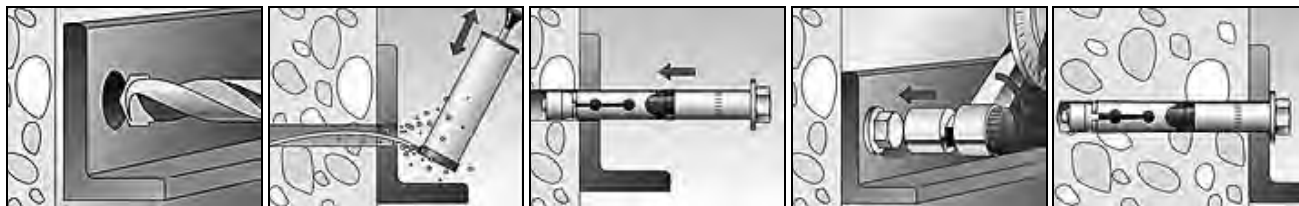

63422 FISCHER Kotwy o wysokiej wytrzymałości typ FH II-S

N03A

Gwint Metryczny
 Materiał Stal
 Obróbka powierzchni Ocynkowane

fischer
 innovative solutions



Końcowe obliczenia powinny być zgodne z pełnym Europejskim Zatwierdzeniem Technicznym (ETA), zatwierdzenie to jest również dostępne na żądanie.

Typ	☒	Kod artykułu	Typ	☒	Kod artykułu	Typ	☒	Kod artykułu
FH II 10/10 S	50	63422.100.011	FH II 12/25 S	50	63422.120.025	FH II 15/50 S	25	63422.150.050
FH II 10/25 S	50	63422.100.026	FH II 12/50 S	25	63422.120.050	FH II 18/10 S	20	63422.180.010
FH II 10/50 S	50	63422.100.051	FH II 15/10 S	25	63422.150.010	FH II 18/25 S	20	63422.180.025
FH II 12/10 S	50	63422.120.010	FH II 15/25 S	25	63422.150.025	FH II 18/50 S	20	63422.180.050

63422 FISCHER Kotwy o wysokiej wytrzymałości typ FH II-S

Typ	✉	Kod artykułu	Typ	✉	Kod artykułu
FH II 24/25 S	10	63422.240.025	FH II 24/50 S	10	63422.240.050

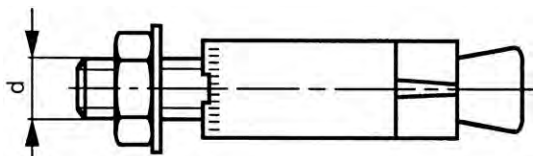
Kotwy ze śrubą, typ FZA

Informacje techniczne

Typ	FZA 12x40 M8/15	FZA 12x50 M8/15	FZA 14x40 M10/25	FZA 14x60 M10/25	FZA 18x80 M12/25
d	M8	M8	M10	M10	M12
Głębokość wiercenia	40	50	40	60	80
T _{inst}	20	20	40	40	60
Wiertło ø (typ FZUB)	12x40	12x50	14x40	14x60	18x80
Zakres uchwytu (maks.)	15	15	25	25	25
Dopuszczalne obciążenie w kN					
Beton ≥ C20/25	2.4	4.3	2.4	5.7	9.5

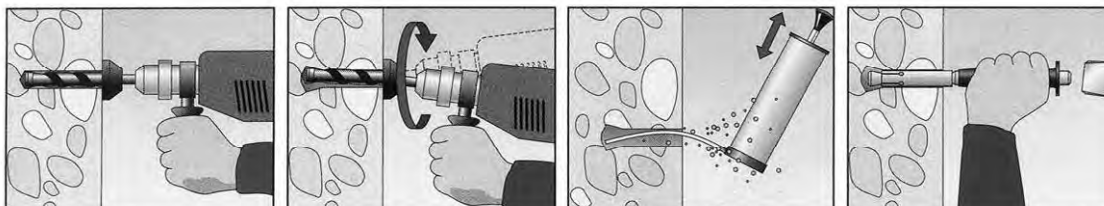
- Wysokie, możliwe do zamontowania w strefach rozciągania!
- Dopuszczalne obciążenie jest ważne dla jednej kotwy, przy pękniętym betonie (strefa rozciągania) z klasą betonu C20/25, w tym częściowy współczynnik bezpieczeństwa $\gamma_F = 1,4$.
- Kiedy mają miejsce zmniejszenia odstępu i odległości krawędzi, należy przeprowadzić ponowne obliczenie sił przy pomocy podręcznika technicznego lub oprogramowania do obliczeń, dostępnych na żądanie.
- Końcowe obliczenia powinny być zgodne z pełnym Europejskim Zatwierdzeniem Technicznym (ETA), zatwierdzenie to jest również dostępne na żądanie.

Kolejność montażu

63445 FISCHER-ZYKON Kotwy ze śrubą, typ FZA
N03B

Gwint	Metryczny
Materiał	Stal
Obróbka powierzchni	Ocynkowane

fischer
 innovative solutions

Końcowe obliczenia powinny być zgodne z pełnym Europejskim Zatwierdzeniem Technicznym (ETA), zatwierdzenie to jest również dostępne na żądanie.

Typ	✉	Kod artykułu	Typ	✉	Kod artykułu	Typ	✉	Kod artykułu
FZA 12X40 M8/15	25	63445.120.040	FZA 14X40 M10/25	25	63445.140.040	FZA 18X80 M12/25	10	63445.180.080
FZA 12X50 M8/15	20	63445.120.050	FZA 14X60 M10/25	10	63445.140.060			

Narzędzia instalacyjne do kotew rozporowych

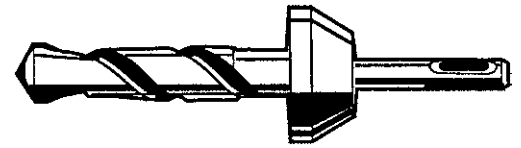

63690 FISCHER-ZYKON Narzędzia instalacyjne do kotew rozporowych typ FZA N03A

fischer innovative solutions

Typ	☒	Kod artykułu		
FZUB 12X40	1	63690.100.005	<ul style="list-style-type: none"> • Stożkowa, prawidłowa geometria wierconego otworu • Wiercenie i podcinanie w jednej, pojedynczej operacji • Z elastyczną głębokością zatrzymania • Uchwyt SDS-plus 	
FZUB 14X40	1	63690.100.010	<ul style="list-style-type: none"> • Stożkowa, prawidłowa geometria wierconego otworu • Wiercenie i podcinanie w jednej, pojedynczej operacji • Z elastyczną głębokością zatrzymania • Uchwyt SDS-plus 	
FZUB 12X50	1	63690.100.015	<ul style="list-style-type: none"> • Stożkowa, prawidłowa geometria wierconego otworu • Wiercenie i podcinanie w jednej, pojedynczej operacji • Z elastyczną głębokością zatrzymania • Uchwyt SDS-plus 	
FZUB 14X60	1	63690.100.020	<ul style="list-style-type: none"> • Stożkowa, prawidłowa geometria wierconego otworu • Wiercenie i podcinanie w jednej, pojedynczej operacji • Z elastyczną głębokością zatrzymania • Uchwyt SDS-plus 	
FZUB 18X80	1	63690.100.025	<ul style="list-style-type: none"> • Stożkowa, prawidłowa geometria wierconego otworu • Wiercenie i podcinanie w jednej, pojedynczej operacji • Z elastyczną głębokością zatrzymania • Uchwyt SDS-plus 	
FZE 12 PLUS	1	63690.100.030		
FZE 14 PLUS	1	63690.100.035		
FZE 18 PLUS	1	63690.100.040		

MaxxFast – zaprawy chemiczne do kotew

MaxxFast przedstawia nowy asortyment wysokiej jakości mocowań chemicznych. Seria składa się z dwóch typów zapraw chemicznych (do standardowych i dużych obciążeń), ocynkowanych kołków kotwiących, plastikowych tulei oraz wszystkich potrzebnych akcesoriów do kotwienia. Wysokiej jakości produkty spełnią potrzeby najbardziej wymagających i trudnych aplikacji. VinyMaxx to nasz nowy standard mocowań chemicznych do dużych obciążeń. Może być używany zarówno w materiale pełnym oraz otworowym. Daje świetne wyniki w zastosowaniu przy wszystkich trudnych aplikacjach. AcryMaxx to nowa chemiczna zaprawa do dużych obciążeń. Może być stosowana w betonie lub w innych wysokiej gęstości kamieniach. Jest to najlepsze rozwiązanie przy wymagających i trudnych aplikacjach. Nasze produkty do kotwienia są zarówno wytrzymałe jak i niezawodne po to aby otrzymać rezultat najlepszy z możliwych.

VinyMaxx Do standardowych obciążeń

Do standardowych zastosowań:

- Do materiałów pełnych oraz otworowych
- Automatyczne otwieranie
- Pozostały materiał może zostać wykorzystany ponownie
- Bezzapachowe (nie zawiera styrenu)
- Do zastosowań w mokrym betonie
- Do zastosowań w zalanych dziurach

Do mocowania:

- Balustrad
- Poręczy
- Zadaszeń
- Zawiasów
- Anten

AcryMaxx ETA 1 Do dużych obciążeń

Z aprobatą do użycia z prętami gwintowanymi w betonie zarysowanym i niezarysowanym (ETAG001 opcja 1)

Do zastosowań krytycznych

- Do dużych obciążeń
- Do materiału pełnego
- Automatyczne otwieranie
- Bezzapachowe (nie zawiera styrenu)
- Do zastosowań w mokrym betonie
- Do zastosowań w zalanych dziurach

Do mocowania:

- Barrier ochronnych
- Regałów magazynowych
- Suwnic
- Maszyn
- Metalowych konstrukcji



Pręty gwintowane mocowane chemicznie

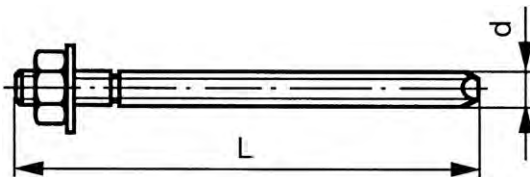

Informacje techniczne

Typ	M8x110	M10x130	M12x160	M12x220	M16x190	M16x220	M20x260
$C_{cr, N}$	90 - 105	105 - 132	120 - 158	120 - 158	150 - 188	150 - 188	180 - 225
C_{min}	$0.5 \cdot h_{ef} \geq 40\text{mm}$	$0.5 \cdot h_{ef} \geq 40\text{mm}$	$0.5 \cdot h_{ef} \geq 40\text{mm}$	$0.5 \cdot h_{ef} \geq 40\text{mm}$	$0.5 \cdot h_{ef} \geq 40\text{mm}$	$0.5 \cdot h_{ef} \geq 40\text{mm}$	$0.5 \cdot h_{ef} \geq 40\text{mm}$
d	8	10	12	12	16	16	20
d_f	9	12	14	14	18	18	22
d_o	10	12	14	14	18	18	24
h_{ef}	60-100	70-120	80-145	80-146	100-190	100-191	120-240
h_{min}	$h_{ef} + 30\text{mm}; \geq 100\text{mm}$	$h_{ef} + 30\text{mm}; \geq 100\text{mm}$	$h_{ef} + 30\text{mm}; \geq 100\text{mm}$	$h_{ef} + 30\text{mm}; \geq 100\text{mm}$	$h_{ef} + 30\text{mm}; \geq 100\text{mm}$	$h_{ef} + 30\text{mm}; \geq 100\text{mm}$	$h_{ef} + 48\text{mm}$
h_o	$h_{ef} + 5\text{mm}$	$h_{ef} + 5\text{mm}$	$h_{ef} + 5\text{mm}$	$h_{ef} + 5\text{mm}$	$h_{ef} + 5\text{mm}$	$h_{ef} + 5\text{mm}$	$h_{ef} + 5\text{mm}$
L	110	130	160	220	190	220	260
$S_{cr, N}$	180 - 211	210 - 263	240 - 316	240 - 316	300 - 375	300 - 375	360 - 450
Dopuszczalne obciążenie w kN							
Beton	7.78	11.35	15.56	15.56	21.94	21.94	28.41

- $C_{cr, N}$ = Odległość od krawędzi (rozciąganie) .
- $C_{cr, N}$ = Min. odległość od krawędzi
- d_f = Średnica otworu w uchwycie.
- d_o = Średnica otworu w materiale.
- h_{ef} = Efektywna głębokość zakotwienia.
- h_{min} = Minimalna grubość materiału.
- h_{min} = Minimalna głębokość otworu.
- $S_{cr, N}$ = Charakterystyczny rozstaw.
- Beton C20/25; zalecane obciążenie dla betonu niepopękany.**
- Dop. obciążenie ważne tylko dla zaprawy Acrymaxx w połączeniu z prętami w klasie 5.8
- Dopuszczalne obciążenie jest ważne dla jednej kotwy, przy pękniętym betonie (strefa rozciągania) z klasą betonu C20/25, w tym częściowy współczynnik bezpieczeństwa $\gamma_r = 1,4$ i jeżeli $S_{cr, N}$ i $C_{cr, N}$ są wzięte pod uwagę.
- Końcowe obliczenia powinny być zgodne z pełnym Europejskim Zatwierdzeniem Technicznym (ETA), zatwierdzenie to jest również dostępne na żądanie.



8

Końcowe obliczenia powinny być zgodne z pełnym Europejskim Zatwierdzeniem Technicznym (ETA), zatwierdzenie to jest również dostępne na żądanie.

30585	MAXXFAST Pręty gwintowane mocowane chemicznie	MF40
Gwint	Metryczny	
Materiał	Stal	
Obróbka powierzchni	Ocynkowane	

Typ	☒	Kod artykułu	Typ	☒	Kod artykułu	Typ	☒	Kod artykułu
M8X110	10	30585.080.110	M12X220	10	30585.120.220	M16X220	10	30585.160.220
M10X130	10	30585.100.130	M16X190	10	30585.160.190	M20X260	6	30585.200.260
M12X160	10	30585.120.160						

Pręty gwintowane mocowane chemicznie, typ RG M

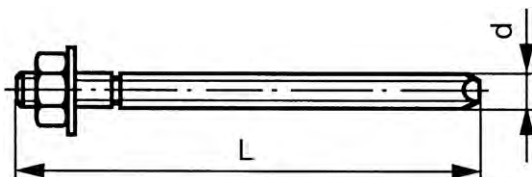

Informacje techniczne

Typ	M8x 110	M10x 130	M10x 165	M10x 190	M12x 160	M12x 220	M12x 250	M12x 300	M16x 190	M16x 250	M16x 300	M20x 260	M20x 350	M24x 300	M30x 380
d	M8	M10	M10	M10	M12	M12	M12	M12	M16	M16	M16	M20	M20	M24	M30
L	110	130	165	190	160	220	250	300	190	250	300	260	350	300	380
t _{fix} (maks.)	13	20	57	82	25	90	120	170	35	98	148	65	155	65	65
Dopuszczalne obciążenie w kN															
Beton	6.3	7.9	7.9	7.9	11.9	11.9	11.9	11.9	19.8	19.8	19.8	29.8	29.8	37.7	67.5

- t_{fix} (maks.) = Zakres uchwytu (maks.)
- Beton C20/25 do C50/65; zalecane obciążenie dla betonu niespękanego.

Grupy katalogowe

Gwint	Materiał	Obróbka powierzchni	Kod	Strona
M	St	Ocynk.	63187	8-79
M	St.St. A4		63188	8-79

63187 FISCHER Pręty gwintowane mocowane chemicznie, typ RG M

N03B

Gwint: Metryczny
 Materiał: Stal
 Obróbka powierzchni: Ocynkowane

fischer
 innovative solutions



Typ	☒	Kod artykułu	Typ	☒	Kod artykułu	Typ	☒	Kod artykułu
M8X110	10	63187.080.110	M12X250	10	63187.120.250	M20X260	10	63187.200.260
M10X130	10	63187.100.130	M12X300	10	63187.120.300	M20X350	10	63187.200.350
M10X165	10	63187.100.165	M16X165	10	63187.160.165	M24X300	10	63187.240.300
M10X190	10	63187.100.190	M16X190	10	63187.160.190	M30X380	5	63187.300.380
M12X160	10	63187.120.160	M16X250	10	63187.160.250			
M12X220	10	63187.120.220	M16X300	10	63187.160.300			

63188 FISCHER Pręty gwintowane mocowane chemicznie, typ RG M

N03B

Gwint: Metryczny
 Materiał: Stal nierdzewna A4

fischer
 innovative solutions



Typ	☒	Kod artykułu	Typ	☒	Kod artykułu	Typ	☒	Kod artykułu
M8X110	10	63188.080.110	M12X160	10	63188.120.160	M20X260	10	63188.200.260
M10X130	10	63188.100.130	M16X190	10	63188.160.190	M24X300	10	63188.240.300
M10X165	10	63188.100.165						

Pręty gwintowane mocowane chemicznie

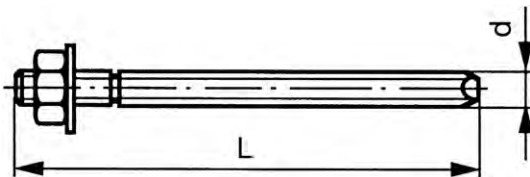

20663	Pręty gwintowane mocowane chemicznie	G06A
Gwint	Metryczny	
Materiał	Stal	
Klasa	5.8	
Obróbka powierzchni	Ocynkowane na gorąco	

d x L	☒	Kod artykułu	d x L	☒	Kod artykułu	d x L	☒	Kod artykułu
M10X130	10	20663.100.130	M16X190	10	20663.160.190	M20X260	1	20663.200.260
M12X160	10	20663.120.160						

- Tylko pełne opakowania.

Kotwa gwintowana dwustronnie Maxima

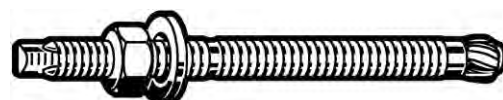
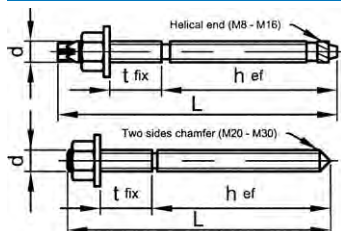



Informacje techniczne

Typ	M8	M10	M12	M16	M20	M24	M30
D	M8	M10	M12	M16	M20	M24	M30
Dopuszczalne obciążenie w kN	5.3	8.3	13.2	19.8	36.9	38	46.3
Efektywna głębokość kotwienia ($h_{ef,min.} - h_{ef,max.}$)	80	90	110	125	170	210	280
Grubość armatury	15	25	30	40	68	64	70
Głębokość wierconego otworu do najgłębszego punktu ($h_{omin.} - h_{omaks.}$)	80	90	110	125	170	210	280
L	105	128	155	183	260	300	380
Minimalna grubość podpory betonowej ($h_{min.}$)	110	120	150	160	220	300	350
Minimalna odległość krawędzi ($C_{min.}$)	40	45	55	65	85	105	140
Minimalny odstęp ($S_{min.}$)	40	45	55	65	85	105	140
Moment dokręcania w Nm	10	20	30	60	120	200	400
Odległość krawędzi ($C_{cr. N}$). charakterystyka	80	90	110	125	170	210	280
Odstęp ($S_{cr. N}$). charakterystyka	160	180	220	250	340	420	560
Znamionowa średnica końcówki wiertła (d_o)	10	12	14	18	25	28	35
Średnica otworu w armaturze (d_i)	9	12	14	18	22	26	33

Grupy katalogowe

Gwint	Materiał	Obróbka powierzchni	Kod	Strona
M	St	Ocynk.	70636	8-81
M	St.St. A4		70646	8-81

70636	SPIT Kotwa gwintowana dwustronnie Maxima	P03A
Gwint	Metryczny	  
Materiał	Stal	
Obróbka powierzchni	Ocynkowane	



Końcowe obliczenia powinny być zgodne z pełnym Europejskim Zatwierdzeniem Technicznym (ETA),
zatwierdzenie to jest również dostępne na żądanie.

Typ	☒	Kod artykułu	Typ	☒	Kod artykułu	Typ	☒	Kod artykułu
M8	10	70636.080.001	M16	10	70636.160.001	M24	10	70636.240.001
M10	10	70636.100.001	M20	10	70636.200.001	M30	5	70636.300.001
M12	10	70636.120.001						

• Tylko pełne opakowania.

70646	SPIT Kotwa gwintowana dwustronnie Maxima	P03B
Gwint	Metryczny	  
Materiał	Stal nierdzewna A4	

Typ	☒	Kod artykułu	Typ	☒	Kod artykułu	Typ	☒	Kod artykułu
M8	10	70646.080.001	M12	10	70646.120.001	M20	10	70646.200.001
M10	10	70646.100.001	M16	10	70646.160.001	M24	10	70646.240.001

Narzędzia montażowe

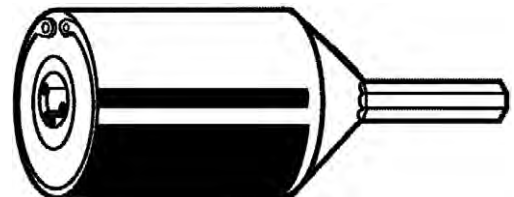

8

Kolejność montażu

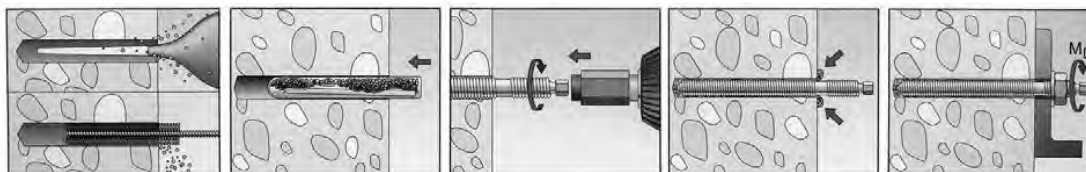

63189	FISCHER Narzędzia montażowe	N03B
		 

Typ	☒	Kod artykułu	Typ	☒	Kod artykułu	Typ	☒	Kod artykułu
M8	1	63189.080.001	M12	1	63189.120.001	M20	1	63189.200.001
M10	1	63189.100.001	M16	1	63189.160.001			

Kapsuły kotwowe do mocowania chemicznego, typy RM/EA

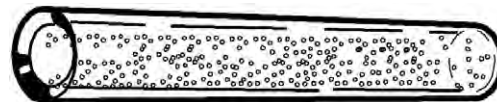
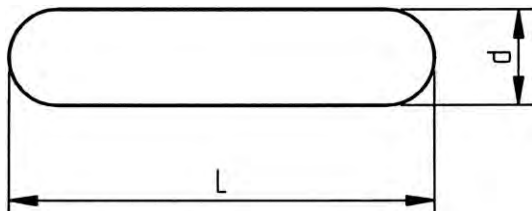



Informacje techniczne

Typ	d	Głębokość wiercenia (min.)	L	Wiertło \varnothing
M8	9	80	80	10
M10	10.5	90	85	12
M12	12.5	110	95	14
M16	16.5	125	95	18
M20	23	170	160	25
M24	23	210	190	28
M30	27.5	280	260	35

- Dla pełnego mocowania chemicznego należy zamówić oddzielnie kapsułę i gwintowaną śrubę dwustronną (w tym nakrętkę i podkładkę).

Grupy katalogowe

Materiał	Kod	Strona
Szkło	63186	8-82
Szkło	70615	8-83

63186 FISCHER Kapsuły kotwowe do mocowania chemicznego żywicą, typ RM		N03A
Materiał	Szkło	 



Końcowe obliczenia powinny być zgodne z pełnym Europejskim Zatwierdzeniem Technicznym (ETA), zatwierdzenie to jest również dostępne na żądanie.

Typ	☒	Kod artykułu	Typ	☒	Kod artykułu	Typ	☒	Kod artykułu
R M8	10	63186.080.001	R M16	10	63186.160.001	R M24	5	63186.240.001
R M10	10	63186.100.001	R M20	10	63186.200.001	R M30	5	63186.300.001
R M12	10	63186.120.001						

- Tylko pełne opakowania.

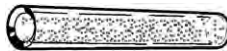
70615	SPIT Kapsuły kotwowe do mocowania chemicznego żywicą, typ EA	P03A
Materiał	Szkło	 



Końcowe obliczenia powinny być zgodne z pełnym Europejskim Zatwierdzeniem Technicznym (ETA),
zatwierdzenie to jest również dostępne na żądanie.

Typ	☒	Kod artykułu	Typ	☒	Kod artykułu	Typ	☒	Kod artykułu
M8	10	70615.080.001	M16	10	70615.160.001	M24	10	70615.240.001
M10	10	70615.100.001	M20	10	70615.200.001	M30	5	70615.300.001
M12	10	70615.120.001						

- Tylko pełne opakowania.

Zaprawy chemiczne

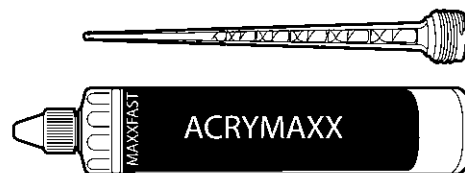

Kolejność montażu

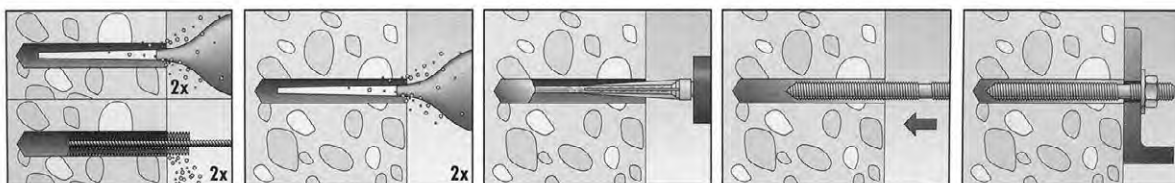

Grupy katalogowe

	Kod	Strona
VinyMaxx	30581	8-83
AcryMaxx	30580	8-84
FIS VS	63252	8-84
FIS V	63051	8-84
FIS VS	63060	8-84

30581	MAXXFAST Dodatki chemiczne VinyMaxx	MF40
	 	

Typ	☒	Kod artykułu	
VinyMaxx	1	30581.000.310	<ul style="list-style-type: none"> • Wysokowydajna masa żywiczna niezawierająca styrenu do zastosowania w materiałach pełnych i kratowanych. • 310 ml. 

30580	MAXXFAST Dodatki chemiczne AcryMaxx	MF40



Końcowe obliczenia powinny być zgodne z pełnym Europejskim Zatwierdzeniem Technicznym (ETA),
zatwierdzenie to jest również dostępne na żądanie.

Typ		Kod artykułu		
AcryMaxx	✉	30580.000.310	<ul style="list-style-type: none"> Wysokowydajna masa żywiczna niezawierająca styrenu do kotwienia prętów gwintowanych i gniazd gwintowanych wewnętrznie. Europejska Aprobata Techniczna i oznaczenie CE. Odporna na ekstremalne temperatury (-40° do +80°st. Celsjusza) po polimeryzacji. 310 ml. 	

63252	FISCHER Dodatki chemiczne	N03A

Typ		Kod artykułu	Typ		Kod artykułu	Typ		Kod artykułu
FIS VS 300 T	✉	63252.000.300	FIS P 300 T	✉	63252.441.030	FIS VT300T	✉	63252.520.020
<ul style="list-style-type: none"> FIS VS300 T= ETA1 FIS P300T ≠ ETA FIS VT300T= ETA7 								

63051	FISCHER Dodatki chemiczne	N03A

Typ		Kod artykułu	Typ		Kod artykułu
V360S=FIS	✉	63051.000.360	VT380C=FIS	✉	63051.000.380
<ul style="list-style-type: none"> V360S=FIS= ETA1 VT380C=FIS= ETA7 					

63060	FISCHER Dodatki chemiczne	N03A

Typ		Kod artykułu
VS150C	✉	63060.000.150
VS150C= ETA1		

Narzędzia do montażu zapraw chemicznych

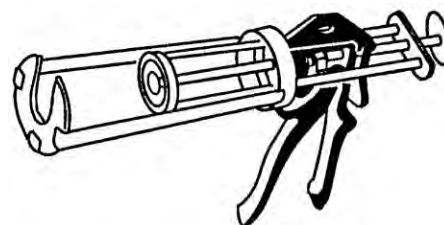

Grupy katalogowe

Kod	Strona
30595	8-85
63691	8-85
63243	8-85

30595 MAXXFAST Narzędzia do montażu zapraw chemicznych

MFN0

MAXXFAST
PROFESSIONAL HARDWARE



Typ	Kod artykułu
Pistolet	1 30595.000.100

63691 FISCHER Narzędzia do montażu zapraw chemicznych

N03C

fischer
innovative solutions



Typ	Kod artykułu	
FIS AM	1 63691.100.015	• Odpowiednie dla dodatków chemicznych wprowadzanych type FIS V 360 S, FIS HB 345 S, FIS EM 390 S, FIS VS 150C & PU foam.
FIS AC	1 63691.100.020	• Odpowiednie dla dodatków chemicznych wprowadzanych, typ FIS P 380 C, FIS VT 380 C, FIS V410 C.
KP M 2	1 63691.100.035	• Odpowiednie dla dodatków chemicznych wprowadzanych, typ FIS V410 C, FIS V T 380 C, FIP C 700 HO, PE 410 SF.



63243 FISCHER Narzędzia do montażu zapraw chemicznych

N03A

fischer
innovative solutions



Typ	Kod artykułu
14/20 MM	1 63243.014.020

Akcesoria mocujące

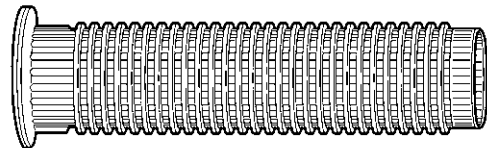
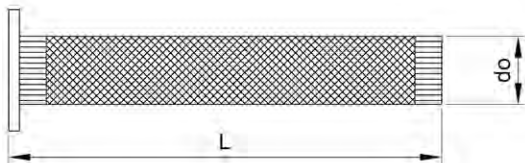

Informacje techniczne

Typ	12x50	15x85	15x130	20x85
d _o	12	15	15	20
Głębokość montażu (min.)	50	85	130	85
Głębokość wiercenia (min.)	60	95	140	95
L	50	85	130	85
Rozmiar pręta gwintowanego	M6	M8-M10-M12	M8-M10-M12	M12-M16
Wiertło ø	12	15	15	20

30596 MAXXFAST Akcesoria mocujące

MFN0

MAXXFAST
PROFESSIONAL HARDWARE

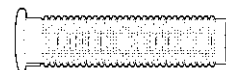

Typ	☒	Kod artykułu	
Pompka	1	30596.000.001	• Plastikowy
Dysza mieszająca	5	30596.000.005	• Plastikowy
Szczotka biała	1	30596.008.012	• 8-12mm
Szczotka niebieska	1	30596.010.018	• 10-18mm
Szczotka czerwona	1	30596.012.028	• 12-28mm
Mocowanie	10	30596.012.050	• Plastikowe Nylon (poliamid) • 12x50
Mocowanie	10	30596.015.085	• Plastikowe Nylon (poliamid) • 15x85
Mocowanie	10	30596.015.130	• Plastikowe Nylon (poliamid) • 15x130
Mocowanie	10	30596.020.085	• Plastikowe Nylon (poliamid) • 20x85

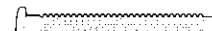
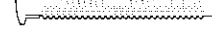
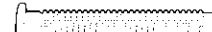
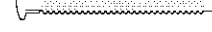

Kotwy tulejkowe, typ FIS H N

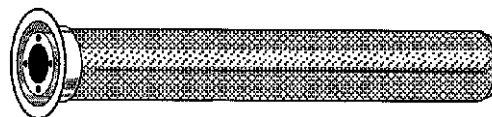

Informacje techniczne

Typ	FIS H16 x 85N	FIS H18 x 85N	FIS H20 x 85N	FIS H12 X 1000	FIS H16 X 1000	FIS H22 X 1000
d	16	18	20	12	16	22
Głębokość montażu (min.)	85	85	85	-	-	-
Głębokość wiercenia (min.)	95	95	95	-	-	-
L	85	85	85	1000	1000	1000
Rozmiar pręta gwintowanego	M8	M10	M12	M6-M8	M10-M12	M12-M16
Wiertło \varnothing	16	18	20	12	16	22

Kolejność montażu

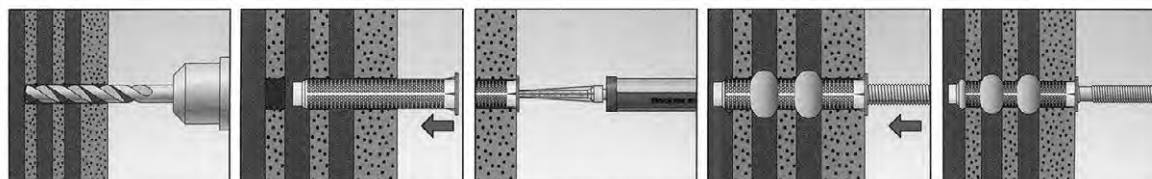

Grupy katalogowe

Materiał	Obróbka powierzchni	Kod	Strona
Plastik PA		63052	8-87
St	Ocynk.	63050	8-87

63052 FISCHER Kotwy tulejkowe, typ FIS H N			N03A
Materiał	Plastik Poliamid (nylon)		
Typ	⊗	Kod artykułu	
FIS16X85MM	20	63052.160.085	
FIS18X85MM	20	63052.180.085	
FIS20X85MM	20	63052.200.085	

63050 FISCHER Kotwy tulejkowe, typ FIS H L			N03A
Materiał	Stal		
Obróbka powierzchni	Ocynkowane		
d x L	⊗	Kod artykułu	
12X1000MM	10	63050.120.001	
16X1000MM	10	63050.160.001	
22X1000MM	6	63050.220.001	

Kotwy gwintowane wewnętrznie, mocowane chemicznie, typ RG MI

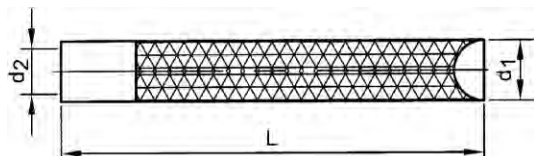

Informacje techniczne

Typ	RG 8x75 M5 I	RG 10x75 M6 I	RG 12x90 M8 I	RG 16x90 M10 I	RG 18x125 M12 I
d ₁	8	10	12	16	18
d ₂	M5	M6	M8	M10	M12
Efektywna głębokość kotwienia (h _{gr})	75	75	90	90	125
Głębokość wierzonego otworu do najgłębszego punktu (h _o)	75	75	90	90	125
Głębokość wkręcania (min.-maks.)	8-14	10-16	12-18	15-23	18-26
L	75	75	75	75	75
Minimalna grubość podpory betonowej (h _{min})	120	120	120	120	170
Minimalna odległość krawędzi (C _{min})	40	45	45	45	60
Minimalny odstęp (S _{min})	40	45	45	45	60
N=Dopuszczalne obciążenie w kN	3,4	4,8	9,1	14,4	21,1

- Dopuszczalne obciążenie jest ważne dla jednej kotwy, przy niepekniętym betonie (strefa nacisku) z klasą betonu C20/25, w połączeniu z klasą śruby 5.8 i jeżeli S_{gr}, N i C_{gr}, N są wzięte pod uwagę. Kiedy mają miejsce zmniejszenie odstępu i odległości krawędzi, należy przeprowadzić ponowne obliczenie sił.
- Dla pełnego mocowania chemicznego należy zamówić oddzielnie kapsułę z żywicą i gwintowaną śrubę dwustronną (w tym nakrętkę i podkładkę). W każdym opakowaniu umieszczone jest narzędzie montażowe.

Kolejność montażu



63227 FISCHER Kotwy gwintowane wewnętrznie, mocowane chemicznie, typ RG MI

N03A

Gwint Metryczny
Materiał Stal
Obróbka powierzchni O cynkowane

fischer
innovative solutions



Typ	☒	Kod artykułu	Typ	☒	Kod artykułu	Typ	☒	Kod artykułu
RG 8X75 M5 I	10	63227.050.001	RG 12X90 M8 I	10	63227.080.090	RG 18X125 M12 I	10	63227.120.100
RG 10X75 M6 I	10	63227.060.001	RG 16X90 M10 I	10	63227.100.090			

Śruby fundamentowe zamknięte, typ A

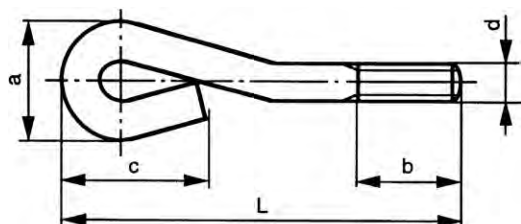

DIN 529 A
NEN 2328 A



Informacje techniczne

d	a	b	c	P
M12	36	30	65	1.75
M16	48	40	85	2
M20	60	50	105	2.5
M24	75	60	125	3
M30	95	75	155	3.5

20710 Śruby fundamentowe zamknięte, typ A

G06D

Gwint Metryczny
Material Stal
Klasa 4.6



d x L	☒	Kod artykułu	d x L	☒	Kod artykułu	d x L	☒	Kod artykułu
M12X160	25	20710.120.160	M16X400	10	20710.160.400	M24X250	3	20710.240.250
M12X200	25	20710.120.200	M20X200	5	20710.200.200	M24X320	3	20710.240.320
M12X250	25	20710.120.250	M20X250	5	20710.200.250	M24X400	3	20710.240.400
M16X160	10	20710.160.160	M20X320	5	20710.200.320	M24X500	3	20710.240.500
M16X200	10	20710.160.200	M20X400	5	20710.200.400	M30X400	2	20710.300.400
M16X250	10	20710.160.250	M20X500	5	20710.200.500	M30X500	2	20710.300.500
M16X320	10	20710.160.320				M30X630	2	20710.300.630

Śruby kotwowe, typ E

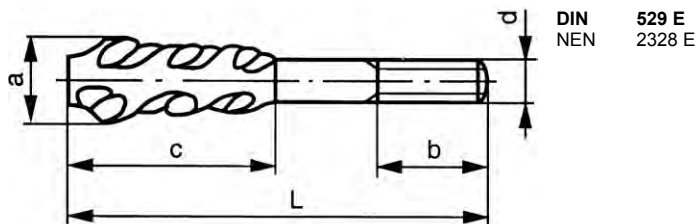

DIN 529 E
NEN 2328 E

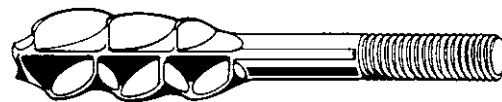

Informacje techniczne

d	a	b	c	P
M10	20	25	55	1.5
M12	24	30	70	1.75
M16	32	40	90	2
M20	40	50	100	2.5
M24	48	60	135	3
M30	60	75	150	3.5

20750 Śruby kotwowe, typ E

G06D

Gwint Metryczny
Materiał Stal
Klasa 3.6
Obróbka powierzchni O cynkowane



d x L	☒	Kod artykułu	d x L	☒	Kod artykułu	d x L	☒	Kod artykułu
M10X125	25	20750.100.125	M20X200	5	20750.200.200	M24X320	3	20750.240.320
M12X125	25	20750.120.125	M20X320	5	20750.200.320	M30X320	2	20750.300.320
M16X160	10	20750.160.160	M24X250	3	20750.240.250	M30X630	2	20750.300.630

Kotwy z hakiem prostym

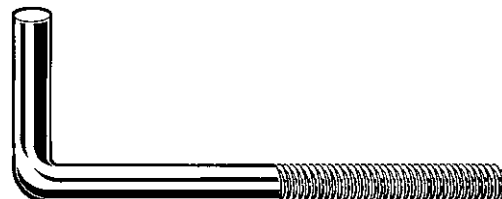
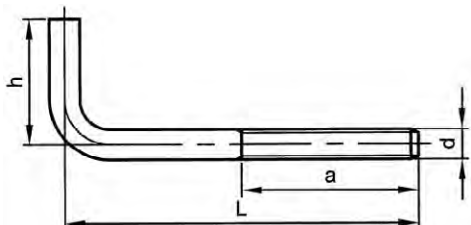

Informacje techniczne

d	a	P
M10	150	1.5
M12	150	1.75
M16	150	2
M20	150	2.5
M24	150	3
M30	150	3.5

• Stal z wytrzymałością na rozciąganie min. 400 N/mm² i niższą granicą plastyczności min. 240 N/mm².

Grupy katalogowe

Gwint	Materiał	Klasa	Obróbka powierzchni	Kod	Strona
M	St			hak 50 mm	20610 8-91
M	St		O cynk.	hak 50 mm	20630 8-91
M	St		O cynk. gor.	hak 50 mm	20650 8-91
M	St			hak 100 mm	20620 8-91
M	St		O cynk.	hak 100 mm	20640 8-91
M	St		O cynk. gor.	hak 100 mm	20660 8-92
M	St	8.8	O cynk. gor.	hak 100 mm	20661 8-92

20610 Kotwy z hakiem prostym, długość haka 50 mm G06D

Gwint Metryczny
 Materiał Stal



d x L	☒	Kod artykułu	d x L	☒	Kod artykułu	d x L	☒	Kod artykułu
M10X200	1	20610.100.200	M16X250	1	20610.160.250	M16X450	1	20610.160.450
M10X300	1	20610.100.300	M16X300	1	20610.160.300	M20X400	1	20610.200.400
M12X300	1	20610.120.300	M16X350	1	20610.160.350	M20X450	1	20610.200.450
M12X400	1	20610.120.400	M16X400	1	20610.160.400			

20630 Kotwy z hakiem prostym, długość haka 50 mm G06D

Gwint Metryczny
 Materiał Stal
 Obróbka powierzchni O cynkowane



d x L	☒	Kod artykułu	d x L	☒	Kod artykułu	d x L	☒	Kod artykułu
M10X200	1	20630.100.200	M16X300	1	20630.160.300	M20X350	1	20630.200.350
M12X250	1	20630.120.250	M16X350	1	20630.160.350	M20X400	1	20630.200.400
M16X250	1	20630.160.250	M16X400	1	20630.160.400	M20X450	1	20630.200.450
			M16X450	1	20630.160.450			
			M16X500	1	20630.160.500			

20650 Kotwy z hakiem prostym z nadwymiarowym gwintem, długość haka 50 mm G06D

Gwint Metryczny
 Materiał Stal
 Obróbka powierzchni O cynkowane na gorąco



d x L	☒	Kod artykułu	d x L	☒	Kod artykułu	d x L	☒	Kod artykułu
M12X300	1	20650.120.300	M16X350	1	20650.160.350	M20X350	1	20650.200.350
M12X400	1	20650.120.400	M16X400	1	20650.160.400	M20X400	1	20650.200.400
M16X300	1	20650.160.300	M16X450	1	20650.160.450	M20X450	1	20650.200.450
			M16X500	1	20650.160.500			

20620 Kotwy z hakiem prostym, długość haka 100 mm G06D

Gwint Metryczny
 Materiał Stal



d x L	☒	Kod artykułu	d x L	☒	Kod artykułu	d x L	☒	Kod artykułu
M16X300	1	20620.160.300	M20X400	1	20620.200.400	M24X600	1	20620.240.600
M16X400	1	20620.160.400	M20X500	1	20620.200.500	M24X700	1	20620.240.700
M16X500	1	20620.160.500	M20X600	1	20620.200.600	M24X800	1	20620.240.800
M16X600	1	20620.160.600	M20X700	1	20620.200.700			
M16X700	1	20620.160.700	M20X800	1	20620.200.800	M30X500	1	20620.300.500
M16X800	1	20620.160.800				M30X600	1	20620.300.600
M20X300	1	20620.200.300	M24X400	1	20620.240.400	M30X700	1	20620.300.700
			M24X500	1	20620.240.500			

20640 Kotwy z hakiem prostym, długość haka 100 mm G06D

Gwint Metryczny
 Materiał Stal
 Obróbka powierzchni O cynkowane



d x L	☒	Kod artykułu	d x L	☒	Kod artykułu	d x L	☒	Kod artykułu
M12X300	1	20640.120.300	M16X300	1	20640.160.300	M16X800	1	20640.160.800
M12X400	1	20640.120.400	M16X400	1	20640.160.400	M20X300	1	20640.200.300
M12X500	1	20640.120.500	M16X500	1	20640.160.500	M20X400	1	20640.200.400
M12X600	1	20640.120.600	M16X600	1	20640.160.600	M20X500	1	20640.200.500
			M16X700	1	20640.160.700			

20640 Kotwy z hakiem prostym, długość haka 100 mm								
d x L	☒	Kod artykułu	d x L	☒	Kod artykułu	d x L	☒	Kod artykułu
M20X600	1	20640.200.600	M24X500	1	20640.240.500	M30X500	1	20640.300.500
M20X700	1	20640.200.700	M24X600	1	20640.240.600	M30X600	1	20640.300.600
M20X800	1	20640.200.800	M24X700	1	20640.240.700	M30X700	1	20640.300.700
M24X400	1	20640.240.400	M24X800	1	20640.240.800	M30X800	1	20640.300.800

20660 Kotwy z hakiem prostym z nadwymiarowym gwintem, długość haka 100 mm							
Gwint	Metryczny						
Materiał	Stal						
Obróbka powierzchni	Ocynkowane na gorąco						

d x L	☒	Kod artykułu	d x L	☒	Kod artykułu	d x L	☒	Kod artykułu
M12X300	1	20660.120.300	M16X800	1	20660.160.800	M24X500	1	20660.240.500
M12X400	1	20660.120.400	M20X300	1	20660.200.300	M24X600	1	20660.240.600
M12X500	1	20660.120.500	M20X400	1	20660.200.400	M24X700	1	20660.240.700
M12X600	1	20660.120.600	M20X500	1	20660.200.500	M24X800	1	20660.240.800
M16X300	1	20660.160.300	M20X600	1	20660.200.600	M30X500	1	20660.300.500
M16X400	1	20660.160.400	M20X700	1	20660.200.700	M30X600	1	20660.300.600
M16X500	1	20660.160.500	M20X800	1	20660.200.800	M30X700	1	20660.300.700
M16X600	1	20660.160.600	M24X400	1	20660.240.400	M30X800	1	20660.300.800
M16X700	1	20660.160.700						

20661 Kotwy z hakiem prostym z nadwymiarowym gwintem, długość haka 100 mm							
Gwint	Metryczny						
Materiał	Stal						
Klasa	8.8						
Obróbka powierzchni	Ocynkowane na gorąco						

d x L	☒	Kod artykułu	d x L	☒	Kod artykułu	d x L	☒	Kod artykułu
M16X400	1	20661.160.400	M20X400	1	20661.200.400	M24X400	1	20661.240.400
M16X500	1	20661.160.500	M20X500	1	20661.200.500	M24X500	1	20661.240.500
M16X600	1	20661.160.600	M20X600	1	20661.200.600	M24X600	1	20661.240.600

Pręty gwintowane do szalowania

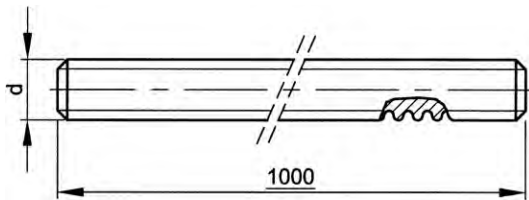

- Cechy specjalne prętów gwintowanych do szalowania:
- Są wlewane w beton bez zastosowania kołnierzy plastikowych czy podobnych rozwiązań.
- Po utwardzeniu betonu pręt gwintowany może zostać obłuzowany przez uderzenie młotkiem i wyjęty.
- Beton nie przylega dobrze do gwintowanego profilu, więc czyszczenie prętów nie jest konieczne, i możliwe jest ich ponowne wykorzystanie.
- Zaprawa do późniejszego przykrycia otworu przylega bardzo dobrze (kontr-profil gwintu w betonie).

20420 Pręty gwintowane, długość 1m, do szalowania		G05B
Materiał	Stal	
Klasa	≥4.8	

d	☒	Kod artykułu	d	☒	Kod artykułu	d	☒	Kod artykułu
20MM	4	20420.200.001	24MM	4	20420.240.001	30MM	2	20420.300.001

Nakrętki do prętów gwintowanych do szalowania - KN

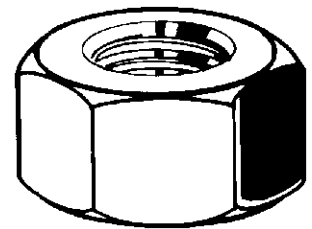
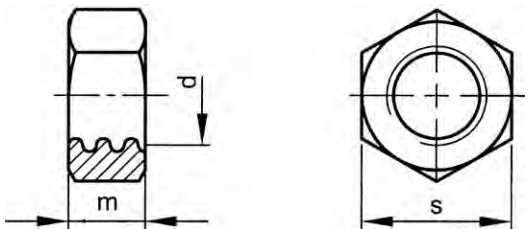

Informacje techniczne			
d	m	P	s
20	16	5	30
24	19	5	36
30	24	5	46

- Cechy specjalne prętów gwintowanych do szalowania:
- Są wlewane w beton bez zastosowania kołnierzy plastikowych czy podobnych rozwiązań.
- Po nakrochmaleniu betonu pręt gwintowany może zostać obłuzowany przez uderzenie młotkiem i wyjęty.
- Beton nie przylega dobrze do gwintowanego profilu, więc czyszczenie prętów nie jest konieczne, i możliwe jest ich ponowne wykorzystanie.
- Zaprawa do późniejszego przykrycia otworu przylega bardzo dobrze (kontr-profil gwintu w betonie).

20430 Nakrętki do prętów gwintowanych do szalowania - KN		G05B
Materiał	Stal	
Klasa	5	

d	☒	Kod artykułu	d	☒	Kod artykułu	d	☒	Kod artykułu
20MM	8	20430.200.001	24MM	8	20430.240.001	30MM	4	20430.300.001

Kotwy mocujące DEMU – systematyczne rozwiązania mocowania

Kotwy mocujące DEMU z gwintem wewnętrznym są dedykowane do stałych zakotwień w warunkach przeważająco statycznych lub quasi-statycznych w betonie zbrojonym lub niezbrojonym o masie normalnej, w klasach wytrzymałości C20/25 do C90/105. Mogą być stosowane w betonie spękanym bądź niespękanym dla przeniesienia obciążeń rozciągających, obciążeń ścinających lub kombinacji obu powyższych.

Kotwy tulejowe VEMO

Informacje ogólne:

Kotwy tulejowe VEMO to kotwy mocujące nisko-obciążeniowe stosowane głównie dla zamocowań tymczasowych i zastosowań o znikomym znaczeniu konstrukcyjnym. Aktualnie dla większości kotew tulejowych nie istnieje metoda obliczania współczynnika obciążalności.

Ochrona antykorozyjna:

- Cynkowanie galwaniczne (GV) – powierzchnia kotew tulejowych jest cynkowana galwanicznie (wolne od chromu VI) na grubość powłoki około 5–8 µm celem przeciwdziałania nieznacznej ekspozycji na korozję (suche pomieszczenia wewnętrzne).
- Stal nierdzewna (A4) – kotwy tulejowe w wykonaniu A4 produkowane są ze stali nierdzewnej dając wysoki poziom zabezpieczenia przeciwko średniej ekspozycji na korozję (atmosfera zewnętrzna).

Różne rodzaje:

995-GB GV, 995 A4, 995-G GV / A4, 995-DG GV, 1036-G GV / A4, 1130 GV, 1140 GV / A4

Dostępne wielkości gwintu:

M6, M8, M10, M12, M16, M20, M24 and M30

Przykłady zastosowań:

Mocowanie regulowanych podpór budowlanych na elementach prefabrykowanych, osadzanie okien, mocowanie maszyn do fundamentu (bez obciążenia dynamicznego), tymczasowe usztywnianie elementów prefabrykowanych, itp.



Tulejki łączące, typ 1550

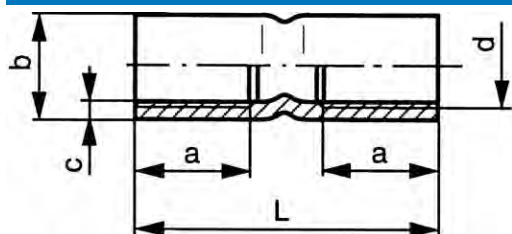

Informacje techniczne

d	a	b	c	Obciążenie rozciągające kN	P
M12	18	15.5	2.5	39	1.75
M16	24	21	3.4	75	2
M20	30	26	4.2	115	2.5

18550 VEMO Tulejki łączące, typ 1550

P07A

Gwint Metryczny
 Materiał Stal
 Obróbka powierzchni Ocynkowane



d x L	☒	Kod artykułu	d x L	☒	Kod artykułu	d x L	☒	Kod artykułu
M12X35	200	18550.120.035	M16X45	200	18550.160.045	M20X55	100	18550.200.055

Tulejki

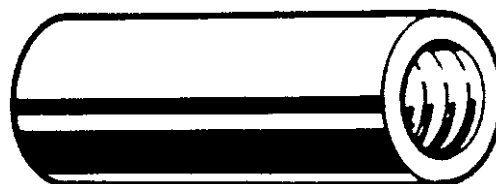
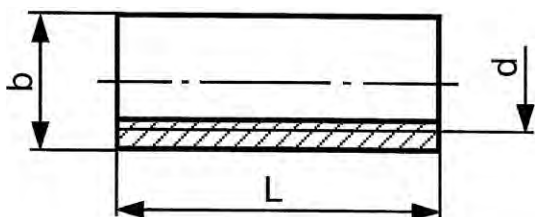

Informacje techniczne

d	b	Obciążenie rozciągające kN	P
M6	10	13	1
M8	12	16	1.25
M10	13	14	1.5
M12	15.5	39	1.75
M16	21	75	2
M20	26	115	2.5
M24	32	181	3
M30	40	284	3.5

18570 VEMO Tulejki, typ 1551

P07A

Gwint Metryczny
 Materiał Stal
 Obróbka powierzchni Ocynkowane



d x L	☒	Kod artykułu	d x L	☒	Kod artykułu	d x L	☒	Kod artykułu
M6X15	200	18570.060.015	M12X35	200	18570.120.035	M24X70	50	18570.240.070
M8X20	200	18570.080.020	M16X45	200	18570.160.045	M30X90	25	18570.300.090
M10X25	200	18570.100.025	M20X55	100	18570.200.055			

Wkładki z końcówką wygiętą pod kątem 90°, typ 1140

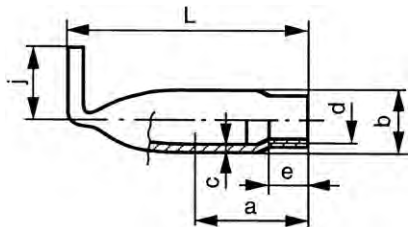

Informacje techniczne

d	M10	M12	M16
a	35	40	32
b	13.5	17	21.3
c	1.5	2	3.2
e	10	12	16
j	25	30	35

Siła wyciągająca w kN

Beton	24	32	52
-------	----	----	----

- Siła potrzebna do wyciągnięcia, w kN.
- Zaleca się współczynnik bezpieczeństwa wynoszący 4.

18120 VEMO Wkładki z końcówką wygiętą pod kątem 90°, typ 1140

P07A

Gwint Metryczny
 Materiał Stal
 Obróbka powierzchni Ocynkowane



d x L	☒	Kod artykułu	d x L	☒	Kod artykułu	d x L	☒	Kod artykułu
M10X60	400	18120.100.060	M12X70	200	18120.120.070	M16X100	100	18120.160.100

Wkładki z końcówką wygiętą pod kątem 90°, z płytką do wbijania gwoździ, typ 1130

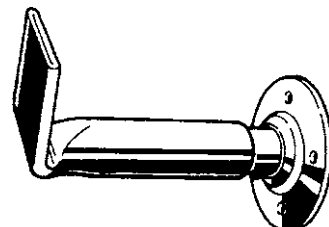
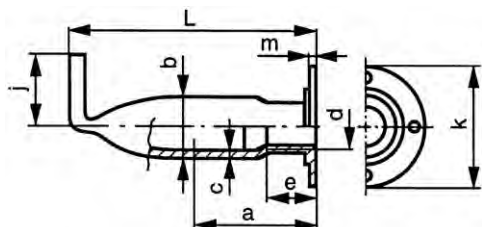

Informacje techniczne

d	M10	M12	M16	M20
a	35	40	32	40
b	13.5	17	21.3	26.9
c	1.5	2	2.6	2.6
e	10	12	16	20
j	25	30	35	35
k	34	40	44	48
m	1	1	1.5	1.5

Siła wyciągająca w kN

Beton	24	32	52	64
-------	----	----	----	----

- Zaleca się współczynnik bezpieczeństwa wynoszący 4.

18140 VEMO Wkładki z końcówką wygiętą pod kątem 90°, z płytką do wbijania gwoździ, typ 1130

P07A

Gwint Metryczny
 Materiał Stal
 Obróbka powierzchni Ocynkowane

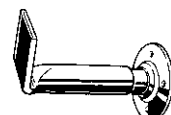

d x L	☒	Kod artykułu	d x L	☒	Kod artykułu	d x L	☒	Kod artykułu
M10X60	400	18140.100.060	M12X70	200	18140.120.070	M16X100	100	18140.160.100

Wkładki z otworem, typ 995G

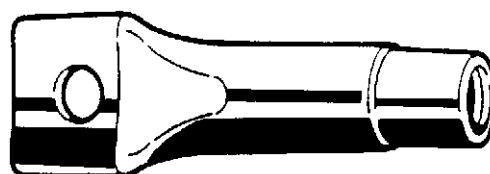
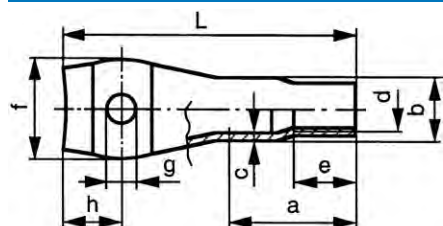

Informacje techniczne

d	M6	M8	M10	M12	M16	M16	M20	M24	M30
a	20	25	20	23	25	32	40	50	70
b	8.5	10.5	13.5	17	21.3	21.3	26.9	33.7	42
c	1	1	1.5	2	3.2	3.2	3.2	4	4
e	6	8	10	12	16	16	20	24	30
f	12.5	16	20	25	30	30	39	48	64
g	6.0	8.1	6.2	7.2	9.2	9.2	12.2	14.2	15.2
h	7	8	12	15	17	22	22	25	25
L	40	50	50	60	70	100	100	120	150
Siła wyciągająca w kN									
Beton	6	10	14	20	28	40	50	72	110

- Zaleca się współczynnik bezpieczeństwa wynoszący 4.

18040 VEMO Wkładki z otworem, typ 995G

P07A

Gwint Metryczny
 Materiał Stal
 Obróbka powierzchni Ocynkowane



d x L	☒	Kod artykułu	d x L	☒	Kod artykułu	d x L	☒	Kod artykułu
M6X40	500	18040.060.040	M12X60	400	18040.120.060	M20X100	100	18040.200.100
M8X50	500	18040.080.050	M16X70	200	18040.160.070	M24X120	50	18040.240.120
M10X50	500	18040.100.050	M16X100	100	18040.160.100	M30X150	25	18040.300.150

Wkładki z płytką do wbijania gwoździ, typ 1036

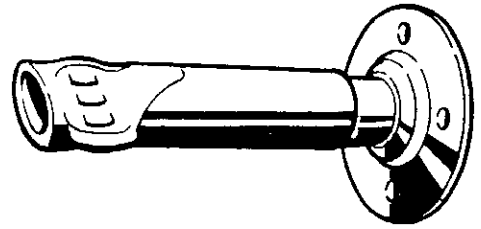
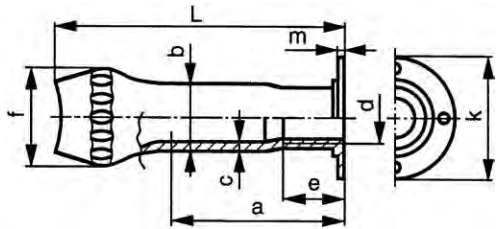

Informacje techniczne

d	M10	M12	M16	M20	M24
a	30	40	32	50	40
b	13.5	17	21.3	26.9	33.7
c	1.5	2	2.6	2.6	4
e	10	12	16	20	24
f	20	25	31	39	48
k	34	40	44	48	57
m	1	1	1.5	1.5	1.5
Siła wyciągająca w kN					
Beton	16	24	40	50	64

- Zaleca się współczynnik bezpieczeństwa wynoszący 4.

18060 VEMO Wkładki z płytką do wbijania gwoździ, typ 1036

P07A

Gwint Metryczny
 Materiał Stal
 Obróbka powierzchni Ocynkowane

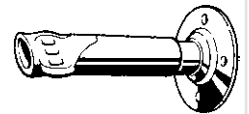

d x L	☒	Kod artykułu	d x L	☒	Kod artykułu	d x L	☒	Kod artykułu
M10X50	200	18060.100.050	M16X100	100	18060.160.100	M24X120	50	18060.240.120
M12X70	200	18060.120.070	M20X100	100	18060.200.100			

Korki do rur

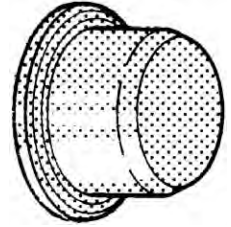
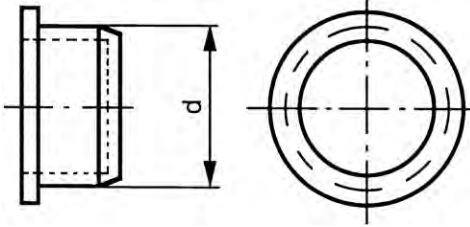

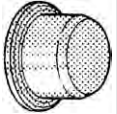
18600	VEMO Korki do rur Nr 2244	P07A
Materiał	Plastik Polietylen	
		

d = Dla wymiaru nominalnego	⊗	Kod artykułu	d = Dla wymiaru nominalnego	⊗	Kod artykułu	d = Dla wymiaru nominalnego	⊗	Kod artykułu
M6-Czerwony	100	18600.060.001	M12-Czerwony	100	18600.120.001	M24-Czerwony	100	18600.240.001
M8-Czerwony	100	18600.080.001	M16-Czarny	100	18600.160.001			
M10-Czerwony	100	18600.100.001	M20-Niebieski	100	18600.200.001			

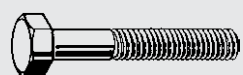

1 Śruby

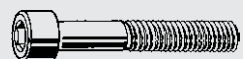

2 Produkty z gniazdem sześciokątnym



3 Nakrętki, nitonakrętki & wkładki



4 Pręty gwintowane & śruby dwustronne



5 Haki & śruby oczkowe



6 Wkręty

I Index



7 Podkładki & pierścienie uszczelniające typu “O-ring”



8 Kotwy, kołki, dyble

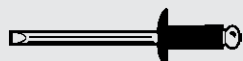

9 Nity, kołki & wpusty



10 Elementy łączące systemowe, meblowe & zabezpieczające



11 Zestawy

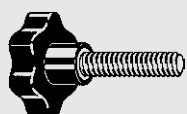



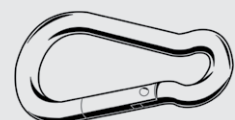







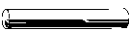
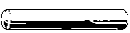
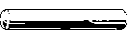
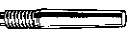
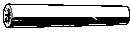
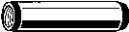
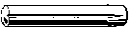



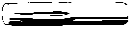
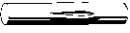
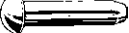









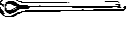











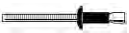

12 Części konstrukcyjne & części maszynowe



13 Przemysł morski

T Technologia łączenia

Nity, kołki & wpusty⁹

 Strona 9-3 DIN 1 B Stożkowe	 Strona 9-5 DIN 7 Walcowe	 Strona 9-8 DIN 6325 Walcowe, tolerancja m6	 Strona 9-9 DIN ≈6325 Walcowe, tolerancja h6	 Strona 9-10 DIN 7977 Stożkowe z czopem gwintowanym
 Strona 9-11 DIN 7978 A Stożkowe z gwintem wewnętrznym	 Strona 9-12 DIN 7979 D Walcowe z gwintem wewnętrznym	 Strona 9-13 DIN 1470 Z karami równoległymi na całej długości	 Strona 9-14 DIN 1471 Z karami zbieżnymi na całej długości	 Strona 9-15 DIN 1472 Z karami zbieżnymi na połowie długości
 Strona 9-17 DIN 1473 Z karami równoległymi na całej długości	 Strona 9-18 DIN 1474 Z karami na 1/2 dł. zbieżnymi do środka	 Strona 9-20 DIN 1475 Z karami w środkowej części na 1/3 długości	 Strona 9-21 DIN 1476 Nitokołki z łbem kulistym	 Strona 9-22 Nitokręt
 Strona 9-23 ISO 8750 Sprężyste zwijane	 Strona 9-24 ISO ≈8750 Sprężyste zwijane, stal nierdzewna	 Strona 9-25 ISO 8748 Sprężyste zwijane, wzmocnione	 Strona 9-26 ISO 8752 Sprężyste rozcięte, wzmocnione	 Strona 9-28 ISO 13337 Sprężyste rozcięte, typ lekki
 Strona 9-29 DIN ≈1481 Sprężyste rozcięte, stal nierdzewna	 Strona 9-31 DIN 660/124 Łeb kulisty	 Strona 9-33 DIN 661/302 Łeb stożkowy płaski	 Strona 9-35 DIN 1434 Sworznie z otworem na zawleczkę	 Strona 9-36 DIN 94 Zawleczki
 Strona 9-41 DIN ≈11024 Zawleczki pojedyncze	 Strona 9-42 DIN ≈11024 Zawleczki podwójne	 Strona 9-43 DIN 11024 Zawleczki podwójne A4	 Strona 9-44 Zawleczki do rur	 Strona 9-45 Zawleczki z pierścieniem
 Strona 9-46 DIN 6885 A Wpusty pryzmatyczne	 Strona 9-49 DIN 6880 Wpusty pryzmatyczne	 Strona 9-50 DIN 6888 Wpusty czółenkowe	 Strona 9-51 DIN 6887 Łeb klinowy	 Strona 9-54 Nity zrywalne
 Strona 9-60 Nity zrywalne kołnierz powiększony	 Strona 9-62 Nity zrywalne kołnierz stożkowy	 Strona 9-64 Nity zrywalne PLUS BULB	 Strona 9-65 Nity zrywalne PLUS BULB	 Strona 9-66 Nity zrywalne P-LOCK
 Strona 9-67 Nity zrywalne PLUS BULB k.stożkowy	 Strona 9-67 Nity zrywalne z zaślepką	 Strona 9-68 DIN ≈7337 A Nity zrywalne MULTI	 Strona 9-69 Nity zrywalne MULTI k.powiększony	 Strona 9-70 MULTI nity szerokozakresowe
 Strona 9-71 MULTI nity szerokozakresowe, kołn. pow.	 Strona 9-72 Nity zrywalne MULTI k.stożkowy	 Strona 9-73 Nity zrywalne szczelne SIGMA	 Strona 9-76 Nity zrywalne szczelne SIGMA k.stożkowy	 Strona 9-77 Nity zrywalne EXPO rozprężne

<p>Strona 9-78</p>  <p>Nity zrywalne TRIPO rozprężne</p>	<p>Strona 9-79</p>  <p>Nitownice</p>	<p>Strona 9-80</p>  <p>Zestawy do nitowania</p>
---	---	--

Kołki stożkowe toczone

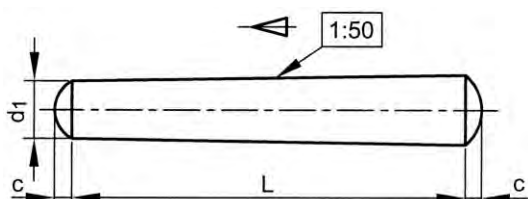

DIN 1 B
ISO 2339 B
NEN 10 B



Informacje techniczne

d ₁ (h10)	c (maks.)	d ₂ >	d ₂ ≤	W (min.)
0.6	0.1	1	2	2
0.8	0.12	2	3	2.5
1	0.15	3	4	3
1.5	0.23	4/5	5/6	3.5/4
2	0.3	6	8	4.5
2.5	0.4	8	9	5
3	0.45	8	11	5
4	0.6	11	17	6
5	0.75	17	23	7.5
6	0.9	23	30	9
6.5 (#DIN)	1	25	33	10
7 (#DIN)	1.2	33	40	12
8	1.2	30/38	38/45	10/11
10	1.5	45/50	50/75	11.5/13
12	1.8	75	110	15
13 (#DIN)	1.8	75	110	15
14	2	75	110	15
16	2.5	110	160	18

- Kołki stożkowe są zaprojektowane do blokowania i/lub łączenia przez tarcie dwóch lub kilku pojedynczych elementów. Kształt stożkowy pozwala na wielokrotne rozłączanie połączenia, a kiedy elementy zostają ponownie połączone, ich wzajemne położenie pozostaje równie dokładne co poprzednim razem, a połączenie trące jest równie mocne co wcześniej.
- Długość znamionowa (L) nie obejmuje zaokrąglonych końców (tolerancja js15).

Dane montażowe

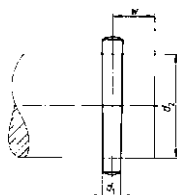

Grupy katalogowe

Material	Kod	Strona
Stal automatowa	39000	9-3
St.St. A1	51560	9-4

39000 Kołki stożkowe toczone		L11A
Material	Stal automatowa	

d ₁ x L	☒	Kod artykułu	d ₁ x L	☒	Kod artykułu	d ₁ x L	☒	Kod artykułu
1X14MM	200	39000.010.014	2X12MM	200	39000.020.012	2,5X20MM	100	39000.025.020
1X18MM	200	39000.010.018	2X14MM	200	39000.020.014	2,5X24MM	100	39000.025.024
1X20MM	200	39000.010.020	2X16MM	200	39000.020.016	2,5X26MM	100	39000.025.026
			2X20MM	100	39000.020.020	2,5X30MM	100	39000.025.030
1,5X10MM	200	39000.015.010	2X24MM	100	39000.020.024	2,5X36MM	50	39000.025.036
1,5X14MM	200	39000.015.014	2X30MM	100	39000.020.030	2,5X40MM	50	39000.025.040
1,5X20MM	200	39000.015.020	2X40MM	100	39000.020.040	2,5X50MM	50	39000.025.050
1,5X24MM	200	39000.015.024	2X50MM	50	39000.020.050			
1,5X30MM	200	39000.015.030				3X12MM	100	39000.030.012
			2,5X12MM	200	39000.025.012	3X14MM	100	39000.030.014
2X10MM	200	39000.020.010	2,5X16MM	200	39000.025.016	3X16MM	100	39000.030.016

39000		Kołki stożkowe toczone						
d ₁ x L	☒	Kod artykułu	d ₁ x L	☒	Kod artykułu	d ₁ x L	☒	Kod artykułu
3X20MM	100	39000.030.020	6X50MM	25	39000.060.050	10X70MM	10	39000.100.070
3X24MM	100	39000.030.024	6X60MM	25	39000.060.060	10X80MM	10	39000.100.080
3X30MM	100	39000.030.030	6X70MM	25	39000.060.070	10X100MM	10	39000.100.100
3X36MM	50	39000.030.036	6X80MM	25	39000.060.080	10X110MM	10	39000.100.110
3X40MM	50	39000.030.040	6X100MM	10	39000.060.100	10X120MM	10	39000.100.120
3X50MM	50	39000.030.050	6X120MM	10	39000.060.120	10X140MM	10	39000.100.140
3X60MM	25	39000.030.060	6X140MM	10	39000.060.140	10X150MM	10	39000.100.150
4X16MM	100	39000.040.016	6,5X50MM	25	39000.065.050	10X160MM	10	39000.100.160
4X20MM	100	39000.040.020	6,5X60MM	25	39000.065.060	12X40MM	10	39000.120.040
4X24MM	100	39000.040.024	6,5X80MM	25	39000.065.080	12X50MM	10	39000.120.050
4X26MM	50	39000.040.026	6,5X100MM	10	39000.065.100	12X60MM	10	39000.120.060
4X30MM	50	39000.040.030	7X50MM	25	39000.070.050	12X70MM	10	39000.120.070
4X36MM	50	39000.040.036	7X60MM	25	39000.070.060	12X80MM	10	39000.120.080
4X40MM	50	39000.040.040	7X70MM	25	39000.070.070	12X100MM	10	39000.120.100
4X50MM	50	39000.040.050	7X70MM	25	39000.070.070	12X120MM	10	39000.120.120
4X60MM	25	39000.040.060	7X80MM	10	39000.070.080	12X140MM	10	39000.120.140
4X70MM	25	39000.040.070	7X100MM	10	39000.070.100	12X160MM	10	39000.120.160
4X80MM	25	39000.040.080	8X30MM	25	39000.080.030	13X100MM	10	39000.130.100
4X100MM	25	39000.040.100	8X36MM	25	39000.080.036	13X120MM	10	39000.130.120
5X20MM	100	39000.050.020	8X40MM	25	39000.080.040	13X150MM	10	39000.130.150
5X24MM	50	39000.050.024	8X50MM	25	39000.080.050	14X90MM	10	39000.140.090
5X26MM	50	39000.050.026	8X60MM	25	39000.080.060	16X50MM	5	39000.160.050
5X30MM	50	39000.050.030	8X70MM	25	39000.080.070	16X60MM	5	39000.160.060
5X40MM	50	39000.050.040	8X80MM	10	39000.080.080	16X70MM	5	39000.160.070
5X50MM	50	39000.050.050	8X90MM	10	39000.080.090	16X80MM	5	39000.160.080
5X60MM	25	39000.050.060	8X100MM	10	39000.080.100	16X100MM	5	39000.160.100
5X70MM	25	39000.050.070	8X120MM	10	39000.080.120	16X120MM	5	39000.160.120
5X80MM	25	39000.050.080	8X140MM	10	39000.080.140	16X150MM	5	39000.160.150
5X100MM	25	39000.050.100	8X160MM	10	39000.080.160	16X180MM	5	39000.160.180
6X20MM	50	39000.060.020	10X30MM	25	39000.100.030	16X200MM	5	39000.160.200
6X24MM	50	39000.060.024	10X40MM	25	39000.100.040			
6X30MM	50	39000.060.030	10X50MM	25	39000.100.050			
6X40MM	25	39000.060.040	10X60MM	25	39000.100.060			

51560		Kołki stożkowe toczone				R09A	
Materiał	Stal nierdzewna A1						

d ₁ x L	☒	Kod artykułu	d ₁ x L	☒	Kod artykułu	d ₁ x L	☒	Kod artykułu
1X10MM	100	51560.010.010	3X32MM*	100	51560.030.032	6X12MM	100	51560.060.012
1X12MM	100	51560.010.012	3X40MM*	100	51560.030.040	6X16MM	100	51560.060.016
1,5X10MM*	200	51560.015.010	3X45MM*	100	51560.030.045	6X20MM	100	51560.060.020
1,5X12MM*	200	51560.015.012	3X50MM*	100	51560.030.050	6X24MM	100	51560.060.024
2X8MM	100	51560.020.008	4X10MM	100	51560.040.010	6X25MM*	100	51560.060.025
2X10MM	100	51560.020.010	4X12MM	100	51560.040.012	6X26MM*	100	51560.060.026
2X12MM	100	51560.020.012	4X16MM	100	51560.040.016	6X30MM	50	51560.060.030
2X16MM*	200	51560.020.016	4X20MM	100	51560.040.020	6X32MM*	100	51560.060.032
2X20MM*	200	51560.020.020	4X24MM	100	51560.040.024	6X40MM	50	51560.060.040
2X24MM*	200	51560.020.024	4X25MM*	100	51560.040.025	6X45MM*	100	51560.060.045
2X26MM*	200	51560.020.026	4X26MM*	100	51560.040.026	6X50MM	50	51560.060.050
2X30MM*	200	51560.020.030	4X28MM*	100	51560.040.028	6X55MM*	100	51560.060.055
2X36MM*	200	51560.020.036	4X30MM	100	51560.040.030	6X60MM*	100	51560.060.060
2,5X10MM	100	51560.025.010	4X36MM	100	51560.040.036	6X70MM*	100	51560.060.070
2,5X16MM	100	51560.025.016	4X40MM*	100	51560.040.040	6X80MM*	100	51560.060.080
2,5X20MM	100	51560.025.020	4X45MM*	100	51560.040.045	6X100MM*	100	51560.060.100
2,5X24MM	100	51560.025.024	4X50MM*	100	51560.040.050	8X16MM	50	51560.080.016
2,5X36MM*	200	51560.025.036	4X60MM*	100	51560.040.060	8X24MM	50	51560.080.024
3X6MM	100	51560.030.006	5X16MM	100	51560.050.016	8X30MM	50	51560.080.030
3X8MM	100	51560.030.008	5X20MM	100	51560.050.020	8X36MM	50	51560.080.036
3X10MM	100	51560.030.010	5X24MM	100	51560.050.024	8X40MM	50	51560.080.040
3X12MM	100	51560.030.012	5X26MM*	100	51560.050.026	8X45MM*	50	51560.080.045
3X14MM*	100	51560.030.014	5X30MM	100	51560.050.030	8X50MM	25	51560.080.050
3X16MM	100	51560.030.016	5X32MM*	100	51560.050.032	8X55MM*	50	51560.080.055
3X18MM*	100	51560.030.018	5X36MM	100	51560.050.036	8X60MM	25	51560.080.060
3X20MM	100	51560.030.020	5X40MM	100	51560.050.040	8X70MM*	50	51560.080.070
3X22MM*	100	51560.030.022	5X45MM*	100	51560.050.045	8X80MM*	50	51560.080.080
3X24MM	100	51560.030.024	5X50MM*	100	51560.050.050	8X90MM*	50	51560.080.090
3X26MM*	100	51560.030.026	5X55MM*	100	51560.050.055	8X100MM*	50	51560.080.100
3X30MM	100	51560.030.030	5X60MM*	100	51560.050.060	10X24MM	50	51560.100.024
			5X70MM*	100	51560.050.070	10X30MM	50	51560.100.030
						10X36MM*	25	51560.100.036

9

51560 Kołki stożkowe toczone								
$d_1 \times L$	☒	Kod artykułu	$d_1 \times L$	☒	Kod artykułu	$d_1 \times L$	☒	Kod artykułu
10X40MM	25	51560.100.040	10X55MM*	25	51560.100.055	10X80MM	25	51560.100.080
10X45MM*	25	51560.100.045	10X60MM	25	51560.100.060	10X100MM*	25	51560.100.100
10X50MM	25	51560.100.050	10X70MM	25	51560.100.070			

Kołki walcowe

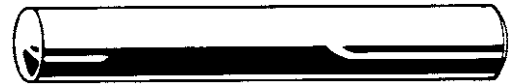
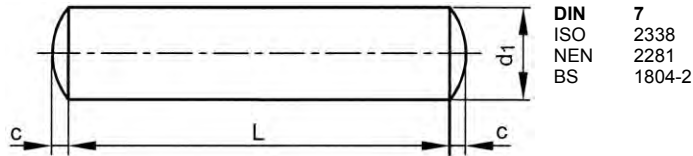

Informacje techniczne

d_1 (m6)	c (maks.)	d_1 (m6)	c (maks.)
1	0.15	6	0.9
1.5	0.23	8	1.2
2	0.3	10	1.5
2.5	0.4	12	1.8
3	0.45	14	2
4	0.6	16	2.5
5	0.75	20	3

- Kołki walcowe są zaprojektowane do łączenia dwóch lub kilku pojedynczych elementów. Przez dobór odpowiedniego rozmiaru można uzyskać połączenie typu ciernego. Jeżeli takie połączenie ma być wielokrotnie rozłączane, to lepiej jest zastosować kołki stożkowe, zgodnie z DIN 1.
- $d \times L$: Długość znamionowa (L) nie obejmuje zaokrąglonych końców.

Grupy katalogowe

Material	Kod	Strona
Stal automatowa	39070	9-5
St.St. A1/A2	51580	9-6
St.St. A4	55580	9-7

39070 Kołki walcowe L11A

Material Stal automatowa

$d_1 \times L$	☒	Kod artykułu	$d_1 \times L$	☒	Kod artykułu	$d_1 \times L$	☒	Kod artykułu
2X10MM	200	39070.020.010	4X14MM	100	39070.040.014	5X70MM	50	39070.050.070
2X12MM	200	39070.020.012	4X16MM	100	39070.040.016	6X10MM	100	39070.060.010
2X14MM	200	39070.020.014	4X18MM	100	39070.040.018	6X12MM	100	39070.060.012
2X16MM	200	39070.020.016	4X20MM	100	39070.040.020	6X14MM	100	39070.060.014
2X18MM	200	39070.020.018	4X24MM	100	39070.040.024	6X16MM	100	39070.060.016
2X20MM	200	39070.020.020	4X28MM	100	39070.040.028	6X18MM	100	39070.060.018
2X24MM	200	39070.020.024	4X30MM	100	39070.040.030	6X20MM	100	39070.060.020
2.5X10MM	200	39070.025.010	4X36MM	100	39070.040.036	6X24MM	50	39070.060.024
2.5X12MM	200	39070.025.012	4X40MM	100	39070.040.040	6X28MM	50	39070.060.028
2.5X14MM	200	39070.025.014	4X50MM	100	39070.040.050	6X30MM	50	39070.060.030
2.5X16MM	200	39070.025.016	4X60MM	100	39070.040.060	6X32MM	50	39070.060.032
2.5X20MM	200	39070.025.020	5X10MM	100	39070.050.010	6X36MM	50	39070.060.036
3X10MM	200	39070.030.010	5X12MM	100	39070.050.012	6X40MM	50	39070.060.040
3X12MM	200	39070.030.012	5X14MM	100	39070.050.014	6X45MM	50	39070.060.045
3X14MM	200	39070.030.014	5X16MM	100	39070.050.016	6X50MM	50	39070.060.050
3X16MM	200	39070.030.016	5X18MM	100	39070.050.018	6X60MM	25	39070.060.060
3X18MM	200	39070.030.018	5X20MM	100	39070.050.020	6X70MM	25	39070.060.070
3X20MM	200	39070.030.020	5X22MM	100	39070.050.022	6X80MM	25	39070.060.080
3X24MM	100	39070.030.024	5X24MM	100	39070.050.024	8X10MM	50	39070.080.010
3X26MM	100	39070.030.026	5X28MM	100	39070.050.028	8X12MM	50	39070.080.012
3X28MM	100	39070.030.028	5X30MM	100	39070.050.030	8X14MM	50	39070.080.014
3X30MM	100	39070.030.030	5X32MM	100	39070.050.032	8X16MM	50	39070.080.016
4X8MM	100	39070.040.008	5X36MM	100	39070.050.036	8X18MM	50	39070.080.018
4X10MM	100	39070.040.010	5X40MM	50	39070.050.040	8X20MM	50	39070.080.020
4X12MM	100	39070.040.012	5X45MM	50	39070.050.045	8X24MM	50	39070.080.024
			5X50MM	50	39070.050.050	8X28MM	50	39070.080.028
			5X60MM	50	39070.050.060			

39070		Kołki walcowe							
d ₁ x L	☒	Kod artykułu	d ₁ x L	☒	Kod artykułu	d ₁ x L	☒	Kod artykułu	
8X30MM	50	39070.080.030	10X24MM	25	39070.100.024	12X30MM	25	39070.120.030	
8X32MM	50	39070.080.032	10X28MM	25	39070.100.028	12X32MM	25	39070.120.032	
8X36MM	50	39070.080.036	10X30MM	25	39070.100.030	12X36MM	25	39070.120.036	
8X40MM	25	39070.080.040	10X32MM	25	39070.100.032	12X40MM	25	39070.120.040	
8X50MM	25	39070.080.050	10X36MM	25	39070.100.036	12X45MM	25	39070.120.045	
8X60MM	25	39070.080.060	10X40MM	25	39070.100.040	12X50MM	10	39070.120.050	
8X70MM	25	39070.080.070	10X50MM	25	39070.100.050	12X60MM	10	39070.120.060	
8X80MM	25	39070.080.080	10X60MM	25	39070.100.060	12X70MM	10	39070.120.070	
8X100MM	25	39070.080.100	10X70MM	25	39070.100.070	12X80MM	10	39070.120.080	
8X120MM	25	39070.080.120	10X80MM	25	39070.100.080	12X100MM	10	39070.120.100	
			10X100MM	25	39070.100.100	12X120MM	10	39070.120.120	
10X16MM	25	39070.100.016	10X120MM	25	39070.100.120				
10X18MM	25	39070.100.018				16X50MM	10	39070.160.050	
10X20MM	25	39070.100.020	12X24MM	25	39070.120.024				

51580		Kołki walcowe						R09A	
Materiał		Stal nierdzewna A1/A2							

d ₁ x L	☒	Kod artykułu	d ₁ x L	☒	Kod artykułu	d ₁ x L	☒	Kod artykułu	
1X3MM*	500	51580.010.003	3X12MM	100	51580.030.012	6X18MM	100	51580.060.018	
1X4MM	100	51580.010.004	3X14MM	100	51580.030.014	6X20MM	100	51580.060.020	
1X5MM	100	51580.010.005	3X16MM	100	51580.030.016	6X24MM	100	51580.060.024	
1X6MM	100	51580.010.006	3X18MM	100	51580.030.018	6X28MM	50	51580.060.028	
1X8MM	100	51580.010.008	3X20MM	100	51580.030.020	6X30MM	50	51580.060.030	
1X10MM	100	51580.010.010	3X24MM	100	51580.030.024	6X32MM	50	51580.060.032	
1X12MM	100	51580.010.012	3X28MM	100	51580.030.028	6X36MM	50	51580.060.036	
1X14MM*	500	51580.010.014	3X30MM	100	51580.030.030	6X40MM	50	51580.060.040	
1X16MM*	500	51580.010.016	3X32MM	100	51580.030.032	6X45MM	50	51580.060.045	
1X20MM*	500	51580.010.020	3X36MM	100	51580.030.036	6X50MM	50	51580.060.050	
			3X40MM	100	51580.030.040	6X55MM*	100	51580.060.055	
1,5X3MM*	500	51580.015.003	3X65MM*	500	51580.030.065	6X60MM	50	51580.060.060	
1,5X4MM	100	51580.015.004				6X70MM	25	51580.060.070	
1,5X5MM	100	51580.015.005	4X5MM*	200	51580.040.005	6X80MM	25	51580.060.080	
1,5X6MM	100	51580.015.006	4X6MM	100	51580.040.006	6X90MM*	100	51580.060.090	
1,5X8MM	100	51580.015.008	4X8MM	100	51580.040.008				
1,5X10MM	100	51580.015.010	4X10MM	100	51580.040.010	8X8MM	100	51580.080.008	
1,5X12MM	100	51580.015.012	4X12MM	100	51580.040.012	8X10MM	100	51580.080.010	
1,5X14MM	100	51580.015.014	4X14MM	100	51580.040.014	8X12MM	100	51580.080.012	
1,5X16MM	100	51580.015.016	4X16MM	100	51580.040.016	8X14MM	100	51580.080.014	
1,5X18MM	100	51580.015.018	4X18MM	100	51580.040.018	8X16MM	100	51580.080.016	
1,5X20MM	100	51580.015.020	4X20MM	100	51580.040.020	8X18MM	50	51580.080.018	
			4X24MM	100	51580.040.024	8X20MM	100	51580.080.020	
2X4MM*	500	51580.020.004	4X28MM	100	51580.040.028	8X24MM	50	51580.080.024	
2X5MM	100	51580.020.005	4X30MM	100	51580.040.030	8X28MM	50	51580.080.028	
2X6MM	100	51580.020.006	4X32MM	100	51580.040.032	8X30MM	50	51580.080.030	
2X8MM	100	51580.020.008	4X36MM	100	51580.040.036	8X32MM	50	51580.080.032	
2X10MM	100	51580.020.010	4X40MM	100	51580.040.040	8X36MM	50	51580.080.036	
2X12MM	100	51580.020.012	4X50MM	100	51580.040.050	8X40MM	50	51580.080.040	
2X14MM	100	51580.020.014	4X60MM*	200	51580.040.060	8X45MM	25	51580.080.045	
2X16MM	100	51580.020.016				8X50MM	25	51580.080.050	
2X18MM	100	51580.020.018	5X5MM*	100	51580.050.005	8X55MM	25	51580.080.055	
2X20MM	100	51580.020.020	5X6MM	100	51580.050.006	8X60MM	25	51580.080.060	
2X24MM	100	51580.020.024	5X8MM	100	51580.050.008	8X70MM	25	51580.080.070	
2X28MM	100	51580.020.028	5X10MM	100	51580.050.010	8X80MM	25	51580.080.080	
2X32MM	100	51580.020.032	5X12MM	100	51580.050.012	8X90MM*	100	51580.080.090	
			5X14MM	100	51580.050.014				
2,5X4MM*	500	51580.025.004	5X16MM	100	51580.050.016	10X10MM*	50	51580.100.010	
2,5X5MM	100	51580.025.005	5X18MM	100	51580.050.018	10X12MM	25	51580.100.012	
2,5X6MM	100	51580.025.006	5X20MM	100	51580.050.020	10X14MM	25	51580.100.014	
2,5X8MM	100	51580.025.008	5X24MM	100	51580.050.024	10X16MM	50	51580.100.016	
2,5X10MM	100	51580.025.010	5X28MM	100	51580.050.028	10X18MM	25	51580.100.018	
2,5X12MM	100	51580.025.012	5X30MM	100	51580.050.030	10X20MM	50	51580.100.020	
2,5X14MM	100	51580.025.014	5X32MM	100	51580.050.032	10X24MM	50	51580.100.024	
2,5X16MM	100	51580.025.016	5X36MM	100	51580.050.036	10X28MM	25	51580.100.028	
2,5X18MM*	500	51580.025.018	5X40MM	100	51580.050.040	10X30MM	50	51580.100.030	
2,5X20MM	100	51580.025.020	5X45MM	50	51580.050.045	10X32MM	25	51580.100.032	
2,5X24MM	100	51580.025.024	5X50MM	50	51580.050.050	10X36MM	25	51580.100.036	
2,5X28MM*	500	51580.025.028	5X60MM	50	51580.050.060	10X40MM	25	51580.100.040	
2,5X32MM*	500	51580.025.032				10X45MM	25	51580.100.045	
			6X6MM*	100	51580.060.006	10X50MM	25	51580.100.050	
3X4MM*	200	51580.030.004	6X8MM*	100	51580.060.008	10X55MM	25	51580.100.055	
3X5mm*	200	51580.030.005	6X10MM	100	51580.060.010	10X60MM	25	51580.100.060	
3X6MM	100	51580.030.006	6X12MM	100	51580.060.012	10X70MM	25	51580.100.070	
3X8MM	100	51580.030.008	6X14MM	100	51580.060.014	10X80MM	25	51580.100.080	
3X10MM	100	51580.030.010	6X16MM	100	51580.060.016	10X90MM	25	51580.100.090	

51580 Kołki walcowe								
d ₁ x L	☒	Kod artykułu	d ₁ x L	☒	Kod artykułu	d ₁ x L	☒	Kod artykułu
10X100MM	25	51580.100.100	14X20MM	25	51580.140.020	16X70MM	10	51580.160.070
12X16MM*	25	51580.120.016	14X24MM	25	51580.140.024	16X80MM	10	51580.160.080
12X18MM*	25	51580.120.018	14X28MM	25	51580.140.028	16X90MM*	25	51580.160.090
12X20MM	25	51580.120.020	14X32MM	25	51580.140.032	16X100MM*	25	51580.160.100
12X24MM*	25	51580.120.024	14X36MM	25	51580.140.036			
12X28MM*	25	51580.120.028	14X40MM	25	51580.140.040	20X20MM*	10	51580.200.020
12X30MM*	25	51580.120.030	14X50MM	10	51580.140.050	20X24MM*	10	51580.200.024
12X32MM	25	51580.120.032	14X100MM	10	51580.140.100	20X30MM*	10	51580.200.030
12X36MM	25	51580.120.036				20X32MM*	10	51580.200.032
12X40MM	25	51580.120.040	16X20MM*	25	51580.160.020	20X36MM*	10	51580.200.036
12X45MM	10	51580.120.045	16X24MM	25	51580.160.024	20X40MM*	10	51580.200.040
12X50MM	10	51580.120.050	16X28MM	25	51580.160.028	20X45MM*	10	51580.200.045
12X55MM	10	51580.120.055	16X30MM*	25	51580.160.030	20X50MM*	10	51580.200.050
12X60MM	10	51580.120.060	16X32MM	25	51580.160.032	20X55MM*	10	51580.200.055
12X70MM	10	51580.120.070	16X36MM	25	51580.160.036	20X60MM*	10	51580.200.060
12X80MM	10	51580.120.080	16X40MM	25	51580.160.040	20X70MM*	10	51580.200.070
12X90MM	10	51580.120.090	16X45MM	10	51580.160.045	20X80MM*	10	51580.200.080
12X100MM	10	51580.120.100	16X50MM	10	51580.160.050	20X90MM*	10	51580.200.090
			16X55MM	10	51580.160.055	20X100MM*	10	51580.200.100
			16X60MM	10	51580.160.060			

• W zależności od dostępności może zostać dostarczona stal A1, jak również stal A2.

55580 Kołki walcowe		R49A
Materiał	Stal nierdzewna A4	
		

d ₁ x L	☒	Kod artykułu	d ₁ x L	☒	Kod artykułu	d ₁ x L	☒	Kod artykułu
1X3MM*	500	55580.010.003	3X10MM	100	55580.030.010	6X6MM*	100	55580.060.006
1X4MM*	500	55580.010.004	3X12MM	100	55580.030.012	6X8MM*	100	55580.060.008
1X5MM	100	55580.010.005	3X14MM	100	55580.030.014	6X10MM	100	55580.060.010
1X6MM*	500	55580.010.006	3X16MM	100	55580.030.016	6X12MM	100	55580.060.012
1X8MM	100	55580.010.008	3X18MM	100	55580.030.018	6X14MM	100	55580.060.014
1X10MM*	500	55580.010.010	3X20MM	100	55580.030.020	6X16MM	100	55580.060.016
1X16MM*	500	55580.010.016	3X24MM	100	55580.030.024	6X18MM	100	55580.060.018
			3X28MM	100	55580.030.028	6X20MM	100	55580.060.020
1,5X3MM*	500	55580.015.003	3X30MM	100	55580.030.030	6X24MM	100	55580.060.024
1,5X4MM*	500	55580.015.004	3X32MM	100	55580.030.032	6X28MM	50	55580.060.028
1,5X5MM	100	55580.015.005	3X36MM	100	55580.030.036	6X30MM	50	55580.060.030
1,5X6MM	100	55580.015.006	3X40MM	100	55580.030.040	6X32MM	50	55580.060.032
1,5X8MM	100	55580.015.008				6X36MM	50	55580.060.036
1,5X10MM	100	55580.015.010	4X5MM*	200	55580.040.005	6X40MM	50	55580.060.040
1,5X12MM	100	55580.015.012	4X6MM*	200	55580.040.006	6X45MM	50	55580.060.045
1,5X14MM	100	55580.015.014	4X8MM	100	55580.040.008	6X50MM	50	55580.060.050
1,5X16MM	100	55580.015.016	4X10MM	100	55580.040.010	6X55MM*	100	55580.060.055
			4X12MM	100	55580.040.012	6X60MM	50	55580.060.060
2X4MM*	500	55580.020.004	4X14MM	100	55580.040.014	6X70MM*	100	55580.060.070
2X5MM*	500	55580.020.005	4X16MM	100	55580.040.016			
2X6MM	100	55580.020.006	4X18MM	100	55580.040.018	8X8MM*	100	55580.080.008
2X8MM	100	55580.020.008	4X20MM	100	55580.040.020	8X10MM	100	55580.080.010
2X10MM	100	55580.020.010	4X24MM	100	55580.040.024	8X12MM	100	55580.080.012
2X12MM	100	55580.020.012	4X28MM	100	55580.040.028	8X14MM	100	55580.080.014
2X14MM	100	55580.020.014	4X30MM	100	55580.040.030	8X16MM	100	55580.080.016
2X16MM	100	55580.020.016	4X32MM	100	55580.040.032	8X18MM	50	55580.080.018
2X18MM	100	55580.020.018	4X36MM	100	55580.040.036	8X20MM	100	55580.080.020
2X20MM	100	55580.020.020	4X40MM	100	55580.040.040	8X24MM	50	55580.080.024
2X24MM*	500	55580.020.024	4X50MM	100	55580.040.050	8X28MM	50	55580.080.028
2X32MM*	500	55580.020.032				8X30MM	50	55580.080.030
			5X5MM*	100	55580.050.005	8X32MM	50	55580.080.032
2,5X4MM*	500	55580.025.004	5X6MM*	100	55580.050.006	8X36MM	50	55580.080.036
2,5X5MM*	500	55580.025.005	5X8MM	100	55580.050.008	8X40MM	50	55580.080.040
2,5X6MM	100	55580.025.006	5X10MM	100	55580.050.010	8X45MM	25	55580.080.045
2,5X8MM	100	55580.025.008	5X12MM	100	55580.050.012	8X50MM	25	55580.080.050
2,5X10MM	100	55580.025.010	5X14MM	100	55580.050.014	8X55MM*	100	55580.080.055
2,5X12MM	100	55580.025.012	5X16MM	100	55580.050.016	8X60MM	25	55580.080.060
2,5X14MM	100	55580.025.014	5X18MM	100	55580.050.018	8X70MM	25	55580.080.070
2,5X16MM	100	55580.025.016	5X20MM	100	55580.050.020	8X80MM	25	55580.080.080
2,5X20MM	100	55580.025.020	5X24MM	100	55580.050.024			
2,5X24MM*	500	55580.025.024	5X28MM	100	55580.050.028	10X12MM*	50	55580.100.012
2,5X28MM*	500	55580.025.028	5X30MM	100	55580.050.030	10X14MM	25	55580.100.014
2,5X32MM*	500	55580.025.032	5X32MM	100	55580.050.032	10X16MM	50	55580.100.016
			5X36MM	100	55580.050.036	10X18MM	25	55580.100.018
3X4MM*	200	55580.030.004	5X40MM	100	55580.050.040	10X20MM	50	55580.100.020
3X5MM*	200	55580.030.005	5X45MM	50	55580.050.045	10X24MM	50	55580.100.024
3X6MM*	200	55580.030.006	5X50MM	50	55580.050.050	10X28MM	25	55580.100.028
3X8MM	100	55580.030.008	5X60MM	50	55580.050.060			

55580		Kołki walcowe							
$d_1 \times L$	☒	Kod artykułu	$d_1 \times L$	☒	Kod artykułu	$d_1 \times L$	☒	Kod artykułu	
10X30MM	50	55580.100.030	12X20MM	25	55580.120.020	16X24MM*	25	55580.160.024	
10X32MM	25	55580.100.032	12X24MM*	25	55580.120.024	16X28MM*	25	55580.160.028	
10X36MM	25	55580.100.036	12X28MM*	25	55580.120.028	16X32MM*	25	55580.160.032	
10X40MM	25	55580.100.040	12X32MM	25	55580.120.032	16X36MM*	25	55580.160.036	
10X45MM	25	55580.100.045	12X36MM	25	55580.120.036	16X40MM*	25	55580.160.040	
10X50MM	25	55580.100.050	12X40MM	25	55580.120.040	16X45MM*	25	55580.160.045	
10X55MM	25	55580.100.055	12X45MM	10	55580.120.045	16X50MM*	25	55580.160.050	
10X60MM	25	55580.100.060	12X50MM	10	55580.120.050	16X55MM*	25	55580.160.055	
10X70MM	25	55580.100.070	12X55MM	10	55580.120.055	16X60MM*	25	55580.160.060	
10X80MM	25	55580.100.080	12X60MM	10	55580.120.060	16X70MM*	25	55580.160.070	
10X90MM	25	55580.100.090	12X70MM*	25	55580.120.070	16X80MM*	25	55580.160.080	
10X100MM	25	55580.100.100	12X80MM	10	55580.120.080	16X90MM*	25	55580.160.090	
			12X90MM	10	55580.120.090	16X100MM*	25	55580.160.100	
12X16MM	25	55580.120.016	12X100MM	10	55580.120.100				
12X18MM	25	55580.120.018				20X100MM*	10	55580.200.100	

Kołki walcowe hartowane, pole tolerancji m6

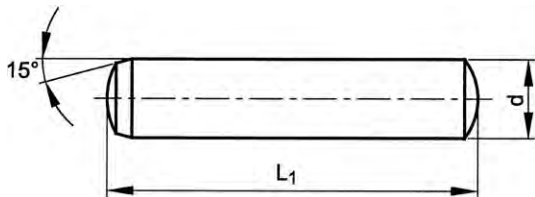

DIN 6325
ISO 8734 A
NEN 2282
NF E27-475

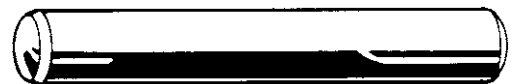

- Kołki walcowe są stosowane głównie jako kołki ustalające do narzędzi, urządzeń mocujących i pomiarowych.
- Długość znamionowa (L_1) obejmuje zaokrąglone końce (tolerancja js14).

39080		Kołki walcowe hartowane, pole tolerancji m6						L11A	
Materiał	Stal 60 ± 2HRc								

$d \times L_1$	☒	Kod artykułu	$d \times L_1$	☒	Kod artykułu	$d \times L_1$	☒	Kod artykułu
1X4MM	100	39080.010.004	2,5X12MM	100	39080.025.012	4X24MM	100	39080.040.024
1X5MM	100	39080.010.005	2,5X14MM	100	39080.025.014	4X26MM	100	39080.040.026
1X6MM	100	39080.010.006	2,5X16MM	100	39080.025.016	4X28MM	100	39080.040.028
1X8MM	100	39080.010.008	2,5X18MM	100	39080.025.018	4X30MM	100	39080.040.030
1X10MM	100	39080.010.010	2,5X20MM	100	39080.025.020	4X32MM	100	39080.040.032
1X12MM	100	39080.010.012	2,5X24MM	100	39080.025.024	4X36MM	100	39080.040.036
			2,5X28MM	100	39080.025.028	4X40MM	100	39080.040.040
1,5X5MM	100	39080.015.005	2,5X32MM	100	39080.025.032	4X45MM	100	39080.040.045
1,5X6MM	100	39080.015.006	2,5X36MM	100	39080.025.036	4X50MM	100	39080.040.050
1,5X8MM	100	39080.015.008	2,5X40MM	100	39080.025.040	4X60MM	100	39080.040.060
1,5X10MM	100	39080.015.010	2,5X45MM	100	39080.025.045			
1,5X12MM	100	39080.015.012	2,5X50MM	100	39080.025.050	5X8MM	100	39080.050.008
1,5X14MM	100	39080.015.014				5X10MM	100	39080.050.010
1,5X16MM	100	39080.015.016	3X6MM	100	39080.030.006	5X12MM	100	39080.050.012
1,5X18MM	100	39080.015.018	3X8MM	100	39080.030.008	5X14MM	100	39080.050.014
1,5X20MM	100	39080.015.020	3X10MM	100	39080.030.010	5X16MM	100	39080.050.016
1,5X24MM	100	39080.015.024	3X12MM	100	39080.030.012	5X18MM	100	39080.050.018
1,5X28MM	100	39080.015.028	3X14MM	100	39080.030.014	5X20MM	100	39080.050.020
1,5X32MM	100	39080.015.032	3X16MM	100	39080.030.016	5X24MM	100	39080.050.024
			3X18MM	100	39080.030.018	5X26MM	100	39080.050.026
2X5MM	100	39080.020.005	3X20MM	100	39080.030.020	5X28MM	100	39080.050.028
2X6MM	100	39080.020.006	3X24MM	100	39080.030.024	5X30MM	100	39080.050.030
2X8MM	100	39080.020.008	3X28MM	100	39080.030.028	5X32MM	100	39080.050.032
2X10MM	100	39080.020.010	3X30MM	100	39080.030.030	5X36MM	100	39080.050.036
2X12MM	100	39080.020.012	3X32MM	100	39080.030.032	5X40MM	100	39080.050.040
2X14MM	100	39080.020.014	3X36MM	100	39080.030.036	5X45MM	50	39080.050.045
2X16MM	100	39080.020.016	3X40MM	100	39080.030.040	5X50MM	50	39080.050.050
2X20MM	100	39080.020.020	3X50MM	100	39080.030.050	5X55MM	50	39080.050.055
2X24MM	100	39080.020.024	3X60MM	100	39080.030.060	5X60MM	50	39080.050.060
2X28MM	100	39080.020.028						
2X30MM	100	39080.020.030	4X6MM	100	39080.040.006	6X8MM	100	39080.060.008
2X32MM	100	39080.020.032	4X8MM	100	39080.040.008	6X10MM	100	39080.060.010
2X36MM	100	39080.020.036	4X10MM	100	39080.040.010	6X12MM	100	39080.060.012
2X40MM	100	39080.020.040	4X12MM	100	39080.040.012	6X14MM	100	39080.060.014
			4X14MM	100	39080.040.014	6X16MM	100	39080.060.016
2,5X6MM	100	39080.025.006	4X16MM	100	39080.040.016	6X18MM	100	39080.060.018
2,5X8MM	100	39080.025.008	4X18MM	100	39080.040.018	6X20MM	100	39080.060.020
2,5X10MM	100	39080.025.010	4X20MM	100	39080.040.020	6X24MM	100	39080.060.024

39080 Kołki walcowe hartowane, pole tolerancji m6								
d x L ₁	☒	Kod artykułu	d x L ₁	☒	Kod artykułu	d x L ₁	☒	Kod artykułu
6X26MM	100	39080.060.026				12X80MM	10	39080.120.080
6X28MM	100	39080.060.028	10X12MM	50	39080.100.012	12X90MM	10	39080.120.090
6X30MM	100	39080.060.030	10X14MM	50	39080.100.014	12X100MM	10	39080.120.100
6X32MM	50	39080.060.032	10X16MM	50	39080.100.016	12X120MM	10	39080.120.120
6X36MM	50	39080.060.036	10X20MM	50	39080.100.020			
6X40MM	50	39080.060.040	10X24MM	50	39080.100.024	14X32MM	25	39080.140.032
6X45MM	50	39080.060.045	10X28MM	50	39080.100.028	14X36MM	25	39080.140.036
6X50MM	50	39080.060.050	10X30MM	50	39080.100.030	14X40MM	25	39080.140.040
6X55MM	50	39080.060.055	10X32MM	50	39080.100.032	14X50MM	25	39080.140.050
6X60MM	50	39080.060.060	10X36MM	25	39080.100.036	14X60MM	10	39080.140.060
6X70MM	25	39080.060.070	10X40MM	25	39080.100.040	14X80MM	10	39080.140.080
6X80MM	25	39080.060.080	10X45MM	25	39080.100.045	14X100MM	10	39080.140.100
			10X50MM	25	39080.100.050	14X120MM	10	39080.140.120
8X10MM	100	39080.080.010	10X55MM	25	39080.100.055			
8X12MM	100	39080.080.012	10X60MM	25	39080.100.060	16X36MM	10	39080.160.036
8X14MM	100	39080.080.014	10X70MM	25	39080.100.070	16X40MM	10	39080.160.040
8X16MM	100	39080.080.016	10X80MM	25	39080.100.080	16X50MM	10	39080.160.050
8X18MM	100	39080.080.018	10X90MM	25	39080.100.090	16X60MM	10	39080.160.060
8X20MM	100	39080.080.020	10X100MM	25	39080.100.100	16X80MM	10	39080.160.080
8X24MM	50	39080.080.024				16X100MM	10	39080.160.100
8X26MM	50	39080.080.026	12X16MM	25	39080.120.016	16X120MM	10	39080.160.120
8X28MM	50	39080.080.028	12X20MM	25	39080.120.020			
8X30MM	50	39080.080.030	12X24MM	25	39080.120.024	20X30MM	100	39080.200.030
8X32MM	50	39080.080.032	12X26MM	25	39080.120.026	20X32MM	10	39080.200.032
8X36MM	50	39080.080.036	12X28MM	25	39080.120.028	20X36MM	10	39080.200.036
8X40MM	50	39080.080.040	12X30MM	25	39080.120.030	20X40MM	10	39080.200.040
8X45MM	50	39080.080.045	12X32MM	25	39080.120.032	20X50MM	10	39080.200.050
8X50MM	25	39080.080.050	12X36MM	25	39080.120.036	20X60MM	10	39080.200.060
8X55MM	25	39080.080.055	12X40MM	25	39080.120.040	20X70MM	10	39080.200.070
8X60MM	25	39080.080.060	12X45MM	25	39080.120.045	20X80MM	10	39080.200.080
8X70MM	25	39080.080.070	12X50MM	25	39080.120.050	20X100MM	10	39080.200.100
8X80MM	25	39080.080.080	12X55MM	25	39080.120.055	20X120MM	10	39080.200.120
8X90MM	25	39080.080.090	12X60MM	25	39080.120.060			
8X100MM	25	39080.080.100	12X70MM	25	39080.120.070			

Kołki walcowe hartowane, pole tolerancji h6

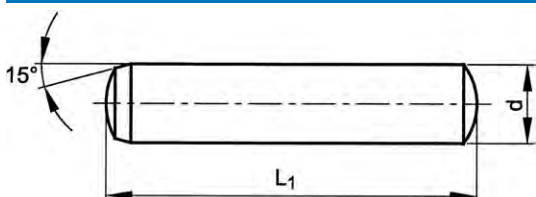

DIN ≈6325
 ISO ≈8734 A
 NEN ≈2282
 NF ≈E27-475

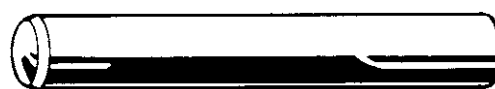

- Kołki walcowe są stosowane głównie jako kołki ustalające do narzędzi, urządzeń mocujących i pomiarowych
- d x L₁: Długość znamionowa (L₁) obejmuje zaokrąglone końce (tolerancja js14).

39078 Kołki walcowe hartowane, pole tolerancji h6		L11A
Materiał	Stal 60 ± 2HRc	

d x L ₁	☒	Kod artykułu	d x L ₁	☒	Kod artykułu	d x L ₁	☒	Kod artykułu
2X5MM	100	39078.020.005	3X10MM	100	39078.030.010	4X28MM	100	39078.040.028
2X6MM	100	39078.020.006	3X12MM	100	39078.030.012	4X30MM	100	39078.040.030
2X8MM	100	39078.020.008	3X14MM	100	39078.030.014	4X32MM	100	39078.040.032
2X10MM	100	39078.020.010	3X16MM	100	39078.030.016	4X40MM	100	39078.040.040
2X12MM	100	39078.020.012	3X20MM	100	39078.030.020	4X50MM	100	39078.040.050
2X14MM	100	39078.020.014	3X24MM	100	39078.030.024			
2X16MM	100	39078.020.016	3X28MM	100	39078.030.028	5X8MM	100	39078.050.008
2X20MM	100	39078.020.020	3X30MM	100	39078.030.030	5X10MM	100	39078.050.010
2X24MM	100	39078.020.024	3X32MM	100	39078.030.032	5X12MM	100	39078.050.012
2X28MM	100	39078.020.028	3X40MM	100	39078.030.040	5X14MM	100	39078.050.014
						5X16MM	100	39078.050.016
2,5X6MM	100	39078.025.006	4X8MM	100	39078.040.008	5X20MM	100	39078.050.020
2,5X8MM	100	39078.025.008	4X10MM	100	39078.040.010	5X24MM	100	39078.050.024
2,5X10MM	100	39078.025.010	4X12MM	100	39078.040.012	5X26MM	100	39078.050.026
2,5X16MM	100	39078.025.016	4X14MM	100	39078.040.014	5X28MM	100	39078.050.028
2,5X24MM	100	39078.025.024	4X16MM	100	39078.040.016	5X30MM	100	39078.050.030
			4X18MM	100	39078.040.018	5X32MM	100	39078.050.032
3X6MM	100	39078.030.006	4X20MM	100	39078.040.020	5X36MM	100	39078.050.036
3X8MM	100	39078.030.008	4X24MM	100	39078.040.024	5X40MM	100	39078.050.040

39078 Kołki walcowe hartowane, pole tolerancji h6

d x L ₁	☒	Kod artykułu	d x L ₁	☒	Kod artykułu	d x L ₁	☒	Kod artykułu
5X50MM	100	39078.050.050	8X24MM	50	39078.080.024	12X24MM	25	39078.120.024
5X60MM	100	39078.050.060	8X28MM	50	39078.080.028	12X32MM	25	39078.120.032
6X10MM	100	39078.060.010	8X30MM	50	39078.080.030	12X36MM	25	39078.120.036
6X12MM	100	39078.060.012	8X32MM	50	39078.080.032	12X40MM	25	39078.120.040
6X14MM	100	39078.060.014	8X36MM	50	39078.080.036	12X45MM	25	39078.120.045
6X16MM	100	39078.060.016	8X40MM	50	39078.080.040	12X50MM	25	39078.120.050
6X18MM	100	39078.060.018	8X50MM	25	39078.080.050	12X60MM	25	39078.120.060
6X20MM	100	39078.060.020	8X60MM	25	39078.080.060	12X80MM	10	39078.120.080
6X24MM	100	39078.060.024	8X70MM	25	39078.080.070	12X100MM	10	39078.120.100
6X26MM	100	39078.060.026	8X80MM	25	39078.080.080			
6X28MM	100	39078.060.028	10X20MM	50	39078.100.020	16X40MM	10	39078.160.040
6X30MM	100	39078.060.030	10X24MM	50	39078.100.024	16X50MM	10	39078.160.050
6X32MM	50	39078.060.032	10X28MM	50	39078.100.028	16X60MM	10	39078.160.060
6X36MM	50	39078.060.036	10X30MM	50	39078.100.030	16X80MM	10	39078.160.080
6X40MM	50	39078.060.040	10X32MM	50	39078.100.032	16X100MM	10	39078.160.100
6X45MM	50	39078.060.045	10X36MM	25	39078.100.036			
6X50MM	50	39078.060.050	10X40MM	25	39078.100.040	20X40MM	10	39078.200.040
6X60MM	50	39078.060.060	10X50MM	25	39078.100.050	20X50MM	10	39078.200.050
			10X60MM	25	39078.100.060	20X60MM	10	39078.200.060
8X16MM	100	39078.080.016	10X80MM	25	39078.100.080	20X80MM	10	39078.200.080
8X20MM	100	39078.080.020	10X100MM	25	39078.100.100			

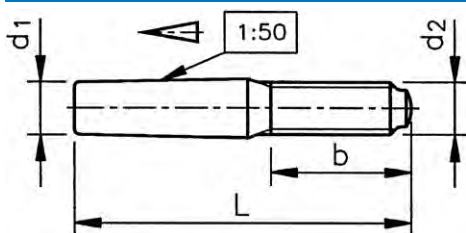
Kołki stożkowe z czopem gwintowym

DIN 7977
ISO 8737
NEN 2462

Informacje techniczne

d ₁	b	d ₂	d ₁	b	d ₂
5	14	M5	12	27	M12
6	18	M6	16	35	M16
8	22	M8	20	35	M16
10	24	M10			

• d₁ x L: Długość znamionowa (L) obejmuje zaokrąglone końce (tolerancja js15).

39011 Kołki stożkowe z czopem gwintowym
L11A
Materiał Stal automatowa

d ₁ x L	☒	Kod artykułu	d ₁ x L	☒	Kod artykułu	d ₁ x L	☒	Kod artykułu
5X40MM	50	39011.050.040	8X75MM	10	39011.080.075	16X85MM	5	39011.160.085
5X45MM	50	39011.050.045	10X60MM	10	39011.100.060	16X100MM	5	39011.160.100
5X50MM	50	39011.050.050	10X65MM	10	39011.100.065	16X120MM	5	39011.160.120
6X45MM	25	39011.060.045	10X75MM	10	39011.100.075	16X140MM	5	39011.160.140
6X50MM	25	39011.060.050	10X85MM	10	39011.100.085	16X160MM	5	39011.160.160
6X55MM	25	39011.060.055	10X100MM	10	39011.100.100			
6X60MM	25	39011.060.060	12X75MM	5	39011.120.075	20X100MM	5	39011.200.100
			12X85MM	5	39011.120.085	20X120MM	5	39011.200.120
8X55MM	10	39011.080.055	12X100MM	5	39011.120.100	20X140MM	5	39011.200.140
8X60MM	10	39011.080.060	12X120MM	5	39011.120.120	20X160MM	5	39011.200.160
8X65MM	10	39011.080.065						

Kołki stożkowe z gwintem wewnętrznym, niehartowane

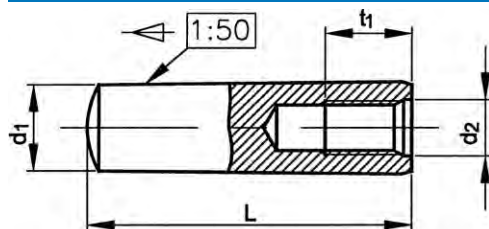

DIN 7978 A
ISO 8736 A
NEN 2463
NF E27-479



Informacje techniczne

d ₁	d ₂	t ₁	d ₁	d ₂	t ₁
6	M4	6	12	M8	12
8	M5	8	16	M10	16
10	M6	10	20	M12	18

- d₁ x L: Długość znamionowa (L) obejmuje zaokrąglone końce (tolerancja js15).

39012 Kołki stożkowe z gwintem wewnętrznym, niehartowane

L11A

Materiał Stal automatowa



d ₁ x L	☒	Kod artykułu	d ₁ x L	☒	Kod artykułu	d ₁ x L	☒	Kod artykułu
6X16MM	50	39012.060.016	8X50MM	10	39012.080.050	12X60MM	10	39012.120.060
6X24MM	50	39012.060.024	8X60MM	10	39012.080.060	12X70MM	10	39012.120.070
6X28MM	50	39012.060.028	8X70MM	10	39012.080.070	12X80MM	5	39012.120.080
6X30MM	50	39012.060.030				12X100MM	5	39012.120.100
6X32MM	25	39012.060.032	10X24MM	25	39012.100.024			
6X36MM	25	39012.060.036	10X28MM	25	39012.100.028	16X40MM	5	39012.160.040
6X40MM	25	39012.060.040	10X32MM	25	39012.100.032	16X50MM	5	39012.160.050
6X50MM	25	39012.060.050	10X40MM	10	39012.100.040	16X60MM	5	39012.160.060
6X60MM	25	39012.060.060	10X50MM	10	39012.100.050	16X80MM	5	39012.160.080
			10X60MM	10	39012.100.060	16X90MM	5	39012.160.090
8X20MM	50	39012.080.020	10X70MM	10	39012.100.070	16X100MM	5	39012.160.100
8X24MM	25	39012.080.024	10X80MM	10	39012.100.080	16X120MM	5	39012.160.120
8X28MM	25	39012.080.028	10X100MM	10	39012.100.100			
8X30MM	25	39012.080.030				20X60MM	5	39012.200.060
8X32MM	25	39012.080.032	12X32MM	10	39012.120.032	20X80MM	5	39012.200.080
8X36MM	25	39012.080.036	12X40MM	10	39012.120.040	20X100MM	5	39012.200.100
8X40MM	25	39012.080.040	12X50MM	10	39012.120.050	20X120MM	5	39012.200.120

Kołki walcowe z gwintem wewnętrznym, hartowane

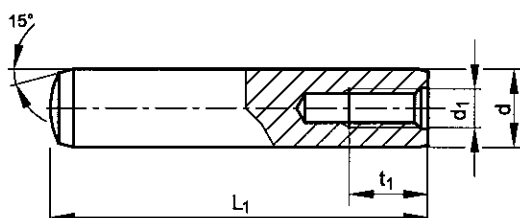

DIN 7979 D
ISO 8735 A
NEN 2464
NF E27-475



Informacje techniczne

d (m6)	d ₁	t ₁	d (m6)	d ₁	t ₁
5 (#DIN)	M3	4	14	M8	12
6	M4	6	16	M8	12
8	M5	8	20	M10	16
10	M6	10	25	M16	24
12	M6	10	30	M20	30

- d x L₁: Długość znamionowa (L₁) obejmuje zaokrąglone końce (tolerancja js15).

39090 Kołki walcowe z gwintem wewnętrznym, hartowane

L11A

Material Stal 60 ± 2HRc

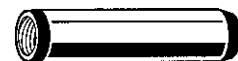

d x L ₁	☒	Kod artykułu	d x L ₁	☒	Kod artykułu	d x L ₁	☒	Kod artykułu
5X12MM	100	39090.050.012	8X40MM	25	39090.080.040	12X50MM	10	39090.120.050
5X16MM	50	39090.050.016	8X45MM	25	39090.080.045	12X60MM	10	39090.120.060
5X20MM	50	39090.050.020	8X50MM	10	39090.080.050	12X70MM	10	39090.120.070
5X24MM	50	39090.050.024	8X60MM	10	39090.080.060	12X80MM	5	39090.120.080
5X28MM	50	39090.050.028	8X70MM	10	39090.080.070	12X100MM	5	39090.120.100
5X30MM	25	39090.050.030	8X80MM	50	39090.080.080			
5X32MM	25	39090.050.032				14X60MM	5	39090.140.060
5X36MM	25	39090.050.036	10X20MM	25	39090.100.020			
5X40MM	25	39090.050.040	10X24MM	25	39090.100.024	16X32MM	5	39090.160.032
			10X28MM	25	39090.100.028	16X40MM	5	39090.160.040
6X16MM	50	39090.060.016	10X30MM	25	39090.100.030	16X50MM	5	39090.160.050
6X20MM	50	39090.060.020	10X32MM	25	39090.100.032	16X60MM	5	39090.160.060
6X24MM	50	39090.060.024	10X36MM	10	39090.100.036	16X70MM	5	39090.160.070
6X28MM	50	39090.060.028	10X40MM	10	39090.100.040	16X80MM	5	39090.160.080
6X30MM	50	39090.060.030	10X45MM	10	39090.100.045	16X90MM	5	39090.160.090
6X32MM	25	39090.060.032	10X50MM	10	39090.100.050	16X100MM	5	39090.160.100
6X40MM	25	39090.060.040	10X60MM	10	39090.100.060	16X120MM	5	39090.160.120
6X45MM	25	39090.060.045	10X70MM	10	39090.100.070			
6X50MM	25	39090.060.050	10X80MM	10	39090.100.080	20X50MM	5	39090.200.050
6X60MM	25	39090.060.060	10X100MM	10	39090.100.100	20X60MM	5	39090.200.060
						20X70MM	5	39090.200.070
8X16MM	50	39090.080.016	12X24MM	10	39090.120.024	20X80MM	5	39090.200.080
8X20MM	50	39090.080.020	12X28MM	10	39090.120.028	20X100MM	5	39090.200.100
8X24MM	25	39090.080.024	12X30MM	10	39090.120.030	20X120MM	5	39090.200.120
8X28MM	25	39090.080.028	12X32MM	10	39090.120.032			
8X30MM	25	39090.080.030	12X36MM	10	39090.120.036	25X60MM	5	39090.250.060
8X32MM	25	39090.080.032	12X40MM	10	39090.120.040	25X70MM	5	39090.250.070
8X36MM	25	39090.080.036	12X45MM	10	39090.120.045			

Kołki z korbami równoległymi na całej długości, z pilotem

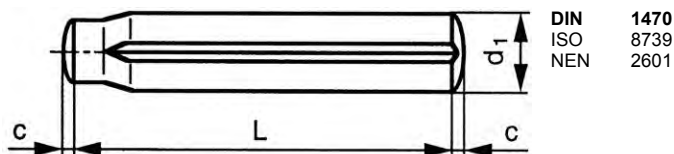

DIN 1470
ISO 8739
NEN 2601



Informacje techniczne

d_1	$c \approx$	Tolerancja	V	d_1	$c \approx$	Tolerancja	V
1.5	0.2	h9	1.6	4	0.5	h11	10.6
2	0.25	h9	2.85	5	0.6	h11	16.5
2.5	0.3	h9	4.25	6	0.8	h11	22.8
3	0.4	h9	6.15	8	1	h11	40.5

- V = Wytrzymałość na ścinanie podwójna min. w kN.
- Dla średnicy znamionowej otworu d, zalecana jest tolerancja H11.
- Długość znamionowa (L) nie obejmuje zaokrąglonych końców (tolerancja js15).

Przykład zastosowania

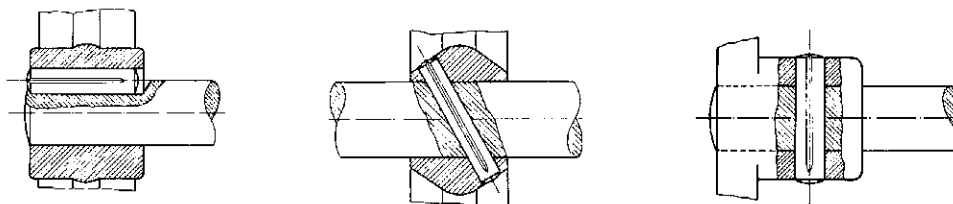

39700 Kołki z korbami równoległymi na całej długości, z pilotem

L11F

Materiał Stal automatowa



$d_1 \times L$	☒	Kod artykułu	$d_1 \times L$	☒	Kod artykułu	$d_1 \times L$	☒	Kod artykułu
1,5X4MM	200	39700.015.004	3X20MM	200	39700.030.020	6X16MM	100	39700.060.016
1,5X6MM	200	39700.015.006	3X30MM	200	39700.030.030	6X20MM	100	39700.060.020
1,5X8MM	200	39700.015.008				6X24MM	100	39700.060.024
1,5X10MM	200	39700.015.010	4X8MM	200	39700.040.008	6X30MM	100	39700.060.030
1,5X16MM	200	39700.015.016	4X10MM	200	39700.040.010	6X36MM	100	39700.060.036
			4X12MM	200	39700.040.012	6X40MM	100	39700.060.040
2X5MM	200	39700.020.005	4X16MM	200	39700.040.016	6X45MM	100	39700.060.045
2X6MM	200	39700.020.006	4X20MM	200	39700.040.020	6X50MM	100	39700.060.050
2X8MM	200	39700.020.008	4X24MM	200	39700.040.024	6X60MM	100	39700.060.060
2X10MM	200	39700.020.010	4X30MM	200	39700.040.030			
2X16MM	200	39700.020.016	4X36MM	100	39700.040.036	8X12MM	100	39700.080.012
2X20MM	200	39700.020.020	4X40MM	100	39700.040.040	8X16MM	100	39700.080.016
2X24MM	200	39700.020.024				8X20MM	100	39700.080.020
			5X12MM	200	39700.050.012	8X24MM	100	39700.080.024
2,5X10MM	200	39700.025.010	5X16MM	200	39700.050.016	8X30MM	100	39700.080.030
2,5X12MM	200	39700.025.012	5X20MM	100	39700.050.020	8X36MM	50	39700.080.036
2,5X16MM	200	39700.025.016	5X24MM	100	39700.050.024	8X40MM	50	39700.080.040
2,5X20MM	200	39700.025.020	5X30MM	100	39700.050.030	8X45MM	50	39700.080.045
			5X36MM	100	39700.050.036	8X50MM	50	39700.080.050
3X10MM	200	39700.030.010	5X40MM	100	39700.050.040	8X60MM	50	39700.080.060
3X12MM	200	39700.030.012				8X70MM	50	39700.080.070
3X16MM	200	39700.030.016	6X10MM	100	39700.060.010			

Kołki z karami zbieżnymi na całej długości

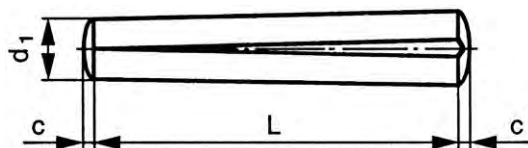

DIN 1471
ISO 8744
NEN 2602

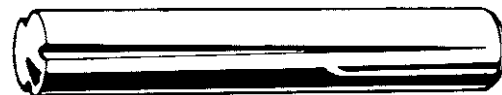

Informacje techniczne

d_1	$c \approx$	Tolerancja	V	d_1	$c \approx$	Tolerancja	V
1.5	0.2	h9	1.6	4	0.5	h11	10.6
2	0.25	h9	2.85	5	0.63	h11	16.5
2.5	0.3	h9	4.25	6	0.8	h11	22.8
3	0.4	h9	6.15	8	1	h11	40.5

- V = Wytrzymałość na ścinanie podwójna min. w kN.
- Dla średnicy znamionowej otworu d , zalecana jest tolerancja H11.
- Długość znamionowa (L) nie obejmuje zaokrąglonych końców (tolerancja js15).

Przykład zastosowania

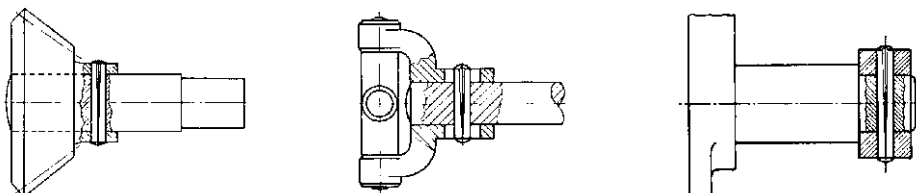

Grupy katalogowe



Material	Kod	Strona
Stal automatowa	39710	9-14
St.St. A1	51585	9-15

39710 Kołki z karami zbieżnymi na całej długości L11F

Material Stal automatowa

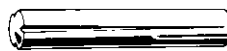

$d_1 \times L$	☒	Kod artykułu	$d_1 \times L$	☒	Kod artykułu	$d_1 \times L$	☒	Kod artykułu
1.5X4MM	200	39710.015.004				5X30MM	100	39710.050.030
1.5X5MM	200	39710.015.005	3X6MM	200	39710.030.006	5X36MM	100	39710.050.036
1.5X8MM	200	39710.015.008	3X8MM	200	39710.030.008	5X40MM	100	39710.050.040
1.5X10MM	200	39710.015.010	3X10MM	200	39710.030.010			
1.5X16MM	200	39710.015.016	3X12MM	200	39710.030.012	6X10MM	100	39710.060.010
1.5X20MM	200	39710.015.020	3X16MM	200	39710.030.016	6X12MM	100	39710.060.012
			3X20MM	200	39710.030.020	6X16MM	100	39710.060.016
2X5MM	200	39710.020.005	3X24MM	200	39710.030.024	6X20MM	100	39710.060.020
2X6MM	200	39710.020.006				6X24MM	100	39710.060.024
2X8MM	200	39710.020.008	4X8MM	200	39710.040.008	6X30MM	100	39710.060.030
2X10MM	200	39710.020.010	4X10MM	200	39710.040.010	6X40MM	100	39710.060.040
2X12MM	200	39710.020.012	4X12MM	200	39710.040.012	6X45MM	100	39710.060.045
2X16MM	200	39710.020.016	4X16MM	200	39710.040.016	6X50MM	100	39710.060.050
2X20MM	200	39710.020.020	4X20MM	200	39710.040.020	6X60MM	100	39710.060.060
2X24MM	200	39710.020.024	4X24MM	200	39710.040.024			
2X30MM	200	39710.020.030	4X30MM	200	39710.040.030	8X12MM	100	39710.080.012
			4X36MM	100	39710.040.036	8X16MM	100	39710.080.016
2.5X6MM	200	39710.025.006	4X40MM	100	39710.040.040	8X20MM	100	39710.080.020
2.5X8MM	200	39710.025.008				8X24MM	100	39710.080.024
2.5X10MM	200	39710.025.010	5X10MM	200	39710.050.010	8X30MM	100	39710.080.030
2.5X12MM	200	39710.025.012	5X12MM	200	39710.050.012	8X40MM	50	39710.080.040
2.5X16MM	200	39710.025.016	5X16MM	200	39710.050.016	8X50MM	50	39710.080.050
2.5X20MM	200	39710.025.020	5X20MM	100	39710.050.020	8X60MM	50	39710.080.060
2.5X30MM	200	39710.025.030	5X24MM	100	39710.050.024	8X70MM	50	39710.080.070

51585	Kołki z karami zbieżnymi na całej długości	R09A
Materiał	Stal nierdzewna A1	
		
		

d ₁ x L	☒	Kod artykułu	d ₁ x L	☒	Kod artykułu	d ₁ x L	☒	Kod artykułu
2X8MM*	500	51585.020.008	4X8MM*	200	51585.040.008	5X35MM*	200	51585.050.035
2X10MM*	500	51585.020.010	4X12MM*	200	51585.040.012	5X40MM*	200	51585.050.040
2X12MM*	500	51585.020.012	4X16MM*	200	51585.040.016	6X10MM*	100	51585.060.010
2X16MM*	500	51585.020.016	4X20MM*	200	51585.040.020	6X12MM*	100	51585.060.012
2X20MM*	500	51585.020.020	4X25MM*	200	51585.040.025	6X16MM*	100	51585.060.016
2.5X20MM*	500	51585.025.020	4X40MM*	200	51585.040.040	6X20MM*	100	51585.060.020
3X8MM*	500	51585.030.008	5X8MM*	200	51585.050.008	6X25MM*	100	51585.060.025
3X10MM*	500	51585.030.010	5X10MM*	200	51585.050.010	6X30MM*	100	51585.060.030
3X12MM*	500	51585.030.012	5X12MM*	200	51585.050.012	6X40MM*	100	51585.060.040
3X16MM*	500	51585.030.016	5X16MM*	200	51585.050.016	8X30MM*	50	51585.080.030
3X18MM*	500	51585.030.018	5X20MM*	200	51585.050.020	8X40MM*	50	51585.080.040
3X20MM*	500	51585.030.020	5X25MM*	200	51585.050.025	8X60MM*	50	51585.080.060
3X25MM*	500	51585.030.025	5X30MM*	200	51585.050.030			

Kołki z karami zbieżnymi na połowie długości

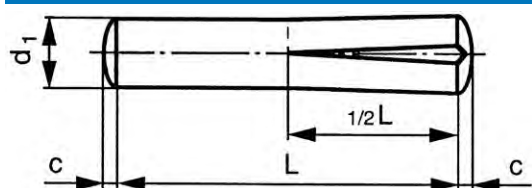

DIN 1472
ISO 8745
NEN 2603



Informacje techniczne

d ₁	c ≈	Tolerancja	V	d ₁	c ≈	Tolerancja	V
1.5	0.2	h9	1.6	4	0.5	h11	10.6
2	0.25	h9	2.85	5	0.6	h11	16.5
2.5	0.3	h9	4.25	6	0.8	h11	22.8
3	0.4	h9	6.15	8	1	h11	40.5

- V = Wytrzymałość na ścinanie podwójna min. w kN.
- Dla średnicy znamionowej otworu d₁ zalecana jest tolerancja H11.
- Długość znamionowa (L) nie obejmuje zaokrąglonych końców (tolerancja js15).

Przykład zastosowania

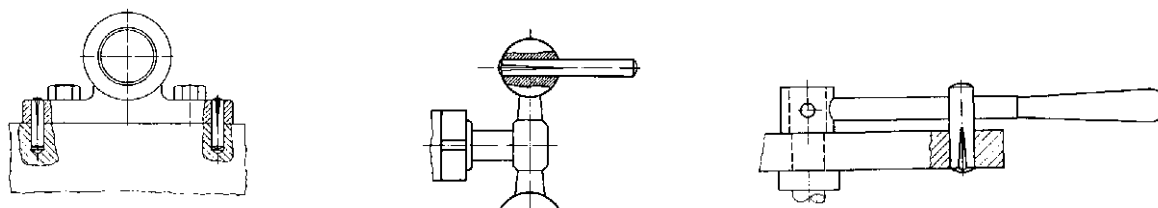

Grupy katalogowe

Materiał	Kod	Strona
Stal automatowa	39720	9-16
St.St. A1	51586	9-16

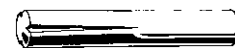
39720 Kołki z karami zbieżnymi na połowie długości L11F
Materiał Stal automatowa

d ₁ x L	☒	Kod artykułu	d ₁ x L	☒	Kod artykułu	d ₁ x L	☒	Kod artykułu
1,5X4MM	200	39720.015.004	3X20MM	200	39720.030.020	6X10MM	100	39720.060.010
1,5X6MM	200	39720.015.006	3X24MM	200	39720.030.024	6X12MM	100	39720.060.012
1,5X8MM	200	39720.015.008	3X30MM	200	39720.030.030	6X16MM	100	39720.060.016
1,5X12MM	200	39720.015.012				6X20MM	100	39720.060.020
1,5X16MM	200	39720.015.016	4X8MM	200	39720.040.008	6X24MM	100	39720.060.024
			4X10MM	200	39720.040.010	6X30MM	100	39720.060.030
2X6MM	200	39720.020.006	4X12MM	200	39720.040.012	6X36MM	100	39720.060.036
2X8MM	200	39720.020.008	4X16MM	200	39720.040.016	6X40MM	100	39720.060.040
2X10MM	200	39720.020.010	4X20MM	200	39720.040.020	6X50MM	100	39720.060.050
2X12MM	200	39720.020.012	4X24MM	200	39720.040.024	6X60MM	100	39720.060.060
2X16MM	200	39720.020.016	4X28MM	200	39720.040.028			
2X20MM	200	39720.020.020	4X30MM	200	39720.040.030	8X12MM	100	39720.080.012
			4X36MM	100	39720.040.036	8X16MM	100	39720.080.016
2,5X6MM	200	39720.025.006				8X20MM	100	39720.080.020
2,5X10MM	200	39720.025.010	5X8MM	200	39720.050.008	8X24MM	100	39720.080.024
2,5X12MM	200	39720.025.012	5X10MM	200	39720.050.010	8X30MM	100	39720.080.030
2,5X16MM	200	39720.025.016	5X12MM	200	39720.050.012	8X36MM	50	39720.080.036
2,5X20MM	250	39720.025.020	5X16MM	200	39720.050.016	8X40MM	50	39720.080.040
			5X20MM	100	39720.050.020	8X45MM	50	39720.080.045
3X8MM	200	39720.030.008	5X24MM	100	39720.050.024	8X50MM	50	39720.080.050
3X10MM	200	39720.030.010	5X30MM	100	39720.050.030	8X60MM	50	39720.080.060
3X12MM	200	39720.030.012	5X40MM	100	39720.050.040	8X70MM	50	39720.080.070
3X16MM	200	39720.030.016						

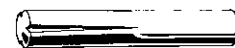
51586 Kołki z karami zbieżnymi na połowie długości R09A
Materiał Stal nierdzewna A1

d ₁ x L	☒	Kod artykułu	d ₁ x L	☒	Kod artykułu	d ₁ x L	☒	Kod artykułu
2X6MM*	500	51586.020.006	4X16MM*	200	51586.040.016	6X16MM*	100	51586.060.016
2X8MM*	500	51586.020.008	4X18MM*	200	51586.040.018	6X18MM*	100	51586.060.018
2X10MM*	500	51586.020.010	4X20MM*	200	51586.040.020	6X20MM*	100	51586.060.020
2X12MM*	500	51586.020.012	4X25MM*	200	51586.040.025	6X25MM*	100	51586.060.025
2X16MM*	500	51586.020.016	4X30MM*	200	51586.040.030	6X30MM*	100	51586.060.030
			4X35MM*	200	51586.040.035	6X35MM*	100	51586.060.035
3X6MM*	500	51586.030.006	4X40MM*	200	51586.040.040	6X40MM*	100	51586.060.040
3X8MM*	500	51586.030.008				6X50MM*	100	51586.060.050
3X10MM*	500	51586.030.010	5X10MM*	200	51586.050.010			
3X12MM*	500	51586.030.012	5X12MM*	200	51586.050.012	8X12MM*	50	51586.080.012
3X16MM*	500	51586.030.016	5X16MM*	200	51586.050.016	8X16MM*	50	51586.080.016
3X18MM*	500	51586.030.018	5X18MM*	200	51586.050.018	8X20MM*	50	51586.080.020
3X20MM*	500	51586.030.020	5X20MM*	200	51586.050.020	8X25MM*	50	51586.080.025
3X25MM*	500	51586.030.025	5X25MM*	200	51586.050.025	8X30MM*	50	51586.080.030
			5X30MM*	200	51586.050.030	8X35MM*	50	51586.080.035
4X8MM*	200	51586.040.008	5X40MM*	200	51586.050.040	8X40MM*	50	51586.080.040
4X10MM*	200	51586.040.010				8X60MM*	50	51586.080.060
4X12MM*	200	51586.040.012	6X12MM*	100	51586.060.012			

Kołki z korbami równoległymi na całej długości, ze ścięciem

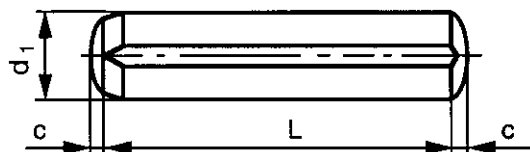

DIN 1473
ISO 8740
NEN 2604

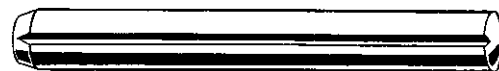

Informacje techniczne

d_1	$c \approx$	Tolerancja	V	d_1	$c \approx$	Tolerancja	V
1.5	0.2	h9	1.6	4	0.4	h11	10.6
2	0.25	h9	2.85	5	0.6	h11	16.5
2.5	0.3	h9	4.25	6	0.8	h11	22.8
3	0.4	h9	6.15	8	1	h11	40.5

- V = Wytrzymałość na ścinanie podwójna min. w kN.
- Dla średnicy znamionowej otworu d, zalecana jest tolerancja H11.
- Długość znamionowa (L) nie obejmuje zaokrąglonych końców (tolerancja js15).

Przykład zastosowania

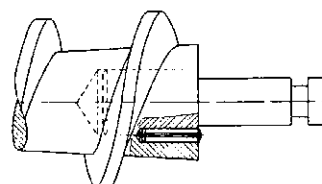
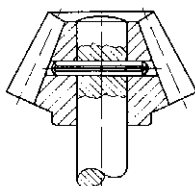
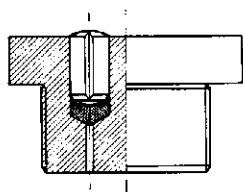

Grupy katalogowe

Material	Kod	Strona
Stal automatowa	39730	9-17
St.St. A1	51582	9-18

39730 Kołki z korbami równoległymi na całej długości, ze ścięciem

L11F

Material Stal automatowa

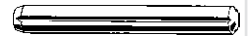

$d_1 \times L$	☒	Kod artykułu	$d_1 \times L$	☒	Kod artykułu	$d_1 \times L$	☒	Kod artykułu
1,5X5MM	200	39730.015.005	3X10MM	200	39730.030.010	5X40MM	100	39730.050.040
1,5X6MM	200	39730.015.006	3X12MM	200	39730.030.012			
1,5X8MM	200	39730.015.008	3X16MM	200	39730.030.016	6X10MM	100	39730.060.010
1,5X10MM	200	39730.015.010	3X20MM	200	39730.030.020	6X12MM	100	39730.060.012
1,5X12MM	200	39730.015.012	3X24MM	200	39730.030.024	6X16MM	100	39730.060.016
1,5X16MM	200	39730.015.016	3X30MM	200	39730.030.030	6X20MM	100	39730.060.020
						6X24MM	100	39730.060.024
2X5MM	200	39730.020.005	4X8MM	200	39730.040.008	6X30MM	100	39730.060.030
2X6MM	200	39730.020.006	4X10MM	200	39730.040.010	6X36MM	100	39730.060.036
2X8MM	200	39730.020.008	4X12MM	200	39730.040.012	6X40MM	100	39730.060.040
2X10MM	200	39730.020.010	4X16MM	200	39730.040.016	6X45MM	100	39730.060.045
2X12MM	200	39730.020.012	4X20MM	200	39730.040.020	6X50MM	100	39730.060.050
2X16MM	200	39730.020.016	4X24MM	200	39730.040.024	6X60MM	100	39730.060.060
2X20MM	200	39730.020.020	4X30MM	200	39730.040.030			
2X24MM	200	39730.020.024	4X36MM	100	39730.040.036	8X12MM	100	39730.080.012
2X30MM	200	39730.020.030	4X40MM	100	39730.040.040	8X16MM	100	39730.080.016
						8X20MM	100	39730.080.020
2,5X10MM	200	39730.025.010	5X8MM	200	39730.050.008	8X24MM	100	39730.080.024
2,5X12MM	200	39730.025.012	5X10MM	200	39730.050.010	8X30MM	100	39730.080.030
2,5X16MM	200	39730.025.016	5X12MM	200	39730.050.012	8X36MM	50	39730.080.036
2,5X20MM	200	39730.025.020	5X16MM	200	39730.050.016	8X40MM	50	39730.080.040
2,5X24MM	200	39730.025.024	5X20MM	100	39730.050.020	8X45MM	50	39730.080.045
			5X24MM	100	39730.050.024	8X50MM	50	39730.080.050
3X6MM	200	39730.030.006	5X30MM	100	39730.050.030	8X60MM	50	39730.080.060
3X8MM	200	39730.030.008	5X36MM	100	39730.050.036	8X70MM	50	39730.080.070

51582 Kołki z karami równoległymi na całej długości, ze ścięciem
R09A
Materiał Stal nierdzewna A1

$d_1 \times L$	☒	Kod artykułu	$d_1 \times L$	☒	Kod artykułu	$d_1 \times L$	☒	Kod artykułu
2X8MM*	500	51582.020.008	4X20MM*	200	51582.040.020	6X18MM*	100	51582.060.018
2X10MM*	500	51582.020.010	4X25MM*	200	51582.040.025	6X20MM*	100	51582.060.020
2X12MM*	500	51582.020.012	4X30MM*	200	51582.040.030	6X25MM*	100	51582.060.025
2X16MM*	500	51582.020.016	4X35MM*	200	51582.040.035	6X30MM*	100	51582.060.030
2X20MM*	500	51582.020.020	4X40MM*	200	51582.040.040	6X35MM*	100	51582.060.035
3X8MM*	500	51582.030.008	5X10MM*	200	51582.050.010	6X40MM*	100	51582.060.040
3X10MM*	500	51582.030.010	5X12MM*	200	51582.050.012	6X45MM*	100	51582.060.045
3X12MM*	500	51582.030.012	5X16MM*	200	51582.050.016	6X50MM*	100	51582.060.050
3X16MM*	500	51582.030.016	5X20MM*	200	51582.050.020	6X60MM*	100	51582.060.060
3X18MM*	500	51582.030.018	5X25MM*	200	51582.050.025	8X12MM*	50	51582.080.012
3X20MM*	500	51582.030.020	5X30MM*	200	51582.050.030	8X16MM*	50	51582.080.016
3X25MM*	500	51582.030.025	5X35MM*	200	51582.050.035	8X20MM*	50	51582.080.020
4X8MM*	200	51582.040.008	5X40MM*	200	51582.050.040	8X25MM*	50	51582.080.025
4X10MM*	200	51582.040.010	6X10MM*	100	51582.060.010	8X30MM*	50	51582.080.030
4X12MM*	200	51582.040.012	6X12MM*	100	51582.060.012	8X35MM*	50	51582.080.035
4X16MM*	200	51582.040.016	6X16MM*	100	51582.060.016	8X40MM*	50	51582.080.040
4X18MM*	200	51582.040.018				8X50MM*	50	51582.080.050

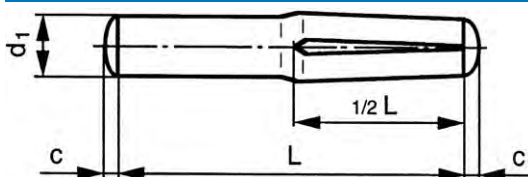
Kołki z karami na połowie długości zbieżnymi do czoła

DIN 1474
ISO 8741
NEN 2605

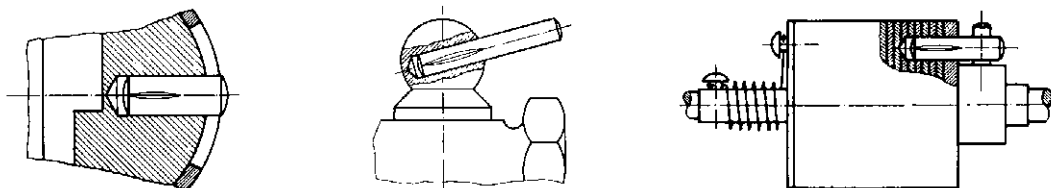

Informacje techniczne

d_1	$c \approx$	Tolerancja	V	d_1	$c \approx$	Tolerancja	V
1.5	0.2	h9	1.6	4	0.5	h11	10.6
2	0.25	h9	2.85	5	0.63	h11	16.5
2.5	0.3	h9	4.25	6	0.8	h11	22.8
3	0.4	h9	6.15	8	1	h11	40.5

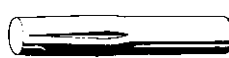

- V = Wytrzymałość na ścinanie podwójna min. w kN.
- Dla średnicy znamionowej otworu d_1 zalecana jest tolerancja H11.
- Długość znamionowa (L) nie obejmuje zaokrąglonych końców (tolerancja js15).

9
Przykład zastosowania

Grupy katalogowe

Materiał	Kod	Strona
Stal automatowa	39740	9-19
St.St. A1	51583	9-19

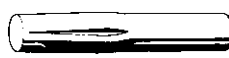
39740	Kołki z korbami na połowie długości zbieżnymi do czoła	L11F
Materiał	Stal automatowa	
		

d ₁ x L	☒	Kod artykułu	d ₁ x L	☒	Kod artykułu	d ₁ x L	☒	Kod artykułu
1,5X5MM	200	39740.015.005	3X16MM	200	39740.030.016	6X12MM	100	39740.060.012
1,5X6MM	200	39740.015.006	3X20MM	200	39740.030.020	6X16MM	100	39740.060.016
1,5X8MM	200	39740.015.008	3X24MM	200	39740.030.024	6X20MM	100	39740.060.020
1,5X10MM	200	39740.015.010	3X30MM	200	39740.030.030	6X24MM	100	39740.060.024
1,5X12MM	200	39740.015.012				6X30MM	100	39740.060.030
			4X8MM	200	39740.040.008	6X40MM	100	39740.060.040
2X5MM	200	39740.020.005	4X10MM	200	39740.040.010	6X45MM	100	39740.060.045
2X6MM	200	39740.020.006	4X12MM	200	39740.040.012	6X50MM	100	39740.060.050
2X8MM	200	39740.020.008	4X16MM	200	39740.040.016	6X60MM	100	39740.060.060
2X10MM	200	39740.020.010	4X20MM	200	39740.040.020			
2X12MM	200	39740.020.012	4X24MM	200	39740.040.024	8X12MM	100	39740.080.012
2X16MM	200	39740.020.016	4X30MM	200	39740.040.030	8X16MM	100	39740.080.016
			4X36MM	100	39740.040.036	8X20MM	100	39740.080.020
2,5X6MM	200	39740.025.006				8X24MM	100	39740.080.024
2,5X8MM	200	39740.025.008	5X8MM	200	39740.050.008	8X30MM	100	39740.080.030
2,5X10MM	200	39740.025.010	5X10MM	200	39740.050.010	8X36MM	50	39740.080.036
2,5X12MM	200	39740.025.012	5X12MM	200	39740.050.012	8X40MM	50	39740.080.040
2,5X16MM	200	39740.025.016	5X16MM	200	39740.050.016	8X45MM	50	39740.080.045
			5X20MM	100	39740.050.020	8X50MM	50	39740.080.050
3X6MM	200	39740.030.006	5X24MM	100	39740.050.024	8X60MM	50	39740.080.060
3X8MM	200	39740.030.008	5X30MM	100	39740.050.030	8X70MM	50	39740.080.070
3X10MM	200	39740.030.010	5X36MM	100	39740.050.036			
3X12MM	200	39740.030.012						

51583	Kołki z korbami na połowie długości zbieżnymi do czoła	R09A
Materiał	Stal nierdzewna A1	
		

d ₁ x L	☒	Kod artykułu	d ₁ x L	☒	Kod artykułu	d ₁ x L	☒	Kod artykułu
2X8MM*	500	51583.020.008	4X10MM*	200	51583.040.010	5X25MM*	200	51583.050.025
2X10MM*	500	51583.020.010	4X12MM*	200	51583.040.012	5X35MM*	200	51583.050.035
2X12MM*	500	51583.020.012	4X16MM*	200	51583.040.016			
2X16MM*	500	51583.020.016	4X20MM*	200	51583.040.020	6X16MM*	100	51583.060.016
			4X25MM*	200	51583.040.025	6X20MM*	100	51583.060.020
3X8MM*	500	51583.030.008				6X30MM*	100	51583.060.030
3X10MM*	500	51583.030.010	5X12MM*	200	51583.050.012	6X40MM*	100	51583.060.040
3X12MM*	500	51583.030.012	5X16MM*	200	51583.050.016			
3X16MM*	500	51583.030.016	5X18MM*	200	51583.050.018	8X40MM*	100	51583.080.040
			5X20MM*	200	51583.050.020			

Kołki z karami w środkowej części na 1/3 długości

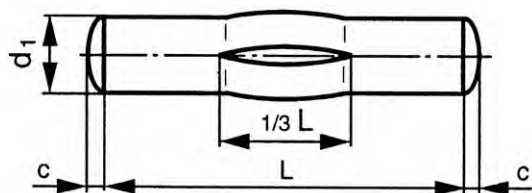

DIN 1475
ISO 8742
NEN 2606



Informacje techniczne

d_1	$c \approx$	Tolerancja	V	d_1	$c \approx$	Tolerancja	V
1.5	0.2	h9	1.6	4	0.5	h11	10.6
2	0.25	h9	2.85	5	0.6	h11	16.5
2.5	0.3	h9	4.25	6	0.8	h11	22.8
3	0.4	h11	6.15	8	1	h11	40.5

- V = Wytrzymałość na ścinanie podwójna min. w kN.
- Dla średnicy znamionowej otworu d , zalecana jest tolerancja H11.
- Długość znamionowa (L) nie obejmuje zaokrąglonych końców (tolerancja js15).

Przykład zastosowania

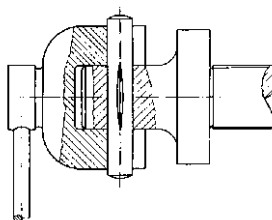
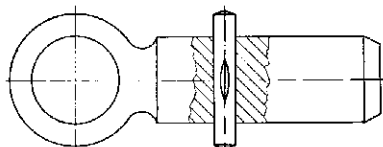

39750 Kołki z karami w środkowej części na 1/3 długości

L11F

Materiał Stal automatowa



$d_1 \times L$	☒	Kod artykułu	$d_1 \times L$	☒	Kod artykułu	$d_1 \times L$	☒	Kod artykułu
1.5X8MM	200	39750.015.008	3X12MM	200	39750.030.012	6X12MM	100	39750.060.012
1.5X10MM	200	39750.015.010	3X16MM	200	39750.030.016	6X16MM	100	39750.060.016
1.5X16MM	200	39750.015.016	3X20MM	200	39750.030.020	6X20MM	100	39750.060.020
2X6MM	200	39750.020.006	3X24MM	200	39750.030.024	6X24MM	100	39750.060.024
2X10MM	200	39750.020.010	3X30MM	200	39750.030.030	6X30MM	100	39750.060.030
2X12MM	200	39750.020.012	4X12MM	200	39750.040.012	6X36MM	100	39750.060.036
2X16MM	200	39750.020.016	4X16MM	200	39750.040.016	6X40MM	100	39750.060.040
2X20MM	200	39750.020.020	4X20MM	200	39750.040.020	6X45MM	100	39750.060.045
2X24MM	200	39750.020.024	4X24MM	200	39750.040.024	6X50MM	100	39750.060.050
2.5X8MM	200	39750.025.008	4X30MM	200	39750.040.030	6X60MM	100	39750.060.060
2.5X10MM	200	39750.025.010	4X36MM	100	39750.040.036	8X20MM	100	39750.080.020
2.5X12MM	200	39750.025.012	4X40MM	100	39750.040.040	8X24MM	100	39750.080.024
2.5X16MM	200	39750.025.016	5X10MM	200	39750.050.010	8X30MM	100	39750.080.030
2.5X20MM	200	39750.025.020	5X12MM	200	39750.050.012	8X36MM	50	39750.080.036
2.5X24MM	200	39750.025.024	5X16MM	200	39750.050.016	8X40MM	50	39750.080.040
2.5X30MM	200	39750.025.030	5X20MM	100	39750.050.020	8X45MM	50	39750.080.045
3X6MM	200	39750.030.006	5X24MM	100	39750.050.024	8X50MM	50	39750.080.050
3X8MM	200	39750.030.008	5X30MM	100	39750.050.030	8X60MM	50	39750.080.060
3X10MM	200	39750.030.010	5X36MM	100	39750.050.036			
			5X40MM	100	39750.050.040			

Nitokołki z łbem kulistym

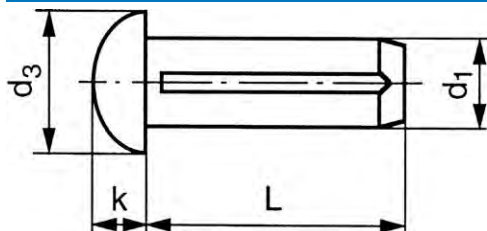

DIN 1476
ISO 8746
NEN 2460

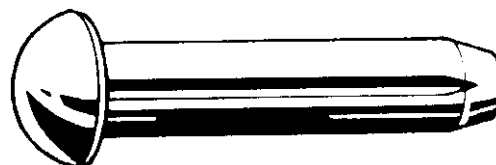

Informacje techniczne

d ₁	d ₃	k	Tolerancja
1.4	2.4	0.8	0/ - 0.05
1.7 (#DIN)	3	1	0/ - 0.05
2	3.5	1.2	0/ - 0.05
2.5	4.4	1.4	0/ - 0.05
2.6 (#DIN)	4.5	1.6	0/ - 0.075
3	5.2	1.8	0/ - 0.075
4	7	2.4	0/ - 0.1
5	8.8	3	0/ - 0.1
6	10.5	3.6	0/ - 0.1

- Dla średnicy znamionowej otworu d₁ zalecana jest tolerancja H11.
- Długość znamionowa (L) ma pole tolerancji js15.

Grupy katalogowe

Material	Kod	Strona
St UTS 36-2	39760	9-21
St.St. A2	51589	9-21

39760 Nitokołki z łbem kulistym

L11F

Material Stal UTS 36-2

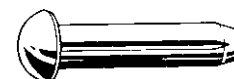

d ₁ x L	☒	Kod artykułu	d ₁ x L	☒	Kod artykułu	d ₁ x L	☒	Kod artykułu
1,4X3MM	200	39760.014.003	2,6X4MM	200	39760.026.004	4X10MM	200	39760.040.010
1,4X4MM	200	39760.014.004	2,6X5MM	200	39760.026.005	4X12MM	200	39760.040.012
1,4X6MM	200	39760.014.006	2,6X6MM	200	39760.026.006	4X15MM	200	39760.040.015
1,7X3MM	200	39760.017.003	2,6X8MM	200	39760.026.008	5X8MM	200	39760.050.008
1,7X4MM	200	39760.017.004	2,6X10MM	200	39760.026.010	5X10MM	200	39760.050.010
1,7X5MM	200	39760.017.005	3X4MM	200	39760.030.004	5X12MM	200	39760.050.012
1,7X6MM	200	39760.017.006	3X5MM	200	39760.030.005	5X15MM	200	39760.050.015
2X3MM	200	39760.020.003	3X6MM	200	39760.030.006	5X20MM	200	39760.050.020
2X4MM	200	39760.020.004	3X8MM	200	39760.030.008	5X25MM	200	39760.050.025
2X5MM	200	39760.020.005	3X10MM	200	39760.030.010	6X10MM	200	39760.060.010
2X6MM	200	39760.020.006	3X12MM	200	39760.030.012	6X12MM	200	39760.060.012
2X8MM	200	39760.020.008	3X15MM	200	39760.030.015	6X15MM	200	39760.060.015
2X10MM	200	39760.020.010	4X6MM	200	39760.040.006	6X20MM	200	39760.060.020
2,6X3MM	200	39760.026.003	4X8MM	200	39760.040.008	6X25MM	200	39760.060.025

51589 Nitokołki z łbem kulistym

R09A

Material Stal nierdzewna A2

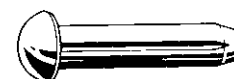

d ₁ x L	☒	Kod artykułu	d ₁ x L	☒	Kod artykułu	d ₁ x L	☒	Kod artykułu
2X3MM*	500	51589.020.003	2,5X3MM*	500	51589.025.003	3X4MM*	500	51589.030.004
2X4MM*	500	51589.020.004	2,5X4MM*	500	51589.025.004	3X5MM	500	51589.030.005
2X5MM*	500	51589.020.005	2,5X5MM*	500	51589.025.005	3X6MM*	500	51589.030.006
2X6MM*	500	51589.020.006	2,5X6MM*	500	51589.025.006	3X8MM*	500	51589.030.008
2X8MM*	500	51589.020.008	2,5X8MM*	500	51589.025.008	3X10MM*	500	51589.030.010
2X10MM*	500	51589.020.010	2,5X10MM*	500	51589.025.010	3X12MM*	500	51589.030.012
						3X16MM*	500	51589.030.016

51589		Nitokołki z łbem kulistym						
$d_1 \times L$	☒	Kod artykułu	$d_1 \times L$	☒	Kod artykułu	$d_1 \times L$	☒	Kod artykułu
4X5MM*	200	51589.040.005	4X10MM*	200	51589.040.010	5X8MM*	200	51589.050.008
4X6MM*	200	51589.040.006	4X12MM*	200	51589.040.012	5X10MM*	200	51589.050.010
4X8MM*	200	51589.040.008	5X6MM*	200	51589.050.006	5X12MM*	200	51589.050.012
						5X16MM*	200	51589.050.016

Nitowkręty

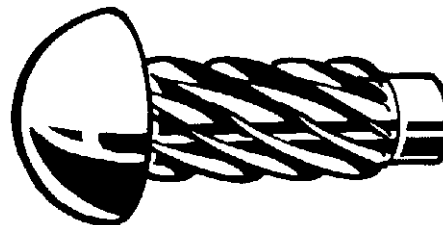
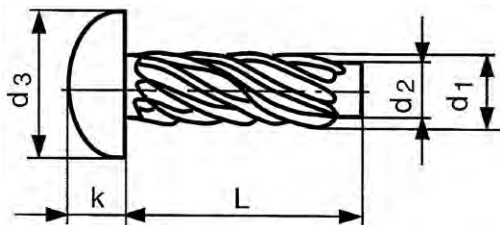

Informacje techniczne

d_1	d_2	d_3	k	Otwór $\varnothing \approx$
1.5	1.35	2.5	0.8	1.4
1.9	1.7	3.2	1.2	1.7
2.5	2.15	4.1	1.7	2.2
2.9	2.65	5.3	2.1	2.6
3.5	3.1	6.6	2.6	3.1

27410 Nitowkręty J04A

Materiał Stal
Obróbka powierzchni Niklowane



$d_1 \times L$	☒	Kod artykułu	$d_1 \times L$	☒	Kod artykułu	$d_1 \times L$	☒	Kod artykułu
1,5X3,2MM	500	27410.015.003	2,5X3,2MM	500	27410.025.003	2,9X6,5MM	500	27410.029.006
1,5X4,7MM	500	27410.015.004	2,5X4,7MM	500	27410.025.004	2,9X8MM	500	27410.029.008
1,5X6,5MM	500	27410.015.006	2,5X6,5MM	500	27410.025.006	3,5X6,5MM	500	27410.035.006
1,9X3,2MM	500	27410.019.003				3,5X8MM	500	27410.035.008
1,9X4,7MM	500	27410.019.004	2,9X4,7MM	500	27410.029.004	3,5X9,5MM	500	27410.035.009
1,9X6,5MM	500	27410.019.006						

Kołki sprężyste zwijane zwykłe

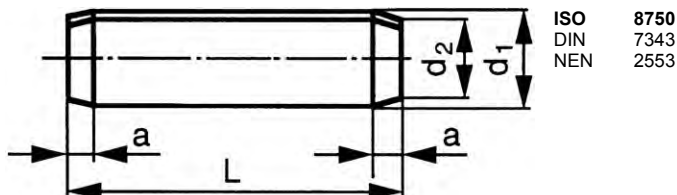

ISO 8750
DIN 7343
NEN 2553



Informacje techniczne

d (nom.)	a ≈	d ₁ (maks.)	d ₁ (min.)	d ₂	V
1	0.3	1.15	1.05	0.95	0.6
1.5	0.5	1.73	1.62	1.4	1.45
2	0.7	2.25	2.13	1.9	2.5
2.5	0.7	2.78	2.65	2.4	3.9
3	0.9	3.3	3.15	2.9	5.5
4	1.1	4.4	4.2	3.9	9.6
5	1.3	5.5	5.25	4.85	15
6	1.5	6.5	6.25	5.85	22
8	2	8.63	8.3	7.8	39
10	2.5	10.8	10.35	9.75	62
12	3	12.85	12.4	11.7	89
14	3.5	14.95	14.45	13.6	120
16	4	17	16.45	15.6	155

- V = Wytrzymałość na ścinanie podwójna min. w kN.
- Cechy szczególne kołków sprężystych zwijanych zwykłych:
- Są stosowane do łączenia (pozyjonowania) z możliwością rozłączania dwóch lub więcej części; mogą być również stosowane jako wałki, przetyczki zawiąsów, czy zawlecзки.
- Z uwagi na spiralny kształt przekroju poprzecznego (ok. 2.1/4 zwojów) kołki sprężyste zwijane zwykłe są bardzo elastyczne i nadają się do wielokrotnego stosowania pod obciążeniami dynamicznymi.
- Równe rozprowadzenie naprężeń przez przekrój poprzeczny kołka na ściany otworu powoduje dobre pasowanie wtlaczane, mogące wytrzymać siły ścinające niezależnie od ich kierunku.
- Kształtowana faza na obu końcach, pozwala na ich łatwe, automatyczne wkładanie i instalowanie.
- Dla otworu średnicy d (znam.) zalecana jest tolerancja H12 z wyjątkiem średnicy znamionowej d = 1mm, gdzie zalecana jest tolerancja H10.

Przykład zastosowania



39140 Kołki sprężyste zwijane zwykłe

L09A

Materiał Stal sprężynowa 420-560 HV30

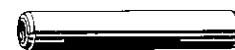

d (nom.) x L	☒	Kod artykułu	d (nom.) x L	☒	Kod artykułu	d (nom.) x L	☒	Kod artykułu
1,5X4MM	200	39140.015.004	2,5X10MM	200	39140.025.010	3X28MM	200	39140.030.028
1,5X6MM	200	39140.015.006	2,5X12MM	200	39140.025.012	3X30MM	200	39140.030.030
1,5X8MM	200	39140.015.008	2,5X14MM	200	39140.025.014			
1,5X10MM	200	39140.015.010	2,5X16MM	200	39140.025.016	4X10MM	200	39140.040.010
1,5X12MM	200	39140.015.012	2,5X18MM	200	39140.025.018	4X12MM	200	39140.040.012
1,5X14MM	200	39140.015.014	2,5X20MM	200	39140.025.020	4X16MM	200	39140.040.016
1,5X16MM	200	39140.015.016	2,5X24MM	200	39140.025.024	4X18MM	200	39140.040.018
						4X20MM	200	39140.040.020
2X6MM	200	39140.020.006	3X8MM	200	39140.030.008	4X22MM	200	39140.040.022
2X8MM	200	39140.020.008	3X10MM	200	39140.030.010	4X24MM	200	39140.040.024
2X10MM	200	39140.020.010	3X12MM	200	39140.030.012	4X26MM	200	39140.040.026
2X12MM	200	39140.020.012	3X14MM	200	39140.030.014	4X28MM	200	39140.040.028
2X14MM	200	39140.020.014	3X16MM	200	39140.030.016	4X30MM	200	39140.040.030
2X16MM	200	39140.020.016	3X20MM	200	39140.030.020	4X32MM	100	39140.040.032
2X20MM	200	39140.020.020	3X22MM	200	39140.030.022	4X35MM	100	39140.040.035
			3X24MM	200	39140.030.024	4X40MM	100	39140.040.040
2,5X8MM	200	39140.025.008	3X26MM	200	39140.030.026			

39140 Kołki sprężyste zwijane zwykłe								
d (nom.) x L	☒	Kod artykułu	d (nom.) x L	☒	Kod artykułu	d (nom.) x L	☒	Kod artykułu
5X12MM	200	39140.050.012	6X45MM	50	39140.060.045	10X70MM	25	39140.100.070
5X16MM	200	39140.050.016	6X50MM	50	39140.060.050	10X80MM	10	39140.100.080
5X20MM	100	39140.050.020						
5X22MM	100	39140.050.022	8X20MM	100	39140.080.020	12X30MM	25	39140.120.030
5X24MM	100	39140.050.024	8X24MM	100	39140.080.024	12X35MM	25	39140.120.035
5X26MM	100	39140.050.026	8X30MM	50	39140.080.030	12X40MM	25	39140.120.040
5X28MM	100	39140.050.028	8X32MM	50	39140.080.032	12X50MM	10	39140.120.050
5X30MM	100	39140.050.030	8X35MM	50	39140.080.035	12X55MM	10	39140.120.055
5X32MM	100	39140.050.032	8X40MM	50	39140.080.040	12X60MM	10	39140.120.060
5X35MM	100	39140.050.035	8X50MM	50	39140.080.050	12X70MM	10	39140.120.070
5X40MM	100	39140.050.040	8X60MM	50	39140.080.060	12X80MM	10	39140.120.080
5X45MM	100	39140.050.045	8X70MM	25	39140.080.070	12X85MM	10	39140.120.085
						12X90MM	10	39140.120.090
6X12MM	200	39140.060.012	10X20MM	50	39140.100.020	12X100MM	10	39140.120.100
6X16MM	200	39140.060.016	10X22MM	50	39140.100.022	12X120MM	10	39140.120.120
6X20MM	100	39140.060.020	10X24MM	50	39140.100.024			
6X24MM	100	39140.060.024	10X28MM	50	39140.100.028	16X40MM	5	39140.160.040
6X26MM	100	39140.060.026	10X30MM	50	39140.100.030	16X50MM	5	39140.160.050
6X28MM	100	39140.060.028	10X35MM	25	39140.100.035	16X60MM	5	39140.160.060
6X30MM	100	39140.060.030	10X40MM	25	39140.100.040	16X80MM	5	39140.160.080
6X32MM	100	39140.060.032	10X45MM	25	39140.100.045	16X90MM	5	39140.160.090
6X35MM	100	39140.060.035	10X50MM	25	39140.100.050	16X100MM	5	39140.160.100
6X40MM	100	39140.060.040	10X60MM	25	39140.100.060	16X120MM	5	39140.160.120

• Ostrzeżenie: cynkowanie elektrolityczne tych produktów może wywołać kruchość wodorową.

Kołki sprężyste zwijane, standardowe

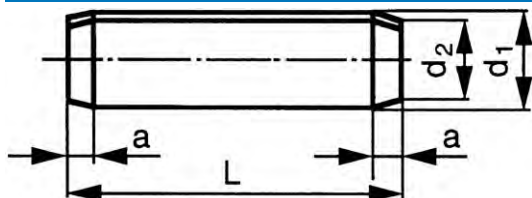

ISO ≈8750
DIN ≈7343
NEN ≈2553



Informacje techniczne

d (nom.)	a ≈	d ₁ (maks.)	d ₁ (min.)	d ₂	V
1	0.3	1.15	1.05	0.95	0.45
1.5	0.5	1.73	1.62	1.4	1.05
2	0.7	2.25	2.13	1.9	1.9
2.5	0.7	2.78	2.65	2.4	2.9
3	0.9	3.3	3.15	2.9	4.2
4	1.1	4.4	4.2	3.9	7.6
5	1.3	5.5	5.25	4.85	11.5
6	1.5	6.5	6.25	5.85	16.8
8	2	8.63	8.3	7.8	30

- V = Wytrzymałość na ścinanie podwójna min. w kN.
- Cechy szczególne kołków sprężystych zwijanych zwykłych:
- Są stosowane do łączenia (pozycjonowania) z możliwością rozłączania dwóch lub więcej części; mogą być również stosowane jako wałki, przetyczki zawiązków, czy zawlecзки.
- Z uwagi na spiralny kształt przekroju poprzecznego (ok. 2.1/4 zwojów) kołki sprężyste zwijane zwykłe są bardzo elastyczne i nadają się do wielokrotnego stosowania pod obciążeniami dynamicznymi.
- Równe rozprowadzenie naprężeń przez przekrój poprzeczny kołka na ściany otworu powoduje dobre pasowanie włączane, mogące wytrzymać siły ścinające niezależnie od ich kierunku.
- Kształtowana faza na obu końcach, pozwala na ich łatwe, automatyczne wkładanie i instalowanie.
- Typ stali austenicznej pozostaje do decyzji producenta i może się różnić od typów stali podanych w ISO 3506
- Dla otworu średnicy d (znam.) zalecana jest tolerancja H12 z wyjątkiem średnicy znamionowej d = 1mm, gdzie zalecana jest tolerancja H10.

51430 Kołki sprężyste zwijane, standardowe R09A

Materiał Stal nierdzewna A2



d (nom.) x L	☒	Kod artykułu	d (nom.) x L	☒	Kod artykułu	d (nom.) x L	☒	Kod artykułu
1X4MM	200	51430.010.004	1,5X4MM	200	51430.015.004	1,5X14MM	200	51430.015.014
1X6MM	200	51430.010.006	1,5X5MM	200	51430.015.005	1,5X16MM	200	51430.015.016
1X8MM	200	51430.010.008	1,5X6MM*	1000	51430.015.006			
1X10MM	200	51430.010.010	1,5X8MM	200	51430.015.008	2X5MM*	1000	51430.020.005
1X12MM	200	51430.010.012	1,5X10MM	200	51430.015.010	2X6MM	200	51430.020.006
			1,5X12MM	200	51430.015.012	2X8MM	200	51430.020.008

51430 Kołki sprężyste zwijane zwykłe								
d (nom.) x L	☒	Kod artykułu	d (nom.) x L	☒	Kod artykułu	d (nom.) x L	☒	Kod artykułu
2X10MM	200	51430.020.010	4X8MM	200	51430.040.008	5X40MM	100	51430.050.040
2X12MM	200	51430.020.012	4X10MM	200	51430.040.010	5X45MM	100	51430.050.045
2X14MM	200	51430.020.014	4X12MM	200	51430.040.012	5X50MM	100	51430.050.050
2X16MM	200	51430.020.016	4X14MM	200	51430.040.014			
2X18MM	200	51430.020.018	4X16MM	200	51430.040.016	6X12MM	200	51430.060.012
2X20MM	200	51430.020.020	4X18MM	200	51430.040.018	6X14MM	200	51430.060.014
			4X20MM	200	51430.040.020	6X16MM	200	51430.060.016
2,5X6MM*	1000	51430.025.006	4X22MM	200	51430.040.022	6X18MM	100	51430.060.018
2,5X8MM	200	51430.025.008	4X24MM	200	51430.040.024	6X20MM	100	51430.060.020
2,5X10MM	200	51430.025.010	4X26MM	200	51430.040.026	6X22MM	100	51430.060.022
2,5X12MM	200	51430.025.012	4X28MM	200	51430.040.028	6X24MM	100	51430.060.024
2,5X14MM	200	51430.025.014	4X30MM	200	51430.040.030	6X26MM	100	51430.060.026
2,5X16MM	200	51430.025.016	4X32MM*	500	51430.040.032	6X28MM	100	51430.060.028
2,5X18MM	200	51430.025.018	4X35MM	100	51430.040.035	6X30MM	100	51430.060.030
2,5X20MM	200	51430.025.020	4X40MM	100	51430.040.040	6X32MM	100	51430.060.032
2,5X24MM	200	51430.025.024	4X45MM*	500	51430.040.045	6X35MM	100	51430.060.035
			4X50MM*	500	51430.040.050	6X40MM	100	51430.060.040
3X8MM	200	51430.030.008				6X45MM	100	51430.060.045
3X10MM	200	51430.030.010	5X10MM*	500	51430.050.010	6X50MM	100	51430.060.050
3X12MM	200	51430.030.012	5X12MM	200	51430.050.012			
3X14MM	200	51430.030.014	5X14MM	200	51430.050.014	8X16MM	100	51430.080.016
3X16MM	200	51430.030.016	5X16MM	200	51430.050.016	8X20MM	100	51430.080.020
3X18MM	200	51430.030.018	5X18MM	100	51430.050.018	8X24MM	100	51430.080.024
3X20MM	200	51430.030.020	5X20MM	100	51430.050.020	8X26MM	50	51430.080.026
3X22MM	200	51430.030.022	5X22MM*	500	51430.050.022	8X28MM	50	51430.080.028
3X24MM	200	51430.030.024	5X24MM	100	51430.050.024	8X30MM	50	51430.080.030
3X26MM	200	51430.030.026	5X26MM	100	51430.050.026	8X32MM	50	51430.080.032
3X28MM	200	51430.030.028	5X28MM	100	51430.050.028	8X35MM	50	51430.080.035
3X30MM	200	51430.030.030	5X30MM	100	51430.050.030	8X40MM	50	51430.080.040
3X32MM*	500	51430.030.032	5X32MM	100	51430.050.032	8X45MM	50	51430.080.045
			5X35MM	100	51430.050.035	8X50MM	50	51430.080.050

Kołki sprężyste zwijane wzmocnione

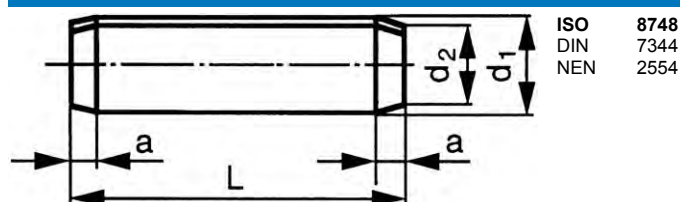

ISO 8748
DIN 7344
NEN 2554



Informacje techniczne

d (nom.)	a ≈	d ₁ (maks.)	d ₁ (min.)	d ₂	V
1.5	0.5	1.71	1.61	1.4	1.9
2	0.7	2.21	2.11	1.9	3.5
2.5	0.7	2.73	2.62	2.4	5.5
3	0.9	3.25	3.12	2.9	7.6
4	1.1	4.3	4.15	3.9	13.5
5	1.3	5.35	5.15	4.85	20
6	1.5	6.4	6.18	5.85	30

- V = Wytrzymałość na ścinanie podwójna min. w kN.
- Cechy szczególne kołków sprężystych zwijanych zwykłych:
- Są stosowane do łączenia (pozycjonowania) z możliwością rozłączania dwóch lub więcej części; mogą być również stosowane jako wałki, przetyczki zawiąsów, czy zawleczki.
- Z uwagi na spiralny kształt przekroju poprzecznego (ok. 2.1/4 zwojów) kołki sprężyste zwijane zwykłe są bardzo elastyczne i nadają się do wielokrotnego stosowania pod obciążeniami dynamicznymi.
- Równe rozprowadzenie naprężeń przez przekrój poprzeczny kołka na ściany otworu powoduje dobre pasowanie włączane, mogące wytrzymać siły ścinające niezależnie od ich kierunku.
- Kształtowana faza na obu końcach, pozwala na ich łatwe, automatyczne wkładanie i instalowanie.
- Dla otworu średnicy d (znam.) zalecana jest tolerancja H12 z wyjątkiem średnicy znamionowej d = 1mm, gdzie zalecana jest tolerancja H10

39150 Kołki sprężyste zwijane wzmocnione				L09A	
Materiał	Stal sprężynowa 420-560 HV30				

d (nom.) x L	☒	Kod artykułu	d (nom.) x L	☒	Kod artykułu	d (nom.) x L	☒	Kod artykułu
1,5X4MM	200	39150.015.004	1,5X10MM	200	39150.015.010	2X6MM	200	39150.020.006
1,5X5MM	200	39150.015.005	1,5X12MM	200	39150.015.012	2X8MM	200	39150.020.008
1,5X6MM	200	39150.015.006	1,5X14MM	200	39150.015.014	2X10MM	200	39150.020.010
1,5X8MM	200	39150.015.008	1,5X16MM	200	39150.015.016			

39150 Kołki sprężyste zwijane wzmocnione								
d (nom.) x L	☒	Kod artykułu	d (nom.) x L	☒	Kod artykułu	d (nom.) x L	☒	Kod artykułu
2X12MM	200	39150.020.012	3X30MM	200	39150.030.030	5X24MM	100	39150.050.024
2X14MM	200	39150.020.014				5X26MM	100	39150.050.026
2X16MM	200	39150.020.016	4X10MM	200	39150.040.010	5X28MM	100	39150.050.028
2X20MM	200	39150.020.020	4X12MM	200	39150.040.012	5X30MM	100	39150.050.030
			4X14MM	200	39150.040.014	5X32MM	100	39150.050.032
2.5X10MM	200	39150.025.010	4X16MM	200	39150.040.016	5X35MM	100	39150.050.035
2.5X12MM	200	39150.025.012	4X18MM	200	39150.040.018	5X40MM	100	39150.050.040
2.5X14MM	200	39150.025.014	4X20MM	200	39150.040.020	5X45MM	100	39150.050.045
2.5X16MM	200	39150.025.016	4X22MM	200	39150.040.022			
2.5X18MM	200	39150.025.018	4X24MM	200	39150.040.024	6X14MM	100	39150.060.014
2.5X20MM	200	39150.025.020	4X26MM	200	39150.040.026	6X16MM	100	39150.060.016
2.5X22MM	200	39150.025.022	4X28MM	200	39150.040.028	6X18MM	100	39150.060.018
2.5X24MM	200	39150.025.024	4X30MM	200	39150.040.030	6X20MM	100	39150.060.020
			4X32MM	100	39150.040.032	6X22MM	100	39150.060.022
3X8MM	200	39150.030.008	4X35MM	100	39150.040.035	6X24MM	100	39150.060.024
3X10MM	200	39150.030.010	4X40MM	100	39150.040.040	6X26MM	100	39150.060.026
3X12MM	200	39150.030.012				6X28MM	100	39150.060.028
3X14MM	200	39150.030.014	5X12MM	200	39150.050.012	6X30MM	100	39150.060.030
3X16MM	200	39150.030.016	5X14MM	200	39150.050.014	6X32MM	100	39150.060.032
3X20MM	200	39150.030.020	5X16MM	200	39150.050.016	6X35MM	100	39150.060.035
3X22MM	200	39150.030.022	5X18MM	100	39150.050.018	6X40MM	100	39150.060.040
3X24MM	200	39150.030.024	5X20MM	100	39150.050.020	6X50MM	100	39150.060.050
3X28MM	200	39150.030.028	5X22MM	100	39150.050.022			

• Ostrzeżenie: cynkowanie elektrolityczne tych produktów może wywołać kruchość wodorową.

Kołki sprężyste rozcięte wzmocnione

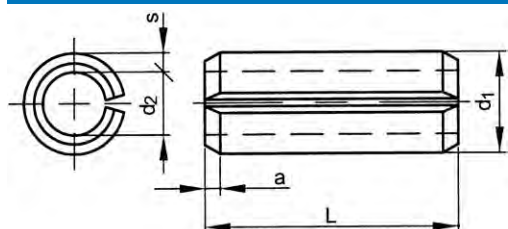

ISO 8752
DIN 1481
NEN 2458
BS 7060



Informacje techniczne

d (nom.)	a (min.)	d ₁ (maks.)	d ₁ (min.)	d ₂ ≈	s	V
1.5	0.25	1.8	1.7	1.1	0.3	1.58
2	0.35	2.4	2.3	1.5	0.4	2.82
2.5	0.4	2.9	2.8	1.8	0.5	4.38
3	0.5	3.5	3.3	2.1	0.6	6.32
3.5	0.6	4	3.8	2.3	0.75	9.06
4	0.65	4.6	4.4	2.8	0.8	11.24
4.5	0.8	5.1	4.9	2.9	1	15.36
5	0.9	5.6	5.4	3.4	1	17.54
6	1.2	6.7	6.4	3.9	1.25	26.04
7 (#DIN)	2	7.8	7.5	4.5	1.5	31.4
8	1.6	8.8	8.5	5.5	1.5	42.76
9 (#DIN)	2	9.8	9.5	5.5	2	60.66
10	2	10.8	10.5	6.5	2	70.16
12	2	12.8	12.5	7.5	2.5	104.1
13	2	13.8	13.5	8.5	2.5	115.1
14	2	14.8	14.4	8.5	3	144.7
16	2	16.8	16.5	10.5	3	171
18	2	18.9	18.5	11.5	3.5	222.5
20	3	20.9	20.5	12.5	4	280.6

• V = Wytrzymałość na ścinanie podwójna min. w kN.
• Dla średnicy znamionowej otworu d zalecana jest tolerancja H12.

Specjalne właściwości kołków walcowych typu sprężystego:

- używane do wzajemnego łączenia dwóch lub większej liczby elementów konstrukcyjnych
- bardzo odpowiednie do pochłaniania sił tnących
- w celu uniknięcia przemieszczeń w niewielkich sprężynujących połączeniach śrubowych, typy kołków walcowych mogą zostać użyte zgodnie z informacją zamieszczoną poniżej:

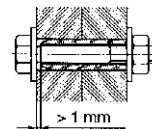

d (nom.) typ sprężysty kołek walcowy rowkowany (karbowany)	6	8	10	12	16	18
Przeznaczone dla śrub o rozmiarach	M3	M4	M5	M6	M8	M10
Podkładki współpracujące według normy DIN 7349	3,2	4,3	5,3	6,4	8,4	10,5

39100 Kołki sprężyste rozcięte wzmocnione L09A

Materiał Stal sprężynowa 420-560 HV30





d (nom.) x L	☒	Kod artykułu	d (nom.) x L	☒	Kod artykułu	d (nom.) x L	☒	Kod artykułu
1,5X6MM	200	39100.015.006	3,5X30MM	200	39100.035.030	6X22MM	100	39100.060.022
1,5X8MM	200	39100.015.008	3,5X32MM	200	39100.035.032	6X24MM	100	39100.060.024
1,5X10MM	200	39100.015.010	3,5X35MM	200	39100.035.035	6X26MM	100	39100.060.026
1,5X12MM	200	39100.015.012	3,5X40MM	200	39100.035.040	6X28MM	100	39100.060.028
1,5X16MM	200	39100.015.016	3,5X45MM	200	39100.035.045	6X30MM	100	39100.060.030
1,5X20MM	200	39100.015.020	3,5X50MM	200	39100.035.050	6X32MM	100	39100.060.032
						6X35MM	100	39100.060.035
2X4MM	200	39100.020.004	4X8MM	200	39100.040.008	6X40MM	100	39100.060.040
2X8MM	200	39100.020.008	4X10MM	200	39100.040.010	6X45MM	50	39100.060.045
2X10MM	200	39100.020.010	4X12MM	200	39100.040.012	6X50MM	50	39100.060.050
2X12MM	200	39100.020.012	4X14MM	200	39100.040.014	6X55MM	50	39100.060.055
2X14MM	200	39100.020.014	4X16MM	200	39100.040.016	6X60MM	50	39100.060.060
2X16MM	200	39100.020.016	4X18MM	200	39100.040.018	6X65MM	50	39100.060.065
2X20MM	200	39100.020.020	4X20MM	200	39100.040.020	6X70MM	50	39100.060.070
2X24MM	200	39100.020.024	4X22MM	200	39100.040.022	6X80MM	50	39100.060.080
2X26MM	200	39100.020.026	4X24MM	200	39100.040.024	6X90MM	50	39100.060.090
2X30MM	200	39100.020.030	4X26MM	200	39100.040.026	6X100MM	50	39100.060.100
2X40MM	200	39100.020.040	4X28MM	200	39100.040.028			
			4X30MM	200	39100.040.030	8X16MM	500	39100.080.016
2,5X6MM	1	39100.025.006	4X32MM	100	39100.040.032	8X20MM	50	39100.080.020
2,5X8MM	200	39100.025.008	4X35MM	100	39100.040.035	8X24MM	50	39100.080.024
2,5X10MM	200	39100.025.010	4X40MM	100	39100.040.040	8X26MM	50	39100.080.026
2,5X12MM	200	39100.025.012	4X45MM	100	39100.040.045	8X30MM	50	39100.080.030
2,5X16MM	200	39100.025.016	4X50MM	100	39100.040.050	8X32MM	50	39100.080.032
2,5X18MM	200	39100.025.018	4X60MM	100	39100.040.060	8X35MM	50	39100.080.035
2,5X20MM	200	39100.025.020				8X40MM	50	39100.080.040
2,5X24MM	200	39100.025.024	4,5X10MM	200	39100.045.010	8X45MM	50	39100.080.045
2,5X26MM	200	39100.025.026	4,5X12MM	200	39100.045.012	8X50MM	50	39100.080.050
2,5X28MM	200	39100.025.028	4,5X14MM	200	39100.045.014	8X55MM	50	39100.080.055
2,5X30MM	200	39100.025.030	4,5X16MM	200	39100.045.016	8X60MM	50	39100.080.060
2,5X35MM	200	39100.025.035	4,5X20MM	200	39100.045.020	8X70MM	25	39100.080.070
2,5X40MM	200	39100.025.040	4,5X30MM	100	39100.045.030	8X80MM	25	39100.080.080
			4,5X40MM	200	39100.045.040	8X100MM	10	39100.080.100
3X6MM	200	39100.030.006	4,5X45MM	100	39100.045.045			
3X8MM	200	39100.030.008	4,5X50MM	200	39100.045.050	10X20MM	50	39100.100.020
3X10MM	200	39100.030.010	4,5X60MM	200	39100.045.060	10X22MM	50	39100.100.022
3X12MM	200	39100.030.012				10X24MM	50	39100.100.024
3X14MM	200	39100.030.014	5X10MM	200	39100.050.010	10X26MM	50	39100.100.026
3X16MM	200	39100.030.016	5X12MM	200	39100.050.012	10X30MM	50	39100.100.030
3X18MM	200	39100.030.018	5X16MM	100	39100.050.016	10X35MM	50	39100.100.035
3X20MM	200	39100.030.020	5X18MM	100	39100.050.018	10X40MM	25	39100.100.040
3X22MM	200	39100.030.022	5X20MM	100	39100.050.020	10X45MM	25	39100.100.045
3X24MM	200	39100.030.024	5X24MM	100	39100.050.024	10X50MM	25	39100.100.050
3X26MM	200	39100.030.026	5X26MM	100	39100.050.026	10X55MM	25	39100.100.055
3X28MM	200	39100.030.028	5X28MM	100	39100.050.028	10X60MM	25	39100.100.060
3X30MM	200	39100.030.030	5X30MM	100	39100.050.030	10X70MM	25	39100.100.070
3X32MM	200	39100.030.032	5X32MM	100	39100.050.032	10X75MM	25	39100.100.075
3X35MM	200	39100.030.035	5X35MM	100	39100.050.035	10X80MM	10	39100.100.080
3X40MM	200	39100.030.040	5X40MM	100	39100.050.040	10X90MM	10	39100.100.090
3X45MM	200	39100.030.045	5X45MM	100	39100.050.045	10X100MM	10	39100.100.100
3X50MM	200	39100.030.050	5X50MM	100	39100.050.050			
			5X55MM	100	39100.050.055	12X24MM	25	39100.120.024
3,5X10MM	200	39100.035.010	5X60MM	100	39100.050.060	12X30MM	25	39100.120.030
3,5X12MM	200	39100.035.012	5X70MM	50	39100.050.070	12X36MM	25	39100.120.036
3,5X16MM	200	39100.035.016	5X80MM	50	39100.050.080	12X40MM	25	39100.120.040
3,5X18MM	200	39100.035.018				12X45MM	100	39100.120.045
3,5X20MM	200	39100.035.020	6X12MM	200	39100.060.012	12X50MM	10	39100.120.050
3,5X22MM	200	39100.035.022	6X16MM	100	39100.060.016	12X60MM	10	39100.120.060
3,5X24MM	200	39100.035.024	6X18MM	100	39100.060.018	12X65MM	10	39100.120.065
3,5X26MM	200	39100.035.026	6X20MM	100	39100.060.020	12X70MM	10	39100.120.070

39100 Kołki sprężyste rozcięte wzmocnione								
d (nom.) x L	☒	Kod artykułu	d (nom.) x L	☒	Kod artykułu	d (nom.) x L	☒	Kod artykułu
12X80MM	10	39100.120.080	16X70MM	5	39100.160.070	20X60MM	5	39100.200.060
12X90MM	10	39100.120.090	16X75MM	5	39100.160.075	20X70MM	5	39100.200.070
12X100MM	10	39100.120.100	16X80MM	5	39100.160.080	20X80MM	5	39100.200.080
12X120MM	10	39100.120.120	16X90MM	5	39100.160.090	20X85MM	5	39100.200.085
16X36MM	5	39100.160.036	16X100MM	5	39100.160.100	20X90MM	5	39100.200.090
16X40MM	5	39100.160.040	16X120MM	5	39100.160.120	20X95MM	5	39100.200.095
16X50MM	5	39100.160.050	18X50MM	5	39100.180.050	20X100MM	5	39100.200.100
16X60MM	5	39100.160.060				20X120MM	5	39100.200.120

• Ostrzeżenie: cynkowanie elektrolityczne tych produktów może wywołać kruchość wodorową.

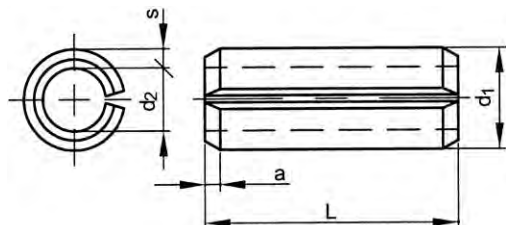
Kołki sprężyste rozcięte lekkie



ISO 13337
DIN 7346
NEN 2459



Informacje techniczne

d (nom.)	a	d ₁ (maks.)	d ₁ (min.)	d ₂ ≈	s	V
2	0.2	2.4	2.3	1.9	0.2	1.5
2.5	0.25	2.9	2.8	2.3	0.25	2.4
3	0.25	3.5	3.3	2.7	0.3	3.5
4	0.5	4.6	4.4	3.4	0.5	8
5	0.5	5.6	5.4	4.4	0.5	10.4
6	0.7	6.7	6.4	4.9	0.75	18
8	1.5	8.8	8.5	7	0.75	24
10	2	10.8	10.5	8.5	1	40
13	2	13.8	13.5	11	1.25	66

- V-1 = Wytrzymałość na ścinanie podwójna min. w kN.
- V-2 = Wytrzymałość na ścinanie podwójna min. w kN.
- Dla średnicy znamionowej otworu d zalecana jest tolerancja H12.
- a: kołki ponad 10mm mają jedną krawędź ściętą.

Specjalne właściwości kołków walcowych typu sprężystego:

- używane do wzajemnego łączenia dwóch lub większej liczby elementów konstrukcyjnych
- bardzo odpowiednie do pochłaniania sił tnących
- w celu uniknięcia przemieszczeń w niewielkich sprężynujących połączeniach śrubowych, typy kołków walcowych mogą zostać użyte zgodnie z informacją zamieszczoną poniżej:

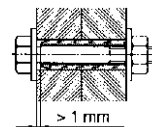

d (nom.) typ sprężysty kołek walcowy rowkowany (karbowany)	6	7	8	11	13	16	18
Przeznaczone dla śrub o rozmiarach	M4	M5	M6	M8	M10	M12	M14
Podkładki współpracujące według normy DIN 125-1 A	4,3	5,3	6,4	8,4	10,5	13	15

39060 Kołki sprężyste rozcięte lekkie		L09A
Materiał	Stal sprężynowa 420-560 HV30	

d (nom.) x L	☒	Kod artykułu	d (nom.) x L	☒	Kod artykułu	d (nom.) x L	☒	Kod artykułu
2X8MM	200	39060.020.008	2,5X10MM	200	39060.025.010	3X20MM	200	39060.030.020
2X10MM	200	39060.020.010	2,5X12MM	200	39060.025.012	3X22MM	200	39060.030.022
2X12MM	200	39060.020.012	2,5X14MM	200	39060.025.014	3X24MM	200	39060.030.024
2X14MM	200	39060.020.014	2,5X16MM	200	39060.025.016	3X30MM	200	39060.030.030
2X16MM	200	39060.020.016	2,5X20MM	200	39060.025.020	3X36MM	200	39060.030.036
2X18MM	200	39060.020.018	2,5X24MM	200	39060.025.024	3X40MM	200	39060.030.040
2X20MM	200	39060.020.020	2,5X30MM	200	39060.025.030			
2X24MM	200	39060.020.024				4X10MM	200	39060.040.010
2X28MM	200	39060.020.028	3X8MM	200	39060.030.008	4X12MM	200	39060.040.012
			3X10MM	200	39060.030.010	4X14MM	200	39060.040.014
2,5X6MM	200	39060.025.006	3X12MM	200	39060.030.012	4X16MM	200	39060.040.016
2,5X8MM	200	39060.025.008	3X16MM	200	39060.030.016	4X20MM	200	39060.040.020

39060 Kołki sprężyste rozcięte lekkie								
d (nom.) x L	☒	Kod artykułu	d (nom.) x L	☒	Kod artykułu	d (nom.) x L	☒	Kod artykułu
4X22MM	200	39060.040.022	5X40MM	100	39060.050.040	8X22MM	100	39060.080.022
4X24MM	200	39060.040.024				8X24MM	100	39060.080.024
4X28MM	200	39060.040.028	6X10MM	200	39060.060.010	8X26MM	100	39060.080.026
4X30MM	200	39060.040.030	6X12MM	200	39060.060.012	8X30MM	50	39060.080.030
4X36MM	100	39060.040.036	6X16MM	200	39060.060.016	8X32MM	50	39060.080.032
4X40MM	100	39060.040.040	6X20MM	100	39060.060.020	8X36MM	50	39060.080.036
4X45MM	100	39060.040.045	6X24MM	100	39060.060.024	8X40MM	50	39060.080.040
4X50MM	100	39060.040.050	6X28MM	100	39060.060.028	8X45MM	50	39060.080.045
			6X30MM	100	39060.060.030	8X50MM	50	39060.080.050
5X6MM	200	39060.050.006	6X32MM	100	39060.060.032			
5X8MM	200	39060.050.008	6X36MM	100	39060.060.036	10X12MM	50	39060.100.012
5X10MM	200	39060.050.010	6X40MM	100	39060.060.040	10X16MM	50	39060.100.016
5X12MM	200	39060.050.012	6X50MM	50	39060.060.050	10X20MM	50	39060.100.020
5X16MM	200	39060.050.016				10X24MM	50	39060.100.024
5X20MM	100	39060.050.020	8X10MM	100	39060.080.010	10X30MM	50	39060.100.030
5X28MM	100	39060.050.028	8X12MM	100	39060.080.012	10X40MM	25	39060.100.040
5X30MM	100	39060.050.030	8X16MM	100	39060.080.016	10X50MM	25	39060.100.050
5X36MM	100	39060.050.036	8X20MM	100	39060.080.020	10X60MM	25	39060.100.060

• Ostrzeżenie: cynkowanie elektrolityczne tych produktów może wywołać kruchość wodorową.

Kołki sprężyste rozcięte wzmocnione

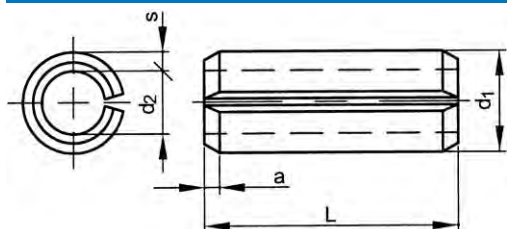

DIN ≈1481
ISO ≈8752
NEN ≈2458
BS ≈7060



Informacje techniczne

d (nom.)	a	d ₁ (maks.)	d ₁ (min.)	d ₂ ≈	s	V
1	0.15	1.3	1.2	0.8	0.2	0.44
1.5	0.25	1.8	1.7	1.1	0.3	0.98
2	0.35	2.4	2.3	1.5	0.4	1.8
2.5	0.4	2.9	2.8	1.8	0.5	2.84
3	0.5	3.5	3.3	2.1	0.6	4.06
3.5	0.6	4	3.8	2.3	0.75	9.06
4	0.65	4.6	4.4	2.8	0.8	7.24
4.5	0.8	5.1	4.9	2.9	1	15.36
5	0.9	5.6	5.4	3.4	1	10.74
6	1.2	6.7	6.4	3.9	1.25	16.16
8	2	8.8	8.5	5.5	1.5	26.46
10	2	10.8	10.5	6.5	2	42.14
12	2	12.8	12.5	7.5	2.5	-

- V = Wytrzymałość na ścinanie podwójna min. w kN.
- Typ stali austenicznej pozostaje do decyzji producenta i może się różnić od typów stali podanych w DIN 267-11.
- Dla średnicy znamionowej otworu d zalecana jest tolerancja H12.
- a: krawędzie ścięte dwustronnie pod kątem 30°, aż do rozmiaru 7mm włącznie, kołki ponad 7mm mają jedną krawędź ściętą pod kątem 15°.

Specjalne właściwości kołków walcowych typu sprężystego:

- używane do wzajemnego łączenia dwóch lub większej liczby elementów konstrukcyjnych
- bardzo odpowiednie do pochłaniania sił tnących
- w celu uniknięcia przemieszczeń w niewielkich sprężynujących połączeniach śrubowych, typy kołków walcowych mogą zostać użyte zgodnie z informacją zamieszczoną poniżej:

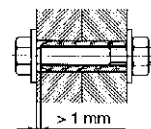

d (nom.) typ sprężysty kołek walcowy rowkowany (karbowany)	6	8	10	12	16	18
Przeznaczone dla śrub o rozmiarach	M3	M4	M5	M6	M8	M10
Podkładki współpracujące według normy DIN 7349	3,2	4,3	5,3	6,4	8,4	10,5

Materiał Stal nierdzewna A2

d (nom.) x L	☒	Kod artykułu	d (nom.) x L	☒	Kod artykułu	d (nom.) x L	☒	Kod artykułu
1X4MM*	1000	51428.010.004	3,5X20MM*	1000	51428.035.020	6X20MM	500	51428.060.020
1X5MM*	1000	51428.010.005	3,5X22MM*	1000	51428.035.022	6X22MM*	500	51428.060.022
1X10MM*	1000	51428.010.010	3,5X24MM*	1000	51428.035.024	6X24MM	100	51428.060.024
1X12MM*	1000	51428.010.012	3,5X26MM*	1000	51428.035.026	6X26MM	100	51428.060.026
1X14MM*	1000	51428.010.014	3,5X28MM*	1000	51428.035.028	6X28MM*	500	51428.060.028
1X16MM*	1000	51428.010.016	3,5X30MM*	1000	51428.035.030	6X30MM	100	51428.060.030
1X18MM*	1000	51428.010.018	3,5X32MM*	1000	51428.035.032	6X32MM	100	51428.060.032
			3,5X36MM*	1000	51428.035.036	6X35MM	50	51428.060.035
1,5X4MM*	1000	51428.015.004	3,5X40MM*	1000	51428.035.040	6X36MM	100	51428.060.036
1,5X5MM*	1000	51428.015.005				6X40MM	100	51428.060.040
1,5X6MM	200	51428.015.006	4X4MM*	500	51428.040.004	6X45MM*	250	51428.060.045
1,5X8MM	200	51428.015.008	4X5MM*	500	51428.040.005	6X50MM	50	51428.060.050
1,5X10MM	200	51428.015.010	4X6MM*	500	51428.040.006	6X55MM*	250	51428.060.055
1,5X12MM	200	51428.015.012	4X8MM*	500	51428.040.008	6X60MM	50	51428.060.060
1,5X14MM*	1000	51428.015.014	4X10MM*	500	51428.040.010	6X65MM*	250	51428.060.065
1,5X16MM	200	51428.015.016	4X12MM	200	51428.040.012	6X70MM	50	51428.060.070
1,5X18MM*	1000	51428.015.018	4X14MM	200	51428.040.014	6X75MM*	250	51428.060.075
1,5X20MM	200	51428.015.020	4X16MM	200	51428.040.016	6X80MM	50	51428.060.080
			4X18MM*	500	51428.040.018			
2X4MM*	1000	51428.020.004	4X20MM	200	51428.040.020	8X10MM*	500	51428.080.010
2X5MM*	1000	51428.020.005	4X22MM*	500	51428.040.022	8X12MM*	500	51428.080.012
2X6MM	200	51428.020.006	4X24MM	200	51428.040.024	8X14MM*	500	51428.080.014
2X8MM	200	51428.020.008	4X26MM	200	51428.040.026	8X16MM*	500	51428.080.016
2X10MM	200	51428.020.010	4X28MM*	500	51428.040.028	8X18MM*	500	51428.080.018
2X12MM	200	51428.020.012	4X30MM	200	51428.040.030	8X20MM*	500	51428.080.020
2X14MM*	1000	51428.020.014	4X32MM	100	51428.040.032	8X22MM*	500	51428.080.022
2X16MM	200	51428.020.016	4X35MM	50	51428.040.035	8X24MM*	500	51428.080.024
2X18MM*	1000	51428.020.018	4X40MM	100	51428.040.040	8X26MM*	250	51428.080.026
2X20MM	200	51428.020.020	4X45MM*	500	51428.040.045	8X28MM*	250	51428.080.028
2X22MM*	1000	51428.020.022	4X50MM	100	51428.040.050	8X30MM	50	51428.080.030
2X24MM	200	51428.020.024				8X32MM*	250	51428.080.032
2X26MM*	1000	51428.020.026	4,5X10MM*	500	51428.045.010	8X35MM	50	51428.080.035
2X30MM	200	51428.020.030	4,5X12MM*	500	51428.045.012	8X40MM	50	51428.080.040
			4,5X14MM*	500	51428.045.014	8X45MM*	250	51428.080.045
2,5X4MM*	1000	51428.025.004	4,5X16MM*	500	51428.045.016	8X50MM	50	51428.080.050
2,5X5MM*	1000	51428.025.005	4,5X18MM*	500	51428.045.018	8X55MM*	250	51428.080.055
2,5X6MM*	1000	51428.025.006	4,5X20MM*	500	51428.045.020	8X60MM	50	51428.080.060
2,5X8MM*	1000	51428.025.008	4,5X24MM*	500	51428.045.024	8X65MM*	250	51428.080.065
2,5X10MM*	1000	51428.025.010	4,5X26MM*	500	51428.045.026	8X70MM	50	51428.080.070
2,5X12MM	200	51428.025.012	4,5X28MM*	500	51428.045.028	8X75MM*	250	51428.080.075
2,5X14MM	200	51428.025.014	4,5X30MM*	500	51428.045.030	8X80MM	50	51428.080.080
2,5X16MM	200	51428.025.016	4,5X32MM*	500	51428.045.032	8X85MM*	200	51428.080.085
2,5X18MM*	1000	51428.025.018	4,5X36MM*	500	51428.045.036	8X90MM*	100	51428.080.090
2,5X20MM	200	51428.025.020	4,5X40MM*	500	51428.045.040	8X100MM	50	51428.080.100
2,5X22MM*	1000	51428.025.022	4,5X45MM*	500	51428.045.045			
2,5X24MM	200	51428.025.024	4,5X50MM*	500	51428.045.050			
2,5X26MM	200	51428.025.026				10X12MM*	500	51428.100.012
2,5X28MM	200	51428.025.028	5X6MM*	500	51428.050.006	10X14MM*	500	51428.100.014
2,5X30MM	200	51428.025.030	5X8MM*	500	51428.050.008	10X16MM*	500	51428.100.016
			5X10MM*	500	51428.050.010	10X18MM*	500	51428.100.018
3X4MM*	1000	51428.030.004	5X12MM*	500	51428.050.012	10X20MM	50	51428.100.020
3X5MM*	1000	51428.030.005	5X14MM*	500	51428.050.014	10X22MM*	500	51428.100.022
3X6MM*	1000	51428.030.006	5X16MM	100	51428.050.016	10X25MM*	500	51428.100.025
3X8MM	200	51428.030.008	5X18MM*	500	51428.050.018	10X26MM*	500	51428.100.026
3X10MM	200	51428.030.010	5X20MM	100	51428.050.020	10X28MM*	500	51428.100.028
3X12MM	200	51428.030.012	5X22MM*	500	51428.050.022	10X30MM	50	51428.100.030
3X14MM	200	51428.030.014	5X24MM	100	51428.050.024	10X32MM*	500	51428.100.032
3X16MM	200	51428.030.016	5X26MM	100	51428.050.026	10X35MM	25	51428.100.035
3X18MM	200	51428.030.018	5X30MM	100	51428.050.030	10X36MM*	250	51428.100.036
3X20MM	200	51428.030.020	5X32MM*	500	51428.050.032	10X40MM	25	51428.100.040
3X22MM*	1000	51428.030.022	5X35MM	100	51428.050.035	10X45MM*	250	51428.100.045
3X24MM	200	51428.030.024	5X36 MM	100	51428.050.036	10X50MM	25	51428.100.050
3X26 MM	200	51428.030.026	5X40MM	100	51428.050.040	10X55MM*	200	51428.100.055
3X28MM*	1000	51428.030.028	5X45MM	100	51428.050.045	10X60MM	25	51428.100.060
3X30MM	200	51428.030.030	5X50MM	100	51428.050.050	10X65MM*	200	51428.100.065
3X32MM	200	51428.030.032	5X55MM*	250	51428.050.055	10X70MM	25	51428.100.070
3X35MM	200	51428.030.035	5X60MM	100	51428.050.060	10X75MM*	100	51428.100.075
3X40MM	200	51428.030.040	5X65MM*	250	51428.050.065	10X80MM	10	51428.100.080
			5X70MM	100	51428.050.070	10X85MM*	100	51428.100.085
3,5X8MM*	1000	51428.035.008				10X90MM*	100	51428.100.090
3,5X10MM*	1000	51428.035.010	6X12MM	100	51428.060.012	10X95MM*	100	51428.100.095
3,5X12MM*	1000	51428.035.012	6X14MM*	500	51428.060.014	10X100MM	10	51428.100.100
3,5X14MM*	1000	51428.035.014	6X16MM	100	51428.060.016	10X120MM*	50	51428.100.120
3,5X16MM*	1000	51428.035.016	6X18MM*	500	51428.060.018			
3,5X18MM*	1000	51428.035.018				12X30MM	200	51428.120.030

Nity z łbem kulistym

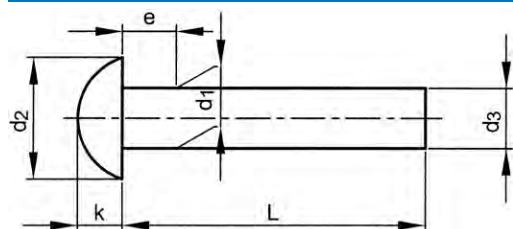

DIN 660/124
ISO 1051
BS 4620

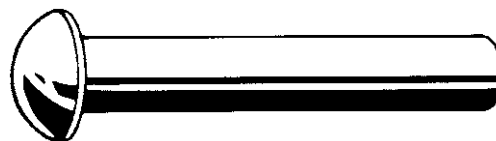

Informacje techniczne

d ₁	d ₂	d ₃ (min.)	e (maks.)	k (js14)
2	3.5	1.87	1	1.2
2.5	4.4	2.37	1.25	1.5
3	5.2	2.87	1.5	1.8
4	7	3.87	2	2.4
5	8.8	4.82	2.5	3
6	10.5	5.82	3	3.6
8	14	7.76	4	4.8
10 (DIN124)	16	9.4	5	6.5

Grupy katalogowe

Material	Kod	Strona
St EN 10263-2	39400	9-31
St.St. A2	51490	9-31
St.St. A4	55490	9-32
Al 99,5 EN1301-2	50670	9-32
Miedź EN 10263-5	50370	9-33

39400 Nity z łbem kulistym

L11C

Material Stal EN 10263-2

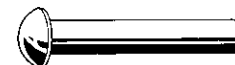

d ₁ x L	☒	Kod artykułu	d ₁ x L	☒	Kod artykułu	d ₁ x L	☒	Kod artykułu
2X6MM	1000	39400.020.006	4X25MM	500	39400.040.025	6X40MM	250	39400.060.040
2X8MM	1000	39400.020.008	4X30MM	500	39400.040.030	6X50MM	250	39400.060.050
2X10MM	1000	39400.020.010	4X40MM	250	39400.040.040	6X60MM	100	39400.060.060
2X12MM	1000	39400.020.012						
2X16MM	1000	39400.020.016	5X8MM	1000	39400.050.008	8X10MM	250	39400.080.010
			5X10MM	1000	39400.050.010	8X12MM	250	39400.080.012
3X6MM	1000	39400.030.006	5X12MM	1000	39400.050.012	8X16MM	250	39400.080.016
3X8MM	1000	39400.030.008	5X16MM	1000	39400.050.016	8X20MM	250	39400.080.020
3X10MM	1000	39400.030.010	5X20MM	500	39400.050.020	8X25MM	250	39400.080.025
3X12MM	1000	39400.030.012	5X25MM	500	39400.050.025	8X30MM	250	39400.080.030
3X16MM	1000	39400.030.016	5X30MM	500	39400.050.030	8X35MM	100	39400.080.035
3X20MM	1000	39400.030.020	5X40MM	250	39400.050.040	8X40MM	100	39400.080.040
3X25MM	1000	39400.030.025	5X50MM	250	39400.050.050	8X50MM	100	39400.080.050
3X30MM	1000	39400.030.030				8X60MM	100	39400.080.060
			6X10MM	500	39400.060.010			
4X6MM	1000	39400.040.006	6X12MM	500	39400.060.012	10X20MM	100	39400.100.020
4X8MM	1000	39400.040.008	6X16MM	500	39400.060.016	10X25MM	100	39400.100.025
4X10MM	1000	39400.040.010	6X20MM	500	39400.060.020	10X30MM	100	39400.100.030
4X12MM	1000	39400.040.012	6X25MM	250	39400.060.025	10X35MM	100	39400.100.035
4X16MM	1000	39400.040.016	6X30MM	250	39400.060.030	10X40MM	100	39400.100.040
4X20MM	1000	39400.040.020	6X35MM	250	39400.060.035	10X50MM	100	39400.100.050

51490 Nity z łbem kulistym

R09A

Material Stal nierdzewna A2

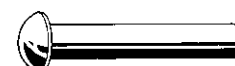

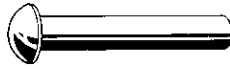

d ₁ x L	☒	Kod artykułu	d ₁ x L	☒	Kod artykułu	d ₁ x L	☒	Kod artykułu
2X6MM*	500	51490.020.006	2X12MM*	500	51490.020.012	2,5X6MM*	500	51490.025.006
2X8MM*	500	51490.020.008	2X16MM*	500	51490.020.016	2,5X8MM*	500	51490.025.008
2X10MM*	500	51490.020.010	2X20MM*	500	51490.020.020			

51490 Nity z łbem kulistym								
$d_1 \times L$	☒	Kod artykułu	$d_1 \times L$	☒	Kod artykułu	$d_1 \times L$	☒	Kod artykułu
2,5X10MM*	500	51490.025.010	4X16MM	100	51490.040.016	5X28MM*	200	51490.050.028
2,5X12MM*	500	51490.025.012	4X18MM*	200	51490.040.018	5X30MM	100	51490.050.030
2,5X35MM*	500	51490.025.035	4X20MM	100	51490.040.020	5X35MM*	200	51490.050.035
			4X25MM	100	51490.040.025	5X40MM*	200	51490.050.040
3X6MM	200	51490.030.006	4X28MM*	200	51490.040.028			
3X8MM	200	51490.030.008	4X30MM	100	51490.040.030	6X10MM	100	51490.060.010
3X10MM	200	51490.030.010	4X35MM*	200	51490.040.035	6X12MM	100	51490.060.012
3X12MM	200	51490.030.012	4X40MM	100	51490.040.040	6X14MM*	100	51490.060.014
3X14MM*	500	51490.030.014	4X45MM*	200	51490.040.045	6X16MM	100	51490.060.016
3X16MM	200	51490.030.016	4X50MM	100	51490.040.050	6X18MM*	100	51490.060.018
3X18MM*	500	51490.030.018	4X60MM	100	51490.040.060	6X20MM	100	51490.060.020
3X20MM	200	51490.030.020				6X22MM*	100	51490.060.022
3X22MM*	500	51490.030.022	5X8MM	100	51490.050.008	6X25MM	100	51490.060.025
3X25MM*	500	51490.030.025	5X10MM	100	51490.050.010	6X28MM*	100	51490.060.028
			5X12MM	100	51490.050.012	6X30MM	100	51490.060.030
4X6MM*	200	51490.040.006	5X14MM*	200	51490.050.014	6X35MM	100	51490.060.035
4X8MM	200	51490.040.008	5X16MM	100	51490.050.016	6X40MM*	100	51490.060.040
4X10MM	200	51490.040.010	5X18MM*	200	51490.050.018	6X45MM*	100	51490.060.045
4X12MM	200	51490.040.012	5X20MM	100	51490.050.020	6X50MM*	100	51490.060.050
4X14MM*	200	51490.040.014	5X25MM	100	51490.050.025			

55490 Nity z łbem kulistym		R49A
Materiał	Stal nierdzewna A4	
		

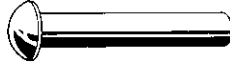
$d_1 \times L$	☒	Kod artykułu	$d_1 \times L$	☒	Kod artykułu	$d_1 \times L$	☒	Kod artykułu
3X6MM*	500	55490.030.006	4X12MM*	200	55490.040.012	5X12MM*	200	55490.050.012
3X8MM*	500	55490.030.008	4X16MM*	200	55490.040.016	5X20MM*	200	55490.050.020
3X10MM*	500	55490.030.010	4X25MM*	200	55490.040.025			
3X20MM*	500	55490.030.020	4X35MM*	200	55490.040.035	6X10MM*	100	55490.060.010
			4X40MM*	200	55490.040.040	6X12MM*	100	55490.060.012
4X6MM*	200	55490.040.006				6X20MM*	100	55490.060.020
4X8MM*	200	55490.040.008	5X8MM*	200	55490.050.008	6X30MM*	100	55490.060.030
4X10MM*	200	55490.040.010	5X10MM*	200	55490.050.010	6X35MM*	100	55490.060.035

50670 Nity z łbem kulistym		W01A
Materiał	Aluminium 99,5 EN1301-2	
		

$d_1 \times L$	☒	Kod artykułu	$d_1 \times L$	☒	Kod artykułu	$d_1 \times L$	☒	Kod artykułu
2X4MM	1000	50670.020.004	4X6MM	1000	50670.040.006	6X10MM	500	50670.060.010
2X6MM	1000	50670.020.006	4X8MM	1000	50670.040.008	6X12MM	500	50670.060.012
2X8MM	1000	50670.020.008	4X10MM	1000	50670.040.010	6X16MM	500	50670.060.016
2X10MM	1000	50670.020.010	4X12MM	1000	50670.040.012	6X20MM	500	50670.060.020
2X12MM	1000	50670.020.012	4X16MM	1000	50670.040.016	6X25MM	250	50670.060.025
2X16MM	1000	50670.020.016	4X20MM	1000	50670.040.020	6X30MM	250	50670.060.030
			4X25MM	500	50670.040.025	6X35MM	250	50670.060.035
3X4MM	1000	50670.030.004	4X30MM	500	50670.040.030	6X40MM	250	50670.060.040
3X6MM	1000	50670.030.006	4X40MM	250	50670.040.040	6X50MM	250	50670.060.050
3X7MM	1000	50670.030.007						
3X8MM	1000	50670.030.008	5X8MM	1000	50670.050.008			
3X10MM	1000	50670.030.010	5X10MM	1000	50670.050.010	8X16MM	250	50670.080.016
3X12MM	1000	50670.030.012	5X12MM	1000	50670.050.012	8X20MM	250	50670.080.020
3X16MM	1000	50670.030.016	5X16MM	1000	50670.050.016	8X25MM	250	50670.080.025
3X20MM	1000	50670.030.020	5X20MM	500	50670.050.020	8X30MM	250	50670.080.030
3X25MM	1000	50670.030.025	5X25MM	500	50670.050.025	8X35MM	100	50670.080.035
3X30MM	1000	50670.030.030	5X30MM	500	50670.050.030	8X40MM	100	50670.080.040
			5X40MM	250	50670.050.040			

50370	Nity z łbem kulistym	M11F
Materiał	Miedź EN 10263-5	

$d_1 \times L$	☒	Kod artykułu	$d_1 \times L$	☒	Kod artykułu	$d_1 \times L$	☒	Kod artykułu
2X4MM	1000	50370.020.004	4X6MM	1000	50370.040.006	6X10MM	500	50370.060.010
2X6MM	1000	50370.020.006	4X8MM	1000	50370.040.008	6X12MM	500	50370.060.012
2X8MM	1000	50370.020.008	4X10MM	1000	50370.040.010	6X16MM	500	50370.060.016
2X10MM	1000	50370.020.010	4X12MM	1000	50370.040.012	6X20MM	500	50370.060.020
2X12MM	1000	50370.020.012	4X16MM	1000	50370.040.016	6X25MM	250	50370.060.025
2X16MM	1000	50370.020.016	4X20MM	1000	50370.040.020	6X30MM	250	50370.060.030
			4X25MM	500	50370.040.025	6X35MM	250	50370.060.035
2,5X6MM	1000	50370.025.006	4X30MM	500	50370.040.030	6X40MM	250	50370.060.040
2,5X8MM	1000	50370.025.008	4X40MM	250	50370.040.040	6X50MM	250	50370.060.050
2,5X10MM	1000	50370.025.010						
			5X8MM	1000	50370.050.008	8X16MM	250	50370.080.016
3X4MM	1000	50370.030.004	5X10MM	1000	50370.050.010	8X20MM	250	50370.080.020
3X6MM	1000	50370.030.006	5X12MM	1000	50370.050.012	8X25MM	250	50370.080.025
3X8MM	1000	50370.030.008	5X16MM	1000	50370.050.016	8X30MM	250	50370.080.030
3X10MM	1000	50370.030.010	5X20MM	500	50370.050.020	8X40MM	100	50370.080.040
3X12MM	1000	50370.030.012	5X25MM	500	50370.050.025	8X50MM	100	50370.080.050
3X16MM	1000	50370.030.016	5X30MM	500	50370.050.030			
3X20MM	1000	50370.030.020	5X40MM	250	50370.050.040	10X30MM	100	50370.100.030
3X25MM	1000	50370.030.025	5X50MM	250	50370.050.050	10X40MM	100	50370.100.040
3X30MM	1000	50370.030.030				10X50MM	100	50370.100.050

Nity z łbem stożkowym płaskim

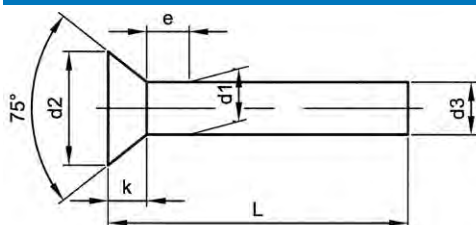

DIN 661/302
ISO 1051
BS 4620

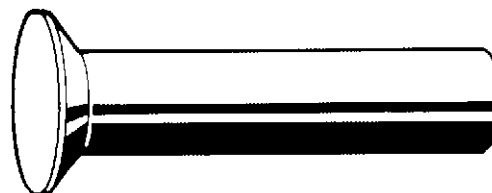

Informacje techniczne

d_1	d_2	d_3 (min.)	e (maks.)	k ≈
2	3.5	1.87	1	1
2.5	4.4	2.37	1.25	1.2
3	5.2	2.87	1.5	1.4
4	7	3.87	2	2
5	8.8	4.82	2.5	2.5
6	10.5	5.82	3	3
8	14	7.76	4	4
10 (DIN302)	14.5	9.4	5	3

Grupy katalogowe

Materiał	Kod	Strona
St EN 10263-2	39410	9-33
St.St. A2	51480	9-34
Al 99,5 EN1301-2	50680	9-34
Miedź EN 12166	50380	9-35

39410	Nity z łbem stożkowym płaskim	L11C
Materiał	Stal EN 10263-2	

$d_1 \times L$	☒	Kod artykułu	$d_1 \times L$	☒	Kod artykułu	$d_1 \times L$	☒	Kod artykułu
2X6MM	1000	39410.020.006	3X6MM	1000	39410.030.006	3X16MM	1000	39410.030.016
2X8MM	1000	39410.020.008	3X8MM	1000	39410.030.008	3X20MM	1000	39410.030.020
2X10MM	1000	39410.020.010	3X10MM	1000	39410.030.010	3X25MM	1000	39410.030.025
2X12MM	1000	39410.020.012	3X12MM	1000	39410.030.012	3X30MM	1000	39410.030.030
2X16MM	1000	39410.020.016						

39410 Nity z łbem stożkowym płaskim								
d ₁ x L	☒	Kod artykułu	d ₁ x L	☒	Kod artykułu	d ₁ x L	☒	Kod artykułu
4X6MM	1000	39410.040.006	5X25MM	500	39410.050.025	8X16MM	250	39410.080.016
4X8MM	1000	39410.040.008	5X30MM	500	39410.050.030	8X20MM	250	39410.080.020
4X10MM	1000	39410.040.010	5X40MM	250	39410.050.040	8X25MM	250	39410.080.025
4X12MM	1000	39410.040.012	5X50MM	250	39410.050.050	8X30MM	250	39410.080.030
4X16MM	1000	39410.040.016	6X10MM	500	39410.060.010	8X35MM	100	39410.080.035
4X20MM	1000	39410.040.020	6X12MM	500	39410.060.012	8X40MM	100	39410.080.040
4X25MM	500	39410.040.025	6X16MM	500	39410.060.016	8X50MM	100	39410.080.050
4X30MM	500	39410.040.030	6X20MM	500	39410.060.020	8X60MM	100	39410.080.060
5X8MM	1000	39410.050.008	6X25MM	250	39410.060.025	10X30MM	100	39410.100.030
5X10MM	1000	39410.050.010	6X30MM	250	39410.060.030	10X40MM	100	39410.100.040
5X12MM	1000	39410.050.012	6X35MM	250	39410.060.035	10X50MM	100	39410.100.050
5X16MM	1000	39410.050.016	6X40MM	250	39410.060.040			
5X20MM	500	39410.050.020	6X50MM	250	39410.060.050			

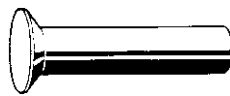
51480 Nity z łbem stożkowym płaskim		R09A
Materiał	Stal nierdzewna A2	
		
		

d ₁ x L	☒	Kod artykułu	d ₁ x L	☒	Kod artykułu	d ₁ x L	☒	Kod artykułu
2X6MM*	500	51480.020.006	4X4MM*	200	51480.040.004	5X18MM*	200	51480.050.018
2X8MM*	500	51480.020.008	4X6MM*	200	51480.040.006	5X20MM	100	51480.050.020
2X10MM*	500	51480.020.010	4X8MM	200	51480.040.008	5X22MM*	200	51480.050.022
2X12MM*	500	51480.020.012	4X10MM	200	51480.040.010	5X25MM	100	51480.050.025
2X16MM*	500	51480.020.016	4X12MM	200	51480.040.012	5X30MM	100	51480.050.030
2X20MM*	500	51480.020.020	4X16MM	100	51480.040.016	5X35MM*	200	51480.050.035
3X6MM	200	51480.030.006	4X18MM*	200	51480.040.018	5X40MM*	200	51480.050.040
3X8MM	200	51480.030.008	4X20MM	100	51480.040.020	6X10MM	100	51480.060.010
3X10MM	200	51480.030.010	4X22MM*	200	51480.040.022	6X12MM	100	51480.060.012
3X12MM	200	51480.030.012	4X25MM	100	51480.040.025	6X16MM	100	51480.060.016
3X16MM	200	51480.030.016	4X30MM	100	51480.040.030	6X18MM*	100	51480.060.018
3X18MM*	500	51480.030.018	5X8MM	100	51480.050.008	6X20MM	100	51480.060.020
3X20MM*	500	51480.030.020	5X10MM	100	51480.050.010	6X25MM	100	51480.060.025
3X22MM*	500	51480.030.022	5X12MM	100	51480.050.012	6X30MM	100	51480.060.030
3X25MM*	500	51480.030.025	5X14MM*	200	51480.050.014	6X40MM*	100	51480.060.040
			5X16MM	100	51480.050.016	6X50MM*	100	51480.060.050

50680 Nity z łbem stożkowym płaskim		W01A
Materiał	Aluminium 99,5 EN1301-2	
		
		

d ₁ x L	☒	Kod artykułu	d ₁ x L	☒	Kod artykułu	d ₁ x L	☒	Kod artykułu
2X6MM	1000	50680.020.006	4X10MM	1000	50680.040.010	6X12MM	500	50680.060.012
2X8MM	1000	50680.020.008	4X12MM	1000	50680.040.012	6X16MM	500	50680.060.016
2X10MM	1000	50680.020.010	4X16MM	1000	50680.040.016	6X20MM	500	50680.060.020
2X12MM	1000	50680.020.012	4X20MM	1000	50680.040.020	6X25MM	250	50680.060.025
2X16MM	1000	50680.020.016	4X25MM	500	50680.040.025	6X30MM	250	50680.060.030
3X6MM	1000	50680.030.006	4X30MM	500	50680.040.030	6X35MM	250	50680.060.035
3X8MM	1000	50680.030.008	5X8MM	1000	50680.050.008	6X40MM	250	50680.060.040
3X10MM	1000	50680.030.010	5X10MM	1000	50680.050.010	6X50MM	250	50680.060.050
3X12MM	1000	50680.030.012	5X12MM	1000	50680.050.012	8X16MM	250	50680.080.016
3X16MM	1000	50680.030.016	5X16MM	1000	50680.050.016	8X20MM	250	50680.080.020
3X20MM	1000	50680.030.020	5X20MM	500	50680.050.020	8X25MM	250	50680.080.025
3X25MM	1000	50680.030.025	5X25MM	500	50680.050.025	8X30MM	250	50680.080.030
3X30MM	1000	50680.030.030	5X30MM	500	50680.050.030	8X35MM	100	50680.080.035
4X6MM	1000	50680.040.006	5X40MM	250	50680.050.040	8X40MM	100	50680.080.040
4X8MM	1000	50680.040.008	6X10MM	500	50680.060.010	8X50MM	100	50680.080.050

50380	Nity z łbem stożkowym płaskim	M11F
Materiał	Miedź EN 12166	
		 

$d_1 \times L$	☒	Kod artykułu	$d_1 \times L$	☒	Kod artykułu	$d_1 \times L$	☒	Kod artykułu
2X6MM	1000	50380.020.006	4X12MM	1000	50380.040.012	6X10MM	500	50380.060.010
2X8MM	1000	50380.020.008	4X16MM	1000	50380.040.016	6X16MM	500	50380.060.016
2X10MM	1000	50380.020.010	4X20MM	1000	50380.040.020	6X20MM	500	50380.060.020
			4X25MM	500	50380.040.025	6X25MM	250	50380.060.025
3X6MM	1000	50380.030.006	4X30MM	500	50380.040.030	6X30MM	250	50380.060.030
3X8MM	1000	50380.030.008				6X40MM	250	50380.060.040
3X10MM	1000	50380.030.010	5X10MM	1000	50380.050.010	6X50MM	250	50380.060.050
3X12MM	1000	50380.030.012	5X12MM	1000	50380.050.012			
3X16MM	1000	50380.030.016	5X16MM	1000	50380.050.016			
3X20MM	1000	50380.030.020	5X20MM	500	50380.050.020	8X16MM	250	50380.080.016
3X25MM	1000	50380.030.025	5X25MM	500	50380.050.025	8X20MM	250	50380.080.020
			5X30MM	500	50380.050.030	8X25MM	250	50380.080.025
4X8MM	1000	50380.040.008	5X40MM	250	50380.050.040	8X30MM	250	50380.080.030
4X10MM	1000	50380.040.010	5X50MM	250	50380.050.050	8X40MM	100	50380.080.040

Sworznie z łbem walcowym i otworem na zawleczkę

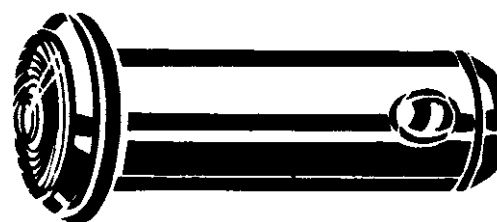
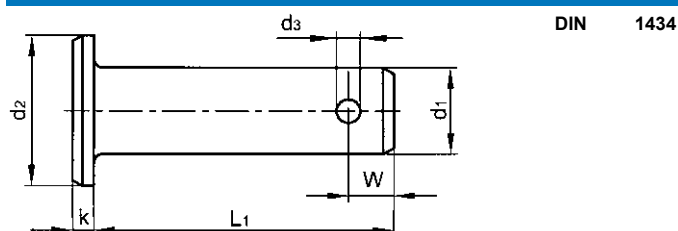

Informacje techniczne				
d_1 (h11)	d_2 (h14)	d_3 (H14)	k (js14)	W (min.)
4	6	1	1	1.8
5	8	1.6	1.5	2
6	9	1.6	1.5	2.5
8	12	2	2	3
10	14	3.2	2	4
12	17	4	3	5
14	19	4	3	5
16	21	4	3	5

39797	Sworznie z łbem walcowym i otworem na zawleczkę	L11F
Materiał	Stal	
Obróbka powierzchni	Ocynkowane	
		 

$d_1 \times L_1$	☒	Kod artykułu	$d_1 \times L_1$	☒	Kod artykułu	$d_1 \times L_1$	☒	Kod artykułu
4X12MM	100	39797.040.012	8X22MM	100	39797.080.022	14X40MM	25	39797.140.040
5X14MM	100	39797.050.014	10X28MM	50	39797.100.028	16X45MM	10	39797.160.045
6X18MM	100	39797.060.018	12X35MM	25	39797.120.035			

Zawlecзки

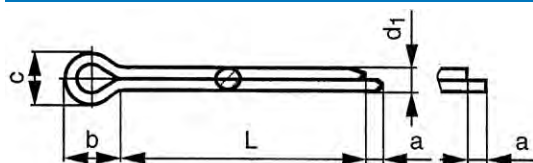

DIN 94
ISO 1234
NEN 182
NF E25-774



Informacje techniczne

d (nom.)	a (maks.)	b ≈	c (maks.)	c (min.)	d ₁ (maks.)	d ₁ (min.)
1	1.6	3	1.8	1.6	0.9	0.8
1.2	2.5	3	2	1.7	1	0.9
1.6	2.5	3.2	2.8	2.4	1.4	1.3
2	2.5	4	3.6	3.2	1.8	1.7
2.5	2.5	5	4.6	4	2.3	2.1
3.2	3.2	6.4	5.8	5.1	2.9	2.7
3.5 (#DIN)	3.5	7	6.8	6.1	3.2	3
4	4	8	7.4	6.5	3.7	3.5
4.5 (#DIN)	4	8.5	8.2	7.6	4.2	4
5	4	10	9.2	8	4.6	4.4
6.3	4	12.6	11.8	10.3	5.9	5.7
7 (#DIN)	4.7	12.3	12.5	12.45	6.5	6.7
8	4	16	15	13.1	7.5	7.3
10	6.3	20	19	16.6	9.5	9.3
13	6.3	26	24.8	21.7	12.4	12.1

- Dla otworu na zawleczkę, zalecana jest tolerancja H13 dla d (znam.) ≤ 1,2 mm i tolerancja H14 dla d (znam.) ≥ 1,6 mm i więcej.
- Kształt końców zawleczki według danego producenta.
- Długość znamionowa (L) ma pole tolerancji js17.

Tabela wyboru zawleczek

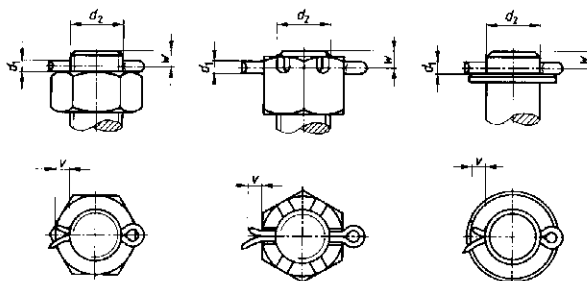

d (nom)		1	1,6	2	2,5	3,2	4	5	6,3	8	10	13	
d2	Części z gwintem*	Powyżej	3,5	5,5	7	9	11	14	20	27	39	56	80
	Do włączenie	4,5	7	9	11	14	20	27	39	56	80	120	
v	Części bez gwintu**	Powyżej	3	5	6	8	9	12	17	23	29	44	69
	Do włączenie	4	6	8	9	12	17	23	29	44	69	110	
v		Min.	4	5	6	6	8	8	10	12	14	16	20

* Do zastosowania w częściach z gwintem zewnętrznym musi być użyta średnica zewnętrzna gwintu lub średnica trzpienia.

** Do kolei i konstrukcji narażonych na zmienne siły poprzeczne, zaleca się użycie następujących większych rozmiarów zawleczek.

Odległość otworu W zależy od części konstrukcji, w której zawleczka jest umieszczona. Jeśli to konieczne patrz w normy tych szczególnych części.

Grupy katalogowe

Materiał	Obróbka powierzchni	Kod	Strona
St		39310	9-37
St	Ocynek.	39350	9-37
St	Ocynek. żłt. pas.	39360	9-38
St.St. A2		51700	9-38
St.St. A4		55700	9-39
Mosiądz		50210	9-40
Miedź		50390	9-40

39310 Zawleczeni		L09B	
Materiał	Stal	 	
Obróbka powierzchni	Ocynkowane		

d (nom.) x L	☒	Kod artykułu	d (nom.) x L	☒	Kod artykułu	d (nom.) x L	☒	Kod artykułu
1X12MM	250	39310.010.012	3,2X32MM	250	39310.032.032	6,3X40MM	100	39310.063.040
1X16MM	250	39310.010.016	3,2X40MM	250	39310.032.040	6,3X50MM	100	39310.063.050
1X20MM	250	39310.010.020	3,2X50MM	250	39310.032.050	6,3X63MM	100	39310.063.063
1X25MM	250	39310.010.025	3,2X63MM	250	39310.032.063	6,3X71MM	100	39310.063.071
1X32MM	250	39310.010.032				6,3X80MM	100	39310.063.080
			3,5X25MM	250	39310.035.025	6,3X100MM	100	39310.063.100
1,6X10MM	250	39310.016.010	3,5X30MM	250	39310.035.030			
1,6X12MM	250	39310.016.012	3,5X35MM	250	39310.035.035	7X63MM	100	39310.070.063
1,6X16MM	250	39310.016.016	3,5X40MM	250	39310.035.040	7X80MM	100	39310.070.080
1,6X20MM	250	39310.016.020	3,5X50MM	250	39310.035.050			
1,6X25MM	250	39310.016.025	3,5X60MM	250	39310.035.060	8X40MM	100	39310.080.040
1,6X32MM	250	39310.016.032	3,5X70MM	250	39310.035.070	8X45MM	100	39310.080.045
1,6X40MM	250	39310.016.040	3,5X80MM	250	39310.035.080	8X50MM	100	39310.080.050
1,6X50MM	250	39310.016.050				8X63MM	50	39310.080.063
			4X20MM	250	39310.040.020	8X80MM	50	39310.080.080
2X16MM	250	39310.020.016	4X25MM	250	39310.040.025	8X90MM	50	39310.080.090
2X20MM	250	39310.020.020	4X28MM	250	39310.040.028	8X100MM	50	39310.080.100
2X25MM	250	39310.020.025	4X32MM	250	39310.040.032	8X125MM	50	39310.080.125
2X32MM	250	39310.020.032	4X40MM	250	39310.040.040			
2X40MM	250	39310.020.040	4X50MM	200	39310.040.050	10X63MM	50	39310.100.063
2X50MM	250	39310.020.050	4X63MM	200	39310.040.063	10X71MM	50	39310.100.071
2X63MM	250	39310.020.063	4X80MM	200	39310.040.080	10X80MM	50	39310.100.080
						10X90MM	25	39310.100.090
2,5X16MM	250	39310.025.016	5X25MM	200	39310.050.025	10X100MM	25	39310.100.100
2,5X20MM	250	39310.025.020	5X32MM	200	39310.050.032	10X125MM	25	39310.100.125
2,5X25MM	250	39310.025.025	5X36MM	200	39310.050.036	10X160MM	25	39310.100.160
2,5X32MM	250	39310.025.032	5X40MM	200	39310.050.040			
2,5X40MM	250	39310.025.040	5X50MM	200	39310.050.050	13X63MM	25	39310.130.063
2,5X50MM	250	39310.025.050	5X63MM	100	39310.050.063	13X80MM	25	39310.130.080
2,5X63MM	250	39310.025.063	5X80MM	100	39310.050.080	13X100MM	25	39310.130.100
			5X100MM	100	39310.050.100	13X125MM	25	39310.130.125
3,2X16MM	250	39310.032.016				13X140MM	25	39310.130.140
3,2X20MM	250	39310.032.020	6,3X25MM	100	39310.063.025	13X160MM	25	39310.130.160
3,2X25MM	250	39310.032.025	6,3X32MM	100	39310.063.032			

39350 Zawleczeni		L09B	
Materiał	Stal	 	
Obróbka powierzchni	Ocynkowane		

d (nom.) x L	☒	Kod artykułu	d (nom.) x L	☒	Kod artykułu	d (nom.) x L	☒	Kod artykułu
1X25MM	250	39350.010.025	2,5X50MM	250	39350.025.050	4X28MM	250	39350.040.028
1X32MM	250	39350.010.032	2,5X63MM	250	39350.025.063	4X32MM	250	39350.040.032
						4X36MM	250	39350.040.036
1,6X10MM	250	39350.016.010	3,2X16MM	250	39350.032.016	4X40MM	250	39350.040.040
1,6X12MM	250	39350.016.012	3,2X20MM	250	39350.032.020	4X45MM	250	39350.040.045
1,6X16MM	250	39350.016.016	3,2X25MM	250	39350.032.025	4X50MM	200	39350.040.050
1,6X20MM	250	39350.016.020	3,2X28MM	250	39350.032.028	4X63MM	200	39350.040.063
1,6X25MM	250	39350.016.025	3,2X32MM	250	39350.032.032	4X71MM	200	39350.040.071
1,6X32MM	250	39350.016.032	3,2X36MM	250	39350.032.036	4X80MM	200	39350.040.080
1,6X40MM	250	39350.016.040	3,2X40MM	250	39350.032.040	4X100MM	200	39350.040.100
1,6X50MM	250	39350.016.050	3,2X45MM	250	39350.032.045			
			3,2X50MM	250	39350.032.050	4,5X40MM	200	39350.045.040
2X16MM	250	39350.020.016	3,2X63MM	250	39350.032.063	4,5X50MM	200	39350.045.050
2X18MM	250	39350.020.018				4,5X63MM	200	39350.045.063
2X20MM	250	39350.020.020	3,5X20MM	250	39350.035.020	4,5X71MM	200	39350.045.071
2X25MM	250	39350.020.025	3,5X25MM	250	39350.035.025			
2X32MM	250	39350.020.032	3,5X30MM	250	39350.035.030	5X25MM	200	39350.050.025
2X36MM	250	39350.020.036	3,5X32MM	250	39350.035.032	5X32MM	200	39350.050.032
2X40MM	250	39350.020.040	3,5X35MM	250	39350.035.035	5X36MM	200	39350.050.036
2X50MM	250	39350.020.050	3,5X36MM	250	39350.035.036	5X40MM	200	39350.050.040
2X63MM	250	39350.020.063	3,5X40MM	250	39350.035.040	5X45MM	200	39350.050.045
			3,5X50MM	250	39350.035.050	5X50MM	200	39350.050.050
2,5X16MM	250	39350.025.016	3,5X60MM	250	39350.035.060	5X56MM	200	39350.050.056
2,5X20MM	250	39350.025.020	3,5X63MM	250	39350.035.063	5X63MM	100	39350.050.063
2,5X25MM	250	39350.025.025	3,5X70MM	250	39350.035.070	5X71MM	100	39350.050.071
2,5X32MM	250	39350.025.032	3,5X80MM	250	39350.035.080	5X80MM	100	39350.050.080
2,5X36MM	250	39350.025.036				5X90MM	100	39350.050.090
2,5X40MM	250	39350.025.040	4X20MM	250	39350.040.020	5X100MM	100	39350.050.100
2,5X45MM	250	39350.025.045	4X25MM	250	39350.040.025			

39350 Zawleczeni								
d (nom.) x L	☒	Kod artykułu	d (nom.) x L	☒	Kod artykułu	d (nom.) x L	☒	Kod artykułu
6,3X32MM	100	39350.063.032	8X40MM	100	39350.080.040	10X90MM	25	39350.100.090
6,3X36MM	100	39350.063.036	8X45MM	100	39350.080.045	10X100MM	25	39350.100.100
6,3X40MM	100	39350.063.040	8X50MM	100	39350.080.050	10X112MM	25	39350.100.112
6,3X45MM	100	39350.063.045	8X63MM	50	39350.080.063	10X125MM	25	39350.100.125
6,3X50MM	100	39350.063.050	8X71MM	50	39350.080.071	10X140MM	25	39350.100.140
6,3X56MM	100	39350.063.056	8X80MM	50	39350.080.080	10X160MM	25	39350.100.160
6,3X63MM	100	39350.063.063	8X90MM	50	39350.080.090	10X180MM	25	39350.100.180
6,3X71MM	100	39350.063.071	8X100MM	50	39350.080.100	10X200MM	25	39350.100.200
6,3X80MM	100	39350.063.080	8X112MM	50	39350.080.112			
6,3X90MM	100	39350.063.090	8X125MM	50	39350.080.125	13X71MM	25	39350.130.071
6,3X100MM	100	39350.063.100	8X140MM	50	39350.080.140	13X100MM	25	39350.130.100
6,3X125MM	100	39350.063.125				13X112MM	25	39350.130.112
			10X56MM	100	39350.100.056	13X125MM	25	39350.130.125
7X71MM	100	39350.070.071	10X63MM	50	39350.100.063	13X140MM	25	39350.130.140
			10X71MM	50	39350.100.071	13X160MM	25	39350.130.160
8X32MM	100	39350.080.032	10X80MM	50	39350.100.080			

39360 Zawleczeni		L09B
Materiał	Stal	
Obróbka powierzchni	Ocynkowane, po żółtej pasywacji	



d (nom.) x L	☒	Kod artykułu	d (nom.) x L	☒	Kod artykułu	d (nom.) x L	☒	Kod artykułu
2X16MM	250	39360.020.016	3,2X32MM	250	39360.032.032	4X40MM	250	39360.040.040
2X20MM	250	39360.020.020	3,2X40MM	250	39360.032.040	4X50MM	250	39360.040.050
2X25MM	250	39360.020.025						
2X32MM	250	39360.020.032	4X20MM	250	39360.040.020	5X32MM	200	39360.050.032
			4X25MM	250	39360.040.025	5X40MM	200	39360.050.040
3,2X20MM	250	39360.032.020	4X32MM	250	39360.040.032	5X50MM	200	39360.050.050
3,2X25MM	250	39360.032.025						

51700 Zawleczeni		R09A
Materiał	Stal nierdzewna A2	

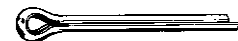

d (nom.) x L	☒	Kod artykułu	d (nom.) x L	☒	Kod artykułu	d (nom.) x L	☒	Kod artykułu
1X6MM*	1000	51700.010.006	1,6X20MM	250	51700.016.020	2,5X36MM*	1000	51700.025.036
1X8MM*	1000	51700.010.008	1,6X22MM*	1000	51700.016.022	2,5X40MM	100	51700.025.040
1X10MM	250	51700.010.010	1,6X25MM	250	51700.016.025	2,5X45MM*	1000	51700.025.045
1X12MM	250	51700.010.012	1,6X28MM*	1000	51700.016.028	2,5X50MM	100	51700.025.050
1X14MM*	1000	51700.010.014	1,6X32MM	250	51700.016.032			
1X16MM	250	51700.010.016	1,6X36MM*	1000	51700.016.036	3,2X16MM	100	51700.032.016
1X18MM*	1000	51700.010.018	1,6X40MM	250	51700.016.040	3,2X18MM*	500	51700.032.018
1X20MM	250	51700.010.020	1,6X45MM*	1000	51700.016.045	3,2X20MM	100	51700.032.020
1X22MM*	1000	51700.010.022				3,2X22MM*	500	51700.032.022
1X25MM	250	51700.010.025	2X6MM*	1000	51700.020.006	3,2X25MM	100	51700.032.025
1X28MM*	1000	51700.010.028	2X10MM	250	51700.020.010	3,2X28MM*	500	51700.032.028
1X32MM	250	51700.010.032	2X12MM*	1000	51700.020.012	3,2X32MM	100	51700.032.032
1X36MM*	1000	51700.010.036	2X14MM*	1000	51700.020.014	3,2X36MM	100	51700.032.036
1X40MM	250	51700.010.040	2X16MM	250	51700.020.016	3,2X40MM	100	51700.032.040
1X45MM*	1000	51700.010.045	2X18MM	250	51700.020.018	3,2X45MM	100	51700.032.045
			2X20MM	250	51700.020.020	3,2X50MM	100	51700.032.050
1,2X8MM*	1000	51700.012.008	2X22MM*	1000	51700.020.022	3,2X56MM*	500	51700.032.056
1,2X10MM*	1000	51700.012.010	2X25MM	250	51700.020.025	3,2X63MM	100	51700.032.063
1,2X12MM*	1000	51700.012.012	2X28MM*	1000	51700.020.028	3,2X71MM*	500	51700.032.071
1,2X14MM*	1000	51700.012.014	2X32MM	250	51700.020.032	3,2X80MM*	500	51700.032.080
1,2X16MM*	1000	51700.012.016	2X36MM*	1000	51700.020.036			
1,2X18MM*	1000	51700.012.018	2X40MM	250	51700.020.040	4X16MM*	500	51700.040.016
1,2X20MM*	1000	51700.012.020	2X45MM*	1000	51700.020.045	4X18MM*	500	51700.040.018
1,2X22MM*	1000	51700.012.022	2X50MM	250	51700.020.050	4X20MM	100	51700.040.020
1,2X25MM*	1000	51700.012.025				4X22MM*	500	51700.040.022
1,2X32MM*	1000	51700.012.032	2,5X10MM	100	51700.025.010	4X25MM	100	51700.040.025
1,2X40MM*	1000	51700.012.040	2,5X12MM*	1000	51700.025.012	4X28MM	100	51700.040.028
			2,5X14MM*	1000	51700.025.014	4X32MM	100	51700.040.032
1,6X6MM*	1000	51700.016.006	2,5X16MM	100	51700.025.016	4X36MM	100	51700.040.036
1,6X8MM*	1000	51700.016.008	2,5X18MM*	1000	51700.025.018	4X40MM	100	51700.040.040
1,6X10MM	250	51700.016.010	2,5X20MM	100	51700.025.020	4X45MM	100	51700.040.045
1,6X12MM	250	51700.016.012	2,5X22MM*	1000	51700.025.022	4X50MM	100	51700.040.050
1,6X14MM*	1000	51700.016.014	2,5X25MM	100	51700.025.025	4X56MM*	500	51700.040.056
1,6X16MM	250	51700.016.016	2,5X28MM*	1000	51700.025.028	4X63MM	100	51700.040.063
1,6X18MM*	1000	51700.016.018	2,5X32MM	100	51700.025.032	4X71MM*	500	51700.040.071



51700 Zawlecзки								
d (nom.) x L	☒	Kod artykułu	d (nom.) x L	☒	Kod artykułu	d (nom.) x L	☒	Kod artykułu
4X80MM	100	51700.040.080	5X100MM	50	51700.050.100	8X50MM	25	51700.080.050
4X90MM*	500	51700.040.090	6,3X20MM*	250	51700.063.020	8X56MM*	100	51700.080.056
4X100MM*	500	51700.040.100	6,3X25MM	50	51700.063.025	8X63MM	25	51700.080.063
5X20MM*	250	51700.050.020	6,3X32MM	50	51700.063.032	8X71MM*	100	51700.080.071
5X22MM*	250	51700.050.022	6,3X36MM*	250	51700.063.036	8X80MM	25	51700.080.080
5X25MM	50	51700.050.025	6,3X40MM	50	51700.063.040	8X90MM*	100	51700.080.090
5X28MM*	250	51700.050.028	6,3X45MM*	250	51700.063.045	8X100MM	25	51700.080.100
5X32MM	50	51700.050.032	6,3X50MM	50	51700.063.050	10X32MM*	100	51700.100.032
5X35MM	50	51700.050.035	6,3X56MM*	250	51700.063.056	10X40MM*	100	51700.100.040
5X36MM	50	51700.050.036	6,3X63MM	50	51700.063.063	10X50MM*	100	51700.100.050
5X40MM	50	51700.050.040	6,3X71MM	50	51700.063.071	10X56MM*	100	51700.100.056
5X45MM*	250	51700.050.045	6,3X80MM	50	51700.063.080	10X63MM	25	51700.100.063
5X50MM	50	51700.050.050	6,3X90MM*	250	51700.063.090	10X71MM*	100	51700.100.071
5X56MM*	250	51700.050.056	6,3X100MM	50	51700.063.100	10X80MM	25	51700.100.080
5X63MM	50	51700.050.063	8X32MM*	100	51700.080.032	10X90MM*	100	51700.100.090
5X71MM	50	51700.050.071	8X40MM	25	51700.080.040	10X100MM	25	51700.100.100
5X80MM	50	51700.050.080	8X45MM*	100	51700.080.045	10X125MM	25	51700.100.125
5X90MM*	250	51700.050.090				10X180MM	25	51700.100.180

* Typ stali austenicznej jest pozostawiony do decyzji producenta i może różnić się od typów stali podanych w ISO 3506.

55700 Zawlecзки		R49A
Materiał	Stal nierdzewna A4	
		

d (nom.) x L	☒	Kod artykułu	d (nom.) x L	☒	Kod artykułu	d (nom.) x L	☒	Kod artykułu
1X8MM*	1000	55700.010.008	2,5X20MM	100	55700.025.020	5X36MM*	250	55700.050.036
1X10MM	250	55700.010.010	2,5X22MM*	1000	55700.025.022	5X40MM	50	55700.050.040
1X12MM	250	55700.010.012	2,5X25MM	100	55700.025.025	5X45MM*	250	55700.050.045
1X16MM	250	55700.010.016	2,5X28MM*	1000	55700.025.028	5X50MM	50	55700.050.050
1X18MM*	1000	55700.010.018	2,5X32MM	100	55700.025.032	5X56MM*	250	55700.050.056
1X20MM	250	55700.010.020	2,5X36MM*	1000	55700.025.036	5X63MM	50	55700.050.063
1X25MM	250	55700.010.025	2,5X40MM	100	55700.025.040	5X71MM*	250	55700.050.071
1,2X8MM*	1000	55700.012.008	2,5X45MM*	1000	55700.025.045	5X80MM	50	55700.050.080
1,2X10MM*	1000	55700.012.010	2,5X50MM	100	55700.025.050	5X90MM*	250	55700.050.090
1,2X12MM*	1000	55700.012.012	3,2X16MM	100	55700.032.016	5X100MM	50	55700.050.100
1,2X16MM*	1000	55700.012.016	3,2X18MM*	500	55700.032.018	6,3X25MM	50	55700.063.025
1,2X20MM*	1000	55700.012.020	3,2X20MM	100	55700.032.020	6,3X32MM	50	55700.063.032
1,2X25MM*	1000	55700.012.025	3,2X22MM*	500	55700.032.022	6,3X36MM*	250	55700.063.036
1,2X32MM*	1000	55700.012.032	3,2X25MM	100	55700.032.025	6,3X40MM	50	55700.063.040
1,6X8MM*	1000	55700.016.008	3,2X28MM*	500	55700.032.028	6,3X45MM*	250	55700.063.045
1,6X10MM	250	55700.016.010	3,2X32MM	100	55700.032.032	6,3X50MM	50	55700.063.050
1,6X12MM	250	55700.016.012	3,2X36MM*	500	55700.032.036	6,3X56MM*	250	55700.063.056
1,6X16MM	250	55700.016.016	3,2X40MM	100	55700.032.040	6,3X63MM	50	55700.063.063
1,6X18MM*	1000	55700.016.018	3,2X45MM*	500	55700.032.045	6,3X71MM*	250	55700.063.071
1,6X20MM	250	55700.016.020	3,2X50MM	100	55700.032.050	6,3X80MM	50	55700.063.080
1,6X22MM*	1000	55700.016.022	3,2X56MM*	500	55700.032.056	6,3X90MM*	250	55700.063.090
1,6X25MM	250	55700.016.025	3,2X63MM	100	55700.032.063	6,3X100MM	50	55700.063.100
1,6X28MM*	1000	55700.016.028	4X16MM*	500	55700.040.016	8X32MM*	100	55700.080.032
1,6X32MM	250	55700.016.032	4X20MM	100	55700.040.020	8X36MM*	100	55700.080.036
1,6X40MM*	1000	55700.016.040	4X22MM*	500	55700.040.022	8X40MM	25	55700.080.040
2X10MM	250	55700.020.010	4X25MM	100	55700.040.025	8X45MM*	100	55700.080.045
2X12MM*	1000	55700.020.012	4X28MM*	500	55700.040.028	8X50MM	25	55700.080.050
2X16MM	250	55700.020.016	4X32MM	100	55700.040.032	8X56MM*	100	55700.080.056
2X18MM	250	55700.020.018	4X36MM*	500	55700.040.036	8X63MM	25	55700.080.063
2X20MM	250	55700.020.020	4X40MM	100	55700.040.040	8X71MM*	100	55700.080.071
2X22MM*	1000	55700.020.022	4X45MM*	500	55700.040.045	8X80MM	25	55700.080.080
2X25MM	250	55700.020.025	4X50MM	100	55700.040.050	8X90MM*	100	55700.080.090
2X28MM*	1000	55700.020.028	4X56MM*	500	55700.040.056	8X100MM	25	55700.080.100
2X32MM	250	55700.020.032	4X63MM	100	55700.040.063	10X40MM*	100	55700.100.040
2X36MM*	1000	55700.020.036	4X71MM*	500	55700.040.071	10X63MM	25	55700.100.063
2X40MM	250	55700.020.040	4X80MM	100	55700.040.080	10X71MM*	100	55700.100.071
2X45MM*	1000	55700.020.045	4X100MM*	500	55700.040.100	10X80MM	25	55700.100.080
2X50MM	250	55700.020.050	5X18MM*	250	55700.050.018	10X90MM*	100	55700.100.090
2,5X10MM	100	55700.025.010	5X20MM*	250	55700.050.020	10X100MM	25	55700.100.100
2,5X12MM*	1000	55700.025.012	5X22MM*	250	55700.050.022	10X125MM	25	55700.100.125
2,5X16MM	100	55700.025.016	5X25MM	50	55700.050.025	13 X 90 MM	25	55700.130.090
2,5X18MM*	1000	55700.025.018	5X28MM*	250	55700.050.028			
			5X32MM	50	55700.050.032			

* Typ stali austenicznej pozostaje do decyzji producenta i może się różnić od typów stali podanych w ISO 3506.

50210	Zawlecзки	M11F
Materiał	Mosiądz	
		 

d (nom.) x L	☒	Kod artykułu	d (nom.) x L	☒	Kod artykułu	d (nom.) x L	☒	Kod artykułu
1,6X20MM	500	50210.016.020	2,5X50MM	500	50210.025.050	4X50MM	250	50210.040.050
1,6X25MM	500	50210.016.025	2,5X63MM	500	50210.025.063	4X63MM	250	50210.040.063
1,6X32MM	500	50210.016.032				4X80MM	250	50210.040.080
1,6X40MM	500	50210.016.040	3,2X25MM	250	50210.032.025			
			3,2X32MM	250	50210.032.032	5X40MM	100	50210.050.040
2X25MM	500	50210.020.025	3,2X40MM	250	50210.032.040	5X50MM	100	50210.050.050
2X32MM	500	50210.020.032	3,2X50MM	250	50210.032.050	5X63MM	100	50210.050.063
2X40MM	500	50210.020.040	3,2X63MM	250	50210.032.063	5X80MM	100	50210.050.080
2X50MM	500	50210.020.050						
			4X25MM	250	50210.040.025	6,3X63MM	100	50210.063.063
2,5X25MM	500	50210.025.025	4X32MM	250	50210.040.032	6,3X80MM	100	50210.063.080
2,5X32MM	500	50210.025.032	4X40MM	250	50210.040.040	6,3X100MM	100	50210.063.100
2,5X40MM	500	50210.025.040						

• Typ stali austenicznej pozostaje do decyzji producenta i może się różnić od typów stali podanych w DIN 267-11.

50390	Zawlecзки	M11F
Materiał	Miedź	
		 

d (nom.) x L	☒	Kod artykułu	d (nom.) x L	☒	Kod artykułu	d (nom.) x L	☒	Kod artykułu
1,6X20MM	500	50390.016.020	3,2X40MM	250	50390.032.040			
1,6X32MM	500	50390.016.032	3,2X50MM	250	50390.032.050	5X40MM	100	50390.050.040
			3,2X63MM	250	50390.032.063	5X50MM	100	50390.050.050
2X32MM	500	50390.020.032				5X63MM	100	50390.050.063
2X40MM	500	50390.020.040	4X32MM	250	50390.040.032	5X80MM	100	50390.050.080
			4X40MM	250	50390.040.040			
2,5X32MM	500	50390.025.032	4X50MM	250	50390.040.050	6,3X63MM	100	50390.063.063
2,5X40MM	500	50390.025.040	4X63MM	250	50390.040.063	6,3X80MM	100	50390.063.080
			4X80MM	250	50390.040.080	6,3X100MM	100	50390.063.100
3,2X32MM	250	50390.032.032						

Zawleccki sprężyste pojedyncze

DIN ≈11024

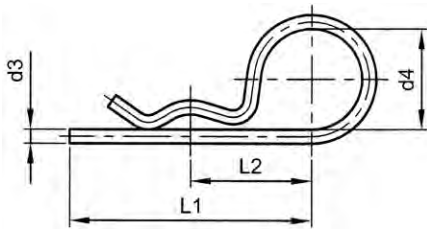

Informacje techniczne

d1(nom.) = ø otworu	Do trzonka ø d ₂ >	Do trzonka ø d ₂ ≤	d ₃	d ₄	L ₁	L ₂
2.5	9	14	2	10	50	25
3.5	10	16	3	18	60	28
4.5	16	20	4	20	60	30
6	20	28	5	24	85	40
7	28	40	6	30	105	50
8	28	45	7	30	105	50
9	30	45	8	28	110	55

Dane montażowe

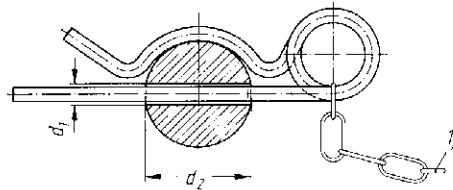

Patrz dane montażowe. Dla średnicy otworu d₁ (nom.) zalecane jest pole tolerancji H13.
Zalecane jest łączenie przetyczki sprężystej śruby z elementem blokującym, tak żeby nie mogła zostać zgubiona.

Grupy katalogowe

Materiał	Obróbka powierzchni	Kod	Strona
Stal sprężynowa	Ocynk. żłt. pas.	39610	9-41
St.St. A2		51970	9-41

39610 Zawleccki sprężyste pojedyncze

L11E

Materiał Stal sprężynowa
Obróbka powierzchni Ocynkowane, po żółtej pasywacji



d ₁ (=d ₃)	☒	Kod artykułu	d ₁ (=d ₃)	☒	Kod artykułu	d ₁ (=d ₃)	☒	Kod artykułu
2,5 (=2 MM)	50	39610.020.001	6 (=5 MM)	25	39610.050.001	8 (=7 MM)	10	39610.070.001
3,5 (=3 MM)	50	39610.030.001	7 (=6 MM)	25	39610.060.001	9 (=8 MM)	10	39610.080.001
4,5 (=4 MM)	25	39610.040.001						

• Ostrzeżenie: cynkowanie elektrolityczne tych produktów może wywołać kruchość wodorową.

51970 Zawleccki sprężyste pojedyncze

R09A

Materiał Stal nierdzewna A2

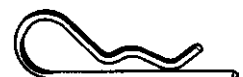

d ₁ (=d ₃)	☒	Kod artykułu	d ₁ (=d ₃)	☒	Kod artykułu	d ₁ (=d ₃)	☒	Kod artykułu
2,5 (=2 MM)	50	51970.020.001	4,5 (=4 MM)	25	51970.040.001	7 (=6 MM)	25	51970.060.001
3,5 (=3 MM)	50	51970.030.001	6 (=5 MM)	25	51970.050.001			

Zawleccki sprężyste podwójne

DIN ≈11024

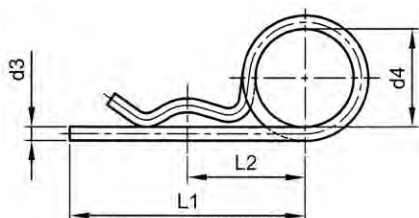

Informacje techniczne

d1(nom.) = \varnothing otworu	Do trzonka $\varnothing d_2 >$	Do trzonka $\varnothing d_2 \leq$	d ₃	d ₄	L ₁	L ₂
3.5	14	20	3	16	62	32
4.5	17	24	4	23	78	44
5.5	18	30	5	26	92	50
6.5	24	36	6	30	120	70
8	26	40	7	30	130	72
9	24	40	8	30	130	76

Dane montażowe

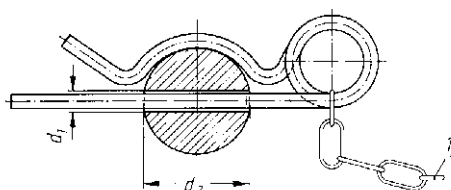

Patrz dane montażowe. Dla średnicy otworu d₁ (nom.) zalecane jest pole tolerancji H13.
Zalecane jest łączenie przetyczki sprężystej śruby z elementem blokującym, tak żeby nie mogła zostać zgubiona.

39630 Zawleccki sprężyste podwójne

L11E

Materiał Stal sprężynowa
Obróbka powierzchni Ocynkowane, po żółtej pasywacji



d ₁ (=d ₃)	☒	Kod artykułu	d ₁ (=d ₃)	☒	Kod artykułu	d ₁ (=d ₃)	☒	Kod artykułu
3,5 (=3 MM)	50	39630.030.001	5,5 (=5 MM)	25	39630.050.001	8 (=7 MM)	10	39630.070.001
4,5 (=4 MM)	25	39630.040.001	6,5 (=6 MM)	25	39630.060.001	9 (=8MM)	10	39630.080.001

- Ostrzeżenie: cynkowanie elektrolityczne tych produktów może wywołać kruchość wodorową.

Zawleczki sprężyste podwójne, A4

DIN 11024

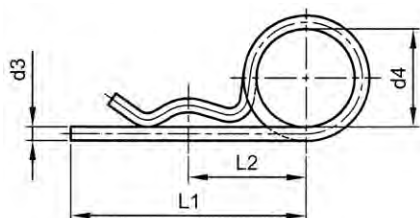

Informacje techniczne

d1(nom.) = \varnothing otworu	Do trzonka $\varnothing d_2 >$	Do trzonka $\varnothing d_2 \leq$	d ₃	d ₄	L ₁	L ₂
3.2	11.2	14	2.8	20	48	26
4	14	20	3.6	20	64	32
5	20	26	4.5	25	80	39
7	34	45	6.3	30	125	56
8	45	56	7	30	150	63

Dane montażowe

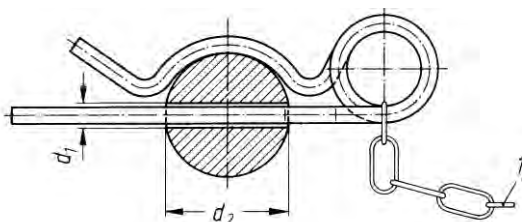

Patrz dane montażowe. Dla średnicy otworu d_1 (nom.) zalecane jest pole tolerancji H13. Zalecane jest łączenie przetyczki sprężystej śruby z elementem blokującym, tak żeby nie mogła zostać zgubiona.

55970 Zawleczki sprężyste podwójne, A4

R09A

Materiał Stal nierdzewna A4



d ₁ (=d ₃)	☒	Kod artykułu	d ₁ (=d ₃)	☒	Kod artykułu	d ₁ (=d ₃)	☒	Kod artykułu
3,2 (=2,8MM)	50	55970.032.001	5 (=4,5MM)	50	55970.050.001	8 (=7MM)	10	55970.080.001
4 (=3,6MM)	50	55970.040.001	7 (=6,3MM)	10	55970.070.001			

Zawlecзки do rur

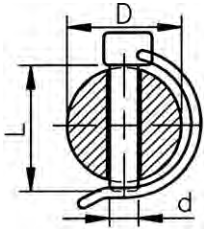

Informacje techniczne

d x L	Do rozmiaru znam. D cale	Do rozmiaru znam. D mm
6x40	1.13/32	36
6x45	1.9/16	40
8x40	1.13/32	36
8x45	1.9/16	40
8x50	1.3/4	45
10x40	1.13/32	36
10x50	1.3/4	45
10x60	2.11/64	55

Dane montażowe

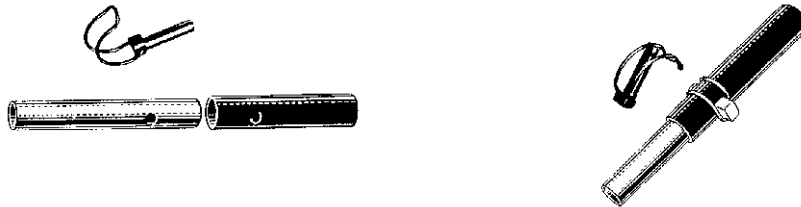

39680 Zawlecзки do rur

L11G

Materiał Stal sprężynowa
Obróbka powierzchni Ocynkowane, po żółtej pasywacji



d x L	☒	Kod artykułu	d x L	☒	Kod artykułu	d x L	☒	Kod artykułu
6X40MM	25	39680.060.040	8X45MM	25	39680.080.045	10X40MM	10	39680.100.040
6X45MM	25	39680.060.045	8X50MM	25	39680.080.050	10X50MM	10	39680.100.050
8X40MM	25	39680.080.040				10X60MM	10	39680.100.060

- Ostrzeżenie: cynkowanie elektrolityczne tych produktów może wywołać kruchość wodorową.

Zawleczka z pierścieniem

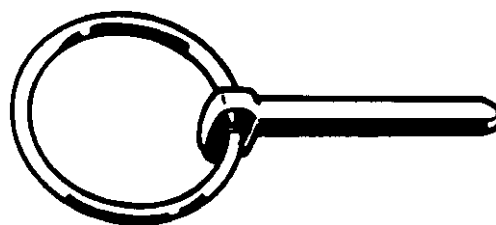
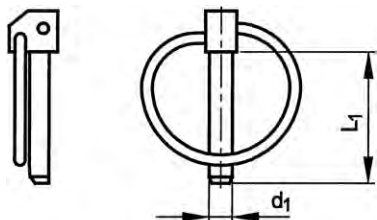

Informacje techniczne

d_1	d_3 (H11)	d_4 (maks.)	Forma trzonka	L_2
4.5	5	25	a	8
6	6.2	32	a	10
7	8	32	b	12
8	8.5	32	b	12
9.5	10	32	b	14
10	10.5	32	b	14
11	12	32	b	14

- Forma trzonka a = okrągły, b = spłaszczony z jednej strony

Dane montażowe

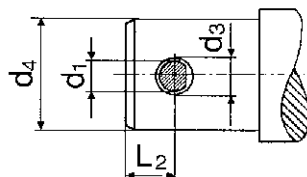

39660 Zawleczka z pierścieniem

L11E

Materiał Stal sprężynowa
Obróbka powierzchni Ocynkowane, po żółtej pasywacji



$d_1 \times L_1$	☒	Kod artykułu	$d_1 \times L_1$	☒	Kod artykułu	$d_1 \times L_1$	☒	Kod artykułu
4,5x40MM	25	39660.045.001	8x40MM	25	39660.080.001	10x40MM	10	39660.100.001
6x40MM	25	39660.060.001	9,5x40MM	25	39660.095.001	11x40MM	10	39660.110.001
7x40MM	25	39660.070.001						

- Ostrzeżenie: cynkowanie elektrolityczne tych produktów może wywołać kruchość wodorową.

Wpusty pryzmatyczne, typ wysoki

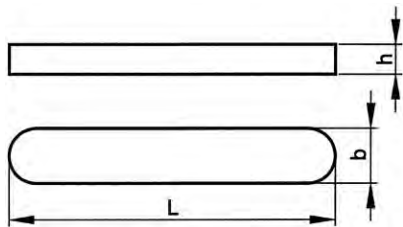

DIN 6885 A
ISO 773
NEN 2430
BS 4235-1

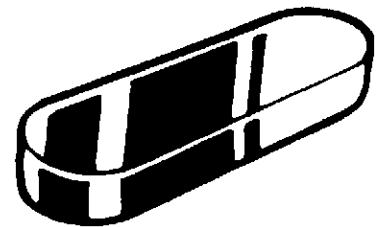

Informacje techniczne

b	Do trzonka $\phi >$	Do trzonka $\phi \leq$	h	b	Do trzonka $\phi >$	Do trzonka $\phi \leq$	h
2	6	8	2	18	50	58	11
3	8	10	3	20	75	85	12
4	10	12	4	22	75	80	14
5	12	17	5	25	85	95	14
6	17	22	6	28	95	110	16
8	22	30	7	32	110	130	18
10	30	38	8	36	130	150	20
12	38	44	8	40	150	170	22
14	44	50	9	45	170	200	25
16	50	58	10	50	200	230	28

Grupy katalogowe

Material	Kod	Strona
St C45K	39250	9-46
St.St. A4	55510	9-48

39250 Wpusty pryzmatyczne, typ wysoki

L11B

Material Stal C45K



b x h x L	☒	Kod artykułu	b x h x L	☒	Kod artykułu	b x h x L	☒	Kod artykułu
2X2X6MM	50	39250.022.006	4X4X15MM	50	39250.044.015	5X5X80MM	50	39250.055.080
2X2X8MM	50	39250.022.008	4X4X16MM	50	39250.044.016	6X6X10MM	50	39250.066.010
2X2X10MM	50	39250.022.010	4X4X18MM	50	39250.044.018	6X6X12MM	50	39250.066.012
2X2X12MM	50	39250.022.012	4X4X20MM	50	39250.044.020	6X6X14MM	50	39250.066.014
2X2X14MM	50	39250.022.014	4X4X22MM	50	39250.044.022	6X6X15MM	50	39250.066.015
2X2X16MM	50	39250.022.016	4X4X25MM	50	39250.044.025	6X6X16MM	50	39250.066.016
2X2X18MM	50	39250.022.018	4X4X28MM	50	39250.044.028	6X6X18MM	50	39250.066.018
2X2X20MM	50	39250.022.020	4X4X30MM	50	39250.044.030	6X6X20MM	50	39250.066.020
2X2X22MM	50	39250.022.022	4X4X32MM	50	39250.044.032	6X6X22MM	50	39250.066.022
2X2X25MM	50	39250.022.025	4X4X35MM	50	39250.044.035	6X6X25MM	50	39250.066.025
2X2X28MM	50	39250.022.028	4X4X36MM	50	39250.044.036	6X6X28MM	50	39250.066.028
2X2X30MM	50	39250.022.030	4X4X40MM	50	39250.044.040	6X6X30MM	50	39250.066.030
2X2X36MM	50	39250.022.036	4X4X45MM	50	39250.044.045	6X6X32MM	50	39250.066.032
2X2X40MM	50	39250.022.040	4X4X50MM	50	39250.044.050	6X6X35MM	50	39250.066.035
3X3X6MM	50	39250.033.006	5X5X10MM	50	39250.055.010	6X6X36MM	50	39250.066.036
3X3X8MM	50	39250.033.008	5X5X12MM	50	39250.055.012	6X6X40MM	50	39250.066.040
3X3X10MM	50	39250.033.010	5X5X14MM	50	39250.055.014	6X6X45MM	50	39250.066.045
3X3X12MM	50	39250.033.012	5X5X15MM	50	39250.055.015	6X6X50MM	50	39250.066.050
3X3X14MM	50	39250.033.014	5X5X16MM	50	39250.055.016	6X6X55MM	50	39250.066.055
3X3X15MM	50	39250.033.015	5X5X18MM	50	39250.055.018	6X6X56MM	50	39250.066.056
3X3X16MM	50	39250.033.016	5X5X20MM	50	39250.055.020	6X6X60MM	50	39250.066.060
3X3X18MM	50	39250.033.018	5X5X22MM	50	39250.055.022	6X6X63MM	50	39250.066.063
3X3X20MM	50	39250.033.020	5X5X25MM	50	39250.055.025	6X6X65MM	50	39250.066.065
3X3X22MM	50	39250.033.022	5X5X28MM	50	39250.055.028	6X6X70MM	50	39250.066.070
3X3X25MM	50	39250.033.025	5X5X30MM	50	39250.055.030	6X6X75MM	50	39250.066.075
3X3X28MM	50	39250.033.028	5X5X32MM	50	39250.055.032	6X6X80MM	50	39250.066.080
3X3X30MM	50	39250.033.030	5X5X35MM	50	39250.055.035	6X6X90MM	50	39250.066.090
3X3X32MM	50	39250.033.032	5X5X36MM	50	39250.055.036	6X6X100MM	50	39250.066.100
3X3X35MM	50	39250.033.035	5X5X40MM	50	39250.055.040	8X7X10MM	50	39250.087.010
3X3X40MM	50	39250.033.040	5X5X45MM	50	39250.055.045	8X7X12MM	50	39250.087.012
4X4X6MM	50	39250.044.006	5X5X50MM	50	39250.055.050	8X7X15MM	50	39250.087.015
4X4X8MM	50	39250.044.008	5X5X55MM	50	39250.055.055	8X7X16MM	50	39250.087.016
4X4X10MM	50	39250.044.010	5X5X60MM	50	39250.055.060	8X7X18MM	50	39250.087.018
4X4X12MM	50	39250.044.012	5X5X63MM	50	39250.055.063	8X7X20MM	50	39250.087.020
4X4X14MM	50	39250.044.014	5X5X70MM	50	39250.055.070	8X7X22MM	50	39250.087.022

39250 Wpusty pryzmatyczne, typ wysoki								
b x h x L	☒	Kod artykułu	b x h x L	☒	Kod artykułu	b x h x L	☒	Kod artykułu
8X7X25MM	50	39250.087.025	12X8X140MM	10	39250.128.140	20X12X125MM	10	39250.212.125
8X7X28MM	50	39250.087.028	12X8X160MM	10	39250.128.160	20X12X140MM	10	39250.212.140
8X7X30MM	50	39250.087.030	12X8X180MM	10	39250.128.180	20X12X160MM	10	39250.212.160
8X7X32MM	50	39250.087.032				20X12X180MM	10	39250.212.180
8X7X35MM	25	39250.087.035	14X9X25MM	10	39250.149.025	20X12X200MM	10	39250.212.200
8X7X36MM	25	39250.087.036	14X9X28MM	10	39250.149.028	20X12X220MM	10	39250.212.220
8X7X40MM	25	39250.087.040	14X9X30MM	10	39250.149.030			
8X7X45MM	25	39250.087.045	14X9X32MM	10	39250.149.032	22X14X50MM	10	39250.234.050
8X7X50MM	25	39250.087.050	14X9X35MM	10	39250.149.035	22X14X56MM	10	39250.234.056
8X7X55MM	25	39250.087.055	14X9X36MM	10	39250.149.036	22X14X60MM	10	39250.234.060
8X7X60MM	25	39250.087.060	14X9X40MM	10	39250.149.040	22X14X63MM	10	39250.234.063
8X7X63MM	25	39250.087.063	14X9X45MM	10	39250.149.045	22X14X70MM	10	39250.234.070
8X7X65MM	25	39250.087.065	14X9X50MM	10	39250.149.050	22X14X80MM	10	39250.234.080
8X7X70MM	25	39250.087.070	14X9X55MM	10	39250.149.055	22X14X90MM	10	39250.234.090
8X7X75MM	25	39250.087.075	14X9X56MM	10	39250.149.056	22X14X100MM	10	39250.234.100
8X7X80MM	25	39250.087.080	14X9X60MM	10	39250.149.060	22X14X110MM	10	39250.234.110
8X7X85MM	25	39250.087.085	14X9X63MM	10	39250.149.063	22X14X120MM	10	39250.234.120
8X7X90MM	25	39250.087.090	14X9X65MM	10	39250.149.065	22X14X125MM	10	39250.234.125
8X7X100MM	25	39250.087.100	14X9X70MM	10	39250.149.070	22X14X140MM	10	39250.234.140
8X7X110MM	25	39250.087.110	14X9X75MM	10	39250.149.075	22X14X160MM	10	39250.234.160
8X7X120MM	25	39250.087.120	14X9X80MM	10	39250.149.080	22X14X180MM	10	39250.234.180
8X7X125MM	25	39250.087.125	14X9X85MM	10	39250.149.085	22X14X200MM	10	39250.234.200
8X7X140MM	25	39250.087.140	14X9X90MM	10	39250.149.090	22X14X220MM	10	39250.234.220
8X7X160MM	25	39250.087.160	14X9X100MM	10	39250.149.100	22X14X250MM	10	39250.234.250
8X7X180MM	25	39250.087.180	14X9X110MM	10	39250.149.110			
			14X9X120MM	10	39250.149.120	25X14X63MM	10	39250.264.063
10X8X16MM	25	39250.108.016	14X9X125MM	10	39250.149.125	25X14X70MM	10	39250.264.070
10X8X18MM	25	39250.108.018	14X9X140MM	10	39250.149.140	25X14X80MM	10	39250.264.080
10X8X20MM	25	39250.108.020	14X9X160MM	10	39250.149.160	25X14X90MM	10	39250.264.090
10X8X22MM	25	39250.108.022	14X9X180MM	10	39250.149.180	25X14X100MM	10	39250.264.100
10X8X25MM	25	39250.108.025				25X14X110MM	10	39250.264.110
10X8X28MM	25	39250.108.028	16X10X30MM	10	39250.170.030	25X14X120MM	10	39250.264.120
10X8X30MM	25	39250.108.030	16X10X32MM	10	39250.170.032	25X14X125MM	10	39250.264.125
10X8X32MM	25	39250.108.032	16X10X36MM	10	39250.170.036	25X14X140MM	10	39250.264.140
10X8X35MM	25	39250.108.035	16X10X40MM	10	39250.170.040	25X14X160MM	10	39250.264.160
10X8X36MM	25	39250.108.036	16X10X45MM	10	39250.170.045	25X14X180MM	10	39250.264.180
10X8X40MM	25	39250.108.040	16X10X50MM	10	39250.170.050	25X14X200MM	5	39250.264.200
10X8X45MM	25	39250.108.045	16X10X56MM	10	39250.170.056	25X14X220MM	5	39250.264.220
10X8X50MM	25	39250.108.050	16X10X60MM	10	39250.170.060	25X14X250MM	5	39250.264.250
10X8X55MM	25	39250.108.055	16X10X63MM	10	39250.170.063	25X14X280MM	5	39250.264.280
10X8X56MM	25	39250.108.056	16X10X70MM	10	39250.170.070			
10X8X60MM	25	39250.108.060	16X10X80MM	10	39250.170.080	28X16X63MM	5	39250.296.063
10X8X63MM	25	39250.108.063	16X10X90MM	10	39250.170.090	28X16X70MM	5	39250.296.070
10X8X65MM	25	39250.108.065	16X10X100MM	10	39250.170.100	28X16X80MM	5	39250.296.080
10X8X70MM	25	39250.108.070	16X10X110MM	10	39250.170.110	28X16X90MM	5	39250.296.090
10X8X75MM	25	39250.108.075	16X10X120MM	10	39250.170.120	28X16X100MM	5	39250.296.100
10X8X80MM	25	39250.108.080	16X10X125MM	10	39250.170.125	28X16X110MM	5	39250.296.110
10X8X85MM	25	39250.108.085	16X10X140MM	10	39250.170.140	28X16X125MM	5	39250.296.125
10X8X90MM	25	39250.108.090	16X10X160MM	10	39250.170.160	28X16X140MM	5	39250.296.140
10X8X100MM	25	39250.108.100	16X10X180MM	10	39250.170.180	28X16X160MM	5	39250.296.160
10X8X110MM	25	39250.108.110	16X10X200MM	10	39250.170.200	28X16X180MM	5	39250.296.180
10X8X120MM	25	39250.108.120				28X16X200MM	5	39250.296.200
10X8X125MM	25	39250.108.125	18X11X40MM	10	39250.191.040	28X16X220MM	5	39250.296.220
10X8X140MM	25	39250.108.140	18X11X45MM	10	39250.191.045	28X16X250MM	5	39250.296.250
10X8X160MM	25	39250.108.160	18X11X50MM	10	39250.191.050	28X16X320MM	5	39250.296.320
10X8X180MM	25	39250.108.180	18X11X56MM	10	39250.191.056			
			18X11X60MM	10	39250.191.060	32X18X70MM	5	39250.338.070
12X8X20MM	25	39250.128.020	18X11X63MM	10	39250.191.063	32X18X80MM	5	39250.338.080
12X8X22MM	25	39250.128.022	18X11X70MM	10	39250.191.070	32X18X90MM	5	39250.338.090
12X8X25MM	25	39250.128.025	18X11X80MM	10	39250.191.080	32X18X100MM	5	39250.338.100
12X8X28MM	25	39250.128.028	18X11X90MM	10	39250.191.090	32X18X110MM	5	39250.338.110
12X8X30MM	25	39250.128.030	18X11X100MM	10	39250.191.100	32X18X125MM	5	39250.338.125
12X8X32MM	25	39250.128.032	18X11X110MM	10	39250.191.110	32X18X140MM	5	39250.338.140
12X8X35MM	25	39250.128.035	18X11X120MM	10	39250.191.120	32X18X160MM	5	39250.338.160
12X8X36MM	25	39250.128.036	18X11X125MM	10	39250.191.125	32X18X180MM	5	39250.338.180
12X8X40MM	25	39250.128.040	18X11X140MM	10	39250.191.140	32X18X200MM	5	39250.338.200
12X8X45MM	25	39250.128.045	18X11X160MM	10	39250.191.160	32X18X220MM	5	39250.338.220
12X8X50MM	25	39250.128.050	18X11X180MM	10	39250.191.180	32X18X250MM	5	39250.338.250
12X8X55MM	10	39250.128.055	18X11X200MM	10	39250.191.200	32X18X280MM	5	39250.338.280
12X8X56MM	10	39250.128.056				32X18X320MM	5	39250.338.320
12X8X60MM	10	39250.128.060	20X12X40MM	10	39250.212.040	32X18X360MM	5	39250.338.360
12X8X63MM	10	39250.128.063	20X12X45MM	10	39250.212.045			
12X8X65MM	10	39250.128.065	20X12X50MM	10	39250.212.050	36X20X80MM	5	39250.380.080
12X8X70MM	10	39250.128.070	20X12X56MM	10	39250.212.056	36X20X90MM	5	39250.380.090
12X8X75MM	10	39250.128.075	20X12X60MM	10	39250.212.060	36X20X100MM	5	39250.380.100
12X8X80MM	10	39250.128.080	20X12X63MM	10	39250.212.063	36X20X110MM	5	39250.380.110
12X8X85MM	10	39250.128.085	20X12X70MM	10	39250.212.070	36X20X120MM	5	39250.380.120
12X8X90MM	10	39250.128.090	20X12X80MM	10	39250.212.080	36X20X125MM	5	39250.380.125
12X8X100MM	10	39250.128.100	20X12X90MM	10	39250.212.090	36X20X140MM	5	39250.380.140
12X8X110MM	10	39250.128.110	20X12X100MM	10	39250.212.100	36X20X160MM	5	39250.380.160
12X8X120MM	10	39250.128.120	20X12X110MM	10	39250.212.110	36X20X180MM	5	39250.380.180
12X8X125MM	10	39250.128.125	20X12X120MM	10	39250.212.120	36X20X200MM	5	39250.380.200

39250 Wpusty pryzmatyczne, typ wysoki

b x h x L	☒	Kod artykułu	b x h x L	☒	Kod artykułu	b x h x L	☒	Kod artykułu
36X20X220MM	5	39250.380.220	40X22X220MM	5	39250.422.220	45X25X280MM	5	39250.475.280
36X20X250MM	5	39250.380.250	40X22X250MM	5	39250.422.250	45X25X320MM	5	39250.475.320
36X20X280MM	5	39250.380.280	40X22X280MM	5	39250.422.280	45X25X360MM	5	39250.475.360
36X20X320MM	5	39250.380.320	40X22X320MM	5	39250.422.320	45X25X400MM	5	39250.475.400
36X20X360MM	5	39250.380.360	40X22X360MM	5	39250.422.360			
36X20X400MM	5	39250.380.400	40X22X400MM	5	39250.422.400	50X28X125MM	3	39250.528.125
						50X28X140MM	3	39250.528.140
40X22X80MM	5	39250.422.080	45X25X100MM	5	39250.475.100	50X28X160MM	3	39250.528.160
40X22X90MM	5	39250.422.090	45X25X110MM	5	39250.475.110	50X28X180MM	3	39250.528.180
40X22X100MM	5	39250.422.100	45X25X125MM	5	39250.475.125	50X28X200MM	3	39250.528.200
40X22X110MM	5	39250.422.110	45X25X140MM	5	39250.475.140	50X28X220MM	3	39250.528.220
40X22X125MM	5	39250.422.125	45X25X160MM	5	39250.475.160	50X28X250MM	3	39250.528.250
40X22X140MM	5	39250.422.140	45X25X180MM	5	39250.475.180	50X28X280MM	3	39250.528.280
40X22X160MM	5	39250.422.160	45X25X200MM	5	39250.475.200	50X28X320MM	3	39250.528.320
40X22X180MM	5	39250.422.180	45X25X220MM	5	39250.475.220	50X28X360MM	3	39250.528.360
40X22X200MM	5	39250.422.200	45X25X250MM	5	39250.475.250	50X28X400MM	3	39250.528.400

* Stal na klucze zgodn. z DIN 1652 i DIN 6880.

55510 Wpusty pryzmatyczne, typ wysoki

Materiał	Stal nierdzewna A4							R49A
	 							

b x h x L	☒	Kod artykułu	b x h x L	☒	Kod artykułu	b x h x L	☒	Kod artykułu
3X3X16MM	50	55510.033.016	6X6X63MM	25	55510.066.063	12X8X50MM	10	55510.128.050
3X3X25MM	50	55510.033.025	6X6X70MM	25	55510.066.070	12X8X56MM	50	55510.128.056
						12X8X60MM	50	55510.128.060
4X4X10MM*	200	55510.044.010	8X7X14MM*	100	55510.087.014	12X8X63MM	5	55510.128.063
4X4X12MM	25	55510.044.012	8X7X16MM	25	55510.087.016	12X8X70MM	5	55510.128.070
4X4X14MM*	200	55510.044.014	8X7X18MM	25	55510.087.018	12X8X80MM	5	55510.128.080
4X4X16MM	25	55510.044.016	8X7X20MM	25	55510.087.020	12X8X90MM*	50	55510.128.090
4X4X18MM*	200	55510.044.018	8X7X25MM	25	55510.087.025	12X8X100MM	5	55510.128.100
4X4X20MM	25	55510.044.020	8X7X28MM*	100	55510.087.028			
4X4X22MM	25	55510.044.022	8X7X30MM	25	55510.087.030	14X9X28MM	5	55510.149.028
4X4X25MM	25	55510.044.025	8X7X32MM	25	55510.087.032	14X9X30MM*	50	55510.149.030
4X4X30MM*	200	55510.044.030	8X7X35MM*	100	55510.087.035	14X9X32MM*	50	55510.149.032
4X4X32MM	25	55510.044.032	8X7X36MM	25	55510.087.036	14X9X36MM*	50	55510.149.036
4X4X36MM*	200	55510.044.036	8X7X40MM	10	55510.087.040	14X9X40MM	5	55510.149.040
4X4X40MM	25	55510.044.040	8X7X45MM	100	55510.087.045	14X9X45MM	5	55510.149.045
4X4X50MM*	200	55510.044.050	8X7X50MM	10	55510.087.050	14X9X50MM	5	55510.149.050
			8X7X60MM	10	55510.087.060	14X9X56MM	5	55510.149.056
5X5X10MM*	200	55510.055.010	8X7X63MM	10	55510.087.063	14X9X60MM	5	55510.149.060
5X5X12MM	25	55510.055.012	8X7X70MM	10	55510.087.070	14X9X63MM	5	55510.149.063
5X5X14MM*	200	55510.055.014	8X7X80MM	10	55510.087.080	14X9X70MM	5	55510.149.070
5X5X16MM	25	55510.055.016	8X7X90MM	10	55510.087.090	14X9X80MM	5	55510.149.080
5X5X18MM*	200	55510.055.018	8X7X100MM	10	55510.087.100	14X9X90MM	50	55510.149.090
5X5X20MM	25	55510.055.020	8X7X125MM	5	55510.087.125	14X9X100MM	5	55510.149.100
5X5X22MM*	200	55510.055.022						
5X5X25MM	25	55510.055.025	10X8X16MM	10	55510.108.016	16X10X50MM	5	55510.170.050
5X5X30MM*	200	55510.055.030	10X8X25MM	10	55510.108.025	16X10X63MM	5	55510.170.063
5X5X32MM	25	55510.055.032	10X8X28MM*	100	55510.108.028	16X10X70MM	5	55510.170.070
5X5X36MM*	200	55510.055.036	10X8X30MM*	100	55510.108.030	16X10X80MM	5	55510.170.080
5X5X40MM	25	55510.055.040	10X8X32MM	10	55510.108.032	16X10X100MM	5	55510.170.100
5X5X50MM	25	55510.055.050	10X8X36MM*	100	55510.108.036			
			10X8X40MM	10	55510.108.040	18X11X50MM	5	55510.191.050
6X6X12MM*	200	55510.066.012	10X8X45MM*	100	55510.108.045	18X11X60MM	5	55510.191.060
6X6X14MM*	200	55510.066.014	10X8X50MM	10	55510.108.050	18X11X63MM	5	55510.191.063
6X6X16MM	25	55510.066.016	10X8X56MM*	100	55510.108.056	18X11X70MM	5	55510.191.070
6X6X18MM*	200	55510.066.018	10X8X60MM	10	55510.108.060	18X11X80MM	5	55510.191.080
6X6X20MM	25	55510.066.020	10X8X63MM	10	55510.108.063	18X11X90MM	5	55510.191.090
6X6X22MM	25	55510.066.022	10X8X70MM	10	55510.108.070	18X11X100MM	5	55510.191.100
6X6X25MM	25	55510.066.025	10X8X80MM	10	55510.108.080	18X11X110MM	5	55510.191.110
6X6X28MM*	200	55510.066.028	10X8X90MM	10	55510.108.090	18X11X140MM	5	55510.191.140
6X6X30MM	200	55510.066.030	10X8X100MM	10	55510.108.100			
6X6X32MM	25	55510.066.032	10X8X125MM	5	55510.108.125	20X12X50MM	5	55510.212.050
6X6X35MM	25	55510.066.035				20X12X70MM	5	55510.212.070
6X6X36MM*	200	55510.066.036	12X8X30MM*	50	55510.128.030	20X12X80MM	5	55510.212.080
6X6X40MM	25	55510.066.040	12X8X32MM	10	55510.128.032	20X12X90MM	5	55510.212.090
6X6X45MM	25	55510.066.045	12X8X36MM*	50	55510.128.036	20X12X100MM	5	55510.212.100
6X6X50MM	25	55510.066.050	12X8X40MM	10	55510.128.040	20X12X110MM	5	55510.212.110
6X6X60MM*	200	55510.066.060	12X8X45MM*	50	55510.128.045	20X12X140MM	5	55510.212.140

Wpusty ze stali wyższej jakości, długość 1 metr

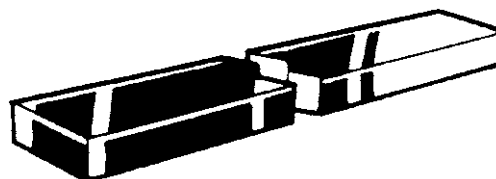
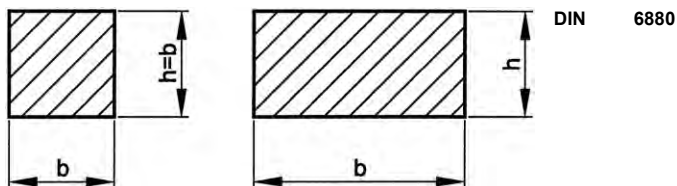



- Stal, z której wykonane są wpusty jest ciągniona na zimno.
- Nadaje się do produkcji wpustów pryzmatycznych i klinów zbieżnych.
- Wymiar b ma tolerancję wykonania h9, a wymiar h ma tolerancję wykonania h11 (z wyjątkiem rozmiaru 12 x 8 i wpustów kwadratowych stalowych, które mają tolerancję h9 zarówno dla wymiaru b, jak również dla wymiaru h).

Grupy katalogowe

Material	Kod	Strona
St C45K	39270	9-49
St.St. A4	55512	9-49

39270 Wpusty ze stali wyższej jakości, długość 1 metr		L11B
Material	Stal C45K	
		 

b x h	☒	Kod artykułu	b x h	☒	Kod artykułu	b x h	☒	Kod artykułu
3X3MM	2	39270.033.001	12X8MM	2	39270.128.001	20X20MM	1	39270.220.001
4X4MM	2	39270.044.001	12X12MM	2	39270.132.001	22X14MM	1	39270.234.001
5X5MM	2	39270.055.001	14X9MM	1	39270.149.001	22X22MM	1	39270.242.001
6X6MM	2	39270.066.001	14X14MM	1	39270.154.001	25X14MM	1	39270.264.001
7X7MM	2	39270.077.001	16X10MM	1	39270.170.001	28X16MM	1	39270.296.001
8X7MM	2	39270.087.001	16X16MM	1	39270.176.001	32X18MM	1	39270.338.001
8X8MM	2	39270.088.001	18X11MM	1	39270.191.001	36X20MM	1	39270.380.001
10X8MM	2	39270.108.001	18X18MM	1	39270.198.001	40X22MM	1	39270.422.001
10X10MM	2	39270.110.001	20X12MM	1	39270.212.001	45X25MM	1	39270.475.001

55512 Wpusty ze stali wyższej jakości, długość 1 metr		R49A
Material	Stal nierdzewna A4	DIN ≈6880
		 

b x h	☒	Kod artykułu	b x h	☒	Kod artykułu	b x h	☒	Kod artykułu
4X4MM	2	55512.044.001	12X8MM	2	55512.128.001	20X12MM	1	55512.212.001
5X5MM	2	55512.055.001	14X9MM	1	55512.149.001	22X14MM	1	55512.234.001
6X6MM	2	55512.066.001	16X10MM	1	55512.170.001	25X14MM	1	55512.264.001
8X7MM	2	55512.087.001	18X11MM	1	55512.191.001	28X16MM	1	55512.296.001
10X8MM	2	55512.108.001						

Wpusty czólenkowe

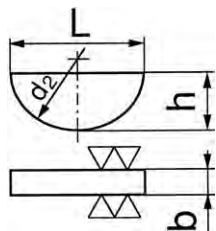

DIN 6888
ISO 3912
BS 4235-2



Informacje techniczne

b (h9) x h (h12)	Do trzonka (1.) $\varnothing >$	Do trzonka (1.) $\varnothing \leq$	Do trzonka (2.) $\varnothing >$	Do trzonka (2.) $\varnothing \leq$	d_2	$L \approx$
2x2.6	6	8	10	12	7	6.76
2x3.7	6	8	10	12	10	9.66
2x5 (#DIN)	8	10	12	17	-	12.65
2.5x3.7	8	10	12	17	10	9.66
3x3.7	8	10	12	17	10	9.66
3x5	8	10	12	17	13	12.65
3x6.5	-	-	12	17	16	15.72
3x7.5 (#DIN)	10	12	17	22	-	18.57
4x5	10	12	17	22	13	12.65
4x6.5 (#DIN)	10	12	17	22	16	15.72
4x7.5	10	12	17	22	16	15.72
4x9	12	17	22	30	16	15.72
5x6.5	12	17	22	30	16	15.72
5x7.5	12	17	22	30	19	18.57
5x9	-	-	22	30	22	21.63
6x9	17	22	30	38	22	21.63
6x11	-	-	30	38	28	27.35
6x13 (#DIN)	22	30	38	-	-	31.43
6x15 (#DIN)	-	-	-	-	-	37.14
8x11	22	30	38	-	28	27.35
8x13	-	-	38	-	32	31.43
10x13	30	38	38	-	32	31.43

- (1.) Uzasadnione zastosowanie jako wpusty łączące, przenoszące cały moment obrotowy.
- (2.) Uzasadnione zastosowanie do pozycjonowania elementu napędowego, gdy do przenoszenia momentu obrotowego stosowane są inne artykuły, np. wpusty pryzmatyczne lub kołki stożkowe.

Grupy katalogowe

Materiał	Klasa	Kod	Strona
St DIN6882	60	39200	9-50
St.St. A4		55516	9-51

39200 Wpusty czólenkowe

L11B

Materiał Stal DIN6882
Klasa 60



b x h	☒	Kod artykułu	b x h	☒	Kod artykułu	b x h	☒	Kod artykułu
2X2,6MM	100	39200.020.002	4X5MM	50	39200.040.005	6X9MM	50	39200.060.009
2X3,7MM	100	39200.020.003	4X6,5MM	50	39200.040.006	6X11MM	25	39200.060.011
2X5MM	100	39200.020.005	4X7,5MM	50	39200.040.007	6X13MM	25	39200.060.013
2.5X3,7MM	100	39200.025.003	4X9MM	50	39200.040.009	6X15MM	25	39200.060.015
3X3,7MM	100	39200.030.003	5X6,5MM	50	39200.050.006	8X11MM	10	39200.080.011
3X5MM	100	39200.030.005	5X7,5MM	50	39200.050.007	8X13MM	10	39200.080.013
3X6,5MM	100	39200.030.006	5X9MM	50	39200.050.009	10X13MM	10	39200.100.013
3X7,5MM	50	39200.030.007						

55516	Wpusty czólenkowe	R49A
Materiał	Stal nierdzewna A4	

b x h	☒	Kod artykułu	b x h	☒	Kod artykułu	b x h	☒	Kod artykułu
3X3,7MM	50	55516.030.003	4X5MM	25	55516.040.005	5X9MM	25	55516.050.009
3X5MM	50	55516.030.005	4X6,5MM	25	55516.040.006	6X9MM	25	55516.060.009
3X6,5MM	50	55516.030.006	4X7,5MM	25	55516.040.007			

Wpusty zbieżne z noskiem klinowym

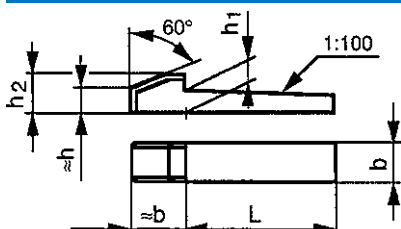

DIN 6887
ISO 774
BS 4235-1



Informacje techniczne

b (h9)	Do trzonka $\phi >$	Do trzonka $\phi \leq$	h (nom.)	h ₁	h ₂
6	17	22	6	6.1	10
8	22	30	7	7.2	11
10	30	38	8	8.2	12
12	38	44	8	8.2	12
14	44	50	9	9.2	14
16	50	58	10	10.2	16
18	58	65	11	11.2	18
32	110	130	18	18.3	28
36	130	150	20	20.4	32
40	150	170	22	22.4	36

• b(h9) Dla szerokości rowka klinowego zalecana jest tolerancja D10.

39220	Wpusty zbieżne z noskiem klinowym	L11B
Materiał	Stal DIN6880	

b x h x L	☒	Kod artykułu	b x h x L	☒	Kod artykułu	b x h x L	☒	Kod artykułu
6X6X40MM	25	39220.066.040	12X8X50MM	10	39220.128.050	16X10X80MM	10	39220.170.080
6X6X50MM	25	39220.066.050	12X8X60MM	10	39220.128.060	16X10X100MM	10	39220.170.100
6X6X60MM	25	39220.066.060	12X8X63MM	10	39220.128.063	18X11X63MM	10	39220.191.063
8X7X40MM	25	39220.087.040	12X8X70MM	10	39220.128.070	18X11X70MM	10	39220.191.070
8X7X50MM	25	39220.087.050	12X8X80MM	10	39220.128.080	18X11X80MM	10	39220.191.080
8X7X63MM	25	39220.087.063	12X8X90MM	10	39220.128.090	18X11X90MM	10	39220.191.090
8X7X70MM	25	39220.087.070	12X8X100MM	10	39220.128.100	18X11X100MM	10	39220.191.100
8X7X80MM	25	39220.087.080	14X9X50MM	10	39220.149.050	18X11X140MM	10	39220.191.140
10X8X40MM	25	39220.108.040	14X9X63MM	10	39220.149.063	32X18X160MM	5	39220.338.160
10X8X50MM	25	39220.108.050	14X9X70MM	10	39220.149.070	32X18X200MM	5	39220.338.200
10X8X63MM	25	39220.108.063	14X9X80MM	10	39220.149.080	36X20X160MM	5	39220.380.160
10X8X70MM	25	39220.108.070	14X9X90MM	10	39220.149.090	36X20X200MM	5	39220.380.200
10X8X80MM	25	39220.108.080	14X9X100MM	10	39220.149.100	40X22X200MM	5	39220.422.200
10X8X100MM	25	39220.108.100	16X10X63MM	10	39220.170.063			
12X8X40MM	10	39220.128.040	16X10X70MM	10	39220.170.070			

Fabory nity zrywalne

Technologia nitowania jest prosta. Materiały przeznaczone do nitowania mogą być dostępne tylko z jednej strony. To wyjaśnia angielski termin 'nity ślepe'. Nit składa się z dwóch części: korpusu i trzpienia. Korpus (łeb) ulega deformacji przy osadzaniu nitu i właśnie ta deformacja powoduje zacisk łączonych materiałów. Trzpień jest tą częścią nitu, która deformuje jego korpus. Jest on mocniejszy niż korpus. Trzpień ulega odłamaniu w specyficznym punkcie odłamania. Taki punkt odłamania zapewnia to, że trzpień odłamuje się dokładnie we właściwym momencie tak, aby spowodować deformację korpusu i prawidłowy zacisk łączonych materiałów.

Linia nitów zrywalnych Fabory obejmuje sześć głównych grup

Omni: nity standardowe

Plus Bulb & P-Lock: nity wysokiej wytrzymałości

Multi: nity o szerokim zakresie

Sigma: nity szczelne

Specials: nity specjalne do materiałów miękkich (EXPO, TRIPO, HAMMER)

Fabory Omni

Marka Fabory Omni reprezentuje gamę standardowych otwartych nitów zrywalnych. Nit Fabory Omni jest nitem ogólnego stosowania o punkcie odłamania trzpienia umieszczonym bezpośrednio pod główką trzpienia.

Fabory Nity Wysokiej Wytrzymałości (P-Lock & Plus Bulb)

Nity wysokiej wytrzymałości są przeznaczone szczególnie do zastosowań wysoko-obciążeniowych, na przykład w przemyśle samochodowym, budownictwie, naprawach, urządzeniach grzewczych, wentylacyjnych i klimatyzacyjnych, wyrobach AGD, szafkach... Krótko mówiąc, wszędzie tam, gdzie duże obciążenie wiąże się z potrzebą niezawodności. Nity wysokiej wytrzymałości są znane ze swej dużej wytrzymałości na rozciąganie oraz ścinanie a także wysokiej retencji trzpienia.

Grupa nitów wysokiej wytrzymałości 34350 (P-Lock)

Nit jednostronny o uniwersalnym zakresie zaciskania oraz wysokiej wytrzymałości na rozciąganie oraz ścinanie oferuje dużą odporność na wibracje i daje połączenia wodoodporne. Po zaciśnięciu, pozostały trzpień zostaje na zawsze w materiale ze względu na specjalny system blokowania trzpienia. Aby zaciśnąć ten rodzaj nitu potrzebne jest specjalne oprzyrządowanie lub główka do nitownicy sprawdź specyfikację narzędzia). Minimalna wymagana siła zaciskania 13,5 kN.

Grupy nitów wysokiej wytrzymałości 32635 - 32642 (Plus Bulb)

Nity grupy Plus Bulb zostały zaprojektowane aby spełnić oczekiwania rynku na łącznik jednostronny o dużej sile zacisku z przeznaczeniem do blach cienkich. Duża średnica główki oraz szeroki kołnierz wtórny rozkładają nacisk na dużą powierzchnię zapewniając tym samym trwałe połączenie. Ten unikatowy nit posiada też stożkową końcówkę naprowadzającą na otwór, co zapewnia szybki i łatwy montaż.

Zalety grup 34350 (P-Lock) i 32635-32642 (Plus Bulb) obejmują:

- Specjalny mechanizm blokujący zwiększa siłę docisku
- Po zanitowaniu trzpień pozostaje trwale zablokowany
- Połączenie w 100% wodoszczelne
- Duża odporność na wibracje
- Duży siła zaciskania

Grupy nitów wysokiej wytrzymałości 34320 - 34330 (Plus Bulb)

Ten rodzaj nitów Plus Bulb, ze stali zwykłej oraz nierdzewnej, tworzy bardzo duży kołnierz wtórny po zanitowaniu. To sprawia, że nit ten jest idealny do wysokowytrzymałościowych połączeń blach cienkich.

Zalety

- Wysoka wytrzymałość na rozciąganie oraz ścinanie
- Stałe zablokowanie trzpienia, pozwala uniknąć usuwania jego pozostałości
- Dobre wypełnienie otworu kompensuje problemy z nadwymiarowymi, szczelinowymi lub źle dopasowanymi otworami
- Zapewnia dużą tylną powierzchnię czynną
- Dobry rozkład siły zacisku
- Odporność na wibracje
- Nie wymaga specjalnego oprzyrządowania lub nasadki nitownicy

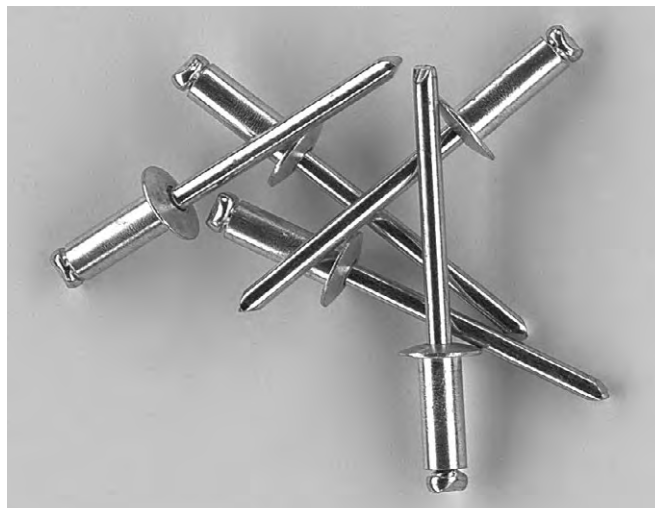

Fabory Multi

Nit typu Fabory Multi jest nitom uniwersalnym o poszerzonym zakresie zacisku. To pomaga osiągnąć znaczną redukcję zapasów magazynowych. Po zaciśnięciu powstaje dużej wielkości główka, która rozkłada siłę zacisku na szerszą powierzchnię. Po zanitowaniu łeb jest bardzo mocno osadzony, co sprawia, że połączenie jest odporne na wibracje. Dzięki cechom strukturalnym nitu ma on dobre własności wypełniania otworu, tak więc precyzja nawierconego wcześniej otworu ma mniejsze znaczenie.

Fabory Sigma

Linia Fabory Sigma oferuje nity szczelne opracowane specjalnie dla połączenia silnego mocowania z uszczelnieniem wodnym lub powietrznym. W trakcie nitowania korpus nitu rozszerza się by wypełnić otwór, co pozwala mu wytrzymać ciśnienie do 35 bar (3500 kPa). Łeb jest mocno zaciśnięty, dając wysoką odporność na wibracje. W rezultacie powstaje połączenie nitowane o wysokiej odporności na rozciąganie i ścinanie. Celem zapewnienia optymalnego łączenia nitami szczelnymi ważne jest, aby uprzednio nawiercony otwór miał prawidłowy wymiar.

Fabory Specials

W uzupełnieniu standardowej gamy nitów zrywalnych Fabory oferuje dostawę licznych innych nitów do zastosowań specjalnych pod nazwą Fabory Specials.

Dla zastosowań w materiałach miękkich.

- nity EXPO Peel
- nity TRIPO
- nity HAMMER

Narzędzia

Do całego zakresu nitów dostępne są odpowiednie narzędzia.

Są to narzędzia do niewielkich i lekkich prac montażowych a także do ciężkich zastosowań. Fabory prowadzi wysokiej jakości narzędzia ręczne, hydrauliczne/pneumatyczne a także akumulatorowe (bezzprzewodowe). Więcej szczegółów znajdziesz na www.fabory.com.

OMNI Nity zrywalne

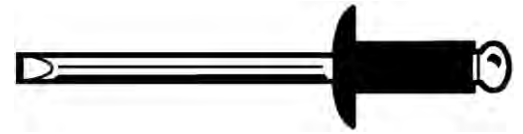
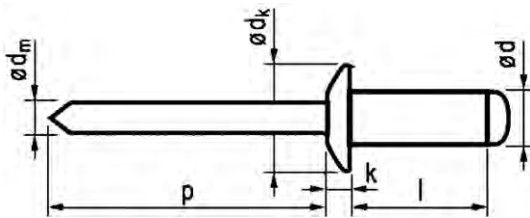

Informacje techniczne

$\varnothing d$	k	p	Wiertło \varnothing	$\varnothing d_k$
2.4	0.7	≥ 27	2.5	5.0
3.0	0.8	≥ 27	3.1	6.5
3.2	0.8	≥ 27	3.3	6.5
4.0	1.0	≥ 27	4.1	8.0
4.8	1.1	≥ 27	4.9	9.5
5.0	1.1	≥ 27	5.1	9.5
6.0	1.5	≥ 31	6.1	12.0
6.4	1.8	≥ 31	6.5	13.0

Grupy katalogowe

Material	Obróbka powierzchni		Kod	Strona
Al AIMg 2,5/3,5		Al - St. Ocynk	34110	9-55
Al AIMg 2,5/3,5		Al czarn. a. - St cynk.	34310	9-56
Al AIMg 3		Al - St.St. A2	34190	9-56
Al AIMg 2,5		Al - Al	33190	9-57
St	Ocynk.	St Ocynk - St Ocynk	34130	9-57
St.St. A2		St.St. A2 - St.St. A2	34180	9-58
St.St. A4		St.St. A4 - St.St. A4	34186	9-59
Miedź		Cu - St cynk.	34150	9-59

Material Aluminium AlMg 2,5/3,5



ø d	l		ø d _m		
(mm)	(mm)	(mm)	(mm)	(N)	(N)
2,4	4,0	≈ 2,0	≈ 1,45	355	315
2,4	6,0	2,0-4,0	≈ 1,45	355	315
2,4	8,0	4,0-6,0	≈ 1,45	355	315
3,0	4,0	≈ 1,5	≈ 1,75	810	620
3,0	6,0	1,5-3,5	≈ 1,75	810	620
3,0	8,0	3,5-5,5	≈ 1,75	810	620
3,0	10,0	5,5-7,5	≈ 1,75	810	620
3,0	12,0	7,5-9,5	≈ 1,75	810	620
3,0	16,0	11,5-13,5	≈ 1,75	810	620
3,2	4,0	≈ 1,5	≈ 1,75	980	760
3,2	6,0	1,5-3,5	≈ 1,75	980	760
3,2	8,0	3,5-5,5	≈ 1,75	980	760
3,2	10,0	5,5-7,5	≈ 1,75	980	760
3,2	12,0	7,5-9,5	≈ 1,75	980	760
3,2	14,0	9,5-11,5	≈ 1,75	980	760
3,2	16,0	11,5-13,5	≈ 1,75	980	760
3,2	18,0	13,5-15,5	≈ 1,75	980	760
3,2	20,0	15,5-17,5	≈ 1,75	980	760
4,0	5,0	≈ 1,5	≈ 2,10	1600	1200
4,0	6,0	1,5-3,0	≈ 2,10	1600	1200
4,0	8,0	3,0-5,0	≈ 2,10	1600	1200
4,0	10,0	5,0-6,5	≈ 2,10	1600	1200
4,0	12,0	6,5-8,5	≈ 2,10	1600	1200
4,0	14,0	8,5-10,5	≈ 2,10	1600	1200
4,0	16,0	10,5-12,5	≈ 2,10	1600	1200
4,0	18,0	12,5-14,5	≈ 2,10	1600	1200
4,0	20,0	14,5-16,5	≈ 2,10	1600	1200
4,0	25,0	19,0-21,5	≈ 2,10	1600	1200
4,0	30,0	21,5-26,0	≈ 2,10	1600	1200
4,0	35,0	26,0-30,0	≈ 2,10	1600	1200
4,8	6,0	1,0-3,0	≈ 2,70	2230	1690
4,8	8,0	3,0-4,5	≈ 2,70	2230	1690
4,8	10,0	4,5-6,0	≈ 2,70	2230	1690
4,8	12,0	6,0-8,0	≈ 2,70	2230	1690
4,8	14,0	8,0-10,0	≈ 2,70	2230	1690
4,8	16,0	10,0-12,0	≈ 2,70	2230	1690
4,8	18,0	12,0-14,0	≈ 2,70	2230	1690
4,8	20,0	14,0-16,0	≈ 2,70	2230	1690
4,8	22,0	16,0-18,0	≈ 2,70	2230	1690



ø d	l		ø d _m		
(mm)	(mm)	(mm)	(mm)	(N)	(N)
4,8	25,0	18,0-21,0	≈ 2,70	2230	1690
4,8	28,0	21,0-23,5	≈ 2,70	2230	1690
4,8	30,0	23,5-25,0	≈ 2,70	2230	1690
4,8	35,0	25,0-30,0	≈ 2,70	2230	1690
4,8	45,0	35,0-39,0	≈ 2,70	2230	1690
5,0	6,0	1,0-3,0	≈ 2,70	2500	2000
5,0	8,0	3,0-4,5	≈ 2,70	2500	2000
5,0	10,0	4,5-6,0	≈ 2,70	2500	2000
5,0	12,0	6,0-8,0	≈ 2,70	2500	2000
5,0	14,0	8,0-10,0	≈ 2,70	2500	2000
5,0	16,0	10,0-12,0	≈ 2,70	2500	2000
5,0	18,0	12,0-14,0	≈ 2,70	2500	2000
5,0	21,0	14,0-17,0	≈ 2,70	2500	2000
5,0	25,0	17,0-20,0	≈ 2,70	2500	2000
5,0	27,0	20,0-23,0	≈ 2,70	2500	2000
5,0	30,0	23,0-25,0	≈ 2,70	2500	2000
5,0	35,0	25,0-30,0	≈ 2,70	2500	2000
5,0	40,0	30,0-35,0	≈ 2,70	2500	2000
5,0	45,0	35,0-40,0	≈ 2,70	2500	2000
5,0	50,0	40,0-45,0	≈ 2,70	2500	2000
5,0	55,0	45,0-50,0	≈ 2,70	2500	2000
5,0	60,0	50,0-55,0	≈ 2,70	2500	2000
6,0	8,0	2,0-4,0	≈ 3,60	3900	3000
6,0	10,0	4,0-6,0	≈ 3,60	3900	3000
6,0	12,0	6,0-8,0	≈ 3,60	3900	3000
6,0	14,0	7,0-9,0	≈ 3,60	3900	3000
6,0	16,0	9,0-11,0	≈ 3,60	3900	3000
6,0	18,0	11,0-13,0	≈ 3,60	3900	3000
6,0	22,0	13,0-17,0	≈ 3,60	3900	3000
6,0	26,0	17,0-20,0	≈ 3,60	3900	3000
6,0	30,0	20,0-24,0	≈ 3,60	3900	3000
6,4	12,0	4,0-6,0	≈ 3,85	4090	3120
6,4	15,0	6,0-9,0	≈ 3,85	4090	3120
6,4	18,0	9,0-13,0	≈ 3,85	4090	3120
6,4	22,0	13,0-16,0	≈ 3,85	4090	3120
6,4	26,0	16,0-20,0	≈ 3,85	4090	3120
6,4	30,0	18,0-24,0	≈ 3,85	4090	3120
6,4	35,0	24,0-30,0	≈ 3,85	4090	3120



9

d x L	☒	Kod artykułu	d x L	☒	Kod artykułu	d x L	☒	Kod artykułu
2,4X4MM	500	34110.024.004	3,2X16MM	500	34110.032.016	4,8X8MM	500	34110.048.008
2,4X6MM	500	34110.024.006	3,2X18MM	500	34110.032.018	4,8X10MM	500	34110.048.010
2,4X8MM	500	34110.024.008	3,2X20MM	500	34110.032.020	4,8X12MM	500	34110.048.012
3,0X4MM	500	34110.030.004	4,0X6MM	500	34110.040.006	4,8X14MM	500	34110.048.014
3,0X6MM	500	34110.030.006	4,0X8MM	500	34110.040.008	4,8X16MM	500	34110.048.016
3,0X8MM	500	34110.030.008	4,0X10MM	500	34110.040.010	4,8X18MM	500	34110.048.018
3,0X10MM	500	34110.030.010	4,0X12MM	500	34110.040.012	4,8X20MM	500	34110.048.020
3,0X12MM	500	34110.030.012	4,0X14MM	500	34110.040.014	4,8X22MM	500	34110.048.022
3,0X16MM	500	34110.030.016	4,0X16MM	500	34110.040.016	4,8X25MM	500	34110.048.025
3,2X4MM	500	34110.032.004	4,0X18MM	500	34110.040.018	4,8X30MM	250	34110.048.030
3,2X6MM	500	34110.032.006	4,0X20MM	500	34110.040.020	4,8X35MM	250	34110.048.035
3,2X8MM	500	34110.032.008	4,0X25MM	500	34110.040.025	4,8X45MM	250	34110.048.045
3,2X10MM	500	34110.032.010	4,0X30MM	500	34110.040.030	5,0X6MM	500	34110.050.006
3,2X12MM	500	34110.032.012	4,0X35MM	500	34110.040.035	5,0X8MM	500	34110.050.008
3,2X14MM	500	34110.032.014	4,8X6MM	500	34110.048.006	5,0X10MM	500	34110.050.010
						5,0X12MM	500	34110.050.012

34110 OMNI Nity zrywalne								
d x L	☒	Kod artykułu	d x L	☒	Kod artykułu	d x L	☒	Kod artykułu
5,0X14MM	500	34110.050.014	5,0X50MM	100	34110.050.050	6,0X26MM	250	34110.060.026
5,0X16MM	500	34110.050.016	5,0X60MM	250	34110.050.060	6,0X30MM	250	34110.060.030
5,0X18MM	500	34110.050.018						
5,0X21MM	500	34110.050.021	6,0X8MM	500	34110.060.008	6,4X12MM	250	34110.064.012
5,0X25MM	500	34110.050.025	6,0X10MM	500	34110.060.010	6,4X15MM	250	34110.064.015
5,0X27MM	250	34110.050.027	6,0X12MM	500	34110.060.012	6,4X18MM	250	34110.064.018
5,0X30MM	500	34110.050.030	6,0X14MM	250	34110.060.014	6,4X22MM	250	34110.064.022
5,0X35MM	100	34110.050.035	6,0X16MM	500	34110.060.016	6,4X26MM	250	34110.064.026
5,0X40MM	250	34110.050.040	6,0X18MM	250	34110.060.018	6,4X30MM	250	34110.064.030
5,0X45MM	100	34110.050.045	6,0X22MM	250	34110.060.022	6,4X35MM	250	34110.064.035

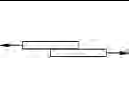

34310 OMNI Nity zrywalne		T05A
Materiał	Aluminium AlMg 2,5/3,5	

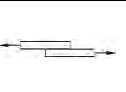

∅ d	l		∅ d _m		
(mm)	(mm)	(mm)	(mm)	(N)	(N)
3,0	8,0	3,5-5,5	≈ 1,75	810	620
3,0	10,0	5,5-7,5	≈ 1,75	810	620
3,0	12,0	7,5-9,5	≈ 1,75	810	620

∅ d	l		∅ d _m		
(mm)	(mm)	(mm)	(mm)	(N)	(N)
4,0	8,0	3,0-5,0	≈ 2,10	1600	1200
4,0	10,0	5,0-6,5	≈ 2,10	1600	1200
4,0	12,0	6,5-8,5	≈ 2,10	1600	1200

d x L	☒	Kod artykułu	d x L	☒	Kod artykułu	d x L	☒	Kod artykułu
3,0X8MM	500	34310.030.008				4,0X10MM	500	34310.040.010
3,0X10MM	500	34310.030.010	4,0X8MM	500	34310.040.008	4,0X12MM	500	34310.040.012
3,0X12MM	500	34310.030.012						

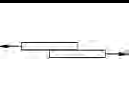
34190 OMNI Nity zrywalne		T05A
Materiał	Aluminium AlMg 3	
		

∅ d	l		∅ d _m		
(mm)	(mm)	(mm)	(mm)	(N)	(N)
3,0	4,0	≈ 1,5	≈ 1,75	810	620
3,0	6,0	1,5-3,5	≈ 1,75	810	620
3,0	8,0	3,5-5,5	≈ 1,75	810	620
3,0	10,0	5,5-7,0	≈ 1,75	810	620
3,0	12,0	7,0-9,0	≈ 1,75	810	620
3,2	6,0	1,5-3,5	≈ 1,95	980	760
3,2	8,0	3,5-5,5	≈ 1,95	980	760
4,0	6,0	1,0-3,0	≈ 2,10	1600	1200
4,0	8,0	3,0-5,0	≈ 2,10	1600	1200
4,0	10,0	5,0-7,0	≈ 2,10	1600	1200
4,0	12,0	7,0-9,0	≈ 2,10	1600	1200
4,0	16,0	11,5-12,5	≈ 2,10	1600	1200

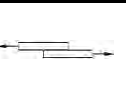
∅ d	l		∅ d _m		
(mm)	(mm)	(mm)	(mm)	(N)	(N)
4,0	20,0	15,0-17,0	≈ 2,10	1600	1200
4,0	25,0	17,0-20,0	≈ 2,10	1600	1200
4,8	10,0	4,5-6,5	≈ 2,70	2230	1690
4,8	12,0	6,5-8,5	≈ 2,70	2230	1690
4,8	14,0	8,5-10,5	≈ 2,70	2230	1690
4,8	16,0	10,5-12,5	≈ 2,70	2230	1690
5,0	8,0	2,5-4,5	≈ 2,70	2500	2000
5,0	10,0	4,5-6,5	≈ 2,70	2500	2000
5,0	12,0	6,5-8,5	≈ 2,70	2500	2000
5,0	14,0	8,5-10,5	≈ 2,70	2500	2000
5,0	16,0	10,5-12,5	≈ 2,70	2500	2000

d x L	☒	Kod artykułu	d x L	☒	Kod artykułu	d x L	☒	Kod artykułu
3,0X6MM	500	34190.030.006	4,0X8MM	500	34190.040.008	4,8X12MM	500	34190.048.012
3,0X8MM	500	34190.030.008	4,0X10MM	500	34190.040.010	4,8X14MM	500	34190.048.014
3,0X10MM	500	34190.030.010	4,0X12MM	500	34190.040.012	4,8X16MM	500	34190.048.016
3,0X12MM	500	34190.030.012	4,0X16MM	500	34190.040.016			
			4,0X20MM	250	34190.040.020	5,0X8MM	500	34190.050.008
3,2X6MM	500	34190.032.006	4,0X25MM	500	34190.040.025	5,0X10MM	500	34190.050.010
3,2X8MM	500	34190.032.008				5,0X12MM	500	34190.050.012
4,0X6MM	500	34190.040.006	4,8X10MM	500	34190.048.010	5,0X16MM	500	34190.050.016

33190 OMNI Nity zrywalne **T05A**

Materiał Aluminium AlMg 2,5

∅ d	l		∅ d _m		
(mm)	(mm)	(mm)	(mm)	(N)	(N)
3,2	6,0	1,5-3,5	≈ 1,95	670	535
3,2	8,0	3,5-5,5	≈ 1,95	670	535
3,2	10,0	5,5-7,5	≈ 1,95	670	535
4,0	6,0	1,5-3,0	≈ 2,45	1025	845
4,0	8,0	3,0-5,0	≈ 2,45	1025	845
4,0	10,0	5,0-7,0	≈ 2,45	1025	845

∅ d	l		∅ d _m		
(mm)	(mm)	(mm)	(mm)	(N)	(N)
4,0	12,0	7,0-9,0	≈ 2,45	1025	845
4,8	8,0	2,5-4,5	≈ 2,90	1425	1155
4,8	10,0	4,5-6,5	≈ 2,90	1425	1155
4,8	12,0	6,5-8,5	≈ 2,90	1425	1155
4,8	14,0	8,5-10,5	≈ 2,90	1425	1155

d x L	☒	Kod artykułu	d x L	☒	Kod artykułu	d x L	☒	Kod artykułu
3,2X6MM	500	33190.032.006	4,0X8MM	500	33190.040.008	4,8X8MM	500	33190.048.008
3,2X8MM	500	33190.032.008	4,0X10MM	500	33190.040.010	4,8X10MM	500	33190.048.010
3,2X10MM	500	33190.032.010	4,0X12MM	500	33190.040.012	4,8X12MM	500	33190.048.012
4,0X6MM	500	33190.040.006				4,8X14MM	500	33190.048.014

34130 OMNI Nity zrywalne **T05A**

Materiał Stal
Obróbka powierzchni Ocynkowane

∅ d	l		∅ d _m		
(mm)	(mm)	(mm)	(mm)	(N)	(N)
3,0	6,0	1,5-3,0	≈ 1,90	1125	915
3,0	8,0	3,0-5,0	≈ 1,90	1125	915
3,0	10,0	5,0-7,0	≈ 1,90	1125	915
3,0	12,0	7,0-9,0	≈ 1,90	1125	915
3,0	14,0	9,0-11,0	≈ 1,90	1125	915
3,2	6,0	1,5-3,0	≈ 2,00	1285	1060
3,2	8,0	3,0-5,0	≈ 2,00	1285	1060
3,2	10,0	5,0-7,0	≈ 2,00	1285	1060
3,2	12,0	7,0-9,0	≈ 2,00	1285	1060
3,2	14,0	9,0-11,0	≈ 2,00	1285	1060
4,0	6,0	1,5-2,5	≈ 2,50	1990	1550
4,0	8,0	2,5-4,5	≈ 2,50	1990	1550
4,0	10,0	4,5-6,5	≈ 2,50	1990	1550
4,0	12,0	6,5-8,5	≈ 2,50	1990	1550
4,0	14,0	8,5-10,5	≈ 2,50	1990	1550
4,0	16,0	10,5-12,5	≈ 2,50	1990	1550
4,0	18,0	12,5-14,5	≈ 2,50	1990	1550
4,0	20,0	14,5-16,5	≈ 2,50	1990	1550
4,8	6,0	1,0-2,5	≈ 2,90	2920	2300
4,8	8,0	2,5-4,5	≈ 2,90	2920	2300
4,8	10,0	4,5-6,0	≈ 2,90	2920	2300
4,8	12,0	6,0-8,0	≈ 2,90	2920	2300
4,8	14,0	8,0-10,0	≈ 2,90	2920	2300
4,8	16,0	10,0-11,5	≈ 2,90	2920	2300

∅ d	l		∅ d _m		
(mm)	(mm)	(mm)	(mm)	(N)	(N)
4,8	18,0	11,5-13,5	≈ 2,90	2920	2300
4,8	20,0	13,5-15,0	≈ 2,90	2920	2300
4,8	22,0	15,0-17,0	≈ 2,90	2920	2300
4,8	25,0	17,0-20,0	≈ 2,90	2920	2300
5,0	8,0	2,5-4,0	≈ 2,90	3255	2575
5,0	10,0	4,0-6,0	≈ 2,90	3255	2575
5,0	12,0	6,0-8,0	≈ 2,90	3255	2575
5,0	14,0	8,0-10,0	≈ 2,90	3255	2575
5,0	16,0	10,0-11,5	≈ 2,90	3255	2575
5,0	18,0	11,5-13,5	≈ 2,90	3255	2575
5,0	20,0	13,5-15,0	≈ 2,90	3255	2575
5,0	25,0	15,0-16,5	≈ 2,90	3255	2575
5,0	30,0	21,0-24,0	≈ 2,90	3255	2575
5,0	35,0	22,0-30,0	≈ 2,90	3255	2575
5,0	40,0	27,0-35,0	≈ 2,90	3255	2575
6,0	10,0	1,5-4,5	≈ 3,60	5020	4040
6,0	12,0	3,5-6,5	≈ 3,60	5020	4040
6,4	12,0	3,5-6,5	≈ 3,85	5415	4355
6,4	15,0	6,5-9,5	≈ 3,85	5415	4355
6,4	18,0	9,5-12,5	≈ 3,85	5415	4355
6,4	22,0	14,5-16,5	≈ 3,85	5415	4355
6,4	26,0	18,5-20,5	≈ 3,85	5415	4355
6,4	30,0	22,5-24,5	≈ 3,85	5415	4355

d x L	☒	Kod artykułu	d x L	☒	Kod artykułu	d x L	☒	Kod artykułu
3,0X6MM	500	34130.030.006	3,0X12MM	500	34130.030.012	3,2X6MM	500	34130.032.006
3,0X8MM	500	34130.030.008	3,0X14MM	500	34130.030.014	3,2X8MM	500	34130.032.008
3,0X10MM	500	34130.030.010				3,2X10MM	500	34130.032.010

34130 OMNI Nity zrywalne								
d x L	☒	Kod artykułu	d x L	☒	Kod artykułu	d x L	☒	Kod artykułu
3,2X12MM	500	34130.032.012	4,8X10MM	500	34130.048.010	5,0X18MM	200	34130.050.018
3,2X14MM	500	34130.032.014	4,8X12MM	500	34130.048.012	5,0X20MM	500	34130.050.020
4,0X6MM	500	34130.040.006	4,8X14MM	500	34130.048.014	5,0X40MM	250	34130.050.040
4,0X8MM	500	34130.040.008	4,8X16MM	500	34130.048.016	6,0X12MM	250	34130.060.012
4,0X10MM	500	34130.040.010	4,8X18MM	500	34130.048.018	6,4X12MM	250	34130.064.012
4,0X12MM	500	34130.040.012	4,8X20MM	500	34130.048.020	6,4X15MM	250	34130.064.015
4,0X14MM	500	34130.040.014	4,8X22MM	250	34130.048.022	6,4X18MM	200	34130.064.018
4,0X16MM	500	34130.040.016	4,8X25MM	250	34130.048.025	6,4X22MM	250	34130.064.022
4,0X18MM	500	34130.040.018	5,0X8MM	500	34130.050.008	6,4X26MM	250	34130.064.026
4,0X20MM	500	34130.040.020	5,0X10MM	500	34130.050.010	6,4X30MM	100	34130.064.030
4,8X6MM	500	34130.048.006	5,0X12MM	500	34130.050.012			
4,8X8MM	500	34130.048.008	5,0X14MM	500	34130.050.014			
			5,0X16MM	250	34130.050.016			

34180 OMNI Nity zrywalne		T05A
Materiał	Stal nierdzewna A2	
		
		

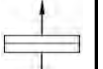
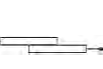

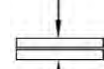
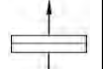
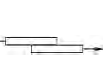
∅ d	l		∅ d _m		
(mm)	(mm)	(mm)	(mm)	(N)	(N)
3,0	6,0	1,5-2,5	≈ 1,90	2000	1600
3,0	8,0	2,5-4,5	≈ 1,90	2000	1600
3,0	10,10	4,5-6,5	≈ 1,90	2000	1600
3,0	12,0	6,5-8,5	≈ 1,90	2000	1600
3,0	15,0	9,5-11,5	≈ 1,90	2000	1600
3,2	6,0	1,5-2,5	≈ 2,00	2500	1800
3,2	8,0	2,5-4,5	≈ 2,00	2500	1800
3,2	10,0	4,5-6,5	≈ 2,00	2500	1800
3,2	12,0	6,5-8,5	≈ 2,00	2500	1800
3,2	15,0	8,5-12,0	≈ 2,00	2500	1800
4,0	6,0	≈ 2,0	≈ 2,50	3800	3100
4,0	8,0	2,0-4,0	≈ 2,50	3800	3100
4,0	10,0	4,0-6,0	≈ 2,50	3800	3100
4,0	13,0	7,0-9,0	≈ 2,50	3800	3100
4,0	14,0	9,0-10,0	≈ 2,50	3800	3100
4,0	16,0	10,0-12,0	≈ 2,50	3800	3100
4,0	18,0	12,0-14,0	≈ 2,50	3800	3100
4,0	20,0	14,0-16,0	≈ 2,50	3800	3100

∅ d	l		∅ d _m		
(mm)	(mm)	(mm)	(mm)	(N)	(N)
4,0	25,0	17,0-21,0	≈ 2,50	3800	3100
4,8	8,0	1,5-3,0	≈ 2,90	6000	4500
4,8	10,0	3,0-5,0	≈ 2,90	6000	4500
4,8	12,0	5,0-7,0	≈ 2,90	6000	4500
4,8	16,0	9,0-11,0	≈ 2,90	6000	4500
4,8	18,0	11,0-13,0	≈ 2,90	6000	4500
4,8	20,0	13,0-15,0	≈ 2,90	6000	4500
4,8	25,0	15,0-20,0	≈ 2,90	6000	4500
4,8	27,0	18,0-22,0	≈ 2,90	6000	4500
4,8	30,0	20,0-25,0	≈ 2,90	6000	4500
5,0	8,0	1,5-3,0	≈ 2,90	6500	5000
5,0	10,0	3,0-5,0	≈ 2,90	6500	5000
5,0	12,0	5,0-7,0	≈ 2,90	6500	5000
5,0	16,0	9,0-11,0	≈ 2,90	6500	5000
5,0	18,0	11,0-13,0	≈ 2,90	6500	5000
5,0	20,0	13,0-15,0	≈ 2,90	6500	5000
5,0	25,0	17,0-20,0	≈ 2,90	6500	5000

d x L	☒	Kod artykułu	d x L	☒	Kod artykułu	d x L	☒	Kod artykułu
3,0X6MM	500	34180.030.006	4,0X6MM	500	34180.040.006	4,8X14MM	500	34180.048.014
3,0X8MM	500	34180.030.008	4,0X8MM	500	34180.040.008	4,8X16MM	500	34180.048.016
3,0X10MM	500	34180.030.010	4,0X10MM	500	34180.040.010	4,8X18MM	500	34180.048.018
3,0X12MM	500	34180.030.012	4,0X13MM	500	34180.040.013	4,8X20MM	500	34180.048.020
3,0X15MM	500	34180.030.015	4,0X16MM	500	34180.040.016	4,8X25MM	500	34180.048.025
3,2X6MM	500	34180.032.006	4,0X18MM	500	34180.040.018	4,8X30MM	500	34180.048.030
3,2X8MM	500	34180.032.008	4,0X20MM	500	34180.040.020	5,0X8MM	500	34180.050.008
3,2X10MM	500	34180.032.010	4,0X25MM	500	34180.040.025	5,0X10MM	500	34180.050.010
3,2X12MM	500	34180.032.012	4,8X8MM	500	34180.048.008	5,0X12MM	500	34180.050.012
3,2X15MM	500	34180.032.015	4,8X10MM	500	34180.048.010	5,0X16MM	500	34180.050.016
			4,8X12MM	500	34180.048.012	5,0X20MM	250	34180.050.020

34186 OMNI Nity zrywalne T05A

Materiał Stal nierdzewna A4

$\varnothing d$	l		$\varnothing d_m$		
(mm)	(mm)	(mm)	(mm)	(N)	(N)
3,0	6,0	1,5-2,5	$\approx 1,90$	2000	1600
3,0	8,0	2,5-4,5	$\approx 1,90$	2000	1600
3,0	10,0	4,6-6,5	$\approx 1,90$	2000	1600
3,0	12,0	6,5-8,5	$\approx 1,90$	2000	1600
3,2	6,0	1,5-2,5	$\approx 2,00$	2500	1800
3,2	8,0	2,5-4,5	$\approx 2,00$	2500	1800
3,2	10,0	4,5-6,5	$\approx 2,00$	2500	1800
3,2	12,0	6,5-8,5	$\approx 2,00$	2500	1800
4,0	6,0	$\approx 2,0$	$\approx 2,50$	3800	3100
4,0	8,0	2,0-4,0	$\approx 2,50$	3800	3100

$\varnothing d$	l		$\varnothing d_m$		
(mm)	(mm)	(mm)	(mm)	(N)	(N)
4,0	10,0	4,0-6,0	$\approx 2,50$	3800	3100
4,0	13,0	7,0-9,0	$\approx 2,50$	3800	3100
4,0	16,0	10,0-12,0	$\approx 2,50$	3800	3100
4,8	8,0	1,5-3,0	$\approx 2,90$	6000	4500
4,8	10,0	3,0-5,0	$\approx 2,90$	6000	4500
4,8	12,0	5,0-7,0	$\approx 2,90$	6000	4500
4,8	16,0	9,0-11,0	$\approx 2,90$	6000	4500
4,8	18,0	11,0-13,0	$\approx 2,90$	6000	4500
4,8	20,0	13,0-15,0	$\approx 2,90$	6000	4500

$d \times L$	☒	Kod artykułu	$d \times L$	☒	Kod artykułu	$d \times L$	☒	Kod artykułu
3,0X6MM	500	34186.030.006	3,2X12MM	500	34186.032.012	4,8X8MM	500	34186.048.008
3,0X8MM	500	34186.030.008	4,0X6MM	500	34186.040.006	4,8X10MM	500	34186.048.010
3,0X10MM	500	34186.030.010	4,0X8MM	500	34186.040.008	4,8X12MM	500	34186.048.012
3,2X6MM	500	34186.032.006	4,0X10MM	500	34186.040.010	4,8X16MM	500	34186.048.016
3,2X8MM	500	34186.032.008	4,0X13MM	500	34186.040.013	4,8X18MM	500	34186.048.018
3,2X10MM	500	34186.032.010	4,0X16MM	500	34186.040.016	4,8X20MM	500	34186.048.020

34150 OMNI Nity zrywalne T05A

Materiał Miedź





$\varnothing d$	l		$\varnothing d_m$		
(mm)	(mm)	(mm)	(mm)	(N)	(N)
3,0	6,0	1,0-3,0	$\approx 1,75$	700	600
3,0	8,0	3,0-5,0	$\approx 1,75$	700	600
3,0	10,0	5,0-7,0	$\approx 1,75$	700	600
3,0	12,0	7,0-9,0	$\approx 1,75$	700	600
4,0	6,0	1,0-2,5	$\approx 2,10$	1500	1000

$\varnothing d$	l		$\varnothing d_m$		
(mm)	(mm)	(mm)	(mm)	(N)	(N)
4,0	8,0	2,5-4,5	$\approx 2,10$	1500	1000
4,0	10,0	4,5-6,5	$\approx 2,10$	1500	1000
4,0	12,0	6,5-8,5	$\approx 2,10$	1500	1000
4,0	16,0	10,5-12,5	$\approx 2,10$	1500	1000

$d \times L$	☒	Kod artykułu	$d \times L$	☒	Kod artykułu	$d \times L$	☒	Kod artykułu
3,0X6MM	500	34150.030.006	4,0X10MM	500	34150.040.010			
3,0X8MM	500	34150.030.008	4,0X12MM	500	34150.040.012			
3,0X10MM	500	34150.030.010	4,0X16MM	500	34150.040.016			
3,0X12MM	500	34150.030.012						

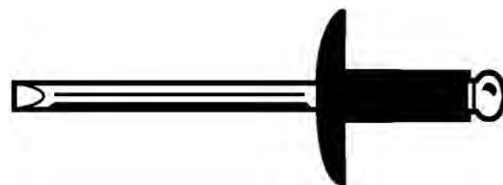
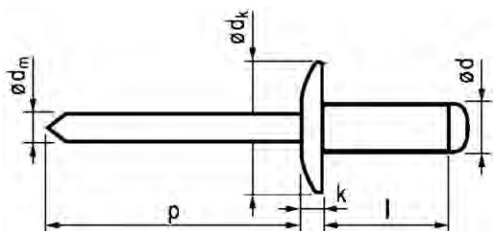
OMNI Nity zrywalne z kołnierzem powiększonym



Informacje techniczne

$\varnothing d$	k	p	Wiertło \varnothing	$\varnothing d_k$
3.2	≤ 2.0	≥ 27	3.3	9.5
4.0	≤ 2.0	≥ 27	4.1	12.0
4.8xk14	≤ 2.5	≥ 27	4.9	14.0
4.8xk16	≤ 2.5	≥ 27	4.9	16.0
5.0xk9.5	≤ 2.5	≥ 27	5.1	9.5
5.0xk11	≤ 2.5	≥ 27	5.1	11.0
5.0xk14	≤ 2.5	≥ 27	5.1	14.0
5.0xk16	1.1	≥ 27	5.1	16.0

Grupy katalogowe

Material	Kod	Strona
Al AIMg 3,5	34113	9-60
Al AIMg 2,5	34126	9-61

34113 OMNI Nity zrywalne z kołnierzem powiększonym

T05A

Material Aluminium AIMg 3,5







$\varnothing d$	l		$\varnothing d_m$		
(mm)	(mm)	(mm)	(mm)	(N)	(N)
3,2	6,0	1,5-3,5	$\approx 1,70$	980	760
3,2	8,0	3,5-5,5	$\approx 1,70$	980	760
3,2	10,0	5,5-7,5	$\approx 1,70$	980	760
3,2	12,0	7,5-9,5	$\approx 1,70$	980	760
4,0	6,0	1,5-3,0	$\approx 2,10$	1600	1200
4,0	8,0	3,0-5,0	$\approx 2,10$	1600	1200
4,0	10,0	5,0-6,5	$\approx 2,10$	1600	1200
4,0	12,0	6,5-8,5	$\approx 2,10$	1600	1200
4,0	14,0	8,5-10,5	$\approx 2,10$	1600	1200
4,0	16,0	10,5-12,5	$\approx 2,10$	1600	1200
4,8	8,0	3,0-4,5	$\approx 2,10$	2230	1690
4,8	10,0	4,5-6,0	$\approx 2,10$	2230	1690
4,8	12,0	6,0-8,0	$\approx 2,10$	2230	1690
4,8	16,0	10,0-12,0	$\approx 2,10$	2230	1690
4,8	18,0	12,0-14,0	$\approx 2,10$	2230	1690
4,8	20,0	14,0-16,0	$\approx 2,10$	2230	1690
5,0	8,0	2,0-5,0	$\approx 2,70$	2500	2000
5,0	10,0	4,0-6,5	$\approx 2,70$	2500	2000
5,0	12,0	6,0-8,0	$\approx 2,70$	2500	2000
5,0	14,0	7,0-10,0	$\approx 2,70$	2500	2000

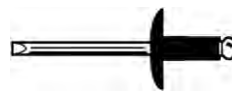

$\varnothing d$	l		$\varnothing d_m$		
(mm)	(mm)	(mm)	(mm)	(N)	(N)
5,0	16,0	8,0-12,0	$\approx 2,70$	2500	2000
5,0	18,0	11,5-13,5	$\approx 2,70$	2500	2000
5,0	20,0	12,0-15,5	$\approx 2,70$	2500	2000
5,0	25,0	15,0-20,5	$\approx 2,70$	2500	2000
5,0	30,0	20,0-25,0	$\approx 2,70$	2500	2000
5,0	8,0	3,0-4,5	$\approx 2,70$	2500	2000
5,0	10,0	4,5-6,0	$\approx 2,70$	2500	2000
5,0	12,0	6,0-8,0	$\approx 2,70$	2500	2000
5,0	14,0	8,0-10,0	$\approx 2,70$	2500	2000
5,0	16,0	10,0-12,0	$\approx 2,70$	2500	2000
5,0	18,0	12,0-14,0	$\approx 2,70$	2500	2000
5,0	21,0	14,0-17,0	$\approx 2,70$	2500	2000
5,0	25,0	17,0-20,0	$\approx 2,70$	2500	2000
5,0	30,0	23,0-26,0	$\approx 2,70$	2500	2000
5,0	10,0	2,0-6,5	$\approx 2,70$	2500	2000
5,0	16,0	6,0-12,0	$\approx 2,70$	2500	2000
5,0	20,0	11,5-15,5	$\approx 2,70$	2500	2000
5,0	25,0	15,0-20,5	$\approx 2,70$	2500	2000
5,0	33,0	20,0-28,0	$\approx 2,70$	2500	2000

d x L	☒	Kod artykułu	d x L	☒	Kod artykułu	d x L	☒	Kod artykułu
3,2X6MM D=9,5	500	34113.320.609	4,0X6MM D=12	500	34113.400.612	4,0X16MM D=12	500	34113.401.612
3,2X8MM D=9,5	500	34113.320.809	4,0X8MM D=12	500	34113.400.812			
3,2X10MM D=9,5	500	34113.321.009	4,0X10MM D=12	500	34113.401.012	4,8X10MM D=16	250	34113.481.016
3,2X12MM D=9,5	500	34113.321.209	4,0X12MM D=12	500	34113.401.212	4,8X12MM D=16	500	34113.481.216
			4,0X14MM D=12	100	34113.401.412	4,8X16MM D=16	250	34113.481.616
						4,8X18MM D=16	250	34113.481.816

34113 OMNI Nity zrywalne z kołnierzem powiększonym								
d x L	☒	Kod artykułu	d x L	☒	Kod artykułu	d x L	☒	Kod artykułu
4,8X20MM D=16	250	34113.482.016	5,0X12MM D=14	500	34113.501.214	5,0X20MM D=16	250	34113.502.016
5,0X8MM D=11	500	34113.500.811	5,0X14MM D=11	500	34113.501.411	5,0X21MM D=14	250	34113.502.114
5,0X8MM D=14	250	34113.500.814	5,0X14MM D=14	500	34113.501.414	5,0X24MM D=14	250	34113.502.414
5,0X10MM D=11	500	34113.501.011	5,0X16MM D=11	500	34113.501.611	5,0X25MM D=11	500	34113.502.511
5,0X10MM D=14	250	34113.501.014	5,0X16MM D=14	500	34113.501.614	5,0X25MM D=16	250	34113.502.516
5,0X10MM D=16	250	34113.501.016	5,0X16MM D=16	500	34113.501.616	5,0X30MM D=11	250	34113.503.011
5,0X12MM D=11	500	34113.501.211	5,0X18MM D=11	500	34113.501.811	5,0X30MM D=14	250	34113.503.014
			5,0X18MM D=14	500	34113.501.814	5,0X35MM D=16	250	34113.503.516
			5,0X20MM D=11	250	34113.502.011			

34126 MULTI Nity zrywalne z kołnierzem powiększonym		T05A
Materiał	Aluminium AlMg 2,5	
		 

∅ d	l		∅ d _m		
(mm)	(mm)	(mm)	(mm)	(N)	(N)
3,2	8,0	0,5-5,0	≈ 1,78	980	680
3,2	9,5	2,0-6,5	≈ 1,78	980	680
3,2	11,1	3,5-8,0	≈ 1,78	980	680
4,0	8,0	0,5-4,5	≈ 2,18	1600	1150
4,0	12,7	4,0-9,5	≈ 2,18	1600	1150

∅ d	l		∅ d _m		
(mm)	(mm)	(mm)	(mm)	(N)	(N)
4,0	17,0	8,5-13,5	≈ 2,18	1600	1150
4,8	10,0	0,5-5,0	≈ 2,78	2350	1500
4,8	14,0	4,0-9,0	≈ 2,78	2350	1500
4,8	16,0	6,0-11,0	≈ 2,78	2350	1500
4,8	20,0	10,0-15,0	≈ 2,78	2350	1500

d x L	☒	Kod artykułu	d x L	☒	Kod artykułu	d x L	☒	Kod artykułu
3,2X8MM D=9,5	500	34126.320.809	4,0X13MM D=12	500	34126.401.312	4,8X14MM D=14	250	34126.481.414
3,2X9MM D=9,5	500	34126.320.909	4,0X17MM D=12	500	34126.401.712	4,8X16MM D=14	250	34126.481.614
3,2X10MM D=9,5	500	34126.321.109	4,8X10MM D=14	250	34126.481.014	4,8X20MM D=14	250	34126.482.014
4,0X8MM D=12	500	34126.400.812						

OMNI Nity zrywalne z kołnierzem stożkowym

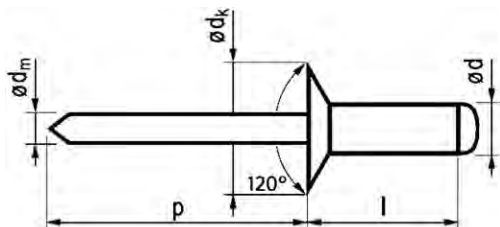

Informacje techniczne

$\varnothing d$	p	Wiertło \varnothing	$\varnothing d_k$
3.0	≥ 27	3.1	6.0
3.2	≥ 27	3.3	6.0
4.0	≥ 27	4.1	7.5
4.8	≥ 27	4.9	9.0
5.0	≥ 27	5.1	9.0

Grupy katalogowe

Materiał	Obróbka powierzchni	Kod	Strona	
Al AlMg 2,5/3,5		Al - St cynk.	34120	9-62
Al AlMg 3		Al - St.St. A2	34200	9-63
St	Ocynk.	St Ocynk - St Ocynk	34140	9-63
St.St. A2		St.St. A2 - St.St. A3	34184	9-64

34120 OMNI Nity zrywalne z kołnierzem stożkowym

T05A

Materiał Aluminium AlMg 2,5/3,5



$\varnothing d$	l		$\varnothing d_m$		
(mm)	(mm)	(mm)	(mm)	(N)	(N)
3,0	6,0	1,5-3,5	$\approx 1,75$	810	620
3,0	8,0	3,5-5,5	$\approx 1,75$	810	620
3,0	10,0	5,5-7,5	$\approx 1,75$	810	620
3,0	12,0	7,5-9,5	$\approx 1,75$	810	620
3,2	6,0	1,5-3,5	$\approx 1,75$	980	760
3,2	8,0	3,5-5,5	$\approx 1,75$	980	760
3,2	10,0	5,5-7,5	$\approx 1,75$	980	760
3,2	12,0	7,5-9,5	$\approx 1,75$	980	760
4,0	6,0	1,5-3,0	$\approx 2,10$	1600	1200
4,0	8,0	3,0-5,0	$\approx 2,10$	1600	1200
4,0	10,0	5,0-6,5	$\approx 2,10$	1600	1200
4,0	12,0	6,5-8,5	$\approx 2,10$	1600	1200
4,0	14,0	10,5-12,5	$\approx 2,10$	1600	1200
4,0	16,0	12,5-14,5	$\approx 2,10$	1600	1200
4,8	8,0	3,0-4,5	$\approx 2,70$	2230	1690

$\varnothing d$	l		$\varnothing d_m$		
(mm)	(mm)	(mm)	(mm)	(N)	(N)
4,8	10,0	4,5-6,0	$\approx 2,70$	2230	1690
4,8	12,0	6,0-8,0	$\approx 2,70$	2230	1690
4,8	14,0	8,0-10,0	$\approx 2,70$	2230	1690
4,8	16,0	10,0-12,0	$\approx 2,70$	2230	1690
4,8	18,0	12,0-14,0	$\approx 2,70$	2230	1690
4,8	20,0	14,0-16,0	$\approx 2,70$	2230	1690
4,8	25,0	18,0-21,0	$\approx 2,70$	2230	1690
5,0	8,0	3,0-4,5	$\approx 2,70$	2500	2000
5,0	10,0	4,5-6,0	$\approx 2,70$	2500	2000
5,0	12,0	6,0-8,0	$\approx 2,70$	2500	2000
5,0	14,0	8,0-10,0	$\approx 2,70$	2500	2000
5,0	16,0	10,0-12,0	$\approx 2,70$	2500	2000
5,0	18,0	12,0-14,0	$\approx 2,70$	2500	2000
5,0	21,0	14,0-17,0	$\approx 2,70$	2500	2000
5,0	25,0	17,0-20,0	$\approx 2,70$	2500	2000

$d \times L$	☒	Kod artykułu	$d \times L$	☒	Kod artykułu	$d \times L$	☒	Kod artykułu
3,0X6MM	500	34120.030.006	4,0X10MM	500	34120.040.010	4,8X20MM	250	34120.048.020
3,0X8MM	500	34120.030.008	4,0X12MM	500	34120.040.012	4,8X25MM	250	34120.048.025
3,0X10MM	500	34120.030.010	4,0X16MM	500	34120.040.016			
3,0X12MM	500	34120.030.012	4,0X18MM	500	34120.040.018	5,0X8MM	500	34120.050.008
						5,0X10MM	500	34120.050.010
3,2X6MM	500	34120.032.006	4,8X8MM	500	34120.048.008	5,0X12MM	500	34120.050.012
3,2X8MM	500	34120.032.008	4,8X10MM	500	34120.048.010	5,0X14MM	250	34120.050.014
3,2X10MM	500	34120.032.010	4,8X12MM	500	34120.048.012	5,0X16MM	500	34120.050.016
3,2X12MM	500	34120.032.012	4,8X14MM	500	34120.048.014	5,0X18MM	500	34120.050.018
			4,8X16MM	500	34120.048.016	5,0X20MM	250	34120.050.020
4,0X6MM	500	34120.040.006	4,8X18MM	500	34120.048.018	5,0X25MM	250	34120.050.025
4,0X8MM	500	34120.040.008						

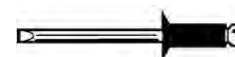
34200 OMNI Nity zrywalne z kołnierzem stożkowym
T05A
Materiał Aluminium AlMg 3

$\varnothing d$	l		$\varnothing d_m$		
(mm)	(mm)	(mm)	(mm)	(N)	(N)
3,0	6,0	1,5-3,5	≈ 1,75	870	680
3,0	8,0	3,5-5,0	≈ 1,75	870	680
3,0	10,0	5,0-7,0	≈ 1,75	870	680
4,0	6,0	1,0-2,5	≈ 2,10	1600	1200
4,0	8,0	2,5-5,0	≈ 2,10	1600	1200

$\varnothing d$	l		$\varnothing d_m$		
(mm)	(mm)	(mm)	(mm)	(N)	(N)
4,0	10,0	5,0-6,5	≈ 2,10	1600	1200
4,0	12,0	6,0-8,0	≈ 2,10	1600	1200
5,0	12,0	4,0-8,5	≈ 2,70	2500	2000
5,0	14,0	8,0-10,0	≈ 2,70	2500	2000
5,0	16,0	10,0-12,0	≈ 2,70	2500	2000

d x L	☒	Kod artykułu	d x L	☒	Kod artykułu	d x L	☒	Kod artykułu
3,0X6MM	500	34200.030.006	4,0X6MM	500	34200.040.006	4,0X12MM	500	34200.040.012
3,0X8MM	500	34200.030.008	4,0X8MM	500	34200.040.008	5,0X12MM	500	34200.050.012
3,0X10MM	500	34200.030.010	4,0X10MM	500	34200.040.010			

34140 OMNI Nity zrywalne z kołnierzem stożkowym
T05A
Materiał Stal
Obróbka powierzchni Ocynkowane

$\varnothing d$	l		$\varnothing d_m$		
(mm)	(mm)	(mm)	(mm)	(N)	(N)
3,0	6,0	1,5-3,0	≈ 1,90	1125	915
3,0	8,0	3,0-5,0	≈ 1,90	1125	915
3,0	10,0	5,0-7,0	≈ 1,90	1125	915
3,0	12,0	7,0-9,0	≈ 1,90	1125	915
3,2	6,0	1,5-3,0	≈ 2,00	1285	1060
3,2	8,0	3,0-5,0	≈ 2,00	1285	1060
4,0	6,0	1,5-2,5	≈ 2,50	1990	1550
4,0	8,0	2,5-4,5	≈ 2,50	1990	1550
4,0	10,0	4,5-6,5	≈ 2,50	1990	1550
4,0	12,0	6,5-8,5	≈ 2,50	1990	1550

$\varnothing d$	l		$\varnothing d_m$		
(mm)	(mm)	(mm)	(mm)	(N)	(N)
4,0	16,0	10,5-12,5	≈ 2,50	1990	1550
4,8	8,0	2,5-4,5	≈ 2,90	2920	2300
4,8	10,0	4,5-6,0	≈ 2,90	2920	2300
4,8	12,0	6,0-8,0	≈ 2,90	2920	2300
4,8	14,0	8,0-10,0	≈ 2,90	2920	2300
4,8	16,0	10,0-11,5	≈ 2,90	2920	2300
4,8	18,0	11,5-13,5	≈ 2,90	2920	2300
4,8	20,0	13,5-15,5	≈ 2,90	2920	2300
5,0	20,0	13,5-15,0	≈ 2,90	4000	3100
5,0	25,0	17,0-20,0	≈ 2,90	4000	3100

d x L	☒	Kod artykułu	d x L	☒	Kod artykułu	d x L	☒	Kod artykułu
3,0X6MM	500	34140.030.006	4,0X8MM	500	34140.040.008	4,8X14MM	500	34140.048.014
3,0X8MM	500	34140.030.008	4,0X10MM	500	34140.040.010	4,8X16MM	500	34140.048.016
3,0X10MM	500	34140.030.010	4,0X12MM	500	34140.040.012	4,8X18MM	500	34140.048.018
3,0X12MM	500	34140.030.012	4,0X14MM	500	34140.040.014	4,8X20MM	250	34140.048.020
			4,0X16MM	500	34140.040.016			
3,2X6MM	1000	34140.032.006				5,0X20MM	250	34140.050.020
3,2X8MM	500	34140.032.008	4,8X8MM	500	34140.048.008	5,0X25MM	250	34140.050.025
			4,8X10MM	500	34140.048.010			
4,0X6MM	500	34140.040.006	4,8X12MM	200	34140.048.012			

34184 OMNI Nity zrywalne z kołnierzem stożkowym
T05A
Materiał Stal nierdzewna A2

$\varnothing d$	l		$\varnothing d_m$		
(mm)	(mm)	(mm)	(mm)	(N)	(N)
4,0	8,0	2,0-4,0	≈ 2,50	3800	3100
4,0	10,0	4,0-6,0	≈ 2,50	3800	3100
4,0	12,0	6,0-8,0	≈ 2,50	3800	3100
4,0	15,0	9,0-11,0	≈ 2,50	3800	3100

$\varnothing d$	l		$\varnothing d_m$		
(mm)	(mm)	(mm)	(mm)	(N)	(N)
4,8	8,0	1,5-3,0	≈ 2,90	6000	4500
4,8	10,0	3,0-5,0	≈ 2,90	6000	4500
4,8	12,0	5,0-7,0	≈ 2,90	6000	4500
4,8	15,0	8,0-10,0	≈ 2,90	6000	4500

$d \times L$	☒	Kod artykułu	$d \times L$	☒	Kod artykułu	$d \times L$	☒	Kod artykułu
4,0X8MM	500	34184.040.008	4,0X15MM	500	34184.040.015	4,8X10MM	500	34184.048.010
4,0X10MM	500	34184.040.010				4,8X12MM	500	34184.048.012
4,0X12MM	500	34184.040.012	4,8X8MM	500	34184.048.008	4,8X15MM	500	34184.048.015

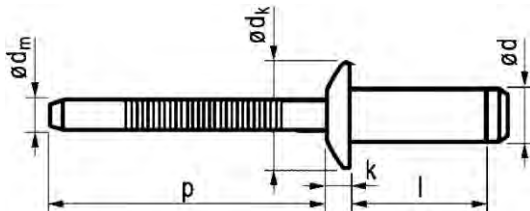
PLUS BULB Nity zrywalne o zwiększonej wytrzymałości

Informacje techniczne

$\varnothing d$	k	p	Wiertło \varnothing	$\varnothing d_k$
4.8	2.2	≥32	5.0	9.8
6.4	3.0	≥32	6.6	13.0

32635 PLUS BULB Nity zrywalne o zwiększonej wytrzymałości
T01A
Materiał Stal
Obróbka powierzchni Ocynkowane

$\varnothing d$	l		$\varnothing d_m$		
(mm)	(mm)	(mm)	(mm)	(N)	(N)
4,8	11,5	3,5-6,0	≈ 3,02	3600	3920/6270
4,8	14,0	6,0-8,5	≈ 3,02	3600	3920/6270
6,4	10,5	2,8-4,8	≈ 4,17	6600	5390/11180
6,4	12,5	4,8-6,8	≈ 4,17	6600	5390/11180

$\varnothing d$	l		$\varnothing d_m$		
(mm)	(mm)	(mm)	(mm)	(N)	(N)
6,4	14,5	6,8-8,8	≈ 4,17	6600	5390/11180
6,4	16,5	8,8-10,8	≈ 4,17	6600	5390/11180
6,4	18,5	10,8-12,8	≈ 4,17	6600	5390/11180
6,4	20,5	12,8-14,8	≈ 4,17	6600	5390/11180

$d \times L$	☒	Kod artykułu	$d \times L$	☒	Kod artykułu	$d \times L$	☒	Kod artykułu
4,8X11,5MM	500	32635.048.011	6,4X10,5MM	250	32635.064.010	6,4X16,5MM	200	32635.064.016
4,8X14MM	250	32635.048.014	6,4X12,5MM	250	32635.064.012	6,4X18,5MM	200	32635.064.018
			6,4X14,5MM	200	32635.064.014	6,4X20,5MM	200	32635.064.020

PLUS BULB Nity zrywalne strukturalne typu P-lock

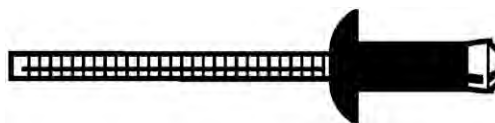
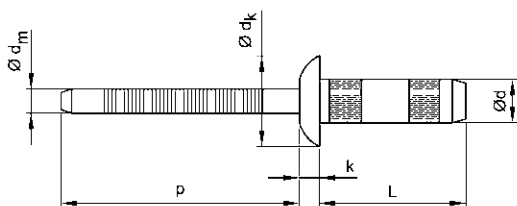

Informacje techniczne

Ø d	k (maks.)	p	Wiertło Ø	Ø d _k
3.2	1.4	>27	3.3	6.8
4.0	1.5	>27	4.1	8.0
4.8	1.5	>27	4.9	9.6

Grupy katalogowe

Material	Kod	Strona
St	34320	9-65
St.St.	34330	9-66

34320 PLUS BULB Nity zrywalne strukturalne typu P-lock

T05A

Material Stal



Ø d	l		Ø d _m		
(mm)	(mm)	(mm)	(mm)	(N)	(N)
3,2	6,6	1,0-3,0	≈ 2,00	1300	1200
3,2	9,2	3,0-5,0	≈ 2,00	1300	1700
3,2	11,5	5,0-7,0	≈ 2,00	1300	2500
4,0	7,5	1,0-3,0	≈ 2,60	2800	3500
4,0	9,5	3,0-5,0	≈ 2,60	2800	3500

Ø d	l		Ø d _m		
(mm)	(mm)	(mm)	(mm)	(N)	(N)
4,0	12,5	5,0-7,0	≈ 2,60	2800	3500
4,8	10,0	1,5-3,5	≈ 3,00	3800	4200
4,8	12,0	3,5-6,0	≈ 3,00	3800	4200
4,8	14,3	6,0-8,5	≈ 3,00	3800	4200

d x L	☒	Kod artykułu	d x L	☒	Kod artykułu	d x L	☒	Kod artykułu
3,2X7,0MM	500	34320.032.007	4,0X8,0MM	500	34320.040.008	4,8X9,0MM	500	34320.048.009
3,2X9,0MM	500	34320.032.009	4,0X10,0MM	500	34320.040.010	4,8X12,0MM	500	34320.048.012
3,2X11,0MM	500	34320.032.011	4,0X12,0MM	500	34320.040.012	4,8X14,0MM	500	34320.048.014

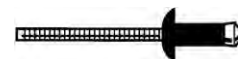
34330 PLUS BULB nity zrywalne
T05A
Materiał Stal nierdzewna A2

$\varnothing d$	l		$\varnothing d_m$		
(mm)	(mm)	(mm)	(mm)	(N)	(N)
3,2	6,6	1,0-3,0	$\approx 2,10$	2000	1600
3,2	9,2	3,5-5,0	$\approx 2,10$	2000	1700
3,2	11,5	5,0-7,0	$\approx 2,10$	2000	2500
4,0	7,5	1,0-3,0	$\approx 2,60$	4000	4200
4,0	9,5	3,0-5,0	$\approx 2,60$	4000	4200

$\varnothing d$	l		$\varnothing d_m$		
(mm)	(mm)	(mm)	(mm)	(N)	(N)
4,0	12,5	5,0-7,0	$\approx 2,60$	4000	4200
4,8	10,0	1,5-3,5	$\approx 3,20$	5000	5500
4,8	12,0	3,5-6,0	$\approx 3,20$	5000	5500
4,8	14,3	6,0-8,5	$\approx 3,20$	5000	5500

$d \times L$	☒	Kod artykułu	$d \times L$	☒	Kod artykułu	$d \times L$	☒	Kod artykułu
3,2X7,0MM	500	34330.032.007	4,0X8,0MM	500	34330.040.008	4,8X9,0MM	500	34330.048.009
3,2X9,0MM	500	34330.032.009	4,0X10,0MM	500	34330.040.010	4,8X12,0MM	500	34330.048.012
3,2X11,0MM	500	34330.032.011	4,0X12,0MM	500	34330.040.012	4,8X14,0MM	500	34330.048.014

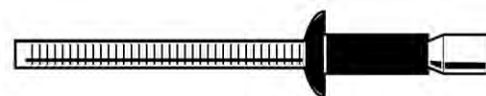
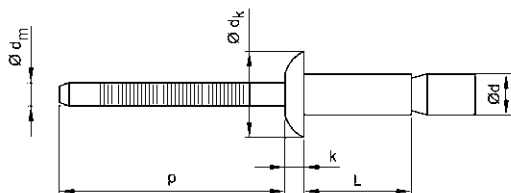
P-LOCK Nity zrywalne o zwiększonej wytrzymałości

Informacje techniczne

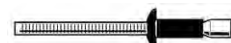
$\varnothing d$	k (maks.)	p	Wiertło \varnothing	$\varnothing d_k$
6,4	2,9	>27	6,6	12,7

34350 P-LOCK nity zrywalne
T05A
Materiał Stal

$\varnothing d$	l		$\varnothing d_m$		
(mm)	(mm)	(mm)	(mm)	(N)	(N)
6,4	14,0	2,0-9,5	$\approx 4,00$	10400	11700

$\varnothing d$	l		$\varnothing d_m$		
(mm)	(mm)	(mm)	(mm)	(N)	(N)
6,4	20,0	2,0-15,8	$\approx 4,00$	10400	11700

$d \times L$	☒	Kod artykułu	$d \times L$	☒	Kod artykułu
6,4X14MM	250	34350.064.014	6,4X20MM	250	34350.064.020

PLUS BULB Nity zrywalne, z kołnierzem stożkowym

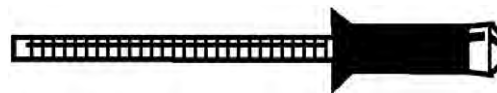
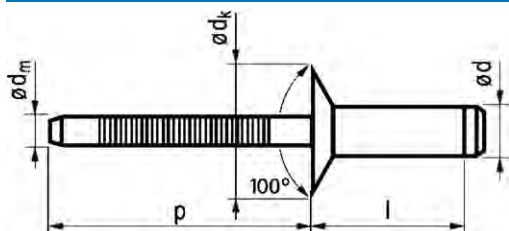

Informacje techniczne

$\varnothing d$	k	p	Wiertło \varnothing	$\varnothing d_k$
6.4	2.0	≥ 32	6.6	10.0

32642 PLUS BULB Nity zrywalne, z kołnierzem stożkowym o zwiększonej wytrzymałości

T05A

Materiał Stal
Obróbka powierzchni O cynkowane



$\varnothing d$	l		$\varnothing d_m$		
(mm)	(mm)	(mm)	(mm)	(N)	(N)
6,4	13,5	5,8-7,8	$\approx 4,17$	5490	5390/10300
6,4	15,5	7,8-9,8	$\approx 4,17$	5490	5390/10300

$\varnothing d$	l		$\varnothing d_m$		
(mm)	(mm)	(mm)	(mm)	(N)	(N)
6,4	17,5	9,8-11,8	$\approx 4,17$	5490	5390/10300
6,4	19,5	11,8-13,8	$\approx 4,17$	5490	5390/10300

d x L	☒	Kod artykułu	d x L	☒	Kod artykułu	d x L	☒	Kod artykułu
6,4X13,5MM	250	32642.064.013	6,4X17,5MM	250	32642.064.017	6,4X19,5MM	250	32642.064.019
6,4X15,5MM	250	32642.064.015						

Nity zrywalne, rozprężne z żółtą zaślepką

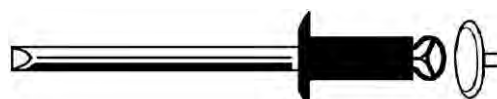

Informacje techniczne

d	\varnothing lba nitu
4.8	9.5

72004 Nity zrywalne aluminium z żółtą zaślepką

Y92D

Materiał Aluminium



d x L	☒	Kod artykułu
4,8X15,5MM	100	72004.048.015

MULTI Nity zrywalne szerokozakresowe typ A

DIN ≈7337 A

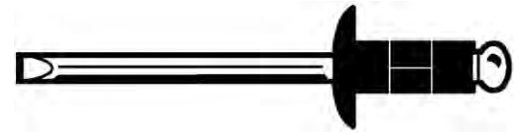

Informacje techniczne

ø d	k (maks.)	p	Wiertło ø	ø d _k
3.2	1.02	>27	3.3	6.4
4.0	1.27	>27	4.1	7.9
4.8	1.52	>27	4.9	9.5

33900 MULTI Nity zrywalne szerokozakresowe typ A

T05A

Materiał Stal

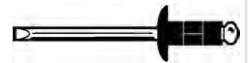

ø d	l		ø d _m		
(mm)	(mm)	(mm)	(mm)	(N)	(N)
3,2	11,4	1,6-6,4	≈ 2,05	1400	1100
4,0	12,0	1,6-6,4	≈ 2,65	2100	1800
4,0	13,6	3,2-8,0	≈ 2,65	2100	1800

ø d	l		ø d _m		
(mm)	(mm)	(mm)	(mm)	(N)	(N)
4,8	12,7	1,6-6,4	≈ 3,00	3100	2600
4,8	14,3	3,2-8,0	≈ 3,00	3100	2600
4,8	19,3	8,0-12,7	≈ 3,00	3100	2600

d x L	☒	Kod artykułu	d x L	☒	Kod artykułu	d x L	☒	Kod artykułu
3,2X11MM	500	33900.032.011	4,0X13MM	500	33900.040.013	4,8X14MM	500	33900.048.014
4,0X12,5MM	500	33900.040.012	4,8X12,7MM	500	33900.048.012	4,8X19MM	500	33900.048.019

MULTI nity zrywalne szerokozakresowe typ B



Informacje techniczne

ø d	k (maks.)	p	Wiertło ø	ø d _k
3.2	1.02	>27	3.3	6.4
4.0	1.27	>27	4.1	7.9
4.8	1.52	>27	4.9	9.5

34185 Nity zrywalne MULTI

T05A

Materiał Stal nierdzewna A2

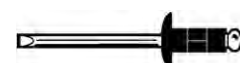

ø d	l		ø d _m		
(mm)	(mm)	(mm)	(mm)	(N)	(N)
3,2	9,9	1,0-4,8	≈ 2,20	2000	1700
4,0	12,0	1,6-6,4	≈ 2,70	3200	2900
4,0	13,6	3,2-8,0	≈ 2,70	3200	2900
4,0	16,8	6,4-11,2	≈ 2,70	3200	2900

ø d	l		ø d _m		
(mm)	(mm)	(mm)	(mm)	(N)	(N)
4,8	12,7	1,6-6,4	≈ 3,10	4800	4100
4,8	14,3	3,2-8,0	≈ 3,10	4800	4100
4,8	17,5	6,5-10,0	≈ 3,10	4800	4100
4,8	19,3	8,0-12,5	≈ 3,10	4800	4100

d x L	☒	Kod artykułu	d x L	☒	Kod artykułu	d x L	☒	Kod artykułu
3,2X10MM	500	34185.032.010	4,0X16MM	500	34185.040.016	4,8X14MM	500	34185.048.014
4,0X12MM	500	34185.040.012	4,8X12,7MM	500	34185.048.012	4,8X17,5MM	500	34185.048.017
4,0X13MM	500	34185.040.013				4,8X19MM	500	34185.048.019

MULTI Nity zrywalne o szerokim zakresie

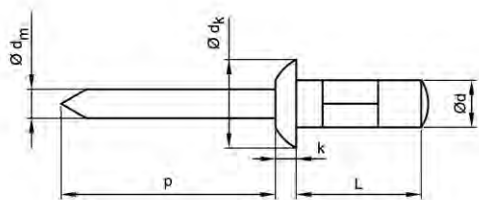

Informacje techniczne

$\varnothing d$	k	p	Wiertło \varnothing	$\varnothing d_k$
3.2	≤ 1.4	≥ 27	3.3	6.0
4.0	≤ 1.7	≥ 27	4.1	8.0
4.8	≤ 2.0	≥ 27	4.9	9.5

Grupy katalogowe

Material		Kod	Strona
Al AlMg 2,5	Al - St cynk.	34125	9-70
Al AlMg 5	Al-St.St. A2	34205	9-71

34125 MULTI Nity zrywalne o szerokim zakresie

T05A

Material Aluminium AlMg 2,5







$\varnothing d$	l		$\varnothing d_m$		
(mm)	(mm)	(mm)	(mm)	(N)	(N)
3,2	8,0	0,5-5,0	$\approx 1,78$	980	680
3,2	9,5	2,0-6,5	$\approx 1,78$	980	680
3,2	11,1	3,5-8,0	$\approx 1,78$	980	680
4,0	9,5	1,0-6,0	$\approx 2,18$	1600	1150
4,0	12,7	4,0-9,5	$\approx 2,18$	1600	1150

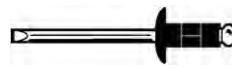

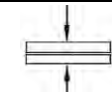
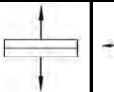



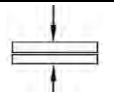
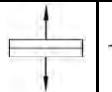





$\varnothing d$	l		$\varnothing d_m$		
(mm)	(mm)	(mm)	(mm)	(N)	(N)
4,0	17,0	8,5-13,5	$\approx 2,18$	1600	1150
4,8	10,3	0,5-5,5	$\approx 2,78$	2350	1500
4,8	15,1	5,0-10,5	$\approx 2,78$	2350	1500
4,8	17,0	7,0-12,0	$\approx 2,78$	2350	1500
4,8	24,8	14,5-19,5	$\approx 2,78$	2350	1500

d x L	☒	Kod artykułu	d x L	☒	Kod artykułu	d x L	☒	Kod artykułu
3,2X8MM	500	34125.032.008	4,0X9,5MM	500	34125.040.009	4,8X10,3MM	500	34125.048.011
3,2X9,5MM	500	34125.032.009	4,0X12,7MM	500	34125.040.013	4,8X15,1MM	250	34125.048.015
3,2X11,1MM	500	34125.032.011	4,0X17MM	500	34125.040.017	4,8X17MM	500	34125.048.017
						4,8X24,8MM	500	34125.048.025

34205	MULTI Nity zrywalne o szerokim zakresie	T05A
Materiał	Aluminium AlMg 5	

$\varnothing d$	l		$\varnothing d_m$		
(mm)	(mm)	(mm)	(mm)	(N)	(N)
3,2	8,0	0,5-5,0	$\approx 1,78$	980	680
3,2	9,5	2,0-6,5	$\approx 1,78$	980	680
3,2	11,1	3,5-8,0	$\approx 1,78$	980	680
4,0	9,5	1,0-6,0	$\approx 2,18$	1600	1150
4,0	12,7	4,0-9,5	$\approx 2,18$	1600	1150

$\varnothing d$	l		$\varnothing d_m$		
(mm)	(mm)	(mm)	(mm)	(N)	(N)
4,0	17,0	8,5-13,5	$\approx 2,18$	1600	1150
4,8	10,3	0,5-5,5	$\approx 2,78$	2350	1500
4,8	15,1	5,0-10,5	$\approx 2,78$	2350	1500
4,8	17,0	7,0-12,0	$\approx 2,78$	2350	1500
4,8	24,8	14,5-19,5	$\approx 2,78$	2350	1500

$d \times L$		Kod artykułu	$d \times L$		Kod artykułu	$d \times L$		Kod artykułu
3,2X8,0MM		500 34205.032.008	4,0X9,5MM		500 34205.040.009	4,8X10,3MM		500 34205.048.010
3,2X9,5MM		500 34205.032.009	4,0X12,7MM		500 34205.040.012	4,8X15,1MM		500 34205.048.015
3,2X11,1MM		500 34205.032.011	4,0X16,9MM		500 34205.040.016	4,8X16,9MM		500 34205.048.016
						4,8X24,8MM		250 34205.048.024

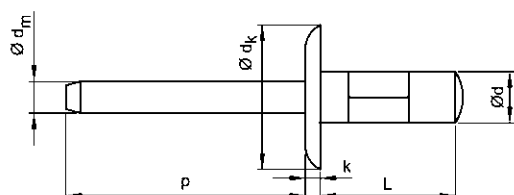

MULTI Nity zrywalne z łbem powiększonym szerokozakresowe







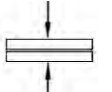
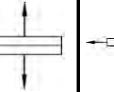



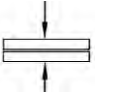
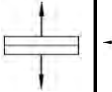







Informacje techniczne

$\varnothing d$	k (maks.)	p	Wiertło \varnothing	$\varnothing d_k$
4.8	2.5	>27	4.9	16.0

34250	MULTI Nity zrywalne z łbem powiększonym szerokozakresowe	T05A
Materiał	Aluminium AlMg 3	

$\varnothing d$	l		$\varnothing d_m$		
(mm)	(mm)	(mm)	(mm)	(N)	(N)
4,8	10,0	0,5-5,0	$\approx 2,78$	2350	1500
4,8	10,3	0,5-5,5	$\approx 2,78$	2350	1500
4,8	12,0	2,0-7,0	$\approx 2,78$	2350	1500
4,8	14,0	4,0-9,0	$\approx 2,78$	2350	1500
4,8	16,0	6,0-11,0	$\approx 2,78$	2350	1500
4,8	17,0	7,0-12,0	$\approx 2,78$	2350	1500

$\varnothing d$	l		$\varnothing d_m$		
(mm)	(mm)	(mm)	(mm)	(N)	(N)
4,8	18,0	8,0-13,0	$\approx 2,78$	2350	1500
4,8	20,0	10,0-15,0	$\approx 2,78$	2350	1500
4,8	22,0	12,0-17,0	$\approx 2,78$	2350	1500
4,8	24,0	14,0-19,0	$\approx 2,78$	2350	1500
4,8	24,8	14,5-19,5	$\approx 2,78$	2350	1500
4,8	27,0	16,0-22,0	$\approx 2,78$	2350	1500

$d \times L$		Kod artykułu	$d \times L$		Kod artykułu	$d \times L$		Kod artykułu
4,8X10X16MM		250 34250.048.010	4,8X16X16MM		250 34250.048.016	4,8X22X16MM		250 34250.048.022
4,8X10,3X16MM		250 34250.048.011	4,8X17X16MM		250 34250.048.017	4,8X24X16MM		250 34250.048.024
4,8X12X16MM		250 34250.048.012	4,8X18X16MM		250 34250.048.018	4,8X24,8X16MM		250 34250.048.025
4,8X14X16MM		250 34250.048.014	4,8X20X16MM		250 34250.048.020	4,8X27X16MM		250 34250.048.027

MULTI Nity zrywalne z kołnierzem stożkowym o szerokim zakresie

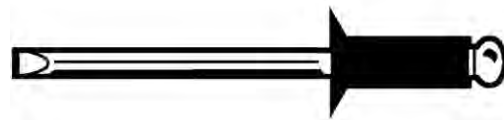

Informacje techniczne

ø d	p	Wiertło ø	ø d _k
3.2	>27	3.3	6.0
4.0	>27	4.1	8.0
4.8	>27	4.9	9.5

34128 MULTI Nity zrywalne z kołnierzem stożkowym o szerokim zakresie

T05A

Materiał Aluminium AlMg 5



ø d	l		ø d _m		
(mm)	(mm)	(mm)	(mm)	(N)	(N)
3,2	8,0	1,5-5,0	≈ 1,78	980	680
3,2	9,7	2,5-6,5	≈ 1,78	980	680
3,2	10,0	2,5-7,0	≈ 1,78	980	680
3,2	12,0	4,5-9,0	≈ 1,78	980	680
4,0	8,0	1,5-4,5	≈ 2,18	1600	1150
4,0	10,0	1,5-6,5	≈ 2,18	1600	1150
4,0	11,3	2,5-7,5	≈ 2,18	1600	1150

ø d	l		ø d _m		
(mm)	(mm)	(mm)	(mm)	(N)	(N)
4,0	12,0	3,5-8,5	≈ 2,18	1600	1150
4,0	14,0	5,5-10,5	≈ 2,18	1600	1150
4,8	10,0	1,5-5,0	≈ 2,78	2350	1500
4,8	12,0	2,0-7,0	≈ 2,78	2350	1500
4,8	14,0	4,0-9,0	≈ 2,78	2350	1500
4,8	16,0	6,0-11,0	≈ 2,78	2350	1500
4,8	16,9	7,0-12,0	≈ 2,78	2350	1500

d x L	☒	Kod artykułu	d x L	☒	Kod artykułu	d x L	☒	Kod artykułu
3,2X8MM	500	34128.032.008	4,0X10MM	500	34128.040.010	4,8X12MM	500	34128.048.012
3,2X9,7MM	500	34128.032.009	4,0X11,3MM	500	34128.040.011	4,8X14MM	500	34128.048.014
3,2X10MM	500	34128.032.010	4,0X12MM	500	34128.040.012	4,8X16MM	500	34128.048.016
3,2X12MM	500	34128.032.012	4,0X14MM	500	34128.040.014	4,8X16,9MM	500	34128.048.017
4,0X8MM	500	34128.040.008	4,8X10MM	500	34128.048.010			

SIGMA Nity zrywalne, szczelne

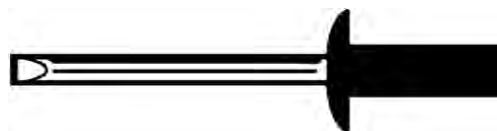
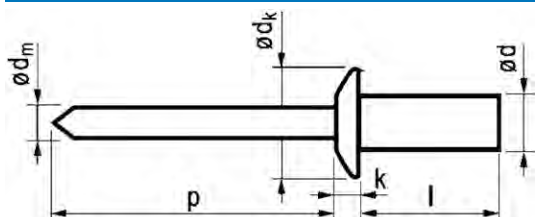

Informacje techniczne

$\varnothing d$	k	p	Wiertło \varnothing	$\varnothing d_k$
3.2	≤ 1.4	≥ 27	3.3	6.0
4.0xk 1.4	1.4	≥ 27	4.1	8.0
4.0xk ≤ 1.7	≤ 1.7	≥ 27	4.1	8.0
4.8xk 1.7	1.7	≥ 27	4.9	9.5
4.8xk ≤ 2.0	≤ 2.0	≥ 27	4.9	9.5
6.4	≤ 2.5	≥ 27	6.5	12.7

Grupy katalogowe

Material	Obróbka powierzchni	Kod	Strona	
Al AlMg 5		Al - St	33610	9-73
Al AlMg 5		Al - St.St. A2	33650	9-74
Al Al 99,5		Al - Al	33600	9-74
St	Ocynk.	St zipl-St zipl	33695	9-75
St.St. A2		St.St. A2 - St.St. A2	33670	9-75

33610 SIGMA Nity zrywalne, szczelne

T03A

Material Aluminium AlMg 5



$\varnothing d$	l		$\varnothing d_m$		
(mm)	(mm)	(mm)	(mm)	(N)	(N)
3,2	6,5	0,5-2,0	$\approx 1,70$	1250	1070
3,2	8,0	2,0-3,5	$\approx 1,70$	1250	1070
3,2	9,5	3,5-5,0	$\approx 1,70$	1250	1070
3,2	10,7	5,0-6,5	$\approx 1,70$	1250	1070
3,2	12,7	6,5-8,0	$\approx 1,70$	1250	1070
4,0	8,0	0,5-3,5	$\approx 2,18$	2240	1700
4,0	9,5	3,5-4,5	$\approx 2,18$	2240	1700
4,0	11,0	4,5-6,0	$\approx 2,18$	2240	1700
4,0	12,7	6,0-7,5	$\approx 2,18$	2240	1700
4,8	8,0	1,0=3,0	$\approx 2,63$	3100	2200

$\varnothing d$	l		$\varnothing d_m$		
(mm)	(mm)	(mm)	(mm)	(N)	(N)
4,8	9,5	3,0-4,5	$\approx 2,63$	3100	2200
4,8	11,0	4,5-6,0	$\approx 2,63$	3100	2200
4,8	12,5	6,0-7,5	$\approx 2,63$	3100	2200
4,8	14,0	7,5-9,0	$\approx 2,63$	3100	2200
4,8	16,0	9,0-11,0	$\approx 2,63$	3100	2200
4,8	18,0	11,0-13,0	$\approx 2,63$	3100	2200
4,8	21,0	13,0-16,0	$\approx 2,63$	3100	2200
6,4	12,5	1,5,6,0	$\approx 3,70$	4900	3950
6,4	16,0	6,0-8,0	$\approx 3,70$	4900	3950

d x L	☒	Kod artykułu	d x L	☒	Kod artykułu	d x L	☒	Kod artykułu
3,2X6,5MM	500	33610.032.006	4,0X11MM	500	33610.040.011	4,8X14MM	500	33610.048.014
3,2X8MM	500	33610.032.008	4,0X12,5MM	500	33610.040.012	4,8X16MM	500	33610.048.016
3,2X9,5MM	500	33610.032.009				4,8X18MM	500	33610.048.018
3,2X10MM	500	33610.032.010	4,8X8MM	500	33610.048.008	4,8X21MM	500	33610.048.021
3,2X12,5MM	500	33610.032.012	4,8X9,5MM	500	33610.048.009			
			4,8X11MM	500	33610.048.011	6,4X12,5MM	250	33610.064.012
4,0X8MM	500	33610.040.008	4,8X12MM	500	33610.048.012	6,4X16MM	250	33610.064.016
4,0X9,5MM	500	33610.040.009						

33650 SIGMA Nity zrywalne, szczelne
T03A
Materiał Aluminium AlMg 5

$\varnothing d$	l		$\varnothing d_m$		
(mm)	(mm)	(mm)	(mm)	(N)	(N)
3,2	6,5	0,5-2,0	≈ 1,70	1250	1070
3,2	8,0	2,0-3,5	≈ 1,70	1250	1070
3,2	9,5	3,5-5,0	≈ 1,70	1250	1070
3,2	11,0	5,0-6,5	≈ 1,70	1250	1070
3,2	12,7	6,5-8,0	≈ 1,70	1250	1070
4,0	8,0	0,5-3,5	≈ 2,18	2240	1700
4,0	9,5	3,5-4,5	≈ 2,18	2240	1700
4,0	11,0	4,5-6,5	≈ 2,18	2240	1700
4,0	12,7	6,5-8,0	≈ 2,18	2240	1700

$\varnothing d$	l		$\varnothing d_m$		
(mm)	(mm)	(mm)	(mm)	(N)	(N)
4,8	8,0	1,0-3,0	≈ 2,63	3100	2200
4,8	9,5	3,0-4,5	≈ 2,63	3100	2200
4,8	11,0	4,5-6,0	≈ 2,63	3100	2200
4,8	12,5	6,0-7,5	≈ 2,63	3100	2200
4,8	14,0	7,5-9,0	≈ 2,63	3100	2200
4,8	16,0	9,0-11,0	≈ 2,63	3100	2200
4,8	18,0	11,0-13,0	≈ 2,63	3100	2200
4,8	21,0	13,0-16,0	≈ 2,63	3100	2200

d x L	⊠	Kod artykułu	d x L	⊠	Kod artykułu	d x L	⊠	Kod artykułu
3,2X6,5MM	1000	33650.032.006	4,0X9,5MM	500	33650.040.009	4,8X11MM	500	33650.048.011
3,2X8MM	500	33650.032.008	4,0X11MM	500	33650.040.011	4,8X12,5MM	500	33650.048.012
3,2X9,5MM	500	33650.032.009	4,0X12,5MM	500	33650.040.012	4,8X14MM	250	33650.048.014
3,2X11MM	500	33650.032.011	4,8X8MM	500	33650.048.008	4,8X16MM	500	33650.048.016
3,2X12,5MM	500	33650.032.012	4,8X9,5MM	500	33650.048.009	4,8X18MM	500	33650.048.018
4,0X8MM	500	33650.040.008				4,8X21MM	500	33650.048.021

33600 SIGMA Nity zrywalne, szczelne
T03A
Materiał Aluminium Al 99,5



$\varnothing d$	l		$\varnothing d_m$		
(mm)	(mm)	(mm)	(mm)	(N)	(N)
3,2	8,0	0,5-3,5	≈ 1,80	460	450
3,2	9,5	3,5-5,5	≈ 1,80	460	450
4,0	9,5	0,5-5,0	≈ 2,20	820	580
4,0	12,5	5,0-8,0	≈ 2,20	820	580



$\varnothing d$	l		$\varnothing d_m$		
(mm)	(mm)	(mm)	(mm)	(N)	(N)
4,8	9,5	1,0-4,5	≈ 2,65	1120	900
4,8	11,5	4,5-6,5	≈ 2,65	1120	900
4,8	14,5	6,5-9,5	≈ 2,65	1120	900
4,8	18,0	9,5-13,0	≈ 2,65	1120	900



d x L	⊠	Kod artykułu	d x L	⊠	Kod artykułu	d x L	⊠	Kod artykułu
3,2X8MM	500	33600.032.008	4,0X12,5MM	500	33600.040.012	4,8X11,5MM	500	33600.048.011
3,2X9,5MM	500	33600.032.009	4,8X9,5MM	500	33600.048.009	4,8X14,5MM	250	33600.048.014
4,0X9,5MM	500	33600.040.009				4,8X18MM	500	33600.048.018

33695 SIGMA Nity zrywalne, szczelne T03A

Materiał Stal
Obróbka powierzchni Ocynkowane

$\varnothing d$	l		$\varnothing d_m$		
(mm)	(mm)	(mm)	(mm)	(N)	(N)
4,0	6,0	0,5-1,5	≈ 2,30	2500	2300
4,0	8,0	1,5-3,0	≈ 2,30	2500	2300
4,0	12,0	5,0-6,5	≈ 2,30	2500	2300
4,0	15,0	6,5-10,5	≈ 2,30	2500	2300

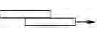

$\varnothing d$	l		$\varnothing d_m$		
(mm)	(mm)	(mm)	(mm)	(N)	(N)
4,8	8,0	1,0-3,0	≈ 2,90	3800	2900
4,8	12,0	5,0-6,5	≈ 2,90	3800	2900
4,8	16,0	6,5-10,5	≈ 2,90	3800	2900



d x L	☒	Kod artykułu	d x L	☒	Kod artykułu	d x L	☒	Kod artykułu
4,0X6MM	500	33695.040.006	4,0X15MM	500	33695.040.015	4,8X12MM	500	33695.048.012
4,0X8MM	500	33695.040.008	4,8X8MM	500	33695.048.008	4,8X16MM	500	33695.048.016
4,0X12MM	500	33695.040.012						

33670 SIGMA Nity zrywalne, szczelne T03A

Materiał Stal nierdzewna A2





$\varnothing d$	l		$\varnothing d_m$		
(mm)	(mm)	(mm)	(mm)	(N)	(N)
3,2	6,0	0,5-1,5	≈ 1,90	2500	2000
3,2	8,0	1,5-3,0	≈ 1,90	2500	2000
3,2	9,5	3,0-5,0	≈ 1,90	2500	2000
3,2	12,0	5,0-7,0	≈ 1,90	2500	2000
4,0	6,0	0,5-1,5	≈ 2,30	4000	3000
4,0	8,0	1,5-3,0	≈ 2,30	4000	3000
4,0	9,5	3,0-5,0	≈ 2,30	4000	3000

$\varnothing d$	l		$\varnothing d_m$		
(mm)	(mm)	(mm)	(mm)	(N)	(N)
4,0	12,0	5,0-6,5	≈ 2,30	4000	3000
4,0	16,0	6,5-10,5	≈ 2,30	4000	3000
4,8	8,0	1,0-3,0	≈ 2,90	5500	4500
4,8	9,5	3,0-5,0	≈ 2,90	5500	4500
4,8	12,0	5,0-6,5	≈ 2,90	5500	4500
4,8	16,0	6,5-10,5	≈ 2,90	5500	4500

d x L	☒	Kod artykułu	d x L	☒	Kod artykułu	d x L	☒	Kod artykułu
3,2X6MM	500	33670.032.006	4,0X6MM	500	33670.040.006	4,8X8MM	500	33670.048.008
3,2X8MM	500	33670.032.008	4,0X8MM	500	33670.040.008	4,8X9MM	500	33670.048.009
3,2X9MM	500	33670.032.009	4,0X9MM	500	33670.040.009	4,8X12MM	500	33670.048.012
3,2X12MM	500	33670.032.012	4,0X12MM	500	33670.040.012	4,8X16MM	500	33670.048.016
			4,0X16MM	500	33670.040.016			

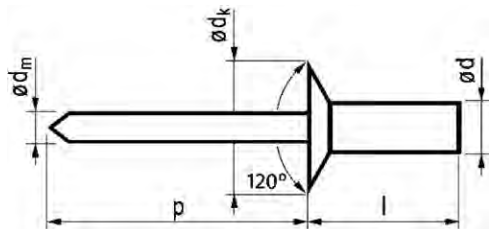
SIGMA Nity zrywalne, szczelne z kołnierzem stożkowym



Informacje techniczne

$\varnothing d$	p	Wiertło \varnothing	$\varnothing d_k$
3.2	≥ 27	3.3	6.0
4.0	≥ 27	4.1	7.5
4.8	≥ 27	4.9	9.0

33620 SIGMA Nity zrywalne, szczelne z kołnierzem stożkowym

T03A

Materiał Aluminium AlMg 5

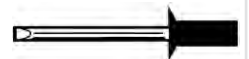

$\varnothing d$	l		$\varnothing d_m$		
(mm)	(mm)	(mm)	(mm)	(N)	(N)
3,2	7,5	1,5-3,5	$\approx 1,70$	1245	1070
3,2	9,0	3,0-5,0	$\approx 1,70$	1245	1070
3,2	10,5	4,5-6,5	$\approx 1,70$	1245	1070
3,2	12,0	6,0-7,5	$\approx 1,70$	1245	1070
4,0	9,5	3,0-5,0	$\approx 2,20$	2240	1710
4,0	11,0	4,5-6,5	$\approx 2,20$	2240	1710
4,0	12,5	6,0-8,0	$\approx 2,20$	2240	1710

$\varnothing d$	l		$\varnothing d_m$		
(mm)	(mm)	(mm)	(mm)	(N)	(N)
4,8	9,5	2,5-4,5	$\approx 2,65$	3070	2230
4,8	11,0	4,0-6,0	$\approx 2,65$	3070	2230
4,8	12,5	5,5-7,5	$\approx 2,65$	3070	2230
4,8	14,0	7,0-9,0	$\approx 2,65$	3070	2230
4,8	15,5	8,5-10,5	$\approx 2,65$	3070	2230
4,8	19,0	12,0-14,0	$\approx 2,65$	3070	2230

$d \times L$	☒	Kod artykułu	$d \times L$	☒	Kod artykułu	$d \times L$	☒	Kod artykułu
3,2X7,5MM	500	33620.032.007	4,0X9,5MM	500	33620.040.009	4,8X11MM	500	33620.048.011
3,2X9,5MM	500	33620.032.009	4,0X11MM	500	33620.040.011	4,8X12,5MM	500	33620.048.012
3,2X10,5MM	500	33620.032.010	4,0X12,5MM	500	33620.040.012	4,8X14MM	500	33620.048.014
3,2X12MM	500	33620.032.012	4,8X9,5MM	250	33620.048.009	4,8X15,5MM	500	33620.048.015
						4,8X19,5MM	250	33620.048.019

EXPO Nity zrywalne, rozprężne

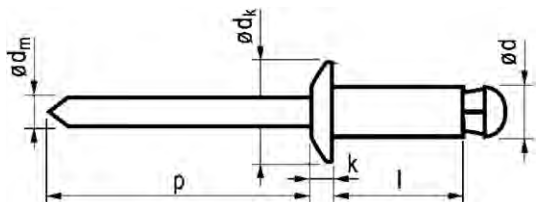

Informacje techniczne

$\varnothing d$	k	p	Wiertło \varnothing	$\varnothing d_k$
3.2	1	≥ 27	3.7	6.5
4.0	1.2	≥ 27	4.5	8.0
4.8	1.4	≥ 27	5.3	9.0

33410 EXPO Nity zrywalne, rozprężne

T03A

Materiał Aluminium AlMg 3,5

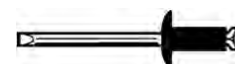

$\varnothing d$	l		$\varnothing d_m$		
(mm)	(mm)	(mm)	(mm)	(N)	(N)
3,2	10,0	1,0-3,0	$\approx 1,80$	750	820
3,2	16,0	7,0-9,0	$\approx 1,80$	750	820
3,2	18,0	9,0-11,0	$\approx 1,80$	750	820
4,0	10,0	1,5-5,0	$\approx 2,10$	1140	1280
4,0	16,0	8,0-11,0	$\approx 2,10$	1140	1280
4,0	18,0	10,0-13,0	$\approx 2,10$	1140	1280
4,8	10,0	1,5-4,0	$\approx 2,70$	2450	2100

$\varnothing d$	l		$\varnothing d_m$		
(mm)	(mm)	(mm)	(mm)	(N)	(N)
4,8	14,0	4,0-8,0	$\approx 2,70$	2450	2100
4,8	18,0	8,0-12,0	$\approx 2,70$	2450	2100
4,8	22,0	12,0-16,0	$\approx 2,70$	2450	2100
4,8	25,0	16,0-19,0	$\approx 2,70$	2450	2100
4,8	30,0	19,0-24,0	$\approx 2,70$	2450	2100
4,8	35,0	24,0-29,0	$\approx 2,70$	2450	2100

d x L	☒	Kod artykułu	d x L	☒	Kod artykułu	d x L	☒	Kod artykułu
3,2X10MM	500	33410.032.010	4,0X16MM	500	33410.040.016	4,8X18MM	500	33410.048.018
3,2X16MM	500	33410.032.016	4,0X18MM	500	33410.040.018	4,8X22MM	500	33410.048.022
3,2X18MM	500	33410.032.018	4,8X10MM	500	33410.048.010	4,8X25MM	250	33410.048.025
4,0X10MM	500	33410.040.010	4,8X14MM	500	33410.048.014	4,8X30MM	250	33410.048.030
						4,8X35MM	250	33410.048.035

TRIPO Nity zrywalne, rozprężne, odsadzone

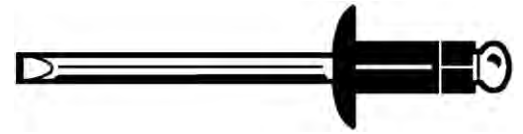
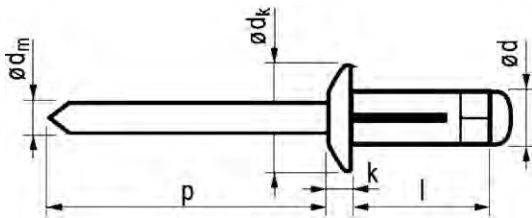

Informacje techniczne

$\varnothing d$	k	p	Wiertło \varnothing	$\varnothing d_k$
4.0	≤ 1.7	≥ 27	4.2	8.0
4.8	≤ 2.0	≥ 27	5.0	9.6

34121 TRIPO Nity zrywalne, rozprężne, odsadzone

T05A

Materiał Aluminium AlMg 3

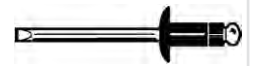

$\varnothing d$	l		$\varnothing d_m$		
(mm)	(mm)	(mm)	(mm)	(N)	(N)
4,0	13,6	1,0-3,0	$\approx 2,50$	800	500
4,0	18,8	3,0-7,0	$\approx 2,50$	800	500
4,8	15,3	1,0-3,0	$\approx 2,90$	1100	800

$\varnothing d$	l		$\varnothing d_m$		
(mm)	(mm)	(mm)	(mm)	(N)	(N)
4,8	20,5	3,0-9,0	$\approx 2,90$	1100	800
4,8	24,5	5,0-12,0	$\approx 2,90$	1100	800

d x L	☒	Kod artykułu	d x L	☒	Kod artykułu	d x L	☒	Kod artykułu
4,0X13MM	500	34121.040.013	4,8X15MM	500	34121.048.015	4,8X20MM	250	34121.048.020
4,0X18MM	500	34121.040.018				4,8X24MM	250	34121.048.024

Nitownice do nitów zrywalnych



	Ø 2,4			Ø 3,0 - 3,2			Ø 4,0			Ø 4,8 - 5,0			Ø 6,0 - 6,4		
	Al	St	St.st.	Al	St	St.st.	Al	St	St.st.	Al	St	St.st.	Al	St	St.st.
F 80															
F 150															
F 260															
FEZ1000															
FEZ2000															

opcje dodatkowe
 zalecana nośność

Grupy katalogowe

Kod	Strona
35145	9-79
35760	9-79

35145	Nitownica ręczna	T90A

Typ	☒	Kod artykułu		
F80	1	35145.080.001	<ul style="list-style-type: none"> Profesjonalna nitownica ręczna. Możliwość obsługi jedną ręką. Do rozmiarów: Ø 3,0 - 6,4 mm. Waga: 2,2 kg. Długość: 310 mm (zamknięta) - 830 mm (otwarta). Korpus: Aluminium Dźwignia: Stal Wyposażenie: końcówki Ø 3,0 - 6,4 mm. 	
F150 B	1	35145.150.001	<ul style="list-style-type: none"> Profesjonalna nitownica do małych i lekkich prac montażowych. Do rozmiarów: 3,0 - 5,0 mm Waga: 0,7 kg Długość: 255 mm Korpus: Aluminium Dźwignia: Stal Wyposażenie: Końcówki 3,0 - 5,0 mm 	
F260	1	35145.260.001	<ul style="list-style-type: none"> Nitownica z przedłużonym ramieniem przystosowana do pracy przy dużych obciążeniach. Do rozmiarów: 3,0 - 6,4 mm Waga: 1,8 kg Długość: 500 mm Korpus: ABS (tworzywo sztuczne) z elementami stalowymi Dźwignia: Stal Wyposażenie: Końcówki 3,0 - 6,4 mm 	

35760	Nitownica pneumatyczna do nitów zrywalnych	T91A

Typ	☒	Kod artykułu		
FEZ 1000	1	35760.100.001	<ul style="list-style-type: none"> Pneumatyczna nitownica nowej generacji wyposażona w zasobnik trzpieni oraz mechanizm blokujący. Do rozmiarów: 3,0 - 5,0 mm Waga: 1,25 kg Wymiary: 264 x 272 x 102 Skok tłoka: 17,0 mm Ciśnienie: 5-7 Bar Siła robocza (6Bar): 7,3 kN Wyposażenie: Końcówki 3,0 - 5,0 mm. 	

35760 Nitownica pneumatyczna do nitów zrywalnych

Typ

FEZ 2000

Kod artykułu

1

[35760.200.001](#)

Pneumatyczna nitownica nowej generacji wyposażona w zasobnik trzpieni oraz mechanizm blokujący.

- Do rozmiarów: 4,0 - 6,4 mm
- Waga: 1,65 kg
- Wymiary: 275 x 272 x 125
- Skok tłoka: 21,0 mm
- Ciśnienie: 5-7 Bar
- Siła robocza (6Bar): 12,5 kN
- Wyposażenie: Końcówki 4,0 - 6,4 mm

Zestaw do nitowania

35146 Zestaw do nitowania
T90A

Wymiary

F150BS



Kod artykułu

1

[35146.150.001](#)

- Zestaw do nitowania.
- Narzędzie z 8 rozmiarami nitów od \varnothing 3,2 mm do \varnothing 4,8 mm do podstawowych prac.

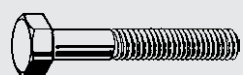



1 Śruby



2 Produkty z gniazdem sześciokątnym



3 Nakrętki, nitonakrętki & wkładki



4 Pręty gwintowane & śruby dwustronne



5 Haki & śruby oczkowe



6 Wkręty

I Index



7 Podkładki & pierścienie uszczelniające typu “O-ring”



8 Kotwy, kołki, dyble

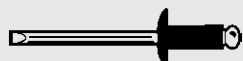

9 Nity, kołki & wpusty



10 Elementy łączące systemowe, meblowe & zabezpieczające

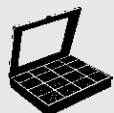

11 Zestawy

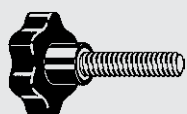

12 Części konstrukcyjne & części maszynowe





13 Przemysł morski

T Technologia łączenia

Elementy złączne systemowe, meblowe & zabezpieczające 10

 Strona 10-4 DIN 787 Śruby do rowków teowych	 Strona 10-5 DIN 508 Nakrętki do rowków teowych	 Strona 10-6 DIN 6330 B 1,5xd, metryczne	 Strona 10-7 DIN 6331 1,5xd z kołnierzem, metryczne	 Strona 10-8 3xd, metryczne
 Strona 10-9 DIN 6319 Podkładki kuliste i stożkowe	 Strona 10-11 DIN 6340 Podkładki do elementów mocujących	 Strona 10-12 DIN 6379 Do nakrętek do rowków teowych, metryczne	 Strona 10-13 Zestawy śrub do rowków teowych	 Strona 10-17 LINDAPTER Holo-bolt sześciokątna
 Strona 10-18 LINDAPTER Holo-bolt łeb płaski	 Strona 10-19 Holo-bolt łeb Flush Fit (chowany)	 Strona 10-20 LINDAPTER Holo-bolt narzędzia	 Strona 10-21 LINDAPTER Systemy zaciskowe	 Strona 10-24 Lindapter zaciski HSR
 Strona 10-24 LINDAPTER Podpórki	 Strona 10-28 LINDAPTER typ W	 Strona 10-28 LINDAPTER typ CF	 Strona 10-29 LINDAPTER typ LR	 Strona 10-30 LINDAPTER typ D2
 Strona 10-31 LINDAPTER typ BR	 Strona 10-32 LINDAPTER Zaciski kołnierzowe	 Strona 10-33 LINDAPTER Zaciski czołowe	 Strona 10-34 LINDAPTER Mocowania podłogowe	 Strona 10-35 LINDAPTER GF3030
 Strona 10-36 FISCHER Siodło	 Strona 10-37 Zacisk rurowy	 Strona 10-38 Zacisk rurowy	 Strona 10-39 Zacisk rurowy do urządzeń chłodniczych	 Strona 10-40 Ceownik
 Strona 10-41 Ramię wspornika	 Strona 10-42 Zaślepka	 Strona 10-42 Śruba typ T clix	 Strona 10-43 Nakrętka	 Strona 10-44 Podkładka
 Strona 10-44 Śruba typ T	 Strona 10-45 Wspornik	 Strona 10-46 Wspornik	 Strona 10-47 Obejmy	 Strona 10-48 Zacisk
 Strona 10-49 Łączniki	 Strona 10-50 Łączniki równoległe	 Strona 10-51 Zacisk śrubowy	 Strona 10-52 Opaski stalowe	 Strona 10-53 Łączniki podwójne
 Strona 10-54 Łącznik śrubowy	 Strona 10-56 Klamry do belek, typ H	 Strona 10-56 Klamry do belek, typ 50H	 Strona 10-57 Klamry do belek, typ BC	 Strona 10-57 Klamry do belek, typ BCC

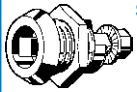
Elementy łączące systemowe, meblowe & zabezpieczające **10**

 Strona 10-58 Klamry do belek, typ RH	 Strona 10-59 Elementy łączące dociskające, typ PF	 Strona 10-59 Zacisk zatraskowe do przewodów/rur	 Strona 10-60 Klamry, typ MC	 Strona 10-60 Zaciski do ciągów kablowych
 Strona 10-62 Klamra	 Strona 10-64 Strychulec do klamr	 Strona 10-67 Korpus zamka	 Strona 10-69 Zapadka do zamka	 Strona 10-72 Klucze
 Strona 10-73 Akcesoria do zapadek	 Strona 10-74 Prowadzenia zapadek zamykających	 Strona 10-76 Sworznie z łbem z rowkiem	 Strona 10-76 Sworznie z łbem skrzydełkowym	 Strona 10-77 Sworznie z łbem radełkowym z rowkiem
 Strona 10-77 Sworznie kulowe	 Strona 10-78 Podkładki zabezpieczające	 Strona 10-79 Pierścienie ustalające	 Strona 10-80 Podkładki ochronne	 Strona 10-80 Pierścienie uszczelniające
 Strona 10-81 Sprężyny zabezpieczające stożkowe	 Strona 10-81 Płytki sprężyste do sworzni	 Strona 10-82 Płytki sprężyste do zgrzewania	 Strona 10-83 Oprawki sprężyste ślizgowe	 Strona 10-83 Wsporniki sprężynujące
 Strona 10-84 Oprawki frontowe	 Strona 10-86 Zaciski trzyczęściowe	 Strona 10-86 Kompensatory tolerancji	 Strona 10-87 Wkładki, typ C, mosiądz	 Strona 10-87 Wkładki, typ D, mosiądz
 Strona 10-88 Wkładki, typ E, mosiądz	 Strona 10-89 Wkładki, typ 530, mosiądz	 Strona 10-89 Nakrętki pazurkowe	 Strona 10-90 Wkładki, typ SK/SKD	 Strona 10-91 DIN 7965 Wkładki, typ A
 Strona 10-92 Wkładki, typ SKDZ	 Strona 10-92 Wkładki, typ TS	 Strona 10-93 Nakrętki, typ RM	 Strona 10-93 Nakrętki, typ RSK	 Strona 10-94 Nakrętki, typ RF
 Strona 10-95 Nakrętki, typ RT	 Strona 10-96 Śruby, typ KF	 Strona 10-96 Śruby, typ KT	 Strona 10-97 Konfirmat, typ KOK	 Strona 10-97 Nakrętka
 Strona 10-98 Rozeta, typ otwarty	 Strona 10-99 Rozeta, typ pełny	 Strona 10-99 Podkładka do śrub z łbem stożkowym	 Strona 10-100 Podkładka do śrub z łbem stożkowym	 Strona 10-101 Nakrętki książkowe

Elementy złączne systemowe, meblowe & zabezpieczające 10

 Strona 10-102 Nakrętki książkowe	 Strona 10-103 Śruby książkowe	 Strona 10-104 Połączenia książkowe	 Strona 10-104 Przedłużka książkowa	 Strona 10-105 Połączenie książkowe
 Strona 10-105 Zaślepki do rur	 Strona 10-106 Zaślepki do rur	 Strona 10-106 Zaślepki do rur	 Strona 10-107 Zaślepki rurowe stożkowe	 Strona 10-109 SECURITY Nakrętki zabezpieczające
 Strona 10-110 SECURITY nakrętka zrywalna	 Strona 10-111 SECURITY Śruby zabezpieczające, gniazdo ze szpilką	 Strona 10-112 SECURITY Śruby zabezpieczające z zaślepką	 Strona 10-113 SECURITY Śruby zabezpieczające, gniazdo 6-karbowe ze szpilką	 Strona 10-114 SECURITY Śruby zabezpieczające z 2 otworami
 Strona 10-114 SECURITY Śruby zabezpieczające, zakręcane w 1 stronę	 Strona 10-115 SECURITY Śruby zabezpieczające, gniazdo 6-kątne ze szpilką	 Strona 10-116 SECURITY Śruby zabezpieczające z zaślepką	 Strona 10-116 SECURITY Śruby zabezpieczające, gniazdo sześciokarbowe ze szpilką	 Strona 10-117 SECURITY Śruby zabezpieczające z 2 otworami
 Strona 10-118 SECURITY Wkręty zabezpieczające	 Strona 10-119 SECURITY Wkręty zabezpieczające, gniazdo 6-karbowe ze szpilką	 Strona 10-120 SECURITY Wkręty zabezpieczające, gniazdo krzyżowe ze szpilką	 Strona 10-120 SECURITY Wkręty zabezpieczające z 2 otworami	 Strona 10-121 SECURITY Wkręty zabezpieczające z 2 otworami
 Strona 10-122 SECURITY Wkręty zabezpieczające, zakręcane w 1 stronę	 Strona 10-123 SECURITY Wkręty zabezpieczające TRI-Wing	 Strona 10-123 SECURITY Wkręty zabezpieczające	 Strona 10-124 SECURITY Wkręty zabezpieczające, gniazdo 6-karbowe ze szpilką	 Strona 10-125 SECURITY Wkręty zabezpieczające, gniazdo krzyżowe ze szpilką
 Strona 10-125 SECURITY Wkręty zabezpieczające z 2 otworami	 Strona 10-126 SECURITY Wkręty zabezpieczające z 2 otworami	 Strona 10-127 SECURITY Wkręty zabezpieczające, zakręcane w 1 stronę	 Strona 10-127 SECURITY Wkręty zabezpieczające, gniazdo kwadratowe	 Strona 10-128 SECURITY Korki zabezpieczające z gniazdem 6-kątnym
 Strona 10-129 SECURITY Korki zabezpieczające	 Strona 10-129 Kołki do zgrzewania			

Śruby do rowków teowych

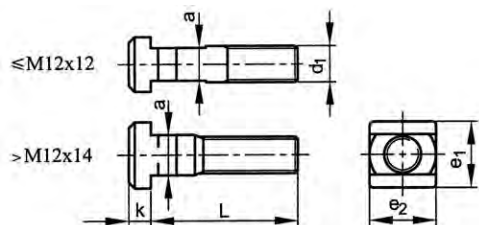

DIN 787
ISO 299
NF E21-301
BS 2485

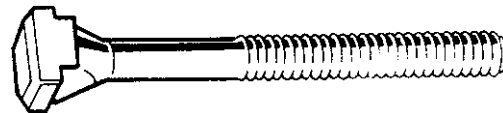

Informacje techniczne

$d_1 \times a$	$e (e_2 \geq e_1)$	k	P	$d_1 \times a$	$e (e_2 \geq e_1)$	k	P
M8x8	13	6	1.25	M16x18	28	10	2
M10x10	15	6	1.5	M20x20 (#DIN)	32	12	2.5
M12x12	18	7	1.75	M20x22	35	14	2.5
M12x14	22	8	1.75	M24x24 (#DIN)	40	16	3
M16x16 (#DIN)	25	9	2	M24x28	44	18	3

- Rozmiary rowków teowych, patrz DIN 650.

16202 Śruby do rowków teowych

F95A

Gwint Metryczny
Materiał Stal
Klasa 10.9/8.8



$d_1 \times a \times L$	☒	Kod artykułu	$d_1 \times a \times L$	☒	Kod artykułu	$d_1 \times a \times L$	☒	Kod artykułu
M8X8X32	25	16202.088.032	M12X14X80	25	16202.134.080	M20X20X125	5	16202.220.125
M8X8X50	25	16202.088.050	M12X14X125	25	16202.134.125	M20X20X160	5	16202.220.160
M8X8X80	25	16202.088.080				M20X20X200	5	16202.220.200
			M16X16X63	10	16202.176.063			
M10X10X40	25	16202.110.040	M16X16X80	10	16202.176.080	M20X22X80	5	16202.222.080
M10X10X63	25	16202.110.063	M16X16X100	10	16202.176.100	M20X22X125	5	16202.222.125
M10X10X100	25	16202.110.100	M16X16X125	10	16202.176.125	M20X22X200	5	16202.222.200
			M16X16X160	10	16202.176.160			
M12X12X50	25	16202.132.050				M24X24X100	5	16202.264.100
M12X12X63	25	16202.132.063	M16X18X63	10	16202.178.063	M24X24X160	5	16202.264.160
M12X12X80	25	16202.132.080	M16X18X100	10	16202.178.100	M24X24X250	5	16202.264.250
M12X12X100	25	16202.132.100	M16X18X160	10	16202.178.160			
M12X12X125	25	16202.132.125				M24X28X100	5	16202.268.100
						M24X28X160	5	16202.268.160
M12X14X50	25	16202.134.050	M20X20X80	5	16202.220.080	M24X28X250	5	16202.268.250
M12X14X63	25	16202.134.063	M20X20X100	5	16202.220.100			

- Śruby do rowków teowych do rozmiaru M12 włącznie klasa 10.9, powyżej rozmiaru M12 klasa 8.8.

Nakrętki do rowków teowych

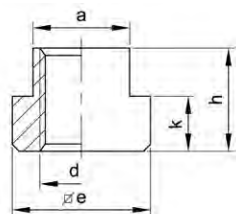

DIN 508
ISO 299
NF E21-301
BS 2485

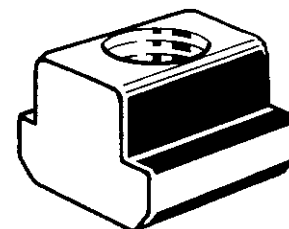

Informacje techniczne

d x a	e	h	k	P	d x a	e	h	k	P
M5x6	10	8	4	0.8	M12x18 (≠DIN)	28	20	10	1.75
M6x8	13	10	6	1	M14x16 (≠DIN)	25	18	9	2
M8x10	15	12	6	1.25	M14x18 (≠DIN)	28	20	10	2
M8x12 (≠DIN)	18	14	7	1.25	M16x18	28	20	10	2
M10x12	18	14	7	1.5	M16x22 (≠DIN)	35	28	14	2
M10x14 (≠DIN)	22	16	8	1.5	M20x22	35	28	14	2.5
M12x14	22	16	8	1.75	M24x28	44	36	18	3
M12x16 (≠DIN)	25	18	9	1.75					

- Rozmiary rowków teowych, patrz DIN 650.

16196 Nakrętki do rowków teowych		F95A
Gwint	Metryczny	
Materiał	Stal	
Klasa	[10]	

d x a	☒	Kod artykułu	d x a	☒	Kod artykułu	d x a	☒	Kod artykułu
M5X6	50	16196.050.006	M10X14	50	16196.100.014	M14X18	25	16196.140.018
M6X8	50	16196.060.008	M12X14	50	16196.120.014	M16X18	25	16196.160.018
M8X10	50	16196.080.010	M12X16	25	16196.120.016	M16X22	25	16196.160.022
M8X12	50	16196.080.012	M12X18	25	16196.120.018	M20X22	10	16196.200.022
M10X12	50	16196.100.012	M14X16	25	16196.140.016	M24X28	10	16196.240.028

Nakrętki sześciokątne, wysokość 1,5xd

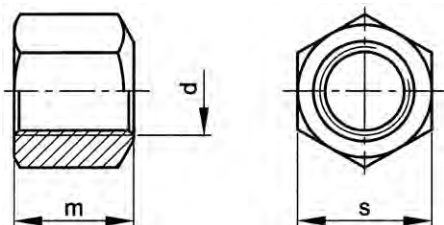

DIN 6330 B
NEN 2307

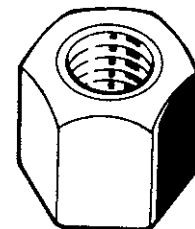

Informacje techniczne

d	m (js15)	P	s	d	m (js15)	P	s
M6	9	1	10	M16	24	2	24
M8	12	1.25	13	M20	30	2.5	30
M10 (≠DIN)	15	1.5	17	M24	36	3	36
M10	15	1.5	16	M27	39	3	41
M12 (≠DIN)	18	1.75	19	M30	45	3.5	46
M12	18	1.75	18	M33	48	3.5	50
M14 (≠DIN)	21	2	22	M36	54	4	55

Przykłady zastosowania

Podkładka dociskowa
według normy DIN 6340

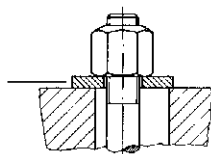

Osadzenie stożkowe
według normy DIN 6319D

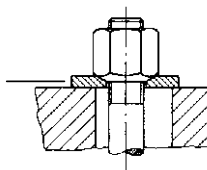

Grupy katalogowe

Gwint	Gniazdo	Materiał	Klasa	Kod	Strona
M	Sześciokąt	St	10	16203	10-6
M	Sześciokąt	St.St. A1	70	51102	10-6
M	Sześciokąt	St.St. A4	70	55102	10-7

16203 Nakrętki sześciokątne, wysokość 1,5xd

F95A

Gwint Metryczny
Materiał Stal
Klasa 10

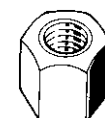

d	☒	Kod artykułu	d	☒	Kod artykułu	d	☒	Kod artykułu
M8	50	16203.080.001	M12 s=19	50	16203.120.190	M20	10	16203.200.001
M10 s=16	50	16203.100.001	M14	25	16203.140.001	M24	10	16203.240.001
M10 s=17	50	16203.100.170	M16	25	16203.160.001	M30	5	16203.300.001
M12 s=18	50	16203.120.001						

51102 Nakrętki sześciokątne, wysokość 1,5xd

R09A

Gwint Metryczny
Materiał Stal nierdzewna A1
Klasa 70

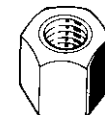

d	☒	Kod artykułu	d	☒	Kod artykułu	d	☒	Kod artykułu
M6*	50	51102.060.001	M14*	25	51102.140.001	M27*	10	51102.270.001
M8	50	51102.080.001	M16	25	51102.160.001	M30*	10	51102.300.001
M10	50	51102.100.001	M20	10	51102.200.001	M33*	10	51102.330.001
M12	50	51102.120.001	M24	10	51102.240.001			

55102	Nakrętki sześciokątne, wysokość 1,5xd	R49A
Gwint	Metryczny	
Materiał	Stal nierdzewna A4	
Klasa	70	
		

d	☒	Kod artykułu	d	☒	Kod artykułu	d	☒	Kod artykułu
M6*	50	55102.060.001	M14*	25	55102.140.001	M27*	10	55102.270.001
M8	50	55102.080.001	M16	25	55102.160.001	M30*	10	55102.300.001
M10	50	55102.100.001	M20	10	55102.200.001	M36*	10	55102.360.001
M12	50	55102.120.001	M24	10	55102.240.001			

Nakrętki sześciokątne z kołnierzem, wysokość 1,5xd

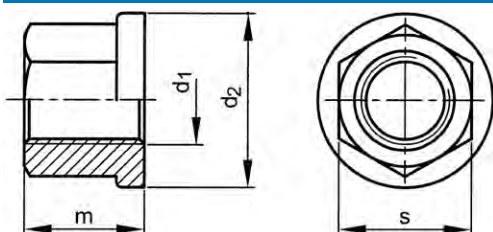

DIN 6331

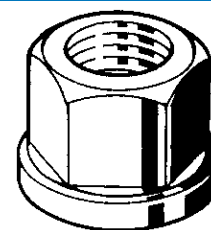

Informacje techniczne



d ₁	d ₂ (h13)	m (js15)	P	s	d ₁	d ₂ (h13)	m (js15)	P	s
M6	14	9	1	10	M16	31	24	2	24
M8	18	12	1.25	13	M20	37	30	2.5	30
M10	22	15	1.5	16/17	M24	45	36	3	36
M12	25	18	1.75	18	M30	58	45	3.5	46
M14	28	21	2	22					

Grupy katalogowe

Gwint	Gniazdo	Materiał	Klasa	Kod	Strona
M	Sześciokąt	St	10	16204	10-7
M	Sześciokąt	St.St. A1	70	51104	10-7
M	Sześciokąt	St.St. A4	70	55104	10-8

16204	Nakrętki sześciokątne z kołnierzem, wysokość 1,5xd	F95A
Gwint	Metryczny	
Materiał	Stal	
Klasa	10	
		

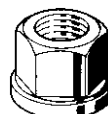
d ₁	☒	Kod artykułu	d ₁	☒	Kod artykułu	d ₁	☒	Kod artykułu
M6	50	16204.060.001	M12	50	16204.120.001	M20	10	16204.200.001
M8	50	16204.080.001	M14	50	16204.140.001	M24	10	16204.240.001
M10 s=16	50	16204.100.001	M16	25	16204.160.001	M30	10	16204.300.001

51104	Nakrętki sześciokątne z kołnierzem, wysokość 1,5xd	R09A
Gwint	Metryczny	
Materiał	Stal nierdzewna A1	
Klasa	70	
		DIN ≈6331
		

d ₁	☒	Kod artykułu	d ₁	☒	Kod artykułu	d ₁	☒	Kod artykułu
M6*	50	51104.060.001	M12	25	51104.120.001	M20	5	51104.200.001
M8	25	51104.080.001	M14*	25	51104.140.001	M24	5	51104.240.001
M10 s=17	25	51104.100.001	M16	10	51104.160.001			

55104	Nakrętki sześciokątne z kołnierzem, wysokość 1,5xd	R49A
Gwint	Metryczny	DIN ≈6331
Materiał	Stal nierdzewna A4	
Klasa	70	

d_1	☒	Kod artykułu	d_1	☒	Kod artykułu	d_1	☒	Kod artykułu
M6*	50	55104.060.001	M12	25	55104.120.001	M20	5	55104.200.001
M8	25	55104.080.001	M14*	25	55104.140.001	M24	5	55104.240.001
M10 s=17	25	55104.100.001	M16	10	55104.160.001			

Nakrętki przedłużane, wysokość 3xd

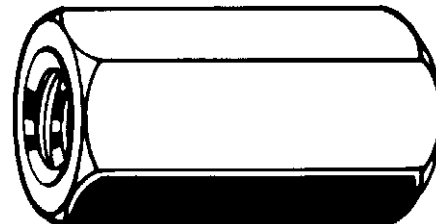
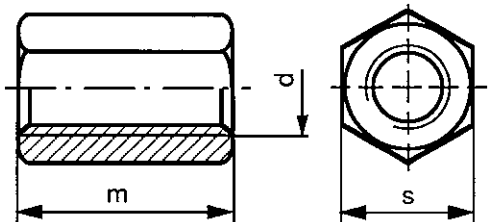

Informacje techniczne

d	m	P	s	d	m	P	s
M8	24	1.25	13	M20	60	2.5	30
M10	30	1.5	17	M24	72	3	36
M12	36	1.75	19	M27	81	3	41
M14	42	2	22	M30	90	3.5	46
M16	48	2	24	M36	108	4	55

16225	Nakrętki przedłużane, wysokość 3xd	F95A
Gwint	Metryczny	
Materiał	Stal	
Klasa	[10]	

d	☒	Kod artykułu	d	☒	Kod artykułu	d	☒	Kod artykułu
M8	25	16225.080.001	M16	10	16225.160.001	M27	5	16225.270.001
M10	25	16225.100.001	M20	5	16225.200.001	M30	5	16225.300.001
M12	25	16225.120.001	M24	5	16225.240.001	M36	5	16225.360.001

Podkładki kuliste i stożkowe

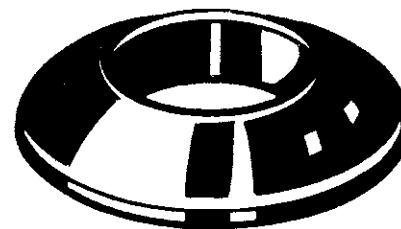
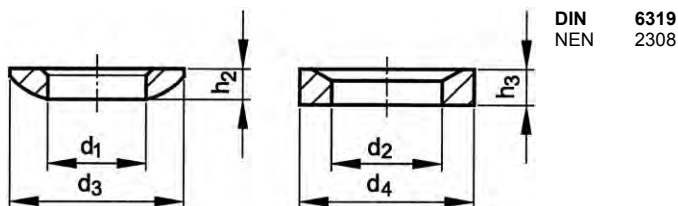

Informacje techniczne

Dla wymiaru nominalnego	d ₁ (H13)	d ₂ (H13)	d ₃	d ₄	h ₂	h ₃	h ₄ ≈	S
M6	6.4	7.1	12	12	2.3	2.8	4.2	9
M8	8.4	9.6	17	17	3.2	3.5	5.6	17
M10	10.5	12	21	21	4	4.2	6.5	26
M12	13	14.2	24	24	4.6	5	8	38
M14	15	16.5	28	28	5	5.6	8.5	53
M16	17	19	30	30	5.3	6.2	9.6	73
M20	21	23.2	36	36	6.3	7.5	11.7	117
M24	25	28	44	44	8.2	9.5	15.2	168
M30	31	35	56	56	11.2	12	19.2	269
M36	37	42	69	69	14	15	23.5	394

- S = Obciążenie statyczne w kN (maks.).
- Połączenie podkładki kulistej typu C z gniazdem stożkowym typu D pozwala na pochylenie $\approx 3^\circ$ w dowolnym kierunku przy przekładaniu śruby.
- UWAGA: gdy stosowane są w połączeniu z częściami złącznymi klasy 10.9 lub 10, dopuszczalne obciążenie zamocowania będzie wynosić maksymalnie 46% Re; dla klasy 8.8 lub 8 maksymalnie 66% Re.
- Podkładki te nie mogą być stosowane do otworów z rowkiem.

Kolejność montażu

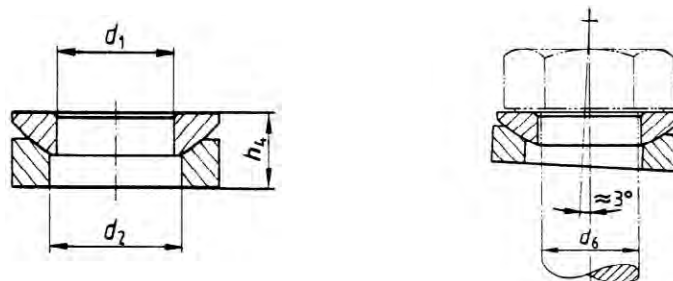

Grupy katalogowe

Material		Kod	Strona
St 550+100 HV10	Typ C	16206	10-9
St.St. A2	Typ C	51936	10-10
St 550+100 HV10	Typ D	16207	10-10
St.St. A2	Typ D	51935	10-10

16206 Podkładki kuliste typu C			F95A
Material	Stal 550+100 HV10	DIN 6319 C NEN 2308 C	



Dla wymiaru nominalnego	☒	Kod artykułu	Dla wymiaru nominalnego	☒	Kod artykułu	Dla wymiaru nominalnego	☒	Kod artykułu
M6	100	16206.060.001	M14	50	16206.140.001	M30	25	16206.300.001
M8	100	16206.080.001	M16	50	16206.160.001	M36	25	16206.360.001
M10	100	16206.100.001	M20	25	16206.200.001			
M12	100	16206.120.001	M24	25	16206.240.001			

51936 Podkładki sferyczne typ C						F95A	
Materiał		Stal nierdzewna A2		DIN	6319 C		
				NEN	2308 C		
Dla wymiaru nominalnego	<input type="checkbox"/>	Kod artykułu	Dla wymiaru nominalnego	<input type="checkbox"/>	Kod artykułu	Dla wymiaru nominalnego	<input type="checkbox"/>
M8	50	51936.080.001	M12	25	51936.120.001	M20	25
M10	50	51936.100.001	M16	100	51936.160.001		

16207 Podkładki kuliste typu D						F95A	
Materiał		Stal 550+100 HV10		DIN	6319 D		
				NEN	2308 D		
Dla wymiaru nominalnego	<input type="checkbox"/>	Kod artykułu	Dla wymiaru nominalnego	<input type="checkbox"/>	Kod artykułu	Dla wymiaru nominalnego	<input type="checkbox"/>
M6	100	16207.060.001	M14	50	16207.140.001	M30	25
M8	100	16207.080.001	M16	50	16207.160.001	M36	25
M10	100	16207.100.001	M20	25	16207.200.001		
M12	100	16207.120.001	M24	25	16207.240.001		

51935 Podkładki stożkowe typ D						F95A	
Materiał		Stal nierdzewna A2		DIN	6319 D		
				NEN	2308 D		
Dla wymiaru nominalnego	<input type="checkbox"/>	Kod artykułu	Dla wymiaru nominalnego	<input type="checkbox"/>	Kod artykułu	Dla wymiaru nominalnego	<input type="checkbox"/>
M8	50	51935.080.001	M12	25	51935.120.001	M20	25
M10	50	51935.100.001	M16	25	51935.160.001		

Podkładki okrągłe do elementów mocujących

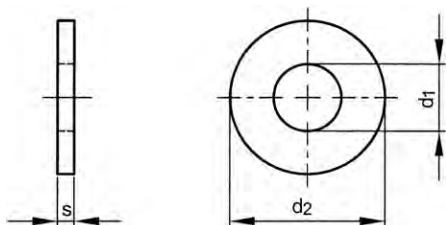

DIN 6340
NF E25-518

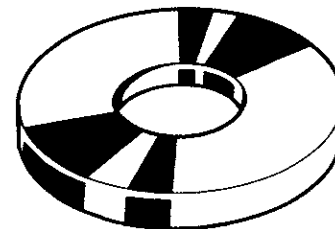

Informacje techniczne

Dla wymiaru nominalnego	d ₁ (H14)	d ₂ (h14)	s	Dla wymiaru nominalnego	d ₁ (H14)	d ₂ (h14)	s
M6	6.4	17	3	M14 (#DIN)	15	40	5
M8	8.4	23	4	M16	17	45	6
M10	10.5	28	4	M20	21	50	6
M12	13	35	5	M24	25	60	8

Grupy katalogowe

Material	Obróbka powierzchni	Kod	Strona
St 350+80 HV30		16205	10-11
St 350+80 HV30	Ocynk.	16229	10-11

16205 Podkładki okrągłe do elementów mocujących

F95A

Material Stal 350+80 HV30



Dla wymiaru nominalnego	Kod artykułu	Dla wymiaru nominalnego	Kod artykułu	Dla wymiaru nominalnego	Kod artykułu
M6	50 16205.060.001	M12	50 16205.120.001	M20	10 16205.200.001
M8	50 16205.080.001	M14	50 16205.140.001	M24	10 16205.240.001
M10	50 16205.100.001	M16	25 16205.160.001		

16229 Podkładki okrągłe do elementów mocujących

F95A

Material Stal 350+80 HV30
Obróbka powierzchni Ocynkowane



Dla wymiaru nominalnego	Kod artykułu	Dla wymiaru nominalnego	Kod artykułu	Dla wymiaru nominalnego	Kod artykułu
M6	100 16229.060.001	M10	100 16229.100.001	M16	100 16229.160.001
M8	100 16229.080.001	M12	100 16229.120.001	M20	100 16229.200.001

Śruby dwustronne do nakrętek teowych

DIN 6379

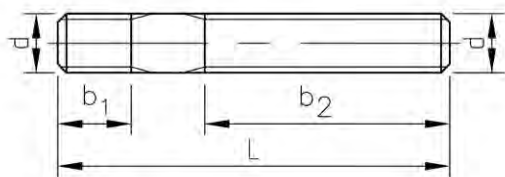

Informacje techniczne

d	b ₁	P	d	b ₁	P
M8	11	1.25	M16	19	2
M10	13	1.5	M20	27	2.5
M12	15	1.75	M24	35	3
M14 (#DIN)	17	2			

- Śruby dwustronne do rozmiaru M12 - klasa 10.9, powyżej rozmiaru M12 klasa 8.8.

16226 Śruby dwustronne do nakrętek teowych

F95A

Gwint Metryczny
 Materiał Stal
 Klasa 10.9/8.8



d x L (b ₂)	☒	Kod artykułu	d x L (b ₂)	☒	Kod artykułu	d x L (b ₂)	☒	Kod artykułu
M8X40 (20)	25	16226.080.040	M12X125 (75)	25	16226.120.125	M20X200 (125)	5	16226.200.200
M8X63 (40)	25	16226.080.063	M12X160 (100)	25	16226.120.160	M20X250 (160)	5	16226.200.250
M8X100 (63)	25	16226.080.100	M12X200 (125)	10	16226.120.200	M20X315 (200)	3	16226.200.315
M8X160 (100)	25	16226.080.160				M20X400 (250)	3	16226.200.400
			M16X63 (32)	10	16226.160.063	M20X500 (315)	3	16226.200.500
M10X50 (25)	25	16226.100.050	M16X80 (50)	10	16226.160.080			
M10X80 (50)	25	16226.100.080	M16X100 (63)	10	16226.160.100	M24X100 (45)	10	16226.240.100
M10X100 (75)	25	16226.100.100	M16X125 (75)	10	16226.160.125	M24X125 (70)	10	16226.240.125
M10X125 (75)	25	16226.100.125	M16X160 (100)	10	16226.160.160	M24X160 (100)	10	16226.240.160
M10X160 (100)	25	16226.100.160	M16X200 (125)	5	16226.160.200	M24X200 (125)	5	16226.240.200
M10X200 (125)	10	16226.100.200	M16X250 (160)	5	16226.160.250	M24X250 (160)	5	16226.240.250
			M16X315 (180)	5	16226.160.315	M24X315 (200)	5	16226.240.315
M12X50 (25)	25	16226.120.050				M24X400 (250)	3	16226.240.400
M12X63 (32)	25	16226.120.063	M20X80 (32)	10	16226.200.080	M24X500 (315)	3	16226.240.500
M12X80 (50)	25	16226.120.080	M20X125 (70)	10	16226.200.125	M24X630 (315)	3	16226.240.630
M12X100 (63)	25	16226.120.100	M20X160 (100)	10	16226.200.160			

Zestawy akcesoriów do rowków teowych



Grupy katalogowe

Material	Kod	Strona
St	16227	10-13
St	16228	10-14

16227 Zestaw akcesoriów do rowków teowych Nr 6520 F95A

Material Stal



Nr	✉	Kod artykułu		
M10X10	1	16227.100.010	<p>Zapakowane w drewniane pudełko</p> <p>Zawartość:</p> <ul style="list-style-type: none"> • 2 sztuki śrub i wkrętów do rowków teowych zgodn. z DIN 787, długość 40 mm • 4 sztuki śrub i wkrętów do rowków teowych zgodn. z DIN 787, długość 63 mm • 4 sztuki śrub i wkrętów do rowków teowych zgodn. z DIN 787, długość 100 mm • 4 sztuki śrub dwustronnych do rowków teowych zgodn. z DIN 6379, długość 50 mm • 4 sztuki śrub dwustronnych do rowków teowych zgodn. z DIN 6379, długość 80 mm • 4 sztuki śrub dwustronnych do rowków teowych zgodn. z DIN 6379, długość 200 mm • 4 sztuki nakrętek sześciokątnych 1,5 d, zgodn. z DIN 6330 B • 4 sztuki nakrętek przedłużanych 3 x d • 4 sztuki podkładek kulistych zgodn. z DIN 6319 C • 4 sztuki podkładek kulistych zgodn. z DIN 6319 G • 4 sztuki podkładek do części mocujących zgodn. z DIN 6340 	
M12X12	1	16227.120.012	<p>Zapakowane w drewniane pudełko</p> <p>Zawartość:</p> <ul style="list-style-type: none"> • 2 sztuki śrub i wkrętów do rowków teowych zgodn. z DIN 787, długość 50 mm • 4 sztuki śrub i wkrętów do rowków teowych zgodn. z DIN 787, długość 80 mm • 4 sztuki śrub i wkrętów do rowków teowych zgodn. z DIN 787, długość 125 mm • 4 sztuki śrub dwustronnych do rowków teowych zgodn. z DIN 6379, długość 63 mm • 4 sztuki śrub dwustronnych do rowków teowych zgodn. z DIN 6379, długość 100 mm • 4 sztuki śrub dwustronnych do rowków teowych zgodn. z DIN 6379, długość 200 mm • 4 sztuki nakrętek sześciokątnych 1,5 d, zgodn. z DIN 6330 B • 4 sztuki nakrętek przedłużanych 3 x d • 4 sztuki podkładek kulistych zgodn. z DIN 6319 C • 4 sztuki podkładek kulistych zgodn. z DIN 6319 G • 4 sztuki podkładek do części mocujących zgodn. z DIN 6340 	
M12X14	1	16227.120.014	<p>Zapakowane w drewniane pudełko</p> <p>Zawartość:</p> <ul style="list-style-type: none"> • 2 sztuki śrub i wkrętów do rowków teowych zgodn. z DIN 787, długość 50 mm • 4 sztuki śrub i wkrętów do rowków teowych zgodn. z DIN 787, długość 80 mm • 4 sztuki nakrętki do rowków teowych, zgodn. z DIN 508 • 4 sztuki śrub dwustronnych do rowków teowych zgodn. z DIN 6379, długość 63 mm • 4 sztuki śrub dwustronnych do rowków teowych zgodn. z DIN 6379, długość 100 mm • 4 sztuki śrub dwustronnych do rowków teowych zgodn. z DIN 6379, długość 125 mm • 4 sztuki śrub dwustronnych do rowków teowych zgodn. z DIN 6379, długość 200 mm • 4 sztuki nakrętek sześciokątnych 1,5 d zgodn. z DIN 6330 B • 4 sztuki nakrętek przedłużanych 3 x d • 4 sztuki podkładek kulistych zgodn. z DIN 6319 C • 4 sztuki podkładek kulistych zgodn. z DIN 6319 G • 4 sztuki podkładek do części mocujących zgodn. z DIN 6340 	



16227 Zestaw akcesoriów do rowków teowych Nr 6520

Nr	Kod artykułu		
M16X18	1 16227.160.018	Zapakowane w drewniane pudełko Zawartość:	
		<ul style="list-style-type: none"> • 2 sztuki śrub i wkrętów do rowków teowych zgodn. z DIN 787, długość 63 mm • 4 sztuki śrub i wkrętów do rowków teowych zgodn. z DIN 787, długość 100 mm • 4 sztuki nakrętki do rowków teowych zgodn. z DIN 508 • 4 sztuki śrub dwustronnych do rowków teowych zgodn. z DIN 6379, długość 80 mm • 4 sztuki śrub dwustronnych do rowków teowych zgodn. z DIN 6379, długość 125 mm • 4 sztuki śrub dwustronnych do rowków teowych zgodn. z DIN 6379, długość 160 mm • 4 sztuki śrub dwustronnych do rowków teowych zgodn. z DIN 6379, długość 250 mm • 4 sztuki nakrętek sześciokątnych 1,5 d zgodn. z DIN 6330 B • 4 sztuki nakrętek przedłużanych 3 x d • 4 sztuki podkładek kulistych zgodn. z DIN 6319 C • 4 sztuki podkładek kulistych zgodn. z DIN 6319 G • 4 sztuki podkładek do części mocujących zgodn. z DIN 6340 	
M20X22	1 16227.200.022	Zapakowane w drewniane pudełko Zawartość:	
		<ul style="list-style-type: none"> • 2 sztuki śrub i wkrętów do rowków teowych zgodn. z DIN 787, długość 80 mm • 4 sztuki śrub i wkrętów do rowków teowych zgodn. z DIN 787, długość 125 mm • 4 sztuki nakrętek do rowków teowych zgodn. z DIN 508 • 4 sztuki śrub dwustronnych do rowków teowych zgodn. z DIN 6379, długość 80 mm • 4 sztuki śrub dwustronnych do rowków teowych zgodn. z DIN 6379, długość 125 mm • 4 sztuki śrub dwustronnych do rowków teowych zgodn. z DIN 6379, długość 200 mm • 4 sztuki śrub dwustronnych do rowków teowych zgodn. z DIN 6379, długość 315 mm • 4 sztuki nakrętek sześciokątnych 1,5 d zgodn. z DIN 6330 B • 4 sztuki nakrętek przedłużanych, wysokość 3 x d • 4 sztuki podkładek kulistych zgodn. z DIN 6319 C • 4 sztuki podkładek kulistych zgodn. z DIN 6319 G • 4 sztuki podkładek do części mocujących zgodn. z DIN 6340 	
M24X28	1 16227.240.028	Zapakowane w drewniane pudełko Zawartość:	
		<ul style="list-style-type: none"> • 2 sztuki śrub i wkrętów do rowków teowych zgodn. z DIN 787, długość 100 mm • 4 sztuki śrub i wkrętów do rowków teowych zgodn. z DIN 787, długość 160 mm • 4 sztuki nakrętek do rowków teowych zgodn. z DIN 508 • 4 sztuki śrub dwustronnych do rowków teowych zgodn. z DIN 6379, długość 100 mm • 4 sztuki śrub dwustronnych do rowków teowych zgodn. z DIN 6379, długość 160 mm • 4 sztuki śrub dwustronnych do rowków teowych zgodn. z DIN 6379, długość 250 mm • 4 sztuki śrub dwustronnych do rowków teowych zgodn. z DIN 6379, długość 400 mm • 4 sztuki nakrętek sześciokątnych 1,5 d zgodn. z DIN 6330 B • 4 sztuki nakrętek przedłużanych, wysokość 3 x d • 4 sztuki podkładek kulistych zgodn. z DIN 6319 C • 4 sztuki podkładek kulistych zgodn. z DIN 6319 G • 4 sztuki podkładek do części mocujących zgodn. z DIN 6340 	

16228 Zestaw akcesoriów do rowków teowych Nr 6530
F95A
Materiał Stal

10

Nr	Kod artykułu		
M10X10	1 16228.100.010	Zapakowane w drewniane pudełko ze zdejmowaną pokrywą Zawartość:	
		<ul style="list-style-type: none"> • 4 sztuki zacisków stopniowych 11 x 80 mm • 4 sztuki uniwersalnych suwaków stopniowych nr 1 • 4 sztuki uniwersalnych suwaków stopniowych nr 2 • 4 sztuki uniwersalnych suwaków stopniowych nr 3 • 2 sztuki śrub i wkrętów do rowków teowych zgodn. z DIN 787, długość 40 mm • 4 sztuki śrub i wkrętów do rowków teowych zgodn. z DIN 787, długość 63 mm • 4 sztuki śrub i wkrętów do rowków teowych zgodn. z DIN 787, długość 100 mm • 4 sztuki śrub dwustronnych do rowków teowych zgodn. z DIN 6379, długość 80 mm • 6 sztuk nakrętek sześciokątnych 1,5 d zgodn. z DIN 6330 B • 4 sztuki nakrętek przedłużanych, wysokość 3 x d • 6 sztuk podkładek okrągłych stożkowych zgodn. z ≈ DIN 6319 G • 4 sztuki szczęk zaciskowych niskiej wysokości (w tym śruby z łbem walcowym z gniazdem sześciokątnym zgodn. z DIN 912, klucze do śrub z gniazdem sześciokątnym zgodn. z DIN 911 i nakrętki do rowków teowych zgodn. z DIN 508) • 1 sztuka klucz oczkowy 17 mm 	

16228		Zestaw akcesoriów do rowków teowych Nr 6530		←
Nr	✉	Kod artykułu		
M12X12	1	16228.120.012	<p>Zapakowane w drewnianą skrzynię z odłączaną pokrywą</p> <p>Zawartość:</p> <ul style="list-style-type: none"> • 4 sztuki zacisków stopniowych 14 x 100 mm • 4 sztuki uniwersalnych suwaków stopniowych nr 2 • 4 sztuki uniwersalnych suwaków stopniowych nr 3 • 2 sztuki śrub i wkrętów do rowków teowych zgodn. z DIN 787, długość 50 mm • 4 sztuki śrub i wkrętów do rowków teowych zgodn. z DIN 787, długość 80 mm • 4 sztuki śrub i wkrętów do rowków teowych zgodn. z DIN 787, długość 125 mm • 4 sztuki śrub dwustronnych do rowków teowych zgodn. z DIN 6379, długość 100 mm • 6 sztuk nakrętek sześciokątnych 1,5 d zgodn. z DIN 6330 B • 4 sztuki nakrętek przedłużanych, wysokość 3 x d • 6 sztuk podkładek okrągłych stożkowych zgodn. z ≈ DIN 6319 G • 4 sztuki szczęk zaciskowych niskiej wysokości (w tym śruby z łbem walcowym z gniazdem sześciokątnym zgodn. z DIN 912, klucze do śrub z gniazdem sześciokątnym zgodn. z DIN 911 i nakrętki do rowków teowych zgodn. z DIN 508) • 1 sztuka klucz oczkowy 19 mm 	
M12X14	1	16228.120.014	<p>Zapakowane w drewniane pudełko ze zdejmowaną pokrywą</p> <p>Zawartość:</p> <ul style="list-style-type: none"> • 4 sztuki zacisków stopniowych 14 x 100 mm • 4 sztuki uniwersalnych suwaków stopniowych nr 2 • 4 sztuki uniwersalnych suwaków stopniowych nr 3 • 2 sztuki śrub i wkrętów do rowków teowych zgodn. z DIN 787, długość 50 mm • 4 sztuki śrub i wkrętów do rowków teowych zgodn. z DIN 787, długość 80 mm • 4 sztuki śrub i wkrętów do rowków teowych zgodn. z DIN 787, długość 125 mm • 4 sztuki śrub dwustronnych do rowków teowych zgodn. z DIN 6379, długość 100 mm • 6 sztuk nakrętek sześciokątnych 1,5 d zgodn. z DIN 6330 B • 4 sztuki nakrętek przedłużanych, wysokość 3 x d • 6 sztuk podkładek okrągłych stożkowych zgodn. z ≈ DIN 6319 G • 4 sztuki szczęk zaciskowych niskiej wysokości (w tym śruby z łbem walcowym z gniazdem sześciokątnym zgodn. z DIN 912, klucze do śrub z gniazdem sześciokątnym zgodn. z DIN 911 i nakrętki do rowków teowych zgodn. z DIN 508) • 1 sztuka klucz oczkowy 19 mm • 1 sztuka skrobak do rowków teowych 	
M16X18	1	16228.160.018	<p>Zapakowane w drewnianą skrzynię z odłączaną pokrywą</p> <p>Zawartość:</p> <ul style="list-style-type: none"> • 4 sztuki zacisków stopniowych 18 x 125 mm • 4 sztuki uniwersalnych suwaków stopniowych nr 2 • 4 sztuki uniwersalnych suwaków stopniowych nr 3 • 2 sztuki śrub i wkrętów do rowków teowych zgodn. z DIN 787, długość 63 mm • 4 sztuki śrub i wkrętów do rowków teowych zgodn. z DIN 787, długość 100 mm • 4 sztuki śrub i wkrętów do rowków teowych zgodn. z DIN 787, długość 160 mm • 4 sztuki śruby dwustronne do rowków teowych zgodn. z DIN 6379 długość 125 mm • 6 sztuk nakrętek sześciokątnych 1,5 d zgodn. z DIN 6330 B • 4 sztuki nakrętek przedłużanych, wysokość 3 x d • 6 sztuk podkładek okrągłych stożkowych zgodn. z ≈ DIN 6319 G • 4 sztuki szczęk zaciskowych niskiej wysokości (w tym śruby z łbem walcowym z gniazdem sześciokątnym zgodn. z DIN 912, klucze do śrub z gniazdem sześciokątnym zgodn. z DIN 911 i nakrętki do rowków teowych zgodn. z DIN 508) • 1 sztuka klucz oczkowy 24 mm • 1 sztuka skrobak do rowków teowych 	

Lindapter - Innowacje techniczne w połączeniach konstrukcji stalowych

Łączy stal szybciej bez potrzeby wiercenia czy spawania: łatwe w montażu mocowania Lindapter nadają się do łączenia belek stalowych, sekcji pustych, łączy podwieszanych w budynkach, zabezpieczeń podłogowych i w liniach kolejowych niższej prędkości

• Kluczowe korzyści

- Oszczędność czasu i kosztów pracy
- Użycie jedynie prostych narzędzi bez potrzeby wiercenia czy spawania
- Unikamy pozwoleń do prac wysokotemperaturowych i zamykania budowy
- Połączenia można demontować
- Konstrukcja i powłoka nie niszczy się, można użyć jej ponownie
- Łatwość dostosowania na miejscu
- Akceptacja w czołowych produktach przemysłowych

Zaciski śrubowe

Zaciski śrubowe są elastyczną alternatywą do wiercenia i spawania oszczędzając użytkownikom czas i koszty pracy. Zaciski wirtualnie pasują do każdego kształtu sekcji stalowej i dają bezpieczne, wytrzymałe połączenie otrzymane poprzez prosty zacisk dwóch sekcji razem.

Zaciski HSR (High Slip Resistance)

Zaciski Lindaptera typu HSR są zaprojektowane do wysokich obciążeń jeśli chodzi o tarcie, obciążenie zrywające i kombinowane. Typ AAF jest najnowszą edycją w rodzinie HSR, oferuje elastyczność stosowania, ochronę antykorozyjną i wytrzymałość na wysokie obciążenia, nawet w temperaturze do (-60st C).

Śruby rozprężne Hollo-Bolt

Śruby rozprężne Hollo-Bolt marki Lindapter mają oznaczenie CE i są dostępne w różnych materiałach, długościach i rozmiarach. Trzy główne rodzaje łąba to: 6-kątny, stożkowy i Flush-Fit (chowany) dostępne w średnicach M8 do M12. Do mocniejszych połączeń 6-kątne M16 i M20 są zoptymalizowane by dać zwiększoną siłę zacisku, 3-krotnie większą niż produkt tego rozmiaru bez tego mechanizmu. Hollo-Bolt to jedyne śruby rozprężne wymienione w przewodniku konstrukcyjnym BCSA/SCI "Złącza w konstrukcjach stalowych". Jest też jedyną śrubą rozprężną z pełną aprobatą ICC-ES do użycia we wszystkich konstrukcjach sejsmicznych kategorii A do F.

Śruby rozprężne Hollo-Bolt eliminują potrzebę tradycyjnego montażu przelotowego czy spawania w dowolnych konstrukcjach, gdzie jest dostęp tylko z jednej strony. Śruby Hollo-Bolt mają certyfikację CE jak również aprobatę Deutsches Institute für Bautechnik oraz TÜV Nord.

10

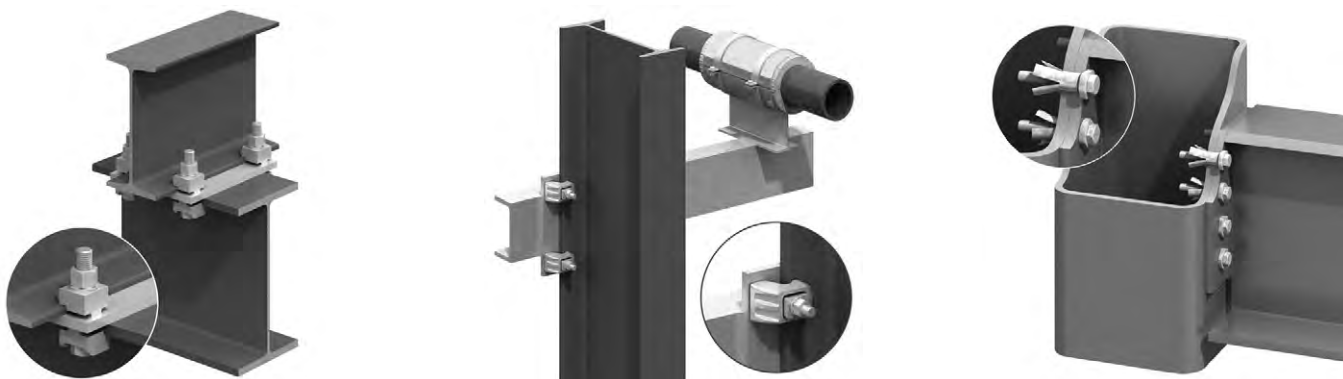

LINDAPTER Hollo-bolt sześciokątna

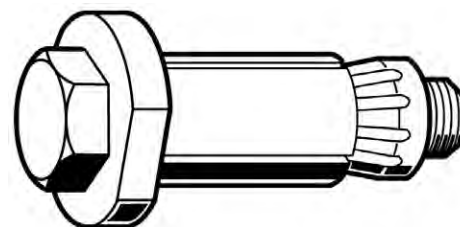
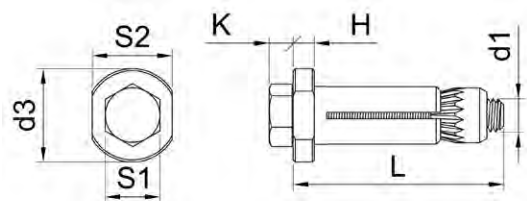

Informacje techniczne

d ₁ x L	M8x50	M8x70	M8x90	M10x55	M10x70	M10x90	M12x60	M12x80	M12x100	M16x75	M16x100	M16x120	M20x90	M20x120	M20x150
d ₃	22	22	22	29	29	29	32	32	32	38	38	38	51	51	51
h	5	5	5	6	6	6	7	7	7	8	8	8	10	10	10
k	5.3	5.3	5.3	6.4	6.4	6.4	7.5	7.5	7.5	10	10	10	12.5	12.5	12.5
Moment dokręcania w Nm	23	23	23	45	45	45	80	80	80	190	190	190	300	300	300
Otwór ø	14	14	14	18	18	18	20	20	20	26	26	26	33	33	33
s ₁	13	13	13	17	17	17	19	19	19	24	24	24	30	30	30
s ₂	19	19	19	24	24	24	30	30	30	36	36	36	46	46	46
Wytrzymałość na rozciąganie w kN (5:1)	4	4	4	8.5	8.5	8.5	10.5	10.5	10.5	21	21	21	35	35	35
Wytrzymałość na ścinanie w kN (5:1)	5	5	5	10	10	10	15	15	15	30	30	30	40	40	40
Zakres uchwytu (maks.)	22	41	60	22	41	60	25	47	69	29	50	71	34	60	86
Zakres uchwytu (min.)	3	22	41	3	22	41	3	25	47	12	29	50	12	34	60

- M8-M10-M12; +1,0/-0,2 / M16-M20; +2,0/-0,2
- Hollo-Bolt jest w prosty sposób montowana przez konstrukcję stalową (zaczynając od końcówki stożkowej) w przygotowanym otworze. Kołnier blokujemy kluczem płaskim i dokręcamy śrubę kluczem dynamometrycznym używając danych z tabeli poniżej.
- Zalecany moment dokręcania wytwarza ograniczoną siłę zacisku przy montażu. Połączenie nie może być porównywane z montażem tradycyjnej śruby/nakrętki.

Kolejność montażu

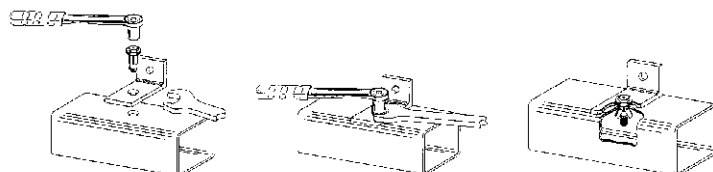

Grupy katalogowe

Gwint	Gniazdo	Materiał	Obróbka powierzchni	Kod	Strona
M	Sześciokąt	St	Ocynk.	61944	10-17
M	Sześciokąt	St	Ocynk. gor.	61945	10-18
M	Sześciokąt	St.St. A4		61946	10-18

61944 LINDAPTER Hollo-Bolt sześciokątna

S02A

Gwint: Metryczny
Materiał: Stal
Obróbka powierzchni: Ocynkowane

Hollo-Bolt

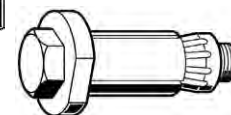

d ₁ x L	☒	Kod artykułu	d ₁ x L	☒	Kod artykułu	d ₁ x L	☒	Kod artykułu
M8X50	100	61944.080.050				M16X100	25	61944.160.100
M8X70	100	61944.080.070	M12X60	50	61944.120.060	M16X120	20	61944.160.120
M8X90	50	61944.080.090	M12X80	25	61944.120.080			
			M12X100	25	61944.120.100	M20X90	10	61944.200.090
M10X55	50	61944.100.055				M20X120	10	61944.200.120
M10X70	50	61944.100.070	M16X75	25	61944.160.075	M20X150	10	61944.200.150
M10X90	50	61944.100.090						

61945	LINDAPTER Hollo-Bolt sześciokątna	S02A
Gwint	Metryczny	
Materiał	Stal	
Obróbka powierzchni	Ocynkowane na gorąco	

$d_1 \times L$	☒	Kod artykułu	$d_1 \times L$	☒	Kod artykułu	$d_1 \times L$	☒	Kod artykułu
M8X50	100	61945.080.050	M12X60	50	61945.120.060	M16X100	25	61945.160.100
M8X70	100	61945.080.070	M12X80	25	61945.120.080	M16X120	20	61945.160.120
M8X90	50	61945.080.090	M12X100	25	61945.120.100	M20X90	10	61945.200.090
M10X55	50	61945.100.055	M16X75	25	61945.160.075	M20X120	10	61945.200.120
M10X70	50	61945.100.070				M20X150	10	61945.200.150
M10X90	50	61945.100.090						

61946	LINDAPTER Hollo-Boltsześciokątna	S02A
Gwint	Metryczny	
Materiał	Stal nierdzewna A4	

$d_1 \times L$	☒	Kod artykułu	$d_1 \times L$	☒	Kod artykułu	$d_1 \times L$	☒	Kod artykułu
M8X50	100	61946.080.050	M12X55	50	61946.120.060	M16X100	25	61946.160.100
M8X70	100	61946.080.070	M12X80	25	61946.120.080	M16X120	20	61946.160.120
M8X90	100	61946.080.090	M12X100	25	61946.120.100	M20X90	10	61946.200.090
M10X50	50	61946.100.055	M16X75	25	61946.160.075	M20X120	10	61946.200.120
M10X70	50	61946.100.070				M20X150	10	61946.200.150
M10X90	50	61946.100.090						

Hollo-bolt łeb płaski z gniazdem sześciokątnym

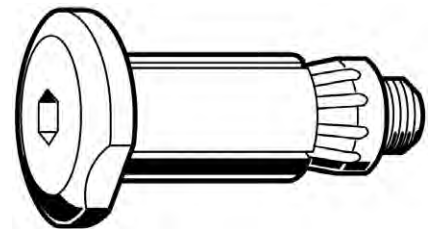
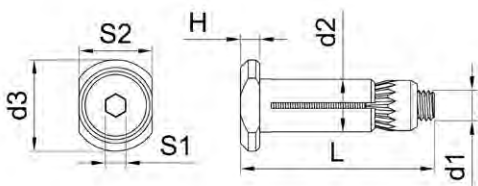

Informacje techniczne

$d_1 \times L$	M8x50	M8x70	M8x90	M10x55	M10x70	M10x90	M12x60	M12x80	M12x100	M16x75	M16x100	M16x120
d_2	14	14	14	18	18	18	20	20	20	26	26	26
d_3	22	22	22	29	29	29	32	32	32	38	38	38
H	5	5	5	6	6	6	7	7	7	8	8	8
Moment dokręcania w Nm	23	23	23	45	45	45	80	80	80	190	190	190
s_1	5	5	5	6	6	6	8	8	8	10	10	10
s_2	19	19	19	24	24	24	30	30	30	36	36	36
Wytrzymałość na rozciąganie w kN (5:1)	4	4	4	8.5	8.5	8.5	10.5	10.5	10.5	21	21	21
Wytrzymałość na ścinanie w kN (5:1)	5	5	5	10	10	10	15	15	15	30	30	30
Zakres uchwytu (maks.)	22	41	60	22	41	60	25	47	69	29	50	71
Zakres uchwytu (min.)	3	22	41	3	22	41	3	25	47	12	29	50

- M8-M10-M12; +1,0/-0,2 / M16; +2,0/-0,2
- Hollo-bolt jest w prosty sposób montowana przez konstrukcje stalową (zaczynając od końcówki stożkowej) w przygotowanym otworze.
- Dopuszczalne obciążenie zrywające. Zastosowanie pod obciążeniem dynamicznym wymaga ostrożnego dokręcania.
- Zalecany moment dokręcania wytwarza ograniczoną siłę zacisku przy montażu. Połączenie nie może być porównywane z montażem tradycyjnej śruby/nakrętki.

Kolejność montażu

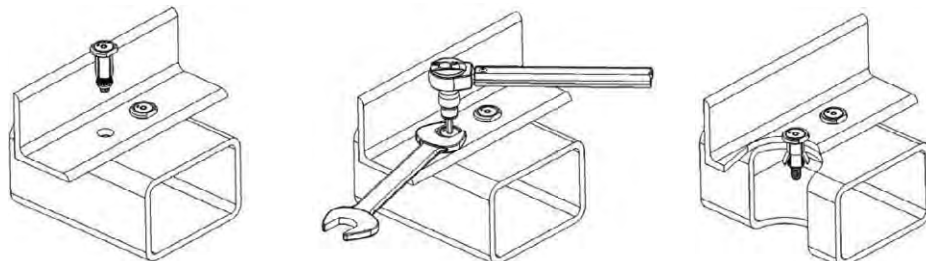

Grupy katalogowe

Gwint	Gniazdo	Materiał	Obróbka powierzchni	Kod	Strona
M	Gniazdo sześciokątne	St	Ocynk.	61952	10-19
M	Gniazdo sześciokątne	St.St. A2		61953	10-19

61952 LINDAPTER Hollo-bolt łeb stożkowy płaski

S02A

Gwint: Metryczny
 Materiał: Stal
 Obróbka powierzchni: Ocynkowane

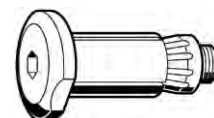

$d_1 \times L$	☒	Kod artykułu	$d_1 \times L$	☒	Kod artykułu	$d_1 \times L$	☒	Kod artykułu
M8X50	100	61952.080.050	M10X70	50	61952.100.070	M12X100	25	61952.120.100
M8X70	100	61952.080.070	M10X90	50	61952.100.090	M16X75	25	61952.160.075
M8X90	50	61952.080.090	M12X60	50	61952.120.060	M16X100	25	61952.160.100
M10X55	50	61952.100.055	M12X80	25	61952.120.080	M16X120	20	61952.160.120

61953 LINDAPTER Hollo-bolt łeb stożkowy płaski

S02A

Gwint: Metryczny
 Materiał: Stal nierdzewna A2

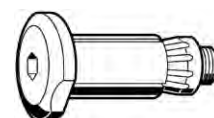

$d_1 \times L$	☒	Kod artykułu	$d_1 \times L$	☒	Kod artykułu	$d_1 \times L$	☒	Kod artykułu
M8X50	100	61953.080.050	M10X70	50	61953.100.070	M12X100	25	61953.120.100
M8X70	100	61953.080.070	M10X90	50	61953.100.090	M16X75	25	61953.160.075
M8X90	100	61953.080.090	M12X60	50	61953.120.060	M16X100	25	61953.160.100
M10X55	50	61953.100.055	M12X80	25	61953.120.080	M16X120	20	61953.160.120

LINDAPTER Hollo-bolt łeb stożkowy z gniazdem sześciokątnym

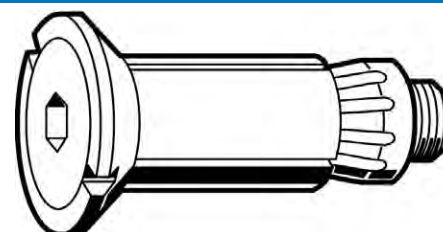
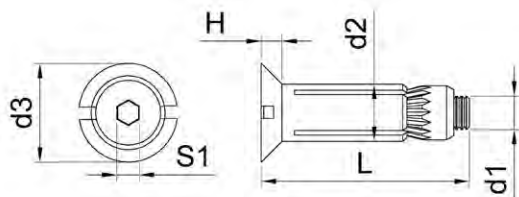





Informacje techniczne

$d_1 \times L$	$d_2 = \varnothing$ wiertła *	d_3	H	Moment dokręcania w Nm	s_1	Wytrzymałość na rozciąganie w kN (5:1)	Wytrzymałość na ścinanie w kN (5:1)	Zakres uchwytu (maks.)	Zakres uchwytu (min.)
M8x50	14	24	5	23	5	4	5	27	10
M10x50	18	30	6	45	6	8.5	10	27	12
M12x55	20	33	7	80	8	10.5	15	30	12

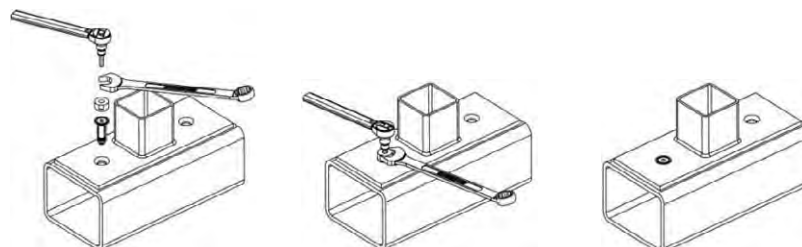
- * M8-M10-M12: +1,0/-0,2
- Do montażu należy stosować narzędzie pomocnicze 61949.
- Hollo-bolt jest w prosty sposób montowana przez konstrukcje stalową w przygotowanym otworze.
- Dopuszczalne obciążenie zrywające. Zastosowanie pod obciążeniem dynamicznym wymaga ostrożnego dokręcania.
- Zalecany moment dokręcania wytwarza ograniczoną siłę zacisku przy montażu. Połączenie nie może być porównywane z montażem tradycyjnej śruby/nakrętki.

Kolejność montażu

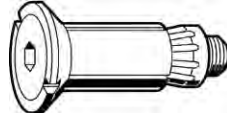

61948 LINDAPTER Hollo-bolt Flush Fit						S02A	
Gwint	Metryczny						
Materiał	Stal						
Obróbka powierzchni	Ocynkowane						
d₁ x L	✉ Kod artykułu	d₁ x L	✉ Kod artykułu	d₁ x L	✉ Kod artykułu		
M8X50	100 61948.080.050	M10X50	50 61948.100.050	M12x55	50 61948.120.055		

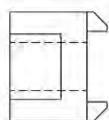
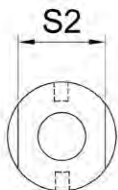

LINDAPTER Hollo-bolt narzędzia



Informacje techniczne

Dla wymiaru nominalnego	s₂
M8	19
M10	24
M12	30

- Narzędzia dla Hollo-bolt 61948.

61949 LINDAPTER Hollo-bolt narzędzia						S02A	
Materiał	Stal						
Obróbka powierzchni	Ocynkowane						
							
Dla wymiaru nominalnego	✉ Kod artykułu	Dla wymiaru nominalnego	✉ Kod artykułu	Dla wymiaru nominalnego	✉ Kod artykułu		
M8	1 61949.080.001	M10	1 61949.100.001	M12	1 61949.120.001		

Systemy zaciskowe

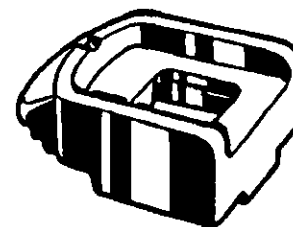

Grupy katalogowe

Material	Obróbka powierzchni		Kod	Strona
Żel	Ocynk.	A krótki	61015	10-21
Żel	Ocynk. gor.	A krótki	61020	10-21
Żel	Ocynk.	A średni	61035	10-21
Żel	Ocynk. gor.	A średni	61040	10-22
Żel	Ocynk.	A długi	61055	10-22
Żel	Ocynk. gor.	A długi	61060	10-22
Żel	Ocynk.	B krótki	61115	10-22
Żel	Ocynk. gor.	B krótki	61120	10-22
Żel	Ocynk.	B średni	61135	10-23
Żel	Ocynk. gor.	B średni	61140	10-23
Żel	Ocynk.	B długi	61155	10-23
Żel	Ocynk. gor.	B długi	61165	10-23
Żeliwo sferoidalne	Ocynk. gor.	AF krótki	61170	10-23
Żeliwo sferoidalne	Ocynk. gor.	AF średni	61180	10-24

61015 LINDAPTER Mocowania konstrukcji stalowych, Typ A krótki

S05A

Material Żeliwo
Obróbka powierzchni Ocynkowane

lindapter



Dla rozmiaru śruby	☒	Kod artykułu	Dla rozmiaru śruby	☒	Kod artykułu	Dla rozmiaru śruby	☒	Kod artykułu
M10	100	61015.100.001	M16	50	61015.160.001	M24	20	61015.240.001
M12	100	61015.120.001	M20	50	61015.200.001			

- Z wgłębieniem, nachylenie maks. 8°.

61020 LINDAPTER Mocowania konstrukcji stalowych, Typ A krótki

S05A

Material Żeliwo
Obróbka powierzchni Ocynkowane na gorąco

lindapter



Dla rozmiaru śruby	☒	Kod artykułu	Dla rozmiaru śruby	☒	Kod artykułu	Dla rozmiaru śruby	☒	Kod artykułu
M10	100	61020.100.001	M16	50	61020.160.001	M24	20	61020.240.001
M12	100	61020.120.001	M20	50	61020.200.001			

- Z wgłębieniem, nachylenie maks. 8°.

61035 LINDAPTER Mocowania konstrukcji stalowych, Typ A średni

S05A

Material Żeliwo
Obróbka powierzchni Ocynkowane

lindapter



Dla rozmiaru śruby	☒	Kod artykułu	Dla rozmiaru śruby	☒	Kod artykułu	Dla rozmiaru śruby	☒	Kod artykułu
M10	100	61035.100.001	M16	50	61035.160.001	M24	20	61035.240.001
M12	100	61035.120.001	M20	50	61035.200.001			

- Z wgłębieniem, nachylenie maks. 8°.

10

61040 LINDAPTER Mocowania konstrukcji stalowych, Typ A średni S05A

Materiał Żeliwo
Obróbka powierzchni Ocynkowane na gorąco

Dla rozmiaru śruby	☒	Kod artykułu	Dla rozmiaru śruby	☒	Kod artykułu	Dla rozmiaru śruby	☒	Kod artykułu
M10	100	61040.100.001	M16	50	61040.160.001	M24	10	61040.240.001
M12	100	61040.120.001	M20	50	61040.200.001			

- Z wgłębieniem, nachylenie maks. 8°.

61055 LINDAPTER Mocowania konstrukcji stalowych, Typ A długi S05A

Materiał Żeliwo
Obróbka powierzchni Ocynkowane

Dla rozmiaru śruby	☒	Kod artykułu	Dla rozmiaru śruby	☒	Kod artykułu	Dla rozmiaru śruby	☒	Kod artykułu
M10	100	61055.100.001	M16	50	61055.160.001	M24	20	61055.240.001
M12	100	61055.120.001	M20	50	61055.200.001			

- Z wgłębieniem, nachylenie maks. 8°.

61060 LINDAPTER Mocowania konstrukcji stalowych, Typ A długi S05A

Materiał Żeliwo
Obróbka powierzchni Ocynkowane na gorąco

Dla rozmiaru śruby	☒	Kod artykułu	Dla rozmiaru śruby	☒	Kod artykułu	Dla rozmiaru śruby	☒	Kod artykułu
M10	100	61060.100.001	M16	50	61060.160.001	M24	10	61060.240.001
M12	100	61060.120.001	M20	50	61060.200.001			

- Z wgłębieniem, nachylenie maks. 8°.

61115 LINDAPTER Mocowania konstrukcji stalowych, Typ B krótki S05A

Materiał Żeliwo
Obróbka powierzchni Ocynkowane

Dla rozmiaru śruby	☒	Kod artykułu	Dla rozmiaru śruby	☒	Kod artykułu	Dla rozmiaru śruby	☒	Kod artykułu
M10	100	61115.100.001	M16	50	61115.160.001	M24	20	61115.240.001
M12	100	61115.120.001	M20	25	61115.200.001			

- Z płaskim łbem, nachylenie maks. 8°.

61120 LINDAPTER Mocowania konstrukcji stalowych, Typ B krótki S05A

Materiał Żeliwo
Obróbka powierzchni Ocynkowane na gorąco

Dla rozmiaru śruby	☒	Kod artykułu	Dla rozmiaru śruby	☒	Kod artykułu	Dla rozmiaru śruby	☒	Kod artykułu
M10	100	61120.100.001	M16	50	61120.160.001	M24	20	61120.240.001
M12	100	61120.120.001	M20	25	61120.200.001			

- Z płaskim łbem, nachylenie maks. 8°.

61135 LINDAPTER Mocowania konstrukcji stalowych, Typ B średni S05A

Materiał Żeliwo
Obróbka powierzchni Ocynkowane

Dla rozmiaru śruby	☒	Kod artykułu	Dla rozmiaru śruby	☒	Kod artykułu	Dla rozmiaru śruby	☒	Kod artykułu
M10	100	61135.100.001	M16	50	61135.160.001	M24	20	61135.240.001
M12	100	61135.120.001	M20	25	61135.200.001			

- Z płaskim łbem, nachylenie maks. 8°.

61140 LINDAPTER Mocowania konstrukcji stalowych, Typ B średni S05A

Materiał Żeliwo
Obróbka powierzchni Ocynkowane na gorąco

Dla rozmiaru śruby	☒	Kod artykułu	Dla rozmiaru śruby	☒	Kod artykułu	Dla rozmiaru śruby	☒	Kod artykułu
M10	100	61140.100.001	M16	50	61140.160.001	M24	10	61140.240.001
M12	100	61140.120.001	M20	25	61140.200.001			

- Z płaskim łbem, nachylenie maks. 8°.

61155 LINDAPTER Mocowania konstrukcji stalowych, Typ B długi S05A

Materiał Żeliwo
Obróbka powierzchni Ocynkowane

Dla rozmiaru śruby	☒	Kod artykułu	Dla rozmiaru śruby	☒	Kod artykułu	Dla rozmiaru śruby	☒	Kod artykułu
M10	100	61155.100.001	M16	50	61155.160.001	M24	20	61155.240.001
M12	100	61155.120.001	M20	25	61155.200.001			

- Z płaskim łbem, nachylenie maks. 8°.

61165 LINDAPTER Mocowania konstrukcji stalowych, Typ B długi S05A

Materiał Żeliwo
Obróbka powierzchni Ocynkowane na gorąco

Dla rozmiaru śruby	☒	Kod artykułu	Dla rozmiaru śruby	☒	Kod artykułu	Dla rozmiaru śruby	☒	Kod artykułu
M10	100	61165.100.001	M16	50	61165.160.001	M24	20	61165.240.001
M12	100	61165.120.001	M20	25	61165.200.001			

- Z płaskim łbem, nachylenie maks. 8°.

61170 LINDAPTER Mocowania konstrukcji stalowych, Typ AF krótki S05A

Materiał Żeliwo sferoidalne
Obróbka powierzchni Ocynkowane na gorąco

Dla rozmiaru śruby	☒	Kod artykułu	Dla rozmiaru śruby	☒	Kod artykułu	Dla rozmiaru śruby	☒	Kod artykułu
M12	25	61170.120.001	M20	10	61170.200.001	M24	5	61170.240.001
M16	10	61170.160.001						

- Z płaskim łbem, nachylenie maks. 10°.

61180 LINDAPTER Mocowania konstrukcji stalowych, Typ AF średni S05A

Materiał Żeliwo sferoidalne
Obróbka powierzchni Ocynkowane na gorąco

lindapter



Dla rozmiaru śruby	☒	Kod artykułu	Dla rozmiaru śruby	☒	Kod artykułu	Dla rozmiaru śruby	☒	Kod artykułu
M12	25	61180.120.001	M20	10	61180.200.001	M24	5	61180.240.001
M16	20	61180.160.001						

- Z płaskim łbem, nachylenie maks. 10°.

Zacisk wysokiej wytrzymałości



61450 LINDAPTER zacisk AAF S05A

Materiał Żeliwo sferoidalne
Obróbka powierzchni Ocynkowane na gorąco

lindapter



d	☒	Kod artykułu	d	☒	Kod artykułu	d	☒	Kod artykułu
M12	20	61450.120.001	M16	10	61450.160.001	M20	4	61450.200.001

Podpórki

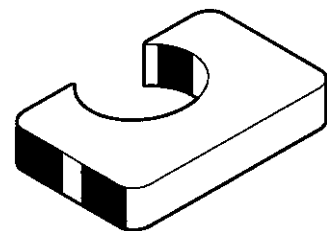

Grupy katalogowe

Material	Obróbka powierzchni		Kod	Strona
St	Ocynk.	CW	61415	10-25
St	Ocynk. gor.	typ CW	61420	10-25
St	Ocynk.	P1 krótki	61515	10-25
St	Ocynk. gor.	P1 krótki	61530	10-25
St	Ocynk.	P2 krótki	61615	10-25
St	Ocynk. gor.	P2 krótki	61630	10-26
St	Ocynk. gor.	typ AF/CW	61430	10-26
St	Ocynk. gor.	typ AF/P1	61435	10-26
St	Ocynk. gor.	typ AF/P2	61440	10-26
St	Ocynk.	P1 długi	61555	10-26
St	Ocynk. gor.	P1 długi	61570	10-27
Cl	Ocynk.	P2 długi	61650	10-27
Cl	Ocynk. gor.	P2 długi	61670	10-27

61415 LINDAPTER Podkładki zaciskane, Typ CW S05A

Materiał: Stal
Obróbka powierzchni: Ocynkowane

lindapter

Dla rozmiaru śruby	Kod artykułu	Dla rozmiaru śruby	Kod artykułu	Dla rozmiaru śruby	Kod artykułu
M10	250 61415.100.001	M16	250 61415.160.001	M24	100 61415.240.001
M12	250 61415.120.001	M20	100 61415.200.001		

• Odpowiednie do mocowań konstrukcji stalowych typ A, B i BR.

61420 LINDAPTER Podkładki zaciskane, Typ CW S05A

Materiał: Stal
Obróbka powierzchni: Ocynkowane na gorąco

lindapter

Dla rozmiaru śruby	Kod artykułu	Dla rozmiaru śruby	Kod artykułu	Dla rozmiaru śruby	Kod artykułu
M10	250 61420.100.001	M16	250 61420.160.001	M24	100 61420.240.001
M12	250 61420.120.001	M20	100 61420.200.001		

• Odpowiednie do mocowań konstrukcji stalowych typ A, B i BR.

61515 LINDAPTER Podkładki, Typ P1 krótki S05A

Materiał: Stal
Obróbka powierzchni: Ocynkowane

lindapter

d	Kod artykułu	d	Kod artykułu	d	Kod artykułu
M10	250 61515.100.001	M16	100 61515.160.001	M24	25 61515.240.001
M12	200 61515.120.001	M20	100 61515.200.001		

• Odpowiednie do mocowań konstrukcji stalowych typ A, B i BR.

61530 LINDAPTER Podkładki, Typ P1 krótki S05A

Materiał: Stal
Obróbka powierzchni: Ocynkowane na gorąco

lindapter

d	Kod artykułu	d	Kod artykułu	d	Kod artykułu
M10	250 61530.100.001	M16	100 61530.160.001	M24	25 61530.240.001
M12	200 61530.120.001	M20	100 61530.200.001		

• Odpowiednie do mocowań konstrukcji stalowych typ A, B i BR.

61615 LINDAPTER Podkładki, Typ P2 krótki S05A

Materiał: Stal
Obróbka powierzchni: Ocynkowane

lindapter

d	Kod artykułu	d	Kod artykułu	d	Kod artykułu
M10	100 61615.100.001	M16	100 61615.160.001	M24	25 61615.240.001
M12	100 61615.120.001	M20	50 61615.200.001		

• Odpowiednie do mocowań konstrukcji stalowych typ A, B i BR.

61630 LINDAPTER Podkładki, Typ P2 krótki S05A

Materiał Stal
Obróbka powierzchni Ocynkowane na gorąco

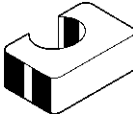

d	☒	Kod artykułu	d	☒	Kod artykułu	d	☒	Kod artykułu
M10	100	61630.100.001	M16	100	61630.160.001	M24	25	61630.240.001
M12	100	61630.120.001	M20	50	61630.200.001			

- Odpowiednie do mocowań konstrukcji stalowych typ A, B i BR.

61430 LINDAPTER Podkładki zaciskowe, Typ AF/CW S05A

Materiał Stal
Obróbka powierzchni Ocynkowane na gorąco



Dla rozmiaru śruby	☒	Kod artykułu	Dla rozmiaru śruby	☒	Kod artykułu	Dla rozmiaru śruby	☒	Kod artykułu
M12	250	61430.120.001	M16	200	61430.160.001	M20	200	61430.200.001

- Odpowiednie do zacisków o wysokim tarciu, typ AF.

61435 LINDAPTER Podkładki, Typ AF/P1 S05A

Materiał Stal
Obróbka powierzchni Ocynkowane na gorąco



d	☒	Kod artykułu	d	☒	Kod artykułu	d	☒	Kod artykułu
M12	100	61435.120.001	M20	50	61435.200.001	M24	25	61435.240.001
M16	100	61435.160.001						

- Odpowiednie do zacisków o wysokim tarciu, typ AF.

61440 LINDAPTER Podkładki, Typ AF/P2 S05A

Materiał Stal
Obróbka powierzchni Ocynkowane na gorąco



d	☒	Kod artykułu	d	☒	Kod artykułu	d	☒	Kod artykułu
M12	50	61440.120.001	M20	10	61440.200.001	M24	10	61440.240.001
M16	50	61440.160.001						

- Odpowiednie do zacisków o wysokim tarciu, typ AF.

61555 LINDAPTER Podkładki, Typ P1 długi S05A

Materiał Stal
Obróbka powierzchni Ocynkowane



d	☒	Kod artykułu	d	☒	Kod artykułu	d	☒	Kod artykułu
M10	100	61555.100.001	M16	100	61555.160.001	M24	25	61555.240.001
M12	100	61555.120.001	M20	50	61555.200.001			

- Odpowiednie do konstrukcji stalowych typ D1, D2 i LR.

61570 LINDAPTER Podkładki, Typ P1 długi S05A

Materiał Stal
Obróbka powierzchni Ocynkowane na gorąco





d	☒	Kod artykułu	d	☒	Kod artykułu	d	☒	Kod artykułu
M12	100	61570.120.001	M20	50	61570.200.001	M24	25	61570.240.001
M16	100	61570.160.001						

- Odpowiednie do mocowań konstrukcji stalowych typ D1, D2 i LR.

61650 LINDAPTER Podkładki, Typ P2 długi S05A

Materiał Żeliwo
Obróbka powierzchni Ocynkowane





d	☒	Kod artykułu	d	☒	Kod artykułu	d	☒	Kod artykułu
M10	100	61650.100.001	M16	50	61650.160.001	M24	25	61650.240.001
M12	100	61650.120.001	M20	10	61650.200.001			

- Odpowiednie do mocowań konstrukcji stalowych typ D2 i LR.

61670 LINDAPTER Podkładki, Typ P2 długi S05A

Materiał Żeliwo
Obróbka powierzchni Ocynkowane na gorąco





d	☒	Kod artykułu	d	☒	Kod artykułu	d	☒	Kod artykułu
M12	100	61670.120.001	M20	25	61670.200.001	M24	20	61670.240.001
M16	100	61670.160.001						

- Odpowiednie do mocowań konstrukcji stalowych typ D2 i LR.

Podkładki głębokie do mocowania w konstrukcjach stalowych i do wypełniania wgłębień

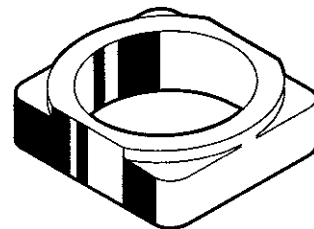

61810	LINDAPTER Podkładki głębokie Typu W	S05A
Materiał	Żeliwo	
Obróbka powierzchni	Ocynkowane	

d	☒	Kod artykułu	d	☒	Kod artykułu	d	☒	Kod artykułu
M10	1000	61810.100.001	M16	500	61810.160.001	M20	250	61810.200.001
M12	500	61810.120.001						

- Odpowiednie do mocowań konstrukcji stalowych typ A i D2.
- Do wypełniania wgłębienia.

Zacisk o wysokim tarciu

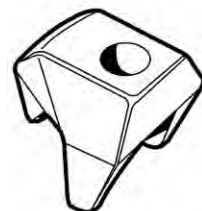

61265	LINDAPTER Zacisk o wysokim tarciu Typ CF	S05A
Materiał	Żeliwo sferoidalne	
Obróbka powierzchni	Ocynkowane na gorąco	

d	☒	Kod artykułu	d	☒	Kod artykułu	d	☒	Kod artykułu
M12	25	61265.120.001	M16	20	61265.160.001	M20	10	61265.200.001

Zacisk samoregulacyjny

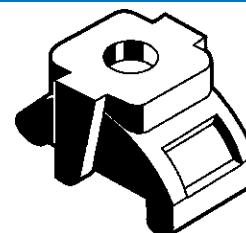

Grupy katalogowe

Material	Obróbka powierzchni	Kod	Strona
Żel	Ocynk.	61951	10-29
Żel	Ocynk. gor.	61961	10-29

61951 LINDAPTER zacisk samoregulacyjny typ LR		S05A	
Material	Żeliwo		
Obróbka powierzchni	Ocynkowane		

d	☒	Kod artykułu	d	☒	Kod artykułu	d	☒	Kod artykułu
M10	50	61951.100.001	M16	25	61951.160.001	M24	5	61951.240.001
M12	50	61951.120.001	M20	10	61951.200.001			

61961 LINDAPTER zacisk samoregulacyjny typ LR		S05A	
Material	Żeliwo		
Obróbka powierzchni	Ocynkowane na gorąco		

d	☒	Kod artykułu	d	☒	Kod artykułu	d	☒	Kod artykułu
10MM	50	61961.100.001	16MM	25	61961.160.001	24MM	5	61961.240.001
12MM	100	61961.120.001	20MM	10	61961.200.001			

Zaciski z regulowaną końcówką i śrubą dociskową

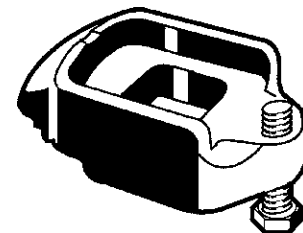

Grupy katalogowe

Material	Obróbka powierzchni	Kod	Strona
Żel	Ocynk.	61290	10-30
Żel	Ocynk. gor.	61300	10-30

61290 LINDAPTER Zaciski z regulowaną końcówką i śrubą dociskową, Typ D2 S05A

Material Żeliwo
Obróbka powierzchni Ocynkowane

lindapter

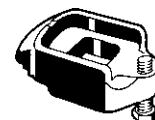

d	☒	Kod artykułu	d	☒	Kod artykułu	d	☒	Kod artykułu
M10	100	61290.100.001	M16	50	61290.160.001	M20	25	61290.200.001
M12	100	61290.120.001						

- Z wgłębieniem i nastawną końcówką.

61300 LINDAPTER Zaciski z regulowaną końcówką i śrubą dociskową, Typ D2 S05A

Material Żeliwo
Obróbka powierzchni Ocynkowane na gorąco

lindapter

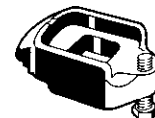

d	☒	Kod artykułu	d	☒	Kod artykułu	d	☒	Kod artykułu
M10	100	61300.100.001	M16	50	61300.160.001	M20	25	61300.200.001
M12	100	61300.120.001						

- Z wgłębieniem i nastawną końcówką.

Zaciski do mocowania poręczy

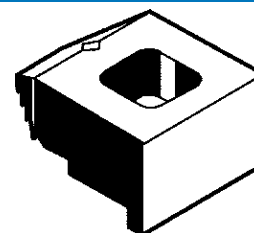

Grupy katalogowe

Material	Obróbka powierzchni		Kod	Strona
Żel	Ocynk.	BR krótki	61936	10-31
Żel	Ocynk.	BR średni	61937	10-31
Żel	Ocynk. gor.	BR krótki	61938	10-31
Żel	Ocynk. gor.	BR średni	61939	10-31

61936 LINDAPTER Zaciski do mocowania poręczy, Typ BR krótki S05A

Material: Żeliwo
Obróbka powierzchni: Ocynkowane

d	✉	Kod artykułu	d	✉	Kod artykułu	d	✉	Kod artykułu
M12	100	61936.120.001	M16	50	61936.160.001	M20	25	61936.200.001

- Z płaska górną powierzchnią, nachylenie maks. 8°.

61937 LINDAPTER Zaciski do mocowania poręczy, Typ BR średni S05A

Material: Żeliwo
Obróbka powierzchni: Ocynkowane

d	✉	Kod artykułu	d	✉	Kod artykułu	d	✉	Kod artykułu
M12	100	61937.120.001	M16	50	61937.160.001	M20	25	61937.200.001

- Z płaska górną powierzchnią, nachylenie maks. 8°.

61938 LINDAPTER Zaciski do mocowania poręczy, Typ BR krótki S05A

Material: Żeliwo
Obróbka powierzchni: Ocynkowane na gorąco

d	✉	Kod artykułu	d	✉	Kod artykułu	d	✉	Kod artykułu
M12	100	61938.120.001	M16	50	61938.160.001	M20	25	61938.200.001

- Z płaska górną powierzchnią, nachylenie maks. 8°.

61939 LINDAPTER Zaciski do mocowania poręczy, Typ BR średni S05A

Material: Żeliwo
Obróbka powierzchni: Ocynkowane na gorąco

d	✉	Kod artykułu	d	✉	Kod artykułu	d	✉	Kod artykułu
M12	100	61939.120.001	M16	50	61939.160.001	M20	25	61939.200.001

- Z płaska górną powierzchnią, nachylenie maks. 8°.

Zaciski do stóp belek

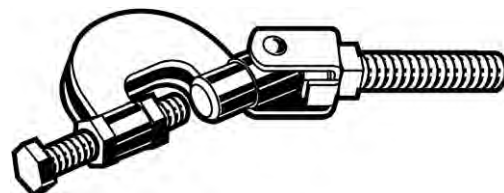

Grupy katalogowe

Materiał	Obróbka powierzchni		Kod	Strona
Żeliwo sferoidalne	Ocynk.	FLS	61860	10-32
Żel	Ocynk.	LC	61317	10-32
Żel	Ocynk.	FL	61355	10-32
Żel	Ocynk. gor.	F3	61390	10-32

61860 LINDAPTER Zaciski do stóp belek, Typ FLS S05A

Materiał Żeliwo sferoidalne
Obróbka powierzchni Ocynkowane

lindapter



Dla pręta dołączanego/ nr typu	✉	Kod artykułu	Dla pręta dołączanego/ nr typu	✉	Kod artykułu
M8	25	61860.080.001	M10	25	61860.100.001

61317 LINDAPTER Zaciski do stóp belek, Typ LC ze śrubą dociskową i nakrętką S05A

Materiał Żeliwo
Obróbka powierzchni Ocynkowane

lindapter



Dla pręta dołączanego/ nr typu	✉	Kod artykułu
M6	100	61317.060.001

Do zamocowań pionowych i poziomych.

61355 LINDAPTER Zaciski do stóp belek, Typ FL ze śrubą dociskową i nakrętką S05A

Materiał Żeliwo
Obróbka powierzchni Ocynkowane

lindapter



Dla pręta dołączanego/ nr typu	✉	Kod artykułu	Dla pręta dołączanego/ nr typu	✉	Kod artykułu	Dla pręta dołączanego/ nr typu	✉	Kod artykułu
M8 FL1	100	61355.080.001	M12 FL3	50	61355.120.001	M12 FL4	25	61355.120.004
M10 FL2	50	61355.100.001						

- Zatwierdzone przez VdS i FM.

61390 LINDAPTER Zaciski uniwersalne do stóp belek, Typ F3 S05A

Materiał Żeliwo
Obróbka powierzchni Ocynkowane na gorąco

lindapter

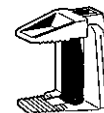

Dla pręta dołączanego/ nr typu	✉	Kod artykułu	Dla pręta dołączanego/ nr typu	✉	Kod artykułu
M12	25	61390.120.001	M16	10	61390.160.001

- Zatwierdzone przez FM.

Zaciski czołowe

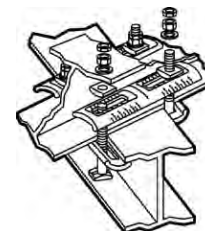

Informacje techniczne

Wymiar nominalny	M16
Grubość/nastawność stopki belki	5-19
Maks. obciążenie w kN (5:1)	30
Moment dokręcania w Nm	147
Szerokość/nastawność stopki belki	75-180

- ZACISK CZOŁOWY to regulowany system zaciskowy łączący ramiona dwóch stalowych belek bez zastosowania płytki lokalizacyjnej. System ten tworzy zacisk umożliwiający łączenie belek o różnej szerokości i grubości kształownika.
- Zawartość zestawu ZACISKÓW CZOŁOWYCH: po 4 sztuki każdego z sześciu podstawowych elementów: specjalny korpus, specjalne śruby, specjalne podkładki, płaskie podkładki, nakrętki sześciokątne i pół-nakrętki.

Przykład zastosowania



61850 LINDAPTER Zaciski czołowe

S05A

Gwint	Metryczny
Materiał	Stal
Obróbka powierzchni	Ocynkowane

lindapter

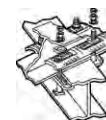

Wymiar nominalny Kod artykułu

M16 1 [61850.160.001](#)

Mocowania podłogowe

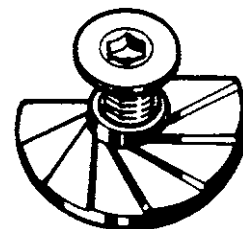
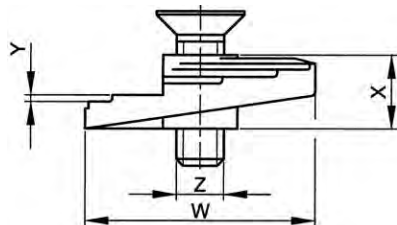

Informacje techniczne

Z	W	X	Y
M8	60	20	2
M10	60	20	2
M12	60	20	2

- MOCOWANIA PODŁOGOWE, umożliwiające mocowanie od góry stalowych blach podłogowych, przez jednego człowieka, przy pomocy zwykłego klucza sześciokątnego z rączką w kształcie T.
- Nie potrzeba dostępu od spodu, nie trzeba też żadnego wiercenia ani miejscowego zgrzewania.

Przykład zastosowania



Grupy katalogowe

Gwint	Materiał	Obróbka powierzchni	Kod	Strona
M	Żel	Ocynk.	61941	10-34
M	Żel	Ocynk. gor.	61963	10-34

61941	LINDAPTER Mocowania podłogowe	S05A
Gwint	Metryczny	
Materiał	Żeliwo	
Obróbka powierzchni	Ocynkowane	

Z	☒	Kod artykułu	Z	☒	Kod artykułu	Z	☒	Kod artykułu
M8	50	61941.080.001	M10	50	61941.100.001	M12	50	61941.120.001

Dostępny również w stali nierdzewnej Grade 316

61963	LINDAPTER Mocowania podłogowe	S05A
Gwint	Metryczny	
Materiał	Żeliwo	
Obróbka powierzchni	Ocynkowane na gorąco	

Z	☒	Kod artykułu
10MM	100	61963.100.001

Dostępny również w stali nierdzewnej Grade 316

Zaciski GF 3030

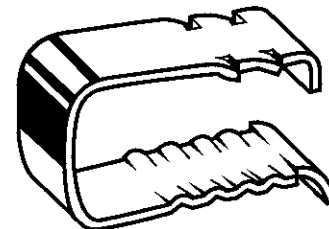
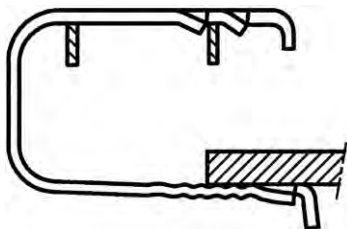

Informacje techniczne

Typ	GF3030
Siła zaciskania na zacisk. w N	340-530-680
Łączna grubość zaciskania	38-43-48

- GF 3030 to przełomowy produkt pozwalający na łączenie kratki podłogowych 30 x 30 w stylu Europejskim do stalowych profili. Zaletą produktu polega na jego metodzie instalacyjnej, która może zostać przeprowadzona tylko przez jedną osobę, mocując od góry, bez konieczności wiercenia ani zgrzewania. Zapewnia to nie tylko znaczące oszczędności, ale pozwala również na zachowanie integralności istniejących konstrukcji stalowych. GF 3030 zostały zaprojektowane specjalnie do zastosowania z kratkami podłogowymi o głębokości 30 mm. Jest jednakże możliwe zastosowanie produktu dla innej głębokości kratki, pod warunkiem, że łączna głębokość mocowania (głębokość kratki + grubość stopki belki konstrukcji stalowej) mieści się między 38 mm (minimum) a 48 mm (maksimum). Zakres grubości stopki belki konstrukcji stalowej to 8-18 mm.
- Cynkowanie dyfuzyjne zgodn. z BS 4921 Klasa 1 (380°C maks.) plus pasywacja i jedna powłoka srebrnego Delta Seal.

Dane montażowe

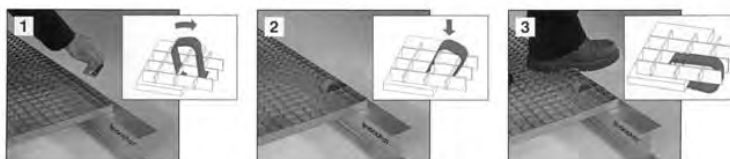

61942 LINDAPTER Zaciski GF 3030

S05A

Materiał Stal sprężynowa
Obróbka powierzchni Sheraplex

lindapter

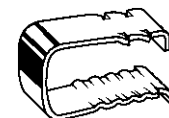

Typ	✉	Kod artykułu
GF 3030	50	61942.001.770

Siodła (obejmy)

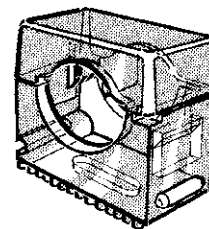
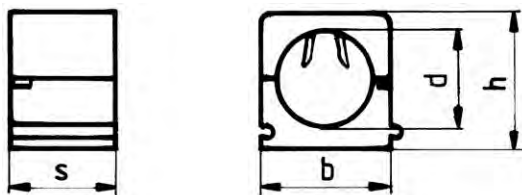

Informacje techniczne

Typ	b	h	s	Siła wyciągająca w N	Średnica przewodu/rury d
SCH 812	21.5	23.1	16.5	0.09	8-12
SCH 1216	27.5	28.7	16.5	0.2	12-16
SCH 1619	32.5	37.6	16.5	0.2	16-19
SCH 1623	36	37.6	16.5	0.2	16-23
SCH 2332	46.5	50	16.5	0.3	23-32
SCH 3242	53.5	62	16.5	0.4	32-42

- Połączenie boczne może zostać rozszerzone do 4 obejm w linii.
- Siła wyciągająca (siła rozrywająca) wymagana do zerwania nasadki obejmy. Zaleca się wzięcie współczynnika bezpieczeństwa: ≥ 7 .

Kolejność montażu

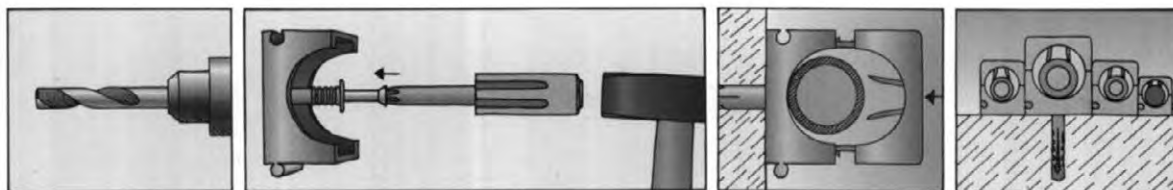

63500 FISCHER Siodła (obejmy), typ SCH

N03B

Materiał Plastik Poliamid (nylon)

fischer
innovative solutions

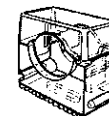

Typ	☒	Kod artykułu	Typ	☒	Kod artykułu	Typ	☒	Kod artykułu
SCH 8-12MM	100	63500.008.013	SCH 16-19MM	50	63500.016.019	23-32MM	25	63500.023.032
SCH 12-16MM	50	63500.012.016	SCH 16-23MM	50	63500.016.023	32-42MM	25	63500.032.042

Zacisk rurowy

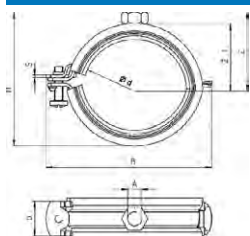

Informacje techniczne

Ø d	A	B	b x s	H	h	N	Rozmiar rury	Rozmiar śruby
15-19	M8	52	20x1.25	40	6.8	0.60	3/8	M5x25
20-24	M8	58	20x1.25	45	6.8	0.60	1/2	M5x25
25-30	M8	63	20x1.25	49	6.8	0.60	3/4	M5x25
32-37	M8	72	20x1.25	57	6.8	0.8	1 Inch	M5x25
40-45	M8	79	20x1.5	66	6.8	0.8	1.1/4	M5x30
48-53	M8	88	20x1.5	76	6.8	0.8	1.1/2	M5x30
59-63	M8	99	20x1.5	85	6.8	0.8	2 Inch	M5x30

- N = Max.rekomend. Obciążenie statyczne (rozciąganie centr.) [kN].

Kolejność montażu

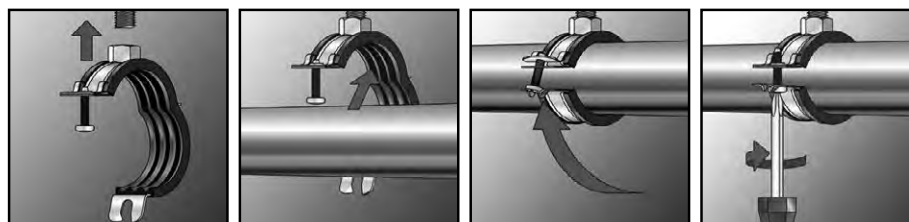

- Wprowadź rurę, zaciśnij opaskę i mocno przykręć śrubą.

64100 FISCHER Zaciski rurowe FGRS Plus

N02A

Materiał Stal DD11

fischer
innovative solutions



Zakres uchwytu	☒	Kod artykułu	Zakres uchwytu	☒	Kod artykułu	Zakres uchwytu	☒	Kod artykułu
15-19	100	64100.015.019	32-37	100	64100.032.037	48-53	50	64100.048.053
20-24	100	64100.020.024	40-45	50	64100.040.045	59-63	50	64100.059.063
25-30	100	64100.025.030						

- Jednoczęściowa, przegubowa opaska nośna.
- Opatentowany zamek z szybkonaśtownym mechanizmem umożliwia łatwe i szybkie mocowanie rur.
- Materiał : Stal DD11 (nr 1.0332) zgodny z DIN EN 10111
- Pokrycie : Ocynk 5-9 µm
- Obciążenie użytkowe, wzdłuż osi mocowania: 800 N
- Wkład tłumiący dźwięki: Materiał: SBR/EPDM
- Izolacja dźwiękowa: wg DIN 4109
- Zakres temperatury: -50° do +110 °C
- Twardość: 45 ± 5° Shore A
- Zachowanie w razie pożaru: wg DIN 4102: klasa B2

Zacisk rurowy

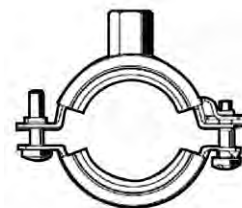
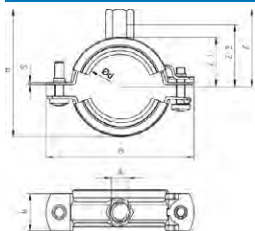

Informacje techniczne

ø d	A	B	b x s	H	h	N	Rozmiar rury	Rozmiar śruby
15-19	M8/M10	61	20x1.25	51	17	0.8	3/8	M5x25
20-24	M8/M10	66	20x1.25	56	17	0.8	1/2	M5x25
25-30	M8/M10	72	20x1.25	62	17	0.8	3/4	M5x25
32-37	M8/M10	79	20x1.25	67	17	0.8	1 Inch	M5x25
40-45	M8/M10	86	20x1.25	78	17	1.00	1.1/4	M5x30
48-53	M8/M10	94	20x1.5	83	17	1.00	1.1/2	M5x30
59-63	M8/M10	114	20x1.5	96	17	1.40	2 Inch	M6x30
62-64	M8/M10	114	25x2.0	96	17	1.40	-	M6x30
68-73	M8/M10	124	25x2.0	108	17	1.40	-	M6x30
74-78	M8/M10	129	25x2.0	113	17	1.80	2.1/2	M6x30
80-86	M8/M10	133	25x2.0	115	17	1.80	-	M6x30
89-92	M8/M10	142	25x2.0	125	17	1.80	3 Inch	M6x30
95-103	M8/M10	156	25x2.0	140	17	1.80	-	M6x30

- N = Max.rekomend. Obciążenie statyczne (rozciąganie centr.) [kN].

Kolejność montażu

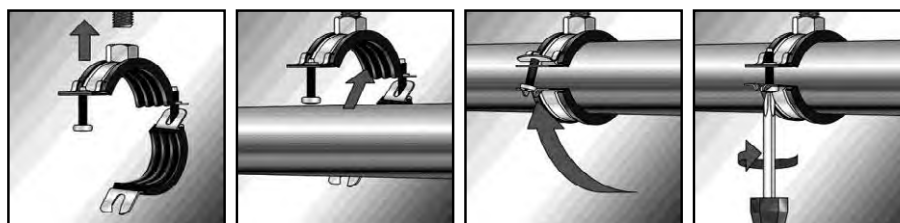

- Wprowadź rurę, zaciśnij opaskę i mocno przykręć śrubą.

64108 FISCHER Zaciski rurowe FRS Plus

N02A

Materiał Stal DD11

fischer
innovative solutions

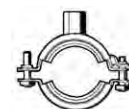

Zakres uchwytu	☒	Kod artykułu	Zakres uchwytu	☒	Kod artykułu	Zakres uchwytu	☒	Kod artykułu
15-19	100	64108.015.019	40-45	50	64108.040.045	74-78	25	64108.074.078
20-24	100	64108.020.024	48-53	50	64108.048.053	80-86	25	64108.080.086
25-30	100	64108.025.030	62-64	25	64108.062.064	89-92	25	64108.089.092
32-37	100	64108.032.037	68-73	25	64108.068.073	95-103	25	64108.095.103

- Dwuczęściowa, przegubowa opaska nośna.
- Opatentowany zamek z szybko nastawnym mechanizmem umożliwia łatwe i szybkie mocowanie rur.
- Materiał : Stal DD11 (nr 1.0332) zgodny z DIN EN 10111
- Pokrycie : O cynk 5-9 µm
- Obciążenie użytkowe, wzdłuż osi mocowania: 800 N
- Wkład tłumiący dźwięki: Materiał: SBR/EPDM
- Izolacja dźwiękowa: wg DIN 4109
- Zakres temperatury: -50° do +110 °C
- Twardość: 45 ± 5° Shore A
- Zachowanie w razie pożaru: wg DIN 4102: klasa B2

Zacisk rurowy

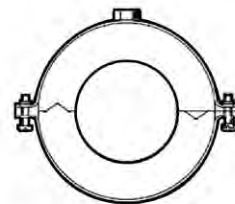
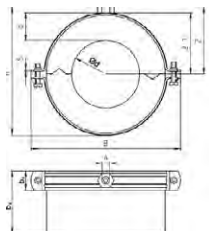

Informacje techniczne

ø d	A	B	b ₂ x d	H	h	M	N	Rozmiar rury	Z	Z ₁
21	M8	126	40x30	92	6.8	1.5	0.06	1/2	60	53

- N = Max.rekomend. Obciążenie statyczne (rozciąganie centr.) [kN].
- M = Max. rekomend. rozpiętość [m].

Dane montażowe

- Zastosuj ochronę przed korozją.
- Wprowadź rurę, pociągnij folię zabezpieczającą i zaklej.
- Zamocuj części zaciskowe.
- Na przodzie zabezpiecz szczelnie izolacją.

64122	FISCHER Zaciski rurowe FRS F	N02A
Materiał	PU	

ø x d	Kod artykułu
21/30	1 64122.021.030

- Dwuczęściowa opaska nośna FRS F z powłoką z twardej pianki poliuretanowej służy do mocowania rur chłodniczych i wodociągowych dla wody zimnej.
- FRS F otoczona jest płaszczem z folii aluminiowej, wyposażonym w samoprzylepną warstwę umożliwiającą szybki montaż.
- Gęstość : 80 kg/m³
- Wytrzymałość na ściskanie: 0,6 N/mm²
- Przewodność cieplna: 0,026 W/mK w 10 °C
- Odporność temperaturowa: -100 °C do +80 °C
- Zachowanie w razie pożaru: wg DIN 4102: klasa B2

Ceownik

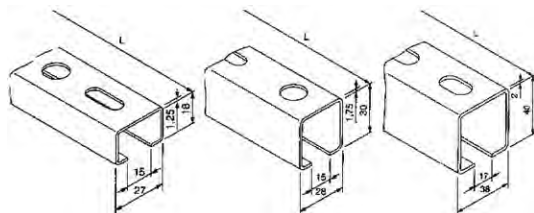

Informacje techniczne

Profil	B	H	L	ly	lz	P ₁	P ₂	Profil	Wx	Wy
27/18	27	18	2000	0.36	0.96	0.84	1.25	27/18/1.25-2m	0.34	0.71
28/30	28	30	2000	1.77	2.09	1.59	1.75	28/30/1.75-2m	1.02	1.49
38/40	38	40	2000	5.39	6.18	2.55	2	38/40/2.00-2m	2.4	3.25

Kolejność montażu

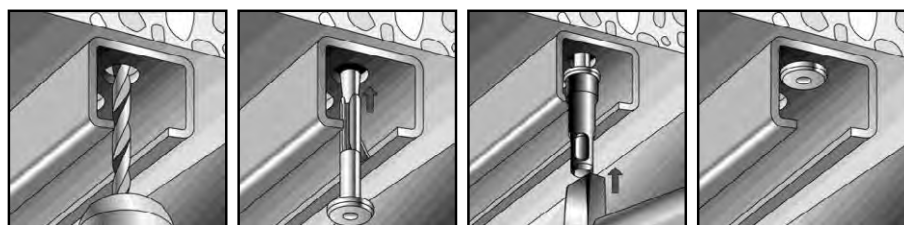

- Solidne mocowanie wymaga użycia odpowiedniego łączenia.

64130 FISCHER Ceownik MS

N02A

Materiał Stal
Obróbka powierzchni Ocynkowane

fischer
innovative solutions



B x H x L	☒	Kod artykułu	B x H x L	☒	Kod artykułu	B x H x L	☒	Kod artykułu
27/18 2000	1	64130.027.182	28/30 2000	1	64130.028.302	38/40 2000	1	64130.038.402

- Szyny montażowe doskonale nadają się do tworzenia pewnego mocowania, które umożliwia regulację kierunku i wysokości, czy to na budowie, czy też w trakcie montażu wstępnego w warsztacie.
- Szyny są idealne do szybkiego i pewnego mocowania
- pasm rur, jak również do tworzenia poprzecznic, wsporników ściennych, stojaków i ram nośnych wszelkiego rodzaju.
- Materiał : Stal DX51D+Z 275 NA-C (nr 1.20226+Z) zgodne z DIN EN 10327
- Pokrycie : Ocynek około 20 µm.

Ramię wspornika

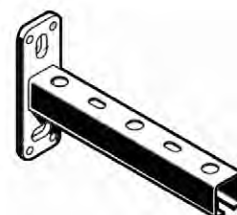
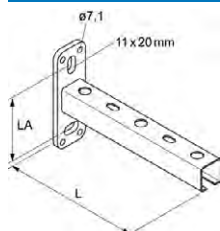

Informacje techniczne

Profil x L	L	LA	Profil	Płyta oporowa
27/18-200	200	79	27/18	120 x 40 x 4
27/18-300	300	79	27/18	120 x 40 x 4
28/30-320	320	79	28/30	120 x 40 x 4
28/30-440	440	79	28/30	120 x 40 x 4
38/40-360	360	79	38/40	120 x 40 x 6
38/40-520	520	79	38/40	120 x 40 x 6
38/40-600	600	79	38/40	120 x 40 x 6

- LA = odstęp między otworami [mm].

Dane montażowe

- Solidne mocowanie wymaga użycia odpowiedniego łączenia.
- Gniazda w płytce pozwalają na dobre dostosowanie odpowiedniej wysokości.

64134 FISCHER Ramiona wspornika ALK

N02A

Materiał Stal
Obróbka powierzchni Ocynkowane

fischer
innovative solutions



Profil x L	☒	Kod artykułu	Profil x L	☒	Kod artykułu	Profil x L	☒	Kod artykułu
ALK 38/40-600	10	64134.020.929	ALK 28/30-320	10	64134.079.578	ALK 38/40-360	10	64134.079.581
ALK 27/18-200	20	64134.079.575	ALK 28/30-440	10	64134.079.579	ALK 38/40-520	10	64134.079.582
ALK 27/18-300	20	64134.079.576						

- Wsporniki służą głównie do mocowania rur bezpośrednio na ścianach. Inne możliwości zastosowania to mocowanie na stropach lub podłodze. W połączeniu z szynami montażowymi i innymi elementami systemu SaMontec, dzięki wspornikom, można wykonać wiele różnych konstrukcji.
- Materiał : Stal DC01 (nr 1.0330) zgodne z DIN EN 10111
- Pokrycie : Ocynk min. 8 µm.

Zaślepka



64132 FISCHER Zaślepki AK						N02A		
Materiał		Plastik Polietylen						
Typ	✉	Kod artykułu	Typ	✉	Kod artykułu	Typ	✉	Kod artykułu
AK 27/18	100	64132.027.018	AK 28/30	100	64132.028.030	AK 38/40	50	64132.038.040

Śruba typ T clix

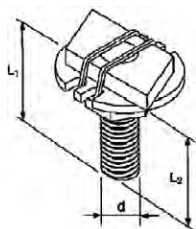

Informacje techniczne

d x L ₁	L ₁	L ₂	Profil
M8x30	30	25	27/18+28/30+30/15
M8x40	40	35	27/18+28/30+30/15

Kolejność montażu

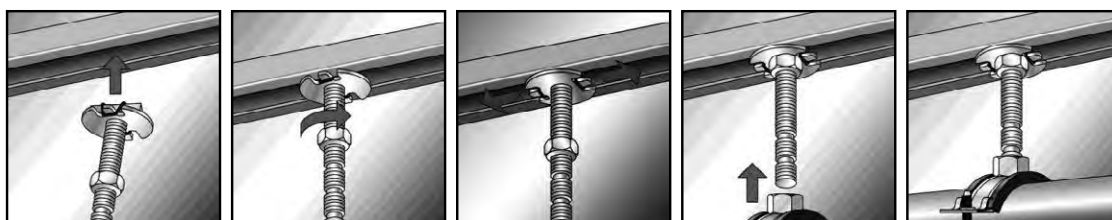

- Wprowadzić śrubę z łbem-T do szyny lub wspornika i przekręcić.
- Po wyrównaniu śruba powinna być zabezpieczona nakrętką

10

64162 FISCHER Śruby typ T clix						N02A	
Materiał		Stal					
Obróbka powierzchni		Ocynkowane					
d x L₁	✉	Kod artykułu	d x L₁	✉	Kod artykułu		
8X30	100	64162.080.030	8X40	100	64162.080.040		

- Opatentowana śruba z łbem młoteczkowym fischer FHS CLIX-N ze sworzniem rowkowanym - do łatwego, szybkiego i efektywnego montażu - składa się z mniejszej ilości elementów niż zwykle mocowania.
- Dzięki opatentowanemu mechanizmowi zabezpieczającemu pozwala ona na doskonałą manipulację w trakcie montażu.
- Możliwe jest skrócenie śruby z łbem młoteczkowym przez ucięcie w specjalnych zagłębieniach, przy pomocy nożyc do sworzni.
- Materiał : Stal DD11 (nr 1.0332) zgodne z DIN EN 10111
- Pokrycie : Ocynk min. 8 µm.

Nakrętka

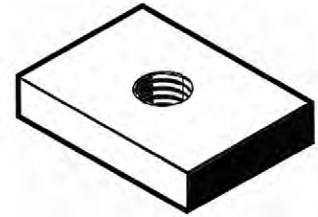
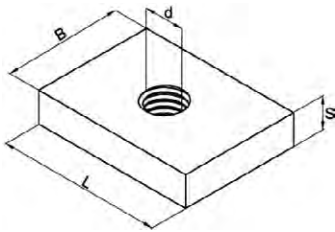

Informacje techniczne

d	B	L	Profil	S
M8	23	33	27/18+28/30+30/15+38/40+40/60+40/120	6
M10	23	33	27/18+28/30+30/15+38/40+40/60+40/120	6

- Elementy mocujące do szyn MS.
- Zalety:
 - Prosty montaż w szynie.
 - Dla standardowych profili szynowych MS z szerokością gniazda 15 i 17mm.
- Jako element łączący podpory i zaciski rurowe.
- Wsporniki, klamry i zaciski rurowe.

Dane montażowe

- Po wyrównaniu, płytka gwintowana powinna być zabezpieczona nakrętką.

64168 FISCHER Nakrętka SM		N02A
Materiał	Stal	
Obróbka powierzchni	Ocynkowane	

Typ	✉	Kod artykułu	Typ	✉	Kod artykułu
38 M8	50	64168.080.001	38 M10	50	64168.100.001

Podkładka do ceowników

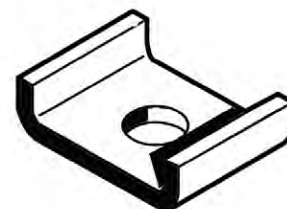
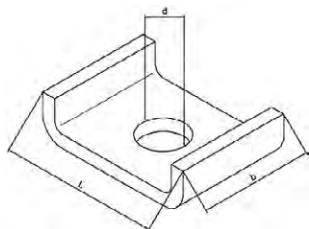

Informacje techniczne

Typ	b	L	Profil	ø d
HK27	33	25	27/18+28/30+30/15	11.5
HK38	33	40	38/40	12.5

64158 FISCHER łapa mocująca do szyn typ HK

N02A

Materiał Stal
Obróbka powierzchni O cynkowane

fischer innovative solutions



Typ	☒	Kod artykułu	Typ	☒	Kod artykułu
27	50	64158.270.001	38	50	64158.380.001

- Zapobiega wyginaniu profili
- Jej kształt ułatwia i przyspiesza montaż przelotowy
- Mat. S235JR wg DIN EN 10025
- Do lekkich rurociągów podwieszanych
- Stabilizuje szyny na ścianie tunelu

Śruba typ T

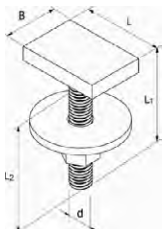

Informacje techniczne

d x L ₁	B	d	L	L ₁	L ₂	Profil	S
M8x30	24	M8	30	30	24	27/18+28/30+30/15+38/40+40/60+40/120	6
M8x40	24	M8	30	40	34	27/18+28/30+30/15+38/40+40/60+40/120	6
M10x30	24	M10	30	30	24	27/18+28/30+30/15+38/40+40/60+40/120	6
M10x40	24	M10	30	40	34	27/18+28/30+30/15+38/40+40/60+40/120	6

- Śruby z łbem typu T dla standardowych profili szynowych z szerokością gniazda 15 i 17mm.
- Zalety:
 - Prosta, szybka i efektywna instalacja.
 - Mniej zastosowanych elementów niż przy tradycyjnym montażu.
 - Proste wyrównanie w szynie.
- Jako element łączący podpory i zaciski rurowe.
- Wsporniki, kłamry i zaciski rurowe.

Dane montażowe

- Wprowadzić z boku śrubę z łbem-T do szyny lub wspornika.
- Po wyrównaniu śruba powinna być zabezpieczona nakrętką

64163	FISCHER Śruby typ T HS 38	N02A
Materiał	Stal	
Obróbka powierzchni	Ocynkowane	

Typ	☒	Kod artykułu	Typ	☒	Kod artykułu	Typ	☒	Kod artykułu
38 M8X30	50	64163.080.030	38 M10X30	50	64163.100.030	38 M10X40	50	64163.100.040
38 M8X40	50	64163.080.040						

Wspornik

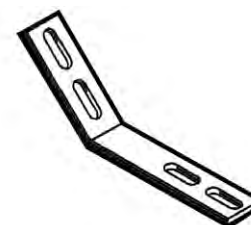
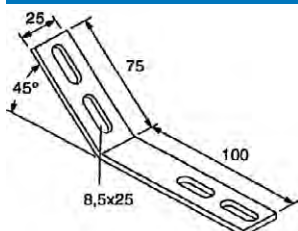

Informacje techniczne

Typ	B	H	Kątownik	L	Profil	S
MW27-45°	25	75	45°	100	27/18+28/30+30/15	4
MW27-90°	25	75	90°	80	27/18+28/30+30/15	4
MW38-45°	40	75	45°	105	38/40+41/21+41/41+40/60+40/120	6
MW38-90°	40	85	90°	105	38/40+41/21+41/41+40/60+40/120	6

Dane montażowe

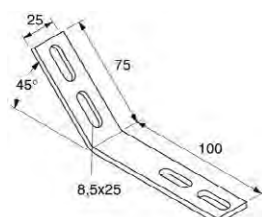

MW 27-45°

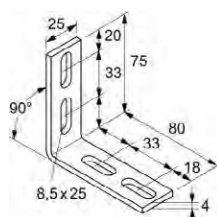

MW 27-90°

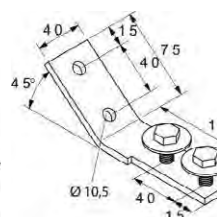

MW 38-45°

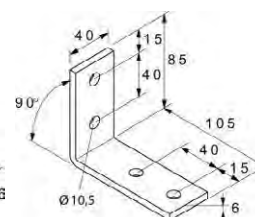

MW 38-90°

- Poprawny montaż używając odpowiednich kotew.
- Aby uprościć instalacje, wsporniki kątowe MW 38-45° są wyposażone w śruby zaciskowe

64144	FISCHER Wsporniki MW	N02A
Materiał	Stal	
Obróbka powierzchni	Ocynkowane	

Typ	☒	Kod artykułu	Typ	☒	Kod artykułu	Typ	☒	Kod artykułu
27-45	25	64144.027.045	38-45	10	64144.038.045	38-90	20	64144.038.090
27-90	25	64144.027.090						

- Kątownik wzmacniający konstrukcje wsporcze
- Umożliwia szybki montaż
- Różne kształty łączników umożliwiają swobodne mocowanie instalacji na szynach
- Otwory zapewniają łatwość w dopasowaniu do szyn MS oraz wsporników ALK
- Materiał S235JR wg DIN EN 10025
- Ocynk galwaniczny min. 8µm.

Wspornik

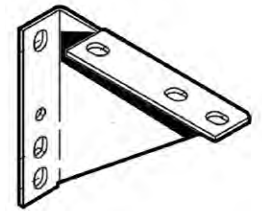
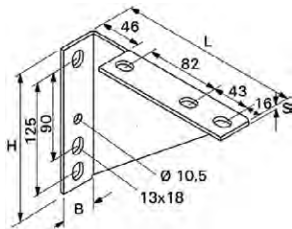

Informacje techniczne

Typ	B	H	L	Profil	S
207/165	40	165	207	38/40+41/21+41/41+40/60+40/120	4

Dane montażowe

- Solidne mocowanie wymaga użycia odpowiedniej kotwy.
- Dzięki łączeniu dwóch wsporników kątowych, możemy osiągnąć dużo większą wytrzymałość.

64136 FISCHER Wsporniki WK

N02A

Materiał Stal
Obróbka powierzchni Ocynkowane

fischer
innovative solutions

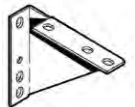

Typ	Kod artykułu
207/165	6 64136.207.165

- Wytrzymały łącznik wzmacniający konstrukcje wsporcze
- Może być stosowany jako niezależny wspornik do podwieszania rur
- Pozwala na bezpośrednie mocowanie rur lub szyn montażowych
- Może być wykorzystywany do usztywniania i wzmacniania konstrukcji
- Materiał stal DD 11 (1.0332) wg DIN EN 10111
- Ocynk galwaniczny min. 5µm

Obejmy

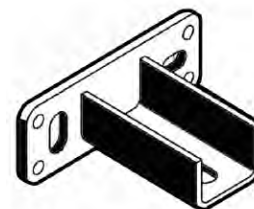
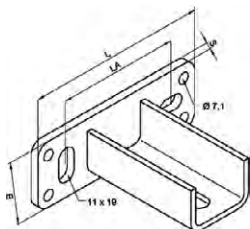

Informacje techniczne

Typ	B	L	LA	Profil	S
SF Q 27	40	125	84	27/18+28/30+30/15	5
SF Q 38	50	136	95	38/40+41/21+41/41+40/60+40/120	6

Dane montażowe

- Wprowadź i zamontuj szynę mocującą
- Solidne mocowanie wymaga użycia odpowiedniej kotwy
- Odpowiednie ustawienie wysokości poprzez użycie gniazd w podstawie płytki

64140 FISCHER Stopka siodłowa SF		N02A
Materiał	Stal	
Obróbka powierzchni	Ocynkowane	

Typ	✉	Kod artykułu	Typ	✉	Kod artykułu
Q27	15	64140.270.001	Q38	10	64140.380.001

- Do konstruowania podpór lub łączenia szyny do konstrukcji budynku
- Szyny montażowe idealnie pasują i mogą być łatwo wsuwane do stopki siodłowej SF
- Stopka stanowi solidną i stabilną
- Podstawę dla obciążonych konstrukcji
- Materiał: stal DD 11 (1.0332) wg DIN EN 10111
- Ocynk galwaniczny min. 8 µm

Zacisk

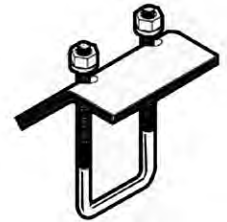
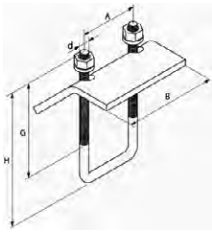

Informacje techniczne

Typ	A	B	d	G	H	N	Profil	Zakres
TKR27/18	37	60	M6	60	81	2.8	27/18+28/30	0-29
TKR38/40	47	70	M8	55	86	5.40	38/40	0-24.5

- N = Maksymalne zalecane obciążenie statyczne (rozciąganie centr.) w [kN].

Dane montażowe

- Dwa zaciski podtrzymujące są niezbędne do przykręcenia do metalowego dźwigara.

64154 FISCHER łącznik do dźwigarów TKR

N02A

Materiał Stal
Obróbka powierzchni O cynkowane

fischer
innovative solutions



Typ	Kod artykułu
27/18	64154.027.018

- Element do połączeń szyn montażowych do dźwigarów stalowych
- Do każdego połączenia z dźwigarem potrzebne są dwa łączniki
- Kształt łącznika pozwala na łączenie szyn montażowych bez wiercenia lub spawania
- Różne długości ramion pozwalają na dopasowanie łączników do większości standardowych dźwigarów stalowych
- Materiał pręta U-kształtowanego: stal S235JR (1.0037) wg DIN EN 10025
- Nakrętki 6-kątne ze stali w kl. 8
- Ocynk galwaniczny min. 5µm

Łączniki

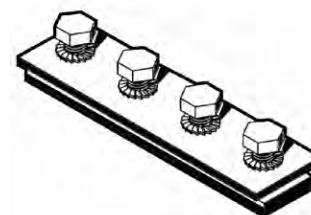
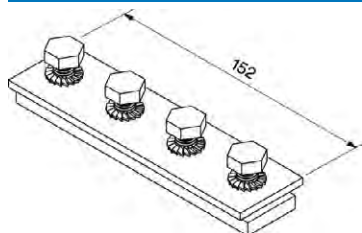

Informacje techniczne

Typ	Profil	Typ	Profil
SV27	27/18+28/30	SV38	38/40

Kolejność montażu



- Złączki wprowadzone są na końcach szyn i mocno przykręcone.

64152 FISCHER łącznik do szyn SV

N02A

Materiał Stal
Obróbka powierzchni Ocynkowane

fischer
innovative solutions

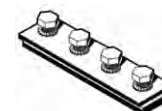

Typ	✉	Kod artykułu	Typ	✉	Kod artykułu
27	20	64152.270.001	38	10	64152.380.001

- Może być stosowany w celu łączenia i dopasowania fragmentów szyn
- Umożliwia stabilne i bezpieczne łączenie szyn
- Szybkie łączenie szyn to oszczędność czasu
- Materiał dla SV 38: stal DD 11 (1.0332) wg DIN EN 10111
- Ocynk galwaniczny min. 5µm

Łączniki równoległe





Informacje techniczne

Typ	d	N
PV M8	M8	2.00

- N = Max.rekomend. Obciążenie statyczne (rozciąganie centr.) [kN].

Dane montażowe

- Przytrzymaj razem gwintowane części.
- Zabezpiecz używając nakrętki samohamownej.
- Dostosowanie poziomu możliwe jest poprzez przekręcanie kolka gwintowanego.

64180 FISCHER Łączniki równoległe		N02A
Materiał	Zamac 3	  

Typ	📧	Kod artykułu
M8	100	64180.080.001

- Zalety i korzyści:
- szybki montaż
- łatwa regulacja wysokości
- regulacja wysokości możliwa również na zmontowanym elemencie

Zacisk śrubowy

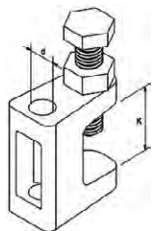

Informacje techniczne

Typ	d	K	N
TKL M8	M8	0-23	2.50
TKL ø9	ø9	0-18	1.20
TKL M10	M10	0-20	2.50
TKL ø11	ø11	0-20	2.50

- N = Maksymalne zalecane obciążenie statyczne (rozciąganie centr.) w [kN].

Dane montażowe

- Wsporniki zabezpieczające potrzebne do systemów VdS zaczynające się od DN 65.

64275 FISCHER Wieszak zaciskowy TKL		N02A	
Materiał	Żeliwo		
Obróbka powierzchni	Ocynkowane		

Typ	☒	Kod artykułu	Typ	☒	Kod artykułu	Typ	☒	Kod artykułu
TKL M8	50	64275.080.001	TKL M10	50	64275.100.001	TKL ø11	50	64275.110.001
TKL ø9	50	64275.090.001						

- Klamra służy do łatwego mocowania do dźwigarów stalowych poprzez zaciskanie
- Umożliwia mocowanie bez spawania lub wiercenia
- Posiada zabezpieczenie przed na zsuniecie się z dźwigara
- Certyfikaty VdS/FM/UL gwarantują odporność ogniową potwierdzoną przez niezależne laboratoria
- Solidna budowa wieszaka zapewnia duży stopień wytrzymałości na obciążenia
- Posiada śrubę zamykającą ułatwiającą szybki montaż
- Możliwa regulacja wysokości po zamontowaniu
- TKL materiał: żeliwo ciągliwe EN-GLMB-350-10 wg DIN 1562
- Śruba ISO 4017 kl.8.8 ; nakrętka ISO 4035 kl. 04
- Ocynk galwaniczny min.5µm

Opaski stalowe

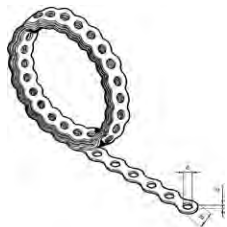

Informacje techniczne

Typ	B	d	L	S
LBV 17	17	6.5	10	0.75
LBV 26	25	8.5	10	0.88

- Do łączenia z: ED 15; ED 18; ED 22.

Kolejność montażu

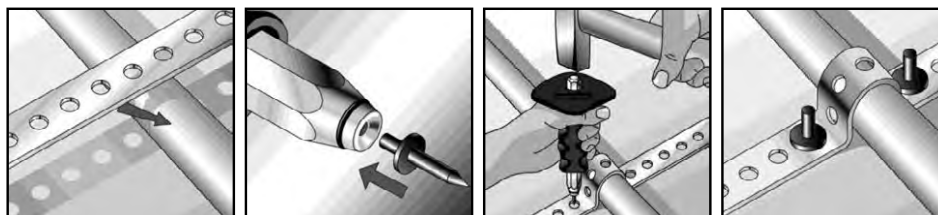

- Należy pociąć kawałki metalu na żądane długości.
- Montaż podłogowy – kotwa gwoździowa Fischer ED.
- Montaż sufitowy w betonie - zalecana jest kotwa gwoździowa Fischer FNA II.

64272 FISCHER Opaski stalowe LBV

N02A

Materiał Stal
Obróbka powierzchni Ocynkowane

fischer
innovative solutions



Typ	⊞	Kod artykułu	Typ	⊞	Kod artykułu
17 (ROLL, 10 MTR)	1	64272.170.001	26 (ROLL, 10 MTR)	1	64272.260.001

- Opaska stalowa z otworami dla prostych instalacji, ocynk lub pokrycie plastikowe.
- Zalety:
- Łatwy montaż.
- Uniwersalne łączenie.
- Elastyczny dobór długości.
- Do łączenia rury na podłodze lub wiszące na ścianie.
- Właściwości:
- Materiał: Stal DX51 D+Z (materiał no. 1.0226) zgodnie z DIN EN 10327.
- Ocynkowane: 5 - 27 µm.

Łączniki podwójne

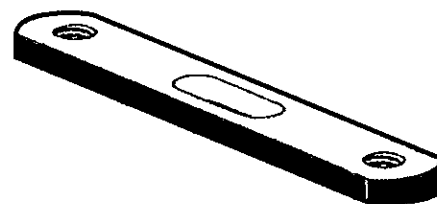

Informacje techniczne

Typ	L	M
DPP 65	65	M8
DPP 85	85	M8
DPF 60-105	105	M8

Dane montażowe

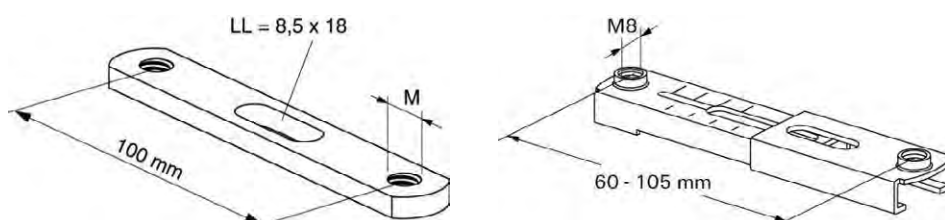

Grupy katalogowe

Materiał	Obróbka powierzchni	Kod	Strona
St	Ocynk.	64271	10-53
St	Ocynk.	64270	10-53

64271 FISCHER Łączniki podwójne DPP

N02A

Materiał Stal
Obróbka powierzchni Ocynkowane

fischer innovative solutions



L	☒	Kod artykułu	L	☒	Kod artykułu
DPP 65	50	64271.000.065	DPP 85	50	64271.000.085

- Element łączący - instalacyjny do dwóch linii równoległych z jednym tylko punktem mocującym.
- Zalety:
 - Tylko jedno pole łączenia dla dwóch linii.
 - Bardzo dobra widoczność instalacji.
 - Możliwość dostosowania ze względu na gniazdo.
- Do łączenia:
 - Równoległych rur na ścianie.
- Właściwości:
 - Materiał: Stal DD11 (materiał nr 1.0332) zgodnie z DIN EN 10111.
 - Ocynkowane: ocynk, 5 - 9 µm.

64270 FISCHER Łączniki podwójne DPF

N02A

Materiał Stal
Obróbka powierzchni Ocynkowane

fischer innovative solutions

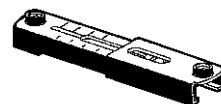

L	☒	Kod artykułu
DPF 60-105	50	64270.060.105

64270 FISCHER Łączniki podwójne DPF

- Element łączący - instalacyjny do dwóch linii równoległych z jednym tylko punktem mocującym.
- Zalety:
 - Tylko jedno pole łączenia dla dwóch linii.
 - Bardzo dobra widoczność instalacji.
 - Możliwość dostosowania ze względu na gniazdo.
 - Możliwość dostosowania odstępu między rurami.
- Do łączenia:
 - Równoległych rur na ścianie.
- Właściwości:
 - Materiał: Stal DD11 (materiał nr 1.0332) zgodnie z DIN EN 10111.
 - Ocynkowane: ocynk, 5 - 9 µm.

Łącznik śrubowy

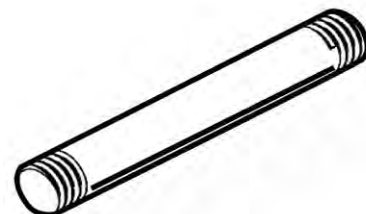
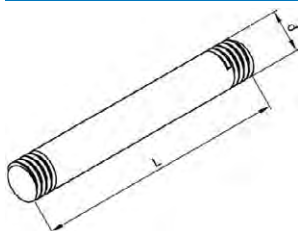

Informacje techniczne

Typ	d	L
SBB 35	M8	35
SBB 55	M8	55

64273 FISCHER Łącznik śrubowy SBB
N02A

Materiał Stal
 Obróbka powierzchni Ocynkowane

fischer
 innovative solutions



d x L	☒	Kod artykułu	d x L	☒	Kod artykułu
35	100	64273.080.035	55	100	64273.080.055

- Idealny do łączenia podwójnych i multikonektorów
- Materiał: stal S235JR (1.0037) wg DIN EN 10025
- Ocynk galwaniczny min. 8µm

Fabory Fastclip System mocowania

Informacje ogólne

System mocowania Fabory Fastclip składa się z zacisku podstawowego, który można bez problemu zainstalować na konstrukcji stalowej, albo jako pojedynczy zacisk, albo w połączeniu z dodatkowymi elementami, ręcznie lub przy pomocy narzędzi ręcznych, takich jak młotek, kombinerki, śrubokręt. Należy tu podkreślić oszczędność kosztów i czasu.

Zastosowanie

Systemy mocowań Fabory Fastclip z ich różnorodnymi możliwościami łączenia są powszechnie stosowane w szeroko pojętym przemyśle budowlanym, np. w instalacjach elektrotechnicznych, w montażu sufitów, instalacjach sanitarnych, klimatyzacyjnych i grzewczych.

Standaryzacja

System mocowania Fabory Fastclip został przetestowany zgodnie z DIN 18168.

Obciążenia

Obciążenie nominalne tych elementów złącznych jest wyrażone w Niutonach jako granica obciążenia statycznego i granica obciążenia statycznego niszczącego. Wartości wskazują maksymalnie dopuszczalne obciążenia dla zastosowań przez użytkownika. Normy wymagają, aby

próbki testowe wybierane losowo, spośród normalnej partii produkcyjnej, wytrzymały obciążenie równe trzykrotnemu obciążeniu podanemu w tym katalogu. Granica statycznego obciążenia niszczącego jest granicą stałego nominalnego obciążenia, które, jeżeli zostanie przekroczone, może uszkodzić element złączny. Wartości te są podane dla obciążeń stosowanych pionowo dla zwyczajnych instalacji elementów złącznych. Gdy obciążenie nominalne elementu złącznego przekracza obciążenie nominalne elementu konstrukcji stalowej, wówczas niższa wartość musi stanowić granicę obciążenia. Zaciski mocujące Fabory Fastclip są wykrawane ze stali sprężynowej, a następnie hartowane.

Obróbka powierzchni

Zaciski mocujące Fabory Fastclip są pokrywane powłoką antykorozyjną Deltatone, grubości 10-12 μm (odporność na korozję podczas prób w mgie solnej zgodnie z ASTM B117/ DIN 50021 wynosi około 480 godzin). Deltatone eliminuje możliwość pęknięcia wywołanego kruchością wodorową!

Przykłady zastosowań

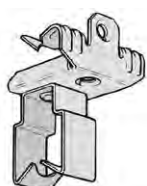

Typ 50 H + 75 H

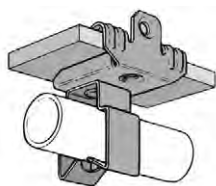

Typ CC



Typ CR

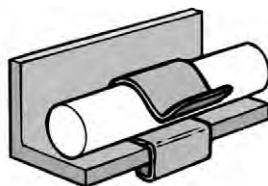

Typ PF



Typ H

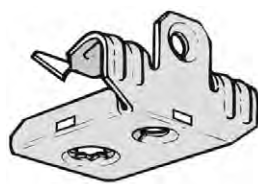

Typ MC



Typ RH



Typ BC

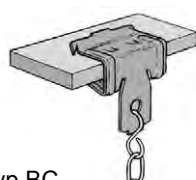

Typ BCC

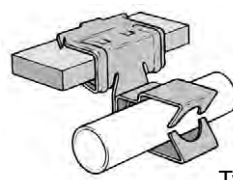

Klamry uniwersalne do belek, typ H

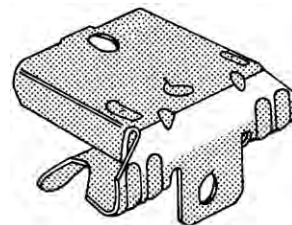

Informacje techniczne

Typ	Dopuszczalne obciążenie statyczne	Grubość/nastawność stopki belki
H2-4	450 N (3:1)	3-7
H5-8	450 N (3:1)	8-12.5

- Informacje techniczne, przykłady zastosowań dotyczące powłok DELTATONE szukaj na stronie informacyjnej.

60319 FASTCLIP Klamry uniwersalne do belek, typ H

S06A

Materiał Stal sprężynowa
Obróbka powierzchni Deltatone

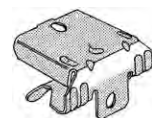

Typ	⊗	Kod artykułu	Typ	⊗	Kod artykułu
H 2-4	100	60319.002.004	H 5-8	100	60319.005.008

Klamry uniwersalne do belek, typ 50H

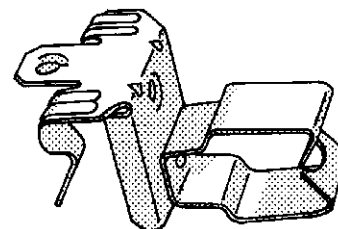

Informacje techniczne

Typ	Grubość/nastawność stopki belki	Maks. obciążenie statyczne	Rozmiar przewodu
50H2-4	3-7	110 N (3:1)	20
50H5-8	8-12.5	110 N (3:1)	20
75H2-4	3-7	110 N (3:1)	25
75H5-8	8-12.5	110 N (3:1)	25

- Informacje techniczne, przykłady zastosowań dotyczące powłok DELTATONE szukaj na stronie informacyjnej.

60321 FASTCLIP Klamry uniwersalne do belek, typ 50H

S06A

Materiał Stal sprężynowa
Obróbka powierzchni Deltatone



Typ	⊗	Kod artykułu	Typ	⊗	Kod artykułu	Typ	⊗	Kod artykułu
50H 2-4	50	60321.502.004	75H 2-4	100	60321.752.004	75H 5-8	50	60321.755.008
50H 5-8	50	60321.505.008						

Klamry do belek, typ BC

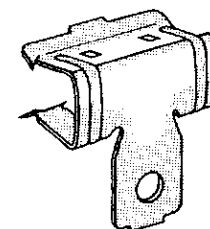

Informacje techniczne

Typ	Dopuszczalne obciążenie statyczne	Grubość/nastawność stopki belki
BC-250	900 N (3:1)	5-9
BC-500	900 N (3:1)	10-16
BC-750	900 N (3:1)	17-20

- Informacje techniczne, przykłady zastosowań dotyczące powłok DELTATONE szukaj na stronie informacyjnej.

60311 FASTCLIP Klamry do belek, typ BC

S06A

Materiał Stal sprężynowa
Obróbka powierzchni Deltatone

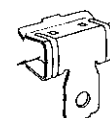

Typ	⊗	Kod artykułu	Typ	⊗	Kod artykułu	Typ	⊗	Kod artykułu
BC-250	100	60311.000.250	BC-500	100	60311.000.500	BC-750	100	60311.000.750

Klamry do belek z klamrą na przewody, zatraskowe, typ BCC

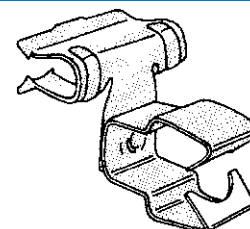

Informacje techniczne

Typ	Grubość/nastawność stopki belki	Maks. obciążenie statyczne	Rozmiar przewodu
BCC 25-50	5-9	110 N (3:1)	20
BCC 50-50	10-16	110 N (3:1)	20
BCC 25-75	5-9	110 N (3:1)	25
BCC 50-75	10-16	110 N (3:1)	25
BCC 25-100	5-9	110 N (3:1)	32
BCC 50-100	10-16	110 N (3:1)	32

- Informacje techniczne, przykłady zastosowań dotyczące powłok DELTATONE szukaj na stronie informacyjnej.

60313 FASTCLIP Klamry do belek z klamrą na przewody, zatraskowe, typ BCC

S06A

Materiał Stal sprężynowa
Obróbka powierzchni Deltatone

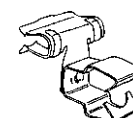

Typ	⊗	Kod artykułu	Typ	⊗	Kod artykułu	Typ	⊗	Kod artykułu
BCC 25-50	100	60313.025.050	BCC 25-100	50	60313.025.100	BCC 50-75	50	60313.050.075
BCC 25-75	100	60313.025.075	BCC 50-50	100	60313.050.050	BCC 50-100	50	60313.050.100

10

Klamry do belek z wieszakiem na pręt gwintowany, typ RH

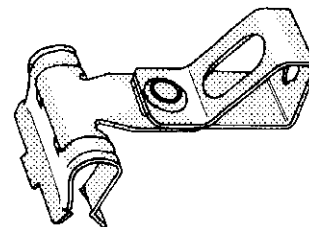

Informacje techniczne

Typ	Dopuszczalne obciążenie statyczne	Grubość/nastawność stopki belki	Śruba dwustronna
RH-6MT/25	680 N (3:1)	5-9	M6
RH-6MT/50	680 N (3:1)	10-16	M6
RH-6MT/75	680 N (3:1)	17-20	M6
RH-8MT/25	680 N (3:1)	5-9	M8
RH-8MT/50	680 N (3:1)	10-16	M8
RH-8MT/75	680 N (3:1)	17-20	M8
RH-10MT/25	680 N (3:1)	5-9	M10
RH-10MT/50	680 N (3:1)	10-16	M10
RH-10MT/75	680 N (3:1)	17-20	M10

- Informacje techniczne, przykłady zastosowań dotyczące powłok DELTATONE szukaj na stronie informacyjnej.

60315 FASTCLIP Klamry do belek z wieszakiem na pręt gwintowany, typ RH

S06A

Materiał Stal sprężynowa
Obróbka powierzchni Deltatone

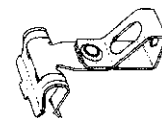

Typ	☒	Kod artykułu	Typ	☒	Kod artykułu	Typ	☒	Kod artykułu
RH-6MT/25	100	60315.060.025	RH-8MT/25	100	60315.080.025	RH-10MT/25	100	60315.100.025
RH-6MT/50	100	60315.060.050	RH-8MT/50	50	60315.080.050	RH-10MT/50	100	60315.100.050
RH-6MT/75	100	60315.060.075	RH-8MT/75	100	60315.080.075	RH-10MT/75	100	60315.100.075

Elementy złączne dociskające, typ PF

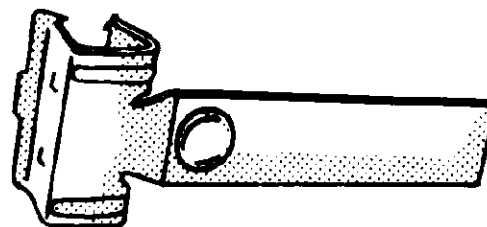

Informacje techniczne

Typ	Grubość/nastawność stopki belki
PF-250	5-9
PF-500	10-16

- Informacje techniczne, przykłady zastosowań dotyczące powłok DELTATONE szukaj na stronie informacyjnej.

60317 FASTCLIP Elementy złączne dociskające, typ PF S06A

Materiał Stal sprężynowa
Obróbka powierzchni Deltatone

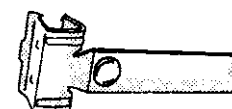

Typ	⊗	Kod artykułu	Typ	⊗	Kod artykułu
PF-250	100	60317.000.250	PF-500	50	60317.000.500

Zaciski zatraskowe do przewodów, typ CC

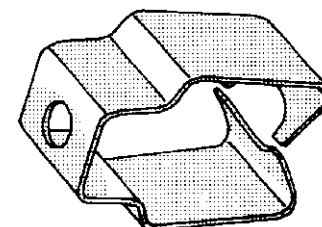

Informacje techniczne

Typ	Maks. obciążenie statyczne	Rozmiar przewodu	Ø Śruby
CC-500	110 N (3:1)	20	6
CC-750	110 N (3:1)	25	6
CC-1000	110 N (3:1)	32	6

- Informacje techniczne, przykłady zastosowań dotyczące powłok DELTATONE szukaj na stronie informacyjnej.

60325 FASTCLIP Zaciski zatraskowe do przewodów, typ CC S06A

Materiał Stal sprężynowa
Obróbka powierzchni Deltatone

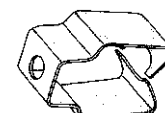

Typ	⊗	Kod artykułu	Typ	⊗	Kod artykułu	Typ	⊗	Kod artykułu
CC-500	100	60325.000.500	CC-750	100	60325.000.750	CC-1000	100	60325.001.000

10

Klamry główne MC

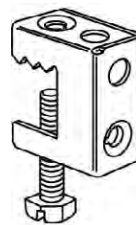
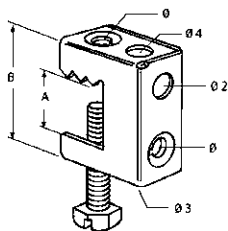

Informacje techniczne

Typ	A	B	Dopuszczalne obciążenie statyczne	Ø	Ø 2	Ø 3	Ø 4
MC	2-18	35	450 N	M6	6.5	11	6.5

- Informacje techniczne, przykłady zastosowań dotyczące powłok DELTATONE szukaj na stronie informacyjnej.

60323 FASTCLIP Klamry główne, typ MC

S06A

Materiał Stal sprężynowa
Obróbka powierzchni Deltatone



Typ	⊠	Kod artykułu
MC	100	60323.001.770

- Zawierają śrubą sześciokątną

Zaciski do ciągów kablowych, typ CR

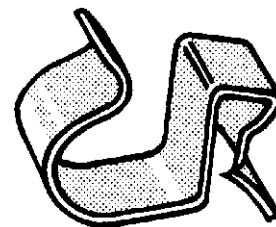

Informacje techniczne

Typ	Do przewodu	Grubość/nastawność stopki belki
CR-215	15-18	2-4
CR-219	19-24	2-4
CR-225	25-30	2-4
CR-412	12-14	4-7
CR-415	15-18	4-7
CR-419	19-24	4-7
CR-812	12-14	8-12
CR-815	15-18	8-12
CR-819	19-24	8-12
CR-825	25-30	8-12

- Informacje techniczne, przykłady zastosowań dotyczące powłok DELTATONE szukaj na stronie informacyjnej.

60331 FASTCLIP Zaciski do ciągów kablowych, typ CR

S06A

Materiał Stal sprężynowa
Obróbka powierzchni Deltatone



Typ	⊠	Kod artykułu	Typ	⊠	Kod artykułu	Typ	⊠	Kod artykułu
CR-215	100	60331.000.215	CR-415	100	60331.000.415	CR-815	100	60331.000.815
CR-219	100	60331.000.219	CR-419	100	60331.000.419	CR-819	100	60331.000.819
CR-225	100	60331.000.225	CR-812	100	60331.000.812	CR-825	100	60331.000.825
CR-412	100	60331.000.412						

FABORY QUICK SYSTEM

Zatrzaski przegubowe

Zastosowanie

Zatrzaski przegubowe FABORY są ważnym elementem FABORY QUICK SYSTEM. Mają szeroki zakres zastosowań począwszy od np. zamykania pokryw prostych elementów skrzyń drewnianych do skutecznej ochrony pomieszczeń silników maszyn rolniczych.

Montaż

Zasada działania zatrzasków przegubowych FABORY QUICK SYSTEM jest zawsze taka sama, niezależnie od ich wymiaru, możliwości blokowania i regulowania. Sam zatrzask jest mocowany do jednej z łączonych części a zaczep jest mocowany do drugiej części. Do zamknięcia konstrukcji, zatrzask jest przeciągany do zaczepu i napinany przez opuszczenie zasuw. Przesunięcie centrum punktu obrotu i punktu zaciśnięcia się zatrzasku na zaczepie zapewniają, że zatrzask nie może się otworzyć. Sprężyna zamykająca jest zwykle lekko zgięta i skupia ogromną część siły zamykającej, pomimo niewielkich tolerancji w montowanych w lub na różnych częściach.

Prezentacja

Zebrane doświadczenie nauczyło nas, że na ogół dostępna przestrzeń do zamontowania decyduje o ostatecznym wyborze zatrzasku przegubowego FABORY QUICK SYSTEM, poniżej przedstawiono szeroki wybór zatrzasków przegubowych w kolejności od najmniejszych do największych modeli. Rozróżniono również modele wykonane ze stali i stali nierdzewnej. Każda prezentacja stara się podać wszystkie istotne informacje w taki sposób, aby były czytelne na pierwszy rzut oka.

Informacje szczególne

Dla każdego zacisku przegubowego FABORY QUICK SYSTEM podano liczne informacje szczególne, takie jak informacje obciążeniowe, standardowe wykończenie, a tam, gdzie to stosowne, szczególne właściwości zamknięcia takie jak, możliwość regulacji i zamknięcia, jeżeli potrzebna jest mocniejsza ochrona przed niepożądanym otwarciem zatrzasku przegubowego.

Zaczepty

Informacje przygotowania montażu zakładają zastosowanie wskazanego zatrzasku przegubowego w połączeniu z zalecanym zaczepem. Oczywiście możliwe jest zastosowanie innych zaczepów, ale prawidłowe przygotowanie montażu części musi być wówczas określone przez praktyczne testy.

Specjalne

W zależności od zastosowania, na żądanie dostępne są specjalne zatrzaski przegubowe, inne kształty zaczepów, różne wykończenia, itd.

Przykład zastosowania



Zatraski przegubowe



Grupy katalogowe

Material	Obróbka powierzchni	Kod	Strona
St	Ocynk.	62255	10-62
St.St. A2		62257	10-63

62255	SZYBKI SYSTEM Zatraski przegubowe	S04A
Material	Stal	
Obróbka powierzchni	Ocynkowane	

Nr	☒	Kod artykułu		
2.00.00.04/6	5	62255.200.004	<ul style="list-style-type: none"> Maks. obciążenie dopuszczalne 2000 N Min. siła niszcząca 4000 N Rozmiar długość x szerokość x wysokość: 131 x 43 x 19 mm 	
2.00.01.04/6	5	62255.200.104	<ul style="list-style-type: none"> Zamykane na kłódkę Maks. obciążenie dopuszczalne 2000 N Min. siła niszcząca 4000 N Rozmiar długość x szerokość x wysokość: 131 x 43 x 30,5 mm 	
2.01.00.04/6	10	62255.201.004	<ul style="list-style-type: none"> Maks. obciążenie dopuszczalne 1500 N Min. siła niszcząca 3000 N Rozmiar długość x szerokość x wysokość: 101 x 34 x 12,5 mm 	
2.02.00.04/6	10	62255.202.004	<ul style="list-style-type: none"> Maks. obciążenie dopuszczalne 400 N Min. siła niszcząca 1000 N Rozmiar długość x szerokość x wysokość: 52 x 21 x 10,7 mm 	
2.03.00.04/6	10	62255.203.004	<ul style="list-style-type: none"> Maks. obciążenie dopuszczalne 550 N Min. siła niszcząca 1500 N Rozmiar długość x szerokość x wysokość: 75 x 23 x 11 mm 	
2.03.02.04/6	10	62255.203.204	<ul style="list-style-type: none"> Z pomocniczym zamkiem Maks. obciążenie dopuszczalne 550 N Min. siła niszcząca 1500 N Rozmiar długość x szerokość x wysokość: 75 x 23 x 11 mm 	
2.04.00.04/6	10	62255.204.004	<ul style="list-style-type: none"> Maks. obciążenie dopuszczalne 550 N Min. siła niszcząca 1500 N Rozmiar długość x szerokość x wysokość: 42,5 x 41 x 12 mm 	
2.05.00.04/6	5	62255.205.004	<ul style="list-style-type: none"> 12 mm regulowane Maks. obciążenie dopuszczalne 1100 N Min. siła niszcząca 2500 N Rozmiar długość x szerokość x wysokość: 128 x 52 x 18 mm 	
2.06.00.04/6	10	62255.206.004	<ul style="list-style-type: none"> Maks. obciążenie dopuszczalne 1000 N Min. siła niszcząca 2500 N Rozmiar długość x szerokość x wysokość: 84 x 28 x 17 mm 	
2.06.01.04/6	10	62255.206.104	<ul style="list-style-type: none"> Zamykane na kłódkę Maks. obciążenie dopuszczalne 1000 N Min. siła niszcząca 2500 N Rozmiar długość x szerokość x wysokość: 84 x 28 x 17 mm 	
2.07.00.04	10	62255.207.004	<ul style="list-style-type: none"> Sprężyna zamykająca zaciskająca bezpośrednio część konstrukcji Mocowanie przez spawanie lub zgrzewanie punktowe Maks. obciążenie dopuszczalne 300 N Min. siła niszcząca 600 N Rozmiar długość x szerokość x wysokość: 81 x 29 x 18 mm 	
2.08.00.04	10	62255.208.004	<ul style="list-style-type: none"> Sprężyna zamykająca zaciskająca bezpośrednio część konstrukcji Maks. obciążenie dopuszczalne 500N Min. siła niszcząca 900 N Rozmiar długość x szerokość x wysokość: 90 x 20 x 17 mm 	
2.17.00.04/6	10	62255.217.004	<ul style="list-style-type: none"> Maks. obciążenie dopuszczalne 400 N Min. siła niszcząca 1000 N Rozmiar długość x szerokość x wysokość: 51 x 22 x 12,5 mm 	
2.18.00.04/6	5	62255.218.004	<ul style="list-style-type: none"> 12 mm regulowane Maks. obciążenie dopuszczalne 1500 N Min. siła niszcząca 3000 N Rozmiar długość x szerokość x wysokość: 88 x 52 x 26 mm 	
2.18.01.04/6	5	62255.218.104	<ul style="list-style-type: none"> 12 mm regulowane Zamykane na kłódkę Maks. obciążenie dopuszczalne 1500 N Min. siła niszcząca 3000 N Rozmiar długość x szerokość x wysokość: 88 x 52 x 25 mm 	

62255		SZYBKI SYSTEM Zatrzaski przegubowe					
Nr	☒	Kod artykułu					
2.19.00.04	5	62255.219.004	<ul style="list-style-type: none"> Sprężyna zamykająca zaciskająca bezpośrednio część konstrukcji Maks. obciążenie dopuszczalne 750 N Min. siła niszcząca a 1500 N Rozmiar długość x szerokość x wysokość : 128,5 x 28,5 x 27 mm 				
2.40.00.04/6	5	62255.240.086	<ul style="list-style-type: none"> 15 mm regulowane Maks. obciążenie dopuszczalne 2000 N Min. siła niszcząca 4000 N Rozmiar długość x szerokość x wysokość : 131,5 x 45,5 x 23 mm 				
2.41.00.04/6	10	62255.241.086	<ul style="list-style-type: none"> 10 mm regulowane Maks. obciążenie dopuszczalne 1000 N Min. siła niszcząca 2000 N Rozmiar długość x szerokość x wysokość : 70 x 25,5 x 18 mm 				
2.41.01.04/6	10	62255.241.186	<ul style="list-style-type: none"> 10 mm regulowane Zamykane na kłódkę Maks. obciążenie dopuszczalne 1000 N Min. siła niszcząca 2000 N Rozmiar długość x szerokość x wysokość : 70 x 25,5 x 18,5 mm 				
2.42.00.04/6	10	62255.242.086	<ul style="list-style-type: none"> Ze sprężynami ściszanymi Maks. obciążenie dopuszczalne 500 N Min. siła niszcząca 1500 N Rozmiar długość x szerokość x wysokość : 54 x 37 x 12,5 mm 				
2.43.00.04/6	10	62255.243.086	<ul style="list-style-type: none"> Maks. obciążenie dopuszczalne 550 N Min. siła niszcząca 1500 N Rozmiar długość x szerokość x wysokość : 45 x 23 x 12 mm 				
2.45.00.04/6	10	62255.245.086	<ul style="list-style-type: none"> Maks. obciążenie dopuszczalne 150 N Min. siła niszcząca 300 N Rozmiar długość x szerokość x wysokość : 32 x 16 x 6 mm 				
62257		SZYBKI SYSTEM Zatrzaski przegubowe				S04A	
Materiał		Stal nierdzewna A2					
Nr	☒	Kod artykułu					
2.00.00.30/6	5	62257.200.030	<ul style="list-style-type: none"> Maks. obciążenie dopuszczalne 2000 N Min. siła niszcząca 4000 N Rozmiar długość x szerokość x wysokość : 131 x 43 x 19 mm 				
2.00.02.30/6	5	62257.200.230	<ul style="list-style-type: none"> Z zamkiem pomocniczym Maks. obciążenie dopuszczalne 2000 N Min. siła niszcząca 4000 N Rozmiar długość x szerokość x wysokość : 131 x 43 x 19 mm 				
2.01.00.30/6	10	62257.201.030	<ul style="list-style-type: none"> Maks. obciążenie dopuszczalne 1500 N Min. siła niszcząca 3000 N Rozmiar długość x szerokość x wysokość : 101 x 34 x 12,5 mm 				
2.02.00.30/6	10	62257.202.030	<ul style="list-style-type: none"> Maks. obciążenie dopuszczalne 400 N Min. siła niszcząca 1000 N Rozmiar długość x szerokość x wysokość : 52 x 21 x 10,7 mm 				
2.03.00.30/6	10	62257.203.030	<ul style="list-style-type: none"> Maks. obciążenie dopuszczalne 550 N Min. siła niszcząca 1500 N Rozmiar długość x szerokość x wysokość : 75 x 23 x 11 mm 				
2.03.02.30/6	10	62257.203.230	<ul style="list-style-type: none"> Z zamkiem pomocniczym Maks. obciążenie dopuszczalne 550 N Min. siła niszcząca 1500 N Rozmiar długość x szerokość x wysokość : 75 x 23 x 11 mm 				
2.04.00.30/6	10	62257.204.030	<ul style="list-style-type: none"> Maks. obciążenie dopuszczalne 550 N Min. siła niszcząca 1500 N Rozmiar długość x szerokość x wysokość : 42,5 x 41 x 12 mm 				
2.05.00.30/6	5	62257.205.030	<ul style="list-style-type: none"> 12 mm regulowane Maks. obciążenie dopuszczalne 1100 N Min. siła niszcząca 2500 N Rozmiar długość x szerokość x wysokość : 128 x 52 x 18 mm 				
2.05.02.30/6	10	62257.205.230	<ul style="list-style-type: none"> 12 mm regulowane Z zamkiem pomocniczym Maks. obciążenie dopuszczalne 1100 N Min. siła niszcząca 2500 N Rozmiar długość x szerokość x wysokość : 128 x 52 x 18 mm 				
2.06.00.30/6	10	62257.206.030	<ul style="list-style-type: none"> Maks. obciążenie dopuszczalne 1000 N Min. siła niszcząca 2500 N Rozmiar długość x szerokość x wysokość : 84 x 28 x 17 mm 				
2.06.01.30/6	10	62257.206.130	<ul style="list-style-type: none"> Zamykane na kłódkę Maks. obciążenie dopuszczalne 1000 N Min. siła niszcząca 2500 N Rozmiar długość x szerokość x wysokość : 84 x 28 x 17 mm 				
2.18.00.30/6	5	62257.218.030	<ul style="list-style-type: none"> 12 mm regulowane Maks. obciążenie dopuszczalne 1500 N Min. siła niszcząca 3000 N Rozmiar długość x szerokość x wysokość : 88 x 52 x 25 mm 				

62257 SZYBKI SYSTEM Zatrzaski przegubowe		←
Nr	<input type="checkbox"/>	Kod artykułu
2.41.00.30/6	10	62257.241.030
		<ul style="list-style-type: none"> • 10 mm regulowane • Maks. obciążenie dopuszczalne 1000 N • Min. siła niszcząca 2000 N • Rozmiar długość x szerokość x wysokość : 70 x 25,5 x 18 mm
2.43.00.30/6	10	62257.243.030
		<ul style="list-style-type: none"> • Maks. obciążenie dopuszczalne 550 N • Min. siła niszcząca 1500 N • Rozmiar długość x szerokość x wysokość : 45 x 23 x 12 mm

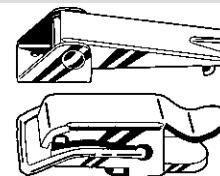

Zaczepty do zatrzasków przegubowych



Grupy katalogowe

Materiał	Obróbka powierzchni	Kod	Strona
St	Ocynk.	62265	10-64
St.St.		62267	10-65

62265 SZYBKI SYSTEM zaczepty do zatrzasków przegubowych		S04A
Materiał	Stal	
Obróbka powierzchni	Ocynkowane	

Nr	<input type="checkbox"/>	Kod artykułu		
2.00.00.04/5	5	62265.200.004	Odpowiednie dla zatrzasków przegubowych typ 2.00.00.04/6 i 2.00.01.04/6	
2.01.00.04/5	5	62265.201.004	Odpowiednie dla zatrzasków przegubowych typ 2.01.00.04/6	
2.02.00.04/5	10	62265.202.004	Odpowiednie dla zatrzasków przegubowych typ 2.02.00.04/6	
2.03.00.04/5	10	62265.203.004	Odpowiednie dla zatrzasków przegubowych typ 2.03.00.04/6 i 2.03.02.04/6	
2.04.00.04/5	10	62265.204.004	Odpowiednie dla zatrzasków przegubowych typ 2.04.00.04/6	
2.05.00.04/5	5	62265.205.004	Odpowiednie dla zatrzasków przegubowych typ 2.02.00.04/6, 2.06.00.04/6 i 2.06.01.04/6	
2.18.00.04/5	5	62265.218.004	Odpowiednie dla zatrzasków przegubowych typ 2.18.00.04/6 i 2.18.01.04/6	
2.40.00.08/5	5	62265.240.008	Odpowiednie dla zatrzasków przegubowych typ 2.40.00.08/6 i 2.40.01.08/6	

62265 SZYBKI SYSTEM zaczepy do zatrzasków przegubowych				←
Nr	✉	Kod artykułu		
2.41.00.08/5	10	62265.241.008	Odpowiednie dla zatrzasków przegubowych typ 2.41.00.08/6 i 2.41.01.08/6	
2.42.00.08/5	10	62265.242.008	Odpowiednie dla zatrzasków przegubowych typ 2.42.00.08/6 i 2.43.00.08/6	
2.44.00.08/5	10	62265.244.008	Odpowiednie dla zatrzasków przegubowych typ 2.45.00.08/6 i 2.17.00.04/6	

62267 SZYBKI SYSTEM Zaczepy do zatrzasków przegubowych		S04A
Materiał	Stal nierdzewna	

Nr	✉	Kod artykułu		
2.00.00.30/5	5	62267.200.030	Odpowiednie dla zatrzasków przegubowych typ 2.00.00.30/6 i 2.00.02.30/6	
2.01.00.30/5	5	62267.201.030	Odpowiednie dla zatrzasków przegubowych typ 2.01.00.30/6	
2.02.00.30/5	10	62267.202.030	Odpowiednie dla zatrzasków przegubowych typ 2.02.00.30/6	
2.03.00.30/5	10	62267.203.030	Odpowiednie dla zatrzasków przegubowych typ 2.03.00.30/6 i 2.03.02.30/6	
2.04.00.30/5	10	62267.204.030	Odpowiednie dla zatrzasków przegubowych typ 2.04.00.30/6	
2.05.00.30/5	5	62267.205.030	Odpowiednie dla zatrzasków przegubowych typ 2.05.00.30/6, 2.05.02.30/6, 2.06.00.30/6 i 2.06.01.30/6	
2.18.00.30/5	5	62267.218.030	Odpowiednie dla zatrzasków przegubowych typ 2.18.00.30/6	
2.41.00.30/5	10	62267.241.030	Odpowiednie dla zatrzasków przegubowych typ 2.41.00.30/6	
2.42.00.30/5	10	62267.242.030	Odpowiednie dla zatrzasków przegubowych typ 2.43.00.30/6	

FABORY QUICK SYSTEM

Zatrzaski zapadkowe

Zastosowanie

Zatrzaski zapadkowe FABORY QUICK SYSTEM są głównie stosowane do zamykania skrzynek instalacyjnych, drzwi szafek, szafek z urządzeniami, itd.

Montaż

Zatrzaski zapadkowe zamykające FABORY QUICK SYSTEM są montowane na panelu lub drzwiach. Mechanizm zamykania działa w ten sposób, że zapadka zamontowana na zamknięciu zatrzaskuje się za ramą zapewniając bezpieczne zamknięcie.

Działanie

Zatrzaski zapadkowe FABORY QUICK SYSTEM funkcjonują na tej samej zasadzie; istnieje jednak wybór, jeśli chodzi o rozmiar, metodę działania i produkcji, tj. materiał (czarny poliamid z częścią wewnętrzną z cynku, cynku chromowanego oraz stali nierdzewnej). Ze standardowymi modelami dostarczane są zarówno pierścienie wewnętrzne o przekroju okrągłym, jak i pierścienie uszczelniające pod feb, dzięki którym elementy złączne są odporne na pryskającą wodę zgodnie z IP65.

Typy

Zatrzaski zapadkowe FABORY QUICK SYSTEM są dostępne zarówno jako typ duży oraz mały.



Informacje techniczne i montażowe

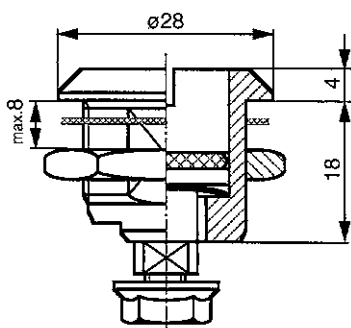

Typ duży

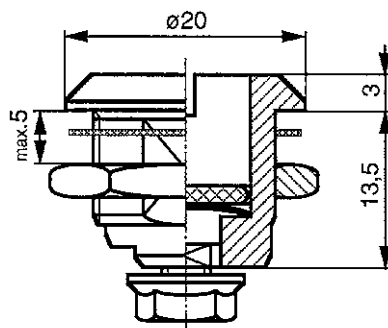

Typ mały

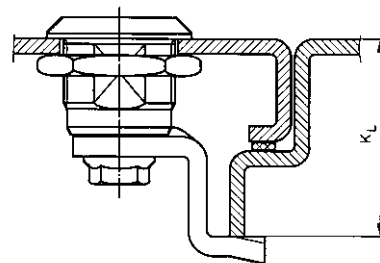

Zakres zacisku KL

Zamknięcia

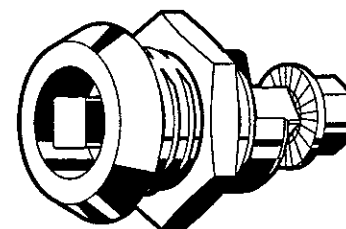

Grupy katalogowe

Material	Obróbka powierzchni	Kod	Strona
	Chrom.	62411	10-67
St.St.		62413	10-68

62411 SZYBKI SYSTEM Zamknięcia

S04A

Obróbka powierzchni Chromowany

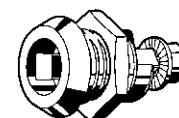

Nr	☒	Kod artykułu	
221178A	10	62411.221.178	<ul style="list-style-type: none"> Zamknięcie z kwadratem 6 mm Chromowany Dopasowany klucz, patrz grupa artykułów 62415, typ 291109
221179A	10	62411.221.179	<ul style="list-style-type: none"> Zamknięcie z trójkątem 6,5 mm Chromowany Dopasowany klucz, patrz grupa artykułów 62415, typ 291112
221180A	10	62411.221.180	<ul style="list-style-type: none"> Zamknięcie z łbem z rowkiem Chromowany
221308A	10	62411.221.308	<ul style="list-style-type: none"> Zamknięcie z kwadratem 7 mm Chromowany Dopasowany klucz, patrz grupa artykułów 62415, typ 291102
221308B	10	62411.221.309	<ul style="list-style-type: none"> Zamknięcie z kwadratem 7 mm Czarny poliamid z wewnętrznymi elementami z cynku Dopasowany klucz, patrz grupa artykułów 62415, typ 291102
221313A	10	62411.221.313	<ul style="list-style-type: none"> Blokująca z trójkątem 8 mm Chromowany Dopasowany klucz, patrz grupa artykułów 62415, typ 291102
221313B	10	62411.221.314	<ul style="list-style-type: none"> Blokująca z trójkątem 8 mm Czarny poliamid z wewnętrznymi elementami z cynku Dopasowany klucz, patrz grupa artykułów 62415, typ 291102
221316A	10	62411.221.316	<ul style="list-style-type: none"> Zamknięcie z podwójną płytką 3 mm Chromowany Dopasowany klucz, patrz grupa artykułów 62415, typ 291102
221316B	10	62411.221.317	<ul style="list-style-type: none"> Blokująca z podwójną płytką 3 mm Czarny poliamid z wewnętrznymi elementami z cynku Dopasowany klucz, patrz grupa artykułów 62415, typ 291102

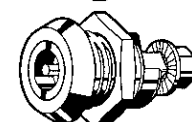
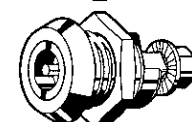
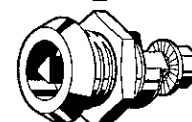
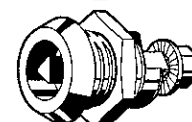
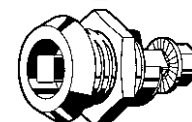
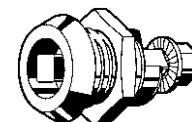
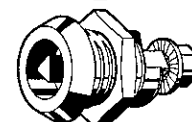
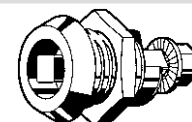

62411		SZYBKI SYSTEM Zamknięcia				←
Nr	☒	Kod artykułu				
221320A	10	62411.221.320	<ul style="list-style-type: none"> Zamknięcie z łbem z rowkiem Chromowany 			
221320B	10	62411.221.321	<ul style="list-style-type: none"> Zamknięcie z łbem z rowkiem Czarny poliamid z wewnętrznymi elementami z cynku 			
241334	1	62411.241.334	<ul style="list-style-type: none"> Zamknięcie z zamkiem bębnowym Identyczne zamknięte Dostarczane są 2 klucze Chromowany 			
241336	1	62411.241.336	<ul style="list-style-type: none"> Zamknięcie z zamkiem bębnowym Nie identyczne zamknięte Dostarczane są 2 klucze Chromowany 			
251350	1	62411.251.350	<ul style="list-style-type: none"> Zamknięcie z rączką w kształcie T Chromowany 			
251352	1	62411.251.352	<ul style="list-style-type: none"> Zamknięcie z rączką w kształcie T z zamkiem bębnowym Identyczne zamki Dostarczane są 2 klucze Chromowany 			
251354	1	62411.251.354	<ul style="list-style-type: none"> Blokująca z rączką T z cylindrem zamka Nie identyczne zamknięte Dostarczane są 2 klucze Chromowany 			
295074A	10	62411.295.074	<ul style="list-style-type: none"> Zamknięcie z łbem skrzydełkowym Chromowany 			
295074B	10	62411.295.075	<ul style="list-style-type: none"> Zamknięcie z łbem skrzydełkowym Czarny poliamid z wewnętrznymi elementami z cynku 			

62413		SZYBKI SYSTEM zabezpieczenia				S04A
Materiał	Stal nierdzewna					

10

Nr	☒	Kod artykułu				
223003A	1	62413.213.003	<ul style="list-style-type: none"> Dopasowany klucz, patrz typ 291102, grupa artykułów 62415. 			
223013A	1	62413.213.005	<ul style="list-style-type: none"> Dopasowany klucz, patrz typ 291105, grupa artykułów 62415. 			
223016A	1	62413.213.006	<ul style="list-style-type: none"> Dopasowany klucz, patrz typ 291107, grupa artykułów 62415. 			

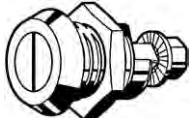
62413 SZYBKI SYSTEM zabezpieczenia				←
Nr	☒	Kod artykułu		
223020A	1	62413.213.008	• Szczelina	







Zapadki



Grupy katalogowe

Materiał	Obróbka powierzchni	Kod	Strona
St	Ocynk.	62412	10-69
St.St.		62414	10-71

62412 SZYBKI SYSTEM Zapadki		S04A
Materiał	Stal	
Obróbka powierzchni	Ocynkowane	
		



Nr	☒	Kod artykułu		
232101	10	62412.232.101	• Zapadka 1-punktowa. • Odpowiednie dla zamknięć, typ duży. • Zakres uchwytu 4mm.	
232102	10	62412.232.102	• Zapadka 1-punktowa. • Odpowiednie dla zamknięć, typ duży. • Zakres uchwytu 6mm.	
232103	10	62412.232.103	• Zapadka 1-punktowa. • Odpowiednie dla zamknięć, typ duży. • Zakres uchwytu 8mm.	
232104	10	62412.232.104	• Zapadka 1-punktowa. • Odpowiednie dla zamknięć, typ duży. • Zakres uchwytu 10mm.	
232105	10	62412.232.105	• Zapadka 1-punktowa. • Odpowiednie dla zamknięć, typ duży. • Zakres uchwytu 12mm.	
232106	10	62412.232.106	• Zapadka 1-punktowa. • Odpowiednie dla zamknięć, typ duży. • Zakres uchwytu 13mm.	
232107	10	62412.232.107	• Zapadka 1-punktowa. • Odpowiednie dla zamknięć, typ duży. • Zakres uchwytu 14mm.	

62412 SZYBKI SYSTEM Zapadki				←
Nr	☒	Kod artykułu		
232108	10	62412.232.108	<ul style="list-style-type: none"> • Zapadka 1-punktowa. • Odpowiednie dla zamknięć, typ duży. • Zakres uchwytu 16mm. 	
232109	10	62412.232.109	<ul style="list-style-type: none"> • Zapadka 1-punktowa. • Odpowiednie dla zamknięć, typ duży. • Zakres uchwytu 18mm. 	
232110	10	62412.232.110	<ul style="list-style-type: none"> • Zapadka 1-punktowa. • Odpowiednie dla zamknięć, typ duży. • Zakres uchwytu 20mm. 	
232111	10	62412.232.111	<ul style="list-style-type: none"> • Zapadka 1-punktowa. • Odpowiednie dla zamknięć, typ duży. • Zakres uchwytu 22mm. 	
232112	10	62412.232.112	<ul style="list-style-type: none"> • Zapadka 1-punktowa. • Odpowiednie dla zamknięć, typ duży. • Zakres uchwytu 24mm. 	
232113	10	62412.232.113	<ul style="list-style-type: none"> • Zapadka 1-punktowa. • Odpowiednie dla zamknięć, typ duży. • Zakres uchwytu 25mm. 	
232114	10	62412.232.114	<ul style="list-style-type: none"> • Zapadka 1-punktowa. • Odpowiednie dla zamknięć, typ duży. • Zakres uchwytu 26mm. 	
232115	10	62412.232.115	<ul style="list-style-type: none"> • Zapadka 1-punktowa. • Odpowiednie dla zamknięć, typ duży. • Zakres uchwytu 28mm. 	
232136	10	62412.232.136	<ul style="list-style-type: none"> • Zapadka 3-punktowa. • Odpowiednie dla zamknięć, typ duży. • Zakres uchwytu 18mm. • Odpowiednie do zasuw zamykających. • Oddzielnie dostarczane są 2 podkładki zabezpieczające (do montażu z zasuwą zabezpieczającą). 	
232137	10	62412.232.137	<ul style="list-style-type: none"> • Zapadka 3-punktowa. • Odpowiednie dla zamknięć, typ duży. • Zakres uchwytu 20mm. • Odpowiednie do zasuw zamykających. • Oddzielnie dostarczane są 2 podkładki zabezpieczające (do montażu z zasuwą zabezpieczającą). 	
232138	10	62412.232.138	<ul style="list-style-type: none"> • Zapadka 3-punktowa. • Odpowiednie dla zamknięć, typ duży. • Zakres uchwytu 22mm. • Odpowiednie do zasuw zamykających. • Oddzielnie dostarczane są 2 podkładki zabezpieczające (do montażu z zasuwą zabezpieczającą). 	
232139	10	62412.232.139	<ul style="list-style-type: none"> • Zapadka 3-punktowa. • Odpowiednie dla zamknięć, typ duży. • Zakres uchwytu 24mm. • Odpowiednie do zasuw zamykających. • Oddzielnie dostarczane są 2 podkładki zabezpieczające (do montażu z zasuwą zabezpieczającą). 	
232141	10	62412.232.141	<ul style="list-style-type: none"> • Zapadka 3-punktowa. • Odpowiednie dla zamknięć, typ duży. • Zakres uchwytu 26mm. • Odpowiednie do zasuw zamykających. • Oddzielnie dostarczane są 2 podkładki zabezpieczające (do montażu z zasuwą zabezpieczającą). 	
232142	10	62412.232.142	<ul style="list-style-type: none"> • Zapadka 3-punktowa. • Odpowiednie dla zamknięć, typ duży. • Zakres uchwytu 28mm. • Odpowiednie do zasuw zamykających. • Oddzielnie dostarczane są 2 podkładki zabezpieczające (do montażu z zasuwą zabezpieczającą). 	

62412		SZYBKI SYSTEM Zapadki				←
Nr	☒	Kod artykułu				
232155	10	62412.232.155	<ul style="list-style-type: none"> • Zapadka 1-punktowa. • Odpowiednie dla zamknięć, typ mały. • Zakres uchwytu 7,5mm. 			
232160	10	62412.232.160	<ul style="list-style-type: none"> • Zapadka 1-punktowa. • Odpowiednie dla zamknięć, typ mały. • Zakres uchwytu 13,5mm. 			
232164	10	62412.232.164	<ul style="list-style-type: none"> • Zapadka 1-punktowa. • Odpowiednie dla zamknięć, typ mały. • Zakres uchwytu 19,5mm. 			

62414		SZYBKI SYSTEM Zapadki				S04A
Materiał	Stal nierdzewna					

Nr	☒	Kod artykułu				
233004	1	62414.233.004	<ul style="list-style-type: none"> • Zapadka 1-punktowa. • Odpowiednie dla zamków, typ duży. • Zakres uchwytu 10mm. 			
233005	1	62414.233.005	<ul style="list-style-type: none"> • Zapadka 1-punktowa. • Odpowiednie dla zamków, typ duży. • Zakres uchwytu 12mm. 			
233006	1	62414.233.006	<ul style="list-style-type: none"> • Zapadka 1-punktowa. • Odpowiednie dla zamków, typ duży. • Zakres uchwytu 13mm. 			
233007	1	62414.233.007	<ul style="list-style-type: none"> • Zapadka 1-punktowa. • Odpowiednie dla zamków, typ duży. • Zakres uchwytu 14mm. 			
233008	1	62414.233.008	<ul style="list-style-type: none"> • Zapadka 1-punktowa. • Odpowiednie dla zamków, typ duży. • Zakres uchwytu 16mm. 			
233009	1	62414.233.009	<ul style="list-style-type: none"> • Zapadka 1-punktowa. • Odpowiednie dla zamków, typ duży. • Zakres uchwytu 18mm. 			
233010	1	62414.233.010	<ul style="list-style-type: none"> • Zapadka 1-punktowa. • Odpowiednie dla zamków, typ duży. • Zakres uchwytu 20mm. 			
233011	1	62414.233.011	<ul style="list-style-type: none"> • Zapadka 1-punktowa. • Odpowiednie dla zamków, typ duży. • Zakres uchwytu 22mm. 			
233012	1	62414.233.012	<ul style="list-style-type: none"> • Zapadka 1-punktowa. • Odpowiednie dla zamków, typ duży. • Zakres uchwytu 24mm. 			

62414 SZYBKI SYSTEM Zapadki		←		
Nr	☒	Kod artykułu		
233013	1	62414.233.013	<ul style="list-style-type: none"> • Zapadka 1-punktowa. • Odpowiednie dla zamków, typ duży. • Zakres uchwytu 25mm. 	
233014	1	62414.233.014	<ul style="list-style-type: none"> • Zapadka 1-punktowa. • Odpowiednie dla zamków, typ duży. • Zakres uchwytu 26mm. 	
233015	1	62414.233.015	<ul style="list-style-type: none"> • Zapadka 1-punktowa. • Odpowiednie dla zamków, typ duży. • Zakres uchwytu 28mm. 	

Quick system - klucze

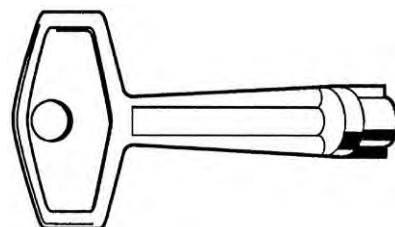

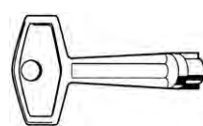
62415 Quick system - klucze		S04A
		

Nr	☒	Kod artykułu		
291102	1	62415.291.102	<ul style="list-style-type: none"> • Odpowiednie dla zamków, typ duży • Cynk • Kwadrat 7 mm 	
291103	1	62415.291.103	<ul style="list-style-type: none"> • Odpowiednie dla zamków, typ duży • Cynk • Kwadrat 8 mm 	
291104	1	62415.291.104	<ul style="list-style-type: none"> • Odpowiednie dla zamków, typ duży • Cynk • Trójkąt 7 mm 	
291105	1	62415.291.105	<ul style="list-style-type: none"> • Odpowiednie dla zamków, typ duży • Cynk • Trójkąt 8 mm 	
291107	1	62415.291.107	<ul style="list-style-type: none"> • Odpowiednie dla zamków, typ duży • Cynk • Podwójna płytką 3 mm 	
291108	1	62415.291.108	<ul style="list-style-type: none"> • Odpowiednie dla zamków, typ duży • Cynk • Podwójna płytką 5 mm 	
291109	1	62415.291.109	<ul style="list-style-type: none"> • Odpowiednie dla zamków, typ mały • Cynk • Kwadrat 6 mm 	

62415 Quick system - klucze		←
Nr	✉	Kod artykułu
291112	1	62415.291.112 <ul style="list-style-type: none"> • Odpowiednie dla zamków, typ mały • Cynk • Trójkąt 6,5 mm



Akcesoria do zapadek



62416 SZYBKI SYSTEM Akcesoria do zapadek		S04A

Nr	✉	Kod artykułu	
282103	4	62416.282.103	<ul style="list-style-type: none"> • Zasuwa zamykająca bez prowadnic • Długość 600 mm
282107	4	62416.282.107	<ul style="list-style-type: none"> • Zasuwa zamykająca bez prowadnic • Długość 1000 mm
282113	4	62416.282.113	<ul style="list-style-type: none"> • Zasuwa zamykająca bez prowadnic • Łącze pośredniczące należy zamówić oddzielnie • Długość 600 mm
282116	4	62416.282.116	<ul style="list-style-type: none"> • Zasuwa zamykająca z prowadnicami • Łącze pośredniczące należy zamówić oddzielnie • Długość 1000 mm
282119	4	62416.282.119	<ul style="list-style-type: none"> • Łącze pośredniczące • Cynk • Odpowiedni do zasuwy zamykającej z prowadnicami

Prowadzenia zapadek zamykających

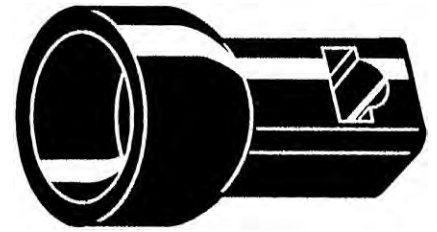

62417 SZYBKI SYSTEM Prowadzenia zapadek zamykających S04A

Material Plastik Poliamid (nylon)



Nr	☒	Kod artykułu	
200-3601	4	62417.203.601	<ul style="list-style-type: none"> • Typ 258 024 • Wielkość A-20 / B-32
200-3602	4	62417.203.602	<ul style="list-style-type: none"> • Typ 258 023 • Wielkość A-26 / B-38



FABORY QUICK SYSTEM

Elementy złączne ćwierć-obrotowe

Informacje ogólne

Elementy złączne ćwierć-obrotowe FABORY QUICK SYSTEM są prostymi, szybkimi i niezawodnymi elementami złącznymi przeznaczonymi do łączenia paneli z ramą lub części ze sobą.

Zastosowanie

Elementy złączne ćwierć-obrotowe FABORY QUICK SYSTEM są przeznaczone do montowania paneli lub części, które muszą być usunięte lub zastąpione, w szybki i przyjazny do obsługi sposób. Nie ma znaczenia, czy czynność tą należy wykonać raz na miesiąc, czy kilka razy w ciągu godziny.

Zasada

W najprostszej formie, element złączny ćwierć-obrotowy FABORY QUICK SYSTEM, składa się ze śruby dwustronnej montowanej w panelu za pomocą elementu ustalającego i oprawki montowanej w ramie.

Montaż

Elementy złączne ćwierć-obrotowe FABORY QUICK SYSTEM mocuje się przez wciśnięcie, a ćwierć obrotu rozłącza połączenie, informacji montażowych szukaj poniżej.

Informacje montażowe

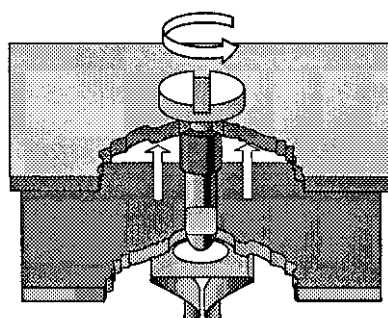

Otwarte

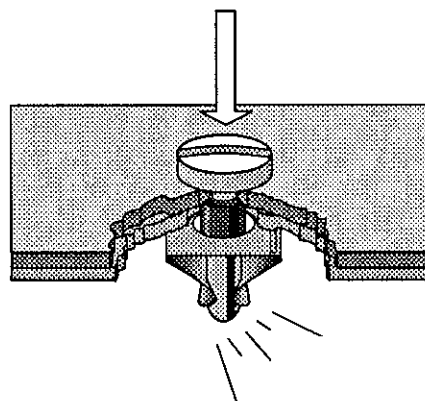

Zamknięte

Sworznie z łbem z rowkiem

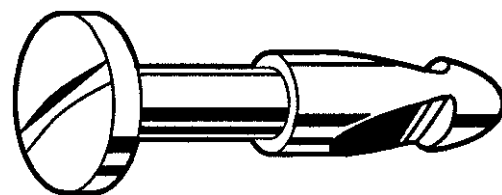

62272	SZYBKI SYSTEM Sworznie z łbem z rowkiem	S04A
Materiał	Mosiądz	
Obróbka powierzchni	Niklowane	

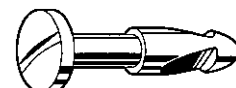

Nr	☒	Kod artykułu	Nr	☒	Kod artykułu	Nr	☒	Kod artykułu
D 0802	25	62272.000.802	D 1107	25	62272.001.107	D 1122	25	62272.001.122
D 0803	25	62272.000.803	D 1108	25	62272.001.108	D 1604	25	62272.001.604
D 0804	25	62272.000.804	D 1109	25	62272.001.109	D 1606	25	62272.001.606
D 0805	25	62272.000.805	D 1110	25	62272.001.110	D 1608	25	62272.001.608
D 0806	25	62272.000.806	D 1111	25	62272.001.111	D 1610	25	62272.001.610
D 0807	25	62272.000.807	D 1112	25	62272.001.112	D 1612	25	62272.001.612
D 0808	25	62272.000.808	D 1114	25	62272.001.114	D 1614	25	62272.001.614
D 1103	25	62272.001.103	D 1116	25	62272.001.116	D 1616	25	62272.001.616
D 1104	25	62272.001.104	D 1118	25	62272.001.118	D 1618	25	62272.001.618
D 1105	25	62272.001.105	D 1120	25	62272.001.120	D 1620	25	62272.001.620
D 1106	25	62272.001.106						

Sworznie z łbem skrzydełkowym

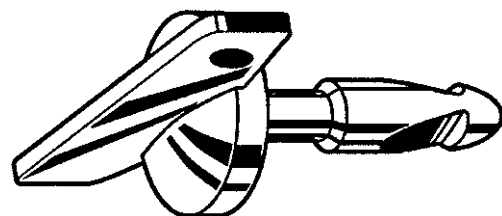

62273	SZYBKI SYSTEM Sworznie z łbem skrzydełkowym	S04A
Materiał	Mosiądz	
Obróbka powierzchni	Niklowane	

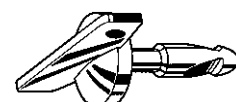

Nr	☒	Kod artykułu	Nr	☒	Kod artykułu	Nr	☒	Kod artykułu
W 0802	25	62273.000.802	W 1107	25	62273.001.107	W 1122	25	62273.001.122
W 0803	25	62273.000.803	W 1108	25	62273.001.108	W 1604	25	62273.001.604
W 0804	25	62273.000.804	W 1109	25	62273.001.109	W 1606	25	62273.001.606
W 0805	25	62273.000.805	W 1110	25	62273.001.110	W 1608	25	62273.001.608
W 0806	25	62273.000.806	W 1111	25	62273.001.111	W 1610	25	62273.001.610
W 0807	25	62273.000.807	W 1112	25	62273.001.112	W 1612	25	62273.001.612
W 0808	25	62273.000.808	W 1114	25	62273.001.114	W 1614	25	62273.001.614
W 1103	25	62273.001.103	W 1116	25	62273.001.116	W 1616	25	62273.001.616
W 1104	25	62273.001.104	W 1118	25	62273.001.118	W 1618	25	62273.001.618
W 1105	25	62273.001.105	W 1120	25	62273.001.120	W 1620	25	62273.001.620
W 1106	25	62273.001.106						

Sworznie z łbem radełkowanym z rowkiem

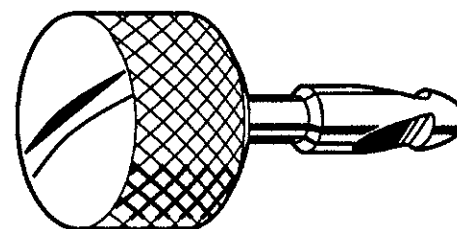

62274 SZYBKI SYSTEM Sworznie z łbem radełkowanym z rowkiem, typ K S04A

Materiał Mosiądz
Obróbka powierzchni Niklowane

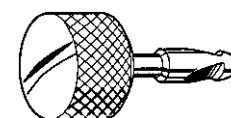

Nr	☒	Kod artykułu	Nr	☒	Kod artykułu	Nr	☒	Kod artykułu
K 0803	25	62274.000.803	K 1107	25	62274.001.107	K 1606	25	62274.001.606
K 0804	25	62274.000.804	K 1108	25	62274.001.108	K 1608	25	62274.001.608
K 0805	25	62274.000.805	K 1110	25	62274.001.110	K 1610	25	62274.001.610
K 0806	25	62274.000.806	K 1112	25	62274.001.112	K 1612	25	62274.001.612
K 0808	25	62274.000.808	K 1114	25	62274.001.114	K 1614	25	62274.001.614
K 1103	25	62274.001.103	K 1116	25	62274.001.116	K 1616	25	62274.001.616
K 1104	25	62274.001.104	K 1118	25	62274.001.118	K 1618	25	62274.001.618
K 1105	25	62274.001.105	K 1120	25	62274.001.120	K 1620	25	62274.001.620
K 1106	25	62274.001.106	K 1122	25	62274.001.122			

Sworznie kulowe



62276 SZYBKI SYSTEM sworznie kulowe, typ KB S04A





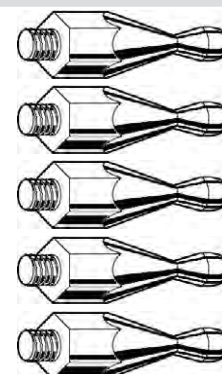

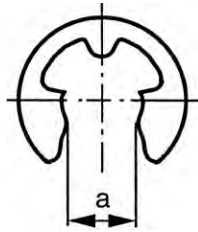
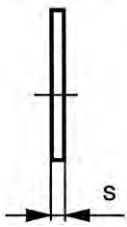

Typ	☒	Kod artykułu	
KB 08 M4 S=7	25	62276.408.010	• Mosiądz niklowany.
KB 08 M5 S=11	25	62276.508.020	• Mosiądz niklowany.
KB 08 M5 S=111	25	62276.508.040	• Mosiądz niklowany.
KB 1615 M6X7 S=8	25	62276.616.150	• Stal cynkowana, pasywacja na żółto.
KB 1615 M6X15 S=8	25	62276.616.151	• Stal cynkowana, pasywacja na żółto.



Podkładka zabezpieczająca



62282	SZYBKI SYSTEM Podkładka zabezpieczająca	S04A
Materiał	Stal sprężynowa	

Wymiar nominalny	☒	Kod artykułu		
2,3MM	25	62282.023.001	<ul style="list-style-type: none"> Podkładka ustalająca (element ustalający sworznia) Stal sprężynowa, fosforowana 	
4MM	25	62282.040.001	<ul style="list-style-type: none"> Podkładka ustalająca (element ustalający sworznia) Stal sprężynowa, fosforowana 	
4MM	25	62282.040.002	<ul style="list-style-type: none"> Podkładka ustalająca (element ustalający sworznia) Stal sprężynowa, powlekana brązem i lakierowana 	
6MM	25	62282.060.002	<ul style="list-style-type: none"> Podkładka ustalająca (element szybko ustalający) Stal sprężynowa, powlekana brązem i lakierowana 	
8 MM	25	62282.080.001	<ul style="list-style-type: none"> Podkładka ustalająca (element ustalający sworznia) Stal sprężynowa, fosforowana 	
10MM	25	62282.100.002	<ul style="list-style-type: none"> Podkładka ustalająca (element szybko ustalający) Stal sprężynowa, powlekana brązem i lakierowana 	

Pierścienie ustalające

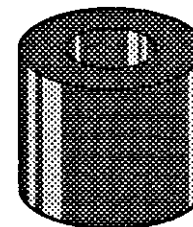

Grupy katalogowe

Material		Kod	Strona
Neopren	R	62283	10-79
Neopren	RC	62284	10-79

62283 SZYBKI SYSTEM Pierścienie ustalające, typ R S04A

Material Neopren



Nr	☒	Kod artykułu	Nr	☒	Kod artykułu	Nr	☒	Kod artykułu
R 1208	25	62283.001.208	R 2511	25	62283.002.511	R 4808	25	62283.004.808
R 1708	25	62283.001.708	R 2516	25	62283.002.516	R 5011	25	62283.005.011
R 1711	25	62283.001.711	R 3208	25	62283.003.208	R 5616	25	62283.005.616
R 1716	25	62283.001.716	R 4011	25	62283.004.011	R 6011	25	62283.006.011
R 2508	25	62283.002.508	R 4016	25	62283.004.016			

62284 SZYBKI SYSTEM Pierścienie ustalające, typ RC S04A

Material Neopren



Nr	☒	Kod artykułu	Nr	☒	Kod artykułu	Nr	☒	Kod artykułu
RC 4008	25	62284.004.008	RC 6011/3	25	62284.060.113	RC 6011/6	25	62284.060.116

- Odpowiednie tylko do zacisku trzyczęściowego typ CR, patrz kod grupy 62325.

Podkładka ochronna

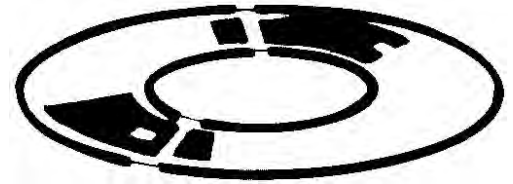

62285 SZYBKI SYSTEM Podkładki ochronne		S04A	
Materiał	Plastik Poliamid (nylon)		
Klasa	6		
			
Nr	✉ Kod artykułu	Nr	✉ Kod artykułu
RT 0208	25 62285.000.208	RT 0211	25 62285.000.211
		RT 0216	25 62285.000.216

Pierścienie uszczelniające

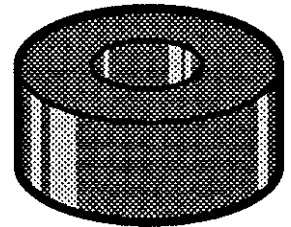

62286 SZYBKI SYSTEM Pierścienie uszczelniające, typ RW		S04A	
Materiał	Neopren		
			
Nr	✉ Kod artykułu	Nr	✉ Kod artykułu
RW 0511	25 62286.000.511	RW 1508	25 62286.001.508
RW 1011	25 62286.001.011	RW 1511	25 62286.001.511
		RW 2011	25 62286.002.011
		RW 2016	25 62286.002.016

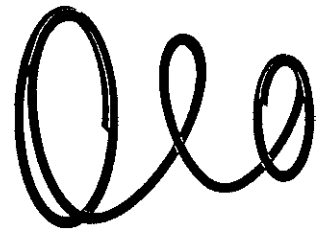

Sprężyny zabezpieczające stożkowe



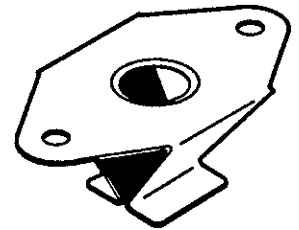

62302 SZYBKI SYSTEM Sprężyny zabezpieczające stożkowe		S04A	
Materiał		Stal sprężynowa	
		 	
Nr	✉ Kod artykułu	Nr	✉ Kod artykułu
KF 08	25 62302.000.008	KF 11	25 62302.000.011
		KF 16	25 62302.000.016

Płytki sprężyste do nitów



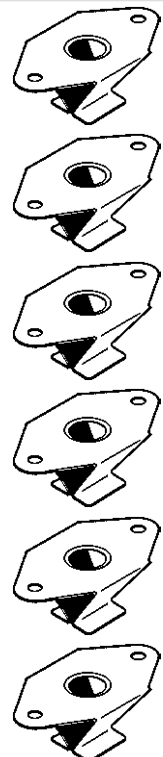

62303 SZYBKI SYSTEM Płytki sprężyste do nitów		S04A	
		 	
Nr	✉ Kod artykułu		
C 08/2,6	25 62303.080.001	•	Stal cynkowana.
C 08/19	25 62303.080.002	•	Stal cynkowana.
C 08/2,6	25 62303.080.003	•	Stal nierdzewna.
C 11	25 62303.110.001	•	Stal cynkowana.
C 11	25 62303.110.002	•	Stal nierdzewna.
C 16	25 62303.160.001	•	Stal cynkowana.

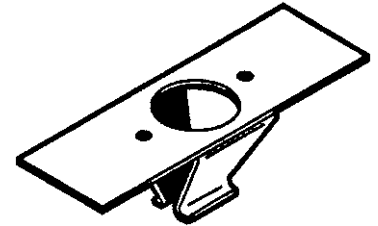

62303		SZYBKI SYSTEM Płytki sprężyste do nitów		←
Nr	✉	Kod artykułu		
C 16	25	62303.160.002	• Stal nierdzewna.	

Płytki sprężyste do zgrzewania



62304		SZYBKI SYSTEM Płytki sprężyste do zgrzewania		S04A
				



Nr	✉	Kod artykułu		
CP 08	25	62304.000.008	• Stal cynkowana.	
CP 11	25	62304.000.011	• Stal cynkowana.	
CP 16	25	62304.000.016	• Stal cynkowana.	
C 08/MSN	25	62304.080.004	• Stal nierdzewna.	

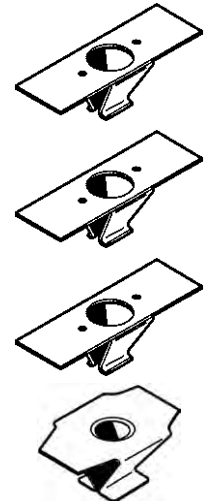

Oprawki sprężyste ślizgowe

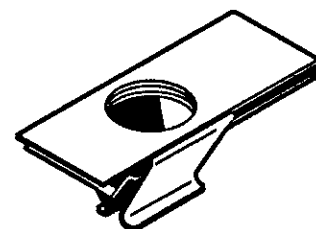

62305 SZYBKI SYSTEM Oprawki sprężyste ślizgowe

S04A

Materiał Stal
Obróbka powierzchni Ocynkowane

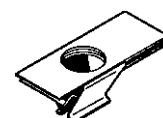

Nr	☒	Kod artykułu	
CS 08/1,4	25	62305.080.001	• Dla ramy grubości: 0,5 - 1,4 mm.
CS 08/3,0	25	62305.080.003	• Dla ramy grubości: 1,5 - 3,0 mm.

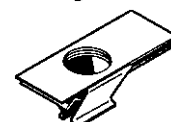

Wspornik sprężynujący

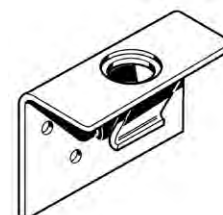

62306 SZYBKI SYSTEM Wspornik sprężynujący

S04A

Materiał Stal
Obróbka powierzchni Ocynkowane



Typ	☒	Kod artykułu	
MSC 08/1	25	62306.080.001	
MSCR 08	25	62306.080.002	
MSC 11/1	25	62306.110.001	
MSCR 11	25	62306.110.002	

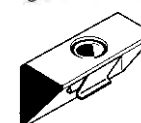
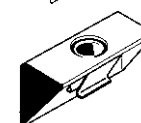

10





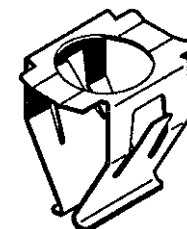

62306 SZYBKI SYSTEM Wspornik sprężynujący			←
Typ	☒	Kod artykułu	
MSC 16/1	25	62306.160.001	
MSCR 16	25	62306.160.002	

Oprawki wprowadzane od przodu



62323 SZYBKI SYSTEM Oprawki wprowadzane od przodu			S04A
Materiał	Stal		
			 

Nr	☒	Kod artykułu		
CC 08/1	25	62323.080.001	• Stal cynkowana	
CC 08/2	25	62323.080.002	• Stal cynkowana	
CC 08/3	25	62323.080.003	• Stal cynkowana	
CC 08/4	25	62323.080.004	• Stal cynkowana	
CC 11/1	25	62323.110.001	• Stal cynkowana	
CC 11/2	25	62323.110.002	• Stal cynkowana	
CC 11/3	25	62323.110.003	• Stal cynkowana	
CC 11/4	25	62323.110.004	• Stal cynkowana	

62323		SZYBKI SYSTEM Oprawki wprowadzane od przodu		←
Nr	☒	Kod artykułu		
CX11/15	25	62323.110.015	• Stal nierdzewna	
CX11/20	25	62323.110.020	• Stal nierdzewna	
CX11/25	25	62323.110.025	• Stal nierdzewna	
CC 16/1	25	62323.160.001	• Stal cynkowana	
CC 16/2	25	62323.160.002	• Stal cynkowana	
CC 16/3	25	62323.160.003	• Stal cynkowana	
CC 16/4	25	62323.160.004	• Stal cynkowana	

Zaciski trzyczęściowe

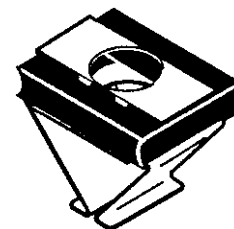

62325 SZYBKI SYSTEM Zaciski trzyczęściowe, Type CR

S04A



Nr	✉	Kod artykułu	Nr	✉	Kod artykułu	Nr	✉	Kod artykułu
CR1008	25	62325.001.008	CR2008	25	62325.002.008	CR2011	25	62325.002.011
CR1508	25	62325.001.508						

- Stal nierdzewna/stal z pierścieniem neoprenowym.
- Do pierścienia ustalającego typu RC, patrz grupa artykułów 62284.

Kompensator tolerancji

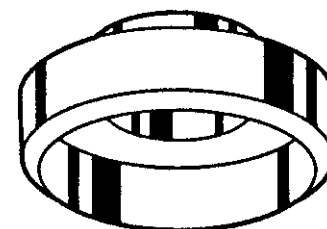

62332 SZYBKI SYSTEM Kompensatory tolerancji

S04A

Kolor Różny



Typ	✉	Kod artykułu	
TA 08	25	62332.080.001	• Mosiądz niklowany.
TAR 08	25	62332.080.002	• Czarny plastik.
TA 11	25	62332.110.001	• Mosiądz niklowany.
TA 16	25	62332.160.001	• Mosiądz niklowany.
TAR 16	25	62332.160.002	• Czarny plastik.

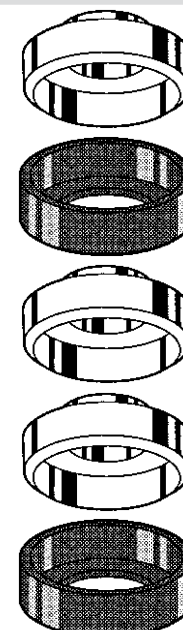

Wkładki, typ C

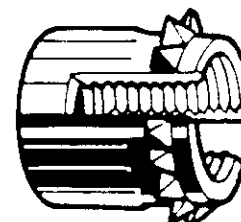
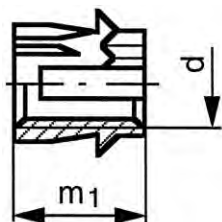

Informacje techniczne

d	m ₁	P	Wiertło ø	d	m ₁	P	Wiertło ø
M3	5	0.5	4.7	M5	6	0.8	6.8
M4	5	0.7	5.6	M6	7	1	7.7

- Cechy szczególne wkładek:
Są odpowiednie do szybkiego i efektywnego zapewnienia mocnego gwintu izometrycznego w miękkich materiałach, jak plastik, drewno, płyta wiórowa i aluminium.
- Podczas montażu zęby osadzają się w ścianach otworu.
- Połączenie jest samozabezpieczającym przed drganiami i wstrząsami.
- Typ C, z jednym rzędem zębów jest zalecany do niskich sił i żądszego demontażu.

64010 Wkładki, typ C

N07A

Gwint Metryczny
Materiał Mosiądz

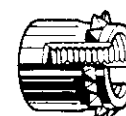

d	☒	Kod artykułu	d	☒	Kod artykułu	d	☒	Kod artykułu
M3	200	64010.030.001	M5	100	64010.050.001	M6	100	64010.060.001
M4	200	64010.040.001						

Wkładki, typ D

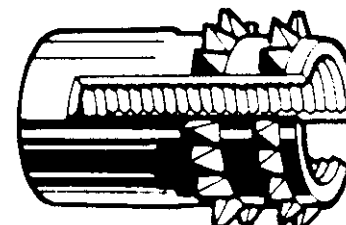
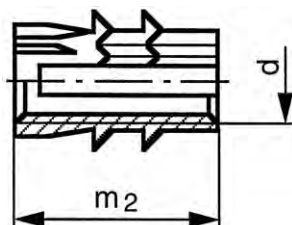

Informacje techniczne

d	m ₂	P	Wiertło ø	d	m ₂	P	Wiertło ø
M3	9.5	0.5	4.7	M6	9	1	7.7
M4	9.5	0.7	5.6	M8	10	1.25	9.6
M5	9.5	0.8	6.8				

- Cechy szczególne wkładek:
Są odpowiednie do szybkiego i efektywnego zapewnienia mocnego gwintu izometrycznego w miękkich materiałach, jak plastik, drewno, płyta wiórowa i aluminium.
- Podczas montażu zęby osadzają się w ścianach otworu.
- Połączenie jest samozabezpieczone przed drganiami i wstrząsami.
- Typ D z dwoma rzędami zębów może być stosowany do drewna, większych sił i częstszego demontażu.

64050 Wkładki, typ D

N07A

Gwint Metryczny
Materiał Mosiądz



d	☒	Kod artykułu	d	☒	Kod artykułu	d	☒	Kod artykułu
M3	200	64050.030.001	M5	100	64050.050.001	M8	100	64050.080.001
M4	200	64050.040.001	M6	100	64050.060.001			

Wkładki, typ E

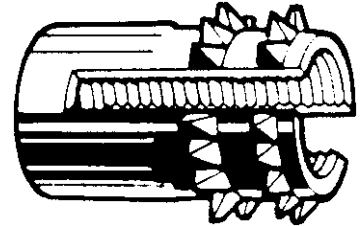
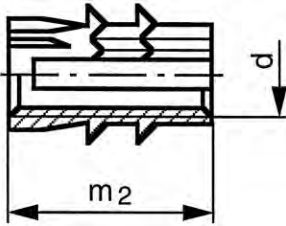



Informacje techniczne

d	m ₂	P	Wiertło ø
M3	8	0.5	4.7
M4	8	0.7	5.6

Specjalne właściwości wkładek:

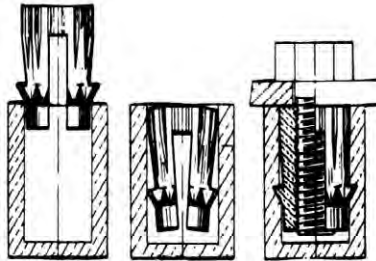
- odpowiednio zabezpieczają miękkie materiały, jak plastik, drewno, płyta wiórowa i aluminium, wyposażone w mocny ISO-metryczny gwint, są montowane w prosty i wydajny sposób
- podczas montażu zęby zahaczają się (mocują) w ścianie otworu
- połączenie jest samozabezpieczone przed drganiami i wstrząsami
- typ E (krótsza wersja typu D) z dwoma rzędami zębów może być użyty do drewna, tam gdzie działają większe siły oraz przy częstszym demontażu.

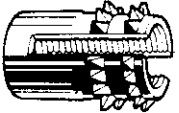

64030	Wkładki, typ E	N07A
Gwint	Metryczny	
Materiał	Mosiądz	
		
		

d	☒	Kod artykułu	d	☒	Kod artykułu
M3	200	64030.030.001	M4	200	64030.040.001

Wkładki wkręcane, typ 530

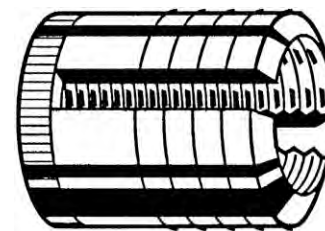
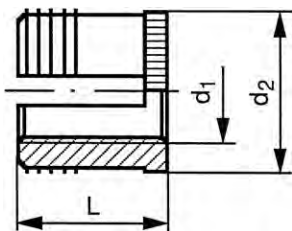

Informacje techniczne

d ₁	d ₂	L	P	Wierćto ø
M3	4.3	4.8	0.5	4
M4	5.9	8	0.7	5.6
M5	6.7	9.5	0.8	6.4
M6	8.3	12.7	1	8
M8	9.9	12.7	1.25	9.5

- Zalecane jest, aby wyboru dokładnej średnicy dokonać na podstawie testów.

71570 Wkładki wkręcane, typ 530

N07A

Gwint Metryczny
Materiał Mosiądz

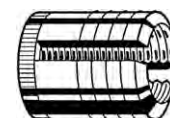

d ₁	☒	Kod artykułu	d ₁	☒	Kod artykułu	d ₁	☒	Kod artykułu
M3	200	71570.030.001	M5	100	71570.050.001	M8	100	71570.080.001
M4	200	71570.040.001	M6	100	71570.060.001			

Nakrętki pazurkowe

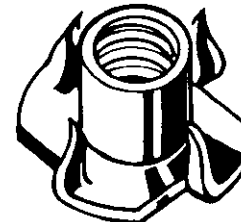
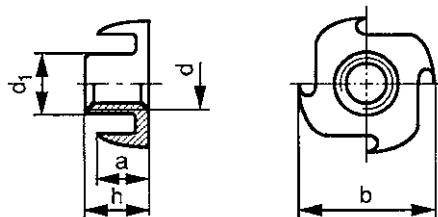

Informacje techniczne

d	a	b	d ₁	h	P
M3	3.5	13	4.3	5	0.5
M4	4.5	15	5	8	0.7
M5	5.5	17	6.3	8	0.8
M6	7	19	7.3	9	1
M8	7.5	22	9.7	11	1.25
M10	9	25	11.9	12	1.5
M12	9.5	27	13.7	14.5	1.75

Grupy katalogowe

Gwint	Materiał	Obróbka powierzchni	Kod	Strona
M	St		14100	10-90
M	St	Ocynk.	14110	10-90

10

14100 Nakrętki pazurkowe		F01F	
Gwint	Metryczny		
Materiał	Stal		
d	☒ Kod artykułu	d	☒ Kod artykułu
M4	500 14100.040.001	M6	500 14100.060.001
M5	500 14100.050.001	M8	500 14100.080.001
		M10	250 14100.100.001

14110 Nakrętki pazurkowe		F01F	
Gwint	Metryczny		
Materiał	Stal		
Obróbka powierzchni	Ocynkowane		
d	☒ Kod artykułu	d	☒ Kod artykułu
M4	500 14110.040.001	M6	500 14110.060.001
M5	500 14110.050.001	M8	500 14110.080.001
		M10	250 14110.100.001
		M12	100 14110.120.001

Wkładki wkręcane z gniazdem sześciokątnym

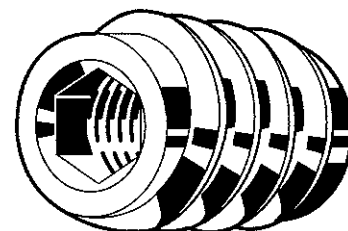
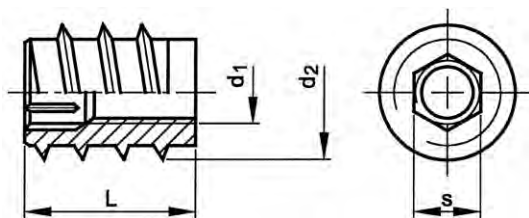

Informacje techniczne

d ₁	d ₂	Otwór ø, miękkie drewno	Otwór ø, twarde drewno	P	s
M4	8	6.6-6.9	6.9-7.2	0.7	4
M5	10	8.4-8.9	8.7-9.2	0.8	5
M6	12	10.0-10.4	10.2-10.8	1	6
M8	14	12.0-12.4	12.2-12.8	1.25	8
M8x23	16	14.0-14.5	14.2-14.8	1.25	8
M10	18.5	16.2-16.7	16.7-17.2	1.5	10

- Zalecane jest, aby wyboru dokładnej średnicy dokonać na podstawie testów.

Grupy katalogowe

Gwint	Materiał	Obróbka powierzchni	Kod	Strona
M	St	Ocynk.	14439	10-90
M	St	Ocynk. z kołnierzem	14440	10-91

14439 Wkładki wkręcane z gniazdem sześciokątnym, typ SK		F01F	
Gwint	Metryczny		
Materiał	Stal		
Obróbka powierzchni	Ocynkowane		
d₁ x L	☒ Kod artykułu	d₁ x L	☒ Kod artykułu
M4X10	100 14439.040.010	M6X12	100 14439.060.012
		M6X15	100 14439.060.015
M5X12	100 14439.050.012	M6X20	100 14439.060.020
		M8X15	100 14439.080.015
		M8X23	100 14439.080.023
		M10X25	100 14439.100.025

14440 Wkładki wkręcane z gniazdem sześciokątnym z kołnierzem, typ SKD				F01F				
Gwint	Metryczny							
Materiał	Stal							
Obróbka powierzchni	O cynkowane							
d₁ x L	✉	Kod artykułu	d₁ x L	✉	Kod artykułu	d₁ x L	✉	Kod artykułu
M4X10	100	14440.040.010	M6X15	100	14440.060.015	M8X18	100	14440.080.018
M5X12	100	14440.050.012	M6X18	100	14440.060.018	M10X20	100	14440.100.020

Wkładki wkręcane z rowkiem

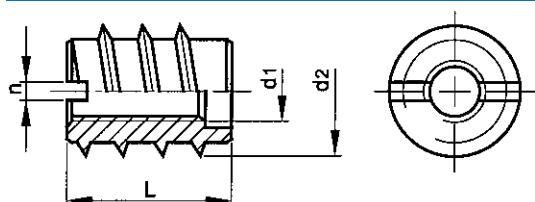

DIN 7965

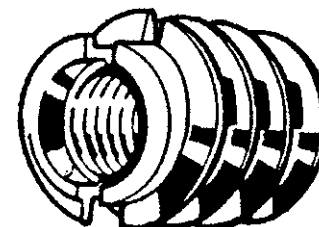

Informacje techniczne

d ₁	d ₂	n	Otwór ø, miękkie drewno	Otwór ø, twarde drewno	P
M3	6	1	4.6-4.9	4.9-5.2	0.5
M4	8	1.2	5.7-6.1	6.1-6.6	0.7
M5	10	1.6	7.6-8.0	8.0-8.5	0.8
M6	12	2	9.4-9.9	9.9-10.4	1
M8x15 (≠DIN)	14	2.5	11.4-11.9	11.9-12.4	1.25
M8x18	16	2.5	12.6-13.3	13.3-14.0	1.25
M10	18.5	3	15.1-15.8	15.8-16.5	1.5
M12	22	3	18.3-19.0	19.0-19.8	1.75

- Zalecane jest, aby wyboru dokładnej średnicy dokonać na podstawie testów.

14410 Wkładki wkręcane z rowkiem, typ A				F01F				
Gwint	Metryczny							
Materiał	Stal							
d₁ x L	✉	Kod artykułu	d₁ x L	✉	Kod artykułu	d₁ x L	✉	Kod artykułu
M3X8	100	14410.030.008	M5X12	100	14410.050.012	M8X18	100	14410.080.018
M4X8	100	14410.040.008	M6X12	100	14410.060.012	M10X20	100	14410.100.020
M4X10	100	14410.040.010	M6X15	100	14410.060.015	M10X25	100	14410.100.025
M4X12	100	14410.040.012	M8X15	100	14410.080.014	M12X30	100	14410.120.030

Wkładki wkręcane z gniazdem sześciokątnym z kołnierzem, stożkowe

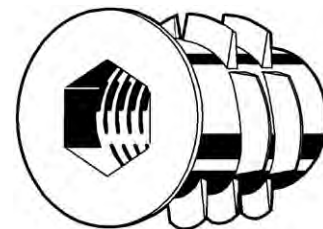
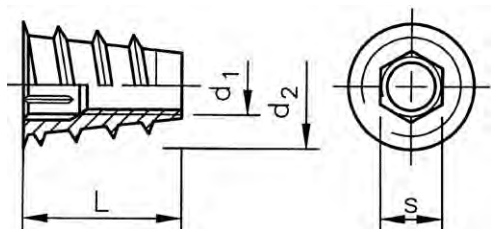

Informacje techniczne

d_1	d_2	Otwór \varnothing (maks.)	Otwór \varnothing (min.)	P	s
M4	8.5	6	5.7	0.7	4
M5	11.5	8	7.7	0.8	5
M6	12.5	9	8.7	1	6
M8	14.5	11	10.7	1.25	8
M10	16	12.5	12.2	1.5	10

- Zalecane jest, aby wyboru dokładnej średnicy dokonać na podstawie testów.

14446 Wkładki wkręcane z gniazdem sześciokątnym i kołnierzem, stożkowe, typ SKDZ

F01F

Gwint Metryczny
Materiał Odlew cynkowy
Obróbka powierzchni Ocynkowane, po żółtej pasywacji



d_1 x L	☒	Kod artykułu	d_1 x L	☒	Kod artykułu	d_1 x L	☒	Kod artykułu
M4X10	100	14446.040.010	M6X10	100	14446.060.010	M8X25	100	14446.080.025
M5X10	100	14446.050.010	M6X13	100	14446.060.013	M10X13	100	14446.100.013
M5X13	100	14446.050.013	M8X13	100	14446.080.013	M10X25	100	14446.100.025

Wkładki wbijane z kołnierzem walcowym

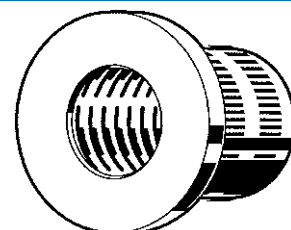
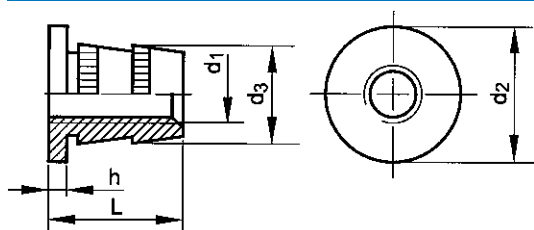

Informacje techniczne

d_1	d_2	d_3	h	L	P
M4	8	5.5	1	8	0.7
M5	10	6.5	1.3	10	0.8
M6	12	8.5	1.5	12	1
M8	15	10.5	2	12	1.25
M10	18.5	12.5	2	12	1.5

- Zalecane jest, aby wyboru dokładnej średnicy dokonać na podstawie testów.

14444 Wkładki wbijane z kołnierzem walcowym, typ TS

F01F

Gwint Metryczny
Materiał Stal
Obróbka powierzchni Ocynkowane



d_1	☒	Kod artykułu	d_1	☒	Kod artykułu	d_1	☒	Kod artykułu
M4	100	14444.040.001	M6	100	14444.060.001	M10	100	14444.100.001
M5	100	14444.050.001	M8	100	14444.080.001			

Nakrętki radełkowane

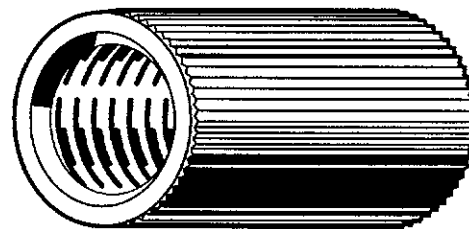
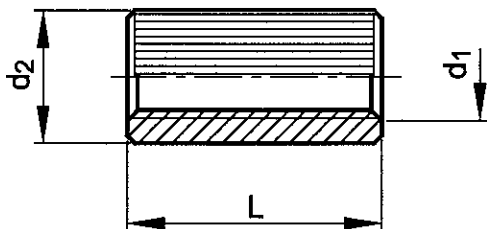

14443 Nakrętki radełkowane, typ RM

F01F

Gwint Metryczny
 Materiał Stal
 Obróbka powierzchni Ocynkowane



$d_1 \times d_2 \times L$	☒	Kod artykułu	$d_1 \times d_2 \times L$	☒	Kod artykułu
M6x10x15	100	14443.060.015	M6x10x18	100	14443.060.018

Nakrętki na kołki ustalające, typ RSK

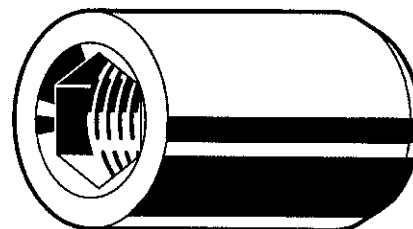
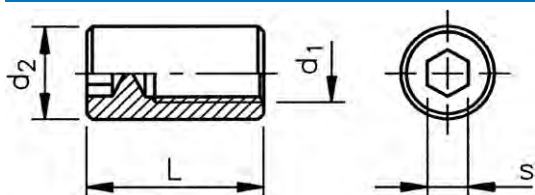

14445 Nakrętki na kołki ustalające, typ RSK

F01F

Gwint Metryczny
 Materiał Stal
 Obróbka powierzchni Ocynkowane



$d_1 \times d_2 \times L$	☒	Kod artykułu	$d_1 \times d_2 \times L$	☒	Kod artykułu
M6x10x16 (s=5)	100	14445.060.016	M6x10x20 (s=5)	100	14445.060.020

Nakrętki ślepe z łbem walcowym płaskim z gniazdem sześciokątnym

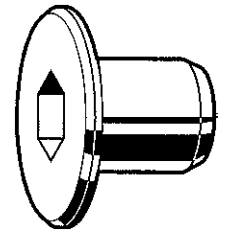
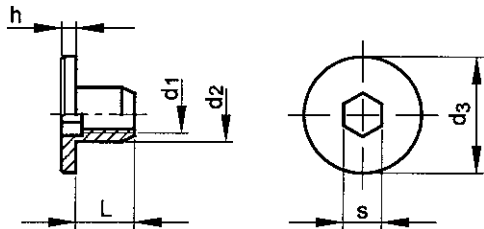

Informacje techniczne

d_1	d_2	d_3	h	P	s
M6	9	15	2	1	5
M8	10	20	2	1.25	5

Grupy katalogowe

Gwint	Gniazdo	Materiał	Obróbka powierzchni	Kod	Strona
M	Gniazdo sześciokątne	St	Nikl.	14456	10-94
M	Gniazdo sześciokątne	Mosiądz	Nikl.	14483	10-94

14456 Nakrętki ślepe z łbem walcowym płaskim z gniazdem sześciokątnym, typ RF

F01F

Gwint Metryczny
 Materiał Stal
 Obróbka powierzchni Niklowane

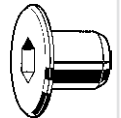
 $d_1 \times L$

Kod artykułu

M6x12

100

[14456.060.001](#)

14483 Nakrętki ślepe z łbem walcowym płaskim z gniazdem sześciokątnym, typ RF

F01F

Gwint Metryczny
 Materiał Mosiądz
 Obróbka powierzchni Niklowane

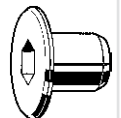
 $d_1 \times L$

Kod artykułu
 $d_1 \times L$

Kod artykułu

M6x10

100

[14483.060.001](#)

M8x10

100

[14483.080.001](#)

Nakrętki ślepe walcowe z łbem grzybkowym z gniazdem sześciokątnym

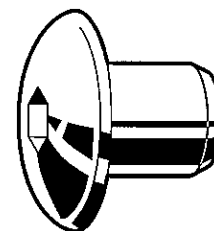
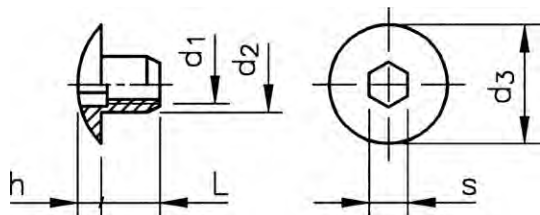

Informacje techniczne

d ₁	d ₂	d ₃	h	P	s
M6	9	15	3.5	1	5
M8	10	20	3	1.25	5

Grupy katalogowe

Gwint	Gniazdo	Materiał	Obróbka powierzchni	Kod	Strona
M	Gniazdo sześciokątne	Stal	Nikl.	14457	10-95
M	Gniazdo sześciokątne	Mosiądz	Nikl.	14484	10-95

14457 Nakrętki ślepe walcowe z łbem grzybkowym z gniazdem sześciokątnym, typ RT

F01F

Gwint	Metryczny
Materiał	Stal
Obróbka powierzchni	Niklowane



d ₁ x L	☒	Kod artykułu
--------------------	---	--------------

M6x12	100	14457.060.001
-------	-----	-------------------------------

14484 Nakrętki ślepe walcowe z łbem grzybkowym z gniazdem sześciokątnym, typ RT

F01F

Gwint	Metryczny
Materiał	Mosiądz
Obróbka powierzchni	Niklowane



d ₁ x L	☒	Kod artykułu	d ₁ x L	☒	Kod artykułu
--------------------	---	--------------	--------------------	---	--------------

M6x10	100	14484.060.001	M8x10	100	14484.080.001
-------	-----	-------------------------------	-------	-----	-------------------------------

Śruby z łbem walcowym płaskim z gniazdem sześciokątnym

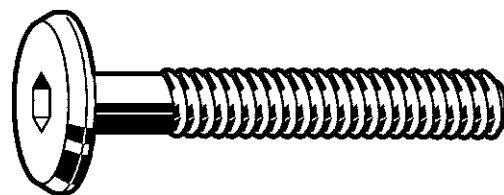
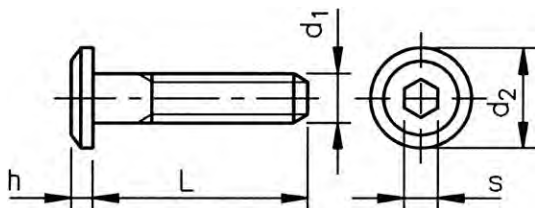

Informacje techniczne

d_1	d_2	h	P	s
M6	15	2.5	1	4

14441 Śruby z łbem walcowym płaskim z gniazdem sześciokątnym, typ KF

H09A

Gwint Metryczny
 Materiał Stal
 Obróbka powierzchni Ocynkowane



d_1 x L	☒	Kod artykułu	d_1 x L	☒	Kod artykułu	d_1 x L	☒	Kod artykułu
M6X12	100	14441.060.012	M6X35	100	14441.060.035	M6X70	100	14441.060.070
M6X16	100	14441.060.016	M6X40	100	14441.060.040	M6X80	100	14441.060.080
M6X20	100	14441.060.020	M6X45	100	14441.060.045	M6X90	100	14441.060.090
M6X25	100	14441.060.025	M6X50	100	14441.060.050	M6X100	100	14441.060.100
M6X30	100	14441.060.030	M6X60	100	14441.060.060			

Śruby z łbem walcowym grzybkowym z gniazdem sześciokątnym

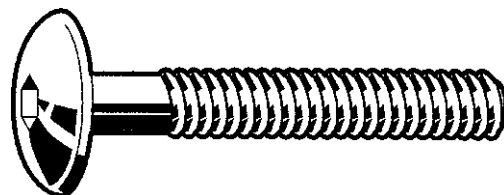
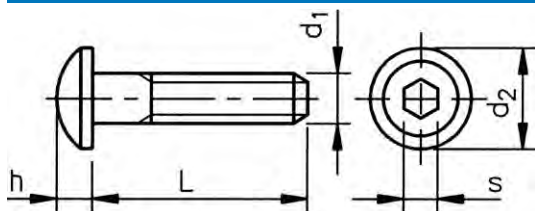

Informacje techniczne

d_1	d_2	h	P	s
M6	15	3.3	1	4

14442 Śruby z łbem walcowym grzybkowym z gniazdem sześciokątnym, typ KT

H09A

Gwint Metryczny
 Materiał Stal
 Obróbka powierzchni Ocynkowane

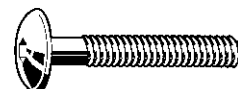

d_1 x L	☒	Kod artykułu	d_1 x L	☒	Kod artykułu	d_1 x L	☒	Kod artykułu
M6X12	100	14442.060.012	M6X35	100	14442.060.035	M6X70	100	14442.060.070
M6X16	100	14442.060.016	M6X40	100	14442.060.040	M6X80	100	14442.060.080
M6X20	100	14442.060.020	M6X45	100	14442.060.045	M6X90	100	14442.060.090
M6X25	100	14442.060.025	M6X50	100	14442.060.050	M6X100	100	14442.060.100
M6X30	100	14442.060.030	M6X60	100	14442.060.060			

Konfirmaty do drewna

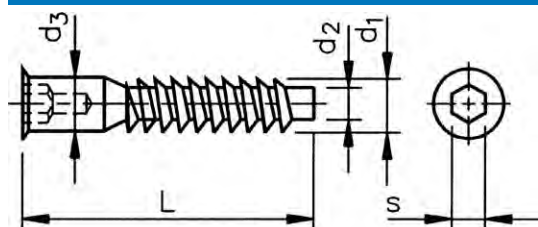

Informacje techniczne

d_1	d_2	d_3	s	Wiertło \varnothing
7	4.5	7	4	4.5

14451 Konfirmaty do drewna z gniazdem sześciokątnym, typ KOK

H09A

Materiał Stal
Obróbka powierzchni Ocynkowane



$d_1 \times L$	☒	Kod artykułu
7X50MM	200	14451.070.050

Kołki ustalające z rowkiem i otworem umieszczonym poprzecznie

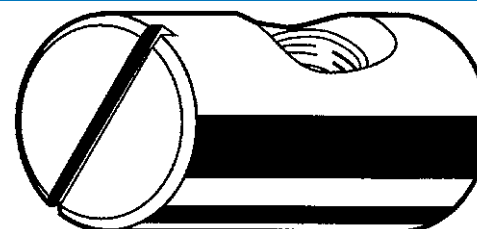
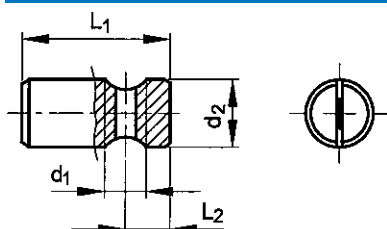

Informacje techniczne

$d_1 \times L_1$	d_2	L_2	P	$d_1 \times L_1$	d_2	L_2	P
M6x12	10	6	1	M6x17	10	6	1
M6x14	10	6	1	M6x20	10	10	1
M6x15	10	6	1	M6x25	10	12.5	1

14450 Kołki ustalające z rowkiem i otworem umieszczonym poprzecznie, typ Q

F01F

Gwint Metryczny
Materiał Stal
Obróbka powierzchni Ocynkowane



$d_1 \times L_1$	☒	Kod artykułu	$d_1 \times L_1$	☒	Kod artykułu	$d_1 \times L_1$	☒	Kod artykułu
M6X12	100	14450.060.012	M6X15	100	14450.060.015	M6X20	100	14450.060.020
M6X14	100	14450.060.014	M6X17	100	14450.060.017	M6X25	100	14450.060.025

10

Rozety otwarte

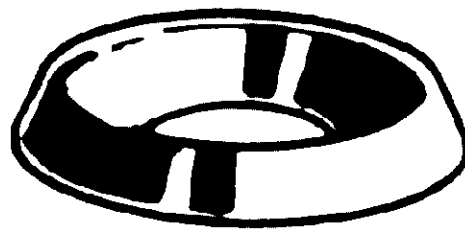
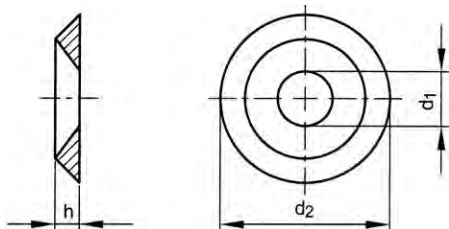

Informacje techniczne

Wymiar nominalny d_1	d_2	Dla \varnothing śruby	h
3.2	9	2.5-3	1.9
4	11	3.5-4	2.3
4.8	13	4-4.5	2.7
5.5	15	5	3.2
6.6	17	5.5-6	3.2
7.4	20	7	4

Przykład zastosowania

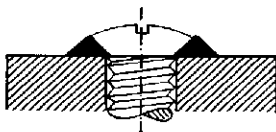

Grupy katalogowe

Materiał	Obróbka powierzchni	Kod	Strona
St.St. A2		51350	10-98
Mosiądz		50230	10-98
Mosiądz	Nikl.	50260	10-98

51350	Rozety otwarte	R09A
Materiał	Stal nierdzewna A2	
		

Wymiar nominalny d_1	☒	Kod artykułu	Wymiar nominalny d_1	☒	Kod artykułu	Wymiar nominalny d_1	☒	Kod artykułu
3,2MM	250	51350.032.001	4,8MM	250	51350.048.001	6,6MM	200	51350.066.001
4,0MM	250	51350.040.001	5,5MM	200	51350.055.001	7,4MM	200	51350.074.001

50230	Rozety otwarte	M11F
Materiał	Mosiądz	
		

Wymiar nominalny d_1	☒	Kod artykułu	Wymiar nominalny d_1	☒	Kod artykułu	Wymiar nominalny d_1	☒	Kod artykułu
3,2MM	250	50230.032.001	4,8MM	250	50230.048.001	6,6MM	200	50230.066.001
4,0MM	250	50230.040.001	5,5MM	200	50230.055.001	7,4MM	200	50230.074.001

50260	Rozety otwarte	M11F
Materiał	Mosiądz	
Obróbka powierzchni	Niklowane	

Wymiar nominalny d_1	☒	Kod artykułu	Wymiar nominalny d_1	☒	Kod artykułu	Wymiar nominalny d_1	☒	Kod artykułu
3,2MM	250	50260.032.001	4,8MM	250	50260.048.001	6,6MM	200	50260.066.001
4,0MM	250	50260.040.001	5,5MM	200	50260.055.001	7,4MM	200	50260.074.001

Rozety zamknięte

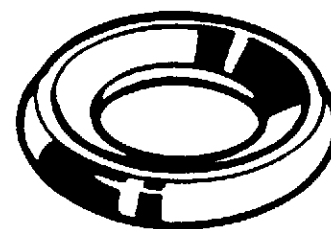
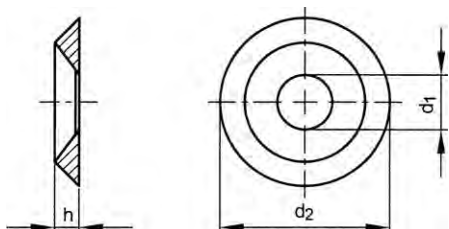

Informacje techniczne

Wymiar nominalny d_1	d_2	Do śruby	Do śruby samogwintującej	h
4	9	M3	ST2.9	2
5	11	M4	ST4.2	2.3
6	13	M5	ST4.8	2.5

50280 Rozety zamknięte

M11F

Materiał Mosiądz
Obróbka powierzchni Niklowane



Wymiar nominalny d_1	☒	Kod artykułu	Wymiar nominalny d_1	☒	Kod artykułu	Wymiar nominalny d_1	☒	Kod artykułu
4,0MM	250	50280.040.001	5,0MM	250	50280.050.001	6,0MM	150	50280.060.001

Podkładki pod śruby z łbem stożkowym o kącie stożka 90°

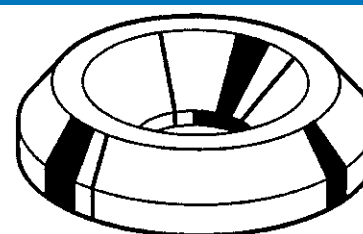
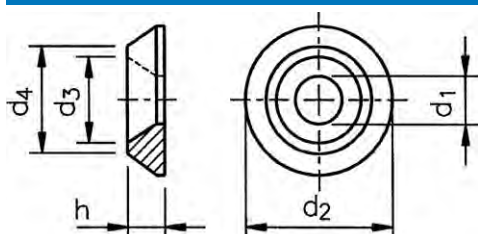

Informacje techniczne

Dla wymiaru nominalnego d_1	d_1 (min.)	d_2 (maks.)	d_3 (min.)	d_4	h (min.)
M4	4.3	14	8.6	9.5	2.3
M5	5.3	16	10.4	11.5	2.8
M6	6.4	18	12.4	13.5	3.3
M8	8.4	25	16.4	17.5	4.8

45140 Podkładki pod śruby z łbem stożkowym o kącie stożka 90°

W01A

Materiał Aluminium



Dla wymiaru nominalnego d_1	☒	Kod artykułu	Dla wymiaru nominalnego d_1	☒	Kod artykułu	Dla wymiaru nominalnego d_1	☒	Kod artykułu
M4	100	45140.040.001	M6	100	45140.060.001	M8	100	45140.080.001
M5	100	45140.050.001						

10

Podkładki rozetowe

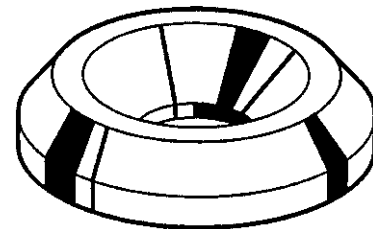
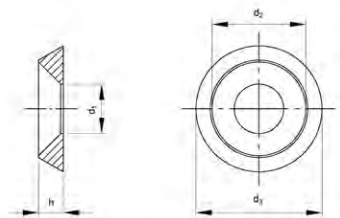

Informacje techniczne



d	d ₁	d ₂	d ₃	h
M3	3.5	6.5	9	2
M4	4.5	8	11	2.5
M5	5.5	10	14	3
M6	7	12	16	4
M8	9	16	22	5
M10	11	20	28	6
M12	14	24	32	6.5

Grupy katalogowe

Material	Kod	Strona
St.St. A1	51546	10-100
St.St. A4	55350	10-100

51546	Podkładki rozetowe	R09A
Material	Stal nierdzewna A1	
		

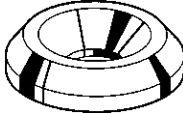
Dla wymiaru nominalnego d ₁	☒	Kod artykułu	Dla wymiaru nominalnego d ₁	☒	Kod artykułu	Dla wymiaru nominalnego d ₁	☒	Kod artykułu
M3	100	51546.030.001	M6	100	51546.060.001	M12*	50	51546.120.001
M4	100	51546.040.001	M8	100	51546.080.001			
M5	100	51546.050.001	M10*	50	51546.100.001			

55350	Podkładki rozetowe	R05A
Material	Stal nierdzewna A4	
		

Dla wymiaru nominalnego d ₁	☒	Kod artykułu	Dla wymiaru nominalnego d ₁	☒	Kod artykułu	Dla wymiaru nominalnego d ₁	☒	Kod artykułu
M3*	200	55350.030.001	M6*	100	55350.060.001	M12*	50	55350.120.001
M4*	200	55350.040.001	M8*	100	55350.080.001			
M5*	200	55350.050.001	M10*	50	55350.100.001			

Nakrętki książkowe

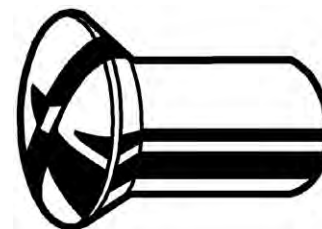
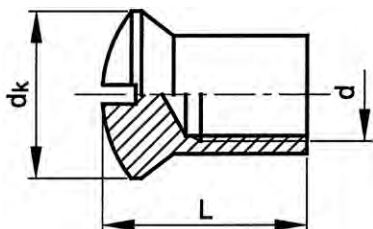

Informacje techniczne

d	P
M4	0.7
M5	0.8
M6	1
M8	1.25

Grupy katalogowe

Gwint	Materiał	Obróbka powierzchni	Kod	Strona
M	Mosiądz	Nikl.	47796	10-101
M	St.St. A1		51212	10-101
M	St.St. A4		55212	10-101

47796 Nakrętki książkowe

M01D

Gwint	Metryczny
Materiał	Mosiądz
Obróbka powierzchni	Nikiowane

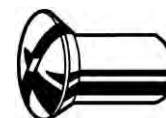

d x d _k x L	☒	Kod artykułu	d x d _k x L	☒	Kod artykułu	d x d _k x L	☒	Kod artykułu
M4X7X12	100	47796.040.012	M5X9X15	100	47796.050.015	M6X10X20	100	47796.060.020
M4X7X14	100	47796.040.014	M5X9X20	100	47796.050.020	M8X15X15	100	47796.080.015
M4X7X20	100	47796.040.020	M6X12X14	100	47796.060.014	M8X15X20	100	47796.080.020
M5X9X10	100	47796.050.010	M6X10X15	100	47796.060.015	M8X15X25	100	47796.080.025

51212 Nakrętki książkowe

R05A

Gwint	Metryczny
Materiał	Stal nierdzewna A1



d x d _k x L	☒	Kod artykułu	d x d _k x L	☒	Kod artykułu	d x d _k x L	☒	Kod artykułu
M4X7X12*	100	51212.040.012	M6X10X15*	100	51212.060.015	M8X15X20*	100	51212.080.020
M5X9X15*	100	51212.050.015						

55212 Nakrętki książkowe

R45A

Gwint	Metryczny
Materiał	Stal nierdzewna A4

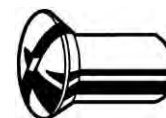

d x d _k x L	☒	Kod artykułu	d x d _k x L	☒	Kod artykułu	d x d _k x L	☒	Kod artykułu
M4X7X12*	100	55212.040.012	M6X10X15*	100	55212.060.015	M8X15X20*	100	55212.080.020
M5X9X15*	100	55212.050.015						

10

Nakrętki książkowe

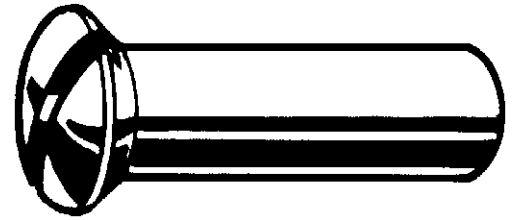
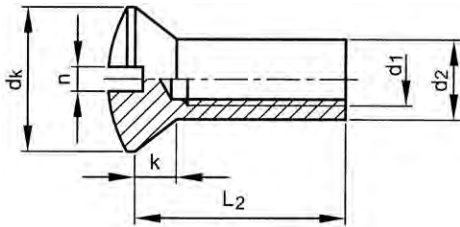

Informacje techniczne

d_1	d_2	d_k	k (maks.)	n	P
M4	5	7.5	2.2	1	0.7

Grupy katalogowe

Gwint	Materiał	Obróbka powierzchni	Kod	Strona
M	Mosiądz		47780	10-102
M	Mosiądz	Nikl.	47790	10-102

47780	Nakrętki książkowe	M11D
Gwint	Metryczny	
Materiał	Mosiądz	
		

$d_1 \times L_2$	✉	Kod artykułu
M4X22	250	47780.040.022

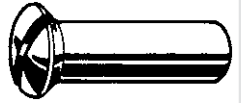
47790	Nakrętki książkowe	M11D
Gwint	Metryczny	
Materiał	Mosiądz	
Obróbka powierzchni	Niklowane	

$d_1 \times L_2$	✉	Kod artykułu
M4X22	250	47790.040.022

Śruby książkowe

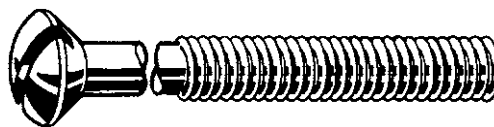
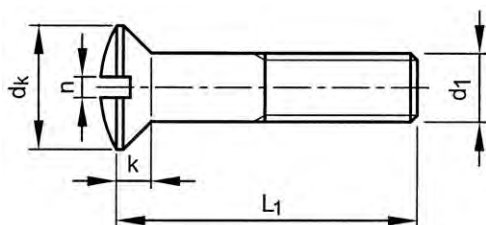

Informacje techniczne

d_1	d_k	k (maks.)	n	P
M4	7.5	2.2	1	0.7

Grupy katalogowe

Gwint	Materiał	Obróbka powierzchni	Kod	Strona
M	St	Nikl.	47720	10-103
M	Mosiądz	Nikl.	47750	10-103

47720 Śruby książkowe				M11D
Gwint	Metryczny			
Materiał	Stal			
Obróbka powierzchni	Niklowane			

$d_1 \times L_1$	☒	Kod artykułu	$d_1 \times L_1$	☒	Kod artykułu	$d_1 \times L_1$	☒	Kod artykułu
M4X38	250	47720.040.038	M4X45	250	47720.040.045	M4X55	250	47720.040.055

47750 Śruby książkowe				M11D
Gwint	Metryczny			
Materiał	Mosiądz			
Obróbka powierzchni	Niklowane			

$d_1 \times L_1$	☒	Kod artykułu	$d_1 \times L_1$	☒	Kod artykułu
M4X38	250	47750.040.038	M4X45	250	47750.040.045

Połączenia "książkowe"

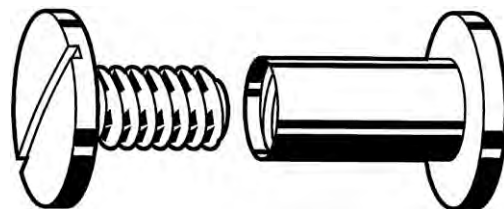

Informacje techniczne

d_1	d_2	d_k	n	P
M3.5	5	9	0.8	0.6

47711 Połączenia "książkowe" M11D

Materiał Mosiądz



d_1 x L	☒	Kod artykułu	d_1 x L	☒	Kod artykułu	d_1 x L	☒	Kod artykułu
M3,5X10	100	47711.035.010	M3,5X25	50	47711.035.025	M3,5X50	25	47711.035.050
M3,5X15	100	47711.035.015	M3,5X30	50	47711.035.030	M3,5X60	25	47711.035.060
M3,5X20	100	47711.035.020	M3,5X40	25	47711.035.040			

Przedłużenie do śrub "książkowych"

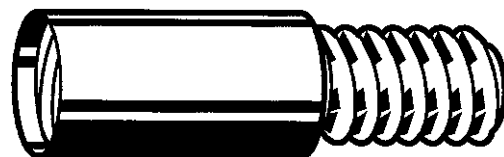
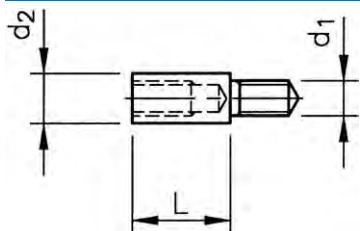

Informacje techniczne

L	d_1	d_2	P
10	M3.5	5	0.6
15	M3.5	5	0.6

47715 Przedłużenie do śrub "książkowych" M11D

Gwint Metryczny
Materiał Mosiądz



L	☒	Kod artykułu	L	☒	Kod artykułu
10MM	100	47715.000.010	15MM	100	47715.000.015

Połączenia śrubowe do oprawiania

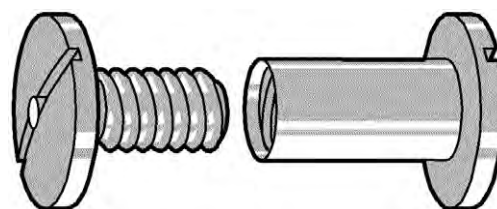
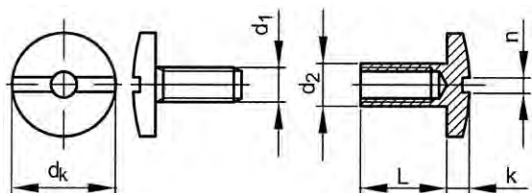

Informacje techniczne

d_1	d_2	d_k	k	n	P
M4	5	12	2.6	1.8	0.7

56480 Połączenia śrubowe do oprawiania

W02A

Gwint Metryczny
Materiał Plastik Polietylen
Kolor Biały

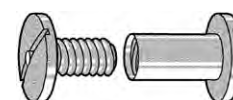

L	☒	Kod artykułu	L	☒	Kod artykułu	L	☒	Kod artykułu
6MM	100	56480.060.001	25MM	50	56480.250.001	60MM	50	56480.600.001
8MM	100	56480.080.001	30MM	50	56480.300.001	70MM	25	56480.700.001
10MM	100	56480.100.001	35MM	50	56480.350.001	80MM	25	56480.800.001
15MM	50	56480.160.001	40MM	50	56480.400.001	90MM	25	56480.900.001
20MM	50	56480.200.001	50MM	50	56480.500.001			

Zaślepki rurowe okrągłe

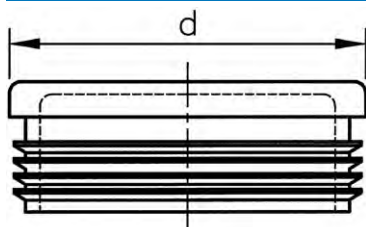

56792 Zaślepki rurowe okrągłe

W05F

Materiał Plastik Polietylen
Kolor Czarny



d (t)	☒	Kod artykułu	d (t)	☒	Kod artykułu	d (t)	☒	Kod artykułu
12MM (1-2mm)	25	56792.120.001	23MM (0,8-2,5mm)	25	56792.230.001	36MM (1-3mm)	25	56792.360.001
13MM (1-2mm)	25	56792.130.001	24MM (1-2,5mm)	25	56792.240.001	37MM (1-3mm)	25	56792.370.001
14MM (1-2mm)	25	56792.140.001	25MM (1-2mm)	25	56792.250.001	38MM (1-2mm)	25	56792.380.001
15MM (0,8-2mm)	25	56792.150.001	26MM (1-3mm)	25	56792.260.001	40MM (1-2mm)	25	56792.400.001
16MM (1-2mm)	25	56792.160.001	27MM (1-3mm)	25	56792.270.001	42MM (1-2mm)	25	56792.420.001
18MM (1-2mm)	25	56792.180.001	28MM (0,8-2,5mm)	25	56792.280.001	45MM (1-3,5mm)	25	56792.450.001
19MM (1-2mm)	25	56792.190.001	30MM (0,8-2,5mm)	25	56792.300.001	48MM (1-2mm)	25	56792.480.001
20MM (0,8-2,5mm)	25	56792.200.001	32MM (0,8-2mm)	25	56792.320.001	50MM (1-2,5mm)	25	56792.500.001
21MM (0,8-2mm)	25	56792.210.001	34MM (1-3mm)	25	56792.340.001	55MM (1-3mm)	25	56792.550.001
22MM (1-2mm)	25	56792.220.001	35MM (1-3mm)	25	56792.350.001	60MM (1,5-2,5mm)	25	56792.600.001

• (t) = odpowiednie dla grubości bazowego materiału

Zaślepki rurowe kwadratowe

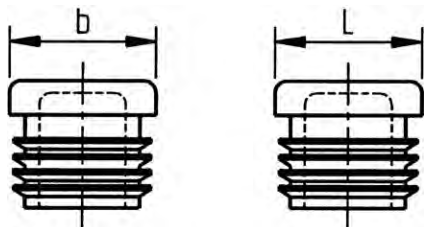

56795 Zaślepki rurowe kwadratowe

W05F

Materiał Plastik Polietylen
Kolor Czarny



L x b (t)	☒	Kod artykułu	L x b (t)	☒	Kod artykułu	L x b (t)	☒	Kod artykułu
12-12MM (1-2mm)	100	56795.120.120	30-30MM (1-2mm)	100	56795.300.300	60-60MM (1,5-2,5mm)	25	56795.600.600
15-15MM (1-2mm)	100	56795.150.150	35-35MM (1-2mm)	50	56795.350.350	70-70MM (2-4mm)	10	56795.700.700
20-20MM (1-2mm)	100	56795.200.200	40-40MM (1-2mm)	25	56795.400.400	80-80MM (2-4mm)	10	56795.800.800
22-22MM (1-2mm)	100	56795.220.220	45-45MM (1-3mm)	25	56795.450.450	100-100MM (3-6mm)	10	56795.982.982
25-25MM (1-2mm)	100	56795.250.250	50-50MM (1-3mm)	25	56795.500.500			

- (t) = Odpowiednie dla grubości ścianki materiału 2,5 do 5 mm włącznie.
- 15-15MM; z gładkim trzonkiem.

Zaślepki rurowe prostokątne

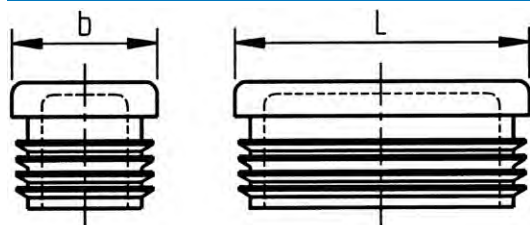

56797 Zaślepki rurowe prostokątne

W05F

Materiał Plastik Polietylen
Kolor Czarny



L x b (t)	☒	Kod artykułu	L x b (t)	☒	Kod artykułu	L x b (t)	☒	Kod artykułu
20-10MM (0,75-2mm)	100	56797.200.100	40-25MM (1-2mm)	50	56797.400.250	70-40MM (1-2mm)	25	56797.700.400
20-15MM (1-2mm)	100	56797.200.150	40-30MM (1-2mm)	50	56797.400.300	80-40MM (1-3mm)	25	56797.800.400
25-10MM (1-2mm)	100	56797.250.100	45-25MM (1-2mm)	50	56797.450.250	80-40x4MM (2-4mm)	25	56797.800.404
25-15MM (1-2mm)	100	56797.250.150	50-20MM (1-2mm)	50	56797.500.200	80-50MM (2-4mm)	25	56797.800.500
30-10MM (1-2mm)	100	56797.300.100	50-25MM (1-3mm)	50	56797.500.250	100-40x4MM (1,5-4mm)	25	56797.960.400
30-15MM (1,2-2,5mm)	100	56797.300.150	50-30MM (1-3mm)	50	56797.500.300	100-60x4MM (2,5-4,5mm)	25	56797.960.600
30-20MM (1-2mm)	100	56797.300.200	60-20MM (1-3mm)	50	56797.600.200	120-30MM (1-2mm)	25	56797.980.300
35-20MM (1-2mm)	100	56797.350.200	60-30MM (2-4mm)	50	56797.600.300	120-60MM (2-3mm)	25	56797.980.600
35-25MM (1-3mm)	50	56797.350.250	60-40MM (2-4mm)	50	56797.600.400	120-80MM (2-3mm)	25	56797.980.800
40-20MM (1-2mm)	50	56797.400.200	70-20MM (1-2mm)	25	56797.700.200			

- (t) = Odpowiednie dla grubości ścianki materiału 2,5 do 5 mm włącznie.

Zaślepki rurowe stożkowe

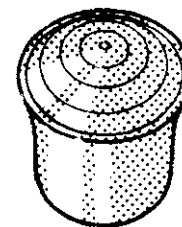
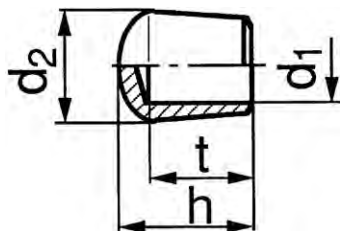

Informacje techniczne

d ₁	d ₂	h	t	d ₁	d ₂	h	t
3	5	10	8	32	36	33	25
4	6	11	9	34	38	33	25
5	7	7.5	7	35	39	33	25
6	8	13	10.5	38	42	33	27
8	11	15	13	40	44	33	24
10	15	18	14	42	46	33	27
12	17	21	17	43	47	33	26
13	17	20	16	45	49	33	26
14	19	22	18	47	51	33	24
16	21	24	20	48	53	33	28
18	25	27	22	49	53	33	28
19	24	24	19	50	53	33	24
20	27	30	24	54	57	35	26
22	29	33	26	59	63	38	27
24	32	36	30	63	67	38	28
25	30	31	24	69	73	38	28
26	33	36	31	75	78	40	28
28	32	30	24	90	95	45	31
30	34	31	24	103	106	40	35

56790 Zaślepki rurowe stożkowe

W02A

Materiał Plastik Poliwinylchlorok
Kolor Czarny



d ₁	☒	Kod artykułu	d ₁	☒	Kod artykułu	d ₁	☒	Kod artykułu
3MM	100	56790.030.001	20MM	50	56790.200.001	43MM	25	56790.430.001
4MM	100	56790.040.001	22MM	50	56790.220.001	45MM	25	56790.450.001
5MM	100	56790.050.001	25MM	25	56790.250.001	47MM	25	56790.470.001
6MM	100	56790.060.001	28MM	25	56790.280.001	48MM	25	56790.480.001
8MM	100	56790.080.001	30MM	25	56790.300.001	50MM	25	56790.500.001
10MM	100	56790.100.001	32MM	25	56790.320.001	54MM	25	56790.540.001
12/13MM	100	56790.120.001	34MM	25	56790.340.001	59MM	25	56790.590.001
14MM	100	56790.140.001	35MM	25	56790.350.001	63MM	25	56790.630.001
16MM	100	56790.160.001	38MM	25	56790.380.001	69MM	10	56790.690.001
18MM	50	56790.180.001	40MM	25	56790.400.001	75MM	10	56790.750.001
19MM	50	56790.190.001	42MM	25	56790.420.001	90MM	10	56790.900.001

Fabory Security Elementy złączne zabezpieczające

Celem zapobiegania zagrożeniom takim jak wandalizm, kradzieże oraz niepożądane ingerencje w licznych aplikacjach stosowane są elementy złączne do zabezpieczeń np. mebli ogrodowych, billboardów, oświetlenia zewnętrznego, itd. Poprzez zastosowanie tych elementów złącznych do minimum zmniejsza się tak zwana "kradzież okazyjna" gdyż potencjalny złodziej/wandal nie będzie miał narzędzi potrzebnych do odkręcenia produktu, który chce zabrać czy zniszczyć.

Elementy złączne zabezpieczające Fabory Security, nakrętki oraz śruby, zapewniają ten dodatkowy poziom bezpieczeństwa poprzez swoją konstrukcję, która uniemożliwia ich usunięcie za pomocą zwykłych narzędzi. Fabory oferuje rozmaite style łbów wkrętów zabezpieczających oraz oczywiście odpowiednie narzędzia do mocowania i odkręcania. Wkręty zabezpieczające dostępne

są z gwintem metrycznym a także jako samogwintujące. Jak widzisz, elementy złączne Fabory Security stanowią dobry system zamocowań wraz z inwestycją w bezpieczeństwo. Jeśli chcesz być w awangardzie, korzystaj z elementów złącznych zabezpieczających Fabory Security. Można je zdemontować tylko wtedy gdy Ty tego chcesz!



SECURITY Nakrętki

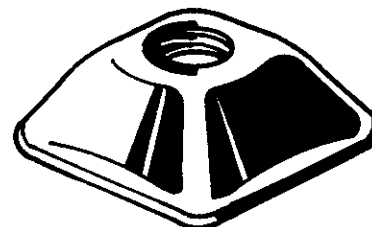
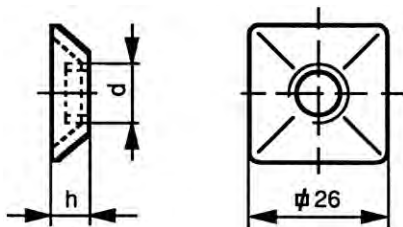

Informacje techniczne

d	M6-4k	M8-4k	M10-4k	M12-6k
h ≈	6.2	7	6.8	7.3
P	1	1.25	1.5	1.75

- Nakrętki SECURITY aż do M10 włącznie, mają kwadratowy kształt, M12 ma kształt sześciokątny z rozmiarem 31 mm.

Kolejność montażu

Specjalne właściwości nakrętek FABORY SECURITY:

- montaż musi zawsze zostać wykonany z dwiema identycznymi nakrętkami
- nakręca się najpierw nakrętkę na śrubę ręcznie. Następnie drugą nakrętkę nakręca się odwrotnie (do góry nogami w stosunku do pierwszej) do połowy nakręcanej odległości od pierwszej nakrętki, co w rezultacie daje dziwny kształt całości. Dalej obie nakrętki mogą być obracane równocześnie kluczem nastawnym. Następnie górna nakrętka może zostać odkręcona ręcznie.
- demontaż: nakręcenie ręcznie drugiej nakrętki odwrotnie na śrubę (do góry nogami w stosunku do pierwszej) do połowy odległości już zamontowanej nakrętki. Luzowanie obu nakrętek odbywa się równocześnie przy użyciu klucza nastawczego.

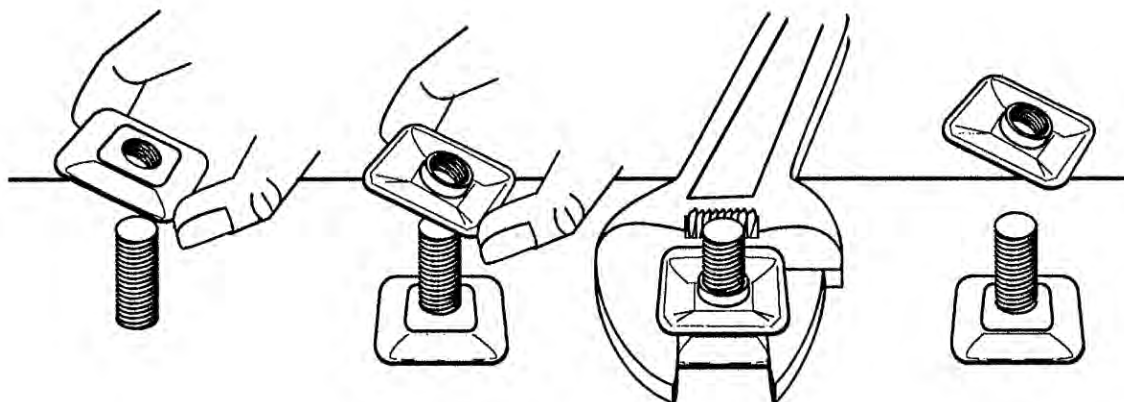

11430 SECURITY Nakrętki zabezpieczające

K91A

Gwint Metryczny
Materiał Stal Min.55HRc
Obróbka powierzchni Ocynkowane, po złotej pasywacji



d	☒	Kod artykułu	d	☒	Kod artykułu	d	☒	Kod artykułu
M6-4k	10	11430.060.001	M10-4k	10	11430.100.001	M12-6k	10	11430.120.001
M8-4k	10	11430.080.001						

SECURITY Nakrętki zrywalne

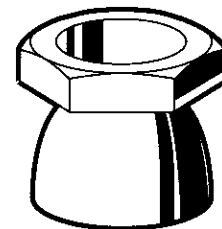
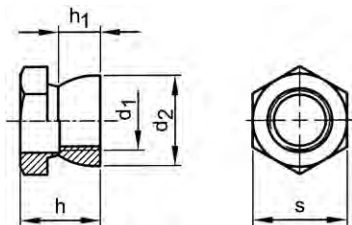

Informacje techniczne

d ₁	d ₂	h	h ₁	Moment końcowy w Nm	P	s
M6	9.8	9.5	4.5	7-13	1	11
M8	12.8	12	7	13-25	1.25	13
M10	16.8	15	8.5	30-40	1.5	17
M12	18.8	16	9	35-45	1.75	19
M16	23.8	22	13	45-60	2	24
M20	29.8	25	18.5	65-80	2.5	27

Kolejność montażu

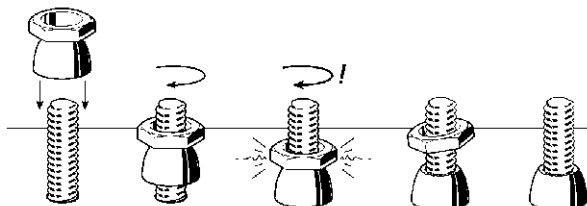

51097 SECURITY nakrętki zrywalne zabezpieczające przed kradzieżą

K91A

Gwint Metryczny
Materiał Stal nierdzewna A2

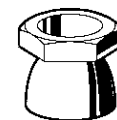

d ₁	☒	Kod artykułu	d ₁	☒	Kod artykułu	d ₁	☒	Kod artykułu
M6 S=10	100	51097.060.001	M10 S=17	50	51097.100.001	M16 S=24	25	51097.160.001
M8 S=13	100	51097.080.001	M12 S=19	50	51097.120.001	M20*	100	51097.200.001

SECURITY Śruby łbem kulistym z gn. sześciokątnym ze szpilką

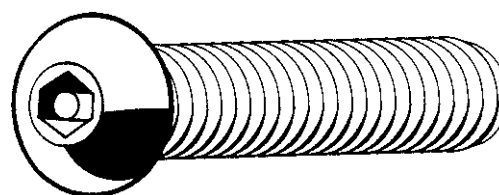
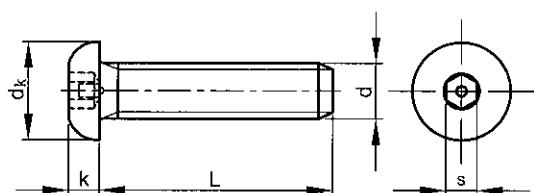

Informacje techniczne

d	d _k (maks.)	k (maks.)	P	s
M3	5.7	1.65	0.5	2
M4	7.6	2.2	0.7	2.5
M5	9.5	2.75	0.8	3
M6	10.5	3.3	1	4
M8	14	4.4	1.25	5
M10	10	5.5	1.5	6

51036 SECURITY Śruby zabezpieczające, z łbem kulistym z gniazdem sześciokątnym ze szpilką

K91A

Gwint Metryczny
 Materiał Stal nierdzewna A2

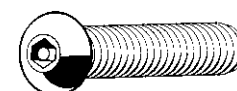

d x L	☒	Kod artykułu	d x L	☒	Kod artykułu	d x L	☒	Kod artykułu
M3X6*	100	51036.030.006	M5X20	50	51036.050.020	M8X25	25	51036.080.025
M3X8*	100	51036.030.008	M5X25	25	51036.050.025	M8X30	25	51036.080.030
M3X10*	100	51036.030.010	M5X30	25	51036.050.030	M8X40	25	51036.080.040
M3X12*	100	51036.030.012	M5X40*	100	51036.050.040	M8X45*	100	51036.080.045
M3X16*	100	51036.030.016				M8X50	25	51036.080.050
M3X20*	100	51036.030.020	M6X10	25	51036.060.010	M8X60*	100	51036.080.060
			M6X12	25	51036.060.012			
M4X6*	100	51036.040.006	M6X16	25	51036.060.016	M10X16*	100	51036.100.016
M4X8*	100	51036.040.008	M6X20	25	51036.060.020	M10X20*	100	51036.100.020
M4X10	50	51036.040.010	M6X25	25	51036.060.025	M10X25*	100	51036.100.025
M4X12	50	51036.040.012	M6X30	25	51036.060.030	M10X30*	100	51036.100.030
M4X16	50	51036.040.016	M6X40	25	51036.060.040	M10X40*	100	51036.100.040
M4X20	50	51036.040.020	M6X50	25	51036.060.050	M10X45*	100	51036.100.045
M4X25	50	51036.040.025	M6X60*	100	51036.060.060	M10X50*	100	51036.100.050
M4X30	50	51036.040.030				M10X60*	100	51036.100.060
			M8X10	25	51036.080.010	M10X70*	100	51036.100.070
M5X10	50	51036.050.010	M8X12	25	51036.080.012	M10X75*	100	51036.100.075
M5X12	50	51036.050.012	M8X16	25	51036.080.016	M10X90*	100	51036.100.090
M5X16	50	51036.050.016	M8X20	25	51036.080.020			

SECURITY Śruby zabezpieczające, z łbem kulistym z korkiem

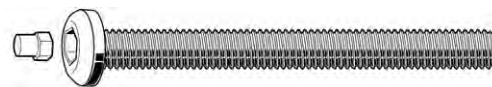
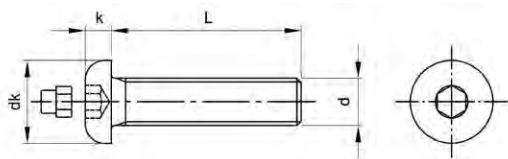

Informacje techniczne

d	d _k	k	s
M6	10.5	3.3	4
M8	14	4.4	5
M10	17.5	5.5	6
M12	21	6.6	7

51672 SECURITY Śruby zabezpieczające, z łbem kulistym z korkiem

K91A

Gwint Metryczny
 Materiał Stal nierdzewna A2



d x L	☒	Kod artykułu	d x L	☒	Kod artykułu	d x L	☒	Kod artykułu
M6X12*	100	51672.060.012	M8X20*	100	51672.080.020	M10X35*	100	51672.100.035
M6X16*	100	51672.060.016	M8X25*	100	51672.080.025	M10X40*	100	51672.100.040
M6X20*	100	51672.060.020	M8X30*	100	51672.080.030	M10X45*	100	51672.100.045
M6X25*	100	51672.060.025	M8X40*	100	51672.080.040	M10X60*	100	51672.100.060
M6X30*	100	51672.060.030	M8X45*	100	51672.080.045			
M6X35*	100	51672.060.035	M8X50*	100	51672.080.050	M12X25*	100	51672.120.025
M6X50*	100	51672.060.050	M8X60*	100	51672.080.060	M12X30*	100	51672.120.030
M6X60*	100	51672.060.060				M12X40*	100	51672.120.040
			M10X25*	100	51672.100.025	M12X50*	100	51672.120.050
M8X12*	100	51672.080.012	M10X30*	100	51672.100.030	M12X60*	100	51672.120.060

SECURITY Śruby z łbem kulistym z gniazdem sześciokarbowym ze szpilką

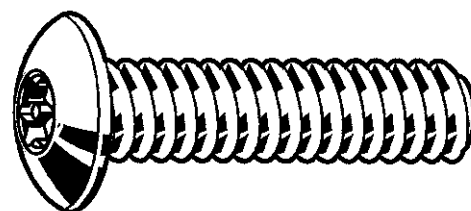
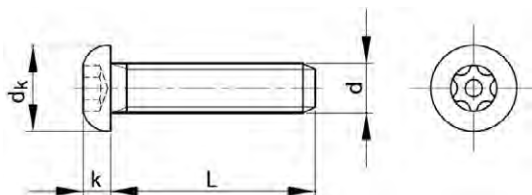

Informacje techniczne

d	d _k (maks.)	k (maks.)	Nasadka	P
M3	5.7	1.65	T10	0.5
M4	7.6	2.2	T20	0.7
M5	9.5	2.75	T25	0.8
M6	10.5	3.3	T30	1
M8	14	4.4	T40	1.25
M10	17.5	5.5	T45	1.5

51037 SECURITY Śruby z łbem kulistym z gniazdem sześciokarbowym ze szpilką

K91A

Gwint Metryczny
 Materiał Stal nierdzewna A2
 Klasa 70

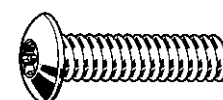

d x L	☒	Kod artykułu	d x L	☒	Kod artykułu	d x L	☒	Kod artykułu
M3X6*	100	51037.030.006	M5X16	50	51037.050.016	M6X55*	100	51037.060.055
M3X8*	100	51037.030.008	M5X20	50	51037.050.020	M6X60*	100	51037.060.060
M3X10*	100	51037.030.010	M5X25	25	51037.050.025	M8X12	25	51037.080.012
M3X12*	100	51037.030.012	M5X30	25	51037.050.030	M8X16	25	51037.080.016
M3X16*	100	51037.030.016	M5X40*	100	51037.050.040	M8X20	25	51037.080.020
M3X20*	100	51037.030.020	M5X50*	100	51037.050.050	M8X25	25	51037.080.025
M4X6*	100	51037.040.006	M5X60*	100	51037.050.060	M8X30	25	51037.080.030
M4X8*	100	51037.040.008	M6X10	25	51037.060.010	M8X40	25	51037.080.040
M4X10	50	51037.040.010	M6X12	25	51037.060.012	M8X50	25	51037.080.050
M4X12	50	51037.040.012	M6X14*	100	51037.060.014	M8X60*	100	51037.080.060
M4X16	50	51037.040.016	M6X16	25	51037.060.016	M10X16*	100	51037.100.016
M4X20	50	51037.040.020	M6X18*	100	51037.060.018	M10X20*	100	51037.100.020
M4X25	50	51037.040.025	M6X20	25	51037.060.020	M10X25*	100	51037.100.025
M4X30	50	51037.040.030	M6X22*	100	51037.060.022	M10X30*	100	51037.100.030
M4X35*	100	51037.040.035	M6X25	25	51037.060.025	M10X40*	100	51037.100.040
M4X40*	100	51037.040.040	M6X30	25	51037.060.030	M10X50*	100	51037.100.050
M4X50*	100	51037.040.050	M6X35*	100	51037.060.035	M10X60*	100	51037.100.060
M5X8*	100	51037.050.008	M6X40	25	51037.060.040	M10X70*	100	51037.100.070
M5X10	50	51037.050.010	M6X45*	100	51037.060.045			
M5X12	50	51037.050.012	M6X50	25	51037.060.050			

SECURITY Śruby z łbem płaskim z 2 otworami

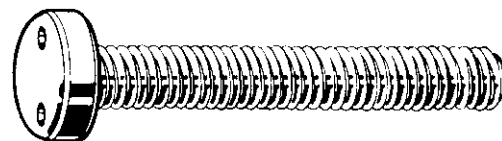
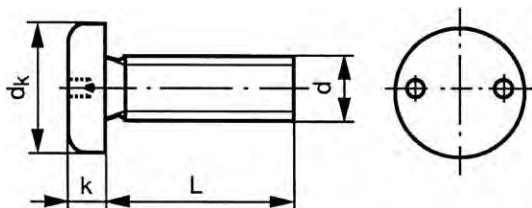

Informacje techniczne

d	dk	k	P	d	dk	k	P
M3	6	1.8	0.5	M5	10	3	0.8
M4	8	2.4	0.7	M6	12	3.6	1

51591 SECURITY Śruby zabezpieczające, z łbem płaskim z 2 otworami

K91A

Gwint Metryczny
Materiał Stal nierdzewna A2



d x L	☒	Kod artykułu	d x L	☒	Kod artykułu	d x L	☒	Kod artykułu
M3X6*	100	51591.030.006	M4X12	10	51591.040.012	M5X30	10	51591.050.030
M3X8*	100	51591.030.008	M4X16	10	51591.040.016	M6X10*	100	51591.060.010
M3X10	10	51591.030.010	M4X20	10	51591.040.020	M6X12	10	51591.060.012
M3X12	10	51591.030.012	M4X25	10	51591.040.025	M6X16	10	51591.060.016
M3X16	10	51591.030.016	M5X10*	100	51591.050.010	M6X20	10	51591.060.020
M3X20*	100	51591.030.020	M5X12	10	51591.050.012	M6X25	10	51591.060.025
M4X6*	100	51591.040.006	M5X16	10	51591.050.016	M6X30	10	51591.060.030
M4X8*	100	51591.040.008	M5X20	10	51591.050.020	M6X40	10	51591.060.040
M4X10	10	51591.040.010	M5X25	10	51591.050.025			

SECURITY wkręty z łbem walcowo-wypukłym jednokierunkowe

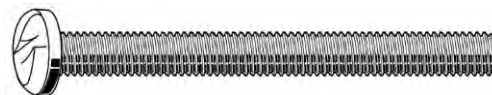
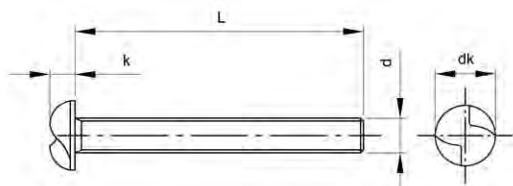

Informacje techniczne

d	dk	k
M4	7.5	3
M5	9.17	3.5
M6	12	4.4
M8	13	4.8

51667 SECURITY wkręty z łbem walcowo-wypukłym jednokierunkowe

K91A

Gwint Metryczny
Materiał Stal nierdzewna A2

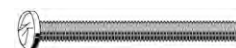

d x L	☒	Kod artykułu	d x L	☒	Kod artykułu	d x L	☒	Kod artykułu
M4X8*	100	51667.040.008	M4X50*	100	51667.040.050	M5X40*	100	51667.050.040
M4X10*	100	51667.040.010	M5X8*	100	51667.050.008	M5X50*	100	51667.050.050
M4X12*	100	51667.040.012	M5X10*	100	51667.050.010	M5X60*	100	51667.050.060
M4X16*	100	51667.040.016	M5X12*	100	51667.050.012	M5X70*	100	51667.050.070
M4X20*	100	51667.040.020	M5X16*	100	51667.050.016	M6X10*	100	51667.060.010
M4X25*	100	51667.040.025	M5X20*	100	51667.050.020	M6X12*	100	51667.060.012
M4X30*	100	51667.040.030	M5X25*	100	51667.050.025	M6X16*	100	51667.060.016
M4X35*	100	51667.040.035	M5X30*	100	51667.050.030	M6X20*	100	51667.060.020
M4X40*	100	51667.040.040						

51667 SECURITY wkręty z łbem walcowo-wypukłym jednokierunkowe								
d x L	☒	Kod artykułu	d x L	☒	Kod artykułu	d x L	☒	Kod artykułu
M6X25*	100	51667.060.025	M6X70*	100	51667.060.070	M8X30*	100	51667.080.030
M6X30*	100	51667.060.030	M8X10*	100	51667.080.010	M8X35*	100	51667.080.035
M6X35*	100	51667.060.035	M8X12*	100	51667.080.012	M8X40*	100	51667.080.040
M6X40*	100	51667.060.040	M8X16*	100	51667.080.016	M8X45*	100	51667.080.045
M6X45*	100	51667.060.045	M8X20*	100	51667.080.020	M8X50*	100	51667.080.050
M6X50*	100	51667.060.050	M8X25*	100	51667.080.025	M8X60*	100	51667.080.060
M6X60*	100	51667.060.060				M8X70*	100	51667.080.070

SECURITY Wkręty stożkowe ze szpilką zabezpieczającą

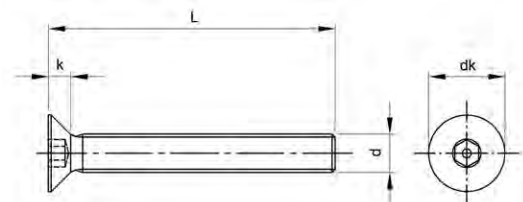

Informacje techniczne			
d	dk	k	Nasadka
M3	6	1.75	2
M4	8	2.4	2.5
M5	10	2.95	3
M6	12	3.45	4
M8	16	4.6	5
M10	20	5.5	6

51578 SECURITY Wkręty stożkowe ze szpilką zabezpieczającą		K91A
Gwint	Metryczny	
Materiał	Stal nierdzewna A2	

d x L	☒	Kod artykułu	d x L	☒	Kod artykułu	d x L	☒	Kod artykułu
M3X6*	100	51578.030.006	M5X12*	100	51578.050.012	M8X10*	100	51578.080.010
M3X8*	100	51578.030.008	M5X16*	100	51578.050.016	M8X12*	100	51578.080.012
M3X10*	100	51578.030.010	M5X20*	100	51578.050.020	M8X16*	100	51578.080.016
M3X12*	100	51578.030.012	M5X25*	100	51578.050.025	M8X20*	100	51578.080.020
M3X16*	100	51578.030.016	M5X30*	100	51578.050.030	M8X25*	100	51578.080.025
M3X20*	100	51578.030.020	M5X40*	100	51578.050.040	M8X30*	100	51578.080.030
M4X8*	100	51578.040.008	M5X50*	100	51578.050.050	M8X40*	100	51578.080.040
M4X10*	100	51578.040.010	M6X10*	100	51578.060.010	M8X50*	100	51578.080.050
M4X12*	100	51578.040.012	M6X12*	100	51578.060.012	M8X60*	100	51578.080.060
M4X16*	100	51578.040.016	M6X16*	100	51578.060.016			
M4X20*	100	51578.040.020	M6X20*	100	51578.060.020	M10X25*	100	51578.100.025
M4X25*	100	51578.040.025	M6X25*	100	51578.060.025	M10X30*	100	51578.100.030
M4X30*	100	51578.040.030	M6X30*	100	51578.060.030	M10X40*	100	51578.100.040
M4X40*	100	51578.040.040	M6X40*	100	51578.060.040	M10X50*	100	51578.100.050
M5X10*	100	51578.050.010	M6X50*	100	51578.060.050	M10X60*	100	51578.100.060

SECURITY Wkręty z łbem stożkowym, gniazdem 6-kątnym i zatyczką

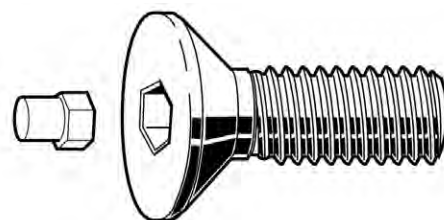
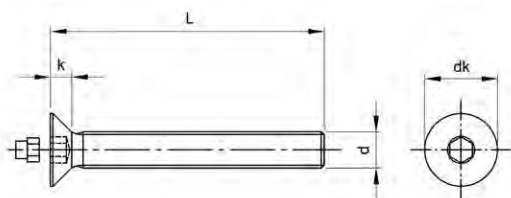

Informacje techniczne

d	d _k	k	Nasadka
M6	12	3.45	4
M8	16	4.6	5
M10	20	5.5	6
M12	24	6.5	8

51673 SECURITY Wkręty z łbem stożkowym, gniazdem 6-kątnym i zatyczką

K91A

Gwint Metryczny
Materiał Stal nierdzewna A2
Klasa 50

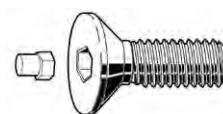

d x L	☒	Kod artykułu	d x L	☒	Kod artykułu	d x L	☒	Kod artykułu
M6X12*	100	51673.060.012	M6X50*	100	51673.060.050	M8X60*	100	51673.080.060
M6X20*	100	51673.060.020						
M6X25*	100	51673.060.025	M8X16*	100	51673.080.016	M10X25*	100	51673.100.025
M6X30*	100	51673.060.030	M8X40*	100	51673.080.040			
M6X40*	100	51673.060.040	M8X50*	100	51673.080.050	M12X30*	100	51673.120.030

SECURITY Śruby stożkowe torx ze szpilką metryczną

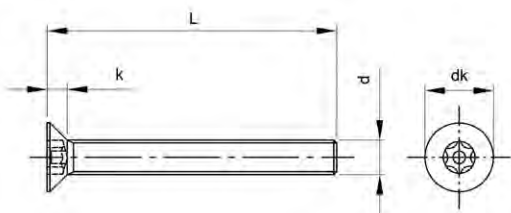

Informacje techniczne

d	d _k	k	Nasadka
M3	6	1.75	T10
M4	8	2.4	T20
M5	10	2.95	T25
M6	12	3.45	T30

51574 SECURITY Śruby stożkowe torx ze szpilką metryczną

K91A

Gwint Metryczny
Materiał Stal nierdzewna A2
Klasa 50



d x L	☒	Kod artykułu	d x L	☒	Kod artykułu	d x L	☒	Kod artykułu
M3X6*	100	51574.030.006	M4X16*	100	51574.040.016	M5X20*	100	51574.050.020
M3X8*	100	51574.030.008	M4X20*	100	51574.040.020	M5X25*	100	51574.050.025
M3X10*	100	51574.030.010	M4X25*	100	51574.040.025	M5X30*	100	51574.050.030
M3X12*	100	51574.030.012	M4X30*	100	51574.040.030	M5X40*	100	51574.050.040
M3X16*	100	51574.030.016	M4X40*	100	51574.040.040	M5X50*	100	51574.050.050
M3X20*	100	51574.030.020	M4X50*	100	51574.040.050	M5X60*	100	51574.050.060
						M5X70*	100	51574.050.070
M4X6*	100	51574.040.006	M5X8*	100	51574.050.008	M5X80*	100	51574.050.080
M4X8*	100	51574.040.008	M5X10*	100	51574.050.010			
M4X10*	100	51574.040.010	M5X12*	100	51574.050.012	M6X10*	100	51574.060.010
M4X12*	100	51574.040.012	M5X16*	100	51574.050.016	M6X12*	100	51574.060.012

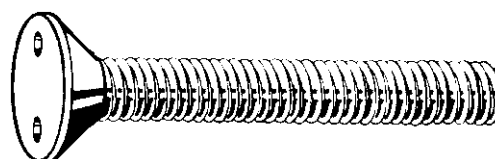
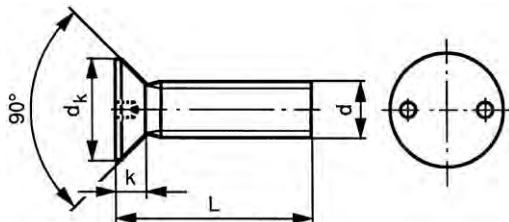

51574 SECURITY Śruby stożkowe torx ze szpilką metryczne								
d x L	☒	Kod artykułu	d x L	☒	Kod artykułu	d x L	☒	Kod artykułu
M6X16*	100	51574.060.016	M6X30*	100	51574.060.030	M6X60*	100	51574.060.060
M6X20*	100	51574.060.020	M6X40*	100	51574.060.040			
M6X25*	100	51574.060.025	M6X50*	100	51574.060.050			

SECURITY Śruby z łbem stożkowym z 2 otworami



Informacje techniczne

d	dk	k (maks.)	P	d	dk	k (maks.)	P
M3	6.3	1.7	0.5	M5	10.4	2.7	0.8
M4	9.4	2.7	0.7	M6	12.6	3.3	1

51592 SECURITY Śruby zabezpieczające, z łbem stożkowym z 2 otworami		K91A
Gwint	Metryczny	
Materiał	Stal nierdzewna A2	
		
		

d x L	☒	Kod artykułu	d x L	☒	Kod artykułu	d x L	☒	Kod artykułu
M3X10	10	51592.030.010	M4X20	10	51592.040.020	M5X30	10	51592.050.030
M3X12	10	51592.030.012	M4X25	10	51592.040.025	M6X12	10	51592.060.012
M3X16	10	51592.030.016	M5X12	10	51592.050.012	M6X20	10	51592.060.020
M4X10	10	51592.040.010	M5X16	10	51592.050.016	M6X25	10	51592.060.025
M4X12	10	51592.040.012	M5X20	10	51592.050.020	M6X30	10	51592.060.030
M4X16	10	51592.040.016	M5X25	10	51592.050.025	M6X40	10	51592.060.040

SECURITY Śruby z gniazdem sześciokątnym ze szpilką

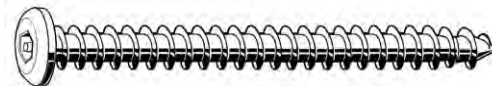
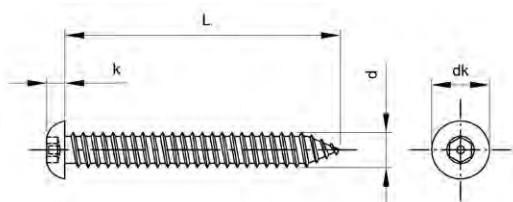

Informacje techniczne

d	d _k	k	Nasadka
ST3.5	5.7	1.65	2
ST4.2	7.6	2.2	2.5
ST4.8	9.5	2.75	3
ST6.3	10.5	3.3	4

51599 SECURITY Śruby z gniazdem sześciokątnym ze szpilką

K91A

Gwint Samogwintujący
Materiał Stal nierdzewna A2



d x L	☒	Kod artykułu	d x L	☒	Kod artykułu	d x L	☒	Kod artykułu
ST3,5X9,5MM*	100	51599.035.009	ST4,2X19MM*	100	51599.042.019	ST4,8X32MM*	100	51599.048.032
ST3,5X13MM*	100	51599.035.013	ST4,2X25MM*	100	51599.042.025	ST4,8X38MM*	100	51599.048.038
ST3,5X16MM*	100	51599.035.016	ST4,2X32MM*	100	51599.042.032	ST4,8X50MM*	100	51599.048.050
ST3,5X19MM*	100	51599.035.019	ST4,2X38MM*	100	51599.042.038			
ST3,5X25MM*	100	51599.035.025	ST4,2X50MM*	100	51599.042.050	ST6,3X16MM*	100	51599.063.016
ST3,5X38MM*	100	51599.035.038				ST6,3X19MM*	100	51599.063.019
			ST4,8X13MM*	100	51599.048.013	ST6,3X25MM*	100	51599.063.025
ST4,2X9,5MM*	100	51599.042.009	ST4,8X16MM*	100	51599.048.016	ST6,3X32MM*	100	51599.063.032
ST4,2X13MM*	100	51599.042.013	ST4,8X19MM*	100	51599.048.019	ST6,3X38MM*	100	51599.063.038
ST4,2X16MM*	100	51599.042.016	ST4,8X25MM*	100	51599.048.025	ST6,3X50MM*	100	51599.063.050

SECURITY śruby zabezpieczające z łbem grzybkowym i gniazdem torx ze szpilką

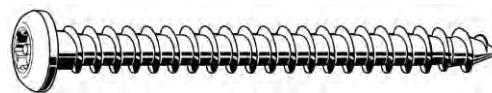
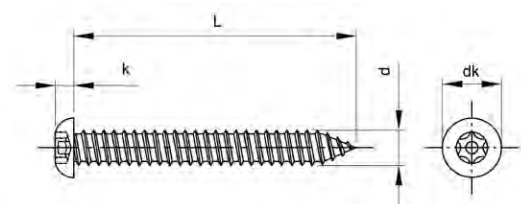

Informacje techniczne

d	d _k	k	Nasadka
ST3.5	5.7	1.65	T10
ST4.2	7.6	2.2	T15
ST4.8	9.5	2.75	T25
ST5.5	9.9	2.9	T27
ST6.3	10.5	3.3	T27

51572 SECURITY śruby zabezpieczające z łbem grzybkowym i gniazdem torx ze szpilką

K91A

Gwint Samogwintujący
Material Stal nierdzewna A2



d x L	☒	Kod artykułu	d x L	☒	Kod artykułu	d x L	☒	Kod artykułu
ST3,5X13MM*	100	51572.035.013	ST4,8X13MM*	100	51572.048.013	ST5,5X50MM*	100	51572.055.050
ST3,5X19MM*	100	51572.035.019	ST4,8X19MM*	100	51572.048.019	ST5,5X63MM*	100	51572.055.063
ST3,5X25MM*	100	51572.035.025	ST4,8X25MM*	100	51572.048.025	ST5,5X75MM*	100	51572.055.075
ST3,5X38MM*	100	51572.035.038	ST4,8X32MM*	100	51572.048.032			
ST4,2X13MM*	100	51572.042.013	ST4,8X38MM*	100	51572.048.038	ST6,3X13MM*	100	51572.063.013
ST4,2X19MM*	100	51572.042.019	ST4,8X50MM*	100	51572.048.050	ST6,3X19MM*	100	51572.063.019
ST4,2X25MM*	100	51572.042.025				ST6,3X25MM*	100	51572.063.025
ST4,2X32MM*	100	51572.042.032	ST5,5X19MM*	100	51572.055.019	ST6,3X32MM*	100	51572.063.032
ST4,2X38MM*	100	51572.042.038	ST5,5X32MM*	100	51572.055.032	ST6,3X38MM*	100	51572.063.038
			ST5,5X38MM*	100	51572.055.038	ST6,3X50MM*	100	51572.063.050

SECURITY wkręty z łbem walcowo wypukłym z gniazdem Philips ze szpilką

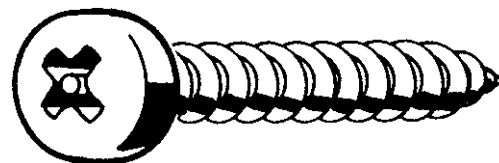
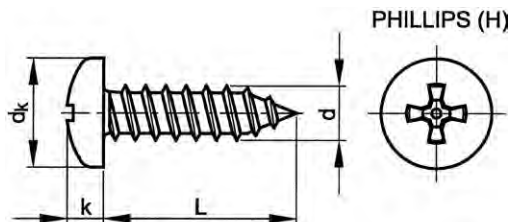

Informacje techniczne

d	$d_k \approx$	$k \approx$	Nr wgłębienia krzyżowego	P
ST3.5	7	2.5	2	1.3
ST4.2	8.1	2.8	2	1.4
ST4.8	9.3	3.5	2	1.6
ST5.5	10.6	3.8	3	1.8

51593 SECURITY wkręty z łbem walcowo wypukłym z gniazdem Philips ze szpilką

K91A

Gwint Samogwintujący
Materiał Stal nierdzewna A2



d x L	☒	Kod artykułu	d x L	☒	Kod artykułu	d x L	☒	Kod artykułu
ST3,5X13MM	10	51593.035.013	ST4,2X32MM	10	51593.042.032	ST4,8X50MM	10	51593.048.050
ST3,5X19MM	10	51593.035.019	ST4,2X38MM	10	51593.042.038	ST5,5X19MM	10	51593.055.019
ST3,5X25MM	10	51593.035.025	ST4,8X13MM	10	51593.048.013	ST5,5X25MM	10	51593.055.025
ST3,5X38MM	10	51593.035.038	ST4,8X19MM	10	51593.048.019	ST5,5X32MM	10	51593.055.032
ST4,2X13MM	10	51593.042.013	ST4,8X25MM	10	51593.048.025	ST5,5X38MM	10	51593.055.038
ST4,2X19MM	10	51593.042.019	ST4,8X32MM	10	51593.048.032	ST5,5X50MM	10	51593.055.050
ST4,2X25MM	10	51593.042.025	ST4,8X38MM	10	51593.048.038			

SECURITY Wkręt z łbem kulistym z 2 otworami

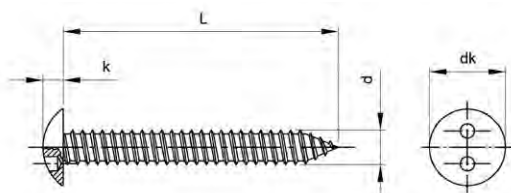

Informacje techniczne

d	d_k	k
ST4.2	9.5	2.2
ST4.8	10.5	2.75

51598 SECURITY wkręty zabezpieczające z łbem kulistym z 2 otworami

K91A

Gwint Samogwintujący
Materiał Stal nierdzewna A2



d x L	☒	Kod artykułu	d x L	☒	Kod artykułu	d x L	☒	Kod artykułu
ST4,2X13MM*	100	51598.042.013	ST4,8X9,5MM*	100	51598.048.009	ST4,8X25MM*	100	51598.048.025
ST4,2X19MM*	100	51598.042.019	ST4,8X13MM*	100	51598.048.013	ST4,8X32MM*	100	51598.048.032
ST4,2X25MM*	100	51598.042.025	ST4,8X19MM*	100	51598.048.019	ST4,8X38MM*	100	51598.048.038
ST4,2X32MM*	100	51598.042.032				ST4,8X50MM*	100	51598.048.050
ST4,2X38MM*	100	51598.042.038						

SECURITY Wkręt z łbem walcowym z 2 otworami

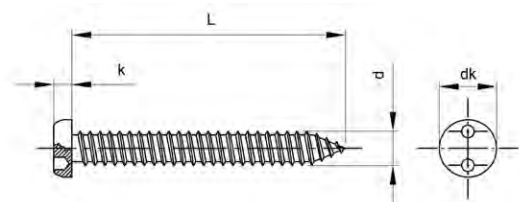

Informacje techniczne

d	d _k	k
ST2.9	5.6	1.65
ST3.5	5.7	1.65
ST4.2	7.6	2.2
ST4.8	9.5	2.75
ST5.5	10.5	3.3
ST6.3	12.4	3.3

51595 SECURITY śruby samoformujące walcowe z dwoma otworami

K91A

Gwint Samogwintujący
 Materiał Stal nierdzewna A2



d x L	☒	Kod artykułu	d x L	☒	Kod artykułu	d x L	☒	Kod artykułu
ST2,9X6,5MM*	100	51595.029.006	ST3,5X50MM*	100	51595.035.050	ST4,8X32MM*	100	51595.048.032
ST2,9X9,5MM*	100	51595.029.009	ST4,2X13MM*	100	51595.042.013	ST4,8X38MM*	100	51595.048.038
ST2,9X13MM*	100	51595.029.013	ST4,2X16MM*	100	51595.042.016	ST4,8X45MM*	100	51595.048.045
ST2,9X16MM*	100	51595.029.016	ST4,2X19MM*	100	51595.042.019	ST4,8X50MM*	100	51595.048.050
ST2,9X19MM*	100	51595.029.019	ST4,2X25MM*	100	51595.042.025	ST5,5X13MM*	100	51595.055.013
ST2,9X25MM*	100	51595.029.025	ST4,2X32MM*	100	51595.042.032	ST5,5X19MM*	100	51595.055.019
ST3,5X6,5MM*	100	51595.035.006	ST4,2X38MM*	100	51595.042.038	ST5,5X25MM*	100	51595.055.025
ST3,5X9,5MM*	100	51595.035.009	ST4,2X45MM*	100	51595.042.045	ST5,5X32MM*	100	51595.055.032
ST3,5X13MM*	100	51595.035.013	ST4,2X50MM*	100	51595.042.050	ST5,5X38MM*	100	51595.055.038
ST3,5X16MM*	100	51595.035.016	ST4,8X13MM*	100	51595.048.013	ST5,5X50MM*	100	51595.055.050
ST3,5X19MM*	100	51595.035.019	ST4,8X16MM*	100	51595.048.016	ST6,3X25MM*	100	51595.063.025
ST3,5X25MM*	100	51595.035.025	ST4,8X19MM*	100	51595.048.019	ST6,3X32MM*	100	51595.063.032
ST3,5X32MM*	100	51595.035.032	ST4,8X25MM*	100	51595.048.025	ST6,3X50MM*	100	51595.063.050
ST3,5X38MM*	100	51595.035.038						

SECURITY Wkręt z łbem one-way

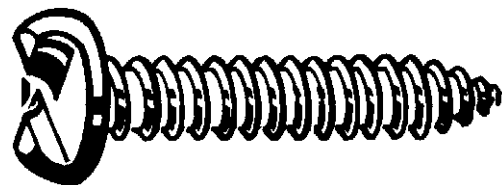
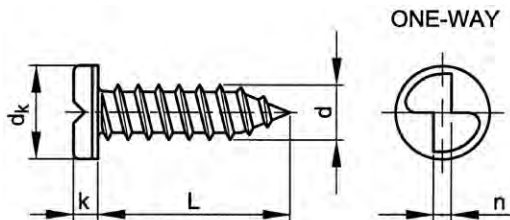

Informacje techniczne

d	d _k	k	n	P
ST2.9	5.6	1.75	0.8	1.1
ST3.5	6.9	2.1	1	1.3
ST4.2	8.2	2.45	1.2	1.4
ST4.8	9.1	3.5	1.4	1.6
ST5.5	10.4	3.9	1.6	1.8
ST6.3	12	4.4	2.0	1.8

Grupy katalogowe

Gwint	Gniazdo	Materiał	Obróbka powierzchni	Kod	Strona
ST	One-way	St	Ocynk.	26910	10-122
ST	One-way	St.St. A2		51668	10-122

26910 SECURITY Wkręt zabezpieczający, z łbem one-way

K91A

Gwint Samogwintujący
Materiał Stal
Obróbka powierzchni Ocynkowane



d x L	☒	Kod artykułu	d x L	☒	Kod artykułu	d x L	☒	Kod artykułu
ST2,9X19MM	200	26910.029.019	ST3,5X25MM	200	26910.035.025	ST4,2X32MM	200	26910.042.032
ST3,5X13MM	200	26910.035.013	ST4,2X19MM	200	26910.042.019	ST4,2X38MM	200	26910.042.038
ST3,5X19MM	200	26910.035.019	ST4,2X25MM	200	26910.042.025	ST4,2X50MM	200	26910.042.050
						ST4,2X63MM	200	26910.042.063

51668 SECURITY Wkręt zabezpieczający, z łbem one-way

K91A

Gwint Samogwintujący
Materiał Stal nierdzewna A2



d x L	☒	Kod artykułu	d x L	☒	Kod artykułu	d x L	☒	Kod artykułu
ST2,9X9,5MM	200	51668.029.009	ST4,2X32MM	200	51668.042.032	ST5,5X25MM*	100	51668.055.025
ST2,9X13MM	200	51668.029.013	ST4,2X38MM	200	51668.042.038	ST5,5X32MM*	100	51668.055.032
ST2,9X16MM*	100	51668.029.016	ST4,2X50MM	200	51668.042.050	ST5,5X38MM*	100	51668.055.038
ST2,9X19MM	200	51668.029.019				ST5,5X50MM*	100	51668.055.050
			ST4,8X13MM*	100	51668.048.013	ST5,5X63MM*	100	51668.055.063
ST3,5X13MM	200	51668.035.013	ST4,8X16MM*	100	51668.048.016			
ST3,5X16MM*	100	51668.035.016	ST4,8X19MM*	100	51668.048.019	ST6,3X19MM*	100	51668.063.019
ST3,5X19MM	200	51668.035.019	ST4,8X25MM*	100	51668.048.025	ST6,3X25MM*	100	51668.063.025
ST3,5X25MM	200	51668.035.025	ST4,8X32MM*	100	51668.048.032	ST6,3X32MM*	100	51668.063.032
ST3,5X32MM*	100	51668.035.032	ST4,8X38MM*	100	51668.048.038	ST6,3X38MM*	100	51668.063.038
			ST4,8X50MM*	100	51668.048.050	ST6,3X50MM*	100	51668.063.050
ST4,2X13MM*	100	51668.042.013				ST6,3X63MM*	100	51668.063.063
ST4,2X19MM	200	51668.042.019	ST5,5X19MM*	100	51668.055.019	ST6,3X75MM*	100	51668.063.075
ST4,2X25MM	200	51668.042.025						

SECURITY Wkręt z łbem kulistym z gn. trójskrzydłowym

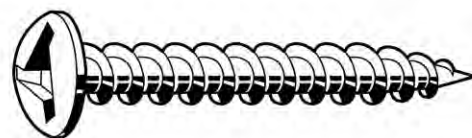
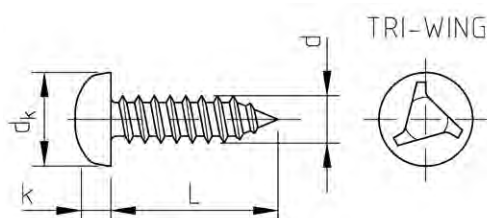

Informacje techniczne

d	d _k	k	Nr wgłębienia trójskrzydłowego	P
ST4.2	8.18	2.44	W4	1.7
ST4.8	9.48	2.88	W5	2

51669 SECURITY Wkręt zabezpieczający, z łbem kulistym z gniazdem trójskrzydłowym

K91A

Gwint Samogwintujący
Materiał Stal nierdzewna A2



d x L	☒	Kod artykułu	d x L	☒	Kod artykułu	d x L	☒	Kod artykułu
ST4,2X13MM	10	51669.042.013	ST4,2X32MM	10	51669.042.032	ST4,8X19MM	10	51669.048.019
ST4,2X19MM	10	51669.042.019				ST4,8X25MM	10	51669.048.025
ST4,2X25MM	10	51669.042.025	ST4,8X13MM	10	51669.048.013			

SECURITY Wkręty stożkowe z gniazdem i szpilką

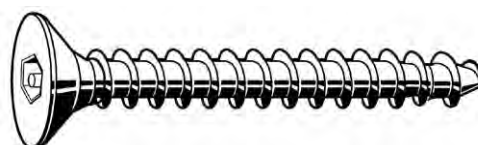
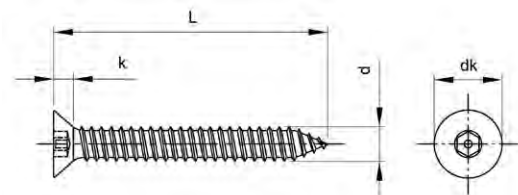

Informacje techniczne

d	d _k	k	Nasadka
ST3.5	6.8	2.15	2
ST4.2	8.1	2.6	2.5
ST4.8	9.5	3.15	3
ST5.5	10.8	3.55	4
ST6.3	12.4	4	4

51588 SECURITY Wkręty stożkowe z gniazdem i szpilką

K91A

Gwint Samogwintujący
Materiał Stal nierdzewna A2



d x L	☒	Kod artykułu	d x L	☒	Kod artykułu	d x L	☒	Kod artykułu
ST3,5X9,5MM*	100	51588.035.009	ST4,2X38MM*	100	51588.042.038	ST5,5X19MM*	100	51588.055.019
ST3,5X19MM*	100	51588.035.019	ST4,2X50MM*	100	51588.042.050	ST5,5X32MM*	100	51588.055.032
ST3,5X25MM*	100	51588.035.025						
ST3,5X38MM*	100	51588.035.038	ST4,8X16MM*	100	51588.048.016	ST6,3X19MM*	100	51588.063.019
ST4,2X13MM*	100	51588.042.013	ST4,8X19MM*	100	51588.048.019	ST6,3X25MM*	100	51588.063.025
ST4,2X16MM*	100	51588.042.016	ST4,8X25MM*	100	51588.048.025	ST6,3X50MM*	100	51588.063.050
ST4,2X19MM*	100	51588.042.019	ST4,8X32MM*	100	51588.048.032			
ST4,2X25MM*	100	51588.042.025	ST4,8X38MM*	100	51588.048.038			
			ST4,8X50MM*	100	51588.048.050			

10

SECURITY Śruby stożkowe torx ze szpilką

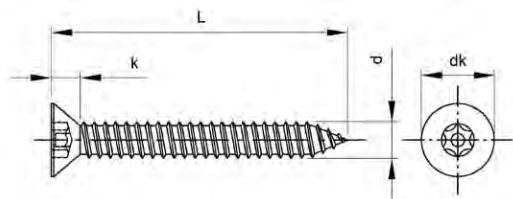

Informacje techniczne

d	d _k	k	Nasadka
ST3.5	6.8	2.15	T15
ST4.2	8.1	2.6	T20
ST4.8	9.5	3.15	T25
ST5.5	10.8	3.55	T27
ST6.3	12.4	4	T30

51573 SECURITY Śruby stożkowe torx ze szpilką

K91A

Gwint Samogwintujący
Materiał Stal nierdzewna A2



d x L	☒	Kod artykułu	d x L	☒	Kod artykułu	d x L	☒	Kod artykułu
ST3,5X13MM*	100	51573.035.013	ST4,2X32MM*	100	51573.042.032	ST5,5X25MM*	100	51573.055.025
ST3,5X16MM*	100	51573.035.016	ST4,2X38MM*	100	51573.042.038	ST5,5X38MM*	100	51573.055.038
ST3,5X19MM*	100	51573.035.019				ST5,5X50MM*	100	51573.055.050
ST3,5X25MM*	100	51573.035.025	ST4,8X13MM*	100	51573.048.013	ST5,5X75MM*	100	51573.055.075
ST3,5X32MM*	100	51573.035.032	ST4,8X16MM*	100	51573.048.016			
ST3,5X38MM*	100	51573.035.038	ST4,8X19MM*	100	51573.048.019	ST6,3X16MM*	100	51573.063.016
			ST4,8X25MM*	100	51573.048.025	ST6,3X19MM*	100	51573.063.019
ST4,2X13MM*	100	51573.042.013	ST4,8X32MM*	100	51573.048.032	ST6,3X25MM*	100	51573.063.025
ST4,2X16MM*	100	51573.042.016	ST4,8X38MM*	100	51573.048.038	ST6,3X32MM*	100	51573.063.032
ST4,2X19MM*	100	51573.042.019	ST4,8X50MM*	100	51573.048.050	ST6,3X38MM*	100	51573.063.038
ST4,2X25MM*	100	51573.042.025				ST6,3X50MM*	100	51573.063.050

SECURITY Wkręt z łbem stożkowym z gn. PHILIPS ze szpilką

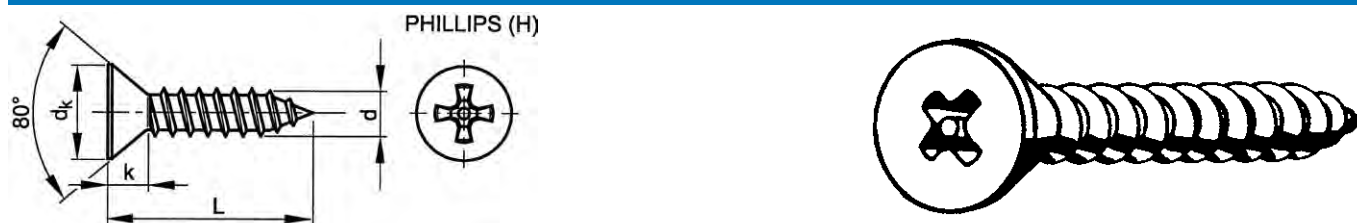

Informacje techniczne

d	$d_k \approx$	$k \approx$	Nr wgłębienia krzyżowego	P
ST3.5	6.7	2.7	2	1.3
ST4.2	8.3	3.4	2	1.4
ST4.8	9	3.4	2	1.6
ST5.5	10.6	4.3	3	1.8

51594 SECURITY Wkręty samogwintujące z łbem stożkowym i wgłębieniem krzyżowym Phillips, ze szpilką

K91A

Gwint Samogwintujący
Materiał Stal nierdzewna A2



d x L	☒	Kod artykułu	d x L	☒	Kod artykułu	d x L	☒	Kod artykułu
ST3,5X13MM	10	51594.035.013	ST4,2X32MM	10	51594.042.032	ST4,8X50MM	10	51594.048.050
ST3,5X25MM	10	51594.035.025	ST4,2X38MM	10	51594.042.038	ST5,5X19MM	10	51594.055.019
ST3,5X32MM	10	51594.035.032	ST4,8X19MM	10	51594.048.019	ST5,5X25MM	10	51594.055.025
ST3,5X38MM	10	51594.035.038	ST4,8X25MM	10	51594.048.025	ST5,5X32MM	10	51594.055.032
ST4,2X19MM	10	51594.042.019	ST4,8X32MM	10	51594.048.032	ST5,5X38MM	10	51594.055.038
ST4,2X25MM	10	51594.042.025	ST4,8X38MM	10	51594.048.038	ST5,5X50MM	10	51594.055.050

SECURITY Wkręt z łbem stożkowym z 2 otworami



Informacje techniczne

d	d_k	k
ST2.9	5.6	1.7
ST3.5	6.8	2.15
ST4.2	8.1	2.6
ST4.8	9.5	3.15
ST5.5	10.8	3.55
ST6.3	12.4	4

51596 SECURITY śruby samoformujące walcowe z dwoma otworami

K91A

Gwint Samogwintujący
Materiał Stal nierdzewna A2



d x L	☒	Kod artykułu	d x L	☒	Kod artykułu	d x L	☒	Kod artykułu
ST2,9X6,5MM*	100	51596.029.006	ST3,5X13MM*	100	51596.035.013	ST4,2X13MM*	100	51596.042.013
ST2,9X9,5MM*	100	51596.029.009	ST3,5X16MM*	100	51596.035.016	ST4,2X16MM*	100	51596.042.016
ST2,9X13MM*	100	51596.029.013	ST3,5X19MM*	100	51596.035.019	ST4,2X19MM*	100	51596.042.019
ST2,9X19MM*	100	51596.029.019	ST3,5X25MM*	100	51596.035.025	ST4,2X25MM*	100	51596.042.025
ST2,9X25MM*	100	51596.029.025	ST3,5X32MM*	100	51596.035.032	ST4,2X32MM*	100	51596.042.032
ST3,5X9,5MM*	100	51596.035.009	ST3,5X38MM*	100	51596.035.038	ST4,2X38MM*	100	51596.042.038
						ST4,2X50MM*	100	51596.042.050

51596 SECURITY śruby samoformujące walcowe z dwoma otworami								
d x L	☒	Kod artykułu	d x L	☒	Kod artykułu	d x L	☒	Kod artykułu
ST4,8X13MM*	100	51596.048.013	ST4,8X38MM*	100	51596.048.038	ST5,5X38MM*	100	51596.055.038
ST4,8X16MM*	100	51596.048.016	ST4,8X45MM*	100	51596.048.045	ST5,5X50MM*	100	51596.055.050
ST4,8X19MM*	100	51596.048.019	ST4,8X50MM*	100	51596.048.050	ST6,3X50MM*	100	51596.063.050
ST4,8X25MM*	100	51596.048.025	ST5,5X25MM*	100	51596.055.025			
ST4,8X32MM*	100	51596.048.032	ST5,5X32MM*	100	51596.055.032			

SECURITY wkręty zabezpieczające z łbem stożkowo soczewkowym z 2 otworami

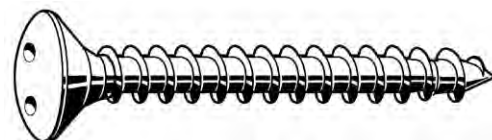
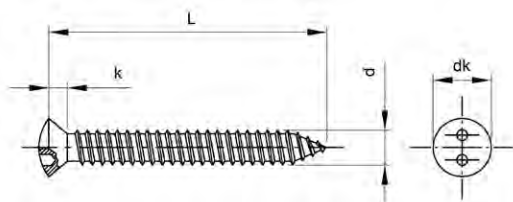

Informacje techniczne

d	dk	k
3.5	5.7	1.65
4.2	7.6	2.2
4.8	9.5	2.75

51597 SECURITY wkręty zabezpieczające z łbem stożkowo soczewkowym z 2 otworami		K91A
Gwint	Samogwintujący	
Materiał	Stal nierdzewna A2	

d x L	☒	Kod artykułu	d x L	☒	Kod artykułu	d x L	☒	Kod artykułu
ST3,5X16MM*	100	51597.035.016	ST4,2X13MM*	100	51597.042.013	ST4,8X13MM*	100	51597.048.013
ST3,5X19MM*	100	51597.035.019	ST4,2X19MM*	100	51597.042.019	ST4,8X19MM*	100	51597.048.019
ST3,5X25MM*	100	51597.035.025	ST4,2X25MM*	100	51597.042.025	ST4,8X25MM*	100	51597.048.025
ST3,5X32MM*	100	51597.035.032	ST4,2X32MM*	100	51597.042.032	ST4,8X32MM*	100	51597.048.032
ST3,5X38MM*	100	51597.035.038	ST4,2X38MM*	100	51597.042.038	ST4,8X38MM*	100	51597.048.038
ST3,5X50MM*	100	51597.035.050	ST4,2X50MM*	100	51597.042.050			

SECURITY Wkręt z łbem soczewkowym one-way

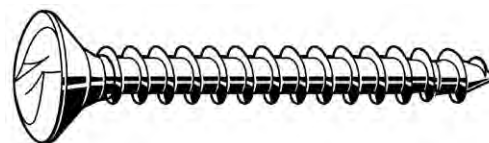
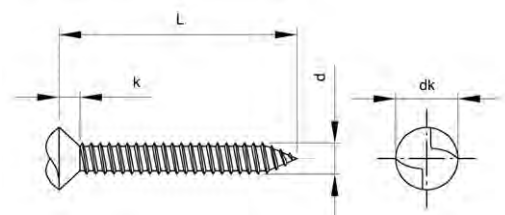

Informacje techniczne

d	d _k	k
4.2	8.4	3.9
4.8	9.8	4.5

51671 SECURITY Wkręt zabezpieczający, z łbem soczewkowym one-way

K91A

Gwint Samogwintujący
Material Stal nierdzewna A2



d x L	☒	Kod artykułu	d x L	☒	Kod artykułu	d x L	☒	Kod artykułu
ST4,2X13MM*	100	51671.042.013	ST4,2X38MM*	100	51671.042.038	ST4,8X19MM*	100	51671.048.019
ST4,2X19MM*	100	51671.042.019				ST4,8X25MM*	100	51671.048.025
ST4,2X25MM*	100	51671.042.025	ST4,8X13MM*	100	51671.048.013	ST4,8X38MM*	100	51671.048.038
ST4,2X32MM*	100	51671.042.032						

SECURITY Wkręty do drewna z łbem kulistym z gniazdem kwadratowym

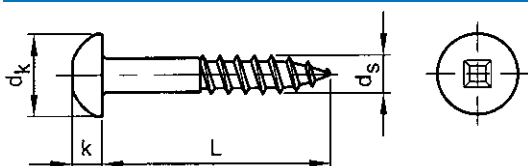

Informacje techniczne

d _s	d _k	k (maks.)	Nr kwadratowy
4.2	8	2.8	2

Grupy katalogowe

Gniazdo	Material	Obróbka powierzchni	Kod	Strona
Kwadratowe gniazdo	St	Ocynk.	25750	10-127
Kwadratowe gniazdo	St	Ocynk. z gwintem na całej długości	25751	10-128

25750 SECURITY Wkręty do drewna z łbem kulistym z gniazdem kwadratowym

K05A

Material Stal
Obróbka powierzchni Ocynkowane

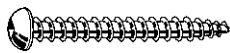

d _s x L	☒	Kod artykułu	d _s x L	☒	Kod artykułu	d _s x L	☒	Kod artykułu
4,2X32MM	200	25750.042.032	4,2X38MM	200	25750.042.038	4,2X50MM	200	25750.042.050

25751	SECURITY Wkręty do drewna z łbem kulistym z gniazdem kwadratowym - pełny gwint	K05A
Materiał	Stal	
Obróbka powierzchni	Ocynkowane	
		 

d_s x L	☒	Kod artykułu	d_s x L	☒	Kod artykułu
4,2X19MM	200	25751.042.019	4,2X25MM	200	25751.042.025

SECURITY Korki z napędem 6-kątnym

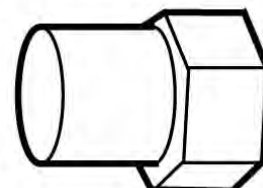
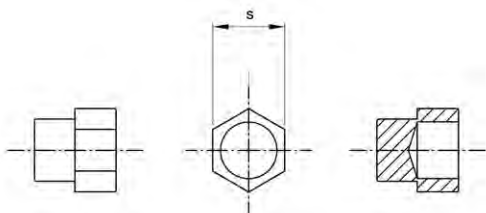

Informacje techniczne

d	s
M4	4
M5	5
M6	6
M8	8

51674	SECURITY Korki z napędem 6-kątnym	K91A
Materiał	Stal nierdzewna A1	
		 

d	☒	Kod artykułu	d	☒	Kod artykułu	d	☒	Kod artykułu
M4*	100	51674.040.001	M6*	100	51674.060.001	M8*	100	51674.080.001
M5*	100	51674.050.001						

SECURITY Korki z gniazdem torx

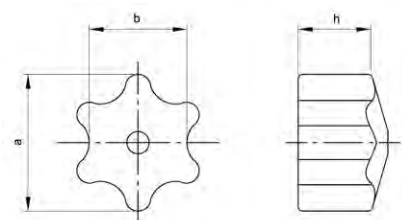

Informacje techniczne

d	a	b	h	Nasadka
10	2.74	2.05	1.1	T10
15	3.27	2.4	1.8	T15
20	3.86	2.85	1.6	T20
25	4.43	3.25	2.45	T25
30	5.52	4.05	2.2	T30
40	6.65	4.85	3.4	T40

51675 SECURITY Korki z gniazdem torx

K91A
Materiał Stal nierdzewna

Wymiary	☒	Kod artykułu	Wymiary	☒	Kod artykułu	Wymiary	☒	Kod artykułu
T10*	100	51675.000.010	T20*	100	51675.000.020	T30*	100	51675.000.030
T15*	100	51675.000.015	T25*	100	51675.000.025	T40*	100	51675.000.040

Szpilka do zgrzewania

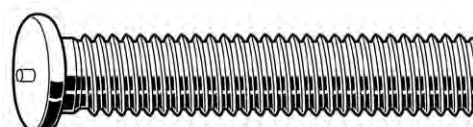
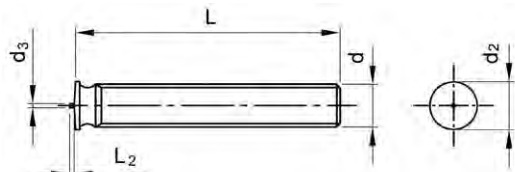

Informacje techniczne

d ₂	d ₂	d ₃	k	L ₂
M3	4.5	0.5	0.7	0.5
M4	5.5	0.6	0.7	0.7
M5	6.5	0.8	0.8	0.8
M6	7.5	0.9	0.8	1.0
M8	9	1.2	0.8	1.4

51190 Szpilka do zgrzewania

R09A
Gwint Metryczny
Materiał Stal nierdzewna A2

d x L	☒	Kod artykułu	d x L	☒	Kod artykułu	d x L	☒	Kod artykułu
M3X8*	500	51190.030.008	M4X20*	500	51190.040.020	M5X30*	500	51190.050.030
M3X10*	500	51190.030.010	M4X25*	500	51190.040.025	M5X35*	500	51190.050.035
M3X12*	500	51190.030.012	M4X30*	500	51190.040.030	M5X40*	500	51190.050.040
M3X16*	500	51190.030.016	M4X35*	500	51190.040.035	M6X8*	200	51190.060.008
M3X20*	500	51190.030.020	M5X8*	500	51190.050.008	M6X10*	200	51190.060.010
M3X25*	500	51190.030.025	M5X10*	500	51190.050.010	M6X12*	200	51190.060.012
M4X8*	500	51190.040.008	M5X12*	500	51190.050.012	M6X16*	200	51190.060.016
M4X10*	500	51190.040.010	M5X16*	500	51190.050.016	M6X20*	200	51190.060.020
M4X12*	500	51190.040.012	M5X20*	500	51190.050.020	M6X25*	200	51190.060.025
M4X16*	500	51190.040.016	M5X25*	500	51190.050.025	M6X30*	200	51190.060.030

51190		Szpilka do zgrzewania							
d x L	☒	Kod artykułu	d x L	☒	Kod artykułu	d x L	☒	Kod artykułu	
M6X35*	200	51190.060.035	M8X16*	200	51190.080.016	M8X40*	200	51190.080.040	
M6X40*	200	51190.060.040	M8X20*	200	51190.080.020	M8X45*	200	51190.080.045	
			M8X25*	200	51190.080.025	M8X50*	200	51190.080.050	
M8X10*	200	51190.080.010	M8X30*	200	51190.080.030	M8X60*	200	51190.080.060	
M8X12*	200	51190.080.012	M8X35*	200	51190.080.035				

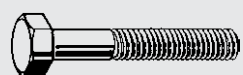

1 Śruby



2 Produkty z gniazdem sześciokątnym



3 Nakrętki, nitonakrętki & wkładki



4 Pręty gwintowane & śruby dwustronne



5 Haki & śruby oczkowe



6 Wkręty

I Index



7 Podkładki & pierścienie uszczelniające typu “O-ring”



8 Kotwy, kołki, dyble

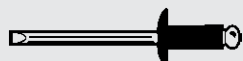

9 Nity, kołki & wpusty



10 Elementy łączące systemowe, meblowe & zabezpieczające

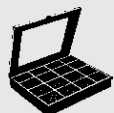

11 Zestawy

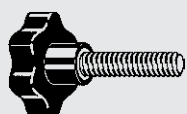

12 Części konstrukcyjne & części maszynowe

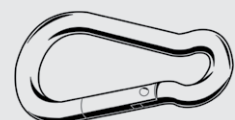

13 Przemysł morski

T Technologia łączenia

Zestawy **11**

 <p>Strona 11-3</p>	 <p>Strona 11-14</p>	 <p>Strona 11-24</p>	 <p>Strona 11-27</p>
Plastikowe kasety	Skrzynki stalowe	Kasety	Skrzynie transportowe

Fabory Kasety Asortymentowe Wysokiej Jakości

Kasety Asortymentowe Wysokiej Jakości Fabory, będące zbiorem najpopularniejszych elementów złącznych, zapewniają wyjątkową ofertę szeregu elementów złącznych w skrzyniach plastikowych (typy 9T i 18T) i stalowych (typ S) do napraw, konserwacji, serwisowania, itd. Wszystkie Zestawy Wysokiej Jakości Fabory są stale dostępne z magazynu.

Ponad 120 asortymentowych KASET plastikowych (typy 9T i 18T) z Asortymentu Wysokiej Jakości Fabory zostało starannie wybranych z najlepiej sprzedających się elementów złącznych, gdzie od lat stanowią niezbędne narzędzie każdego inżyniera utrzymania ruchu i serwisu.



Wszystkie zestawy w trwałych, przezroczystych skrzyniach są dostarczane z czytelną etykietą, wygodnie rozmieszczoną tabelą zawartości i zamykaną pokrywą. Przyjazne dla środowiska plastikowe kasety są dostarczane w wersji z 9 lub 18 przedziałowym wnętrzem.



Dzięki ich wyjątkowemu składowi, ponad 90 asortymentowych kaset stalowych (typ S) z Asortymentu Wysokiej Jakości Fabory, stanowią pełny zakres elementów złącznych, w związku z czym doskonale nadają się do napraw i utrzymania w fabrykach, na placu budowy lub w warsztacie.

Wszystkie zestawy w trwałych, stalowych skrzyniach są dostarczane z mocnym plastikowym wnętrzem, czytelną etykietą i wygodnie rozmieszczoną wielojęzyczną tabelą zawartości”.

Zestawy w plastikowych kasetach











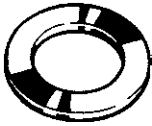

41000 Zestawy w plastikowych kasetach



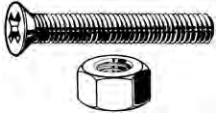
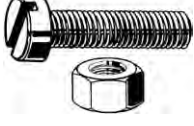
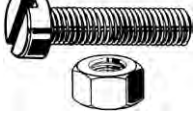
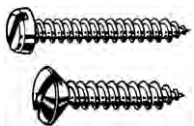







Y94A

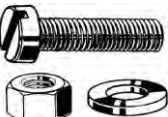

Wymiary	✉	Kod artykułu		
9 T 1	1	41000.000.001	<p>Skład:</p> <ul style="list-style-type: none"> • Podkładki sprężyste zgodn. z DIN 127 B • Stal cynkowana • Zawartość: • M5 / M6 / M8 / M10 / M11 / M12 / M14 / M16 / M20 • 523 szt. 	
9 T 3	1	41000.000.003	<p>Skład:</p> <ul style="list-style-type: none"> • Podkładki wachlarzowe ząbkowane zewnętrznie zgodn. z DIN 6798 A • Stal cynkowana • Zawartość: • M4 / M5 / M6 / M8 / M10 / M12 / M14 / M16 / M20 • 743 szt. 	
9 T 5	1	41000.000.005	<p>Skład:</p> <ul style="list-style-type: none"> • Podkładki stożkowe wachlarzowe ząbkowane zewnętrznie zgodn. z DIN 6798 V • Stal • Zawartość: • M3 / M4 / M5 / M6 / M8 / M10 / M12 / M14 / M16 / M20 • 595 szt. 	
9 T 6	1	41000.000.006	<p>Skład:</p> <ul style="list-style-type: none"> • Podkładki podatne faliste zgodn. z DIN 137 B • Stal • Zawartość: • M5 / M6 / M7 / M8 / M10 / M12 / M14 / M16 / M20 • 570 szt. 	
9 T 7	1	41000.000.007	<p>Skład:</p> <ul style="list-style-type: none"> • Podkładki okrągłe bez ścięcia zgodn. z DIN 125-1 A • Stal cynkowana • Zawartość: • M3 / M4 / M5 / M6 / M8 / M10 / M12 / M14 / M16 • 825 szt. 	
9 T 8	1	41000.000.008	<p>Skład:</p> <ul style="list-style-type: none"> • Podkładki okrągłe ze ścięciem zgodn. z DIN 125-1 B • Mosiądz • Zawartość: • M3 / M4 / M5 / M6 / M8 / M10 / M12 / M14 / M16 • 835 szt. 	
9 T 9	1	41000.000.009	<p>Skład:</p> <ul style="list-style-type: none"> • Podkładki okrągłe ze ścięciem zgodn. z DIN 125-1 B i podkładki okrągłe bez ścięcia zgodn. z DIN 125-1 A • Zawartość: • M5 / M6 / M8 / M10 / M11 / M12 / M14 / M16 / M20 • 440 szt. 	
18 T 10	1	41000.000.010	<p>Skład:</p> <ul style="list-style-type: none"> • Pierścienie uszczelniające zgodn. z DIN 7603 A • Aluminium 99F11, twardość HB 32-45 • Zawartość: • Ø 4x8x1 / 5x9x1 / 6x10x1 / 6x12x1 / 8x12x1 / 8x14x1 / 10x14x1 / 12x18x1,5 / 14x20x1,5 / 16x20x1,5 / 16x22x1,5 / 18x24x1,5 / 20x26x1,5 / 22x27x1,5 / 24x30x2 / 26x32x2 • 571 szt. 	
9 T 11	1	41000.000.011	<p>Skład:</p> <ul style="list-style-type: none"> • Podkładki okrągłe powiększone d2 ≈ 3xd1 zgodn. z DIN 9021 • Stal cynkowana • Zawartość: • Podkładki okrągłe powiększone: M4x20 / M5x20 / M6x25 / M8x30 / M10x30 / M12x36 • DIN 9021: M6x18 / M8x24 / M10x30 • 180 szt. 	
9 T 12	1	41000.000.012	<p>Skład:</p> <ul style="list-style-type: none"> • Pierścienie regulacyjne, grubość 0,1 mm • Stal • Zawartość: • Ø 8x20 / 10x22 / 12x24 / 14x26 / 16x28 / 18x30 / 20x32 / 22x34 / 24x36 • 215 szt. 	
9 T 13	1	41000.000.013	<p>Skład:</p> <ul style="list-style-type: none"> • Rozety otwarte • Mosiądz niklowany • Zawartość: • Ø 3,2 / 4 / 4,8 / 5,5 / 6,6 / 7,4 • 850 szt. 	

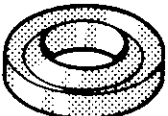
41000 Zestawy w plastikowych kasetach		←	
Wymiary	☒	Kod artykułu	
18 T 14	1	41000.000.014 Skład: <ul style="list-style-type: none"> Pierścienie uszczelniające zgodn. z DIN 7603 A Miedź, wyarzona Zawartość: Ø 5x10x1 / 6x10x1 / 7x10x1 / 8x12x1 / 9x14x1 / 10x16x1,5 / 10,5x17x1,5 / 11x17x1,5 / 12x16x1,5 / 12,5x20x1,5 / 13x18x2 / 14x18x1 / 14x20x1,5 / 15x20x2 / 16x22x2 / 16,5x24x2 / 17x24x2 / 17,5x25x2 44 szt. 	
9 T 15	1	41000.000.015 Skład: <ul style="list-style-type: none"> Pierścienie uszczelniające zgodn. z DIN 7603 A Miedź, wyarzona Zawartość: Ø 18x24x2 / 20x24x2 / 22x26x2 / 24x30x2 / 26x33x2 / 28x35x2 / 30x38x2 / 32x40x2 / 35x45x2 90 szt. 	
9 T 16	1	41000.000.016 Skład: <ul style="list-style-type: none"> Zawlecзки zgodn. z DIN 94 Stal Zawartość: 1x25 / 1,6x32 / 2x40 / 2,5x40 / 3,2x40 -x50 / 4x32 -x50 / 5x50 600 szt. 	
9 T 17	1	41000.000.017 Skład: <ul style="list-style-type: none"> Wkręty z łbem walcowym płaskim z rowkiem zgodn. z DIN 84 i nakrętki sześciokątne zgodn. z DIN 934 Stal klasy 4.8-l8l cynkowana Zawartość: M3x25 -x40 / M4x25 -x40 / M5x25 -x40 / M6x25 -x40 -x50 550 szt. 	
9 T 18	1	41000.000.018 Skład: <ul style="list-style-type: none"> Wkręty z łbem stożkowym z rowkiem zgodn. z DIN 963 i nakrętki sześciokątne zgodn. z DIN 934 Stal klasy 4.8-l8l cynkowana Zawartość: M3x10 -x30 / M4x16 -x40 / M5x16 -x30 -x40 / M6x16 -x50 490 szt. 	
9 T 19	1	41000.000.019 Skład: <ul style="list-style-type: none"> Wkręty z łbem walcowym stożkowym z wgłębieniem krzyżowym Phillips (H) zgodn. z DIN 7985 H i nakrętki sześciokątne zgodn. z DIN 934 Stal klasy 4.8-l8l cynkowana Zawartość: M3x25 -x30 / M4x25 -x40 / M5x25 -x40 / M6x25 -x40 -x50 550 szt. 	
9 T 20	1	41000.000.020 Skład: <ul style="list-style-type: none"> Wkręty z łbem stożkowym płaskim z wgłębieniem krzyżowym Phillips (H) zgodn. z DIN 965 H i nakrętki sześciokątne zgodn. z DIN 934 Stal klasy 4.8-l8l cynkowana Zawartość: M3x10 -x20 / M4x16 -x30 / M5x16 -x30 -x40 / M6x16 -x50 480 szt. 	
9 T 21	1	41000.000.021 Skład: <ul style="list-style-type: none"> Wkręty z łbem walcowym płaskim z rowkiem zgodn. z DIN 84 i nakrętki sześciokątne zgodn. z DIN 934 Stal klasy 4.8-l8l cynkowana Zawartość: M5x10 -x16 -x20 -x25 / M6x10 -x16 -x20 -x25 -x30 400 szt. 	
9 T 22	1	41000.000.022 Skład: <ul style="list-style-type: none"> Wkręty z łbem walcowym płaskim z rowkiem zgodn. z DIN 84 i nakrętki sześciokątne zgodn. z DIN 934 Mosiądz Zawartość: M3x25 -x40 / M4x25 -x40 / M5x25 -x40 / M6x25 -x40 -x50 470 szt. 	
9 T 23	1	41000.000.023 Skład: <ul style="list-style-type: none"> Wkręty z łbem walcowym płaskim z rowkiem zgodn. z DIN 7971 C i wkręty z łbem stożkowym soczewkowym z rowkiem zgodn. z DIN 7973 C Stal niklowana Zawartość: ST2,9x13 / ST3,5x16 -x19 / ST4,2x16 -x19 -x25 / ST4,8x16 -x19 / ST5,5x25 390 szt. 	
9 T 24	1	41000.000.024 Skład: <ul style="list-style-type: none"> Wkręty z łbem walcowym płaskim z rowkiem zgodn. z DIN 7971 C Stal niklowana Zawartość: ST2,9x13 / ST3,5x16 -x19 / ST4,2x16 -x19 -x25 / ST4,8x16 -x19 / ST5,5x25 390 szt. 	
9 T 25	1	41000.000.025 Skład: <ul style="list-style-type: none"> Wkręty z łbem stożkowym soczewkowym z rowkiem zgodn. z DIN 7973 C Stal niklowana Zawartość: ST2,9x13 / ST3,5x16 -x19 / ST4,2x16 -x19 -x25 / ST4,8x16 -x19 / ST5,5x25 390 szt. 	
9 T 26	1	41000.000.026 Skład: <ul style="list-style-type: none"> BEZPIECZEŃSTWO Jednostronne wkręty samogwintujące Stal cynkowana Zawartość: ST2,9x19 / ST3,5x13 -x19 -x25 / ST4,2x19 -x25 -x32 -x38 -x50 370 szt. 	

41000		Zestawy w plastikowych kasetach		←
Wymiary	☒	Kod artykułu		
9 T 27	1	41000.000.027	Skład: <ul style="list-style-type: none"> • Wkręty samogwintujące z łbem sześciokątnym kołnierzym zgodn. z ≈ DIN 7976 C, wkręty samogwintujące z łbem sześciokątnym zgodn. z DIN 7976 F i wkręty samogwintujące z łbem sześciokątnym ze stożkową końcówką i niespadającą podkładką • Stal cynkowana i stal cynkowana, pasywacja na żółto • Zawartość: <ul style="list-style-type: none"> • ≈ DIN 7976 C: ST3,5x16 / ST4,2x16 -x19 -x25 / ST4,8x19 -x25 • DIN 7976 F: ST6,3x25 • Ze stożkową końcówką i podkładką zabezpieczoną przed wypadnięciem: ST5,6x13 / ST6,5x20 • 255 szt. 	
18 T 28	1	41000.000.028	Skład: <ul style="list-style-type: none"> • Wkręty samogwintujące z łbem walcowym wypukłym z wgłębieniem krzyżowym Phillips (H) zgodn. z DIN 7981 C-H i wkręty samogwintujące z łbem stożkowym soczewkowym z wgłębieniem krzyżowym Phillips (H) zgodn. z DIN 7983 C-H • Stal cynkowana, pasywacja na czarno • Zawartość: <ul style="list-style-type: none"> • ST2,9x19 / ST3,5x16 -x25 / ST4,2x16 -x25 -x32 / ST4,8x19 -x25 -x32 • 440 szt. 	
9 T 29	1	41000.000.029	Skład: <ul style="list-style-type: none"> • Śruby z łbem sześciokątnym zgodn. z ISO 8765, śruby z łbem sześciokątnym zgodn. z ISO 8676 i nakrętki sześciokątne zgodn. z DIN 934 • Metryczny gwint o drobnym zwoju • Stal klasy 8.8-l8l • Zawartość: <ul style="list-style-type: none"> • M8x1x30 -x40 / M10x1x30 -x40 / M10x1,25x30 -x40 • 76 szt. 	
9 T 30	1	41000.000.030	Skład: <ul style="list-style-type: none"> • Śruby z łbem sześciokątnym z gwintem na całej długości zgodn. z ISO 4017 i nakrętki sześciokątne zgodn. z DIN 934 • Stal klasy 8.8-l8l cynkowana • Zawartość: <ul style="list-style-type: none"> • M5x12 -x16 -x20 -x25 / M6x12 -x16 -x20 -x25 -x30 • 320 szt. 	
9 T 32	1	41000.000.032	Skład: <ul style="list-style-type: none"> • Obrobione śruby z łbem sześciokątnym i nakrętki sześciokątne • Stal klasy ≈ 8.8/8 • Zawartość: <ul style="list-style-type: none"> • UNC 1/4 x 5/8 -x 3/4 -x 1.IN. -x 1.1/4 / UNC 5/16 x 1.IN. -x 1.1/2 / UNC 3/8 x 1.IN. -x 1.1/2 / UNC 1/2 x 1.1/4 • 126 szt. 	
9 T 33	1	41000.000.033	Skład: <ul style="list-style-type: none"> • Śruby z łbem sześciokątnym zgodn. z DIN 933 (1954) i nakrętki sześciokątne zgodn. z DIN 934 (1954) • Stal klasy ≈ 8.8/8 • Zawartość: <ul style="list-style-type: none"> • BSW 1/4 x15 -x20 -x25 -x30 / BSW 5/16 x20 -x30 / BSW 3/8 x25 -x35 / BSW 1/2 x30 • 110 szt. 	
9 T 34	1	41000.000.034	Skład: <ul style="list-style-type: none"> • Śruby z łbem sześciokątnym z zgodn. z ISO 4017 i nakrętki sześciokątne zgodn. z DIN 934 • Mosiądz • Zawartość: <ul style="list-style-type: none"> • M5x12 -x16 -x20 -x25 / M6x12 -x16 -x20 -x25 -x30 • 300 szt. 	
9 T 35	1	41000.000.035	Skład: <ul style="list-style-type: none"> • Śruby z łbem walcowym z gniazdem sześciokątnym zgodn. z DIN 912 • Stal klasy 8.8 cynkowana • Zawartość: <ul style="list-style-type: none"> • M6x16 -x20 -x25 -x30 / M8x25 -x30 -x35 / M10x25 -x35 • 95 szt. 	
9 T 36	1	41000.000.036	Skład: <ul style="list-style-type: none"> • Śruby z łbem walcowym z gniazdem sześciokątnym • Stal klasy ≈ 12.9 • Zawartość: <ul style="list-style-type: none"> • UNC 1/4 x 5/8 -x 3/4 -x 1.IN. -x 1.1/4 / UNC 5/16 x 1.IN. -x 1.1/4 -x 1.1/2 / UNC 3/8 x 1.IN. -x 1.1/2 • 98 szt. 	
9 T 37	1	41000.000.037	Skład: <ul style="list-style-type: none"> • Śruby z łbem stożkowym z gniazdem sześciokątnym zgodn. z DIN 7991 • Stal klasy 8.8 cynkowana • Zawartość: <ul style="list-style-type: none"> • M6x20 -x25 -x30 / M8x20 -x25 -x30 -x40 / M10x30 -x40 • 78 szt. 	
9 T 39	1	41000.000.039	Skład: <ul style="list-style-type: none"> • Śruby z łbem sześciokątnym z gwintem na całej długości zgodn. z ISO 4017 i nakrętki sześciokątne zgodn. z DIN 934 • Stal klasy 8.8-l8l cynkowana, pasywacja na żółto • Zawartość: <ul style="list-style-type: none"> • M5x10 -x20 / M6x12 -x30 / M8x20 -x40 / M10x30 -x40 • 190 szt. 	
9 T 40	1	41000.000.040	Skład: <ul style="list-style-type: none"> • Śruby z łbem walcowym z gniazdem sześciokątnym zgodn. z DIN 912 • Stal klasy 12.9 • Zawartość: <ul style="list-style-type: none"> • M6x16 -x20 -x25 -x30 / M8x25 -x30 -x35 / M10x25 -x35 • 95 szt. 	

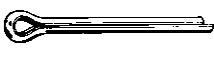
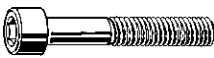





41000 Zestawy w plastikowych kasetach		←	
Wymiary	☒	Kod artykułu	
18 T 41	1	41000.000.041 Skład: • Pierścienie uszczelniające pełne zgodn. z DIN 7603 C • Miedź/FESTAPLAN • Zawartość: • Ø 5x9x1,5 / 6x10x1,5 / 8x12x1,5 / 8x14x1,5 / 10x14x1,5 / 10x16x1,5 / 12x16x2 / 12x18x2 / 14x18x2 / 14x20x2 / 16x20x2 / 16x22x2 / 18x22x2 / 18x24x2 / 20x24x2 / 20x26x2 / 22x27x2 / 22x29x2 • 200 szt.	
9 T 42	1	41000.000.042 Skład: • Pierścienie uszczelniające pełne zgodn. z DIN 7603 C • Miedź/FESTAPLAN • Zawartość: • Ø 24x32x2,5 / 26x32x2,5 / 26x34x2,5 / 30x36x2,5 / 30x38x2,5 / 32x38x2,5 / 35x41x2,5 / 38x44x2,5 / 40x47x2,5 • 65 szt.	
9 T 51	1	41000.000.051 Skład: • Wpusty pryzmatyczne - typ wysoki zgodn. z DIN 6885 A • Stal • Zawartość: • 5x5x20 -x32 -x40 / 6x6x20 -x32 / 8x7x40 -x50 / 10x8x50 -x63 • 90 szt.	
9 T 54	1	41000.000.054 Skład: • Pierścienie uszczelniające • Włókno • Zawartość: • Ø 20x24 / 22x26 / 24x28 / 25x34 / 26x33 / 28x40 / 30x42 / 32x44 / 34x46 • 120 szt.	
18 T 55	1	41000.000.055 Skład: • Nakrętki sześciokątne zgodn. z ≈ DIN 934, śruby z łbem walcowym płaskim z rowkiem zgodn. z ≈ DIN 84 i podkładki okrągłe bez ściegna ≈ DIN 125-1 A • Plastik PA 6.6 (biały) • Zawartość: • M3x6 -x8 -x10 -x12 / M4x8 -x10 -x12 -x16 / M5x10 -x16 -x20 -x25 • 770 szt.	
9 T 56	1	41000.000.056 Skład: • Podkładki okrągłe bez ściegna • Aluminium Sopral AG3 • Zawartość: • M3 / M4 / M5 / M6 / M8 / M10 / M12 / M16 / M20 • 514 szt.	
9 T 57	1	41000.000.057 Skład: • Pierścienie uszczelniające DUBO do śrub z łbem sześciokątnym i nakrętek sześciokątnych • Plastik PA 6 (biały) • Zawartość: • M5 / M6 / M8 / M10 / M12 / M14 / M16 / M18 / M20 • 311 szt.	
9 T 58	1	41000.000.058 Skład: • Podkładki okrągłe bez ściegna zgodn. z ≈ DIN 125-1 A • Plastik PA 6.6 (biały) • Zawartość: • M4 / M5 / M6 / M8 / M10 / M12 / M14 / M16 / M20 • 484 szt.	
9 T 59	1	41000.000.059 Skład: • Śruby z łbem sześciokątnym z gwintem na całej długości zgodn. z ≈ ISO 4017, nakrętki sześciokątne zgodn. z ≈ DIN 934 i wkręty z łbem walcowym płaskim z rowkiem zgodn. z ≈ DIN 84 • Plastik PA 6.6 (biały) • Zawartość: • M5x20 / M6x20 -x40 / M8x30 -x50 / M10x50 • 106 szt.	
18 T 60	1	41000.000.060 Skład: • Części odległościowe • Plastik PA 6.6 (biały) • Zawartość: • Ø 2,5x5x5 / 2,5x5x15 / 3x8x5 / 3x8x15 / 3,5x6x5 / 3,5x6x15 / 4x8x15 / 5x10x5 / 5x10x15 / 6x10x5 / 6x10x15 / 8x12x5 / 8x12x15 / 10x15x5 / 10x15x15 / 10x15x25 / 12x18x5 / 12x18x15 • 191 szt.	
9 T 62	1	41000.000.062 Skład: • Wkręty do płyty wiórowej z łbem stożkowym z wgłębieniem krzyżowym Pozidriv (Z) • Stal cynkowana • Zawartość: • 3x13 -x17 -x20 / 3,5x20 -x25 / 4x20 -x25 -x30 / 5x40 • 380 szt.	
9 T 66	1	41000.000.066 Skład: • Zawlecзки zgodn. z DIN 94 • Stal nierdzewna A2 • Zawartość: • 1x20 / 1,6x20 / 2x32 / 2,5x32 / 3,2x32 -x40 / 4x40 / 5x50 / 6,3x50 • 165 szt.	
9 T 68	1	41000.000.068 Skład: • Śruby z łbem walcowym z gniazdem sześciokątnym zgodn. z DIN 912 • Stal nierdzewna A2-70 • Zawartość: • M6x16 -x20 -x25 -x30 / M8x25 -x30 -x35 / M10x25 -x35 • 85 szt.	

41000		Zestawy w plastikowych kasetach		←
Wymiary	☒	Kod artykułu		
18 T 69	1	41000.000.069	Skład: <ul style="list-style-type: none"> • Wkręty z łbem walcowym płaskim z rowkiem zgodn. z DIN 84, nakrętki sześciokątne zgodn. z DIN 934, podkładki okrągłe bez ścięcia zgodn. z DIN 125-1 A i podkładki sprężyste zgodn. z ≈ DIN 127 B • Stal nierdzewna A2-70 • Zawartość: <ul style="list-style-type: none"> • M1,6x6 / M2x8 / M2,5x10 / M3x6 -x8 -x10 / M4x8 -x10 -x12 / M5x10 -x16 -x20 • 945 szt. 	
9 T 70	1	41000.000.070	Skład: <ul style="list-style-type: none"> • Podkładki sprężyste zgodn. z DIN 127 B • Stal nierdzewna A2 • Zawartość: <ul style="list-style-type: none"> • M4 / M5 / M6 / M8 / M10 / M12 / M14 / M16 / M20 • 527 szt. 	
9 T 71	1	41000.000.071	Skład: <ul style="list-style-type: none"> • Podkładki okrągłe bez ścięcia zgodn. z DIN 125-1 A • Stal nierdzewna A2 • Zawartość: <ul style="list-style-type: none"> • M4 / M5 / M6 / M8 / M10 / M12 / M14 / M16 / M20 • 390 szt. 	
9 T 72	1	41000.000.072	Skład: <ul style="list-style-type: none"> • Wkręty do drewna z łbem kulistym z rowkiem zgodn. z DIN 96 • Stal nierdzewna A2 • Zawartość: <ul style="list-style-type: none"> • 3x12 -x16 / 4x20 -x25 -x30 -x40 / 5x25 -x40 -x50 • 279 szt. 	
9 T 73	1	41000.000.073	Skład: <ul style="list-style-type: none"> • Wkręty do drewna z łbem stożkowym płaskim z rowkiem zgodn. z DIN 97 • Stal nierdzewna A2 • Zawartość: <ul style="list-style-type: none"> • 3x20 -x25 / 4x20 -x25 -x30 -x40 / 5x30 -x40 -x50 • 223 szt. 	
9 T 74	1	41000.000.074	Skład: <ul style="list-style-type: none"> • Wkręty do płyty wiórowej z łbem stożkowym z wgłębieniem krzyżowym Pozidriv (Z) • Stal nierdzewna A2 • Zawartość: <ul style="list-style-type: none"> • 3,5x25 -x30 / 4x20 -x30 -x40 -x50 / 5x50 -x60 -x70 • 220 szt. 	
9 T 75	1	41000.000.075	Skład: <ul style="list-style-type: none"> • Śruby z łbem sześciokątnym z gwintem na całej długości zgodn. z ISO 4017 i nakrętki sześciokątne zgodn. z DIN 934 • Stal nierdzewna A2-70 • Zawartość: <ul style="list-style-type: none"> • M6x16 -x20 -x25 / M8x20 -x25 -x30 / M10x25 -x30 -x40 • 138 szt. 	
9 T 76	1	41000.000.076	Skład: <ul style="list-style-type: none"> • Wkręty z łbem walcowym płaskim z rowkiem zgodn. z DIN 84 i nakrętki sześciokątne zgodn. z DIN 934 • Stal nierdzewna A2-70 • Zawartość: <ul style="list-style-type: none"> • M4x10 -x16 -x20 / M5x10 -x16 -x20 / M6x16 -x20 -x25 • 360 szt. 	
9 T 77	1	41000.000.077	Skład: <ul style="list-style-type: none"> • Wkręty z łbem stożkowym płaskim z rowkiem zgodn. z DIN 963 i nakrętki sześciokątne zgodn. z DIN 934 • Stal nierdzewna A2-70 • Zawartość: <ul style="list-style-type: none"> • M4x10 -x16 -x20 / M5x10 -x16 -x20 / M6x16 -x20 -x25 • 360 szt. 	
9 T 78	1	41000.000.078	Skład: <ul style="list-style-type: none"> • Wkręty samogwintujące z łbem walcowym płaskim z rowkiem zgodn. z DIN 7971 C • Stal nierdzewna A2 • Zawartość: <ul style="list-style-type: none"> • ST2,9x13 / ST3,5x9,5 -x13 -x19 / ST4,2x13 -x19 -x25 / ST4,8x19 -x25 • 265 szt. 	
9 T 79	1	41000.000.079	Skład: <ul style="list-style-type: none"> • Wkręty samogwintujące z łbem stożkowym soczewkowym z rowkiem zgodn. z DIN 7973 C • Stal nierdzewna A2 • Zawartość: <ul style="list-style-type: none"> • ST2,9x13 / ST3,5x9,5 -x13 -x19 / ST4,2x13 -x19 -x25 / ST4,8x19 -x25 • 265 szt. 	
9 T 80	1	41000.000.080	Skład: <ul style="list-style-type: none"> • Nakrętki sześciokątne samozabezpieczające z wkładką plastikową zgodn. z DIN 985 • Stal klasy 5/8 cynkowana • Zawartość: <ul style="list-style-type: none"> • M4 / M5 / M6 / M7 / M8 / M10 / M12 / M14 / M16 • 214 szt. 	
9 T 81	1	41000.000.081	Skład: <ul style="list-style-type: none"> • Nakrętki sześciokątne samozabezpieczające z wkładką plastikową zgodn. z DIN 985 • Stal klasy ≥ 6 cynkowana • Zawartość: <ul style="list-style-type: none"> • M10x1 -x1,25 / M12x1,25 -x1,5UNF 1/4 / UNF 5/16 / UNF 3/8 / UNF 7/16 / UNF 1/2 • 95 szt. 	

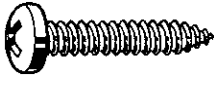
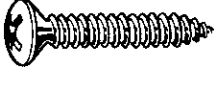
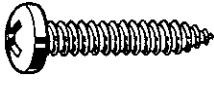
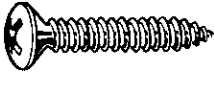
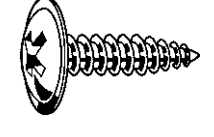
41000 Zestawy w plastikowych kasetach

Wymiary	Kod artykułu		
18 T 85	41000.000.085	Skład: • Pierścienie uszczelniające o przekroju okrągłym (niemetryczne) • Guma - NBR 70° brzeg (czarna) • Zawartość: • Ø 5x1,5 / 6x1,5 / 7x1,5 / 8x1,5 / 8x2 / 10x2 / 12x2 / 11,3x2,4 / 13,3x2,4 / 12x2,5 / 14x2,5 / 15x2,5 / 16x2,5 / 18x3 / 20,2x3 / 22,2x3 / 24,2x3 / 26,2x3 • 179 szt.	
18 T 86	41000.000.086	Skład: • Pierścienie o przekroju okrągłym (niemetryczne) • Guma - NBR 70° Shore (czarna) • Zawartość: • Ø 5,28x1,78 / 6,07x1,78 / 7,66x1,78 / 9,25x1,78 / 10,82x1,78 / 12,42x1,78 / 10,78x2,62 / 12,37x2,62 / 13,95x2,62 / 15,08x2,62 / 17,13x2,62 / 18,72x2,62 / 20,29x2,62 / 21,89x2,62 / 23,47x2,62 / 23,40x3,53 / 24,99x3,53 / 26,58x3,53 • 167 szt.	
9 T 88	41000.000.088	Skład: • Pierścienie uszczelniające • Guma (czarna) • Zawartość: • Ø 4x6,4 / 5,5x8 / 6,4x9,5 / 8x9,5 / 9,5x12,5 / 11x12,5 / 12,5x17,5 / 14,2x17,5 / 16x19 • 218 szt.	
9 T 89	41000.000.089	Skład: • Korki zaślepiające • Guma (czarna) • Zawartość: • Ø 6,4x9,5 / 8x14,2 / 9,5x15,4 / 11,2x17,7 / 12,5x18,7 / 15,5x22 / 19x25,5 / 20x25,5 / 22,5x28,4 • 178 szt.	
9 T 91	41000.000.091	Skład: • Nity z łbem kulistym zgodn. z DIN 660 i nity z łbem stożkowym płaskim zgodn. z DIN 661 • Miedź • Zawartość: • 2x6 -x10 / 3x6 -x10 / 4x10 -x16 / 5x12 -x20 / 6x20 • 620 szt.	
9 T 93	41000.000.093	Skład: • Nity z łbem kulistym zgodn. z DIN 660 i nity z łbem stożkowym płaskim zgodn. z DIN 661 • Aluminium • Zawartość: • 2x6 -x10 / 3x6 -x10 / 4x10 -x16 / 5x12 -x20 / 6x20 • 620 szt.	
18 T 101	41000.000.101	Skład: • Pierścienie uszczelniające • Włókno • Zawartość: • Ø 5x8 / 6x9 / 6,5x10 / 7x10 / 8x12 / 8,5x14 / 9x14 / 9,5x14 / 10x14 / 11x17 / 12x16 / 12,5x18 / 14x18 / 15x19 / 16x21 / 17x22 / 18x24 / 19x23 • 400 szt.	
18 T 102	41000.000.102	Skład: • Pierścienie osadkowe sprężynujące zewnętrzne zgodn. z DIN 471 • Stal • Zawartość: • Ø 10 / 11 / 12 / 13 / 14 / 15 / 16 / 17 / 18 / 19 / 20 / 21 / 22 / 23 / 24 / 25 / 26 / 27 • 260 szt.	
18 T 103	41000.000.103	Skład: • Pierścienie osadkowe sprężynujące wewnętrzne zgodn. z DIN 472 • Stal • Zawartość: • Ø 10 / 11 / 12 / 13 / 14 / 15 / 16 / 17 / 18 / 19 / 20 / 21 / 22 / 23 / 24 / 25 / 26 / 27 • 260 szt.	
9 T 104	41000.000.104	Skład: • Pierścienie osadkowe sprężynujące zewnętrzne zgodn. z DIN 471 • Stal • Zawartość: • Ø 29 / 30 / 31 / 33 / 35 / 36 / 38 / 40 / 42 • 115 szt.	
9 T 105	41000.000.105	Skład: • Pierścienie osadkowe sprężynujące wewnętrzne zgodn. z DIN 472 • Stal • Zawartość: • Ø 28 / 29 / 30 / 32 / 35 / 36 / 37 / 40 / 42 • 115 szt.	
18 T 107	41000.000.107	Skład: • Wkręty samogwintujące z łbem walcowym płaskim z rowkiem zgodn. z DIN 7971 C • Stal niklowana • Zawartość: • ST2,9x13 / ST3,5x13 -x16 -x19 -x25 / ST4,2x13 -16 -x19 -x25 / ST4,8x16 -x19 -x25 -x32 / ST5,5x19 -25 -x32 / ST6,3x25 -x38 • 500 szt.	
18 T 109	41000.000.109	Skład: • Wkręty samogwintujące z łbem stożkowym soczewkowym z wgłębieniem krzyżowym Phillips (H) zgodn. z DIN 7983 C-H • Stal niklowana • Zawartość: • ST2,9x13 / ST3,5x13 -x16 -x19 -x25 / ST4,2x13 -x16 -x19 -x25 / ST4,8x16 -x19 -x25 -x32 / ST5,5x19 -x25 -x32 / ST6,3x25 -x38 • 500 szt.	

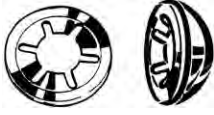
41000		Zestawy w plastikowych kasetach		←
Wymiary	☒	Kod artykułu		
18 T 110	1	41000.000.110	Skład: <ul style="list-style-type: none"> • Wkręty dociskowe bez łba z gniazdem sześciokątnym i końcem wgłębnym zgodn. z DIN 916 (z wyj. rozmiarów UNC) • Stal klasy 45H • Zawartość: <ul style="list-style-type: none"> • M4x5 -x10 / M5x10 -x16 / M6x8 -x12 -x20 / M8x12 -x20 / UNC 3/16 x 1/4 -x 3/8 / UNC 1/4 x 3/8 -x 1/2 -x 5/8 -x 3/4 / UNC 5/16 x 1/2 -x 5/8 -x 3/4 • 229 szt. 	
18 T 111	1	41000.000.111	Skład: <ul style="list-style-type: none"> • Wpusty czólenkowe zgodn. z DIN 6888 • Stal • Zawartość: <ul style="list-style-type: none"> • 2x3,7 / 2,5x3,7 / 3x3,7 -x5 -x6,5 / 4x5 -x6,5 -x7,5 -x9 / 5x6,5 -x9 / 6x9 -x11 -x13 -x15 / 8x11 -x13 / 10x13 • 220 szt. 	
18 T 112	1	41000.000.112	Skład: <ul style="list-style-type: none"> • Śruby z łbem walcowym płaskim z rowkiem zgodn. z DIN 84 i nakrętki sześciokątne zgodn. z DIN 934 • Stal klasy 4.8-18I cynkowana • Zawartość: <ul style="list-style-type: none"> • M3x4 -x6 -x8 -x10 -x12 -x16 -x20 -x25 / M4x6 -x8 -x10 -x12 -x16 -x20 -x25 -x30 • 1020 szt. 	
18 T 113	1	41000.000.113	Skład: <ul style="list-style-type: none"> • PRYM Kolki sprężyste zwijane zwykle zgodn. z ISO 8750 • Stal • Zawartość: <ul style="list-style-type: none"> • 1,5x8 -x12 / 2x10 -x16 / 3x12 -x14 -x16 -x20 -x24 -x30 / 4x16 -x20 -x24 -x30 -x40 / 5x20 -x40 / 6x40 • 415 szt. 	
18 T 114	1	41000.000.114	Skład: <ul style="list-style-type: none"> • Kolki stożkowe toczone zgodn. z DIN 1 B • Stal • Zawartość: <ul style="list-style-type: none"> • 2x10 -x12 -x14 -x20 -x30 / 3x14 -x20 -x24 -x30 -x40 / 4x20 -x30 -x40 / 5x20 -x30 -x40 / 6x30 -x40 • 365 szt. 	
18 T 115	1	41000.000.115	Skład: <ul style="list-style-type: none"> • Kolki walcowe - utwardzane cieplnie i szlifowane zgodn. z DIN 6325 • Stal twardość 60 ± 2 HRC • Zawartość: <ul style="list-style-type: none"> • 2x10 -x12 -x14 -x20 -x28 / 3x14 -x20 -x24 -x32 -x40 / 4x20 -x32 -x40 / 5x20 -x32 -x40 / 6x28 -x40 • 187 szt. 	
18 T 116	1	41000.000.116	Skład: <ul style="list-style-type: none"> • Kolki sprężyste rozcięte wzmocnione zgodn. z ISO 8752 • Stal • Zawartość: <ul style="list-style-type: none"> • 1,5x8 -x12 / 2x10 -x16 / 2,5x30 / 3x14 -x16 -x20 -x24 -x30 / 4x16 -x20 -x24 -x30 -x40 / 5x20 -x40 / 6x40 • 414 szt. 	
9 T 117	1	41000.000.117	Skład: <ul style="list-style-type: none"> • Kolki sprężyste rozcięte wzmocnione zgodn. z ISO 8752 • Stal • Zawartość: <ul style="list-style-type: none"> • 4x50 / 5x50 -x60 / 6x50 -x60 -x70 / 8x50 -x60 -x70 • 136 szt. 	
9 T 121	1	41000.000.121	Skład: <ul style="list-style-type: none"> • Wkręty do drewna z łbem stożkowym płaskim z rowkiem zgodn. z DIN 97 • Mosiądz • Zawartość: <ul style="list-style-type: none"> • 3x20 -x25 / 4x20 -x25 -x30 -x40 / 5x30 -x40 -x50 • 223 szt. 	
9 T 122	1	41000.000.122	Skład: <ul style="list-style-type: none"> • Wkręty do drewna z łbem kulistym z rowkiem zgodn. z DIN 96 • Mosiądz • Zawartość: <ul style="list-style-type: none"> • 3x20 / 3,5x20 -x25 -x30 / 4x20 -x25 -x30 / 5x30 -x40 • 235 szt. 	
9 T 125	1	41000.000.125	Skład: <ul style="list-style-type: none"> • Wkręty do drewna z łbem stożkowym płaskim z rowkiem zgodn. z DIN 97 • Stal cynkowana • Zawartość: <ul style="list-style-type: none"> • 3x20 / 3,5x20 -x25 -x30 / 4x20 -x25 -x30 / 5x40 -x50 • 425 szt. 	
9 T 126	1	41000.000.126	Skład: <ul style="list-style-type: none"> • Wkręty do drewna z łbem kulistym z rowkiem zgodn. z DIN 96 • Stal cynkowana • Zawartość: <ul style="list-style-type: none"> • 3x20 / 3,5x20 -x25 -x30 / 4x20 -x25 -x30 / 5x30 -x40 • 425 szt. 	
18 T 131	1	41000.000.131	Skład: <ul style="list-style-type: none"> • Wkręty samogwintujące z łbem walcowym płaskim z rowkiem zgodn. z DIN 7971 C • Stal cynkowana • Zawartość: <ul style="list-style-type: none"> • ST2,9x13 / ST3,5x13 -x16 -x19 -x25 / ST4,2x13 -x16 -x19 -x25 / ST4,8x16 -x19 -x25 -x32 / ST5,5x19 -x25 -x32 / ST6,3x25 -x38 • 500 szt. 	

41000		Zestawy w plastikowych kasetach		
Wymiary	☒	Kod artykułu		
18 T 133	1	41000.000.133	Skład: <ul style="list-style-type: none"> • Wkręty samogwintujące z łbem stożkowym soczewkowym z rowkiem zgodn. z DIN 7973 C • Stal cynkowana • Zawartość: ST2,9x13 / ST3,5x13 -x16 -x19 -x25 / ST4,2x13 -x16 -x19 -x25 / ST4,8x16 -x19 -x25 -x32 / ST5,5x19 -x25 -x32 / ST6,3x25 -x38 500 szt. 	
18 T 137	1	41000.000.137	Skład: <ul style="list-style-type: none"> • Wkręty samogwintujące z łbem walcowym wypukłym z wgłębieniem krzyżowym Phillips (H) zgodn. z DIN 7981 C-H • Stal cynkowana • Zawartość: ST2,9x13 / ST3,5x13 -x16 -x19 -x25 / ST4,2x13 -x16 -x19 -x25 / ST4,8x16 -x19 -x25 -x32 / ST5,5x19 -x25 -x32 / ST6,3x25 -x38 500 szt. 	
18 T 139	1	41000.000.139	Skład: <ul style="list-style-type: none"> • Wkręty samogwintujące z łbem stożkowym soczewkowym z wgłębieniem krzyżowym Phillips (H) zgodn. z DIN 7983 C-H • Stal cynkowana • Zawartość: ST2,9x13 / ST3,5x13 -x16 -x19 -x25 / ST4,2x13 -x16 -x19 -x25 / ST4,8x16 -x19 -x25 -x32 / ST5,5x19 -x25 -x32 / ST6,3x25 -x38 500 szt. 	
9 T 140	1	41000.000.140	Skład: <ul style="list-style-type: none"> • Wkręty samogwintujące z łbem walcowym wypukłym z wgłębieniem krzyżowym Phillips (H) zgodn. z DIN 7981 C-H • Stal cynkowana, pasywacja na czarno • Zawartość: ST2,9x19 / ST3,5x16 -x25 / ST4,2x16 -x25 -x32 / ST4,8x19 -x25 -x32 440 szt. 	
9 T 141	1	41000.000.141	Skład: <ul style="list-style-type: none"> • Wkręty samogwintujące z łbem stożkowym soczewkowym z wgłębieniem krzyżowym Phillips (H) zgodn. z DIN 7983 C-H • Stal cynkowana, pasywacja na czarno • Zawartość: ST2,9x19 / ST3,5x16 -x25 / ST4,2x16 -x25 -x32 / ST4,8x19 -x25 -x32 440 szt. 	
9 T 143	1	41000.000.143	Skład: <ul style="list-style-type: none"> • Wkręty samogwintujące z łbem grzybkowym z wgłębieniem krzyżowym Phillips (H) z kołnierzem • Stal cynkowana, pasywacja na czarno • Zawartość: ST3,5x16 -x19 / ST4,2x16 -x19 -x22 / ST4,8x16 -x19 -x25 360 szt. 	
9 T 151	1	41000.000.151	Skład: <ul style="list-style-type: none"> • Pierścienie uszczelniające • Włókno • Zawartość: Ø 3x5 / 4x6,5 / 4,5x8 / 5x8 / 5,5x9 / 6x9 / 6,5x10 / 7x10 / 8x12 750 szt. 	
9 T 152	1	41000.000.152	Skład: <ul style="list-style-type: none"> • Wpusty czótenkowe zgodn. z DIN 6888 • Stal • Zawartość: 2x2,6 -x3,7 -x5 / 2,5x3,7 / 3x3,7 -x5 -x6,5 -x7,5 / 4x5 235 szt. 	
9 T 156	1	41000.000.156	Skład: <ul style="list-style-type: none"> • Pierścienie osadczе sprężynujące zewnętrzne zgodn. z DIN 471 i pierścienie osadczе sprężynujące wewnętrzne zgodn. z DIN 472 • Stal • Zawartość: Ø 8 / 9 / 10 / 11 / 12 / 13 / 14 / 15 / 16 326 szt. 	
9 T 157	1	41000.000.157	Skład: <ul style="list-style-type: none"> • Pierścienie osadczе sprężynujące zgodn. z DIN 6799 • Stal • Zawartość: Ø 1,5 / 1,9 / 2,3 / 3,2 / 4 / 5 / 6 / 7 / 8 550 szt. 	
9 T 159	1	41000.000.159	Skład: <ul style="list-style-type: none"> • Podkładki ustalające do wałków STARLOCK • Stal sprężynowa (bez zaślepki) i stal sprężynowa (z zaślepką ze stali nierdzewnej) • Zawartość: Ø 3 / 4 / 5 / 6 / 8 / 10 / 12 / 16 / 20 289 szt. 	
9 T 175	1	41000.000.175	Skład: <ul style="list-style-type: none"> • Smarowniczki stożkowe zgodn. z ≈ DIN 71412 • Stal cynkowana • Zawartość: R 1/8 -45° -90° -180° / R 1/4 -45° -90° -180° SAE (UNF) 1/4 -180° / UNF 5/16 -180° / UNF 3/8 -180° 97 szt. 	
18 T 176	1	41000.000.176	Skład: <ul style="list-style-type: none"> • Smarowniczki stożkowe zgodn. z ≈ DIN 71412 i smarowniczki wkręcane • Stal cynkowana • Zawartość: M6x1-45° -90° -180° M8x1-45° -90° -180° / M8x1,25-45° -90° -180° M10x1-45° -90° -180° / M10x1,5-90° -180° Smarowniczek wkręcany: 6-45° -180° / 8-90° -180° 123 szt. 	

41000		Zestawy w plastikowych kasetach		←
Wymiary	☒	Kod artykułu		
9 T 177	1	41000.000.177	Skład: <ul style="list-style-type: none"> • Smarowniczeki stożkowe zgodn. z ≈ DIN 71412 • Stal cynkowana • Zawartość: <ul style="list-style-type: none"> • M6x1-45° -90° -180° • M8x1-180° / M8x1,25-45° -90° -180° • M10x1-180° / M10x1,5-180° • 120 szt. 	
9 T 201	1	41000.000.201	Skład: <ul style="list-style-type: none"> • Podkładki okrągłe bez ścieżcia zgodn. z DIN 125-1 A i podkładki sprężyste zgodn. z DIN 127 B • Stal cynkowana • Zawartość: <ul style="list-style-type: none"> • M5 / M6 / M8 / M10 / M11 • 675 szt. 	
9 T 203	1	41000.000.203	Skład: <ul style="list-style-type: none"> • Podkładki okrągłe bez ścieżcia zgodn. z DIN 125-1 A i podkładki sprężyste zgodn. z DIN 127 B • Stal cynkowana, pasywacja na żółto • Zawartość: <ul style="list-style-type: none"> • M5 / M6 / M8 / M10 / M12 • 630 szt. 	
18 T 209	1	41000.000.209	Skład: <ul style="list-style-type: none"> • Wkręty samogwintujące z łbem walcowym płaskim z wgłębieniem krzyżowym Phillips (H) zgodn. z DIN 7981 C-H • Stal niklowana • Zawartość: <ul style="list-style-type: none"> • ST2,9x13 / ST3,5x13 -x16 -x19 -x25 / ST4,2x13 -x16 -x19 -x25 / ST4,8x16 -x19 -x25 x32 / ST5,5x19-x25 -x32 / ST6,3x25-x38 • 500 szt. 	
18 T 210	1	41000.000.210	Skład: <ul style="list-style-type: none"> • Wkręty dociskowe bez łba z gniazdem sześciokątnym i końcem wgłębionym zgodn. z DIN 916 • Stal klasy 45H • Zawartość: <ul style="list-style-type: none"> • M4x5 -x8 -x10 / M5x8 -x10 -x12 -x16 / M6x8 -x10 -x12 -x16 -x20 / M8x12 -x16 -x20 / M10x16 -x20 -x25 • 245 szt. 	
9 T 212	1	41000.000.212	Skład: <ul style="list-style-type: none"> • Pierścienie regulacyjne, grubość 0,1 mm • Stal • Zawartość: <ul style="list-style-type: none"> • Ø 24x36 / 26x38 / 28x40 / 30x42 / 32x44 / 34x46 / 36x48 / 38x50 / 40x50 • 160 szt. 	
9 T 214	1	41000.000.214	Skład: <ul style="list-style-type: none"> • Kołki stożkowe toczone zgodn. z DIN 1 B • Stal • Zawartość: <ul style="list-style-type: none"> • 3x50 / 4x50 -x60 / 5x50 -x60 / 6x50 -x60 -x70 / 6,5x60 • 150 szt. 	
9 T 219	1	41000.000.219	Skład: <ul style="list-style-type: none"> • Wkręty z łbem walcowym soczewkowym z wgłębieniem krzyżowym Phillips (H) zgodn. z DIN 7985 H • Stal klasy 4.8 cynkowana, pasywacja na czarno • Zawartość: <ul style="list-style-type: none"> • M3x6 -x10 -x16 -x20 -x30 / M4x10 -x20 -x30 -x50 • 525 szt. 	
9 T 220	1	41000.000.220	Skład: <ul style="list-style-type: none"> • Wkręty z łbem stożkowym płaskim z wgłębieniem krzyżowym Phillips (H) zgodn. z DIN 965H • Stal klasy 4.8 cynkowana, pasywacja na czarno • Zawartość: <ul style="list-style-type: none"> • M3x6 -x10 -x16 -x20 -x30 / M4x10 -x20 -x30 -x50 • 525 szt. 	
9 T 230	1	41000.000.230	Skład: <ul style="list-style-type: none"> • Wkręty z łbem stożkowym płaskim z wgłębieniem krzyżowym Phillips (H) zgodn. z DIN 965 H • Stal klasy 8.8-18l cynkowana • Zawartość: <ul style="list-style-type: none"> • M8x20 -x25 -x30 -x35 / M10x25 -x30 -x35 • 86 szt. 	
9 T 231	1	41000.000.231	Skład: <ul style="list-style-type: none"> • Obrobione śruby z łbem sześciokątnym i nakrętki sześciokątne • Stal, klasa 5, cynkowana • Zawartość: <ul style="list-style-type: none"> • UNF 1/4 x 5/8 -x 3/4 -x 1.IN. -x 1.1/4 / UNF 5/16 x 1.IN. -x 1.1/2 / UNF 3/8 x 1.IN. -x 1.1/2 / UNF 1/2 x 1.1/4 • 126 szt. 	
9 T 240	1	41000.000.240	Skład: <ul style="list-style-type: none"> • Sprężyny śrubowe walcowe naciskowe zgodn. z DIN 2095 • Stal sprężynowa cynkowana • Zawartość: <ul style="list-style-type: none"> • 0,5x6,5x30 / 0,8x7,7x35 -x50 / 1x8x30 / 1x10x60 / 1,5x10x50 / 1,5x12x40 / 1,5x14x60 / 2x14x50 • 105 szt. 	
9 T 245	1	41000.000.245	Skład: <ul style="list-style-type: none"> • Sprężyny śrubowe naciągowe zgodn. z DIN 2097 • Stal sprężynowa cynkowana • Zawartość: <ul style="list-style-type: none"> • 0,5x4,5x20 / 0,5x6,5x20 -x30 / 0,8x6,7x35 / 0,8x7,7x40 -x50 / 1x10x40 -x60 / 1,5x10x50 • 166 szt. 	

41000		Zestawy w plastikowych kasetach		
Wymiary	☒	Kod artykułu		
18 T 250	1	41000.000.250	Skład: <ul style="list-style-type: none"> Sprężyny śrubowe walcowe naciskowe zgodn. z DIN 2095 i sprężyny śrubowe naciągowe zgodn. z DIN 2097 Stal sprężynowa cynkowana Zawartość: <ul style="list-style-type: none"> 0,5x3,5x15 -x20 / 0,5x4,5x12 / 0,5x6,5x20 -x25 -x35 / 0,8x5,7x25 / 0,8x6,7x25 -x30 / 0,8x7,7x30 / 1x6x25 -x30 / 1x8x25 -x35 / 1x10x25 -x35 / 1x10x40 -x60 / 1,5x10x35 251 szt. 	
9 T 300	1	41000.000.300	Skład: <ul style="list-style-type: none"> Izolowane wstępnie końcówki i złącza Stal/plastik Zawartość: <ul style="list-style-type: none"> Przewód 0,5 - 1,5 mm <ul style="list-style-type: none"> typ 545 / 547 / 548 Przewód 1,5 - 2,5 mm <ul style="list-style-type: none"> typ 546 / 550 / 549 Przewód 2,5 - 6,0 mm <ul style="list-style-type: none"> typ 563 (M8) / 554 (M10) Złącze typ C-560 niebieskie 149 szt. 	
18 T 305	1	41000.000.305	Skład: <ul style="list-style-type: none"> Izolowane wstępnie końcówki Stal/plastik Zawartość: <ul style="list-style-type: none"> Przewód 0,5 - 1,5 mm <ul style="list-style-type: none"> typ 599 / 741 / 541 / 540 / 1541 / 561 / 556 (M3) / 535 (M4) / 557 (M5) Przewód 1,5 - 2,5 mm <ul style="list-style-type: none"> typ 742 / 542 / 740 / 1542 / 562 / 536 (M4) / 537 (M5) / 560 (M6) Przewód 2,5 - 6,0 mm <ul style="list-style-type: none"> typ 539 (M6) 204 szt. 	
18 T 320	1	41000.000.320	Skład: <ul style="list-style-type: none"> Bezpieczniki samochodowe Stal/plastik Zawartość: <ul style="list-style-type: none"> 7,5A / 10A / 15A / 20A / 25A / 30A 2A (5x20 mm) / 2A (6,35x25 mm) / 5A / 10A / 15A / 20A / 25A 5A / 8A / 16A / 25A / 40A 152 szt. 	
9 T 321	1	41000.000.321	Skład: <ul style="list-style-type: none"> NORD-LOCK podkładki klejone odporne na drgania, 2 części Stal Deltaprotekt Zawartość: <ul style="list-style-type: none"> M4 / M5 / M6 / M8 / M10 / M12 / M14 / M16 180 (x2) szt. 	

Zestawy MaxxFast

Całkowicie nowy zakres zestawów w kasetach MaxxFast, najpopularniejsze wkręty do drewna, kołki nylonowe oraz opaski do węży w wygodnych i solidnych metalowych kasetach. Zestawy MaxxFast są odpowiednie do napraw i konserwacji w zakładzie pracy, na placu budowy czy w warsztacie!

Oferta składa się z następujących kartonów:

- 6 kartonów rewolucyjnych wkrętów do drewna różnego rodzaju MaxxFast
- 1 karton kołków nylonowych MaxxFast
- 2 kartony kołków nylonowych z dopasowanymi wkrętami do płyt wiórowych MaxxFast
- 1 karton opasek zaciskowych do węży MaxxFast



Zestawy w kasetach stalowych



Grupy katalogowe

	Kod	Strona
S-Case	41010	11-14
MaxxFast	30950	11-23









41010 Zestawy w kasetach stalowych Y94A



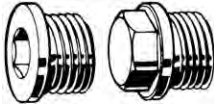
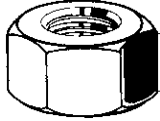

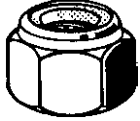

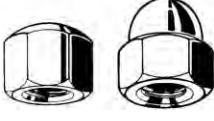
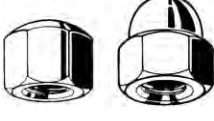

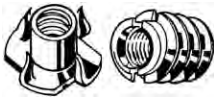

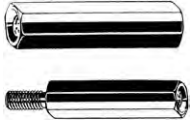
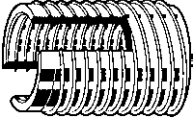
Wymiary	✉	Kod artykułu		
S 502	1	41010.000.502	<p>Skład:</p> <ul style="list-style-type: none"> • Śruby z łbem sześciokątnym zgodn. z ISO 4014, śruby z łbem sześciokątnym zgodn. z ISO 4017 i nakrętki sześciokątne zgodn. z DIN 934 • Stal klasy 8.8-l8l cynkowana • Zawartość: • M5x10 -x16 -x20 -x30 -x40 / M6x12 -x16 -x20 -x25 -x30 -x40 -x50 / M8x20 -x25 -x30 -x40 -x50 -x60 • 758 szt. 	
S 504	1	41010.000.504	<p>Skład:</p> <ul style="list-style-type: none"> • Śruby z łbem sześciokątnym zgodn. z ISO 4014, śruby z łbem sześciokątnym zgodn. z ISO 4017 i nakrętki sześciokątne zgodn. z DIN 934 • Stal klasy 8.8-l8l cynkowana • Zawartość: • M10x20 -x25 -x30 -x40 -x50 -x60 / M12x30 -x40 -x50 / M14x50 -x60 / M16x40 -x50 -x60 • 157 szt. 	
S 506	1	41010.000.506	<p>Skład:</p> <ul style="list-style-type: none"> • Śruby z łbem sześciokątnym zgodn. z ISO 4017 i nakrętki sześciokątne zgodn. z DIN 934 • Stal klasy 8.8-l8l cynkowana • Zawartość: • M5x10 -x16 -x20 / M6x16 -x20 -x25 / M8x20 -x25 -x30 / M10x30 -x40 / M12x30 -x40 • 950 szt. 	
S 508	1	41010.000.508	<p>Skład:</p> <ul style="list-style-type: none"> • Śruby z łbem sześciokątnym zgodn. z ISO 4017 • Stal klasy 8.8 cynkowana, pasywacja na żółto • Zawartość: • M5x16 -x25 / M6x10 -x16 -x20 -x25 / M8x20 -x25 -x30 / M10x25 -x30 -x356 • 10 szt. 	
S 510	1	41010.000.510	<p>Skład:</p> <ul style="list-style-type: none"> • Śruby z łbem sześciokątnym zgodn. z ISO 8765, śruby z łbem sześciokątnym zgodn. z ISO 8676 i nakrętki sześciokątne zgodn. z DIN 934. Gwint metryczny drobnozwojny • Stal klasy 8.8-l8l • Zawartość: • M10x1,25x20 -x25 -x30 -x40 -x50 / M12x1,5x30 -x40 -x45 -x50 / M14x1,5x30 -x40 -x50 -x60 / M16x1,5x30 -x40 -x50 -x60 • 196 szt. 	
S 512	1	41010.000.512	<p>Skład:</p> <ul style="list-style-type: none"> • Śruby z łbem sześciokątnym zgodn. z ISO 4017 i nakrętki sześciokątne zgodn. z DIN 934 • Stal nierdzewna A2-70 • Zawartość: • M5x16 -x20 / M6x16 -x20 -x25 / M8x20 -x25 -x30 / M10x20 -x30 -x40 / M12x30 -x40 • 434 szt. 	
S 514	1	41010.000.514	<p>Skład:</p> <ul style="list-style-type: none"> • Śruby z łbem sześciokątnym zgodn. z ISO 4014, nakrętki sześciokątne zgodn. z DIN 934 i podkładki sprężyste zgodn. z DIN 127 B • Stal nierdzewna A2-70 • Zawartość: • M6x30 -x35 -x40 -x50 -x60 / M8x30 -x35 -x40 -x50 -x60 / M10x40 -x50 -x60 / M12x50 • 552 szt. 	
S 518	1	41010.000.518	<p>Skład:</p> <ul style="list-style-type: none"> • Śruby z łbem sześciokątnym zgodn. z ≈ ISO 4017 i nakrętki sześciokątne zgodn. z ≈ DIN 934 • Plastik PA 6.6 (biały) • Zawartość: • M5x10 -x20 / M6x10 -x20 -x25 -x30 -x40 / M8x16 -x20 -x25 -x30 -x40 -x50 • 987 szt. 	

41010 Zestawy w kasetach stalowych

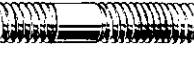
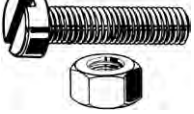
Wymiary	☒	Kod artykułu		
S 520	1	41010.000.520	Skład: • Obrobione śruby z łbem sześciokątnym i nakrętki sześciokątne • Stal, klasa 5, cynkowana • Zawartość: • UNF 1/4 x 5/8 -x 3/4 -x 1.IN. -x 1.1/4 -x 1.1/2 -x 2.IN. / UNF 5/16 x 3/4 -x 1.IN. -x 1.1/4 -x 1.1/2 -x 2.IN. / UNF 3/8 x 3/4 -x 1.IN. -x 1.1/4 -x 1.1/2 -x 2.IN. -x 2.1/2 / UNF 7/16 x 1.1/2 • 600 szt.	
S 522	1	41010.000.522	Skład: • Obrobione śruby z łbem sześciokątnym i nakrętki sześciokątne • Stal, klasa 5, cynkowana • Zawartość: • UNF 7/16 x 1.IN. -x 1.1/4 -x 1.1/2 -x 1.3/4 -x 2.IN. / UNF 1/2 x 1.IN. -x 1.1/4 -x 1.1/2 -x 2.IN. / UNF 9/16 x 1.3/4 -x 2.IN. / UNF 5/8 x 1.1/2 -x 2.IN. -x 2.1/2 • 148 szt.	
S 524	1	41010.000.524	Skład: • Obrobione śruby z łbem sześciokątnym i nakrętki sześciokątne • Stal, klasa 5, cynkowana • Zawartość: • UNC 1/4 x 1/2 -x 5/8 -x 3/4 -x 1.IN. / UNC 5/16 x 3/4 -x 1.IN. -x 1.1/4 -x 1.1/2 / UNC 3/8 x 3/4 -x 1.IN. -x 1.1/4 -x 1.1/2 / UNC 1/2 x 1.1/4 -x 1.1/2 • 670 szt.	
S 526	1	41010.000.526	Skład: • Obrobione śruby z łbem sześciokątnym i nakrętki sześciokątne • Stal nierdzewna A4 • Zawartość: • UNC 1/4 x 3/4 / UNC 5/16 x 3/4 -x 1.IN. / UNC 3/8 x 3/4 -x1.IN. / UNC 1/2 x 1.IN. • 395 szt.	
S 528	1	41010.000.528	Skład: • Śruby z łbem grzybkowym z podsadzeniem zgodn. z DIN 603 i nakrętki sześciokątne zgodn. z DIN 555 • Stal klasy 4.6-8 cynkowana • Zawartość: • M5x16 -x20 -x25 -x30 / M6x25 -x30 -x35 -x40 / M8x25 -x40 -x50 -x60 • 517 szt.	
S 530	1	41010.000.530	Skład: • Wkręty do drewna z łbem sześciokątnym zgodn. z DIN 571 • Stal cynkowana • Zawartość: • 6x30 -x40 -x50 -x60 / 8x30 -x40 -x50 -x60 -x70 -x80 / 10x50 -x60 mm • 357 szt.	
S 532	1	41010.000.532	Skład: • Wkręty do drewna z łbem sześciokątnym zgodn. z DIN 571 • Stal nierdzewna A2 • Zawartość: • 6x30 -x40 -x50 -x60 -x70 / 8x40 -x50 -x60 -x70 -x80 / 10x50 -x70 • 323 szt.	
S 534	1	41010.000.534	Skład: • Śruby z łbem walcowym z gniazdem sześciokątnym zgodn. z DIN 912 • Stal klasy 8.8 cynkowana • Zawartość: • M4x10 -x16 -x20 / M5x10 -x16 -x20 -x25 -x30 / M6x10 -x16 -x20 -x25 -x30 -x40 / M8x20 -x25 -x30 -x40 • 885 szt.	
S 536	1	41010.000.536	Skład: • Śruby z łbem walcowym z gniazdem sześciokątnym zgodn. z DIN 912 • Stal nierdzewna A2-70 • Zawartość: • M4x10 -x12 -x16 / M5x10 -x12 -x16 -x20 / M6x10 -x12 -x16 -x20 -x25 -x30 / M8x16 -x20 -x25 -x30 -x35 • 355 szt.	
S 538	1	41010.000.538	Skład: • Śruby z łbem stożkowym płaskim z gniazdem sześciokątnym zgodn. z DIN 7991 • Stal klasy 8.8 cynkowana • Zawartość: • M3x8 -x16 / M4x10 -x12 -x16 / M5x10 -x16 / M6x10 -x16 -x20 -x25 / M8x20 -x25 -x30 / M10x20 -x25 -x30 -x40 • 1147 szt.	
S 540	1	41010.000.540	Skład: • Śruby z łbem zaokrąglonym z gniazdem sześciokątnym zgodn. z ≈ ISO 7380 • Stal klasy 10.9 cynkowana • Zawartość: • M4x6 -x10 / M5x12 -x16 -x20 / M6x10 -x12 -x16 -x20 -x25 / M8x16 -x20 -x25 / M10x20 -x25 -x30 / M12x25 -x30 • 582 szt.	
S 542	1	41010.000.542	Skład: • Wkręty dociskowe bez łba z gniazdem sześciokątnym i końcem stożkowym płaskim zgodn. z DIN 913, wkręty dociskowe bez łba z gniazdem sześciokątnym i końcem stożkowym zgodn. z DIN 914 i wkręty dociskowe bez łba z gniazdem sześciokątnym i czopem walcowym zgodn. z DIN 915 • Stal klasy 45H • Zawartość: • M4x5 -x8 -x10 / M5x6 -x10 -x20 / M6x8 -x10 -x12 -x16 -x20 / M8x10 -x16 • 1950 szt.	





41010 Zestawy w kasetach stalowych		←	
Wymiary	☒	Kod artykułu	
S 544	1	41010.000.544 Skład: <ul style="list-style-type: none"> • Wkręty dociskowe bez łba z gniazdem sześciokątnym i końcem wglębnym zgodn. z DIN 916S • Stal klasy 45H cynkowana • Zawartość: <ul style="list-style-type: none"> • M4x4 -x6 -x8 -x10 / M5x6 -x8 -x10 / M6x8 -x10 -x16 -x20 / M8x10 -x12 -x16 -x20 / M10x16 -x20 -x25 • 1105 szt. 	
S 546	1	41010.000.546 Skład: <ul style="list-style-type: none"> • Wkręty dociskowe bez łba z gniazdem sześciokątnym i końcem wglębnym zgodn. z DIN 916 • Stal nierdzewna A2-70 • Zawartość: <ul style="list-style-type: none"> • M6x6 -x8 -x10 -x16 / M8x16 -x20 -x25 -x30 / M10x10 -x16 -x20 -x30 • 585 szt. 	
S 548	1	41010.000.548 Skład: <ul style="list-style-type: none"> • Korki gwintowane z kołnierzem z gniazdem sześciokątnym zgodn. z DIN 908 i korki gwintowane z łbem sześciokątnym z kołnierzem zgodn. z DIN 910. • Metryczny drobnozwojny gwint cylindryczny • Stal • Zawartość: <ul style="list-style-type: none"> • M10x1 / M12x1,5 / M14x1,5 / M16x1,5 / M18x1,5 / M20x1,5 / M22x1,5 / M24x1,5 / M30x1,5 • 126 szt. 	
S 550	1	41010.000.550 Skład: <ul style="list-style-type: none"> • Nakrętki sześciokątne zgodn. z DIN 934 • Stal klasy I81 cynkowana • Zawartość: <ul style="list-style-type: none"> • M3 / M4 / M5 / M6 / M8 / M10 / M12 / M16 • 2200 szt. 	
S 552	1	41010.000.552 Skład: <ul style="list-style-type: none"> • Nakrętki sześciokątne zgodn. z ISO 4032 i podkładki okrągłe bez ściegła zgodn. z DIN 125-1A • Stal klasy 8 cynkowana, pasywacja na żółto • Zawartość: <ul style="list-style-type: none"> • M4 / M5 / M6 / M8 / M10 / M12 • 2210 szt. 	
S 554	1	41010.000.554 Skład: <ul style="list-style-type: none"> • Nakrętki sześciokątne zgodn. z DIN 934 i podkładki okrągłe bez ściegła zgodn. z DIN 125-1A • Stal nierdzewna A2-70 • Zawartość: <ul style="list-style-type: none"> • M4 / M5 / M6 / M8 / M10 / M12 • 1700 szt. 	
S 556	1	41010.000.556 Skład: <ul style="list-style-type: none"> • Nakrętki sześciokątne samozabezpieczające z wkładką plastikową zgodn. z DIN 985 • Stal klasy ≥ 5 cynkowana • Zawartość: <ul style="list-style-type: none"> • M3 / M4 / M5 / M6 / M7 / M8 / M10 / M12 / M14 / M16 • 1450 szt. 	
S 558	1	41010.000.558 Skład: <ul style="list-style-type: none"> • Nakrętki sześciokątne samozabezpieczające z wkładką plastikową zgodn. z DIN 985 • Stal nierdzewna A2 • Zawartość: <ul style="list-style-type: none"> • M3 / M4 / M5 / M6 / M8 / M10 / M12 / M14 / M16 / M20 • 614 szt. 	
S 560	1	41010.000.560 Skład: <ul style="list-style-type: none"> • Nakrętki kołpakowe zgodn. z DIN 1587 i nakrętki kołpakowe niskie zgodn. z DIN 917 • Stal klasy 6 cynkowana • Zawartość: <ul style="list-style-type: none"> • M4 / M5 / M6 / M8 / M10 • 1050 szt. 	
S 562	1	41010.000.562 Skład: <ul style="list-style-type: none"> • Nakrętki kołpakowe sześciokątne zgodn. z DIN 1587 i nakrętki sześciokątne zgodn. z DIN 917 • Stal nierdzewna A1-50 • Zawartość: <ul style="list-style-type: none"> • M4 / M5 / M6 / M8 / M10 • 540 szt. 	
S 564	1	41010.000.564 Skład: <ul style="list-style-type: none"> • Śruby skrzydełkowe z okrągłymi skrzydełkami zgodn. z DIN 316 i nakrętki skrzydełkowe typu lekkiego (amerykańskiego) • Żeliwo i stal klasy 04 cynkowana • Zawartość: <ul style="list-style-type: none"> • DIN 316: M5x16 / M6x10 -x20 -x30 / M8x20 -x30 • Nakrętki skrzydełkowe: M4 / M5 / M6 / M8 / M10 / M12 • 417 szt. 	
S 566	1	41010.000.566 Skład: <ul style="list-style-type: none"> • Wkładki z rowkiem typ A zgodn. z DIN 7965 i nakrętki wkręcane do drewna • Stal • Zawartość: <ul style="list-style-type: none"> • DIN 7965: M4x10 / M5x12 / M6x15 / M8x15 -x18 • Nakrętki wkręcane do drewna: M4 / M5 / M6 / M8 / M10 • 665 szt. 	

41010 Zestawy w kasetach stalowych		←
Wymiary	☒	Kod artykułu
S 570	1	41010.000.570 <ul style="list-style-type: none"> Skład: • Części odległościowe z 2x gwintem wewnętrznym typ H1200 i części odległościowe z gwintem wewnętrznym i gwintem zewnętrznym typ H1202 • Stal cynkowana • Zawartość: • H1200: M3x5x5 -x8,5x8,5 -x10x10 -x20x7 / M4x10x10 -x15x15 / -x25x9 -x40x9 -x50x9 • H1202: M3x5x3 -x10x7 -x15x7 -x30x7 / M4x10x6 -x30x9 -x40x9 / M5x20x11 -x30x11 • 435 szt. 
S 572	1	41010.000.572 <ul style="list-style-type: none"> Skład: • Wkładki gwintowane samonacinające typ 300 • Stal cynkowana, pasywacja na żółto i stal nierdzewna C4 • Zawartość: • M3 / M4 / M5 / M6 / M8 / M10 / M12 / M16 • 420 szt. 
S 574	1	41010.000.574 <ul style="list-style-type: none"> Skład: • Wkręty oczkowe art. 1G: 2,40x10x5 / 4,00x30x12 / 4,40x40x16 • Haki proste z zaostrzeniem art. 4: 2,65x30 / 3,20x40 • Haki proste art. 7: 2,65x30 / 3,20x40 • Haki proste mocne z wgłębieniem krzyżowym art. 9G: 5,25x40 -x50 • Haki sufitowe art. 11: 2,40x16/30 / 3,20x20/40 • Stal cynkowana • 1050 szt. 
S 576	1	41010.000.576 <ul style="list-style-type: none"> Skład: • Wkręty dwustronne art. 73A i wkręty dwustronne z sześciokątem na szczęki art. 69G • Stal cynkowana • Zawartość: • Art. 73A: M6x40 -x50 -x60 -x90 / M8x60 -x70 • Art. 69G: M8x80 -x90 / M10x80 -x90 -x100 • 226 szt. 
S 578	1	41010.000.578 <ul style="list-style-type: none"> Skład: • Szekle i szekle omega z • Stal nierdzewna A4 • Zawartość: • 5 / 6 / 8 / 10 / 12 • 32 szt. 
S 580	1	41010.000.580 <ul style="list-style-type: none"> Skład: • Śruby dwustronne zgodn. z DIN 976-1 A • Stal klasy ≥ 4.6 cynkowana, pasywacja na żółto • Zawartość: • M4x30 -x40 / M5x40 -x50 / M6x30 -x40 -x50 / M8x60 -x70 -x80 / M10x40 -x60 • 505 szt. 
S 582	1	41010.000.582 <ul style="list-style-type: none"> Skład: • Śruby dwustronne o długości części wkręcanej ≈ 1,25d zgodn. z DIN 939 • Stal nierdzewna A4 • Zawartość: • M6x30 / M8x20 -x25 -x40 -x50 / M10x25 -x30 -x40 -x50 / M12x40 -x50 / M16x50 • 73 szt. 
S 584	1	41010.000.584 <ul style="list-style-type: none"> Skład: • Wkręty z łbem walcowym płaskim z rowkiem zgodn. z DIN 84 i nakrętki sześciokątne zgodn. z DIN 934 • Stal klasy 4.8-10I cynkowana • Zawartość: • M3x10 -x12 -x16 -x20 -x25 / M4x10 -x16 -x20 -x25 -x30 / M5x20 -x25 -x30 -x40 / M6x25 -x30 -x40 -x50 • 3060 szt. 
S 586	1	41010.000.586 <ul style="list-style-type: none"> Skład: • Wkręty z łbem stożkowym płaskim z rowkiem zgodn. z DIN 963 i nakrętki sześciokątne zgodn. z DIN 934 • Stal klasy 4.8-10I cynkowana • Zawartość: • M3x10 -x20 -x30 / M4x10 -x20 -x30 / M5x10 -x20 -x25 / M6x20 -x30 / M8x20 -x25 • 2970 szt. 
S 588	1	41010.000.588 <ul style="list-style-type: none"> Skład: • Wkręty z łbem walcowym płaskim z rowkiem zgodn. z DIN 84 i nakrętki sześciokątne zgodn. z DIN 934 • Stal nierdzewna A2-70 • Zawartość: • M3x8 -x10 -x16 / M4x8 -x10 -x16 -x20 / M5x10 -x12 -x16 -x20 / M6x10 -x16 -x20 • 4550 szt. 
S 590	1	41010.000.590 <ul style="list-style-type: none"> Skład: • Wkręty z łbem stożkowym płaskim z rowkiem zgodn. z DIN 963 i nakrętki sześciokątne zgodn. z DIN 934 • Stal nierdzewna A2-70 • Zawartość: • M3x6 -x10 -x16 / M4x10 -x16 -x20 / M5x10 -x16 -x20 -x30 / M6x16 -x20 -x25 -x30 • 1550 szt. 
S 592	1	41010.000.592 <ul style="list-style-type: none"> Skład: • Nakrętki sześciokątne zgodn. z ≈ DIN 934, wkręty z łbem walcowym płaskim z rowkiem zgodn. z ≈ DIN 84, wkręty z łbem stożkowym płaskim z rowkiem zgodn. z ≈ DIN 963 i podkładki okrągłe bez ścięcia zgodn. z ≈ DIN 125-1 A • Plastik PA 6.6 (biały) • Zawartość: • M3x10 / M4x8 -x20 / M5x16 / M6x20 • 2100 szt. 

41010 Zestawy w kasetach stalowych		←		
Wymiary	<input type="checkbox"/>	Kod artykułu		
S 594	1	41010.000.594	Skład: <ul style="list-style-type: none"> Wkręty samogwintujące z łbem walcowym soczewkowym z wgłębieniem krzyżowym Phillips (H) zgodn. z DIN 7981 C-H Stal cynkowana Zawartość: <ul style="list-style-type: none"> ST2,9x13 / ST3,5x13 -x16 -x19 -x25 / ST4,2x13 -x16 -x19 -x25 / ST4,8x16 -x19 -x25 -x32 / ST5,5x19 -x25 -x32 / ST6,3x25 -x38 1855 szt. 	
S 596	1	41010.000.596	Skład: <ul style="list-style-type: none"> Wkręty samogwintujące z łbem walcowym soczewkowym z wgłębieniem krzyżowym Phillips (H) zgodn. z DIN 7981 C-H Stal cynkowana, pasywacja na czarno Zawartość: <ul style="list-style-type: none"> ST2,9x6,5 -x9,5 -x13 -x19 / ST3,5x9,5 -x13 -x16 -x19 -x25 / ST3,9x9,5 / ST4,2x9,5 -x13 -x16 -x19 -x25 / ST4,8x16 -x19 -x25 2145 szt. 	
S 598	1	41010.000.598	Skład: <ul style="list-style-type: none"> Wkręty samogwintujące z łbem stożkowym płaskim z wgłębieniem krzyżowym Phillips (H) zgodn. z DIN 7982 C-H Stal cynkowana Zawartość: <ul style="list-style-type: none"> ST2,9x9,5 -x13 / ST3,5x16 -x19 -x25 -x32 / ST3,9x19 / ST4,2x13 -x16 -x19 -x25 -x32 -x38 / ST4,8x19 -x25 -x32 / ST5,5x25 -x32 1650 szt. 	
S 600	1	41010.000.600	Skład: <ul style="list-style-type: none"> Wkręty samogwintujące z łbem walcowym soczewkowym z wgłębieniem krzyżowym Phillips (H) zgodn. z DIN 7981 C-H i wkręty samogwintujące z łbem stożkowym płaskim z wgłębieniem krzyżowym Phillips (H) zgodn. z DIN 7982 C-H Stal nierdzewna A2 Zawartość: <ul style="list-style-type: none"> ST3,5x9,5 -x13 -x16 -x19 -x25 / ST4,2x13 -x16 -x19 -x25 -x32 / ST4,8x19 -x25 1675 szt. 	
S 602	1	41010.000.602	Skład: <ul style="list-style-type: none"> Wkręty samogwintujące z łbem stożkowym soczewkowym z wgłębieniem krzyżowym Phillips (H) zgodn. z DIN 7983 C-H Stal cynkowana Zawartość: <ul style="list-style-type: none"> ST2,9x9,5 -x13 -x16 / ST3,5x13 -x16 -x19 -x25 / ST4,2x13 -x16 -x19 -x25 -x32 / ST4,8x16 -x19 -x25 -x32 / ST5,5x19 -x25 2175 szt. 	
S 604	1	41010.000.604	Skład: <ul style="list-style-type: none"> Wkręty samogwintujące z łbem stożkowym soczewkowym z wgłębieniem krzyżowym Phillips (H) zgodn. z DIN 7983 C-H Stal cynkowana, pasywacja na czarno Zawartość: <ul style="list-style-type: none"> ST2,9x9,5 -x13 -x19 / ST3,5x13 -x16 -x19 -x25 / ST3,9x16 -x25 / ST4,2x13 -x16 -x19 -x25 -x32 / ST4,8x16 -x19 -x25 -x32 1875 szt. 	
S 606	1	41010.000.606	Skład: <ul style="list-style-type: none"> Wkręty do płyty wiórowej z łbem stożkowym płaskim z wgłębieniem krzyżowym Pozidriv (Z) Stal cynkowana Zawartość: <ul style="list-style-type: none"> 3,5x20 -x25 -x30 -x35 -x40 / 4x17 -x20 -x25 -x30 -x35 -x40 -x45 -x50 / 4,5x30 -x40 -x50 / 5x50 -x60 1225 szt. 	
S 608	1	41010.000.608	Skład: <ul style="list-style-type: none"> SPEDEC: wkręty samowierzące z łbem sześciokątnym z kołnierzem zgodn. z DIN 7504 K, wkręty samowierzące z łbem walcowym wypukłym z wgłębieniem krzyżowym Phillips (H) zgodn. z DIN 7504 M-H, wkręty samowierzące z łbem stożkowym płaskim z wgłębieniem krzyżowym Phillips (H) zgodn. z DIN 7504 O-H Stal cynkowana Zawartość: <ul style="list-style-type: none"> ST3,5x9,5 -x19 / ST3,9x13 -x19 / ST4,2x13 -x19 -x25 -x32 / ST4,8x13 -x16 -x19 -x32 / ST5,5x32 / ST6,3x19 1460 szt. 	
S 610	1	41010.000.610	Skład: <ul style="list-style-type: none"> Kółki do ścian Plastik nylon (szary) Zawartość: <ul style="list-style-type: none"> 4 / 5 / 6 / 7 / 8 / 10 / 12 720 szt. 	
S 612	1	41010.000.612	Skład: <ul style="list-style-type: none"> Podkładki okrągłe powiększone d2 ≈ 3xd1 zgodn. z DIN 9021 Stal cynkowana Zawartość: <ul style="list-style-type: none"> Podkładki naprawiające: M4x20 / M5x20 / M6x25 -x30 / M8x30 / M10x30 / M12x36 DIN 9021: M4x12 / M5x15 / M6x18 / M8x24 / M10x24 1300 szt. 	
S 614	1	41010.000.614	Skład: <ul style="list-style-type: none"> Podkładki okrągłe bez ściecia zgodn. z DIN 125-1 A i podkładki sprężyste zgodn. z DIN 127 B Stal cynkowana Zawartość: <ul style="list-style-type: none"> M4 / M5 / M6 / M8 / M10 / M11 / M12 / M14 / M16 1700 szt. 	
S 616	1	41010.000.616	Skład: <ul style="list-style-type: none"> Podkładki sprężyste zgodn. z DIN 127 B Stal nierdzewna A2 Zawartość: <ul style="list-style-type: none"> M3 / M4 / M5 / M6 / M8 / M10 / M12 / M14 / M16 / M20 / M24 / M27 1180 szt. 	

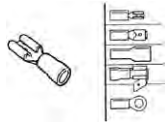
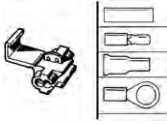
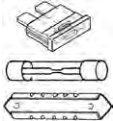
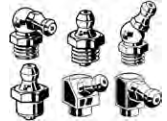
41010 Zestawy w kasetach stalowych		←		
Wymiary	☒	Kod artykułu		
S 618	1	41010.000.618	<p>Skład:</p> <ul style="list-style-type: none"> • Podkładki podatne faliste zgodn. z DIN 137 B, podkładki wachlarzowe ząbkowane zewnętrznie zgodn. z DIN 6798 A i podkładki wachlarzowe ząbkowane wewnętrznie zgodn. z DIN 6798 J • Stal cynkowana i stal cynkowana, pasywacja na żółto • Zawartość: • M3 / M4 / M5 / M6 / M8 / M10 • 6450 szt. 	
S 620	1	41010.000.620	<p>Skład:</p> <ul style="list-style-type: none"> • Podkładki okrągłe bez ściepnięcia zgodn. z DIN 125-1 A, podkładki podatne faliste zgodn. z DIN 137 B i podkładki wachlarzowe ząbkowane zewnętrznie zgodn. z ≈ DIN 6798 A • Stal nierdzewna A2 • Zawartość: • M3 / M4 / M5 / M6 / M8 / M10 • 2475 szt. 	
S 622	1	41010.000.622	<p>Skład:</p> <ul style="list-style-type: none"> • Pierścienie osadcze zewnętrzne zgodn. z DIN 471 • Stal • Zawartość: • Ø 25 / 26 / 27 / 30 / 31 / 33 / 35 / 38 / 40 / 42 • 247 szt. 	
S 624	1	41010.000.624	<p>Skład:</p> <ul style="list-style-type: none"> • Pierścienie osadcze wewnętrzne zgodn. z DIN 472 • Stal • Zawartość: • Ø 8 / 9 / 10 / 11 / 12 / 13 / 14 / 15 / 16 / 17 / 18 / 19 / 20 / 22 / 24 / 25 / 26 / 27 • 1460 szt. 	
S 626	1	41010.000.626	<p>Skład:</p> <ul style="list-style-type: none"> • Pierścienie osadcze zewnętrzne zgodn. z DIN 471 i pierścienie osadcze wewnętrzne zgodn. z DIN 472 • Stal nierdzewna • Zawartość: • Ø 5 / 6 / 8 / 10 / 12 / 14 / 16 / 20 / 22 / 25 / 26 / 30 / 32 / 35 / 42 / 47 • 263 szt. 	
S 628	1	41010.000.628	<p>Skład:</p> <ul style="list-style-type: none"> • Pierścienie osadcze zgodn. z ≈ DIN 705 A z wkrętem dociskowym bez łba z gniazdem sześciokątnym zgodn. z DIN 916 • Stal nierdzewna A1 • Zawartość: • 6x12x8 / 8x16x8 / 10x20x10 / 12x22x12 / 14x25x12 / 15x25x12 / 20x32x14 / 25x40x16 / 30x45x16 / 36x56x16 • 46 szt. 	
S 630	1	41010.000.630	<p>Skład:</p> <ul style="list-style-type: none"> • Pierścienie uszczelniające zgodn. z DIN 7603 A • Miedź, wyzarzona • Zawartość: • Ø 6x10x1,5 / 8x12x1,5 / 8x14x1,5 / 10x14x1,5 / 10x16x1,5 / 12x16x1,5 / 12x18x1,5 / 13x18x1,5 / 14x18x1,5 / 14x20x1,5 / 16x20x1,5 • 840 szt. 	
S 632	1	41010.000.632	<p>Skład:</p> <ul style="list-style-type: none"> • Pierścienie uszczelniające zgodn. z DIN 7603 A • Miedź, wyzarzona • Zawartość: • Ø 8x12x1,5 / 10x14x1,5 / 10x16x1,5 / 12x16x1,5 / 12x18x1,5 / 12x20x1,5 / 14x18x1,5 / 14x20x1,5 / 14x20x2 / 16x20x1,5 / 16x22x2 / 18x24x2 / 20x24x1,5 / 22x26x2 / 24x30x2 / 26x33x2 / 28x34x2 / 30x38x2 • 780 szt. 	
S 634	1	41010.000.634	<p>Skład:</p> <ul style="list-style-type: none"> • Pierścienie uszczelniające zgodn. z DIN 7603 A • Miedź, wyzarzona • Zawartość: • Ø 14x20x2 / 15x20x2 / 16x22x2 / 17x24x2 / 18x24x2 / 20x24x2 / 22x26x2 / 24x30x2 / 26x33x2 / 28x34x2 / 30x38x2 / 32x40x2 • 275 szt. 	
S 636	1	41010.000.636	<p>Skład:</p> <ul style="list-style-type: none"> • Pierścienie uszczelniające pełne zgodn. z DIN 7603 C • Miedź/FESTAPLAN • Zawartość: • Ø 6x10x1,5 / 8x12x1,5 / 8x14x1,5 / 12x16x2 / 14x18x2 / 14x20x2 / 16x22x2 / 18x24x2 / 20x26x2 / 24x32x2,5 / 26x32x2,5 / 32x38x2,5 • 645 szt. 	
S 638	1	41010.000.638	<p>Skład:</p> <ul style="list-style-type: none"> • Pierścienie uszczelniające • Włókno • Zawartość: • Ø 5x8 / 6x9 / 7x10 / 8x12 / 9x14 / 10x14 / 11x17 / 12x16 / 12,5x18 / 14x18 / 15x19 / 16x21 / 17x22 / 18x24 / 19x23 / 20x24 / 22x26 / 24x28 • 1910 szt. 	
S 640	1	41010.000.640	<p>Skład:</p> <ul style="list-style-type: none"> • Pierścienie uszczelniające o przekroju okrągłym (metryczne) • Guma - NBR 70° brzeg (czarna) • Zawartość: • Ø 5x1,5 / 6x1,5 / 7x1,5 / 8x2 / 10x2 / 12x2 / 18x2 / 20x2 / 11,3x2,4 / 13,3x2,4 / 13x2,5 / 14x2,5 / 15x2,5 / 16x2,5 / 20,2x3 / 22,2x3 / 24,2x3 / 26,2x3 • 1075 szt. 	
S 642	1	41010.000.642	<p>Skład:</p> <ul style="list-style-type: none"> • Linka na pierścień o przekroju okrągłym z taśmą mierniczą, nożami, formą do cięcia i klejem cyjanoakrylowym • Guma - NBR 70° brzeg (czarna) • Zawartość: • Ø 1,78 / 2,0 / 2,4 / 2,62 / 3,0 / 3,53 / 4,0 / 5,0 / 5,33 / 5,7 • UWAGA: ilość to 10x2 metry. Linka na pierścień o przekroju okrągłym 	

41010 Zestawy w kasetach stalowych		←		
Wymiary	<input type="checkbox"/>	Kod artykułu		
S 644	1	41010.000.644	Skład: <ul style="list-style-type: none"> • Pierścienie uszczelniające i korki zaślepiające • Guma (czarna) • Zawartość: <ul style="list-style-type: none"> • Pierścienie uszczelniające: Ø 4x6,4 / 5,5x8 / 6,4x9,5 / 8x9,5 / 9,5x12,5 / 11x12,5 / 12,5x17,5 / 14,2x17,5 / 16x19 • Korki zaślepiające: Ø 6,4x9,5 / 8x14,2 / 9,5x15,4 / 11,2x17,7 / 12,5x18,7 / 15,5x22 / 19x25,5 / 20x25,5 / 22,5x28,4 • 596 szt. 	
S 646	1	41010.000.646	Skład: <ul style="list-style-type: none"> • Podkładki ustalające do wałków STARLOCK • Stal sprężynowa (bez zaślepki) i stal sprężynowa (z zaślepką ze stali nierdzewnej) • Zawartość: <ul style="list-style-type: none"> • Ø 3 / 4 / 5 / 6 / 8 / 10 • 1400 szt. 	
S 648	1	41010.000.648	Skład: <ul style="list-style-type: none"> • Kołki sprężyste rozcięte wzmocnione zgodn. z ISO 8752 • Stal • Zawartość: <ul style="list-style-type: none"> • 4x30 -x40 -x50 -x60 / 5x20 -x26 -x30 -x40 -x50 -x60 / 6x40 -x50 -x60 -x70 / 8x40 -x50 -x60 -x70 • 520 szt. 	
S 650	1	41010.000.650	Skład: <ul style="list-style-type: none"> • PRYM Kołki sprężyste zwijane zwykle zgodn. z ISO 8750 • Stal • Zawartość: <ul style="list-style-type: none"> • 1,5x12 / 2x16 / 3x16 -x20 -x24 / 4x20 -x24 -x30 -x40 / 5x30 -x50 / 6x40 -x50 -x70 8x50 -x70 / 10x50 -x70 • 1040 szt. 	
S 652	1	41010.000.652	Skład: <ul style="list-style-type: none"> • PRYM Kołki sprężyste zwijane zwykle zgodn. z ≈ ISO 8750 • Stal nierdzewna A2 • Zawartość: <ul style="list-style-type: none"> • 2,5x8 -x16 / 3x8 -x10 -x12 -x16 -x20 / 4x10 -x14 -x16 -x18 -x22 -x30 / 5x24 -x26 -x50 / 6x20 • 725 szt. 	
S 654	1	41010.000.654	Skład: <ul style="list-style-type: none"> • Zawlecзки zgodn. z DIN 94 • Stal cynkowana • Zawartość: <ul style="list-style-type: none"> • 2x20 -x40 / 2,5x32 -x40 / 3,2x40 -x50 / 4x40 -x50 / 5x40 -x50 / 6,3x63 -x80 • 1345 szt. 	
S 656	1	41010.000.656	Skład: <ul style="list-style-type: none"> • Zawlecзки zgodn. z DIN 94 • Stal nierdzewna A2 • Zawartość: <ul style="list-style-type: none"> • 1,6x16 -x32 / 2x16 -x20 -x32 -x40 / 2,5x25 -x32 / 3,2x20 -x40 / 4x25 -x32 • 915 szt. 	
S 658	1	41010.000.658	Skład: <ul style="list-style-type: none"> • Wpusty pryzmatyczne - typ wysoki zgodn. z DIN 6885 A • Stal • Zawartość: <ul style="list-style-type: none"> • 4x4x12 / 5x5x10 -x20 -x25 / 6x6x12 -x20 -x25 -x32 -x40 / 8x7x25 -x32 -x40 -x50 / 10x8x40 -x50 -x63 / 12x8x40 -x50 • 336 szt. 	
S 660	1	41010.000.660	Skład: <ul style="list-style-type: none"> • Wpusty czółenkowe zgodn. z DIN 6888 • Stal • Zawartość: <ul style="list-style-type: none"> • 2x3,7 / 2,5x3,7 / 3x3,7 -x5 -x6,5 / 4x5 -x6,5 -x7,5 -x9 / 5x6,5 -x9 / 6x9 -x11 -x13 -x15 / 8x11 -x13 / 10x13 • 450 szt. 	
S 662	1	41010.000.662	Skład: <ul style="list-style-type: none"> • Sworznie ze zmniejszonym łbem i otworem na zawleczkę zgodn. z DIN 1434, podkładki okrągłe do sworzni zgodn. z DIN 1440 i zawlecзки zgodn. z DIN 94 • Stal cynkowana • Zawartość: <ul style="list-style-type: none"> • ISO 2341 B: Ø 5x14 / 6x18 / 8x22 / 10x28 / 12x35 / 14x40 • DIN 1440: dla zawlecзки Ø 5 / 6 / 8 / 10 / 12 / 14 / 16 • DIN 94: 1,6x10 / 2x16 / 2,5x20 / 3,2x20 / 4x25 • 234 szt. 	
S 666	1	41010.000.666	Skład: <ul style="list-style-type: none"> • Pierścienie uszczelniające zgodn. z DIN 7603 A, podkładki okrągłe bez ścieńca zgodn. z DIN 125-1 A i podkładki uszczelniające pełne zgodn. z DIN 7603 C • Aluminium 99F11; twardość HB 32-45, miedź, miedź/FESTAPLAN i plastik PA 6.6 (biały) • Zawartość: <ul style="list-style-type: none"> • Aluminium: Ø 8x14x1 / 10x14x1 / 12x18x1,5 / 14x20x1,5 / 16x22x1,5 / 18x24x1,5 / 20x26x1,5 • Miedź: Ø 10x16x1,5 / 12x16x1,5 / 14x20x1,5 / 16x22x2 / 18x24x2 / 20x24x2 • Miedź/FESTAPLAN: Ø 14x20x2 / 16x22x2 / 18x24x2 / 20x26x2 • Plastik: M14,5 • 1155 szt. 	

41010 Zestawy w kasetach stalowych		←	
Wymiary	☒	Kod artykułu	
S 668	1	41010.000.668	<p>Skład:</p> <ul style="list-style-type: none"> Izolowane wstępnie końcówki Stal/plastik Zawartość: Przewód 0,5 - 1,5 mm: typ 599 / 741 / 541 / 540 / 1541 / 561 / 556 (M3) / 535 (M4) / 557 (M5) Przewód 1,5 - 2,5 mm: typ 742 / 542 / 740 / 1542 / 562 / 536 (M4) / 537 (M5) / 560 (M6) Przewód 2,5 - 6,0 mm: typ 539 (M6) 408 szt. 
S 670	1	41010.000.670	<p>Skład:</p> <ul style="list-style-type: none"> Izolowane wstępnie końcówki i złącza Stal/plastik Zawartość: Przewód 0,5 - 1,5 mm: typ 545 / 547 / 548 Przewód 1,5 - 2,5 mm: typ 546 / 550 / 549 Przewód 2,5 - 6,0 mm: typ 563 (M8) / 554 (M10) Złącze typ C-560 niebieskie 298 szt. 
S 672	1	41010.000.672	<p>Skład:</p> <ul style="list-style-type: none"> Bezpieczniki samochodowe Stal/plastik Zawartość: 7,5A / 10A / 15A / 20A / 25A / 30A2A (5x20 mm) / 2A (6,35x25 mm) / 5A / 10A / 15A / 20A / 25A5A / 8A / 16A / 25A / 40A 304 szt. 
S 676	1	41010.000.676	<p>Skład:</p> <ul style="list-style-type: none"> Smarowniczk stożkowe zgodn. z ≈ DIN 71412 i smarowniczk wkręcane Stal cynkowana Zawartość: M6x1-45° -90° -180° / M8x1-45° -90° -180° / M8x1,25-45° -90° -180° / M10x1-45° -90° -180° / M10x1,25-45° -90° -180° Smarowniczek wkręcany: 6-45° -180° / 8-90° -180° 246 szt. 
S 680	1	41010.000.680	<p>Skład:</p> <ul style="list-style-type: none"> Sprężyny śrubowe walcowe naciskowe zgodn. z DIN 2095 Stal sprężynowa cynkowana Zawartość: 0,5x3,5x15 / 0,5x4,5x12 / 0,5x6,5x20 -x30 / 0,8x5,7x25 / 0,8x6,7x25 / 0,8x7,7x30 -x35 -x50 / 1x6x25 / 1x8x25 -x30 / 1x10x25 -x60 / 1,5x10x50 / 1,5x12x40 / 1,5x14x60 / 2x14x50 695 szt. 
S 682	1	41010.000.682	<p>Skład:</p> <ul style="list-style-type: none"> Sprężyny śrubowe naciągowe zgodn. z DIN 2097 Stal sprężynowa cynkowana Zawartość: 0,5x3,5x20 / 0,5x4,5x20 / 0,5x6,5x20 -x25 -x30 -x35 / 0,8x6,7x30 -x35 / 0,8x7,7x40 -x50 / 1x6x30 / 1x8x25 -x35 / 1x10x35 -x40 -x60 / 1,5x10x35 -x50 522 szt. 
S 684	1	41010.000.684	<p>Skład:</p> <ul style="list-style-type: none"> SECURITY: "jednostronne wkręty samogwintujące, wkręty samogwintujące z łbem walcowym wypukłym z wgłębieniem krzyżowym, wkręty z łbem stożkowym płaskim z 2 otworami, wkręty z łbem walcowym płaskim z 2 otworami, wkręty z łbem kulistym z gniazdem sześciokątnym, wkręty do drewna z łbem kulistym z gniazdem kwadratowym, końcówki wkrętaka, klucz do wkrętów z gniazdem sześciokątnym, wkrętaki i nakrętki Stal, stal cynkowana i stal nierdzewna A2 Zawartość: Wkręty z łbem walcowym płaskim z 2 otworami: M4x10 / M5x12 + końcówka wkrętaka Wkręty z łbem stożkowym płaskim z 2 otworami: M3x12 / M4x10 + końcówka wkrętaka Wkręty samogwintujące z łbem walcowym wypukłym z wgłębieniem krzyżowym: ST 4,8x13 -x19 + końcówka wkrętaka Jednostronne wkręty samogwintujące: ST 3,5x25 / ST 4,2x19 -x32 Wkręty do drewna z łbem kulistym z gniazdem kwadratowym: 4,2x25 -x32 Wkręty z łbem kulistym z gniazdem sześciokątnym: M6x25 + klucz do wkrętów z gniazdem sześciokątnym Nakrętki: M8 Wkrętaki 310 szt. 
S 686	1	41010.000.686	<p>Skład:</p> <ul style="list-style-type: none"> Wiertła kręte z chwytem walcowym zgodn. z DIN 338 RN Stal HSS Zawartość: Ø 0,5 / 1 / 1,5 / 2 / 2,5 / 3 / 3,5 / 4 / 4,5 / 5 / 5,5 / 6 / 6,5 / 7 / 7,5 / 8 / 8,5 / 9 / 9,5 / 10 175 szt. 

41010 Zestawy w kasetach stalowych		←	
Wymiary	Kod artykułu		
S 688	1 41010.000.688	<p>Skład:</p> <ul style="list-style-type: none"> • Łączniki do mebli: sześciokątne wkładki wkręcane typ SK, wkładki wkręcane z gniazdem sześciokątnym z kołnierzem typ SKD, nakrętki radełkowane typ RM, nakrętki na kołek ustalający typ RSK, nakrętki walcowe z gniazdem sześciokątnym typ RF, nakrętki walcowe z gniazdem sześciokątnym typ RT, wkładki wbijane z kołnierzem typ TS, kołki ustalające z rowkiem krzyżowym typ Q, wkręty z łbem walcowym płaskim z gniazdem sześciokątnym typ KF, wkręty z łbem grzybkowym z gniazdem sześciokątnym typ KT i łączniki narożne z gniazdem sześciokątnym typ KOK • Stal cynkowana, stal niklowana i mosiądz niklowany • Zawartość: • Sześciokątne wkładki wkręcane: M6x15 • Wkładki wkręcane z gniazdem sześciokątnym z kołnierzem: M6x15 • Nakrętki radełkowane: M6x18 • Nakrętki na kołek ustalający: M6x16 • Nakrętki walcowe z gniazdem sześciokątnym: M6 • Nakrętki walcowe z gniazdem sześciokątnym: M6 • Wkładki wbijane z kołnierzem: M6 • Kołki ustalające z rowkiem krzyżowym: M6x12 -x14 • Wkręty z łbem walcowym płaskim z gniazdem sześciokątnym: M6x50 -x60 -x70 • Wkręty z łbem kulistym z gniazdem sześciokątnym: M6x50 -x60 -x70 • Łączniki narożne z gniazdem: 7x50 • 425 szt. 	
S 690	1 41010.000.690	<p>Skład:</p> <ul style="list-style-type: none"> • Kołki do ścian i wiertła do murów typ A • Plastik nylon (szary) i stal • Zawartość: • 5 / 6 / 7 / 8 / 10 / 12 • 520 szt. 	
S 692	1 41010.000.692	<p>Skład:</p> <ul style="list-style-type: none"> • Bezpieczniki samochodowe • Stal/plastik • Zawartość: • 7,5A / 10A / 15A / 20A / 25A / 30A4A / 5A / 7,5A / 10A / 15A / 20A / 25A / 30A20A / 30A / 40A / 50A / 60A / 70A / 80A • 276 szt. 	
S 694	1 41010.000.694	<p>Skład:</p> <ul style="list-style-type: none"> • NORD-LOCK podkładki klejone odporne na drgania, 2 części • Stal Deltaprotekt • Zawartość: • M8 / M10 / M14 / M16 / M18 / M20 / M24 • 170 (x2) szt. 	
S 698	1 41010.000.698	<p>Skład:</p> <ul style="list-style-type: none"> • OMNI nity jednostronnie zamykane, z kopułą zgodn., podkładki okrągłe bez ściecia zgodn. z DIN 125-1 A i narzędzie ręczne • Aluminium ze stalą cynkowaną - trzpień • Zawartość: • 3x6 -x8 -x10 / 4x6 -x8 -x10 -x12 -x16 / 4,8x8 - x10 -x12 -x14 • DIN 125-1 A: M3 / M4 / M5 • Narzędzie ręczne: typ F150B • 1.565 szt. 	
S 700	1 41010.000.700	<p>Zestaw:</p> <ul style="list-style-type: none"> • ABA Zacisk gumowy • Zawartość: • 5 / 6 / 8 / 10 / 11 / 13 / 14 / 16 mm • 130 szt. 	
S 702	1 41010.000.702	<p>Zestaw:</p> <ul style="list-style-type: none"> • ABA zaciski Nova i Mini • Zawartość: • Nova 11-17 / 13-20 / 15-24 / 19-28 / 22-32 / 26-38 mm • Mini nr 8 / 10 / 12 / 14 / 16 / 17 • 1 elastyczny śrubokręt • 146 szt. 	
S 704	1 41010.000.704	<p>Zestaw:</p> <ul style="list-style-type: none"> • ABA zaciski z 2 uchami • Zawartość: • 5-7 / 7-9 / 9-11 / 11-13 / 13-15 / 15-18 / 17-20 / 20-23 / 23-25 • 1 narzędzie • 601 szt. 	
S706	1 41010.000.706	<p>Zestaw:</p> <ul style="list-style-type: none"> • NORD-LOCK Podkładki klejone odporne na drgania / NORD-LOCK Podkładki klejone odporne na drgania o dużej średnicy zewnętrznej • Zawartość: • M6 - M8 - M10 - M12 - M16 - M20 / M6x13,5 - M8x16 - M10x21 - M12x25 - M16x30 - M20x39 • 350 szt. 	



Wymiary	☒	Kod artykułu		
Wkręty do drewna 3,5X25-6X60	1	30950.007.001	Zestaw: <ul style="list-style-type: none"> 3,5x25mm, 4x30mm, 4x35mm, 4x40mm, 4x45mm, 5x40mm, 5x50mm, 6x60mm MF 1/4 Bit TTAP 15, MF 1/4 Bit TTAP 20, MF 1/4 Bit TTAP 25 	
Wkręty do drewna 3,5X16-5X70	1	30950.007.002	Zestaw: <ul style="list-style-type: none"> 3,5x16mm, 3,5x20mm, 3,5x25mm, 3,5x30mm, 3,5x35mm, 4x30mm, 4x40mm, 4x50mm, 4x60mm, 5x50mm, 5x60mm, 5x70mm MF 1/4 Bit TTAP15, MF 1/4 Bit TTAP 20, MF 1/4 Bit TTAP 25 	
Wkręty do drewna 3X16-5X50	1	30950.007.003	Zestaw: <ul style="list-style-type: none"> 3x16mm, 3,5x20mm, 3,5x25mm, 4x16mm, 4x20mm, 4x25mm, 4x30mm, 4x40mm, 5x20mm, 5x30mm, 5x40mm, 5x50mm MF 1/4 Bit TTAP 10, MF 1/4 Bit TTAP 15, MF 1/4 Bit TTAP 20, MF 1/4 Bit TTAP 25 	
Wkręty do drewna 3,5X25-6X60	1	30950.007.010	Zestaw: <ul style="list-style-type: none"> 3,5x25mm, 4x30mm, 4x35mm, 4x40mm, 4x45mm, 5x40mm, 5x50mm, 6x60mm MF 1/4 Bit TTAP PZ2, MF 1/4 Bit TTAP PZ3 	
Wkręty do drewna 3,5X16-5X70	1	30950.007.011	Zestaw: <ul style="list-style-type: none"> 3,5x16mm, 3,5x20mm, 3,5x25mm, 3,5x30mm, 3,5x35mm, 4x30mm, 4x40mm, 4x50mm, 4x60mm, 5x50mm, 5x60mm, 5x70mm MF 1/4 Bit PZ2 	
Wkręty do drewna 3X16-5X50	1	30950.007.012	Zestaw: <ul style="list-style-type: none"> 3x16mm, 3,5x20mm, 3,5x25mm, 4x16mm, 4x20mm, 4x25mm, 4x30mm, 4x40mm, 5x20mm, 5x30mm, 5x40mm, 5x50mm MF 1/4 Bit PZ1, MF 1/4 Bit PZ2 	
Kołki 5-6-8-10-12	1	30950.009.001	Zestaw: <ul style="list-style-type: none"> 4FAST: 5, 6, 8, 10, 12mm Multifast: 6, 8, 10mm 	
Kołki i wkręty 5-6-8-10	1	30950.009.002	Zestaw: <ul style="list-style-type: none"> 4FAST: 5, 6, 8, 10mm Chipboard screw: 4x30mm, 4,5x40mm, 5x50mm, 6x60mm 	
Kołki i wkręty 6-8-10	1	30950.009.003	Zestaw: <ul style="list-style-type: none"> 4FAST: 6, 8, 10mm Chipboard screw: 4,5x40mm, 5x50mm, 6x60mm, 4,5x45mm, 4,5x60mm, 5x70mm Multifast: 6, 8, 10mm 	
Opaski do węży 8-70	1	30950.012.001	Zestaw: <ul style="list-style-type: none"> 9mm 8-16, 12-22, 16-27, 20-32, 25-40, 32-50, 40-60, 50-70 	

Akcesoria do segregowania





Grupy katalogowe

Kod	Strona
41030	11-24
41020	11-24
41040	11-24

41030 Szafka z szufladami *99B



Typ	<input type="checkbox"/>	Kod artykułu		
SF-3	<input checked="" type="checkbox"/>	41030.001.770	<ul style="list-style-type: none"> Szafki na zestawy w kasetach stalowych, odpowiednie na 3 x typ S Rozmiar: 385 x 265 x 215 mm Solidne, przystosowane od układania w stosy Z dwoma otworami z tyłu, co pozwala na zamocowanie szafki do ściany w razie konieczności 	
SF-5	<input checked="" type="checkbox"/>	41030.001.780	<ul style="list-style-type: none"> Szafki na zestawy w kasetach stalowych, odpowiednie na 5 x typ S Rozmiar: 415 x 255 x 430 mm. Każda szuflada posiada zasuwkę blokującą w kolorze czerwonym, zapobiegającą niekontrolowanemu wysunięciu Każda szuflada wysuwana na szynie teleskopowej Zamek cylindryczny pozwala na zamknięcie wszystkich szuflad jednocześnie Dołączone są łączniki pozwalające na zamocowanie szafki z szufladami do ściany 	

41020 Kasety *99B



Typ	<input type="checkbox"/>	Kod artykułu	
Kasety kompletne	<input checked="" type="checkbox"/>	41020.001.775	

41040 Akcesoria do segregowania *99B

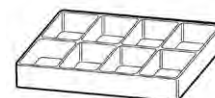

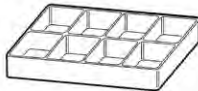



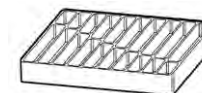
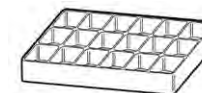
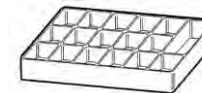
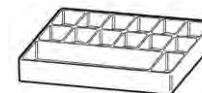
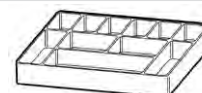





Typ	<input type="checkbox"/>	Kod artykułu	
8-Przedziałów	<input checked="" type="checkbox"/>	41040.100.008	
10-Przedziałów	<input checked="" type="checkbox"/>	41040.100.010	

41040 Akcesoria do segregowania		←
Typ	☒	Kod artykułu
11-Przedziałów	1	41040.100.011
12-Przedziałów	1	41040.100.012
14-Przedziałów	1	41040.100.014
17-Przedziałów	1	41040.100.017
18-Przedziałów	1	41040.100.018
20-Przedziałów	1	41040.100.020
Wkładka piankowa	1	41040.200.010



ELEMENTY WYPOSAŻENIA KEEPSTOCK





Kompletne wyposażenie, którego potrzebujesz do najefektywniejszego systemu magazynowania. Szafy, regały, kuwety oraz bogaty asortyment akcesoriów.

 <p>Szafa stojąca z 12 półkami bez przegród. W1200.000.005 198x60x30 cm</p>	 <p>Szafa na kuwety uchylne bez kuwet. Odpowiednia na 96 kuwet uchylnych. W1200.200.027 200x100x30 cm</p>	 <p>Szafa stojąca z 12 półkami bez przegród. W1201.201.031 198x100x30 cm</p>		
 <p>Szafa transportowa z dwoma pokrywami i uchwytami. W1201.202.300 147x100x52 cm</p>	 <p>Szafa z 8 otworami na pręty gwintowane. W1297.000.008 63x60x25 cm</p>	 <p>Przenośny regał na pojemniki z 2 sztywnymi, nylonowymi i 2 obrotowymi kółkami samonastawnymi z hamulcami oraz 18 taśmami montażowymi do pojemników nr 52, 53, 54 i 55. W1210.001.775</p>		
 <p>Mocowanie do systemu kuwet uchylnych. W1276.001.125 160x115x110 cm</p>	 <p>Zasobnik do systemu kuwet uchylnych. W1276.001.105</p>	 <p>Przegroda z tworzywa sztucznego do szafy magazynowej. W1290.001.030</p>	 <p>Przegroda metalowa do szafy magazynowej. W1290.000.030</p>	 <p>Pojemnik zawieszany z tworzywa sztucznego do przenośnych regałów na pojemniki. W1275.000.052: 16,5x20,5x35 cm W1275.000.053: 13x15x24 cm W1275.000.054: 17,5x10x17,5 cm W1275.000.055: 5x10,5x9 cm</p>

Przejrzyj stronę www.fabory.com i zapoznaj się ze szczegółowymi informacjami na temat wyposażenia i rozwiązań KeepStock.

Skrzynie transportowe



63152		FISCHER Skrzynia transportowa		N03B	
Materiał	Plastik				
Kolor	Czerwony				
Typ	 Kod artykułu				
MOBIBOX	1	63152.001.770	•	Czerwona z aluminiowym uchwytem	
					

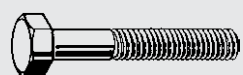

1 Śruby

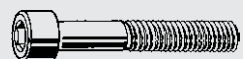

2 Produkty z gniazdem sześciokątnym



3 Nakrętki, nitonakrętki & wkładki



4 Pręty gwintowane & śruby dwustronne



5 Haki & śruby oczkowe



6 Wkręty

I Index



7 Podkładki & pierścienie uszczelniające typu “O-ring”



8 Kotwy, kołki, dyble



9 Nity, kołki & wpusty



10 Elementy łączące systemowe, meblowe & zabezpieczające



11 Zestawy

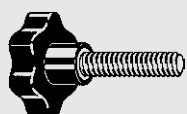

12 Części konstrukcyjne & części maszynowe

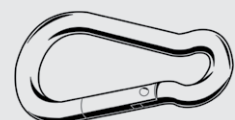













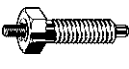



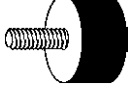























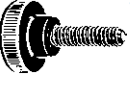
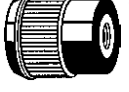

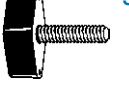

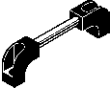

13 Przemysł morski

T Technologia łączenia

Części konstrukcyjne & części maszynowe **12**

 Strona 12-6 Obejmy ślimakowe 9 mm	 Strona 12-8 Obejmy ślimakowe 12 mm	 Strona 12-9 Ślimakowe 12 mm, stal nierdzewna	 Strona 12-11 AWAB Obejmy ślimakowe, stal nierdzewna	 Strona 12-12 MAXXFAST Obejmy zaciskowe Mini
 Strona 12-13 ABA Obejmy zaciskowe Mini	 Strona 12-14 ABA Obejmy zaciskowe heavy duty stal nierdzewna	 Strona 12-15 ABA Obejmy zaciskowe heavy duty	 Strona 12-16 ABA Obejmy zaciskowe Mikro	 Strona 12-16 Obejmy zaciskowe pojedyncze
 Strona 12-17 ABA Obejmy zaciskowe podwójne	 Strona 12-18 ABA Obejmy zaciskowe dwuczęściowe	 Strona 12-19 MAXXFAST Zaciski z gumą	 Strona 12-20 ABA Zaciski z gumą	 Strona 12-21 BA zestaw opasek do węży
 Strona 12-23 ABA Wkrętaki	 Strona 12-24 AWAB Zaciski rurowe	 Strona 12-25 Zaciski rurowe 8mm	 Strona 12-26 BAND-IT	 Strona 12-29 Obejmy rurowe (cybanty)
 Strona 12-31 Obejmy rurowe (cybanty)	 Strona 12-32 Obejmy do rur - połówkowe	 Strona 12-34 Obejmy do rur - połówkowe nierdzewne	 Strona 12-36 Obejmy do rur	 Strona 12-37 Obejmy do rur nierdzewne
 Strona 12-39 Kołpak ozdobny	 Strona 12-40 DIN ≈443 Nasadki uszczelniające wciskane	 Strona 12-41 DIN ≈470 Podkładki uszczelniające	 Strona 12-42 DIN ≈71412 Smarownicza z gwintem metrycznym	 Strona 12-43 Smarownicza wciskana
 Strona 12-43 DIN ≈3405 A Smarownicza z gwintem metrycznym	 Strona 12-44 DIN ≈3404 A Smarownicza z gwintem metr. drobnozwojnym	 Strona 12-44 DIN ≈71412 A/B/C Smarownicza z gwintem drobnozwojnym	 Strona 12-45 DIN ≈71412 A/B/C Smarownicza z gwintem extra drobnozwojnym	 Strona 12-45 DIN ≈71412 A/B/C Smarownicza z gwintem rurowym
 Strona 12-46 DIN ≈71412 A/B/C Smarownicza z gwintem UNF	 Strona 12-46 DIN ≈3404 A Smarownicza z gwintem rurowym	 Strona 12-47 DIN 71802 CS Przegub kulowy	 Strona 12-48 DIN 808 E Przegub Cardana	 Strona 12-49 DIN 808 D Przegub Cardana
 Strona 12-49 DIN 71752 Przeguby widelkowe	 Strona 12-50 DIN 648 B Główki cięgieł z gwintem wewnętrznym	 Strona 12-51 DIN 648 A Główki cięgieł z gwintem zewnętrznym	 Strona 12-52 Łączniki	 Strona 12-53 Łączniki
 Strona 12-54 Zawiasy do spawania	 Strona 12-55 Zawiasy	 Strona 12-56 Wkręt dociskowy	 Strona 12-57 Wkręt dociskowy	 Strona 12-58 Wkręt dociskowy

 Strona 12-59 Wkręt dociskowy	 Strona 12-59 Wkręt dociskowy	 Strona 12-60 Śruba zabezpieczająca	 Strona 12-60 Śruba zabezpieczająca	 Strona 12-61 Śruba zabezpieczająca
 Strona 12-61 Odbojnik, typ A	 Strona 12-62 Odbojnik, typ B	 Strona 12-63 Odbojnik, typ C	 Strona 12-64 Odbojnik, typ D-KD	 Strona 12-65 Amortyzator typ RA
 Strona 12-66 Amortyzator typ RAEM	 Strona 12-67 Amortyzator typ RAB	 Strona 12-68 Amortyzator typ M	 Strona 12-69 Amortyzator typ SE	 Strona 12-69 Zaślepka kwadratowa
 Strona 12-70 Podkładka antywibracyjna	 Strona 12-71 Śruba do podstawki antywibracyjnej	 Strona 12-72 Podpory maszyn	 Strona 12-73 Tulejki typ VP	 Strona 12-74 DIN 2095 Sprężyny naciskowe
 Strona 12-75 DIN 2097 Sprężyny naciągowe	 Strona 12-76 DIN ≈319 Gałka, typ C	 Strona 12-77 DIN ≈319 M Gałka, typ M	 Strona 12-78 DIN ≈6336 L Plastikowa gałka, typ L	 Strona 12-78 DIN ≈6336 K Plastikowa gałka, typ K
 Strona 12-79 Pokrętło plastikowe	 Strona 12-80 Pokrętło plastikowe	 Strona 12-81 Pokrętło plastikowe	 Strona 12-82 Gałka trójkątna	 Strona 12-83 Gałka pięciokątna
 Strona 12-84 Zaślepka do śrub i nakrętek	 Strona 12-85 Zaślepka do śrub imbusowych	 Strona 12-85 Śruba radełkowana	 Strona 12-86 Śruba radełkowana	 Strona 12-87 Plastikowa gałka
 Strona 12-87 Pokrętło skrzydełkowe	 Strona 12-88 Nakrętka skrzydełkowa	 Strona 12-88 Śruba skrzydełkowa	 Strona 12-89 Uchwyt	 Strona 12-90 Uchwyt kabłąkowy
 Strona 12-90 Uchwyt kabłąkowy	 Strona 12-91 Uchwyt kabłąkowy	 Strona 12-91 Uchwyt kabłąkowy	 Strona 12-92 Uchwyt z gwintem wewnętrznym	 Strona 12-92 Plastikowy uchwyt
 Strona 12-93 Plastikowy uchwyt	 Strona 12-93 Plastikowy uchwyt	 Strona 12-94 Uchwyt z możliwością obrotu	 Strona 12-95 Uchwyt z możliwością obrotu	 Strona 12-95 Uchwyt chowany z możliwością obrotu

Części konstrukcyjne & części maszynowe **12**

 Strona 12-96 Korba	 Strona 12-96 Korba	 Strona 12-97 Dźwignia typ A	 Strona 12-97 Dźwignia	 Strona 12-98 Umożliwiająca podnoszenie, metryczne
 Strona 12-99 Umożliwiająca podnoszenie, metryczne	 Strona 12-101 Dźwignia	 Strona 12-102 Umożliwiająca podnoszenie, metryczne	 Strona 12-103 Dźwignia	 Strona 12-103 Dźwignia
 Strona 12-104 DIN 388-1C Pokrętko plastikowe	 Strona 12-105 DIN 950 Aluminiowe pokrętła	 Strona 12-106 Plastikowe pokrętko	 Strona 12-106 Pokrętko z chowaną rączką	 Strona 12-107 Plastikowe pokrętko
 Strona 12-107 Pokrętko z rączką	 Strona 12-108 Pokrętko z chowaną rączką	 Strona 12-108 Pokrętko z chowaną rączką	 Strona 12-109 Pokrętko z chowaną rączką	 Strona 12-111 DIN =5401 Kule techniczne
 Strona 12-113 Kule techniczne, nieżelazne	 Strona 12-115 Pierścienie uszczelniające	 Strona 12-116 Korki zaślepiające	 Strona 12-117 Zacisk	 Strona 12-118 Zacisk
 Strona 12-120 Opaski zaciskowe	 Strona 12-121 Opaski zaciskowe stal nierdzewna	 Strona 12-122 Opaski zaciskowe	 Strona 12-123 Zestaw opasek zaciskowych	 Strona 12-124 Opaski zaciskowe
 Strona 12-124 Opaski zaciskowe	 Strona 12-126 Opaski zaciskowe wielokrotnego użytku	 Strona 12-127 Opaski zaciskowe	 Strona 12-127 Podstawy mocujące do opasek zaciskowych	 Strona 12-128 Elementy mocujące do opasek zaciskowych
 Strona 12-129 Szczypce ręczne do opasek	 Strona 12-130 Opaski zaciskowe, plastikowe	 Strona 12-131 Uchwyty do kabli	 Strona 12-132 Zaciski do kabli, samoprzylepne	 Strona 12-133 Zaciski do płaskich kabli, samoprzylepne
 Strona 12-134 Dryle	 Strona 12-135 Element mocujący	 Strona 12-136 Nity	 Strona 12-137 Nity	 Strona 12-138 Zaślepka
 Strona 12-139 Zaślepka	 Strona 12-140 Przelotki	 Strona 12-141 Podstawa	 Strona 12-142 Odbojnik	 Strona 12-143 Odbojnik

 <p>Strona 12-143</p> <p>Rozeta plastikowa, typ zamknięty</p>	 <p>Strona 12-144</p> <p>Podkładki zabezpieczające</p>	 <p>Strona 12-145</p> <p>Podkładki kołnierzowe</p>	 <p>Strona 12-145</p> <p>Tuleje izolujące</p>	 <p>Strona 12-146</p> <p>Tulejki izolacyjne</p>
 <p>Strona 12-147</p> <p>Tuleje izolujące</p>	 <p>Strona 12-147</p> <p>Tuleje plastikowe</p>	 <p>Strona 12-148</p> <p>Rurki izolacyjne</p>	 <p>Strona 12-149</p> <p>Korki plastikowe</p>	 <p>Strona 12-150</p> <p>Zaślepki i korki ochronne</p>
 <p>Strona 12-151</p> <p>Zaciski przegubowe pionowe</p>	 <p>Strona 12-154</p> <p>Zaciski przegubowe poziome</p>	 <p>Strona 12-157</p> <p>Zaciski przegubowe przeciwsołbne</p>	 <p>Strona 12-160</p> <p>Zaciski przegubowe hakowe</p>	 <p>Strona 12-161</p> <p>Zaciski przegubowe poziome</p>
 <p>Strona 12-162</p> <p>Zaciski przegubowe pionowe</p>	 <p>Strona 12-163</p> <p>Przeciwwzaczepy do zacis. przegub. hakowych</p>			

MaxxFast opaski zaciskowe do węży

- Gładkie wykończenie krawędzi przeciwdziała uszkodzeniu rury.
- Silna obręcz z mechanicznym blokowaniem.
- Budowa opaski zapewnia bardzo dobry kontakt pomiędzy śrubą a opaską.
- Całość zapewnia doskonałe rozłożenie siły wokół całej opaski i w ten sposób zapobiega przeciekom pod wysokim ciśnieniem.
- Zgodne z ROHS (2006).
- DIN 3017

MaxxFast obejmy ocynkowane

- MaxxFast obejmy OCYNK 9mm
- MaxxFast obejmy OCYNK 12mm
- MaxxFast narzędzia do opasek zaciskowych
- MaxxFast opaski zaciskowe mini OCYNK
- MaxxFast zaciski z gumą

MaxxFast obejmy stal nierdzewna

- MaxxFast obejmy stal nierdzewna 12mm

MaxxFast element wystawowy

Regał na opaski do węży oraz narzędzia MaxxFast jest wyposażony w najczęściej używane standardowe opaski zaciskowe, mini opaski zaciskowe oraz specjalnie zaprojektowany wkrętak.



Opaski zaciskowe do węży, szerokość 9 mm

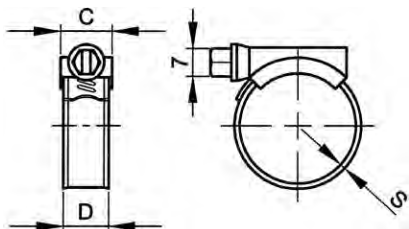

Informacje techniczne

Typ	C (maks.)	D	Moment obrotowy dokręcania w Nm (maks.)	S
8-14	12	9	3.5	0.8
8-16	14	9	3	0.6
11-17	12	9	3.5	0.8
12-22	14	9	3	0.6
13-20	12	9	4	0.8
15-24	12	9	4	0.8
16-27	14	9	3.5	0.7
19-28	12	9	4	0.8
20-32	14	9	3.5	0.7
22-32	12	9	4	0.8
25-40	14	9	4	0.7
26-38	12	9	4.5	0.8
32-44	12	9	4.5	0.8
32-50	14	9	4	0.7
38-50	12	9	4.5	0.8
40-60	14	9	4	0.7
44-56	12	9	4.5	0.8
50-65	12	9	4.5	0.8
50-70	14	9	4	0.7
58-75	12	9	4.5	0.8
68-85	12	9	4.5	0.8

- Numer typu podaje minimalny i maksymalny zakres uchwytu.

Grupy katalogowe

Materiał	Obróbka powierzchni	Kod	Strona
St	Ocynk.	30650	12-6
St	Ocynk.	43081	12-7
St	Ocynk.	Duże Opakowanie	12-7

30650 MAXXFAST Opaski zaciskowe do węży, szerokość 9 mm

MF60

Materiał Stal
Obróbka powierzchni Ocynkowane

MAXXFAST
PROFESSIONAL HARDWARE



Zakres uchwytu	☒	Kod artykułu	Zakres uchwytu	☒	Kod artykułu	Zakres uchwytu	☒	Kod artykułu
8-16MM	50	30650.008.016	20-32MM	50	30650.020.032	40-60MM	25	30650.040.060
12-22MM	50	30650.012.022	25-40MM	50	30650.025.040	50-70MM	25	30650.050.070
16-27MM	50	30650.016.027	32-50MM	25	30650.032.050			

- Tylko pełne opakowania.

43081	ABA Opaski zaciskowe do wężu, szerokość 9 mm	Y01A	
Materiał	Stal	 	
Obróbka powierzchni	Ocynkowane		

- Specjalne właściwości opasek zaciskowych do wężu ABA:
- z jednoczęściową NIEBIESKĄ oprawą do zacisnięcia (patent ABA)
 - zawinięte krawędzie opaski nie niszczą wężu
 - opaska jest gładka od wewnętrznej strony, co chroni wąż
 - proste w instalacji i luzowaniu dzięki sześciokątnej rowkowanej główce
 - możliwość wielokrotnego używania



Zakres uchwytu	☒	Kod artykułu	Zakres uchwytu	☒	Kod artykułu	Zakres uchwytu	☒	Kod artykułu
8-14MM	10	43081.008.014	11-17MM	10	43081.011.017	13-20MM	10	43081.013.020

43080	ABA Opaski zaciskowe do wężu, szerokość 9 mm	Y01A	
Materiał	Stal	 	
Obróbka powierzchni	Ocynkowane		

- Specjalne właściwości opasek zaciskowych do wężu ABA:
- z jednoczęściową NIEBIESKĄ oprawą do zacisnięcia (patent ABA)
 - zawinięte krawędzie opaski nie niszczą wężu
 - opaska jest gładka od wewnętrznej strony, co chroni wąż
 - proste w instalacji i luzowaniu dzięki sześciokątnej rowkowanej główce
 - możliwość wielokrotnego używania



Zakres uchwytu	☒	Kod artykułu	Zakres uchwytu	☒	Kod artykułu	Zakres uchwytu	☒	Kod artykułu
8-14MM	50	43080.008.014	22-32MM	50	43080.022.032	44-56MM	50	43080.044.056
11-17MM	50	43080.011.017	26-38MM	50	43080.026.038	50-65MM	50	43080.050.065
13-20MM	50	43080.013.020	32-44MM	50	43080.032.044	58-75MM	25	43080.058.075
15-24MM	50	43080.015.024	38-50MM	50	43080.038.050	68-85MM	25	43080.068.085
19-28MM	50	43080.019.028						

Opaski zaciskowe do węży, szerokość 12 mm

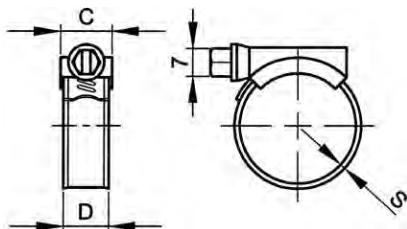

Informacje techniczne

Typ	C (maks.)	D	Moment obrotowy dokręcania w Nm (maks.)	S
13-20	17	12	5	0.8
15-24	17	12	5	0.8
16-27	18	12	4.2	0.8
19-28	17	12	5	0.8
20-32	18	12	5.2	0.8
22-32	17	12	5	0.8
25-40	18	12	5.2	0.8
26-38	17	12	5	0.8
32-44	17	12	6	1
32-50	18	12	6	0.8
38-50	17	12	6	1
40-60	18	12	6	0.8
44-56	17	12	6	1
50-65	17	12	6	1
50-70	18	12	6.8	0.8
58-75	17	12	6	1
60-80	18	12	6.8	0.8
68-85	17	12	6	1
70-90	18	12	6.8	0.8
77-95	17	12	6	1
80-100	18	12	6.8	0.8
87-112	17	12	6	1
90-110	18	12	6.8	0.8
104-138	17	12	6	1
130-165	17	12	6	1
150-180	17	12	6	1
175-205	17	12	6	1
200-231	17	12	6	1
226-256	17	12	6	1
251-282	17	12	6	1
277-307	17	12	6	1

- Numer typu podaje minimalny i maksymalny zakres uchwytu.

Grupy katalogowe

Materiał	Obróbka powierzchni	Kod	Strona
St	Ocynk.	30660	12-8
St	Ocynk.	43011	12-9
St	Ocynk.	Duże Opakowanie 43010	12-9

30660 MAXXFAST Opaski zaciskowe do węży, szerokość 12 mm

MF60

Materiał Stal
Obróbka powierzchni Ocynkowane

MAXXFAST
PROFESSIONAL HARDWARE



Zakres uchwytu	☒	Kod artykułu	Zakres uchwytu	☒	Kod artykułu	Zakres uchwytu	☒	Kod artykułu
16-27MM	50	30660.016.027	40-60MM	25	30660.040.060	70-90MM	10	30660.070.090
20-32MM	50	30660.020.032	50-70MM	25	30660.050.070	80-100MM	10	30660.080.100
25-40MM	50	30660.025.040	60-80MM	25	30660.060.080	90-110MM	10	30660.090.110
32-50MM	50	30660.032.050						

- Tylko pełne opakowania

43011 ABA Opaski zaciskowe do węży, szerokość 12 mm Y01A

Materiał: Stal
Obróbka powierzchni: Ocynkowane

ABA

Zakres uchwytu	☒	Kod artykułu	Zakres uchwytu	☒	Kod artykułu	Zakres uchwytu	☒	Kod artykułu
15-24MM	10	43011.015.024	38-50MM	10	43011.038.050	77-95MM	10	43011.077.095
19-28MM	10	43011.019.028	44-56MM	10	43011.044.056	87-112MM	10	43011.087.112
22-32MM	10	43011.022.032	50-65MM	10	43011.050.065	104-138MM	10	43011.104.138
26-38MM	10	43011.026.038	58-75MM	10	43011.058.075	130-165MM	10	43011.130.165
32-44MM	10	43011.032.044	68-85MM	10	43011.068.085			

43010 ABA Opaski zaciskowe do węży, szerokość 12 mm Y01A

Materiał: Stal
Obróbka powierzchni: Ocynkowane

ABA

Zakres uchwytu	☒	Kod artykułu	Zakres uchwytu	☒	Kod artykułu	Zakres uchwytu	☒	Kod artykułu
15-24MM	50	43010.015.024	50-65MM	50	43010.050.065	150-180MM	10	43010.150.180
19-28MM	50	43010.019.028	58-75MM	25	43010.058.075	175-205MM	10	43010.175.205
22-32MM	50	43010.022.032	68-85MM	25	43010.068.085	200-231MM	10	43010.200.231
26-38MM	50	43010.026.038	77-95MM	25	43010.077.095	226-256MM	10	43010.226.256
32-44MM	50	43010.032.044	87-112MM	25	43010.087.112	251-282MM	10	43010.251.282
38-50MM	50	43010.038.050	104-138MM	25	43010.104.138	277-307MM	10	43010.277.307
44-56MM	50	43010.044.056	130-165MM	25	43010.130.165			

Opaski zaciskowe do węży, szerokość 12 mm ze stali nierdzewnej A2

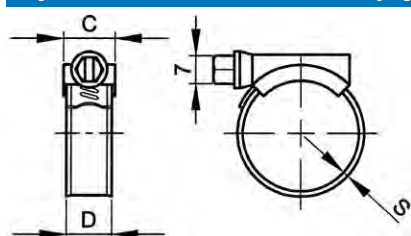



Informacje techniczne				
Typ	C (maks.)	D	Moment obrotowy dokręcania w Nm (maks.)	S
15-24	17	12	5	0.8
16-27	18	12	4.6	0.8
19-28	17	12	5	0.8
20-32	18	12	5.6	0.8
22-32	17	12	5	0.8
25-40	18	12	5.6	0.8
26-38	17	12	5	0.8
32-44	17	12	6	0.8
32-50	18	12	6.5	0.8
38-50	17	12	6	0.8
40-60	18	12	6.5	0.8
44-56	17	12	6	0.8
50-65	17	12	6	0.8
50-70	18	12	7	0.8
58-75	17	12	6	0.8
68-85	17	12	6	0.8
77-95	17	12	6	0.8
87-112	17	12	6	0.8
104-138	17	12	6	0.8
130-165	17	12	6	0.8
150-180	17	12	6	0.8
175-205	17	12	6	0.8
200-231	17	12	6	0.8
226-256	17	12	6	0.8
251-282	17	12	6	0.8
277-307	17	12	6	0.8

- Numer typu podaje minimalny i maksymalny zakres uchwytu.

Grupy katalogowe

Material	Kod	Strona
St.St. A2	30664	12-10
St.St. A2	43020	12-10

30664	MAXXFAST Opaski zaciskowe do węży, szerokość 12 mm ze stali nierdzewnej A2	MF60
Material	Stal nierdzewna A2	  

Zakres uchwytu	☒	Kod artykułu	Zakres uchwytu	☒	Kod artykułu	Zakres uchwytu	☒	Kod artykułu
16-27MM	10	30664.016.027	25-40MM	10	30664.025.040	40-60MM	10	30664.040.060
20-32MM	10	30664.020.032	32-50MM	10	30664.032.050	50-70MM	10	30664.050.070

- Tylko pełne opakowania

43020	ABA Opaski zaciskowe do węży, szerokość 12 mm	Y03A
Material	Stal nierdzewna A2	  

- Specjalne właściwości opasek zaciskowych do węży ABA:
- z jednoczęściową oprawą do zaciśnięcia ze stali nierdzewnej (patent ABA)
 - zawinięte krawędzie opaski nie niszczą węży
 - opaska jest gładka od wewnętrznej strony, co chroni wąż
 - proste w instalacji i luzowaniu z powodu sześciokątnej rowkowanej główki
 - możliwość wielokrotnego używania



Zakres uchwytu	☒	Kod artykułu	Zakres uchwytu	☒	Kod artykułu	Zakres uchwytu	☒	Kod artykułu
15-24MM	10	43020.015.024	50-65MM	10	43020.050.065	150-180MM	5	43020.150.180
19-28MM	10	43020.019.028	58-75MM	10	43020.058.075	175-205MM	5	43020.175.205
22-32MM	10	43020.022.032	68-85MM	10	43020.068.085	200-231MM	5	43020.200.231
26-38MM	10	43020.026.038	77-95MM	10	43020.077.095	226-256MM	5	43020.226.256
32-44MM	10	43020.032.044	87-112MM	5	43020.087.112	251-282MM	3	43020.251.282
38-50MM	10	43020.038.050	104-138MM	5	43020.104.138	277-307MM	3	43020.277.307
44-56MM	10	43020.044.056	130-165MM	5	43020.130.165			

Opaski zaciskowe do węży ze stali nierdzewnej A4

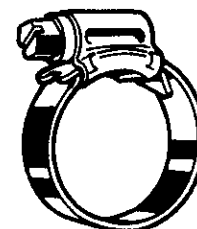
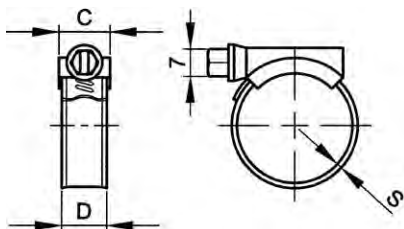

Informacje techniczne

Typ	C	D	Moment dokręcania w Nm	S
8-14	13	9	2.5-3.5	1
11-17	19	9	2.5-3.5	1
13-20	19	9	2.5-3.5	1
15-24	19	12	2.5-3.5	1
19-28	19	12	2.5-3.5	1
22-32	19	12	2.5-3.5	1
26-38	19	12	3.5-4.5	1
32-44	19	12	3.5-4.5	1
38-50	19	12	3.5-4.5	1
44-56	19	12	5-6	1
50-65	19	12	5-6	1
58-75	19	12	5-6	1
68-85	19	12	5-6	1
77-95	19	12	5-6	1
87-112	19	12	5-6	1
104-138	19	12	5-6	1
130-165	19	12	5-6	1
150-180	19	12	5-6	1
175-205	19	12	5-6	1
200-231	19	12	5-6	1
226-256	19	12	5-6	1
251-282	19	12	5-6	1
277-307	19	12	5-6	1

- Numer typu podaje minimalny i maksymalny zakres uchwytu.

43019 AWAB Opaski zaciskowe do węży

Y03A

Materiał Stal nierdzewna A4

ABA



Zakres uchwytu	☒	Kod artykułu	Zakres uchwytu	☒	Kod artykułu	Zakres uchwytu	☒	Kod artykułu
8-14MM D= 9MM	10	43019.008.014	38-50MM D=12MM	10	43019.038.050	130-165MM D=12MM	5	43019.130.165
11-17MM D= 9MM	10	43019.011.017	44-56MM D=12MM	10	43019.044.056	150-180MM D=12MM	5	43019.150.181
13-20MM D= 9MM	10	43019.013.020	50-65MM D=12MM	10	43019.050.065	175-205MM D=12MM	5	43019.180.206
15-24MM D=12MM	10	43019.015.024	58-75MM D=12MM	10	43019.058.075	200-231MM D=12MM	5	43019.205.232
19-28MM D=12MM	10	43019.019.028	68-85MM D=12MM	10	43019.068.085	226-256MM D=12MM	5	43019.231.257
22-32MM D=12MM	10	43019.022.032	77-95MM D=12MM	10	43019.077.095	251-282MM D=12MM	3	43019.256.283
26-38MM D=12MM	10	43019.026.038	87-112MM D=12MM	5	43019.087.112	277-307MM D=12MM	3	43019.282.308
32-44MM D=12MM	10	43019.032.044	104-138MM D=12MM	5	43019.104.138			

Opaski zaciskowe do węży Mini

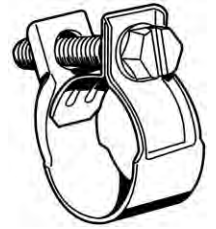
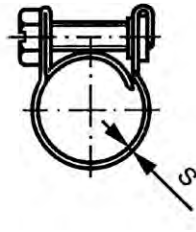

Informacje techniczne

Typ	D	Moment dokręcania w Nm	S	Zakres uchwytu (maks.)	Zakres uchwytu (min.)
6	8.4	0.4	0.5	6	5
8	9	0.4	0.5	8	7
9	10	1	0.5	9	7.5
9.5-10	10	1	0.5	10	9.5
10-11	10	1	0.5	11	10
12-13	10	1	0.5	13	12
13-14	10	1	0.5	14	13
14-15	10	1	0.5	15	14
15-17	10	1	0.5	17	15

30667 MAXXFAST Opaski zaciskowe do węży Mini

MF6A

Materiał Stal
Obróbka powierzchni Cynkowane

MAXXFAST
PROFESSIONAL HARDWARE



Typ	☒	Kod artykułu	Typ	☒	Kod artykułu	Typ	☒	Kod artykułu
6	10	30667.006.001	9,5-10	10	30667.009.010	13-14	10	30667.013.014
8	10	30667.008.001	10-11	10	30667.010.011	14-15	10	30667.014.015
9	10	30667.009.001	12-13	10	30667.012.013	15-17	10	30667.015.017

- Odpowiadające nakrętki sześciokątne mają klasę właściwości \geq I4I.

Opaski zaciskowe do węży Mini

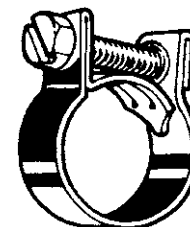
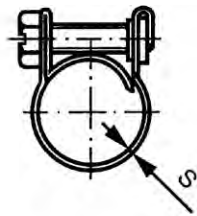

Informacje techniczne

Nr	D	Moment dokręcania w Nm	S	Zakres uchwytu (maks.)	Zakres uchwytu (min.)
No.8	9	1.5	0.5	8.5	7
No.9	9	1.5	0.5	9.5	8
No.10	9	1.5	0.5	10.5	9
No.11	9	1.5	0.5	11.5	9.5
No.12	9	1.5	0.5	12.5	10.5
No.13	9	1.5	0.5	13.5	11.5
No.14	9	1.5	0.5	14.5	12.5
No.15	9	1.5	0.5	15.5	13.5
No.16	9	1.5	0.5	16.5	14
No.17	9	1.5	0.5	17.5	15

- ABA MINI opaski zaciskowe: bezpieczne zaciskanie małych węży o cienkich ściankach, łatwe w montażu i ze stałą nakrętką.

Grupy katalogowe

Materiał	Obróbka powierzchni	Kod	Strona
St	Ocynk.	43063	12-13
St.St. A2		43062	12-13

43063 ABA Opaski zaciskowe do węży MINI

Y03A

Materiał: Stal
Obróbka powierzchni: Ocynkowane

ABA



Nr	☒	Kod artykułu	Nr	☒	Kod artykułu	Nr	☒	Kod artykułu
No.8	25	43063.000.008	No.12	25	43063.000.012	No.15	25	43063.000.015
No.9	25	43063.000.009	No.13	25	43063.000.013	No.16	25	43063.000.016
No.10	25	43063.000.010	No.14	25	43063.000.014	No.17	25	43063.000.017
No.11	25	43063.000.011						

43062 ABA Opaski zaciskowe do węży MINI

Y03A

Materiał: Stal nierdzewna A2

ABA



Nr	☒	Kod artykułu	Nr	☒	Kod artykułu	Nr	☒	Kod artykułu
TYP NR8	25	43062.000.008	TYP NR12	25	43062.000.012	TYP NR15	25	43062.000.015
TYP NR9	25	43062.000.009	TYP NR13	25	43062.000.013	TYP NR16	25	43062.000.016
TYP NR10	25	43062.000.010	TYP NR14	25	43062.000.014	TYP NR17	25	43062.000.017
TYP NR11	25	43062.000.011						

Opaski zaciskowe wzmacnione

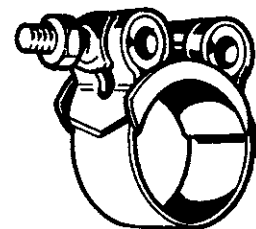
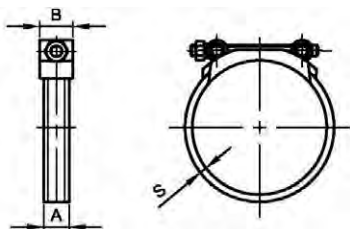

Informacje techniczne

Typ	A	B	S	Typ	A	B	S
29-31	18	19.8	0.6	92-97	25	26.5	1.2
32-35	20	19.8	1	98-103	25	26.5	1.2
36-39	20	22	1	104-112	25	26.5	1.2
40-43	20	22	1	113-121	25	26.5	1.2
44-47	20	24.5	1	122-130	25	26.5	1.2
48-51	20	24.5	1	131-139	25	29	1.2
52-55	20	24.5	1	140-148	25	29	1.2
56-59	20	24.5	1	149-161	25	29	1.5
60-63	20	24.5	1	162-174	25	29	1.5
64-67	25	24.5	1	175-187	25	29	1.5
68-73	25	26.5	1	188-200	25	29	1.5
74-79	25	26.5	1	201-213	25	29	1.5
80-85	25	26.5	1.2	214-226	25	29	1.5
86-91	25	26.5	1.2				

- ABA Heavy Duty to przystosowane do dużych obciążeń opaski zaciskowe z podwiniętymi krawędziami paska.
- Jest stosowana głównie do zaciskania ciężkich, wzmacnianych węży.
- Numer typu podaje minimalny i maksymalny zakres uchwytu.

Dane montażowe



43024 ABA Opaski zaciskowe węży heavy duty

Y03A

Materiał Stal nierdzewna A4

ABA

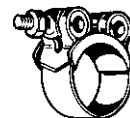

Zakres uchwytu	☒	Kod artykułu	Zakres uchwytu	☒	Kod artykułu	Zakres uchwytu	☒	Kod artykułu
29-31MM	10	43024.029.031	64-67MM	10	43024.064.067	122-130MM	5	43024.122.130
32-35MM	10	43024.032.035	68-73MM	10	43024.068.073	131-139MM	5	43024.131.139
36-39MM	10	43024.036.039	74-79MM	10	43024.074.079	140-148MM	3	43024.140.148
40-43MM	10	43024.040.043	80-85MM	10	43024.080.085	149-161MM	3	43024.149.161
44-47MM	10	43024.044.047	86-91MM	5	43024.086.091	162-174MM	3	43024.162.174
48-51MM	10	43024.048.051	92-97MM	5	43024.092.097	175-187MM	3	43024.175.187
52-55MM	10	43024.052.055	98-103MM	5	43024.098.103	188-200MM	3	43024.188.200
56-59MM	10	43024.056.059	104-112MM	5	43024.104.112	201-213MM	3	43024.201.213
60-63MM	10	43024.060.063	113-121MM	5	43024.113.121	214-226MM	3	43024.214.226

Opaski zaciskowe wzmacnione

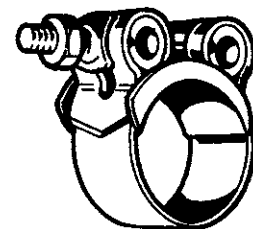
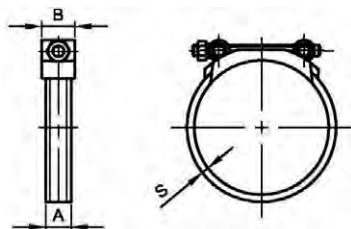

Informacje techniczne

Typ	A	B	S	Typ	A	B	S
29-31	18	20	0.6	104-111	20	22.1	0.8
31-34	18	20	0.6	111-118	20	22.1	0.8
34-37	18	20	0.6	118-125	20	22.1	0.8
37-40	18	20	0.6	125-132	20	22.1	0.8
40-43	18	20	0.6	132-139	20	22.1	0.8
43-47	20	22.1	0.8	139-146	20	22.1	0.8
47-51	20	22.1	0.8	146-153	20	22.1	0.8
51-55	20	22.1	0.8	153-160	20	22.1	0.8
55-59	20	22.1	0.8	160-167	20	22.1	0.8
59-63	20	22.1	0.8	167-174	20	22.1	0.8
63-68	20	22.1	0.8	174-187	30	32.5	1.25
68-73	20	22.1	0.8	187-200	30	32.5	1.25
73-79	20	22.1	0.8	200-213	30	32.5	1.25
79-85	20	22.1	0.8	213-226	30	32.5	1.25
85-91	20	22.1	0.8	226-239	30	32.5	1.25
91-97	20	22.1	0.8	239-252	30	32.5	1.25
97-104	20	22.1	0.8				

- ABA MOCNE to przystosowane do dużych obciążeń opaski zaciskowe z podwiniętymi krawędziami paska.
- Jest stosowana głównie do zaciskania ciężkich, wzmacnianych węży.
- Numer typu podaje minimalny i maksymalny zakres uchwytu.

Dane montażowe



43033 Opaski zaciskowe do węży heavy duty

Y03A

Materiał Stal nierdzewna AISI 430

ABA

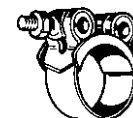

Typ	☒	Kod artykułu	Typ	☒	Kod artykułu	Typ	☒	Kod artykułu
29-31	25	43033.029.031	68-73	25	43033.068.073	139-146	5	43033.139.146
31-34	25	43033.031.034	73-79	25	43033.073.079	146-153	5	43033.146.153
34-37	25	43033.034.037	79-85	25	43033.079.085	153-160	5	43033.153.160
37-40	25	43033.037.040	85-91	10	43033.085.091	160-167	5	43033.160.167
40-43	25	43033.040.043	91-97	10	43033.091.097	167-174	5	43033.167.174
43-47	25	43033.043.047	97-104	10	43033.097.104	174-187	5	43033.174.187
47-51	25	43033.047.051	104-111	10	43033.104.111	187-200	5	43033.187.200
51-55	25	43033.051.055	111-118	10	43033.111.118	200-213	5	43033.200.213
55-59	25	43033.055.059	118-125	10	43033.118.125	213-226	5	43033.213.226
59-63	25	43033.059.063	125-132	5	43033.125.132	226-239	5	43033.226.239
63-68	25	43033.063.068	132-139	5	43033.132.139	239-252	5	43033.239.252

- Materiał: opaska i zacisk AISI430/śruba i nakrętka stal ocynkowana
- Do typu 40-43 śruba sześciokątna M6x40
- Typ 43-47 do 167-174 śruba imbusowa M7x55
- Typ 174-187 do 239-252 śruba sześciokątna M10x80

Opaski zaciskowe do węży Mikro

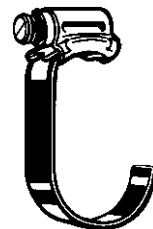
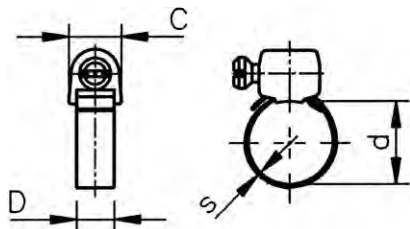

Informacje techniczne

Typ	C	D	Moment dokręcania w Nm	s
6-11	7.5	5	0.5-0.7	0.4
7-11	9	5.5	0.5-0.7	0.5

- Materiał paska stal nierdzewna.
- Numer typu podaje minimalny i maksymalny zakres uchwytu.

43065 ABA Opaski zaciskowe węży MIKRO

Y03A

Materiał Stal
Obróbka powierzchni Ocynkowane

ABA



Zakres uchwytu	Kod artykułu
7-11MM	25 43065.007.011

Zaciski jednooczkowe do węży

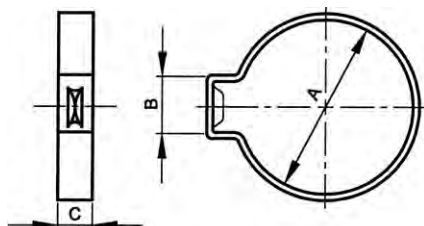

Informacje techniczne

Typ	A	B	C
10-12	12.3	7	6.5
12-14	14	7	6.5
14-16	16.5	8.5	7
16-18	18.5	9.5	7

- Może być łatwo i szybko zainstalowana przy pomocy obcęgi lub szczypiec do zacisków.
- Numer typu podaje minimalny i maksymalny zakres uchwytu.

43074 ABA Zaciski jednooczkowe węży

Y03A

Materiał Stal
Obróbka powierzchni Ocynk, gruba pasywacja Cr³⁺

ABA



Zakres uchwytu	Kod artykułu	Zakres uchwytu	Kod artykułu	Zakres uchwytu	Kod artykułu
10-12MM	50 43074.010.012	14-16MM	50 43074.014.016	16-18MM	50 43074.016.018
12-14MM	50 43074.012.014				

ABA Zaciski dwuoczkowe do węży”

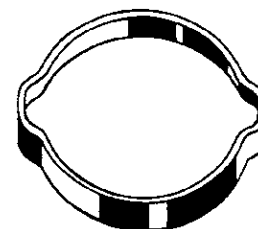
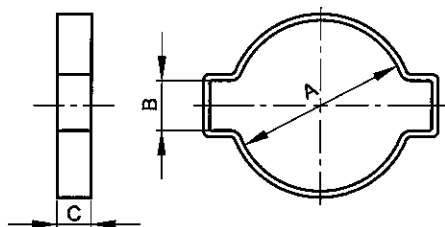

Informacje techniczne

Typ	A	B	C	Typ	A	B	C
5-7	7.3	4.3	6	22-25	25.5	9.1	8.5
7-9	9.3	4.8	6	25-28	28.5	10	9
9-11	11.3	5.3	6.5	28-31	31.5	11	9.5
11-13	13.3	5.8	6.5	31-34	34.5	11	9.5
13-15	15.3	6.3	7	34-37	37.5	11.5	9.5
15-18	18.5	7	7.5	37-40	40.5	12	10
17-20	20.5	7.6	7.5	40-43	43.3	8.5	10
20-23	23.5	8.5	8	43-46	46.3	8.5	10

- Może być łatwo i szybko zainstalowana przy pomocy obcęgi lub szczypiec do zacisków.
- Numer typu podaje minimalny i maksymalny zakres uchwytu.

43076 ABA Zaciski dwuoczkowe do węży”

Y03A

Materiał Stal
Obróbka powierzchni Ocynk, gruba pasywacja Cr³⁺

ABA



Zakres uchwytu	☒	Kod artykułu	Zakres uchwytu	☒	Kod artykułu	Zakres uchwytu	☒	Kod artykułu
5-7MM	50	43076.005.007	17-20MM	50	43076.017.020	34-37MM	50	43076.034.037
7-9MM	50	43076.007.009	20-23MM	50	43076.020.023	37-40MM	50	43076.037.040
9-11MM	50	43076.009.011	22-25MM	50	43076.022.025	40-43MM	50	43076.040.043
11-13MM	50	43076.011.013	25-28MM	50	43076.025.028	43-46MM	50	43076.043.046
13-15MM	50	43076.013.015	28-31MM	50	43076.028.031			
15-18MM	50	43076.015.018	31-34MM	50	43076.031.034			

Opaski zaciskowe do węży" dwuczęściowe

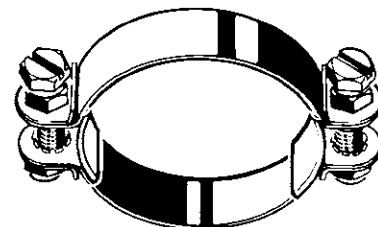
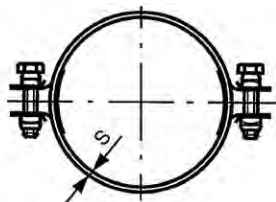
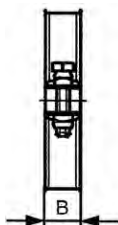

Informacje techniczne

Typ	B	S	Typ	B	S
33-39	20	1	106-116	25	1.25
37-43	20	1	112-122	25	1.25
43-49	20	1	118-128	25	1.25
49-55	20	1	126-136	25	1.25
55-63	20	1	136-146	25	1.25
61-69	20	1	156-166	25	1.25
67-75	20	1	166-176	25	1.25
73-81	20	1	176-186	25	1.25
79-87	20	1	186-196	25	1.25
85-93	20	1	196-206	25	1.25
89-97	20	1	208-218	25	1.25
95-103	20	1	218-228	25	1.25
97-105	20	1	228-238	25	1.25
96-106	25	1.25	238-248	25	1.25
102-112	25	1.25	146-156	25	1.25

- Pasek stalowy grubiej cynkowany z grubością warstwy min. 18µm.
- Numer typu podaje minimalny i maksymalny zakres uchwytu.

Grupy katalogowe

Materiał	Obróbka powierzchni	Kod	Strona
St	Ocynk.	B=20 43025	12-18
St	Ocynk.	B=25 43026	12-18

43025 Opaski zaciskowe do węży" dwuczęściowe

Y03A

Materiał Stal
Obróbka powierzchni Ocynkowane

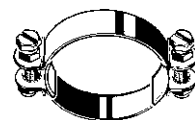

Typ	⊗	Kod artykułu	Typ	⊗	Kod artykułu	Typ	⊗	Kod artykułu
33-39MM	5	43025.033.039	61-69MM	5	43025.061.069	85-93MM	5	43025.085.093
37-43MM	5	43025.037.043	67-75MM	5	43025.067.075	89-97MM	5	43025.089.097
43-49MM	5	43025.043.049	73-81MM	5	43025.073.081	95-103MM	5	43025.095.103
49-55MM	5	43025.049.055	79-87MM	5	43025.079.087	97-105MM	5	43025.097.105
55-63MM	5	43025.055.063						

43026 Opaski zaciskowe do węży" dwuczęściowe

Y03A

Materiał Stal
Obróbka powierzchni Ocynkowane

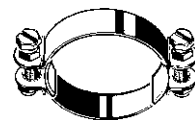

Typ	⊗	Kod artykułu	Typ	⊗	Kod artykułu	Typ	⊗	Kod artykułu
96-106MM	2	43026.096.106	136-146MM	2	43026.136.146	196-206MM	1	43026.196.206
102-112MM	2	43026.102.112	146-156MM	2	43026.146.156	208-218MM	1	43026.208.218
106-116MM	2	43026.106.116	156-166MM	2	43026.156.166	218-228MM	1	43026.218.228
112-122MM	2	43026.112.122	166-176MM	2	43026.166.176	228-238MM	1	43026.228.238
118-128MM	2	43026.118.128	176-186MM	1	43026.176.186	238-248MM	1	43026.238.248
126-136MM	2	43026.126.136	186-196MM	1	43026.186.196			

Zaciski z gumą

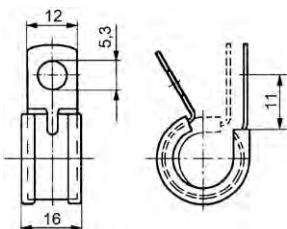

Informacje techniczne

Typ	d	D	Rura ø	Typ	d	D	Rura ø
5	5.3	12	5	19	5.3	12	19
6	5.3	12	6	20	5.3	12	20
8	5.3	12	8	21	5.3	12	21
10	5.3	12	10	22	5.3	12	22
12	5.3	12	12	23	5.3	12	23
13	5.3	12	13	24	5.3	12	24
14	5.3	12	14	25	5.3	12	25
15	5.3	12	15	26	5.3	12	26
16	5.3	12	16	27	5.3	12	27
17	5.3	12	17	28	5.3	12	28
18	5.3	12	18				

30666 MAXXFAST Zaciski z gumą

MF6A

Materiał Stal
Obróbka powierzchni Ocynkowane

MAXXFAST
PROFESSIONAL HARDWARE



Typ rury ø	☒	Kod artykułu	Typ rury ø	☒	Kod artykułu	Typ rury ø	☒	Kod artykułu
5/12	10	30666.050.012	15/12	10	30666.150.012	22/12	10	30666.220.012
6/12	10	30666.060.012	16/12	10	30666.160.012	23/12	10	30666.230.012
8/12	10	30666.080.012	17/12	10	30666.170.012	24/12	10	30666.240.012
10/12	10	30666.100.012	18/12	10	30666.180.012	25/12	10	30666.250.012
12/12	10	30666.120.012	19/12	10	30666.190.012	26/12	10	30666.260.012
13/12	10	30666.130.012	20/12	10	30666.200.012	27/12	10	30666.270.012
14/12	10	30666.140.012	21/12	10	30666.210.012	28/12	10	30666.280.012

- Tylko pełne opakowania

Zaciski z gumą

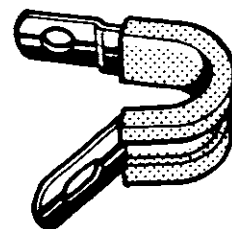
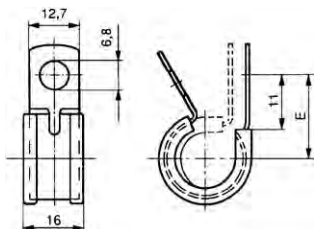

Informacje techniczne

Typ	E	Rura ø	Typ	E	Rura ø
300	14.6	3	314	25.8	25
301	15.4	5	315	27.1	27
302	16.2	6	316	27.9	29
303	17	8	317	28.6	30
304	17.8	10	318	29.4	32
305	18.6	11	319	30.2	33
306	19.4	13	320	31	35
307	20.2	14	321	31.8	37
308	21	16	322	32.6	38
309	21.8	18	323	38	45
310	22.6	19	325	45.5	54
311	23.4	21	326	34	41
312	24.2	22	329	43.5	60
313	25	24			

- Cechy szczególne zacisków z gumą ABA:
- Z profilem gumowym (EPDM)
- Wysoka odporność na wodę, zużycie, wahania temperatury i proces starzenia
- Zwłaszcza do tłumiącego wibracje zawieszania rur, przewodów, obwodów, węży etc.

Grupy katalogowe

Materiał	Obróbka powierzchni	Kod	Strona
St	Ocynk. gor.	43111	12-20
St	Ocynk. gor.	Duże Opakowanie 43110	12-20
St.St. A2		43115	12-21

43111 ABA Zaciski z gumą

Y03A

Materiał Stal
Obróbka powierzchni Ocynkowane na gorąco

ABA



Typ rury ø	⊗	Kod artykułu	Typ rury ø	⊗	Kod artykułu	Typ rury ø	⊗	Kod artykułu
300-3MM	25	43111.000.300	305-11MM	25	43111.000.305	309-18MM	25	43111.000.309
301-5MM	25	43111.000.301	306-13MM	25	43111.000.306	310-19MM	25	43111.000.310
302-6MM	25	43111.000.302	307-14MM	25	43111.000.307	311-21MM	25	43111.000.311
303-8MM	25	43111.000.303	308-16MM	25	43111.000.308	312-22MM	25	43111.000.312
304-10MM	25	43111.000.304						

43110 ABA Zaciski z gumą

Y03A

Materiał Stal
Obróbka powierzchni Ocynkowane na gorąco

ABA

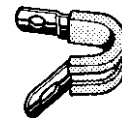

Typ rury ø	⊗	Kod artykułu	Typ rury ø	⊗	Kod artykułu	Typ rury ø	⊗	Kod artykułu
300-3MM	100	43110.000.300	309-18MM	50	43110.000.309	318-32MM	50	43110.000.318
301-5MM	100	43110.000.301	310-19MM	50	43110.000.310	319-33MM	50	43110.000.319
302-6MM	100	43110.000.302	311-21MM	50	43110.000.311	320-35MM	50	43110.000.320
303-8MM	100	43110.000.303	312-22MM	50	43110.000.312	321-37MM	50	43110.000.321
304-10MM	100	43110.000.304	313-24MM	50	43110.000.313	322-38MM	50	43110.000.322
305-11MM	100	43110.000.305	314-25MM	50	43110.000.314	323-45MM	50	43110.000.323
306-13MM	100	43110.000.306	315-27MM	50	43110.000.315	325-54MM	50	43110.000.325
307-14MM	100	43110.000.307	316-29MM	50	43110.000.316	326-41MM	50	43110.000.326
308-16MM	100	43110.000.308	317-30MM	50	43110.000.317	329-60MM	50	43110.000.329

Assembly hole ø = 5,3MM

43115	Zaciski z gumą	Y03A
Materiał	Stal nierdzewna A2	

Typ rury ø	☒	Kod artykułu	Typ rury ø	☒	Kod artykułu	Typ rury ø	☒	Kod artykułu
302-6MM	25	43115.000.006	307-14MM	25	43115.000.014	312-22MM	25	43115.000.023
303-8MM	25	43115.000.008	309-18MM	25	43115.000.018	314-25MM	25	43115.000.026
304-10MM	25	43115.000.010	311-21MM	25	43115.000.021	322-38MM	25	43115.000.040
306-13MM	25	43115.000.013						

Asortyment do opasek zaciskowych do węży



Grupy katalogowe

Kod	Strona
30668	12-21
43055	12-22

30668	MAXXFAST Wieszak na opaski	MFNA

Wymiary	☒	Kod artykułu	
8-70 EMPTY	1	30668.000.005	
8-70 + Hoseclamp	1	30668.000.010	<ul style="list-style-type: none"> Nasz ekskluzywny wieszak na opaski do opasek zaciskowych MaxxFast jest wyposażony w najczęściej używane standardowe opaski zaciskowe, mini opaski zaciskowe oraz specjalnie do nich zaprojektowany wkrętak. <p>Pełna zawartość</p> <p>MaxxFast opaski zaciskowe 9mm OCYNK:</p> <ul style="list-style-type: none"> 8-16mm - 10szt 12-22mm - 10szt 16-27mm - 10szt 20-32mm - 10szt 25-40mm - 10szt 32-50mm - 10szt 40-60mm - 10szt 50-70mm - 10szt <p>MaxxFast opaski zaciskowe mini OCYNK:</p> <ul style="list-style-type: none"> 8mm - 10szt 9mm - 10szt 9,5-10mm - 10szt 10-11mm - 10szt 12-13mm - 10szt 13-14mm - 10szt 14-15mm - 10szt 15-17mm - 10szt <p>MaxxFast wkrętak do opasek zaciskowych hex 7mm - 1szt</p> <ul style="list-style-type: none"> 2 kołki i 2 haki do montażu



ABA

Typ	☒	Kod artykułu	
244C	1	43055.001.803	<ul style="list-style-type: none"> • Stojak wystawowy • Wymiary: 65 x 15 x 23,4 cm • Zawartość: • 12 x 8-14/9 W1 • 12 x 11-17/9 W1 • 12 x 13-20/9 W1 • 24 x 15-24/12 W1 • 12 x 19-28/12 W1 • 12 x 22-32/12 W1 • 12 x 26-38/12 W1 • 12 x 32-44/12 W1 • 12 x 38-50/12 W1 • 12 x 44-56/12 W1 • 12 x 50-65/12 W1 • 10 x Mini 8 C • 10 x Mini 9 C • 10 x Mini 10 C • 10 x Mini 11 C • 10 x Mini 12 C • 10 x Mini 13 C • 10 x Mini 14 C • 10 x Mini 15 C • 10 x Mini 16 C • 10 x Mini 17 C • Elastyczny wkrętak do gniazd sześciokątnych, model normalny 250 mm
270C	1	43055.001.805	<ul style="list-style-type: none"> • W plastikowym opakowaniu. • Wymiary: 40 x 27 x 8,5 cm • Zawartość: • 50 x 8-14/9 W1 • 50 x 11-17/9 W1 • 50 x 13-20/9 W1 • 25 x 15-24/12 W1 • 25 x 19-28/12 W1 • 20 x 22-32/12 W1 • 15 x 26-38/12 W1 • 15 x 32-44/12 W1 • 10 x 38-50/12 W1 • 10 x 44-56/12 W1 • Elastyczny wkrętak do gniazd sześciokątnych, model normalny 250 mm
ABA Display 244 empty	1	43055.790.244	

Elastyczne wkrętki do gniazd sześciokątnych



Grupy katalogowe

Kod	Strona
30669	12-23
43030	12-23

30669 MAXXFAST Narzędzia do opasek zaciskowych

MT2A

MAXXFAST
PROFESSIONAL HARDWARE



Wymiary



Kod artykułu

7 MM 1 [30669.000.100](#)

- Wygodny wkrętek 7 mm sześciokątny do opasek zaciskowych MaxxFast.
- Zgodny ze standardem Euro.
- Ergonomiczny uchwyt dla wygody i wysokiego momentu obrotowego.
- Elastyczny trzonek dla łatwej instalacji lub usunięcia, nawet w ciasnych przestrzeniach.
- Cienkie gniazdo przeznaczone do standardowych opasek zaciskowych (S = 7mm).

43030 ABA Elastyczne wkrętki do gniazd sześciokątnych

Y95A

ABA



Typ



Kod artykułu

Elast	1	43030.001.770	Model normalny
Elast długi	1	43030.001.780	Model długi 600 mm



- Dla obszarów trudno dostępnych.
- Dostarczane z końcówką do gniazd sześciokątnych 7 mm.
- Wyginane pod kątem 90°.
- Odpowiednie dla wszystkich typów opasek zaciskowych ABA i AWAB.

Opaski do układów wydechowych

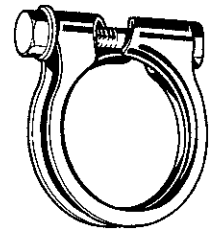
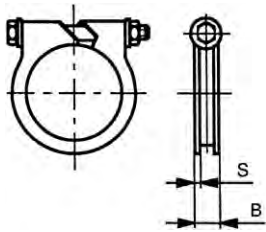

Informacje techniczne

Typ	B	Moment dokręcania w Nm	S	Zakres uchwytu (maks.)	Zakres uchwytu (min.)
R27-1.5	11.5	8-10	1.5	27	24
R30-1.5	11.5	8-10	1.5	30	27
R33-1.5	11.5	8-10	1.5	33	30
R42-2	11.5	8-10	2.0	42	39
R45-2.5	11.5	8-10	2.5	45	42
R48-2.5	12.5	10-15	2.5	48	45
R51-2.5	12.5	10-15	2.5	51	48
R55-2.5	12.5	10-15	2.5	55	52
R58-2.5	12.5	10-15	2.5	58	55

Dane montażowe

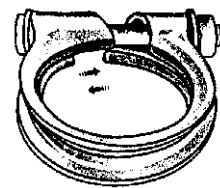
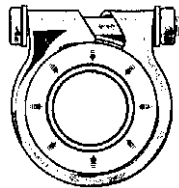

43246 AWAB Opaski do układów wydechowych

Y03A

Materiał Stal

ABA



Typ	☒	Kod artykułu	Typ	☒	Kod artykułu	Typ	☒	Kod artykułu
R27-1,5MM	10	43246.270.001	R42-2MM	10	43246.420.001	R51-2,5MM	10	43246.510.001
R30-1,5MM	10	43246.300.001	R45-2,5MM	10	43246.450.001	R55-2,5MM	10	43246.550.001
R33-1,5MM	10	43246.330.001	R48-2,5MM	10	43246.480.001	R58-2,5MM	10	43246.580.001

Zaciski rurowe 8 mm

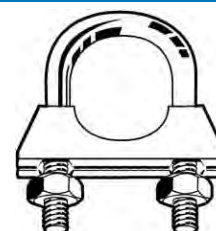
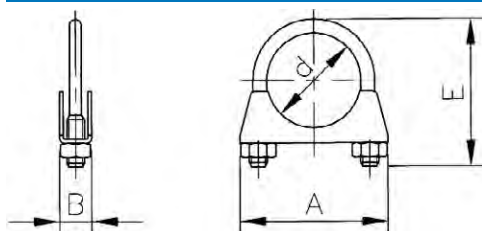

Informacje techniczne

Dla wymiaru nominalnego d	A	B	E	Dla wymiaru nominalnego d	A	B	E
25	50	14.5	52	50	84	13.5	77
26	55	13.5	57	51	76	14.5	76
28	54.5	13.5	56	52	53.5	13.5	77
32	59.5	13.5	59	54	88	13.5	78
35	60	14.5	63	57	82.5	14.5	83
36	63	13.5	68	58	91	13.5	85
38	67	13.5	62	60	94	13.5	84.5
42	72	13.5	68.5	65	99	13.5	89
45	75	13.5	70	70	107	13.5	94
48	79.5	13.5	74	75	115	13.5	102

43241 Zaciski rurowe 8 mm

Y03A

Materiał Stal
Obróbka powierzchni Ocynkowane



Dla wymiaru nominalnego d	☒	Kod artykułu	Dla wymiaru nominalnego d	☒	Kod artykułu	Dla wymiaru nominalnego d	☒	Kod artykułu
26MM	10	43241.260.001	45MM	10	43241.450.001	58MM	10	43241.580.001
28MM	10	43241.280.001	48MM	10	43241.480.001	60MM	10	43241.600.001
32MM	10	43241.320.001	50MM	10	43241.500.001	64/65MM	10	43241.650.001
36MM	10	43241.360.001	51/52MM	10	43241.520.001	70MM	10	43241.700.001
38MM	10	43241.380.001	54MM	10	43241.540.001	75/76MM	10	43241.750.001
42MM	10	43241.420.001						

- W zależności od dostępności wymiary mogą się różnić.

System zacisków



		Szerokość		Grubość	Średnia siła zerwania	Ear-Lokt	Clip	Scru-Lok	J-020	C-001
		IN	mm			Lbs	43272.380.xxx	43273.380.xxx	43274.380.xxx	43276.385.041
43270.380.201		1/4	6.35	0.51	500	211			X	X
43270.380.202		3/8	9.52	0.64	900	212	322	451	X	X
43270.380.203		1/2	12.70	0.76	1500	213	323	452		X
43270.380.204		5/8	15.87	0.76	1875	214	324	453		X
43270.380.205		3/4	19.05	0.76	2250	215	325	454		X
43280.000.203		3/8	9.52	0.64	900	212	322	451	X	X
43280.000.204		1/2	12.70	0.76	1500	213	323	452		X
43280.000.205		5/8	15.87	0.76	1875	214	324	453		X
43280.000.206		3/4	19.05	0.76	2250	215	325	454		X
43271.380.302		3/8	9.52	0.38	450	212	322	451	X	X
43271.380.303		1/2	12.70	0.38	600	213	323	452		X
43271.380.304		5/8	15.87	0.38	750	214	324	453		X
43271.380.305		3/4	19.05	0.38	900	215	325	454		X

Grupy katalogowe

Material		Kod	Strona
St.St.	Opaski typ 201	43270	12-26
St.St.	Opaska typ 201 z zapasem	43280	12-26
St.St.	Zaciski z uchwytem	43272	12-27
St.St.	Opaski VALU	43271	12-27
St.St.	Zaciski do opasek VALU	43273	12-27
St.St.	Zaciski śrubowe	43274	12-27
St.St.	Klamry	43279	12-27
St.St.	Zaciski paskowe	43275	12-28
	Narzędzia	43276	12-28

43270 Opaski typ 201

Material	Stal nierdzewna	BAND-IT®		Y63A

Typ	☒	Kod artykułu	Typ	☒	Kod artykułu	Typ	☒	Kod artykułu
C-202 1/4-30,5M-0,51MM	1	43270.380.201	C-204 1/2-30,5M-0,76MM	1	43270.380.203	C-206 3/4-30,5M-0,76MM	1	43270.380.205
C-203 3/8-30,5M-0,64MM	1	43270.380.202	C-205 5/8-30,5M-0,76MM	1	43270.380.204			

43280 Opaska typ 201 z zapasem

Material	Stal nierdzewna	BAND-IT®		Y63A

Typ	☒	Kod artykułu	Typ	☒	Kod artykułu	Typ	☒	Kod artykułu
C203Y 3/8-30,5M-0,64MM	1	43280.000.203	C205G 5/8-30,5M-0,76MM	1	43280.000.205	C206R 3/4-30,5M-0,76MM	1	43280.000.206
C204B 1/2-30,5M-0,76MM	1	43280.000.204						

43272 Zaciski z uchwytem Y63A

Materiał Stal nierdzewna

BAND-IT®



Typ	☒	Kod artykułu	Typ	☒	Kod artykułu	Typ	☒	Kod artykułu
C-252 1/4-0,38MM	100	43272.380.211	C-254 1/2-0,38MM	100	43272.380.213	C-256 3/4-0,38MM	100	43272.380.215
C-253 3/8-0,38MM	100	43272.380.212	C-255 5/8-0,38MM	100	43272.380.214			

43271 Opaski VALU Y63A

Materiał Stal nierdzewna

BAND-IT®



Typ	☒	Kod artykułu	Typ	☒	Kod artykułu	Typ	☒	Kod artykułu
C-133 3/8-30,5M-0,38MM	1	43271.380.302	C-135 5/8-30,5M-0,38MM	1	43271.380.304	C-136 3/4-30,5M-0,38MM	1	43271.380.305
C-134 1/2-30,5M-0,38MM	1	43271.380.303						

43273 Zaciski do opasek Valu Y63A

Materiał Stal nierdzewna

BAND-IT®



Typ	☒	Kod artykułu	Typ	☒	Kod artykułu	Typ	☒	Kod artykułu
C-153 3/8	100	43273.380.322	C-155 5/8	100	43273.380.324	C-156 3/4	100	43273.380.325
C-154 1/2	100	43273.380.323						

43274 Zaciski śrubowe Y63A

Materiał Stal nierdzewna

BAND-IT®



Typ	☒	Kod artykułu	Typ	☒	Kod artykułu	Typ	☒	Kod artykułu
C-720 1/4	50	43274.380.451	C-724 1/2	25	43274.380.453	C-726 3/4	25	43274.380.454
C-722 3/8	50	43274.380.452						

- Do zacisków typu 201 i taśmy do uszczelniania.

43279 Klamry Y63A

Materiał Stal nierdzewna

BAND-IT®



Typ	☒	Kod artykułu	
D-007 BR-IT MON-TAZ L	50	43279.007.001	<ul style="list-style-type: none"> • Klamra w kształcie litery L-kąt prosty • Do śrub 6mm
D-008 BR-IT 2 SRU-BOWA	50	43279.008.001	<ul style="list-style-type: none"> • Klamra, 2 śruby - prosta



43279 Klamry		←
Typ	☒	Kod artykułu
D-001 1-BT PROSTA	50	43279.380.484 • Klamra z jedną śrubą - prosta
D-021 1-BT ROZSZERZANA	50	43279.380.485 • Klamra z jedną śrubą - rozszerzana



43275 Zaciski paskowe		Y63A
Materiał	Stal nierdzewna	
		BAND-IT®

Typ	☒	Kod artykułu
ZESTAW OPASEK Z ZACISKAMI ŚR.	1	43275.153.001 • Opaska 3,5m (9,5mm szeroka, stal nierdzewna) • 5 Zacisków • 5 Śrub z rowkiem
ZACISKI	10	43275.380.471 • 10 Uszczeltek śrubowych • 10 Zacisków • Nadaje się do opasek C-133 (43271.380.302)
OPASKIE ZAKRĘCANE	1	43275.380.473 • Taśma do uszczelniania 30,5m • 25 Uszczeltek śrubowych • 25 Zacisków



43276 Narzędzia		Y63A
		BAND-IT®

Typ	☒	Kod artykułu
380001 C-001	1	43276.380.001 • NARZĘDZIE TYP C-001 dla opasek od 3/16" do 3/4"
J-020 POKKITII	1	43276.385.041 • NARZĘDZIE TYP J-020 Pok-it dla opasek od 3/16" do 3/8"



Obejmy rurowe (cybanty) typ A

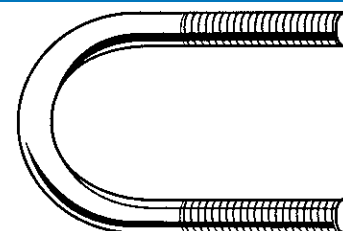
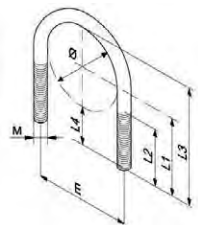

Informacje techniczne

d x L ₃	d	E	L ₁	L ₂	L ₄
M5x37	22	25	26	21	15
M6x33	18	28	24	18	15
M6x37	22	29	26	20	15
M6x42	27	31	29	22	15
M6x49	34	34	32	26	15
M6x62	42	36	41	27	20
M6x68	48	38	44	27	20
M6x85	60	41	55	32	25
M6x101	76	43	63	32	25
M6x114	89	45	70	32	25
M6x144	114	50	87	37	30
M8x37	22	52	26	18	15
M8x42	27	54	29	20	15
M8x49	34	56	32	24	15
M8x62	42	58	41	29	20
M8x68	48	60	44	29	20
M8x85	60	69	55	34	25
M8x101	76	71	63	34	25
M8x114	89	73	70	34	25
M8x132	102	75	81	39	30
M8x144	114	85	87	39	30
M8x170	140	87	100	39	30
M10x42	27	89	29	18	15
M10x49	34	91	32	22	15
M10x62	42	98	41	31	20
M10x68	48	100	44	31	20
M10x85	60	102	55	36	25
M10x101	76	104	63	36	25
M10x114	89	113	70	36	25
M10x132	102	115	81	41	30
M10x144	114	117	87	41	30
M10x170	140	123	100	41	30
M10x203	168	125	119	46	35
M10x259	219	127	150	51	40
M12x85	60	129	55	38	25
M12x101	76	133	63	38	25
M12x114	89	152	70	38	25
M12x132	102	154	81	43	30
M12x144	114	156	87	43	30
M12x170	140	160	100	43	30
M12x203	168	182	119	48	35
M12x259	219	184	150	53	40
M12x313	273	188	177	53	40
M12x364	324	218	202	53	40
M16x144	114	233	87	48	30
M16x170	140	235	100	48	30
M16x203	168	239	119	53	35
M16x259	219	243	150	58	40
M16x313	273	289	177	58	40
M16x364	324	293	202	58	40
M20x234	194	297	137	62	40
M20x259	219	341	150	62	40
M20x313	273	345	177	62	40
M20x364	324	349	202	62	40
M24x364	324	353	202	66	40

Grupy katalogowe

Gwint	Materiał	Obróbka powierzchni	Kod	Strona
M	St	Ocynk.	17260	12-30
M	St.St. A2		17261	12-30
M	St.St. A4		17262	12-30

17260 Obejmy rurowe (cybanty) typ A

F11B

Gwint Metryczny
 Materiał Stal
 Obróbka powierzchni Ocynkowane

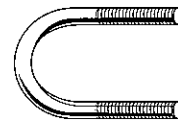

d x l ₃	☒	Kod artykułu	d x l ₃	☒	Kod artykułu	d x l ₃	☒	Kod artykułu
M5x37	1	17260.050.028	M8x132	1	17260.080.113	M12x132	1	17260.120.117
M6x33	1	17260.060.025	M8x144	1	17260.080.125	M12x144	1	17260.120.129
M6x37	1	17260.060.029	M8x170	1	17260.080.152	M12x170	1	17260.120.156
M6x42	1	17260.060.034	M10x42	1	17260.100.038	M12x203	1	17260.120.184
M6x49	1	17260.060.041	M10x49	1	17260.100.045	M12x259	1	17260.120.235
M6x62	1	17260.060.050	M10x62	1	17260.100.054	M12x313	1	17260.120.289
M6x68	1	17260.060.056	M10x68	1	17260.100.060	M12x364	1	17260.120.341
M6x85	1	17260.060.069	M10x85	1	17260.100.073	M16x144	1	17260.160.133
M6x101	1	17260.060.085	M10x101	1	17260.100.089	M16x170	1	17260.160.160
M6x114	1	17260.060.098	M10x114	1	17260.100.102	M16x203	1	17260.160.188
M6x144	1	17260.060.123	M10x132	1	17260.100.115	M16x259	1	17260.160.239
M8x37	1	17260.080.031	M10x144	1	17260.100.127	M16x313	1	17260.160.293
M8x42	1	17260.080.036	M10x170	1	17260.100.154	M16x364	1	17260.160.345
M8x49	1	17260.080.043	M10x203	1	17260.100.182	M20x234	1	17260.200.218
M8x62	1	17260.080.052	M10x259	1	17260.100.233	M20x259	1	17260.200.243
M8x68	1	17260.080.058	M12x85	1	17260.120.075	M20x313	1	17260.200.297
M8x85	1	17260.080.071	M12x101	1	17260.120.091	M20x364	1	17260.200.349
M8x101	1	17260.080.087	M12x114	1	17260.120.104	M24x364	1	17260.240.353
M8x114	1	17260.080.100						

17261 Obejmy rurowe (cybanty) typ A

F11C

Gwint Metryczny
 Materiał Stal nierdzewna A2

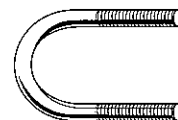

d x l ₃	☒	Kod artykułu	d x l ₃	☒	Kod artykułu	d x l ₃	☒	Kod artykułu
M5x37	1	17261.050.028	M8x132	1	17261.080.113	M12x132	1	17261.120.117
M6x33	1	17261.060.025	M8x144	1	17261.080.125	M12x144	1	17261.120.129
M6x37	1	17261.060.029	M8x170	1	17261.080.152	M12x170	1	17261.120.156
M6x42	1	17261.060.034	M10x42	1	17261.100.038	M12x203	1	17261.120.184
M6x49	1	17261.060.041	M10x49	1	17261.100.045	M12x259	1	17261.120.235
M6x62	1	17261.060.050	M10x62	1	17261.100.054	M12x313	1	17261.120.289
M6x68	1	17261.060.056	M10x68	1	17261.100.060	M12x364	1	17261.120.341
M6x85	1	17261.060.069	M10x85	1	17261.100.073	M16x144	1	17261.160.133
M6x101	1	17261.060.085	M10x101	1	17261.100.089	M16x170	1	17261.160.160
M6x114	1	17261.060.098	M10x114	1	17261.100.102	M16x203	1	17261.160.188
M6x144	1	17261.060.123	M10x132	1	17261.100.115	M16x259	1	17261.160.239
M8x37	1	17261.080.031	M10x144	1	17261.100.127	M16x313	1	17261.160.293
M8x42	1	17261.080.036	M10x170	1	17261.100.154	M16x364	1	17261.160.345
M8x49	1	17261.080.043	M10x203	1	17261.100.182	M20x234	1	17261.200.218
M8x62	1	17261.080.052	M10x259	1	17261.100.233	M20x259	1	17261.200.243
M8x68	1	17261.080.058	M12x85	1	17261.120.075	M20x313	1	17261.200.297
M8x85	1	17261.080.071	M12x101	1	17261.120.091	M20x364	1	17261.200.349
M8x101	1	17261.080.087	M12x114	1	17261.120.104	M24x364	1	17261.240.353
M8x114	1	17261.080.100						

17262 Obejmy rurowe (cybanty) typ A

F11C

Gwint Metryczny
 Materiał Stal nierdzewna A4

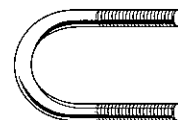

d x l ₃	☒	Kod artykułu	d x l ₃	☒	Kod artykułu	d x l ₃	☒	Kod artykułu
M5x37	1	17262.050.028	M6x62	1	17262.060.050	M6x144	1	17262.060.123
M6x33	1	17262.060.025	M6x68	1	17262.060.056	M8x37	1	17262.080.031
M6x37	1	17262.060.029	M6x85	1	17262.060.069	M8x42	1	17262.080.036
M6x42	1	17262.060.034	M6x101	1	17262.060.085	M8x49	1	17262.080.043
M6x49	1	17262.060.041	M6x114	1	17262.060.098	M8x62	1	17262.080.052

17262 U-bolts type A								
d x l ₃	☒	Kod artykułu	d x l ₃	☒	Kod artykułu	d x l ₃	☒	Kod artykułu
M8x68	1	17262.080.058	M10x132	1	17262.100.115	M12x364	1	17262.120.341
M8x85	1	17262.080.071	M10x144	1	17262.100.127	M16x144	1	17262.160.133
M8x101	1	17262.080.087	M10x170	1	17262.100.154	M16x170	1	17262.160.160
M8x114	1	17262.080.100	M10x203	1	17262.100.182	M16x203	1	17262.160.188
M8x132	1	17262.080.113	M10x259	1	17262.100.233	M16x259	1	17262.160.239
M8x144	1	17262.080.125	M12x85	1	17262.120.075	M16x313	1	17262.160.293
M8x170	1	17262.080.152	M12x101	1	17262.120.091	M16x364	1	17262.160.345
M10x42	1	17262.100.038	M12x114	1	17262.120.104	M20x234	1	17262.200.218
M10x49	1	17262.100.045	M12x132	1	17262.120.117	M20x259	1	17262.200.243
M10x62	1	17262.100.054	M12x144	1	17262.120.129	M20x313	1	17262.200.297
M10x68	1	17262.100.060	M12x170	1	17262.120.156	M20x364	1	17262.200.349
M10x85	1	17262.100.073	M12x203	1	17262.120.184	M24x364	1	17262.240.353
M10x101	1	17262.100.089	M12x259	1	17262.120.235			
M10x114	1	17262.100.102	M12x313	1	17262.120.289			

Obejmy rurowe (cybanty) typ B

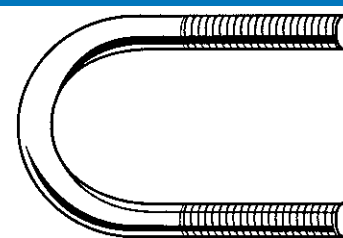
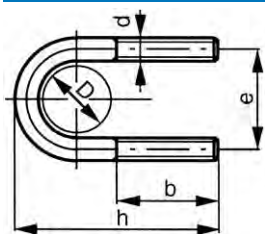

Informacje techniczne				
d x L ₃	b	D (nom. cale)	D (nom. mm)	e
M6x42	-	-	-	-
M6x53	25	3/4	27	34
M6x61	30	1 Inch	34	41
M8x42	20	1/2	22	29
M8x61	30	1 Inch	34	44
M8x65	25	1 Inch	35	48
M8x71	30	3/4	27	36
M8x74	35	1.1/4	42	52
M8x85	40	1.1/2	48	57
M8x99	40	2 Inch	60	71
M10x85	40	1.1/2	48	59
M10x99	40	2 Inch	60	73
M10x112	40	2.1/2	76	89
M12x124	50	3 Inch	89	102
M12x155	50	4 Inch	117	126
M16x140	-	-	-	-
M16x184	60	5 Inch	140	160
M16x209	60	6 Inch	168	186
M16x216	-	-	-	-
M16x266	60	8 Inch	216	240

Grupy katalogowe				
Gwint	Materiał	Obróbka powierzchni	Kod	Strona
M	St	O cynk.	17243	12-31
M	St.St. A2		17567	12-32

17243 Śruby w kształcie U (Kabłąki do rur), wyrób 40G				F11B
Gwint	Metryczny			
Materiał	Stal			
Obróbka powierzchni	O cynkowane			

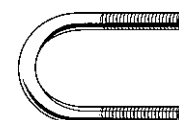

d x h x e x b	☒	Kod artykułu	d x h x e x b	☒	Kod artykułu	d x h x e x b	☒	Kod artykułu
M6X42X29X20	50	17243.060.029	M8X74X52X35	50	17243.080.052	M12X124X102X50	10	17243.120.102
M6X53X34X25	50	17243.060.034	M8X85X57X40	50	17243.080.057	M12X155X126X50	10	17243.120.126
M6X61X41X30	50	17243.060.041						
			M10X85X59X40	25	17243.100.059			
			M10X99X73X40	25	17243.100.073	M16X184X160X60	3	17243.160.160
			M10X112X89X40	25	17243.100.089	M16X209X186X60	3	17243.160.186

17243 Śruby w kształcie U (Kabłąki do rur), wyrób 40G

d x h x e x b	☒	Kod artykułu
M16X266X240X60	2	17243.160.240

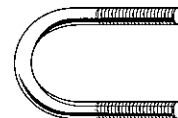
17567 Śruby w kształcie U (Kabłąki do rur), wyrób 40R
F11C
Gwint Metryczny
Materiał Stal nierdzewna A2

d x h x e x b	☒	Kod artykułu	d x h x e x b	☒	Kod artykułu	d x h x e x b	☒	Kod artykułu
M6X42X29X20	25	17567.060.029	M8X61X44X30	25	17567.080.044	M8X85X57X40	25	17567.080.057
M6X53X34X25	25	17567.060.034	M8X74X52X35	25	17567.080.052	M8X99X71X40	25	17567.080.073

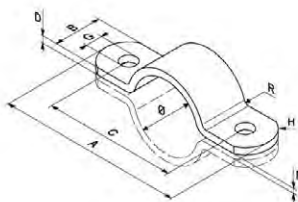
Obejmy do rur - połówkowe

Informacje techniczne

ø	A	C	F	G	H	R
12	63	38	3	9	18	4
16	68	43	3	9	18	4
18	72	47	3	9	18	4
20	75	50	3	9	18	4
22	80	55	3	9	18	4
25	88	58	4	11	18	5
27	92	62	4	11	18	5
30	93	63	4	11	18	5
32	95	65	4	11	18	5
34	98	68	4	11	18	5
38	104	74	4	11	18	5
42	126	86	5	14	22	6
45	132	92	5	14	22	6
48	135	95	5	14	22	6
54	140	100	5	14	22	6
57	145	105	5	14	22	6
60	150	110	5	14	22	6
63	150	110	5	14	22	6
66	155	115	5	14	22	6
70	162	122	5	14	22	6
76	165	125	5	14	22	6
80	172	132	5	14	22	6
83	175	135	5	14	22	6
89	180	140	5	14	22	6
95	185	145	5	14	22	6
102	200	160	5	14	38	10
108	210	170	5	14	38	10
114	215	175	5	14	38	10
120	220	180	5	14	38	10
127	225	185	5	14	38	10
133	255	205	6	18	60	12
140	260	210	6	18	60	12
146	266	216	6	18	60	12
152	272	222	6	18	60	12
159	285	235	6	18	60	12
165	290	240	6	18	60	12
168	293	243	6	18	60	12
174	300	250	6	18	60	12
178	304	254	6	18	60	12
191	320	270	6	18	60	12

Informacje techniczne						
ø	A	C	F	G	H	R
194	326	276	6	18	60	12
203	335	285	6	18	60	12
216	344	294	6	18	60	12
219	356	306	6	18	60	12
226	362	312	6	18	60	12
241	370	320	6	22	60	12
245	376	326	6	22	60	12
253	385	335	6	22	60	12
267	400	350	6	22	60	12
273	410	360	6	22	60	12
300	430	380	6	22	60	12
318	470	410	8	22	60	12
324	480	420	8	22	60	12
356	515	455	8	22	60	12
368	545	470	12	22	60	22
406	585	510	12	22	60	22
420	600	525	12	22	60	22
457	655	580	12	22	60	22
508	680	605	12	22	60	22
520	690	615	12	22	60	22
559	733	658	12	22	60	22
610	795	720	12	22	60	22
660	845	770	12	22	60	22
710	895	820	12	22	60	22
762	947	872	12	22	60	22
812	975	920	12	22	60	22
914	1124	1034	15	27	60	22

Grupy katalogowe			
Materiał	Obróbka powierzchni	Kod	Strona
St		64500	12-33
St	Ocynk. gor.	64507	12-34

64500 Obejmy do rur - półowkowe
F11B

Materiał	Stal		
----------	------	--	---

ø	⊗	Kod artykułu	ø	⊗	Kod artykułu	ø	⊗	Kod artykułu
12MM	1	64500.012.001	89MM	1	64500.089.001	245MM	1	64500.245.001
16MM	1	64500.016.001	95MM	1	64500.095.001	253MM	1	64500.253.001
18MM	1	64500.018.001	102MM	1	64500.102.001	267MM	1	64500.267.001
20MM	1	64500.020.001	108MM	1	64500.108.001	273MM	1	64500.273.001
22MM	1	64500.022.001	114MM	1	64500.114.001	300MM	1	64500.300.001
25MM	1	64500.025.001	120MM	1	64500.120.001	318MM	1	64500.318.001
27MM	1	64500.027.001	127MM	1	64500.127.001	324MM	1	64500.324.001
30MM	1	64500.030.001	133MM	1	64500.133.001	356MM	1	64500.356.001
32MM	1	64500.032.001	140MM	1	64500.140.001	368MM	1	64500.368.001
34MM	1	64500.034.001	146MM	1	64500.146.001	406MM	1	64500.406.001
38MM	1	64500.038.001	152MM	1	64500.152.001	420MM	1	64500.420.001
42MM	1	64500.042.001	159MM	1	64500.159.001	457MM	1	64500.457.001
45MM	1	64500.045.001	165MM	1	64500.165.001	508MM	1	64500.508.001
48MM	1	64500.048.001	168MM	1	64500.168.001	520MM	1	64500.520.001
54MM	1	64500.054.001	174MM	1	64500.174.001	559MM	1	64500.559.001
57MM	1	64500.057.001	178MM	1	64500.178.001	610MM	1	64500.610.001
60MM	1	64500.060.001	191MM	1	64500.191.001	660MM	1	64500.660.001
63MM	1	64500.063.001	194MM	1	64500.194.001	710MM	1	64500.710.001
66MM	1	64500.066.001	203MM	1	64500.203.001	762MM	1	64500.762.001
70MM	1	64500.070.001	216MM	1	64500.216.001	812MM	1	64500.812.001
76MM	1	64500.076.001	219MM	1	64500.219.001	914MM	1	64500.914.001
80MM	1	64500.080.001	226MM	1	64500.226.001			
83MM	1	64500.083.001	241MM	1	64500.241.001			

64507 Obejmy do rur - połówkowe
F11B
Materiał Stal
Obróbka powierzchni Ocynkowane na gorąco

ø	☒	Kod artykułu	ø	☒	Kod artykułu	ø	☒	Kod artykułu
12MM	1	64507.012.001	80MM	1	64507.080.001	219MM	1	64507.219.001
16MM	1	64507.016.001	83MM	1	64507.083.001	226MM	1	64507.226.001
18MM	1	64507.018.001	89MM	1	64507.089.001	241MM	1	64507.241.001
20MM	1	64507.020.001	95MM	1	64507.095.001	245MM	1	64507.245.001
22MM	1	64507.022.001	102MM	1	64507.102.001	253MM	1	64507.253.001
25MM	1	64507.025.001	108MM	1	64507.108.001	267MM	1	64507.267.001
27MM	1	64507.027.001	114MM	1	64507.114.001	273MM	1	64507.273.001
30MM	1	64507.030.001	120MM	1	64507.120.001	300MM	1	64507.300.001
32MM	1	64507.032.001	127MM	1	64507.127.001	318MM	1	64507.318.001
34MM	1	64507.034.001	133MM	1	64507.133.001	324MM	1	64507.324.001
38MM	1	64507.038.001	140MM	1	64507.140.001	356MM	1	64507.356.001
42MM	1	64507.042.001	152MM	1	64507.152.001	368MM	1	64507.368.001
45MM	1	64507.045.001	159MM	1	64507.159.001	406MM	1	64507.406.001
48MM	1	64507.048.001	165MM	1	64507.165.001	420MM	1	64507.420.001
54MM	1	64507.054.001	168MM	1	64507.168.001	457MM	1	64507.457.001
57MM	1	64507.057.001	178MM	1	64507.178.001	508MM	1	64507.508.001
60MM	1	64507.060.001	191MM	1	64507.191.001	520MM	1	64507.520.001
63MM	1	64507.063.001	194MM	1	64507.194.001	610MM	1	64507.610.001
66MM	1	64507.066.001	203MM	1	64507.203.001	710MM	1	64507.710.001
70MM	1	64507.070.001	216MM	1	64507.216.001	812MM	1	64507.812.001
76MM	1	64507.076.001						

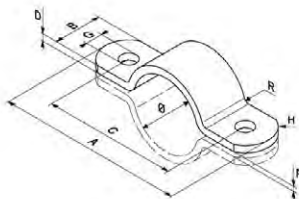
Obejmy do rur - połówkowe nierdzewne

Informacje techniczne

ø	A	C	F	G	H	R
12	63	39	3	7	20	3
16	67	43	3	7	20	3
18	69	45	3	7	20	3
20	71	47	3	7	20	3
22	73	49	3	7	20	3
25	76	52	3	7	20	3
27	78	54	3	7	20	3
30	81	57	3	7	20	3
32	83	59	3	7	20	3
34	85	61	3	7	20	3
38	89	65	3	7	20	3
42	102	74	3	10	25	4
45	105	77	3	10	25	4
48	108	80	3	10	25	4
51	112	83	3	10	25	4
54	114	86	3	10	25	4
57	117	89	3	10	25	4
60	120	92	3	10	25	4
63	123	95	3	10	25	4
66	126	98	3	10	25	4
70	138	110	4	10	30	4
76	144	116	4	10	30	4
80	148	120	4	10	30	4
83	151	123	4	10	30	4
89	157	129	4	10	30	4
95	163	135	4	10	30	4
102	170	142	4	10	30	4
108	176	148	4	10	30	4
114	182	154	4	10	30	4

Informacje techniczne						
ø	A	C	F	G	H	R
120	188	160	4	10	30	4
127	195	167	4	10	30	4
133	218	182	5	12	40	5
140	225	189	5	12	40	5
146	231	195	5	12	40	5
152	237	201	5	12	40	5
159	244	208	5	12	40	5
165	250	214	5	12	40	5
168	253	217	5	12	40	5
174	259	223	5	12	40	5
178	263	227	5	12	40	5
191	276	240	5	12	40	5
194	279	243	5	12	40	5
203	288	252	5	12	40	5
216	301	265	5	12	40	5
219	304	268	5	12	40	5
226	311	275	5	12	40	5
241	341	301	5	14	40	8
245	345	305	5	14	40	8
253	353	313	5	14	40	8
267	367	327	5	14	40	8
273	373	333	5	14	40	8
300	400	360	5	14	40	8
318	418	378	5	14	40	8
324	424	384	5	14	40	8
356	456	416	5	14	40	8
368	468	428	5	14	40	8
406	506	466	5	14	40	8
420	520	480	5	14	40	8
457	557	517	5	14	40	8
508	608	568	5	14	40	8
520	620	580	5	14	40	8
559	659	619	5	14	40	8
610	710	670	5	14	40	8

Grupy katalogowe		
Material	Kod	Strona
St.St. A2	64503	12-35
St.St. A4	64504	12-36

64503 **Obejmy do rur - połówkowe nierdzewne** **F11B**

Material Stal nierdzewna A2





ø	⊗	Kod artykułu	ø	⊗	Kod artykułu	ø	⊗	Kod artykułu
12MM	1	64503.012.001	76MM	1	64503.076.001	203MM	1	64503.203.001
16MM	1	64503.016.001	80MM	1	64503.080.001	216MM	1	64503.216.001
18MM	1	64503.018.001	83MM	1	64503.083.001	219MM	1	64503.219.001
20MM	1	64503.020.001	89MM	1	64503.089.001	226MM	1	64503.226.001
22MM	1	64503.022.001	95MM	1	64503.095.001	241MM	1	64503.241.001
25MM	1	64503.025.001	102MM	1	64503.102.001	245MM	1	64503.245.001
27MM	1	64503.027.001	108MM	1	64503.108.001	253MM	1	64503.253.001
30MM	1	64503.030.001	114MM	1	64503.114.001	267MM	1	64503.267.001
32MM	1	64503.032.001	120MM	1	64503.120.001	273MM	1	64503.273.001
34MM	1	64503.034.001	127MM	1	64503.127.001	300MM	1	64503.300.001
38MM	1	64503.038.001	133MM	1	64503.133.001	318MM	1	64503.318.001
42MM	1	64503.042.001	140MM	1	64503.140.001	324MM	1	64503.324.001
45MM	1	64503.045.001	146MM	1	64503.146.001	356MM	1	64503.356.001
48MM	1	64503.048.001	152MM	1	64503.152.001	368MM	1	64503.368.001
51MM	1	64503.051.001	159MM	1	64503.159.001	406MM	1	64503.406.001
54MM	1	64503.054.001	165MM	1	64503.165.001	420MM	1	64503.420.001
57MM	1	64503.057.001	168MM	1	64503.168.001	457MM	1	64503.457.001
60MM	1	64503.060.001	174MM	1	64503.174.001	508MM	1	64503.508.001
63MM	1	64503.063.001	178MM	1	64503.178.001	520MM	1	64503.520.001
66MM	1	64503.066.001	191MM	1	64503.191.001	559MM	1	64503.559.001
70MM	1	64503.070.001	194MM	1	64503.194.001	610MM	1	64503.610.001

Materiał Stal nierdzewna A4

ø	☒	Kod artykułu	ø	☒	Kod artykułu	ø	☒	Kod artykułu
12MM	1	64504.012.001	76MM	1	64504.076.001	203MM	1	64504.203.001
16MM	1	64504.016.001	80MM	1	64504.080.001	216MM	1	64504.216.001
18MM	1	64504.018.001	83MM	1	64504.083.001	219MM	1	64504.219.001
20MM	1	64504.020.001	89MM	1	64504.089.001	226MM	1	64504.226.001
22MM	1	64504.022.001	95MM	1	64504.095.001	241MM	1	64504.241.001
25MM	1	64504.025.001	102MM	1	64504.102.001	245MM	1	64504.245.001
27MM	1	64504.027.001	108MM	1	64504.108.001	253MM	1	64504.253.001
30MM	1	64504.030.001	114MM	1	64504.114.001	267MM	1	64504.267.001
32MM	1	64504.032.001	120MM	1	64504.120.001	273MM	1	64504.273.001
34MM	1	64504.034.001	127MM	1	64504.127.001	300MM	1	64504.300.001
38MM	1	64504.038.001	133MM	1	64504.133.001	318MM	1	64504.318.001
42MM	1	64504.042.001	140MM	1	64504.140.001	324MM	1	64504.324.001
45MM	1	64504.045.001	146MM	1	64504.146.001	356MM	1	64504.356.001
48MM	1	64504.048.001	152MM	1	64504.152.001	368MM	1	64504.368.001
51MM	1	64504.051.001	159MM	1	64504.159.001	406MM	1	64504.406.001
54MM	1	64504.054.001	165MM	1	64504.165.001	420MM	1	64504.420.001
57MM	1	64504.057.001	168MM	1	64504.168.001	457MM	1	64504.457.001
60MM	1	64504.060.001	174MM	1	64504.174.001	508MM	1	64504.508.001
63MM	1	64504.063.001	178MM	1	64504.178.001	520MM	1	64504.520.001
66MM	1	64504.066.001	191MM	1	64504.191.001	559MM	1	64504.559.001
70MM	1	64504.070.001	194MM	1	64504.194.001	610MM	1	64504.610.001

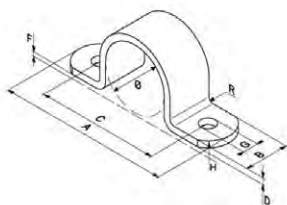
Obejmy do rur, stalowe



Informacje techniczne

ø	A	C	F	G	H	R
22	80	55	3	9	18	4
27	92	62	4	11	18	5
34	98	68	4	11	18	5
42	126	86	5	14	22	6
48	135	95	5	14	22	6
60	150	110	5	14	22	6
70	162	122	5	14	22	6
76	165	125	5	14	22	6
89	180	140	5	14	22	6
102	200	160	5	14	38	10
114	215	175	5	14	38	10
140	260	210	6	18	60	12
194	326	276	6	18	60	12
219	356	306	6	18	60	12
168	293	243	6	18	60	12
273	410	360	6	22	60	12
324	480	420	8	22	60	12

Grupy katalogowe

Materiał	Obróbka powierzchni	Kod	Strona
St		64501	12-37
St	Ocynk. gor.	64502	12-37

64501 Obejmy do rur, stalowe F11B

Material: Stal



Ø	⊠	Kod artykułu	Ø	⊠	Kod artykułu	Ø	⊠	Kod artykułu
22MM	1	64501.022.001	60MM	1	64501.060.001	114MM	1	64501.114.001
27MM	1	64501.027.001	70MM	1	64501.070.001	140MM	1	64501.140.001
34MM	1	64501.034.001	76MM	1	64501.076.001	194MM	1	64501.194.001
42MM	1	64501.042.001	89MM	1	64501.089.001	219MM	1	64501.219.001
48MM	1	64501.048.001	102MM	1	64501.102.001			

64502 Obejmy do rur, stalowe F11B

Material: Stal
Obróbka powierzchni: Ocynkowane na gorąco



Ø	⊠	Kod artykułu	Ø	⊠	Kod artykułu	Ø	⊠	Kod artykułu
22MM	1	64502.022.001	60MM	1	64502.060.001	168MM	1	64502.168.001
27MM	1	64502.027.001	76MM	1	64502.076.001	219MM	1	64502.219.001
42MM	1	64502.042.001	89MM	1	64502.089.001	273MM	1	64502.273.001
48MM	1	64502.048.001	114MM	1	64502.114.001	324MM	1	64502.324.001

Obejmy do rur, stal nierdzewna

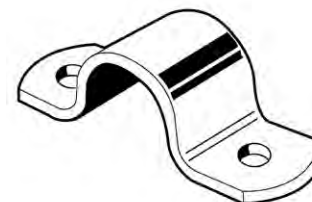
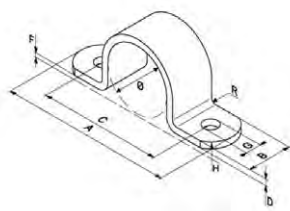

Informacje techniczne

Ø	A	C	F	G	H	R
12	63	39	3	7	20	3
16	67	43	3	7	20	3
18	69	45	3	7	20	3
20	71	47	3	7	20	3
22	73	49	3	7	20	3
25	76	52	3	7	20	3
27	78	54	3	7	20	3
30	81	57	3	7	20	3
32	83	59	3	7	20	3
34	85	61	3	7	20	3
38	89	65	3	7	20	3
42	102	74	3	10	25	4
45	105	77	3	10	25	4
48	108	80	3	10	25	4
57	117	89	3	10	25	4
60	120	92	3	10	25	4
70	138	110	4	10	30	4
76	144	116	4	10	30	4
89	157	129	4	10	30	4
102	170	142	4	10	30	4
108	176	148	4	10	30	4
114	182	154	4	10	30	4
120	188	160	4	10	30	4
127	195	167	4	10	30	4
133	218	182	5	12	40	5
140	225	189	5	12	40	5
152	237	201	5	12	40	5
159	244	208	5	12	40	5
168	253	217	5	12	40	5

Informacje techniczne

ø	A	C	F	G	H	R
191	276	240	5	12	40	5
219	304	268	5	12	40	5
241	341	301	5	14	40	8
273	373	333	5	14	40	8
324	424	384	5	14	40	8
368	468	428	5	14	40	8
406	506	466	5	14	40	8
457	557	517	5	14	40	8
520	620	580	5	14	40	8
610	710	670	5	14	40	8

Grupy katalogowe

Material	Kod	Strona
St.St. A2	64505	12-38
St.St. A4	64506	12-38

64505 Obejmy do rur, stal nierdzewna F11B

Material Stal nierdzewna A2



ø	⊗	Kod artykułu	ø	⊗	Kod artykułu	ø	⊗	Kod artykułu
12MM	1	64505.012.001	48MM	1	64505.048.001	152MM	1	64505.152.001
16MM	1	64505.016.001	57MM	1	64505.057.001	159MM	1	64505.159.001
18MM	1	64505.018.001	60MM	1	64505.060.001	168MM	1	64505.168.001
20MM	1	64505.020.001	70MM	1	64505.070.001	191MM	1	64505.191.001
22MM	1	64505.022.001	76MM	1	64505.076.001	219MM	1	64505.219.001
25MM	1	64505.025.001	89MM	1	64505.089.001	241MM	1	64505.241.001
27MM	1	64505.027.001	102MM	1	64505.102.001	273MM	1	64505.273.001
30MM	1	64505.030.001	108MM	1	64505.108.001	324MM	1	64505.324.001
32MM	1	64505.032.001	114MM	1	64505.114.001	368MM	1	64505.368.001
34MM	1	64505.034.001	120MM	1	64505.120.001	406MM	1	64505.406.001
38MM	1	64505.038.001	127MM	1	64505.127.001	457MM	1	64505.457.001
42MM	1	64505.042.001	133MM	1	64505.133.001	520MM	1	64505.520.001
45MM	1	64505.045.001	140MM	1	64505.140.001	610MM	1	64505.610.001

64506 Obejmy do rur, stal nierdzewna F11B

Material Stal nierdzewna A4



ø	⊗	Kod artykułu	ø	⊗	Kod artykułu	ø	⊗	Kod artykułu
12MM	1	64506.012.001	48MM	1	64506.048.001	152MM	1	64506.152.001
16MM	1	64506.016.001	57MM	1	64506.057.001	159MM	1	64506.159.001
18MM	1	64506.018.001	60MM	1	64506.060.001	168MM	1	64506.168.001
20MM	1	64506.020.001	70MM	1	64506.070.001	191MM	1	64506.191.001
22MM	1	64506.022.001	76MM	1	64506.076.001	219MM	1	64506.219.001
25MM	1	64506.025.001	89MM	1	64506.089.001	241MM	1	64506.241.001
27MM	1	64506.027.001	102MM	1	64506.102.001	273MM	1	64506.273.001
30MM	1	64506.030.001	108MM	1	64506.108.001	324MM	1	64506.324.001
32MM	1	64506.032.001	114MM	1	64506.114.001	368MM	1	64506.368.001
34MM	1	64506.034.001	120MM	1	64506.120.001	406MM	1	64506.406.001
38MM	1	64506.038.001	127MM	1	64506.127.001	457MM	1	64506.457.001
42MM	1	64506.042.001	133MM	1	64506.133.001	520MM	1	64506.520.001
45MM	1	64506.045.001	140MM	1	64506.140.001	610MM	1	64506.610.001

Kołpaki ozdobne

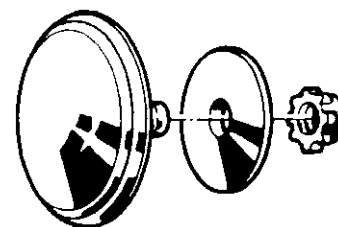

- Montowane na kartonowej karcie demonstracyjnej z podkładką powiększoną i nakrętką plastikową.

Grupy katalogowe

Material	Obróbka powierzchni	Kolor	Kod	Strona
Plastik		Czarny	72110	12-39
Plastik	Chrom.	Beż	72100	12-39

72110 Kołpaki ozdobne		Y92E
Material	Plastik	
Kolor	Czarny	

d	☒	Kod artykułu	d	☒	Kod artykułu	d	☒	Kod artykułu
13-21-29 (6-22 ASS/S)	25	72110.001.770	18MM (6-21E/S)	25	72110.180.001	29MM (6-21C/S)	25	72110.320.001
13MM (6-21/S)	25	72110.130.001	21MM (6-21B/S)	25	72110.220.001	42MM (6-21D/S)	12	72110.400.001

- ASS/S (6-22), zawartość:
- 13mm - 10 sztuk.
- 21mm - 5 sztuk.
- 29mm - 10 sztuk.

72100 Kołpaki ozdobne		Y92E
Material	Plastik	
Obróbka powierzchni	Chromowany	
Kolor	Beż	

d	☒	Kod artykułu	d	☒	Kod artykułu	d	☒	Kod artykułu
13-21-29 (6-22 ASS)	25	72100.001.770	21MM (6-21B)	25	72100.220.001	42MM (6-21D)	12	72100.400.001
18MM (6-21E)	25	72100.180.001	29MM (6-21C)	25	72100.320.001			

- ASS (6-22), zawartość:
- 13mm - 10 sztuk.
- 21mm - 5 sztuk.
- 29mm - 10 sztuk.

Nasadki uszczelniające wciskane

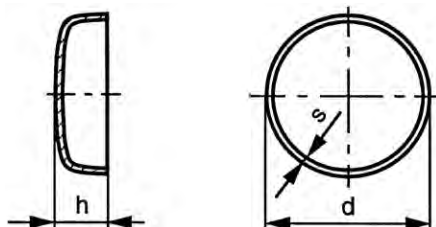

DIN ≈443

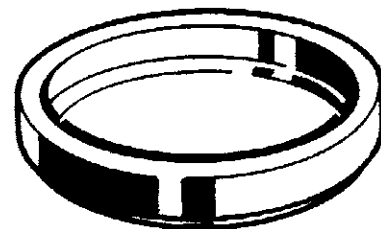

Informacje techniczne

d (zc10)	h (js16)	s	d (zc10)	h (js16)	s
8	3	0.75	28	9	1.6
10	3	0.75	30	9	1.6
12	4	1	36	11	1.6
14	5	1	38	12	1.6
16	5	1	40	12	1.6
18	6	1	45	14	1.6
20	6	1	50	15	1.6
22	7	1.6	52	16	2
24 (#DIN)	7	1.6	56	17	2
25	8	1.6			

72150 Nasadki uszczelniające wciskane

Y92D

Materiał Stal
Obróbka powierzchni O cynkowane

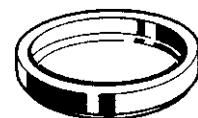

d	☒	Kod artykułu	d	☒	Kod artykułu	d	☒	Kod artykułu
8MM	10	72150.080.001	22MM	10	72150.220.001	38MM	10	72150.380.001
10MM	10	72150.100.001	24MM	10	72150.240.001	40MM	10	72150.400.001
12MM	10	72150.120.001	25MM	10	72150.250.001	45MM	10	72150.450.001
14MM	10	72150.140.001	28MM	10	72150.280.001	50MM	10	72150.500.001
16MM	10	72150.160.001	30MM	10	72150.300.001	52MM	10	72150.520.001
18MM	10	72150.180.001	36MM	10	72150.360.001	56MM	10	72150.560.001
20MM	10	72150.200.001						

Zaślepki zamykające

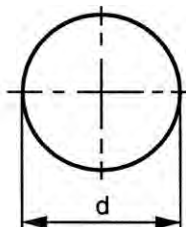
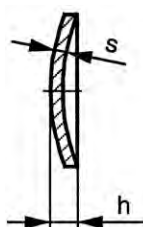

DIN ≈470



Informacje techniczne

d (js11)	h	s	d (js11)	h	s
10	2.67	1.6	32	4.95	2
12	2.77	1.6	34	5.11	2
14	2.94	1.6	36	5.36	2
16	3.11	1.6	38	5.6	2
18	3.28	1.6	40	5.7	2
20	3.45	1.6	45	6.15	2
22	4.09	2	50	6.62	2
25	4.38	2	52	6.66	2
28	4.53	2	56	7.06	2
30	4.77	2			

72160 Zaślepki zamykające

Y92D

Materiał Stal
Obróbka powierzchni O cynkowane



d	☒	Kod artykułu	d	☒	Kod artykułu	d	☒	Kod artykułu
10MM	20	72160.100.001	25MM	20	72160.250.001	38MM	20	72160.380.001
12MM	20	72160.120.001	28MM	20	72160.280.001	40MM	20	72160.400.001
14MM	20	72160.140.001	30MM	20	72160.300.001	45MM	20	72160.450.001
16MM	20	72160.160.001	32MM	20	72160.320.001	50MM	20	72160.500.001
18MM	20	72160.180.001	34MM	20	72160.340.001	52MM	20	72160.520.001
20MM	20	72160.200.001	36MM	20	72160.360.001	56MM	20	72160.560.001
22MM	20	72160.220.001						

Smarowniczki kulkowe ciśnieniowe z główką stożkową - kątowe, typ A/B/C, metryczne

DIN ≈71412



- Zewnętrzny gwint metryczny stożkowy zgodn. ≈ DIN 158.

Grupy katalogowe

Gwint	Materiał	Obróbka powierzchni	Kod	Strona
M	St	Ocyнк.	72210	12-42
M	St.St. A1		72213	12-42

72210 Smarowniczki kulkowe ciśnieniowe z główką stożkową - kątowe, typ A/B/C, metryczne Y05A

Gwint	Metryczny
Materiał	Stal
Obróbka powierzchni	Ocyńkowane



d	☒	Kod artykułu	d	☒	Kod artykułu	d	☒	Kod artykułu
M6-45°	100	72210.060.045	M8-90°	100	72210.080.090	M10-180°	100	72210.100.180
M6-90°	100	72210.060.090	M8-180°	100	72210.080.180	M12-45°	50	72210.120.045
M6-180°	100	72210.060.180	M10-45°	100	72210.100.045	M12-90°	50	72210.120.090
M8-45°	100	72210.080.045	M10-90°	100	72210.100.090	M12-180°	50	72210.120.180

72213 Smarowniczki kulkowe ciśnieniowe z główką stożkową - kątowe, typ A/B/C, metryczne Y05A

Gwint	Metryczny
Materiał	Stal nierdzewna A1



d	☒	Kod artykułu	d	☒	Kod artykułu	d	☒	Kod artykułu
M6-45°	50	72213.060.045	M8-45°	50	72213.080.045	M10-45°	50	72213.100.045
M6-90°	50	72213.060.090	M8-90°	50	72213.080.090	M10-90°	50	72213.100.090
M6-180°	50	72213.060.180	M8-180°	50	72213.080.180	M10-180°	50	72213.100.180

Smarowniczki kulkowe ciśnieniowe z główką stożkową - wciskane, typ A/B/C (A=180°/B=45°/C=90°)

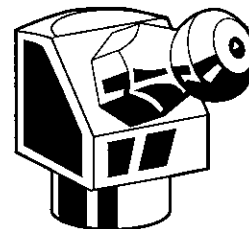

- Otwór wiercony, tolerancja w stali – 0,25 do 0,3 mm, aluminium 0,15 do 0,2 mm i w odlewach – 0,1 mm.

72230 Smarowniczki kulkowe ciśnieniowe z główką stożkową - wciskane, typ A/B/C							Y05A	
Materiał		Stal						
Obróbka powierzchni		Ocynkowane						
d	☒	Kod artykułu	d	☒	Kod artykułu	d	☒	Kod artykułu
6MM-45°	100	72230.060.045	8MM-45°	100	72230.080.045	10MM-45°	100	72230.100.045
6MM-90°	100	72230.060.090	8MM-90°	100	72230.080.090	10MM-90°	100	72230.100.090
6MM-180°	100	72230.060.180	8MM-180°	100	72230.080.180	10MM-180°	100	72230.100.180

Smarowniczki kulkowe ciśnieniowe lejkowe - proste, metryczne drobnozwojne

DIN ≈3405 A



72170 Smarowniczki kulkowe ciśnieniowe lejkowe - proste, metryczne drobnozwojne							Y05A	
Gwint		Metryczny drobnozwojny						
Materiał		Stal						
Obróbka powierzchni		Ocynkowane						
d	☒	Kod artykułu	d	☒	Kod artykułu	d	☒	Kod artykułu
M6X0,75	100	72170.060.075	M8X1,00	100	72170.080.100	M10X1,00	100	72170.100.100
M6X1,00	100	72170.060.100	M8X1,25	100	72170.080.125			

Smarowniczki kulkowe ciśnieniowe z główką płaską - proste, metryczne (drobnozwojne)

DIN ≈3404 A

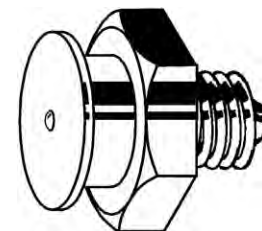



72186 Smarowniczki kulkowe ciśnieniowe z główką płaską - proste, metryczne (drobnozwojne)		Y05A	
Gwint	Metryczny drobnozwojny		
Materiał	Stal		
Obróbka powierzchni	Ocynkowane		
		 	
d x P	☒ Kod artykułu	d x P	☒ Kod artykułu
M6X0,75	100 72186.060.075	M8X1,00	100 72186.080.100
M6X1,00	100 72186.060.100	M8X1,25	100 72186.080.125
		M10X1,00	100 72186.100.100
		M10X1,50	100 72186.100.150

Smarowniczki stożkowe metryczne drobnozwojne (A=180°/B=45°/C=90°)

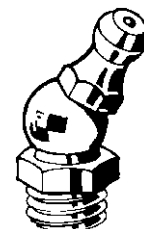
DIN ≈71412 A/B/C



- Metryczny drobny gwint zewnętrzny zgodn. ≈ DIN 158.

72220 Smarowniczki stożkowe metryczne drobnozwojne (A=180°/B=45°/C=90°)		Y05A	
Gwint	Metryczny drobnozwojny		
Materiał	Stal		
Obróbka powierzchni	Ocynkowane		
		 	
d	☒ Kod artykułu	d	☒ Kod artykułu
M8X1,00-45°	100 72220.080.045	M12X1,50-45°	50 72220.120.045
M8X1,00-90°	100 72220.080.090	M12X1,50-90°	50 72220.120.090
M8X1,00-180°	100 72220.080.180	M12X1,50-180°	50 72220.120.180

Smarowniczki kulkowe ciśnieniowe z główką stożkową - (A=180°/B=45°/C=90°)

DIN ≈71412 A/B/C



- Wewnętrzny gwint metryczny bardzo drobnostrojny stożkowy zgodn. ≈ DIN 158.

72221 Smarowniczki kulkowe ciśnieniowe z główką stożkową - (A=180°/B=45°/C=90°)							Y05A	
Gwint	Metryczny bardzo drobnostrojny							
Materiał	Stal							
Obróbka powierzchni	Ocynkowane							
d	☒	Kod artykułu	d	☒	Kod artykułu	d	☒	Kod artykułu
M6X0,75-45°	100	72221.060.045	M8X0,75-90°	100	72221.080.090	M10X1,00-180°	100	72221.100.180
M6X0,75-90°	100	72221.060.090	M8X0,75-180°	100	72221.080.180	M12X1,00-45°	50	72221.120.045
M6X0,75-180°	100	72221.060.180	M10X1,00-45°	100	72221.100.045	M12X1,00-90°	50	72221.120.090
M8X0,75-45°	100	72221.080.045	M10X1,00-90°	100	72221.100.090	M12X1,00-180°	50	72221.120.180

Smarowniczki kulkowe ciśnieniowe z główką stożkową - (A=180°/B=45°/C=90°)

DIN ≈71412 A/B/C

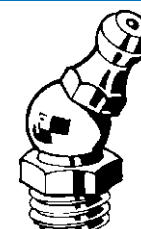

- Zewnętrzny gwint rurowy stożkowy zgodn. ≈ DIN 3858.

Grupy katalogowe

Gwint	Materiał	Obróbka powierzchni	Kod	Strona
R	St	Ocynk.	72240	12-45
R	St.St.		72243	12-45

72240 Smarowniczki kulkowe ciśnieniowe z główką stożkową - (A=180°/B=45°/C=90°)							Y05A	
Gwint	Rurowy							
Materiał	Stal							
Obróbka powierzchni	Ocynkowane							
d	☒	Kod artykułu	d	☒	Kod artykułu	d	☒	Kod artykułu
1/8-45°	100	72240.031.045	1/4-90°	50	72240.063.090	3/8-180°	25	72240.096.180
1/8-90°	100	72240.031.090	1/4-180°	50	72240.063.180	1/2-45°	25	72240.127.045
1/8-180°	100	72240.031.180	3/8-45°	25	72240.096.045	1/2-90°	25	72240.127.090
1/4-45°	50	72240.063.045	3/8-90°	25	72240.096.090	1/2-180°	25	72240.127.180

72243 Smarowniczki kulkowe ciśnieniowe z główką stożkową - (A=180°/B=45°/C=90°)							Y05A	
Gwint	Rurowy							
Materiał	Stal nierdzewna							
Obróbka powierzchni								
d	☒	Kod artykułu	d	☒	Kod artykułu	d	☒	Kod artykułu
1/8-45°	50	72243.031.045	1/8-180°	50	72243.031.180	1/4-90°	50	72243.063.090
1/8-90°	50	72243.031.090	1/4-45°	50	72243.063.045	1/4-180°	50	72243.063.180

Smarowniczki kulkowe ciśnieniowe z główką stożkową UNF - (A=180°/B=45°/C=90°)

DIN ≈71412 A/B/C



72260		Smarowniczki kulkowe ciśnieniowe z główką stożkową UNF - (A=180°/B=45°/C=90°)				Y05A		
Gwint		Całowy, zunifikowany drobnozwojny (UNF)						
Materiał		Stal						
Obróbka powierzchni		Ocynkowane						
d	✉	Kod artykułu	d	✉	Kod artykułu	d	✉	Kod artykułu
1/4-45°	100	72260.063.045	5/16-90°	100	72260.079.090	3/8-180°	100	72260.096.180
1/4-90°	100	72260.063.090	5/16-180°	100	72260.079.180	1/2-45°	50	72260.127.045
1/4-180°	100	72260.063.180	3/8-45°	100	72260.096.045	1/2-90°	50	72260.127.090
5/16-45°	100	72260.079.045	3/8-90°	100	72260.096.090	1/2-180°	50	72260.127.180

Smarowniczki kulkowe ciśnieniowe z główką płaską - proste, gwint rurowy walcowy G

DIN ≈3404 A

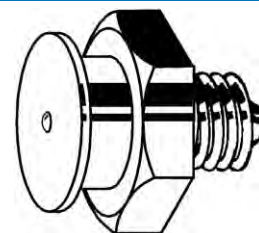

- Gwint rurowy walcowy zgodn. z DIN ISO 228-1.

72185		Smarowniczki kulkowe ciśnieniowe z główką płaską - proste, gwint rurowy walcowy G				Y05A		
Gwint		Rurowy						
Materiał		Stal						
Obróbka powierzchni		Ocynkowane						
d	✉	Kod artykułu	d	✉	Kod artykułu	d	✉	Kod artykułu
1/8	100	72185.031.001	1/4	100	72185.063.001	3/8	100	72185.096.001

Przeguby kulowe

DIN 71802 CS

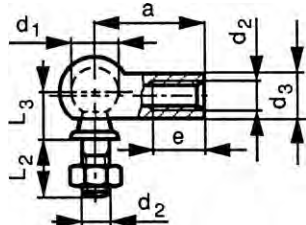

Informacje techniczne

d ₂	a	d ₁	d ₃	e (min.)	L ₂	L ₃	Obciążenie statyczne w kN	P
M5	22	8	8	10.2	10.2	9	0.3	0.8
M6	25	10	10	11.5	12.5	11	0.7	1
M8	30	13	13	14	16.5	13	1.5	1.25
M10	35	16	16	15.5	20	16	2	1.5
M12 (#DIN)	35	16	16	15.5	20	16	2	1.75
M14	45	19	22	21.5	28	20	3	1.5
M16 (#DIN)	45	19	22	21.5	28	20	3	2

- Cechy szczególne przegubów kulowych:
- Są dostarczane z gwintem WEWNĘTRZNYM prawo- lub lewozwojnym.
- Wyposażone w panewkę kulistą zgodn. z DIN 71805 typ B, czop kulisty zgodn. z DIN 71803 typ A z pierścieniem sprężynującym zabezpieczającym zgodn. z DIN 71805 typ S i nakrętkę sześciokątną zgodn. z DIN 934

Grupy katalogowe

Gwint	Materiał	Obróbka powierzchni		Kod	Strona
M	St	Ocynk.	prawy	57425	12-47
M.drob.	St	Ocynk.	prawy	57426	12-47
M	St	Ocynk.	lewy	57475	12-47
M.drob.	St	Ocynk.	lewy	57476	12-48

57425 Złącze kulowe z wewnętrznym gwintem prawym

L11A

Gwint: Metryczny
Materiał: Stal
Obróbka powierzchni: Ocynkowane



d ₂	Kod artykułu	d ₂	Kod artykułu	d ₂	Kod artykułu
M5	5 57425.050.001	M8	5 57425.080.001	M12	5 57425.120.001
M6	5 57425.060.001	M10	5 57425.100.001	M16	1 57425.160.001

57426 Złącze kulowe z wewnętrznym gwintem prawym

L11A

Gwint: Metryczny drobnoszwojny
Materiał: Stal
Obróbka powierzchni: Ocynkowane



d ₂	Kod artykułu
M14X1,50	5 57426.140.150

57475 Złącze kulowe z wewnętrznym gwintem lewym

L11A

Gwint: Metryczny
Materiał: Stal
Obróbka powierzchni: Ocynkowane



d ₂	Kod artykułu	d ₂	Kod artykułu	d ₂	Kod artykułu
M5	5 57475.050.001	M8	5 57475.080.001	M12	5 57475.120.001
M6	5 57475.060.001	M10	5 57475.100.001	M16	1 57475.160.001

57476	Złącze kulowe z wewnętrznym gwintem lewym	L11A
Gwint	Metryczny drobnozwojny	
Materiał	Stal	
Obróbka powierzchni	Ocynkowane	

d₂	☒ Kod artykułu
M14X1,50	5 57476.140.150

Przeguby Cardana, złącze pojedyncze

DIN 808 E

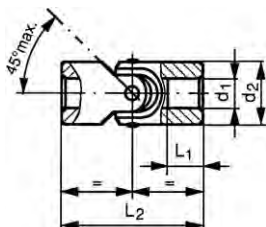

Informacje techniczne

d ₁ (H7)	d ₂ (k11)	L ₁	L ₂	Md (maks.) w Nm
8 (#DIN)	13	12	42	6
10	16	15	52	8
12	20	18	62	20
16	25	22	74	30
20	32	25	86	60
25	40	32	108	160
32	50	40	132	290

- MD maks = maksymalny dopuszczalny moment obrotowy

57510	Przeguby Cardana, złącze pojedyncze	L11A
Materiał	Stal automatowa	

d ₁ x d ₂ x L ₂	☒	Kod artykułu	d ₁ x d ₂ x L ₂	☒	Kod artykułu	d ₁ x d ₂ x L ₂	☒	Kod artykułu
8X13X42MM	1	57510.080.013	16X25X74MM	1	57510.160.025	25X40X108MM	1	57510.250.040
10X16X52MM	1	57510.100.016	20X32X86MM	1	57510.200.032	32X50X132MM	1	57510.320.050
12X20X62MM	1	57510.120.020						

Przeguby Cardana, złącze podwójne

DIN 808 D

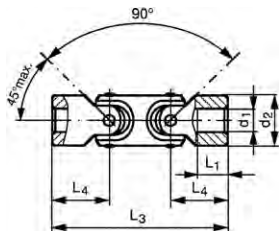

Informacje techniczne

d ₁ (H7)	d ₂ (k11)	L ₁	L ₃	L ₄	Md (maks.) w Nm
8 (#DIN)	13	12	60	21	6
10	16	15	74	26	8
12	20	18	88	31	20
16	25	22	104	37	30
20	32	25	124	43	60
25	40	32	156	54	160

- MD maks = maksymalny dopuszczalny moment obrotowy

57560 Przeguby Cardana, złącze podwójne

L11A

Materiał Stal automatowa



d ₁ x d ₂ x L ₃	☒	Kod artykułu	d ₁ x d ₂ x L ₃	☒	Kod artykułu	d ₁ x d ₂ x L ₃	☒	Kod artykułu
8X13X60MM	1	57560.080.013	12X20X88MM	1	57560.120.020	20X32X124MM	1	57560.200.032
10X16X74MM	1	57560.100.016	16X25X104MM	1	57560.160.025	25X40X156MM	1	57560.250.040

Przeguby widelkowe ze sworzniem sprężynującym, typ ES

DIN 71752

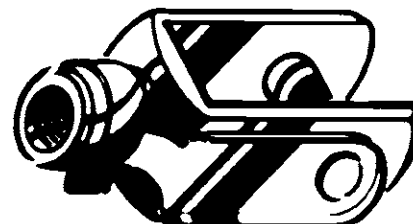
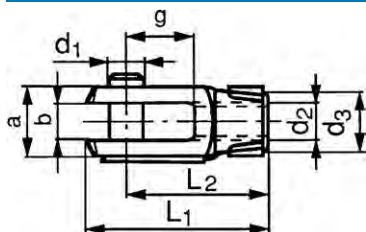

Informacje techniczne

d ₁ x g	a	b (B13)	d ₂	d ₃	L ₁	L ₂
4x8	8	4	M4	8	21	16
5x10	10	5	M5	9	26	20
5x20	10	5	M5	9	36	30
6x12	12	6	M6	10	31	24
6x24	12	6	M6	10	43	36
8x16	16	8	M8	14	42	32
8x32	16	8	M8	14	58	48
10x20	20	10	M10	18	52	40
10x40	20	10	M10	18	72	60
12x24	24	12	M12	20	62	48
12x48	24	12	M12	20	86	72
14x28	27	14	M14	24	72	56
14x56	27	14	M14	24	101	85
16x32	32	16	M16	26	83	64
16x64	32	16	M16	26	115	96
20x40 (#DIN)	40	20	M20	34	105	80

- Cechy szczególne połączeń widelkowych:
- Są dostarczane ze sworzniem sprężynującym typ ES.
- Z uwagi na zaczep sprężynowy połączenia przegubowe mogą być wykorzystane znacznie szybciej i łatwiej bez narzędzi niż w przypadku metody tradycyjnej wykorzystującej sworzeń ze zmniejszonym łbem zgodn. z DIN 1434, zawleczką zgodn. z DIN 94 i podkładką okrągłą do sworznii zgodn. z DIN 1440.
- Typowe zastosowania połączeń widelkowych to wycieraczki szyb samochodowych, hamulec odciągający gaz, czy też pręty łączące (wiązary) i przenoszące ruchy prostoliniowe.
- Tolerancja d₁ = H9/h11.

Grupy katalogowe

Gwint	Materiał	Obróbka powierzchni	Kod	Strona
M	Stal automatowa	Ocynk.	57580	12-50
M	Stal automatowa	Ocynk. lewy	57578	12-50

57580 Przeguby widelkowe ze sworzniem sprężynującym, typ ES

L11A

Gwint Metryczny
 Materiał Stal automatowa
 Obróbka powierzchni Ocynkowane



$d_1 \times g$	☒	Kod artykułu	$d_1 \times g$	☒	Kod artykułu	$d_1 \times g$	☒	Kod artykułu
5X10MM	5	57580.050.010	8X32MM	5	57580.080.032	14X28MM	2	57580.140.028
5X20MM	5	57580.050.020	10X20MM	5	57580.100.020	14X56MM	2	57580.140.056
6X12MM	5	57580.060.012	10X40MM	5	57580.100.040	16X32MM	2	57580.160.032
6X24MM	5	57580.060.024	12X24MM	2	57580.120.024	16X64MM	1	57580.160.064
8X16MM	5	57580.080.016	12X48MM	2	57580.120.048	20X40MM	1	57580.200.040

57578 Złącza rozwidlone, gwint lewy

L11A

Gwint Metryczny DIN 71752 LH
 Materiał Stal automatowa
 Obróbka powierzchni Ocynkowane



$d_1 \times g$	☒	Kod artykułu	$d_1 \times g$	☒	Kod artykułu	$d_1 \times g$	☒	Kod artykułu
5X20MM	5	57578.050.020	8X32MM	5	57578.080.032	12X48MM	2	57578.120.048
6X12MM	5	57578.060.012	10X20MM	5	57578.100.020	14X28MM	2	57578.140.028
6X24MM	5	57578.060.024	10X40MM	5	57578.100.040	16X32MM	2	57578.160.032
8X16MM	5	57578.080.016	12X24MM	2	57578.120.024	20X40MM	1	57578.200.040

Główki cięgł łozysk przegubowych z gwintem wewnętrznym, typ SFC

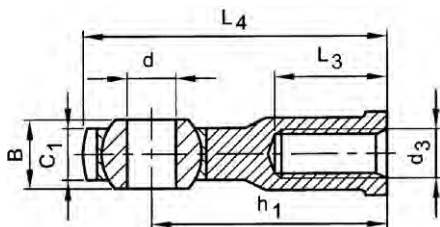

DIN 648 B
 ISO 12240-4

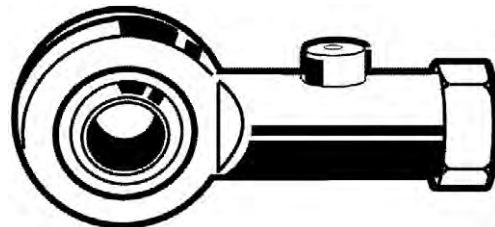

Informacje techniczne

Typ	SFC5	SFC6	SFC8	SFC10	SFC12	SFC14	SFC16
B	8	9	12	14	16	19	21
C_1 (maks.)	7.5	7.5	9.5	11.5	12.5	14.5	15.5
d (H7)	5	6	8	10	12	14	16
d_2 (maks.)	18	20	24	28	32	36	42
d_3	M5	M6	M8	M10	M12	M14	M16
d_4 (maks.)	9	10	12.5	15	17.5	20	22
d_5 (maks.)	12	13	16	19	22	25	27
h_1	27	30	36	43	50	57	64
L_3 (min.)	8	9	12	15	18	21	24
L_4 (maks.)	37	41	49	58	67	76	86
L_5 (maks.)	4	5	5	6.5	6.5	8	8
Obciążenie statyczne (C^0) w N	6 000	7 000	12 000	14 500	17 000	24 000	28 500
s	9	11	14	17	19	22	22
$\alpha \approx$	13	13	13	13	13	15	15

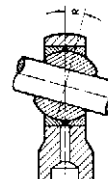
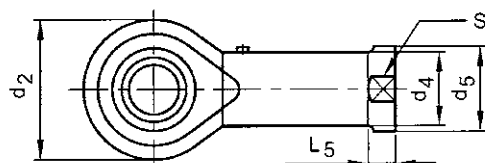

Grupy katalogowe

Gwint	Materiał		Kod	Strona
M	St	prawy	57605	12-51
M	St	lewy	57655	12-51

57605 Końcówki pręta okrągłe pod łożysko ślizgowe z gwintem wewnętrznym prawym

L11A

Gwint
Materiał

Metryczny
Stal



Typ	☒	Kod artykułu	Typ	☒	Kod artykułu	Typ	☒	Kod artykułu
5	1	57605.050.001	10	1	57605.100.001	14	1	57605.140.001
6	1	57605.060.001	12	1	57605.120.001	16	1	57605.160.001
8	1	57605.080.001						

57655 Końcówki pręta okrągłe pod łożysko ślizgowe z gwintem wewnętrznym lewym

L11A

Gwint
Materiał

Metryczny
Stal



Typ	☒	Kod artykułu	Typ	☒	Kod artykułu	Typ	☒	Kod artykułu
5	1	57655.050.001	10	1	57655.100.001	14	1	57655.140.001
6	1	57655.060.001	12	1	57655.120.001	16	1	57655.160.001
8	1	57655.080.001						

Końcówki pręta okrągłe pod łożysko ślizgowe z gwintem zewnętrznym

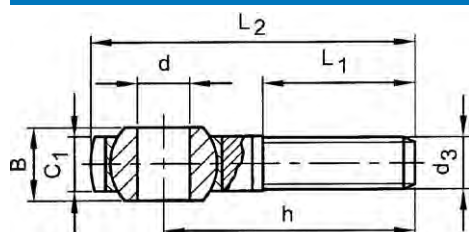

DIN 648 A
ISO 12240-4

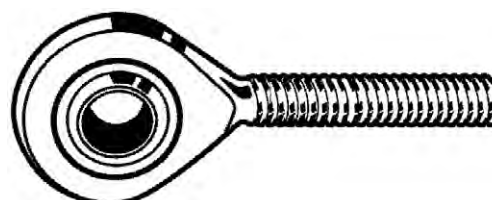

Informacje techniczne

Typ	SMC 5	SMC 6	SMC 8	SMC 10	SMC 12	SMC 14	SMC 16
B	8	9	12	14	16	19	21
C ₁ (maks.)	7.5	7.5	9.5	11.5	12.5	14.5	15.5
d (H7)	5	6	8	10	12	14	16
d ₂ (maks.)	18	20	24	28	32	36	42
d ₃	M5	M6	M8	M10	M12	M14	M16
h	33	36	42	48	54	60	66
L ₁ (min.)	19	21	25	28	32	36	37
L ₂ (maks.)	43	47	55	63	71	79	88
Obciążenie statyczne (C°) w N	3 000	4 000	8 000	13 000	17 000	24 000	28 500
α ° ≈	13	13	13	13	13	15	15

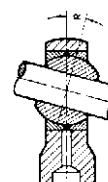
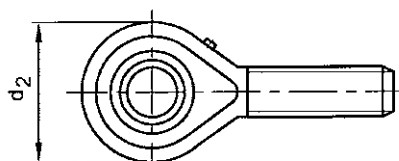

Grupy katalogowe

Gwint	Materiał	Obróbka powierzchni		Kod	Strona
M	St	Ocynk.	prawy	57600	12-52
M	St	Ocynk.	lewy	57650	12-52

57600	Końcówki pręta okrągłe pod łożysko ślizgowe z gwintem zewnętrznym typu SMC prawym	L11A
Gwint	Metryczny	
Materiał	Stal	
Obróbka powierzchni	Ocynkowane	

Typ	☒	Kod artykułu	Typ	☒	Kod artykułu	Typ	☒	Kod artykułu
5MM	1	57600.050.001	10MM	1	57600.100.001	14MM	1	57600.140.001
6MM	1	57600.060.001	12MM	1	57600.120.001	16MM	1	57600.160.001
8MM	1	57600.080.001						

57650	Końcówki pręta okrągłe pod łożysko ślizgowe z gwintem zewnętrznym typu SMC lewym	L11A
Gwint	Metryczny	
Materiał	Stal	
Obróbka powierzchni	Ocynkowane	

Typ	☒	Kod artykułu	Typ	☒	Kod artykułu	Typ	☒	Kod artykułu
5MM	1	57650.050.001	10MM	1	57650.100.001	14MM	1	57650.140.001
6MM	1	57650.060.001	12MM	1	57650.120.001	16MM	1	57650.160.001
8MM	1	57650.080.001						

Łączniki

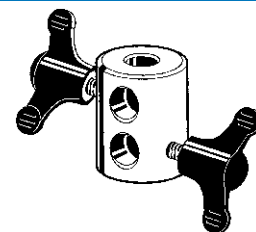
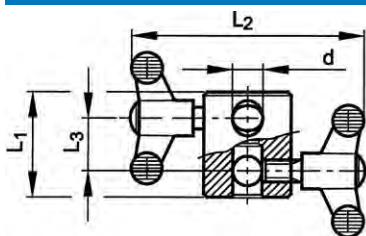

Informacje techniczne

d	L ₁	L ₂	L ₃
10	40	90	20
12	44	90	20
16	56	126	24

57007	Łączniki	W03A
Materiał	Aluminium	

d	☒	Kod artykułu	d	☒	Kod artykułu	d	☒	Kod artykułu
10MM	1	57007.100.001	12MM	1	57007.120.001	16MM	1	57007.160.001

Łączniki zaciskowe

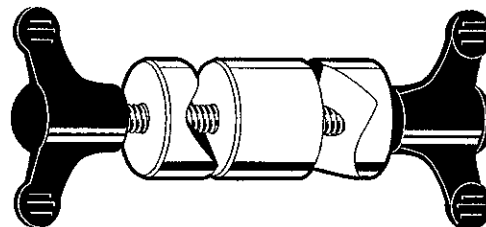
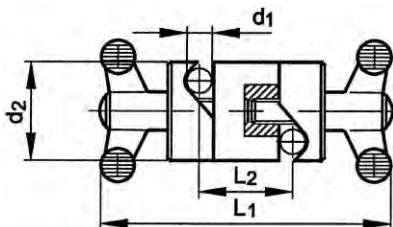

Informacje techniczne

d_1	d_2	L_1	L_2
10	32	100	32
12	36	104	34
16	45	142	44

- Aluminium ze stalą klasy 5.8 cynkowane, sworzeń gwintowany na żółto i pokrętła skrzydełkowe z poliamidu PA 6.

Dane montażowe

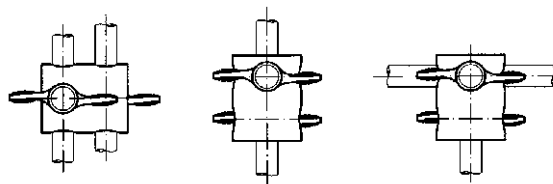

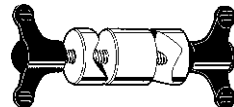
57008 Łączniki zaciskowe		W03A
Materiał	Aluminium	

d_1	☒	Kod artykułu	d_1	☒	Kod artykułu	d_1	☒	Kod artykułu
10MM	1	57008.100.001	12MM	1	57008.120.001	16MM	1	57008.160.001

Zawiasy do spawania ze stali nierdzewnej

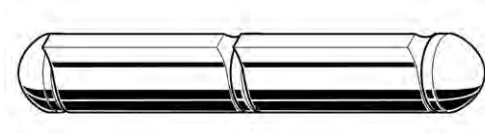

Grupy katalogowe

Material	Kod	Strona
St	87911	12-54
St.St.	87916	12-54

87911 Zawiasy do spawania ze stali nierdzewnej POM1

Material	Stal
 	

Wymiary	⊗	Kod artykułu	Wymiary	⊗	Kod artykułu	Wymiary	⊗	Kod artykułu
40	25	87911.000.040	80	25	87911.000.080	150	25	87911.000.150
50	25	87911.000.050	100	25	87911.000.100	180	25	87911.000.180
60	25	87911.000.060	120	25	87911.000.120	200	25	87911.000.200
70	25	87911.000.070	135	25	87911.000.135			

87916 Zawiasy do spawania ze stali nierdzewnej POM1

Material	Stal nierdzewna
 	

Wymiary	⊗	Kod artykułu	Wymiary	⊗	Kod artykułu	Wymiary	⊗	Kod artykułu
60	25	87916.000.060	100	25	87916.000.100	180MM	25	87916.000.180
80	25	87916.000.080	120	25	87916.000.120			

Zawiasy

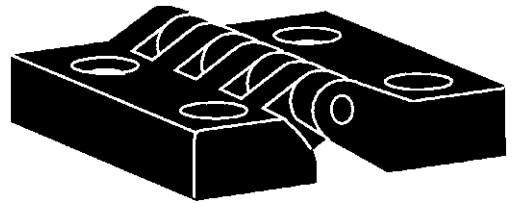
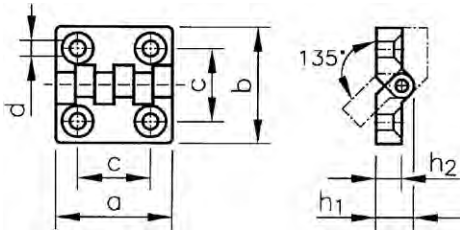

Informacje techniczne

a x b	c	d	h ₁	h ₂
48 x 48	30	6.5	15.5	10.5
64 x 64	40	6.5	19	13

Dane montażowe

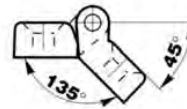
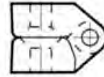

57013 Zawiasy		W03A
Materiał	Tworzywo sztuczne wzmocnione włóknem szklanym	
Kolor	Czarny	

a x b	☒	Kod artykułu	a x b	☒	Kod artykułu	a x b	☒	Kod artykułu
48X48MM	4	57013.040.040				64X64MM	4	57013.064.064

Trzpienie ruchome sprężyste z rowkiem i kulką

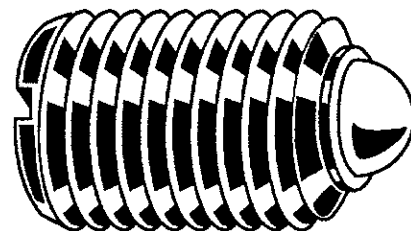
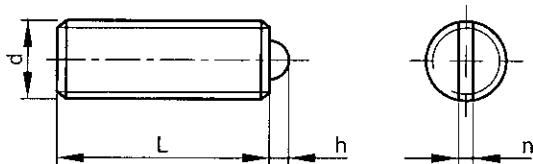

Informacje techniczne

d	h	n	Nacisk sprężyny w N	P
M3	0.5	0.4	1.5-3	0.5
M4	0.8	0.6	4-10	0.7
M5	0.9	0.8	6-11	0.8
M6	1	1	9-15	1
M8	1.5	1.2	15-30	1.25
M10	2	1.6	20-40	1.5
M12	2.5	2	30-55	1.75
M16	3.5	2.5	65-125	2
M20	4.5	2.5	80-160	2.5

Grupy katalogowe

Gwint	Materiał	Kod	Strona
M	Stal automatowa	56950	12-56
M	St.St.	56951	12-56

56950 Trzpienie ruchome sprężyste z rowkiem i kulką W03A

Gwint Metryczny
Materiał Stal automatowa



d x L	☒	Kod artykułu	d x L	☒	Kod artykułu	d x L	☒	Kod artykułu
M3X7	50	56950.030.007	M6X14	50	56950.060.014	M12X22	10	56950.120.022
M4X9	50	56950.040.009	M8X16	25	56950.080.016	M16X24	10	56950.160.024
M5X12	50	56950.050.012	M10X19	25	56950.100.019	M20X30	10	56950.200.030

56951 Trzpienie ruchome sprężyste z rowkiem i kulką W03A

Gwint Metryczny
Materiał Stal nierdzewna



d x L	☒	Kod artykułu	d x L	☒	Kod artykułu	d x L	☒	Kod artykułu
M3X7	25	56951.030.007	M6X14	25	56951.060.014	M12X22	10	56951.120.022
M4X9	25	56951.040.009	M8X16	10	56951.080.016	M16X24	10	56951.160.024
M5X12	25	56951.050.012	M10X19	10	56951.100.019	M20X30	10	56951.200.030

Trzpień ruchome sprężyste z rowkiem

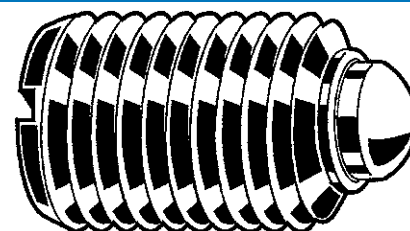
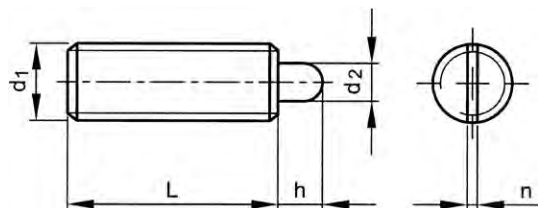

Informacje techniczne

d ₁	d ₂	h	n	Nacisk sprężyny w N	P
M4	1.8	1.5	0.6	6-20	0.7
M5	2.4	2	0.8	6-20	0.8
M6	2.7	2	1	7-20	1
M8	4	2	1.2	15-35	1.25
M10	4.5	2.5	1.6	20-45	1.5
M12	6	3.5	2	25-60	1.75
M16	8.5	4.5	2.5	45-100	2

Grupy katalogowe

Gwint	Materiał	Kod	Strona
M	Stal automatowa	56975	12-57
M	St.St.	56976	12-57

56975 Trzpień ruchome sprężyste z rowkiem

W03A

Gwint: Metryczny
Materiał: Stal automatowa



d ₁	☒	Kod artykułu	d ₁	☒	Kod artykułu	d ₁	☒	Kod artykułu
M4X9	50	56975.040.009	M8X16	25	56975.080.016	M12X22	10	56975.120.022
M5X12	50	56975.050.012	M10X19	25	56975.100.019	M16X24	10	56975.160.024
M6X14	50	56975.060.014						

56976 Trzpień ruchome sprężyste z rowkiem

W03A

Gwint: Metryczny
Materiał: Stal nierdzewna



d ₁ x L	☒	Kod artykułu	d ₁ x L	☒	Kod artykułu	d ₁ x L	☒	Kod artykułu
M4X9	25	56976.040.009	M8X16	10	56976.080.016	M12X22	10	56976.120.022
M5X12	25	56976.050.012	M10X19	10	56976.100.019	M16X24	10	56976.160.024
M6X14	25	56976.060.014						

Trzpień ruchome sprężyste z gniazdem sześciokątnym

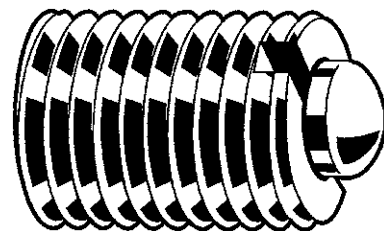
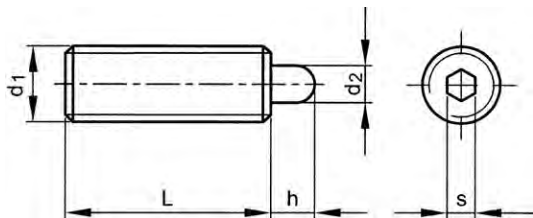

Informacje techniczne

d_1	d_2	h	Nacisk sprężyny w N	P	s
M3	1	1.5	0.5-3.5	0.5	0.7
M4	1.5	1.5	5-16	0.7	1.3
M5	2.4	2.3	6-20	0.8	1.5
M6	2.7	2.5	7-20	1	2
M8	3.5	3	9-35	1.25	2.5
M10	4	3	9-35	1.5	3
M12	6	4	10-55	1.75	4
M16	7.5	5	45-100	2	5
M20	10	7	60-145	2.5	6

Grupy katalogowe

Gwint	Materiał	Kod	Strona
M	Stal automatowa	56977	12-58
M	St.St.	56978	12-58

56977 Trzpień ruchome sprężyste z gniazdem sześciokątnym

W03A

Gwint Metryczny
Materiał Stal automatowa



$d_1 \times L$	☒	Kod artykułu	$d_1 \times L$	☒	Kod artykułu	$d_1 \times L$	☒	Kod artykułu
M3X10	50	56977.030.010	M6X20	50	56977.060.020	M12X28	10	56977.120.028
M4X15	50	56977.040.015	M8X22	25	56977.080.022	M16X32	10	56977.160.032
M5X18	50	56977.050.018	M10X22	25	56977.100.022	M20X40	10	56977.200.040

56978 Trzpień ruchome sprężyste z gniazdem sześciokątnym

W03A

Gwint Metryczny
Materiał Stal nierdzewna



$d_1 \times L$	☒	Kod artykułu	$d_1 \times L$	☒	Kod artykułu	$d_1 \times L$	☒	Kod artykułu
M4X15	25	56978.040.015	M8X22	10	56978.080.022	M12X28	10	56978.120.028
M5X18	25	56978.050.018	M10X22	10	56978.100.022	M16X32	10	56978.160.032
M6X20	25	56978.060.020						

Trzpienie ruchome sprężyste z gniazdem sześciokątnym.

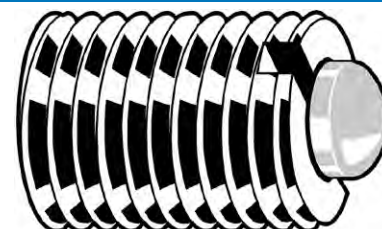
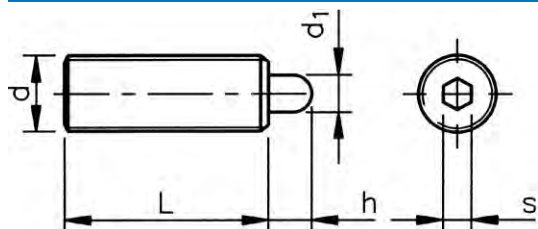

Informacje techniczne

d	d ₁	h	Nacisk sprężyny w N	P	s
M4	1.5	1.5	5-16	0.7	1.3
M5	2.4	2.3	5-20	0.8	1.5
M6	2.7	2.5	6-20	1	2
M8	3.5	3	7-35	1.25	2.5
M10	4	3	9-35	1.5	3
M12	6	4	10-55	1.75	4
M16	7.5	5	45-100	2	5

56980 Trzpienie ruchome sprężyste z gniazdem sześciokątnym.

W03A

Gwint Metryczny
Materiał Stal automatowa



d x L	☒	Kod artykułu	d x L	☒	Kod artykułu	d x L	☒	Kod artykułu
M4X15	25	56980.040.015	M8X22	10	56980.080.022	M12X28	10	56980.120.028
M5X18	25	56980.050.018	M10X22	10	56980.100.022	M16X32	10	56980.160.032
M6X20	25	56980.060.020						

Trzpienie ruchome sprężyste gładkie

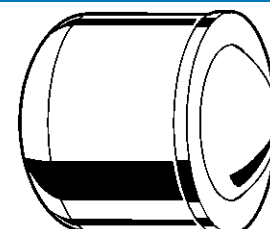
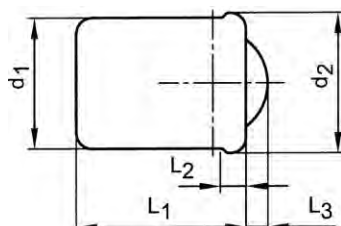

Informacje techniczne

d ₁	d ₂	L ₁	L ₂	L ₃	Nacisk sprężyny w N
4	4.6	5	1	0.8	3-7
5	5.6	6	1	1	4-7
6	6.5	7	1	1.5	6-12
8	8.5	9	1	1.8	6-12

56979 Trzpienie ruchome sprężyste gładkie

W03A

Materiał Stal nierdzewna

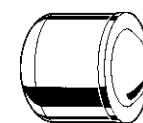

d ₁ x L ₁	☒	Kod artykułu	d ₁ x L ₁	☒	Kod artykułu	d ₁ x L ₁	☒	Kod artykułu
4X5MM	50	56979.040.005	6X7MM	50	56979.060.007	8X9MM	25	56979.080.009
5X6MM	50	56979.050.006						

Śruby zabezpieczające bez blokującego rowka, plastikowe

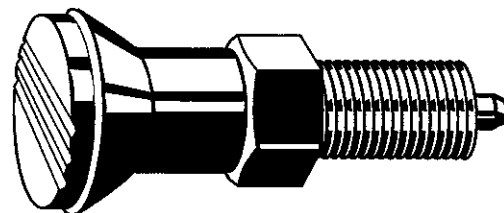
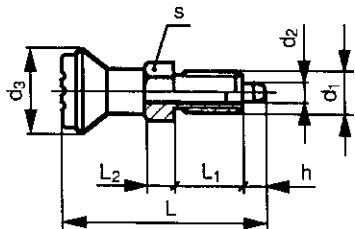

Informacje techniczne

$d_1 \times P \times h$	d_2	d_3	h	L	L_2	s
M10x1.0x5	5	21	5	47	7	13
M12x1.5x6	6	25	6	56	8	14
M16x1.5x8	8	33	8	74	10	19
M16x1.5x15	8	33	15	80	13	19

56952 Śruby zabezpieczające bez blokującego rowka, plastikowe

W03A

Gwint Metryczny drobnostrojny
Materiał Plastik Poliamid (nylon)/Stal
Klasa 6
Kolor Czarny

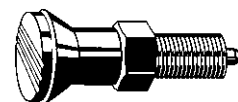

$d_1 \times P \times L_1$ (h)	☒	Kod artykułu	$d_1 \times P \times L_1$ (h)	☒	Kod artykułu	$d_1 \times P \times L_1$ (h)	☒	Kod artykułu
M10X1,00X17/5	10	56952.100.017	M12X1,50X20/6	5	56952.120.020	M16X1,50X26/8	3	56952.160.026

Śruby zabezpieczające z blokującym rowkiem, plastikowe

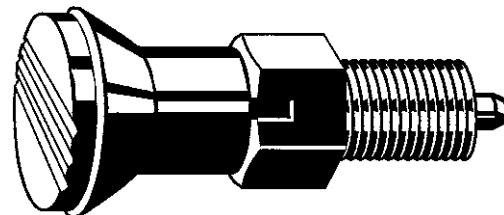
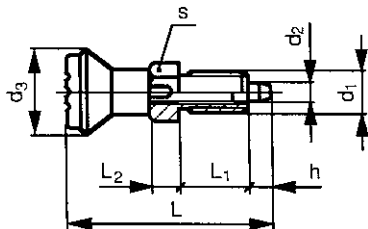

Informacje techniczne

$d_1 \times P \times h$	d_2	d_3	h	L	L_2	s
M10x1.0x5	5	21	5	47	10	13
M12x1.5x6	6	25	6	56	11	14
M16x1.5x8	8	33	8	74	13	19

56953 Śruby zabezpieczające z blokującym rowkiem, plastikowe

W03A

Gwint Metryczny drobnostrojny
Materiał Plastik Poliamid (nylon)/Stal
Klasa 6
Kolor Czarny

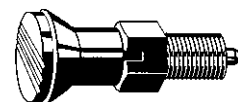

$d_1 \times P \times L_1$ (h)	☒	Kod artykułu	$d_1 \times P \times L_1$ (h)	☒	Kod artykułu	$d_1 \times P \times L_1$ (h)	☒	Kod artykułu
M10X1,00X17/5	10	56953.100.017	M12X1,50X20/6	5	56953.120.020	M16X1,50X26/8	3	56953.160.026

Śruby zabezpieczające, stalowe

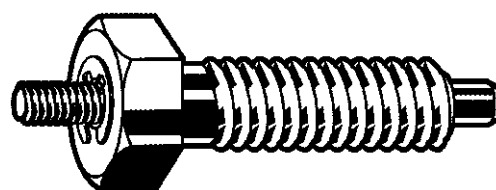
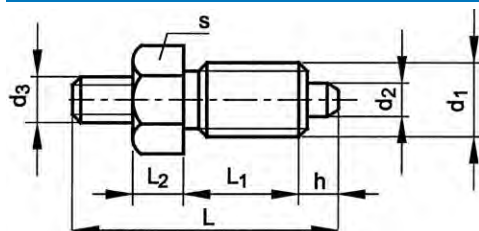

Informacje techniczne

$d_1 \times P \times h$	d_2	d_3	h	L	L_2	s
M10x1.0x5	5	M4	5	37	7	13
M12x1.5x6	6	M6	6	43	8	14
M16x1.5x8	8	M8	8	56	10	19
M20x1.5x10	10	M8	10	62	12	22

57001 Śruby zabezpieczające, stalowe

W03A

Gwint Metryczny drobnozwojny
 Materiał Stal

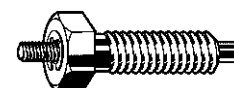

$d_1 \times P \times L_1 (h)$	☒	Kod artykułu	$d_1 \times P \times L_1 (h)$	☒	Kod artykułu	$d_1 \times P \times L_1 (h)$	☒	Kod artykułu
M10X1,00X17/5	10	57001.100.100	M16X1,50X26/8	3	57001.160.150	M20X1,50X28/10	2	57001.200.150
M12X1,50X20/6	5	57001.120.150						

Zamocowania walcowe typu A

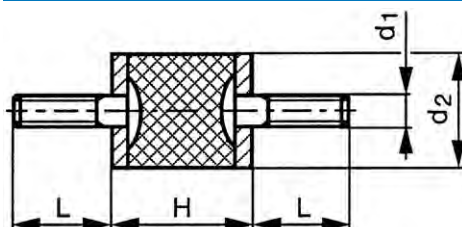

Informacje techniczne

Typ	d_1	d_2	H	L	Maks. dopuszczalne obciążenie ścinające w N
A10/10	M4	10	10	10	20
A15/08	M4	15	8	10	25
A15/15	M4	15	15	10	40
A18/8.5	M6	18	8.5	16	70
A20/15	M6	20	15	18	70
A20/20	M6	20	20	18	70
A20/25	M6	20	25	18	60
A25/10	M6	25	10	18	120
A25/15	M6	25	15	18	110
A25/20	M6	25	20	18	110
A25/25	M6	25	25	18	105
A25/30	M6	25	30	18	90
A30/15	M8	30	15	20	170
A30/20	M8	30	20	20	170
A30/30	M8	30	30	20	150
A30/40	M8	30	40	20	100
A40/30	M8	40	30	23	300
A40/40	M8	40	40	23	260
A50/20	M10	50	20	28	500
A50/25	M10	50	25	28	500
A50/30	M10	50	30	28	500
A50/40	M10	50	40	28	450
A50/45	M10	50	45	28	450
A50/50	M10	50	50	28	420
A70/45	M10	70	45	28	900
A75/25	M12	75	25	37	1 000

Informacje techniczne

Typ	d ₁	d ₂	H	L	Maks. dopuszczalne obciążenie ścinające w N
A75/40	M12	75	40	37	1 000
A75/50	M12	75	50	37	1 000
A75/55	M12	75	55	37	1 000
A100/40	M16	100	40	41	2 000
A100/55	M16	100	55	41	2 000
A100/60	M16	100	60	41	2 000
A100/65	M16	100	65	41	2 000

- Przedłużenie, materiał naturalny, guma 55°/60° brzeg.

57770 Zamocowania walcowe typu A

S11A

Gwint Metryczny
Materiał Stal
Obróbka powierzchni Ocynkowane



Typ	☒	Kod artykułu	Typ	☒	Kod artykułu	Typ	☒	Kod artykułu
10/10 M4X10	10	57770.010.010	25/30 M6X18	10	57770.025.030	50/45 M10X28	5	57770.050.045
15/8 M4X10	10	57770.015.008	30/15 M8X20	10	57770.030.015	50/50 M10X28	5	57770.050.050
15/15 M4X13	10	57770.015.015	30/20 M8X20	10	57770.030.020	70/45 M10X28	5	57770.070.045
18/8,5 M6X16	10	57770.018.008	30/30 M8X20	10	57770.030.030	75/25 M12X37	5	57770.075.025
20/15 M6X18	10	57770.020.015	30/40 M8X20	10	57770.030.040	75/40 M12X37	5	57770.075.040
20/20 M6X18	10	57770.020.020	40/30 M8X23	10	57770.040.030	75/50 M12X37	5	57770.075.050
20/25 M6X18	10	57770.020.025	40/40 M8X23	10	57770.040.040	75/55 M12X37	5	57770.075.055
25/10 M6X18	10	57770.025.010	50/20 M10X28	5	57770.050.020	100/40 M16X41	2	57770.100.040
25/15 M6X18	10	57770.025.015	50/25 M10X28	5	57770.050.025	100/55 M16X41	2	57770.100.055
25/20 M6X18	10	57770.025.020	50/30 M10X28	5	57770.050.030	100/60 M16X41	2	57770.100.060
25/25 M6X18	10	57770.025.025	50/40 M10X28	5	57770.050.040	100/60M16X45	2	57770.100.065

Zamocowania walcowe typu B

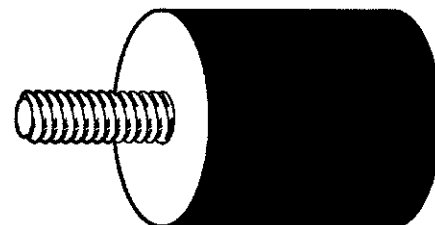
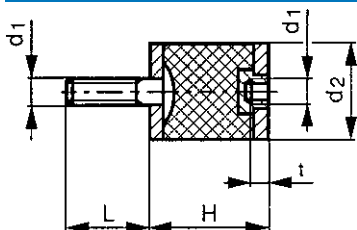

Informacje techniczne

Typ	d ₁	d ₂	H	L	Maks. dopuszczalne obciążenie ścinające w N	Maks. obciążenie ściskające (N)	t
B10/10	M4	10	10	10	10	56	4
B15/15	M4	15	15	10	50	115	4
B20/15	M6	20	15	18	105	160	6
B20/20	M6	20	20	18	90	160	6
B20/25	M6	20	25	18	90	150	6
B25/15	M6	25	15	18	160	290	6
B25/20	M6	25	20	18	145	280	6
B25/25	M6	25	25	18	135	260	6
B25/30	M6	25	30	18	135	250	6
B30/15	M8	30	15	20	208	676	8
B30/20	M8	30	20	20	210	380	8
B30/30	M8	30	30	20	190	355	8
B30/40	M8	30	40	23	340	600	8
B40/30	M8	40	30	23	340	600	8
B40/40	M8	40	40	23	330	600	8
B50/20	M10	50	20	28	455	1 300	10
B50/30	M10	50	30	28	500	1 200	10
B50/40	M10	50	40	28	315	1 100	10
B50/45	M10	50	45	28	510	1 050	10
B50/50	M10	50	50	28	505	1 050	10
B70/45	M10	70	45	28	995	2 200	10
B75/40	M12	75	40	37	1 215	2 900	12
B75/50	M12	75	50	37	1 185	2 600	12
B75/55	M12	75	55	37	1 170	2 400	12
B100/40	M16	100	40	41	2 310	6 500	16

Informacje techniczne

Typ	d ₁	d ₂	H	L	Maks. dopuszczalne obciążenie ścinające w N	Maks. obciążenie ściskające (N)	t
B100/55	M16	100	55	41	2 180	5 100	16
B100/60	M16	100	60	41	2 125	5 000	16

- Przedłużenie, materiał naturalny, guma 55°/60° shore.
- Tolerancja zgodn. z DIN 7715-2, klasa M3.

57771 Zamocowania walcowe typu B

S11A

Gwint Metryczny
Materiał Stal
Obrobka powierzchni Ocykowane

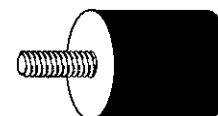

Typ	☒	Kod artykułu	Typ	☒	Kod artykułu	Typ	☒	Kod artykułu
10/10 M4X10-5	10	57771.010.010	30/15 M8X20	10	57771.030.015	50/45 M10X28-10	5	57771.050.045
15/15 M4X10-5	10	57771.015.015	30/20 M8X20-8	10	57771.030.020	50/50 M10X28-10	5	57771.050.050
20/15 M6X18-6	10	57771.020.015	30/30 M8X20-8	10	57771.030.030	70/45 M10X28-10	5	57771.070.045
20/20 M6X18-6	10	57771.020.020	30/40 M8X20	10	57771.030.040	75/40 M12X37-12	5	57771.075.040
20/25 M6X18-6	10	57771.020.025	40/30 M8X23-8	10	57771.040.030	75/50 M12X37	5	57771.075.050
25/15 M6X18-6	10	57771.025.015	40/40 M8X23-8	10	57771.040.040	75/55 M12X37-12	5	57771.075.055
25/20 M6X18-6	10	57771.025.020	50/20 M10X28-10	5	57771.050.020	100/40 M16X41-16	2	57771.100.040
25/25 M6X18-6	10	57771.025.025	50/30 M10X28-10	5	57771.050.030	100/55 M16X41-16	2	57771.100.055
25/30 M6X18-6	10	57771.025.030	50/40 M10X28-10	5	57771.050.040	100/60 M16X41-16	2	57771.100.060

Zamocowania walcowe typu C

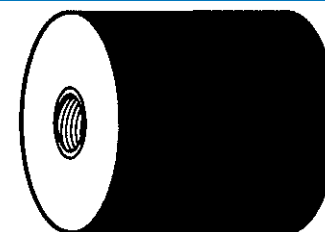
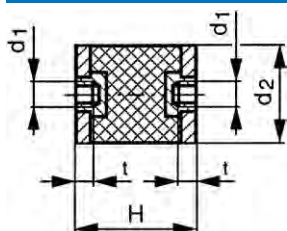

Informacje techniczne

Typ	d ₁	d ₂	H	Maks. dopuszczalne obciążenie ścinające w N	Maks. obciążenie ściskające (N)	t
C10/10	M4	10	10	12	96	5
C15/15	M4	15	15	40	120	5
C20/20	M6	20	20	50	170	6
C20/25	M6	20	25	40	150	6
C25/20	M6	25	20	90	280	6
C25/25	M6	25	25	80	260	6
C25/30	M6	25	30	80	250	6
C30/20	M8	30	20	120	380	8
C30/30	M8	30	30	110	355	8
C30/40	M8	30	40	208	429	8
C40/30	M8	40	30	250	700	8
C40/40	M8	40	40	250	650	8
C50/30	M10	50	30	400	1 200	10
C50/40	M10	50	40	400	1 100	10
C50/45	M10	50	45	400	1 050	10
C50/50	M10	50	50	400	1 050	10
C70/45	M10	70	45	750	2 200	10
C75/40	M12	75	40	900	2 900	12
C75/50	M12	75	50	900	2 600	12
C100/40	M16	100	40	1 500	6 500	16
C100/55	M16	100	55	1 500	5 100	16
C100/60	M16	100	60	1 500	5 000	16

- Przedłużenie, materiał naturalny, guma 55°/60° shore.
- Tolerancja zgodn. z DIN 7715-2, klasa M3.

57780 Zamocowania walcowe typu C
S11A

Gwint Metryczny
 Materiał Stal
 Obróbka powierzchni Ocynkowane

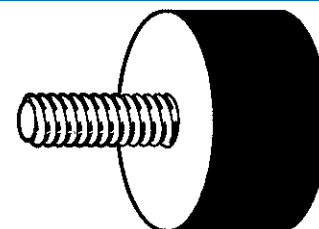
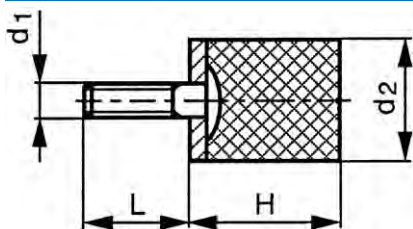

Typ	☒	Kod artykułu	Typ	☒	Kod artykułu	Typ	☒	Kod artykułu
10/10M4X5	10	57780.010.010	30/20M8X8	10	57780.030.020	50/45M10X10	5	57780.050.045
15/15M4X5	10	57780.015.015	30/30M8X8	10	57780.030.030	50/50M10X10	5	57780.050.050
20/20M6X6	10	57780.020.020	30/40M8X8	10	57780.030.040	70/45M10X10	5	57780.070.045
20/25M6X6	10	57780.020.025	40/30M8X8	10	57780.040.030	75/40M12X12	5	57780.075.040
25/20M6X6	10	57780.025.020	40/40M8X8	10	57780.040.040	75/50M12X12	5	57780.075.050
25/25M6X6	10	57780.025.025	50/30M10X10	5	57780.050.030	100/40M16X16	2	57780.100.040
25/30M6X6	10	57780.025.030	50/40M10X10	5	57780.050.040	100/55M16X16	2	57780.100.055

Zamocowania walcowe typu D i KD

Informacje techniczne

Typ	d ₁	d ₂	H	L	Maks. obciążenie ściskające (N)
D10/10	M4	10	10	10	59
D20/15	M6	20	15	18	160
KD25/17	M6	25	17	18	250
D25/17	M6	25	17	18	290
D30/17	M8	30	17	20	380
D30/20	M8	30	20	20	350
D40/28	M8	40	28	23	680
D40/30	M8	40	30	23	660
D40/38	M8	40	38	23	660
KD50/18	M10	50	18	28	1 400
D50/20	M10	50	20	28	1 500
D50/42	M10	50	42	28	1 100
D70/42	M10	70	42	30	2 200
D75/25	M12	75	25	37	5 446
D100/40	M16	100	40	41	6 600

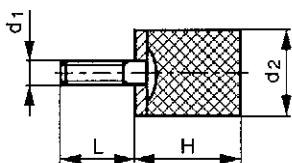
- Przedłużenie, materiał naturalny, guma 55°/60° shore.
- Tolerancja zgodn. z DIN 7715-2, klasa M3.

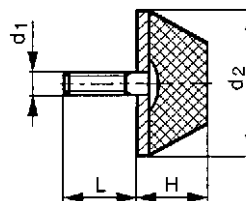
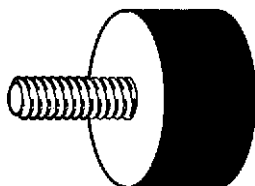

TYP D

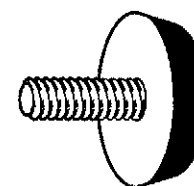

TYP KD

57779 Zamocowania walcowe typu D i KD
S11A

Gwint Metryczny
 Materiał Stal
 Obróbka powierzchni Ocynkowane

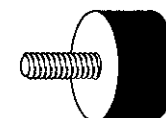

Typ	☒	Kod artykułu	Typ	☒	Kod artykułu	Typ	☒	Kod artykułu
D10/10 M4X10	10	57779.010.010	D30/17 M8X20	10	57779.030.017	D40/38 M8X23	10	57779.040.038
D20/15 M6X18	10	57779.020.015	D30/20 M8X20	10	57779.030.020	KD50/18	5	57779.050.018
DK25/17 M6X18	10	57779.025.017	D40/28 M8X23	10	57779.040.028	D50/20 M10X28	5	57779.050.020
D25/17 M6X18	10	57779.025.117	D40/30 M8X23	10	57779.040.030	D50/42 M10X28	5	57779.050.042

57779 Zamocowania walcowe typu D i KD								
Typ	☒	Kod artykułu	Typ	☒	Kod artykułu	Typ	☒	Kod artykułu
D70/42 M10X30	5	57779.070.042	D75/25 M12X37	5	57779.075.025	D100/40 M16X41	2	57779.100.040

Zamocowania typu RA

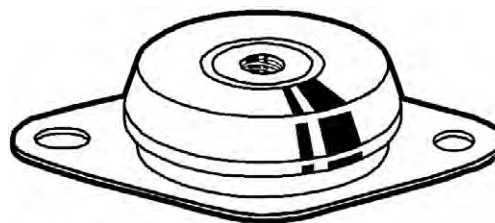
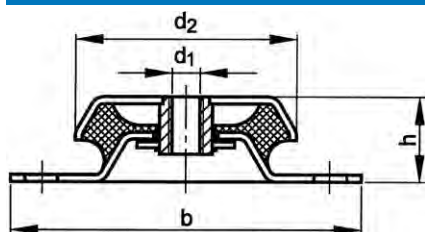

Informacje techniczne

Typ	a	b	d ₁	d ₂	d ₃	h	Maks. obciążenie ściskające (N)
RA 100/M10	110	130	M10	79	9	30	2 400
RA 100/M12	110	130	M12	79	9	30	2 400
RA 200/M10	124	150	M10	94	10	35	2 800
RA 200/M12	124	150	M12	94	10	35	2 800
RA 350/M12	140-148	175	M12	101	14	38	4 500
RA 350/M16	140-148	175	M16	101	14	38	4 500
RA 500/M16	158	192	M16	123	14	42	7 000
RA 800/M16	182	216	M16	144	14	48	13 000

- Pokrywa kopułowa cynkowana, pasywacja na niebiesko, materiał izolujący wibracje, guma naturalna (NR) 60° twardość (tol. ± 5°), płyta zamocowania pokryta czarną ochronną powłoką Suncotire Aqua 100.

Specjalne właściwości zamocowań FABORY typ RA:

- odpowiednie dla efektywnej izolacji drgań i hałasu różnych maszyn z elementami obrotowymi, jak kompresory, silniki spalinowe, generatory (prądnice), konwertery (przetwornice), pompy, przemysłowe i okrętowe urządzenia generujące, wentylatory, do użycia z prasami, stemplami i innymi maszynami warsztatowymi.
- montowane jako standard w urządzeniach z systemami łagodnego zatrzymania pracy w przypadku awarii.

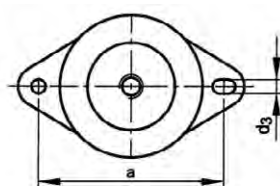

TYP RA 100, RA 200, RA 500, RA 800

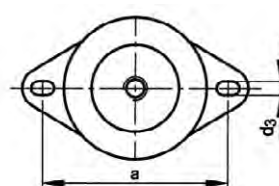

TYP RA 350

57792 Zamocowania typu RA								S12A
Gwint		Metryczny						
Materiał		Stal						

Typ	☒	Kod artykułu	Typ	☒	Kod artykułu	Typ	☒	Kod artykułu
100-M10	2	57792.100.100	200-M12	2	57792.200.120	500-M16	1	57792.500.160
100-M12	2	57792.100.120	350-M12	1	57792.350.120	800-M16	1	57792.800.160
200-M10	2	57792.200.100	350-M16	1	57792.350.160			

Zamocowania typu RAEM

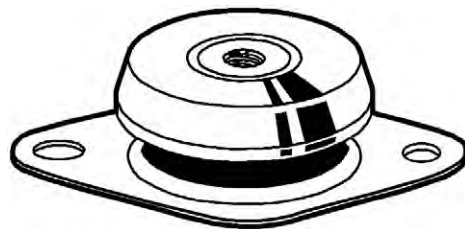
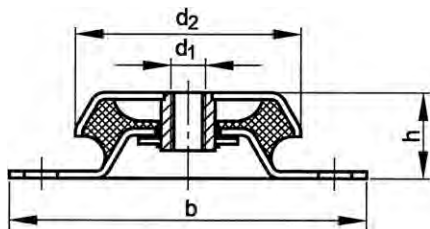

Informacje techniczne

Typ	a	b	d ₁	d ₂	d ₃	h	Maks. obciążenie ściskające (N)
RAEM 40/M10	88	110	M10	64	9	35.5	600
RAEM 60/M12	100	120	M12	63	11	35.5	1 200
RAEM 125/M10	110	135	M10	84	11	35.5	1 800
RAEM 125/M12	110	135	M12	84	11	35.5	1 800
RAEM 350/M12	140-148	175	M12	110	14	42	4 000
RAEM 350/M16	140-148	175	M16	110	14	42	4 000
RAEM 800/M16	182	216	M16	155	14	54	8 000

- Pokrywa kopułowa cynkowana, pasywacja na niebiesko, materiał izolujący wibracje, guma naturalna (NR) 60° twardość (tol. ± 5°), płyta zamocowania pokryta czarną ochronną powłoką Suncotire Aqua 100.

Specjalne właściwości zamocowań FABORY typ RAEM:

- do zastosowań wymagających maksymalnej izolacji
- odpowiednie do efektywnej izolacji drgań i hałasu różnych maszyn z elementami obrotowymi, jak kompresory, jednostki AC, wentylatory przemysłowe, generatory (prądnice), silniki spalinowe, urządzenia do zasilania awaryjnego, dużych mechanizmów frezujących, przemysłowe i okrętowe urządzenia generujące, rafinerie i defibratory.
- montowane jako standard w urządzeniach z systemami łagodnego zatrzymania pracy w przypadku awarii.

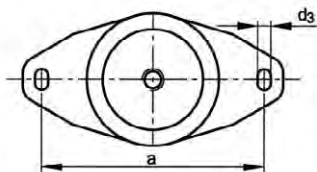

TYP RAEM 60

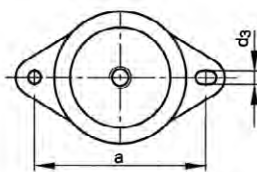

TYP RAEM 40, RAEM 125, RAEM 800

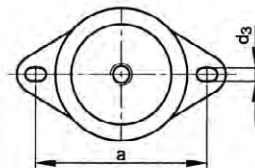

TYP RAEM 350

57793 Zamocowania typu RAEM

S12A

Gwint Metryczny
Materiał Stal



Typ	☒	Kod artykułu	Typ	☒	Kod artykułu	Typ	☒	Kod artykułu
40-M10	2	57793.040.100	125-M12	2	57793.125.120	350-M16	1	57793.350.160
60-M12	2	57793.060.120	350-M12	1	57793.350.120	800-M16	1	57793.800.160
125-M10	2	57793.125.100						

Zamocowania typu RAB

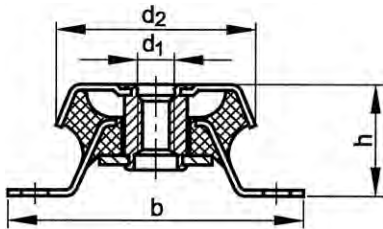

Informacje techniczne

Typ	a	b	d ₁	d ₂	h	Maks. obciążenie ściskające (N)
RAB-0	76	93.5	M12	63	35	1 300
RAB-2	76	93.5	M12	63	35	1 050
RAB-3	76	93.5	M12	63	35	700

- Pokrywa kopułowa cynkowana, pasywacja na niebiesko, materiał izolujący wibracje, guma butylowa (NR) 55° twardość (tol. ± 5°), płyta zamocowania pokryta czarną ochronną powłoką Suncotire Aqua 100.

Specjalne właściwości zamocowań FABORY typ RAB:

- optymalne charakterystyki sztywności i stabilności poziomej
- szczególnie skuteczne na małych 1,2 i 3 cylindrowych silnikach wysokoprężnych (Diesla).
- montowane jako standard w urządzeniach z systemami łagodnego zatrzymania pracy w przypadku awarii.

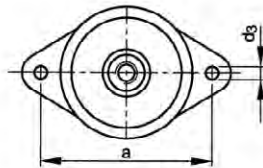

57794 Zamocowania typu RAB

S12A

Gwint Metryczny
Materiał Stal



Typ	☒	Kod artykułu	Typ	☒	Kod artykułu	Typ	☒	Kod artykułu
0-M12	2	57794.000.120	2-M12	2	57794.002.120	3-M12	2	57794.003.120

Zamocowania typu M

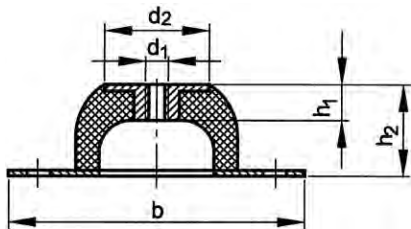

Informacje techniczne

Typ	a	b	d ₁	d ₂	d ₃	h ₁	h ₂	Maks. obciążenie ściskające (N)
M 7	50	64	M6	18	7	7	20	90
M 25	66	85	M8	33	8	11	25	500
M 50	92	114	M10	45	10	14	35	800
M 100	110	136	M10	53	11.5	15	40	1 500
M 200	124	151	M10	58	11.5	13	45	2 200
M 400	120	150	M12	78	14.5	18	63	5 000

- Pokrywa kopułowa pokryta czarną ochronną powłoką Suncotire Aqua 100., materiał izolujący wibracje guma naturalna (NR) 60° twardość (tol. ± 5°), płyta zamocowania pokryta czarną ochronną powłoką Suncotire Aqua 100.

Specjalne właściwości zamocowań FABORY typ M:

- wysoka elastyczność pionowa, jak również pozioma
- odpowiednie także do tłumienia drgań
- szkodliwego działania oleju można uniknąć dzięki odpowiedniemu montażowi lub zastosowaniu osłon mechanicznej

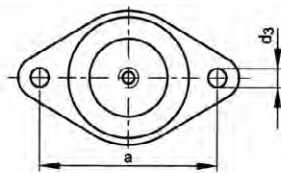

TYP M7, M25, M50, M100, M200

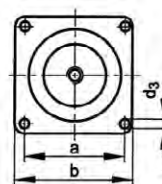

TYP M400

57795 Zamocowania typu M

S12A

Gwint Metryczny
Material Stal



Typ	☒	Kod artykułu	Typ	☒	Kod artykułu	Typ	☒	Kod artykułu
7-M6	4	57795.007.060	50-M10	4	57795.050.100	200-M10	2	57795.200.100
25-M8	4	57795.025.080	100-M10	2	57795.100.100	400-M12	1	57795.400.120

Zamocowania typu SE

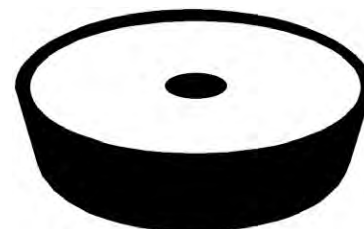
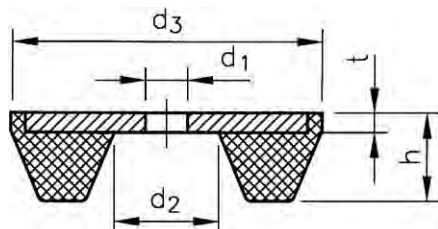

Informacje techniczne

Typ	d ₁	d ₂	d ₃	h	Maks. obciążenie ściskające (N)	t
SE 75	8	18	55	15	1 500	3
SE 250	10	25	75	17	4 000	4

- Cechy szczególne zamocowań typ SE:
- Proste zamocowanie, tarcie zazwyczaj wystarcza aby zapobiec przesuwaniu się zawieszonoego wyposażenia
- Odpowiednie do wyposażenia biura, maszyn włókienniczych, artykułów gospodarstwa domowego, silników elektrycznych oraz urządzeń ważących.
- Pokrywa kopułowa pokryta czarną ochronną powłoką Suncofire Aqua 100, materiał izolujący wibracje, guma naturalna (NR) 50°.

57805 Zamocowania typu SE

S12A

Gwint Metryczny
Materiał Stal
Obróbka powierzchni Ocynkowane



Typ	☒	Kod artykułu	Typ	☒	Kod artykułu
75SE	4	57805.000.075	250SE	4	57805.000.250

Zaślepka kwadratowa

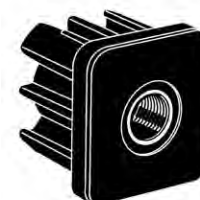
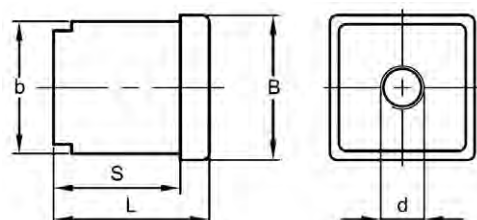

Informacje techniczne

d x B x b	B	b	d	L	S
M10x30x27.5	30	27.5	M10	33	27
M12x40x36.5	40	36.5	M12	43	35
M12x50x45.5	50	45.5	M12	55	44
M14x40x36.5	40	36.5	M14	43	35
M16x40x36.5	40	36.5	M16	43	35
M16x40x37.5	40	37.5	M16	43	35
M16x50x45.5	50	45.5	M16	55	44
M16x50x47.5	50	47.5	M16	55	44
M16x60x56.5	60	56.5	M16	55	45
M20x50x45.5	50	45.5	M20	55	44
M20x50x46.5	50	46.5	M20	55	44

57730 Zaślepka kwadratowa

S11A

Materiał Plastik Poliamid (nylon)



d x B x b	☒	Kod artykułu	d x B x b	☒	Kod artykułu	d x B x b	☒	Kod artykułu
M10X30X27,5	2	57730.103.027	M16X40X36,5	1	57730.164.036	M16X60X56,5	1	57730.166.056
M12X40X36,5	2	57730.124.036	M16X40X37,5	1	57730.164.037	M20X50X45,5	1	57730.205.045
M12X50X45,5	2	57730.125.045	M16X50X45,5	1	57730.165.045	M20X50X46,5	1	57730.205.046
M14X40X36,5	2	57730.144.036	M16X50X47,5	1	57730.165.047			

Podstawka antywibracyjna

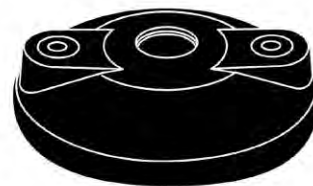
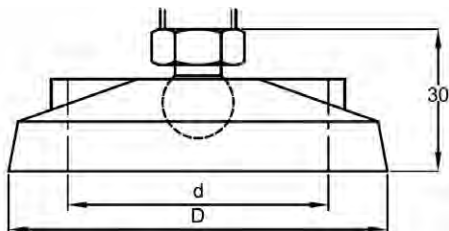

Informacje techniczne

D	80	100	120
d	55	74	94

- Średnice 80, 100 i 120 z grupy 57747 mają płytkę bazową z otworami montażowymi.

Grupy katalogowe

Material	Kod	Strona
Plastik PA	57747	12-70
St	57748	12-70
St.St. A2	57745	12-70

57747 Podstawka antywibracyjna S11A

Material Plastik Poliamid (nylon)



D	☒	Kod artykułu	D	☒	Kod artykułu	D	☒	Kod artykułu
50MM	4	57747.000.050	80MM	4	57747.000.080	120MM	2	57747.000.120
60MM	4	57747.000.060	100MM	2	57747.000.100			

57748 Podstawka antywibracyjna S11A

Material Stal



D	☒	Kod artykułu	D	☒	Kod artykułu	D	☒	Kod artykułu
30MM	4	57748.000.030	60MM	4	57748.000.060	120MM	2	57748.000.120
40MM	4	57748.000.040	80MM	4	57748.000.080			

57745 Podstawka antywibracyjna S11A

Material Stal nierdzewna A2



d	☒	Kod artykułu	d	☒	Kod artykułu	d	☒	Kod artykułu
40MM	4	57745.040.001	60MM	4	57745.060.001	80MM	4	57745.080.001

Śruba do podstawki antywibracyjnej

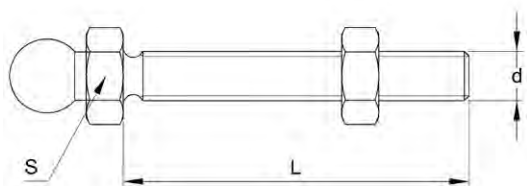

Informacje techniczne

d	s	d	s
M8	14	M16	17
M10	14	M20	22
M12	14	M24*	17

* Ta nakrętka jest spłaszczona w dwóch miejscach zamiast regularnego sześciokątnego kształtu.

Grupy katalogowe

Gwint	Gniazdo	Materiał	Obróbka powierzchni	Kod	Strona
M	Sześciokąt	St	Ocynk.	57750	12-71
M	Sześciokąt	St.St. A2		57749	12-71

57750 Śruba do podstawki antywibracyjnej

S11A

Gwint Metryczny
Materiał Stal
Obróbka powierzchni Ocynkowane



d x L	☒	Kod artykułu	d x L	☒	Kod artykułu	d x L	☒	Kod artykułu
M10X45	4	57750.100.045	M16X66	4	57750.160.066	M20X125	2	57750.200.125
M10X70	4	57750.100.070	M16X100	4	57750.160.100	M20X150	2	57750.200.150
M10X90	4	57750.100.090	M16X125	4	57750.160.125	M20X200	2	57750.200.200
M10X125	4	57750.100.125	M16X150	4	57750.160.150	M24X85	2	57750.240.085
M12X45	4	57750.120.045	M16X200	2	57750.160.200	M24X100	2	57750.240.100
M12X66	4	57750.120.066	M20X85	2	57750.200.085	M24X125	2	57750.240.125
M12X100	4	57750.120.100	M20X100	2	57750.200.100	M24X150	2	57750.240.150
M12X125	4	57750.120.125				M24X200	2	57750.240.200
M12X150	4	57750.120.150						

57749 Śruba do podstawki antywibracyjnej

S11A

Gwint Metryczny
Materiał Stal nierdzewna A2



d x L	☒	Kod artykułu	d x L	☒	Kod artykułu	d x L	☒	Kod artykułu
M8X40	4	57749.080.040	M12X125	4	57749.120.125	M20X125	2	57749.200.125
M8X80	4	57749.080.080	M12X150	4	57749.120.150	M20X150	2	57749.200.150
M10X45	4	57749.100.045	M16X66	4	57749.160.066	M20X200	2	57749.200.200
M10X70	4	57749.100.070	M16X100	4	57749.160.100	M20X250	1	57749.200.250
M10X90	4	57749.100.090	M16X125	4	57749.160.125	M24X85	2	57749.240.085
M10X125	4	57749.100.125	M16X150	2	57749.160.150	M24X100	2	57749.240.100
M12X45	4	57749.120.045	M16X200	2	57749.160.200	M24X125	2	57749.240.125
M12X66	4	57749.120.066	M20X85	2	57749.200.085	M24X150	2	57749.240.150
M12X100	4	57749.120.100	M20X100	2	57749.200.100	M24X200	2	57749.240.200

Elastyczne podpory maszyn

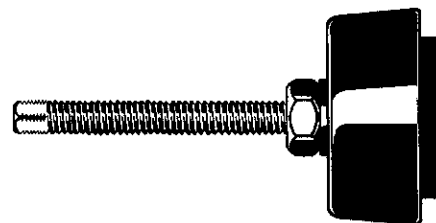
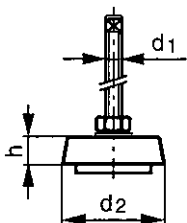

Informacje techniczne

Typ	T3	T5	T10	T15	T20	T25	T35	T40
d₁ x P	M10x1.25	M12x1.25	M14x1.5	M16x1.5	M16x1.5	M20x1.5	M20x1.5	M24x1.5
d₂	60	81	97	120	139	163	211	236
Długość śruby regulującej	100	100	120	120	150	150	170	170
h	28	30	38	42	46	50	54	54
Obciążenie w kN	0.5-1.5	1.5-4.5	4.5-7.5	6-12.5	7.5-15	11-22.5	22.5-45	30-60
Wysokość rozciągania gumy	10	12	14	15	16	17	20	20
Obciążenie w kN na podstawę prasy								
Maks. skoki 125/min.	-	0.7-2	2-4	3-7	4-10	7-15	15-30	20-40
Maks. skoki 160/min.	-	0.6-1.4	1.2-3.5	2.2-4.6	3.5-6	4.8-8	9-16	13-22
Maks. skoki 200/min.	-	0.5-1.2	1-2.5	1.7-3.8	2.5-5	3.7-6.7	7.5-13	10-17

- Stal klasy 8.8 z profilem z gumy NBR.
- Śruba regulacyjna do typu T20 włącznie ze śrubą z łbem kwadratowym, powyżej typu T20 ze śrubą z łbem sześciokątnym.
- Obciążenie statyczne na elastyczną podporę urządzenia w kN.
- Obciążenie dynamiczne na elastyczną podporę urządzenia w kN dla pras, maks. liczba nacisków podana jest na minutę.
- Na żądanie dostępne są inne rodzaje gumy i/lub twardości lub dłuższe śruby regulacyjne.

Przykład zastosowania

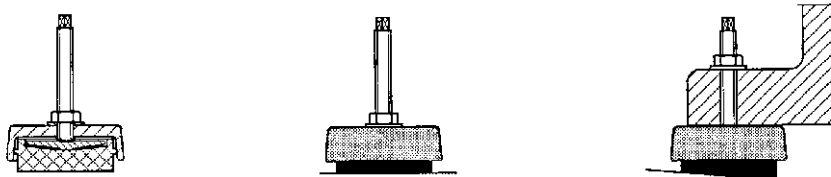

57676 Elastyczne podpory maszyn

S11A

Gwint Metryczny drobnozwojny
Materiał Stal
Klasa 8.8



Typ	☒	Kod artykułu	Typ	☒	Kod artykułu	Typ	☒	Kod artykułu
T3	4	57676.000.003	T15	2	57676.000.015	T35	1	57676.000.035
T5	4	57676.000.005	T20	2	57676.000.020	T40	1	57676.000.040
T10	4	57676.000.010	T25	1	57676.000.026			

Tulejki typu VP

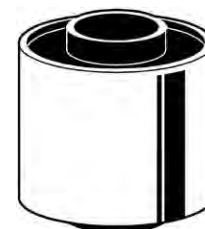
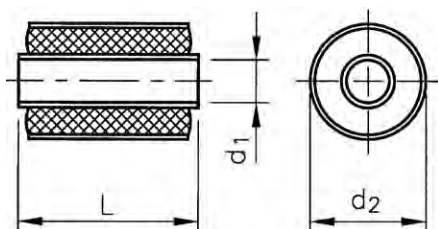

Informacje techniczne

$d_1 \times d_2 \times L$	F_a (maks.) w Nm	F_r (maks.) w Nm	α (maks.) w °	β (maks.) w °
10x25x25	750	2 300	8	15
10x25x40	1 500	3 800	8	15
15x35x30	1 500	3 500	8	15
15x35x50	2 500	6 000	8	15
20x45x40	2 600	6 800	8	15
20x45x75	5 500	13 500	8	15
25x50x45	3 800	9 000	8	14
25x50x85	7 500	18 000	8	14
30x60x55	5 100	12 000	8	14
30x60x100	10 500	25 000	8	14
35x65x60	10 500	25 000	8	14
35x65x110	8 300	20 500	7	12
40x70x65	8 300	20 500	7	12
40x70x120	18 000	40 000	6	11
45x75x70	10 000	24 000	7	12
45x75x130	20 000	40 000	6	10
50x80x75	12 000	28 500	7	11
50x80x140	23 500	49 000	6	10

- Tulejka typu VP zaprojektowana do kompensowania ruchów skręcających oraz obciążeń osiowych i promieniowych.
- Składa się z dwóch koncentrycznych rękawów z gumą bezpiecznie umieszczoną między nimi.

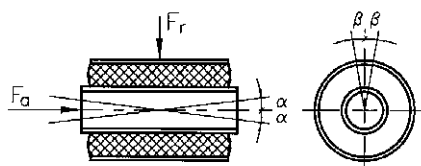

57807 Tulejki typu VP

S12A

Material Stal



$d_1 \times d_2 \times L$	☒	Kod artykułu	$d_1 \times d_2 \times L$	☒	Kod artykułu	$d_1 \times d_2 \times L$	☒	Kod artykułu
10X25X25MM	2	57807.125.025	25X50X45MM	1	57807.275.045	40X70X65MM	1	57807.470.065
10X25X40MM	2	57807.125.040		1	57807.275.085	40X70X120MM	1	57807.470.120
15X35X30MM	2	57807.185.030	30X60X55MM	1	57807.360.055	45X75X70MM	1	57807.525.070
20X45X40MM	2	57807.245.040		1		50X80X75MM	1	57807.580.075
20X45X75MM	1	57807.245.075						

Sprężyny śrubowe walcowe naciskowe

DIN 2095

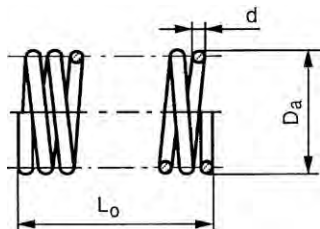

- Końcówki sprężyny zamknięte, nieszlifowane.

17912 Sprężyny śrubowe walcowe naciskowe

Y92A

Materiał Stal sprężynowa
Obróbka powierzchni Ocynkowane



d x D _a x L ₀	☒	Kod artykułu	d x D _a x L ₀	☒	Kod artykułu	d x D _a x L ₀	☒	Kod artykułu
0,5X3,5X12MM	100	17912.053.012	0,8X7,7X40MM	100	17912.077.040	1,5X12,0X75MM	50	17912.162.075
0,5X3,5X15MM	100	17912.053.015	0,8X7,7X50MM	100	17912.077.050			
0,5X3,5X20MM	100	17912.053.020				1,5X14,0X40MM	100	17912.164.040
0,5X3,5X25MM	100	17912.053.025	1,0X6,0X20MM	100	17912.106.020	1,5X14,0X60MM	100	17912.164.060
			1,0X6,0X25MM	100	17912.106.025	1,5X14,0X75MM	50	17912.164.075
0,5X4,5X12MM	100	17912.054.012	1,0X6,0X30MM	100	17912.106.030	1,5X14,0X100MM	50	17912.164.100
0,5X4,5X15MM	100	17912.054.015	1,0X6,0X50MM	100	17912.106.050			
0,5X4,5X20MM	100	17912.054.020				2,0X12,0X35MM	100	17912.212.035
0,5X4,5X25MM	100	17912.054.025	1,0X8,0X25MM	100	17912.108.025	2,0X12,0X50MM	100	17912.212.050
			1,0X8,0X30MM	100	17912.108.030	2,0X12,0X75MM	100	17912.212.075
0,5X6,5X20MM	100	17912.056.020	1,0X8,0X35MM	100	17912.108.035			
0,5X6,5X25MM	100	17912.056.025				2,0X14,0X50MM	100	17912.214.050
0,5X6,5X30MM	100	17912.056.030	1,0X10,0X25MM	100	17912.110.025	2,0X14,0X75MM	50	17912.214.075
0,5X6,5X35MM	100	17912.056.035	1,0X10,0X35MM	100	17912.110.035	2,0X14,0X100MM	50	17912.214.100
0,5X6,5X40MM	100	17912.056.040	1,0X10,0X40MM	100	17912.110.040			
			1,0X10,0X60MM	100	17912.110.060	2,0X20,0X60MM	50	17912.220.060
0,8X4,7X15MM	100	17912.074.015	1,0X10,0X75MM	100	17912.110.075	2,0X20,0X75MM	50	17912.220.075
0,8X4,7X20MM	100	17912.074.020	1,0X10,0X100MM	100	17912.110.100	2,0X20,0X100MM	100	17912.220.100
0,8X4,7X25MM	100	17912.074.025						
			1,5X8,5X25MM	100	17912.158.025	2,25X14,0X50MM	100	17912.239.050
0,8X5,7X25MM	100	17912.075.025	1,5X8,5X35MM	100	17912.158.035	2,25X14,0X75MM	100	17912.239.075
0,8X5,7X35MM	100	17912.075.035				2,25X14,0X100MM	100	17912.239.100
			1,5X9,0X40MM	100	17912.159.040			
0,8X6,7X20MM	100	17912.076.020	1,5X9,0X75MM	100	17912.159.075	2,25X17,0X60MM	50	17912.242.060
0,8X6,7X25MM	100	17912.076.025				2,25X17,0X75MM	50	17912.242.075
0,8X6,7X30MM	100	17912.076.030	1,5X10,0X35MM	100	17912.160.035	2,25X17,0X100MM	50	17912.242.100
0,8X6,7X35MM	100	17912.076.035	1,5X10,0X50MM	100	17912.160.050			
			1,5X10,0X75MM	100	17912.160.075	2,25X22,0X60MM	50	17912.247.060
0,8X7,7X25MM	100	17912.077.025	1,5X10,0X100MM	50	17912.160.100	2,25X22,0X75MM	50	17912.247.075
0,8X7,7X30MM	100	17912.077.030				2,25X22,0X100MM	50	17912.247.100
0,8X7,7X35MM	100	17912.077.035	1,5X12,0X40MM	100	17912.162.040			

- Ostrzeżenie: cynkowanie elektrolityczne tych produktów może wywołać kruchość wodorową.

Sprężyny śrubowe naciągowe/rozciągowe

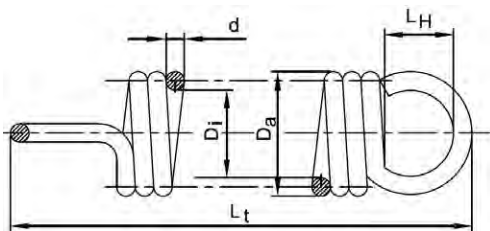

DIN 2097



- Z oczkiem angielskim $L_H \approx 1,1 D_e$.

17902 Sprężyny śrubowe naciągowe/rozciągowe

Y92A

Materiał Stal sprężynowa
Obróbka powierzchni Ocynkowane



d x D _e x L _t	☒	Kod artykułu	d x D _e x L _t	☒	Kod artykułu	d x D _e x L _t	☒	Kod artykułu
0,5X3,5X12MM	100	17902.053.012	0,8X7,7X40MM	100	17902.077.040	1,5X12,0X40MM	100	17902.162.040
0,5X3,5X15MM	100	17902.053.015	0,8X7,7X50MM	100	17902.077.050	1,5X12,0X75MM	100	17902.162.075
0,5X3,5X20MM	100	17902.053.020						
0,5X3,5X25MM	100	17902.053.025	1,0X6,0X20MM	100	17902.106.020	1,5X14,0X40MM	100	17902.164.040
			1,0X6,0X25MM	100	17902.106.025	1,5X14,0X60MM	100	17902.164.060
0,5X4,5X12MM	100	17902.054.012	1,0X6,0X30MM	100	17902.106.030	1,5X14,0X75MM	100	17902.164.075
0,5X4,5X15MM	100	17902.054.015	1,0X6,0X44MM	100	17902.106.044	1,5X14,0X100MM	50	17902.164.100
0,5X4,5X20MM	100	17902.054.020	1,0X6,0X50MM	100	17902.106.050			
0,5X4,5X25MM	100	17902.054.025				2,0X12,0X35MM	100	17902.212.035
			1,0X8,0X25MM	100	17902.108.025	2,0X12,0X50MM	100	17902.212.050
0,5X6,5X20MM	100	17902.056.020	1,0X8,0X30MM	100	17902.108.030	2,0X12,0X75MM	100	17902.212.075
0,5X6,5X25MM	100	17902.056.025	1,0X8,0X35MM	100	17902.108.035			
0,5X6,5X30MM	100	17902.056.030				2,0X14,0X50MM	100	17902.214.050
0,5X6,5X35MM	100	17902.056.035	1,0X10,0X25MM	100	17902.110.025	2,0X14,0X75MM	100	17902.214.075
0,5X6,5X40MM	100	17902.056.040	1,0X10,0X35MM	100	17902.110.035	2,0X14,0X100MM	50	17902.214.100
0,5X6,0X46MM	100	17902.056.046	1,0X10,0X40MM	100	17902.110.040			
			1,0X10,0X60MM	100	17902.110.060	2,0X20,0X60MM	50	17902.220.060
0,8X4,7X15MM	100	17902.074.015	1,0X10,0X75MM	100	17902.110.075	2,0X20,0X75MM	50	17902.220.075
0,8X4,7X20MM	100	17902.074.020	1,0X10,0X100MM	100	17902.110.100	2,0X20,0X100MM	50	17902.220.100
0,8X4,7X25MM	100	17902.074.025						
			1,5X8,5X25MM	100	17902.158.025	2,25X14,0X50MM	100	17902.239.050
0,8X5,7X25MM	100	17902.075.025	1,5X8,5X35MM	100	17902.158.035	2,25X14,0X75MM	100	17902.239.075
0,8X5,7X35MM	100	17902.075.035				2,25X14,0X100MM	50	17902.239.100
			1,5X9,0X40MM	100	17902.159.040			
0,8X6,7X20MM	100	17902.076.020	1,5X9,0X75MM	100	17902.159.075	2,25X17,0X60MM	100	17902.242.060
0,8X6,7X25MM	100	17902.076.025				2,25X17,0X75MM	50	17902.242.075
0,8X6,7X30MM	100	17902.076.030	1,5X10,0X35MM	100	17902.160.035	2,25X17,0X100MM	25	17902.242.100
0,8X6,7X35MM	100	17902.076.035	1,5X10,0X50MM	100	17902.160.050			
			1,5X10,0X75MM	100	17902.160.075	2,25X22,0X60MM	100	17902.247.060
0,8X7,7X25MM	100	17902.077.025	1,5X10,0X100MM	100	17902.160.100	2,25X22,0X75MM	50	17902.247.075
0,8X7,7X30MM	100	17902.077.030				2,25X22,0X100MM	25	17902.247.100
0,8X7,7X35MM	100	17902.077.035						

- Ostrzeżenie: cynkowanie elektrolityczne tych produktów może wywołać kruchość wodorową.

Uchwyty kuliste

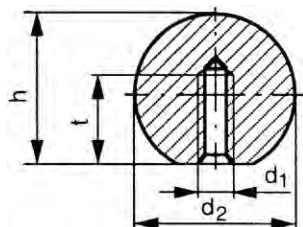

DIN ≈319



Informacje techniczne

d ₁ x d ₂	h	P	t	d ₁ x d ₂	h	P	t
M3x10	9.5	0.5	5	M8x36	34	1.25	16
M4x12	11	0.7	7.5	M8x40	37	1.25	21
M4x16	15	0.7	7.5	M10x32	29	1.5	16
M4x20	18	0.7	10.5	M10x35	21	1.5	13.5
M5x16	15	0.8	7.5	M10x40	37	1.5	21
M5x20	18	0.8	10.5	M10x45	43	1.5	21
M5x25	22.5	0.8	13.5	M10x50	46	1.5	25
M6x16	15	1	7.5	M12x40	37	1.75	21
M6x20	18	1	10.5	M12x45	43	1.75	21
M6x25	22.5	1	13.5	M12x50	46	1.75	25
M6x32	29	1	16	M12x60	57	1.75	30
M8x20	18	1.25	10.5	M14x40	37	1.75	21
M8x25	13.5	1.25	13.5	M16x50	46	2	25
M8x32	29	1.25	16	M16x60	57	2	30
M8x35	21	1.25	13.5				

Grupy katalogowe

Gwint	Materiał	Klasa	Kolor	Kod	Strona
M	Plastik PF	FS31	Czarny	56914	12-76
M	Plastik PF	FS31	Czarny	56916	12-76

56914 Uchwyty kuliste, typ C

W03F

Gwint	Metryczny	DIN	≈319 C
Materiał	Plastik Fenoloformaldehyd (bakelit)		
Klasa	FS31		
Kolor	Czarny		



d ₁ x d ₂	☒	Kod artykułu	d ₁ x d ₂	☒	Kod artykułu	d ₁ x d ₂	☒	Kod artykułu
M3X10	5	56914.030.010	M6X25	5	56914.060.025	M10X45	5	56914.100.045
M4X12	5	56914.040.012	M6X32	5	56914.060.032	M10X50	5	56914.100.050
M4X16	5	56914.040.016	M8X20	5	56914.080.020	M12X40	5	56914.120.040
M4X20	5	56914.040.020	M8X25	5	56914.080.025	M12X45	5	56914.120.045
M5X16	5	56914.050.016	M8X32	5	56914.080.032	M12X50	5	56914.120.050
M5X20	5	56914.050.020	M8X35	5	56914.080.035	M14X40	5	56914.140.040
M5X25	5	56914.050.025	M8X40	5	56914.080.040	M16X50	5	56914.160.050
M6X16	5	56914.060.016	M10X32	5	56914.100.032	M16X60	5	56914.160.060
M6X20	5	56914.060.020	M10X35	5	56914.100.035			
			M10X40	5	56914.100.040			

56916 Uchwyty kuliste, typ E

W03F

Gwint	Metryczny	DIN	≈319 E
Materiał	Plastik Fenoloformaldehyd (bakelit)		
Klasa	FS31		
Kolor	Czarny		



d ₁ x d ₂	☒	Kod artykułu	d ₁ x d ₂	☒	Kod artykułu	d ₁ x d ₂	☒	Kod artykułu
M4X16	10	56916.040.016	M8X32	5	56916.080.032	M10X50	5	56916.100.050
M5X20	10	56916.050.020	M8X36	5	56916.080.036	M12X40	5	56916.120.040
M5X25	10	56916.050.025	M8X40	5	56916.080.040	M12X50	5	56916.120.050
M6X25	5	56916.060.025	M10X40	5	56916.100.040	M12X60	5	56916.120.060
M6X32	5	56916.060.032	M10X45	5	56916.100.045	M16X60	5	56916.160.060

56916 Uchwyty kuliste, typ E

- Z tuleją gwintowaną ze stali cynkowanej, rozmiary M4 x 16 i M16 x 60 z tuleją gwintowaną z mosiądzu.

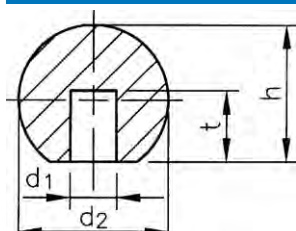
Uchwyty kulowe z otworem stożkowym

DIN ≈319 M

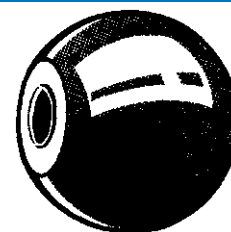
Informacje techniczne

d ₁ x d ₂	h	t	d ₁ x d ₂	h	t
4x16	15	9	10x32	29	15
5x20	18	12	10x40	37	20
6x25	22.5	15	12x40	37	20
8x25	22.5	15	12x50	46	22
8x32	29	15	16x50	46	22

56915 Uchwyty kulowe z otworem stożkowym, typ M

W03F

Materiał Plastik Fenoloformaldehyd (bakelit)
Klasa FS31
Kolor Czarny



d ₁ x d ₂	☒	Kod artykułu	d ₁ x d ₂	☒	Kod artykułu	d ₁ x d ₂	☒	Kod artykułu
4X16MM	10	56915.040.016	8X32MM	5	56915.080.032	12X40MM	5	56915.120.040
5X20MM	10	56915.050.020	10X32MM	5	56915.100.032	12X50MM	5	56915.120.050
6X25MM	5	56915.060.025	10X40MM	5	56915.100.040	16X50MM	5	56915.160.050
8X25MM	5	56915.080.025						

Rękojeści gwiazdowe, typ L

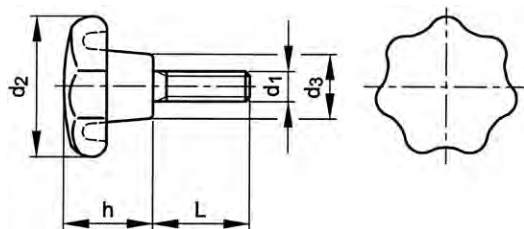

DIN ≈6336 L

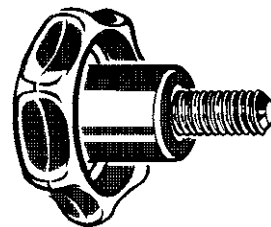

Informacje techniczne

d_1	d_2	d_3	h	P
M5	25	12	16	0.8
M6	32	14	20	1
M8	40	16	25	1.25
M10	50	21	32	1.5

56922 Rękojeści gwiazdowe, typ L

W03F

Gwint Metryczny
Materiał Plastik Fenoloformaldehyd (bakelit)
Klasa FS31
Kolor Czarny

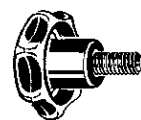

$d_1 \times L$	☒	Kod artykułu	$d_1 \times L$	☒	Kod artykułu	$d_1 \times L$	☒	Kod artykułu
M5X15	10	56922.050.015	M8X15	10	56922.080.015	M10X15	5	56922.100.015
M5X20	10	56922.050.020	M8X20	10	56922.080.020	M10X20	5	56922.100.020
M6X15	10	56922.060.015	M8X25	10	56922.080.025	M10X25	5	56922.100.025
M6X20	10	56922.060.020	M8X30	10	56922.080.030	M10X30	5	56922.100.030
M6X25	10	56922.060.025	M8X40	10	56922.080.040	M10X35	5	56922.100.035
M6X30	10	56922.060.030	M8X50	10	56922.080.050			

- Z końcówką gwintowaną ze stali cynkowanej.

Rękojeści gwiazdowe, typ K

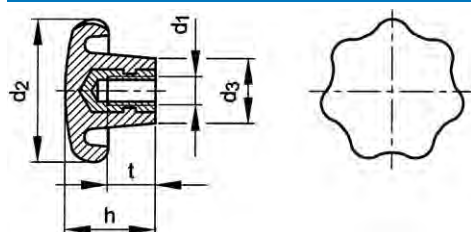

DIN ≈6336 K

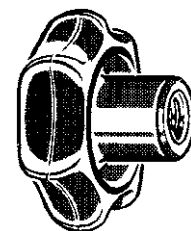

Informacje techniczne

$d_1 \times d_2$	d_2	d_3	h	P	t
M4x20	20	10	17	0.7	8
M5x25	25	12	16	0.8	10.5
M5x32	32	14	20	0.8	10.5
M6x32	32	14	20	1	13.5
M6x40	40	16	25	1	13.5
M8x40	40	16	25	1.25	16
M8x50	50	21	32	1.25	16
M8x63	63	23	40	1.25	16
M10x50	50	21	32	1.5	21
M10x63	63	23	40	1.5	21
M12x50	50	21	32	1.75	21
M12x63	63	23	40	1.75	25
M12x80	80	34	48	1.75	25
M16x80	80	34	48	2	30

56921	Rękojeści gwiazdowe, typ K	W03F
Gwint	Metryczny	
Materiał	Plastik Fenoloformaldehyd (bakelit)	
Klasa	FS31	
Kolor	Czarny	

$d_1 \times d_2$	☒	Kod artykułu	$d_1 \times d_2$	☒	Kod artykułu	$d_1 \times d_2$	☒	Kod artykułu
M4X20	10	56921.040.020	M8X40	10	56921.080.040	M12X50	5	56921.120.050
M5X25	10	56921.050.025	M8X50	10	56921.080.050	M12X63	5	56921.120.063
M5X32	10	56921.050.032	M8X63	10	56921.080.063	M12X80	5	56921.120.080
M6X32	10	56921.060.032	M10X50	5	56921.100.050	M16X80	5	56921.160.080
M6X40	10	56921.060.040	M10X63	5	56921.100.063			

- Z tuleją gwintowaną ze stali cynkowanej, rozmiar M4 x 20 z tuleją gwintowaną z mosiądzu.

Rękojeści czterouchwytowe

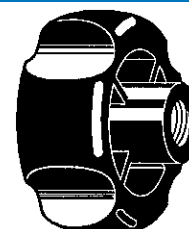
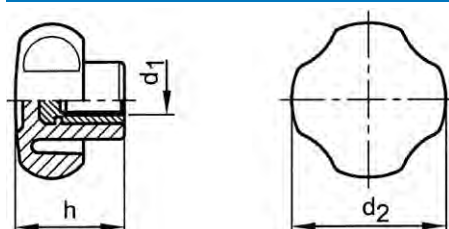

Informacje techniczne

d_1	d_2	h	P	d_1	d_2	h	P
M4	20	13	0.7	M8	40	28	1.25
M5	20	13	0.8	M10	50	32	1.5
M6	25	15	1	M12	60	38	1.75

Grupy katalogowe

Gwint	Materiał	Kolor	Kod	Strona
M	GRP	Czarny	57040	12-79
M	GRP	otwór przelotowy	57041	12-79
M	GRP	ze szpilką gwintowaną	57043	12-80

57040	Rękojeści z mosiężną tuleją gwintowaną	W03A
Gwint	Metryczny	
Materiał	Tworzywo sztuczne wzmocnione włóknem szklanym	
Kolor	Czarny	

d_1	☒	Kod artykułu	d_1	☒	Kod artykułu	d_1	☒	Kod artykułu
M4	10	57040.040.001	M6	10	57040.060.001	M10	5	57040.100.001
M5	10	57040.050.001	M8	10	57040.080.001	M12	5	57040.120.001

57041	Rękojeści otwarte	W03A
Gwint	Metryczny	
Materiał	Tworzywo sztuczne wzmocnione włóknem szklanym	
Kolor	Czarny	

d_1	☒	Kod artykułu	d_1	☒	Kod artykułu	d_1	☒	Kod artykułu
M4	10	57041.040.001	M6	10	57041.060.001	M10	5	57041.100.001
M5	10	57041.050.001	M8	10	57041.080.001	M12	5	57041.120.001

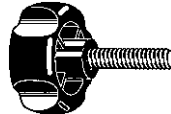
57043	Rękojeści z cynkowaną końcówką gwintowaną	W03A
Gwint	Metryczny	
Materiał	Tworzywo sztuczne wzmocnione włóknem szklanym	
Kolor	Czarny	

$d_1 \times L$	☒	Kod artykułu	$d_1 \times L$	☒	Kod artykułu	$d_1 \times L$	☒	Kod artykułu
M4X10	10	57043.040.010	M6X15	10	57043.060.015	M10X30	5	57043.100.030
M5X16	10	57043.050.015	M8X30	10	57043.080.030	M12X50	5	57043.120.050

Rękojeści czterouchwytowe, głębokie

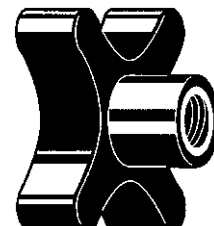
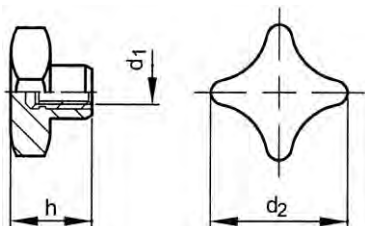

Informacje techniczne

d_1	d_2	h	P	d_1	d_2	h	P
M6	40	24	1	M10	50	28.5	1.5
M8	40	24	1.25	M12	60	33	1.75

Grupy katalogowe

Gwint	Materiał	Kolor	Kod	Strona
M	GRP	Czarny	57045	12-80
M	GRP	ze szpiłką gwintowaną	57046	12-80
M	GRP	otwór przelotowy	57048	12-80

57045	Rękojeści z mosiężną tuleją gwintowaną	W03A
Gwint	Metryczny	
Materiał	Tworzywo sztuczne wzmocnione włóknem szklanym	
Kolor	Czarny	

d_1	☒	Kod artykułu	d_1	☒	Kod artykułu	d_1	☒	Kod artykułu
M6	10	57045.060.001	M10	5	57045.100.001	M12	5	57045.120.001
M8	10	57045.080.001						

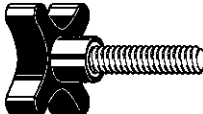
57046	Rękojeści ze stalową szpiłką gwintowaną	W03A
Gwint	Metryczny	
Materiał	Tworzywo sztuczne wzmocnione włóknem szklanym	
Kolor	Czarny	

$d_1 \times L$	☒	Kod artykułu	$d_1 \times L$	☒	Kod artykułu	$d_1 \times L$	☒	Kod artykułu
M6X20	10	57046.060.020	M10X40	5	57046.100.040	M12X50	5	57046.120.050
M8X30	10	57046.080.030						

57048	Rękojeści otwarte z mosiężną tuleją gwintowaną	W03A
Gwint	Metryczny	
Materiał	Tworzywo sztuczne wzmocnione włóknem szklanym	
Kolor	Czarny	

d_1	☒	Kod artykułu	d_1	☒	Kod artykułu	d_1	☒	Kod artykułu
M6	10	57048.060.001	M10	5	57048.100.001	M12	5	57048.120.001
M8	10	57048.080.001						

Rękojeści tarczowe

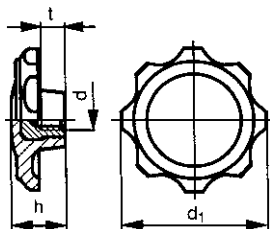

Informacje techniczne

d x d ₁ x h	P	d x d ₁ x h	P
M5x30x20	0.8	M8x40x24	1.25
M6x30x20	1	M8x50x16	1.25
M6x30x24	1	M10x50x28.5	1.5
M6x40x14.5	1	M10x70x20	1.5
M6x40x24	1	M12x60x33	1.75

Grupy katalogowe

Gwint	Materiał	Kolor	Kod	Strona
M	GRP	Czarny	57090	12-81
M	GRP	otwór przelotowy	57091	12-81
M	GRP	ze szpilką gwintowaną	57092	12-81
M	GRP	Czarny	57011	12-82
M	GRP	ze szpilką gwintowaną	57012	12-82

57090 Rękojeści tarczowe z mosiężną tuleją gwintowaną

W03A

Gwint	Metryczny
Materiał	Tworzywo sztuczne wzmocnione włóknem szklanym
Kolor	Czarny



d x d ₁ x h	☒	Kod artykułu	d x d ₁ x h	☒	Kod artykułu	d x d ₁ x h	☒	Kod artykułu
M6X30X24	10	57090.060.001	M10X50X28.5	5	57090.100.001	M12X60X33	5	57090.120.001
M8X40X24	10	57090.080.001						

57091 Rękojeści przelotowe

W03A

Gwint	Metryczny
Materiał	Tworzywo sztuczne wzmocnione włóknem szklanym
Kolor	Czarny



d x d ₁ x h	☒	Kod artykułu	d x d ₁ x h	☒	Kod artykułu	d x d ₁ x h	☒	Kod artykułu
M6X40X24	10	57091.060.001	M10X50X28,5	5	57091.100.001	M12X60X33	5	57091.120.001
M8X40X24	10	57091.080.001						

57092 Rękojeści z cynkową szpilką gwintowaną

W03A

Gwint	Metryczny
Materiał	Tworzywo sztuczne wzmocnione włóknem szklanym
Kolor	Czarny

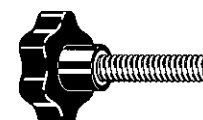

d x L	☒	Kod artykułu	d x L	☒	Kod artykułu	d x L	☒	Kod artykułu
M6X20	10	57092.060.020	M10X30	5	57092.100.030	M12X50	5	57092.120.050
M8X30	10	57092.080.030						

57011	Rękojeści tarczowe z gwintowaną tuleją ze stali nierdzewnej A1	W03A
Gwint	Metryczny	
Materiał	Tworzywo sztuczne wzmocnione włóknem szklanym	
Kolor	Czarny	

d x d₁ x h	☒	Kod artykułu	d x d₁ x h	☒	Kod artykułu	d x d₁ x h	☒	Kod artykułu
M5X30X20	10	57011.050.001	M8X40X24	10	57011.080.001	M12X60X33	5	57011.120.001
M6X30X20	10	57011.060.001	M10X50X28.5	5	57011.100.001			

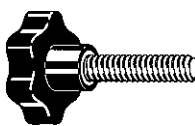
57012	Rękojeści z gwintowaną szpilką ze stali nierdzewnej A2	W03A
Gwint	Metryczny	
Materiał	Tworzywo sztuczne wzmocnione włóknem szklanym	
Kolor	Czarny	

d x L	☒	Kod artykułu	d x L	☒	Kod artykułu	d x L	☒	Kod artykułu
M5X15	10	57012.050.015	M8X20	10	57012.080.020	M12X40	5	57012.120.040
M6X20	10	57012.060.020	M10X30	5	57012.100.030			

Rękojeści trójkątne gwiazdowe

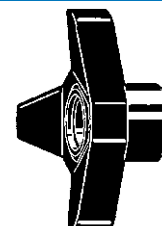
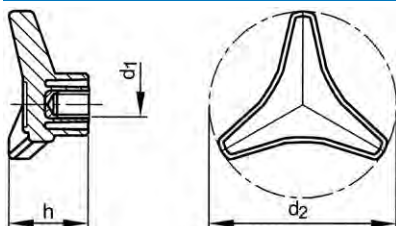

Informacje techniczne

d ₁	d ₂	h	P	d ₁	d ₂	h	P
M8	85	36	1.25	M12	105	45	1.75
M10	85	36	1.5	M14	105	45	2

Grupy katalogowe

Gwint	Materiał	Kolor	Kod	Strona
M	GRP	Czarny	57020	12-82
M	GRP	ze szpilką gwintowaną	57021	12-82
M	GRP	otwór przelotowy	57023	12-83

57020	Rękojeści trójkątne gwiazdowe z mosiężną tuleją cynkowaną	W03A
Gwint	Metryczny	
Materiał	Tworzywo sztuczne wzmocnione włóknem szklanym	
Kolor	Czarny	

d₁	☒	Kod artykułu	d₁	☒	Kod artykułu	d₁	☒	Kod artykułu
M8	10	57020.080.001	M12	5	57020.120.001	M14	5	57020.140.001
M10	10	57020.100.001						

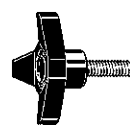
57021	Rękojeści trójkątne gwiazdowe z ocynkowaną szpilką gwintowaną	W03A
Gwint	Metryczny	
Materiał	Tworzywo sztuczne wzmocnione włóknem szklanym	
Kolor	Czarny	

d₁ x L	☒	Kod artykułu	d₁ x L	☒	Kod artykułu	d₁ x L	☒	Kod artykułu
M8X30	10	57021.080.030	M12X50	5	57021.120.050	M14X50	5	57021.140.050
M10X40	10	57021.100.040						

57023	Rękojeści trójkątne gwiazdowe otwarte z mosiężną tuleją gwintową		W03A
Gwint	Metryczny		
Materiał	Tworzywo sztuczne wzmocnione włóknem szklanym		
Kolor	Czarny		

d₁	☒	Kod artykułu	d₁	☒	Kod artykułu	d₁	☒	Kod artykułu
M8	10	57023.080.001	M12	5	57023.120.001	M14	5	57023.140.001
M10	10	57023.100.001						

Uchwyty pięciograbowe

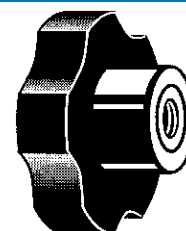
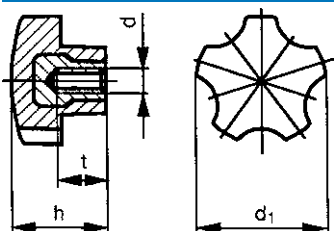

Informacje techniczne

d	d ₁	h	P	d	d ₁	h	P
M5	32	22.4	0.8	M8	40	28	1.25
M6	32	22.4	1	M10	40	28	1.5

56970	Uchwyty pięciograbowe		W03A
Gwint	Metryczny		
Materiał	Plastik Fenoloformaldehyd (bakelit)		
Klasa	FS31		
Kolor	Czarny		

d x t	☒	Kod artykułu	d x t	☒	Kod artykułu	d x t	☒	Kod artykułu
M5X10	10	56970.050.010	M8X14	10	56970.080.014	M10X14	5	56970.100.014
M6X9	10	56970.060.009						

- Z tuleją gwintowaną z mosiądzu, rozmiary M8 x 14 i M10 x 14 z tuleją gwintowaną ze stali cynkowanej.

Rękojeści radełkowane do śrub z łbem sześciokątnym i nakrętek sześciokątnych

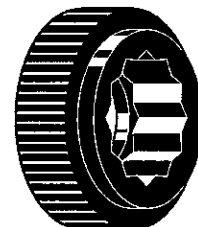
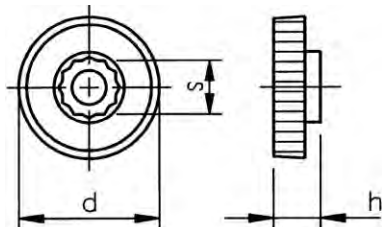

Informacje techniczne

W użyciu z x d	d	s	W użyciu z x d	d	s
M4x13	13	7	M6x25	25	10
M4x17	17	7	M8x25	25	13
M5x17	17	8	M8x36	36	13
M5x20	20	8	M10x36	36	17
M6x20	20	10			

Grupy katalogowe

Gwint	Materiał	Kolor	Kod	Strona
M	Plastik POM	cienka	56730	12-84
M	Plastik POM	wysoka	56735	12-84

56730 Rękojeści radełkowane niskie do śrub z łbem sześciokątnym i nakrętek sześciokątnych

W02A

Gwint	Metryczny
Materiał	Plastik Polioksymetylen
Kolor	Czarny



W użyciu z x d x h	☒	Kod artykułu	W użyciu z x d x h	☒	Kod artykułu	W użyciu z x d x h	☒	Kod artykułu
M4X13x4,5	100	56730.040.013	M5X20x6,5	100	56730.050.020	M8X25x8	100	56730.080.025
M4X17x5,5	100	56730.040.017	M6X20x6,5	100	56730.060.020	M8X36x10	100	56730.080.036
M5X17x5,5	100	56730.050.017	M6X25x8	100	56730.060.025	M10X36x10	100	56730.100.036

56735 Rękojeści radełkowane wysokie do śrub z łbem sześciokątnym i nakrętek sześciokątnych

W02A

Gwint	Metryczny
Materiał	Plastik Polioksymetylen
Kolor	Czarny

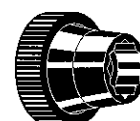

W użyciu z x d x h	☒	Kod artykułu	W użyciu z x d x h	☒	Kod artykułu	W użyciu z x d x h	☒	Kod artykułu
M4X13x9,5	100	56735.040.013	M5X20x15	100	56735.050.020	M8X25x18	100	56735.080.025
M4X17x11,5	100	56735.040.017	M6X20x15	100	56735.060.020	M8X36x23	100	56735.080.036
M5X17x11,5	100	56735.050.017	M6X25x18	100	56735.060.025	M10X36x23	100	56735.100.036

Uchwyty radełkowane do śrub z gniazdem sześciokątnym

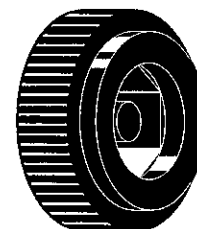
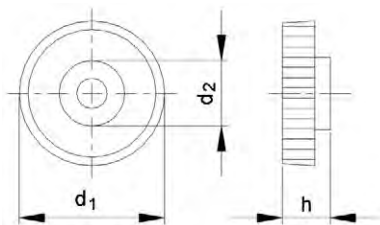

Informacje techniczne

W użyciu z x d ₁	d ₁	d ₂	h	W użyciu z x d ₁	d ₁	d ₂	h
M3x11	11	5.5	4.5	M6x20	20	10	7.5
M4x13	13	7	5.5	M6x25	25	10	7.5
M4x17	17	7	5.5	M8x25	25	13	9.5
M5x17	17	8.5	6.5	M8x36	36	13	9.5
M5x20	20	8.5	6.5	M10x36	36	16	12

56740 Uchwyty radełkowane do śrub z gniazdem sześciokątnym

W02A

Gwint Metryczny
Materiał Plastik Polioksymetylen
Kolor Czarny



W użyciu z	☒	Kod artykułu	W użyciu z	☒	Kod artykułu	W użyciu z	☒	Kod artykułu
M3X11	100	56740.030.011	M5X20	100	56740.050.020	M8X25	100	56740.080.025
M4X13	100	56740.040.013	M6X20	100	56740.060.020	M8X36	100	56740.080.036
M4X17	100	56740.040.017	M6X25	100	56740.060.025	M10X36	100	56740.100.036
M5X17	100	56740.050.017						

Uchwyty radełkowane

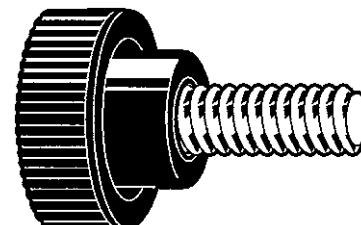
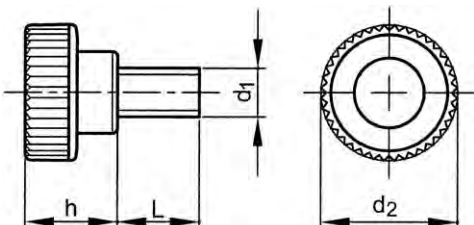

Informacje techniczne

d ₁	d ₂	h	P	d ₁	d ₂	h	P
M5	21	15	0.8	M8	26	18	1.25
M6	21	15	1	M10	33	23	1.5

Grupy katalogowe

Gwint	Materiał	Kolor	Kod	Strona
M	GRP ze szpilką gwintowaną	Czarny	57025	12-85
M	GRP z tuleją gwintowaną	Czarny	57027	12-86
M	GRP przelotowe z tuleją gwintowaną	Czarny	57028	12-86

57025 Uchwyty radełkowane ze szpilką gwintowaną ze stali ocynkowanej

W03A

Gwint Metryczny
Materiał Tworzywo sztuczne wzmocnione włóknem szklanym
Kolor Czarny

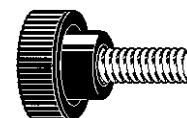

d ₁ x L	☒	Kod artykułu	d ₁ x L	☒	Kod artykułu	d ₁ x L	☒	Kod artykułu
M5X15	10	57025.050.015	M8X25	10	57025.080.025	M10X30	5	57025.100.030
M6X20	10	57025.060.020						

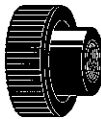
57027	Uchwyty radełkowane z mosiężną tuleją gwintowaną				W03A	
Gwint	Metryczny					
Materiał	Tworzywo sztuczne wzmocnione włóknem szklanym					
Kolor	Czarny					

d₁	☒	Kod artykułu	d₁	☒	Kod artykułu	d₁	☒	Kod artykułu
M5	10	57027.050.001	M8	10	57027.080.001	M10	5	57027.100.001
M6	10	57027.060.001						

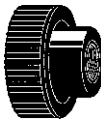
57028	Uchwyty radełkowane otwarte z mosiężną tuleją gwintową				W03A	
Gwint	Metryczny					
Materiał	Tworzywo sztuczne wzmocnione włóknem szklanym					
Kolor	Czarny					

d₁	☒	Kod artykułu	d₁	☒	Kod artykułu	d₁	☒	Kod artykułu
M5	10	57028.050.001	M8	10	57028.080.001	M10	5	57028.100.001
M6	10	57028.060.001						

Uchwyty radełkowane, seria 700

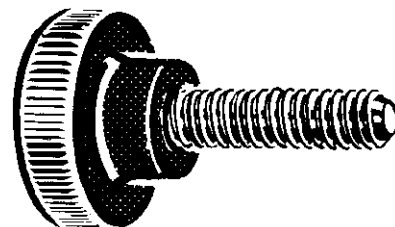
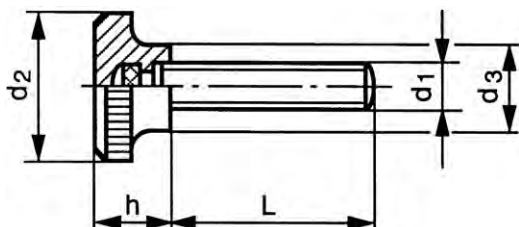

Informacje techniczne

Typ	d ₁	d ₂	d ₃	h	P
700	M5	18	10	12	0.8
710	M6	22	12	13	1
711	M8	26	15	13	1.25

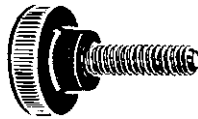
56931	Uchwyty radełkowane ze szpilką gwintowaną ze stali ocynkowanej				W03F	
Gwint	Metryczny					
Materiał	Plastik Fenoloformaldehyd (bakelit)					
Klasa	FS31					
Kolor	Czarny					

Typ-d₁ x L	☒	Kod artykułu	Typ-d₁ x L	☒	Kod artykułu	Typ-d₁ x L	☒	Kod artykułu
700-M5X20	10	56931.050.020	710-M6X30	10	56931.060.030	711-M8X30	10	56931.080.030
700-M5X30	10	56931.050.030	711-M8X20	10	56931.080.020	711-M8X40	10	56931.080.040
710-M6X20	10	56931.060.020						

- W zależności od dostępności gwintowana końcówka może zostać dostarczona cynkowana, jak również cynkowana po żółtej pasywacji.

Pokrętła radełkowane o zmniejszonej średnicy

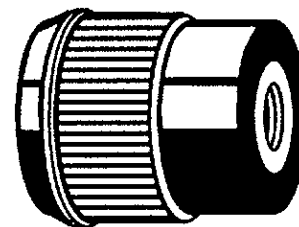
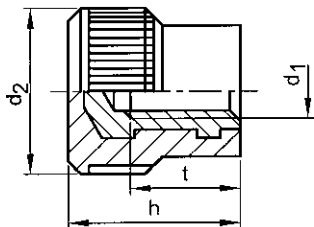

Informacje techniczne

d ₁	d ₂	h	P
M3	12	13.5	0.5
M4	12	13.5	0.7
M5	15	15.5	0.8
M6	15	15.5	1

56972 Uchwyty radełkowane z mosięzną tuleją gwintowaną

W03A

Gwint	Metryczny
Materiał	Plastik Fenoloformaldehyd (bakelit)
Klasa	FS31
Kolor	Czarny

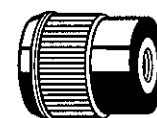

d ₁ x t	☒	Kod artykułu	d ₁ x t	☒	Kod artykułu	d ₁ x t	☒	Kod artykułu
M3X6,5	25	56972.030.006	M5X10	10	56972.050.010	M6X9	10	56972.060.009
M4X10	25	56972.040.010						

Uchwyty skrzydełkowe

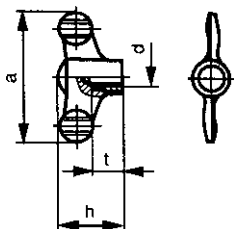

Informacje techniczne

d	a	h	P	t
M5	50	24	0.8	10
M6	50	24	1	10
M8	75	35	1.25	14
M10	75	35	1.5	14

56966 Uchwyty skrzydełkowe

W03A

Gwint	Metryczny
Materiał	Plastik Poliamid (nylon)
Klasa	6
Kolor	Czarny



d	☒	Kod artykułu	d	☒	Kod artykułu	d	☒	Kod artykułu
M5	10	56966.050.001	M8	5	56966.080.001	M10	5	56966.100.001
M6	10	56966.060.001						

- Z tuleją gwintowaną ze stali cynkowanej, pasywacja na żółto.

Nakrętki skrzydełkowe

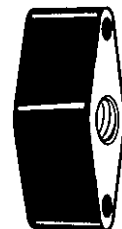
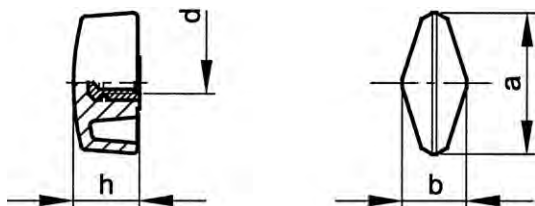

Informacje techniczne

d	a	b	h	P
M5	33	15	16.5	0.8
M6	33	15	16.5	1
M8	33	15	16.5	1.25
M10	45	19	17	1.5

57051 Nakrętki skrzydełkowe z mosiężną tuleją gwintowaną

W03A

Gwint Metryczny
Materiał Tworzywo sztuczne wzmocnione włóknem szklanym
Kolor Czarny



d	☒	Kod artykułu	d	☒	Kod artykułu	d	☒	Kod artykułu
M5	10	57051.050.001	M8	10	57051.080.001	M10	5	57051.100.001
M6	10	57051.060.001						

- Kształt rozmiaru M10 odbiega od normy.

Śruby skrzydełkowe

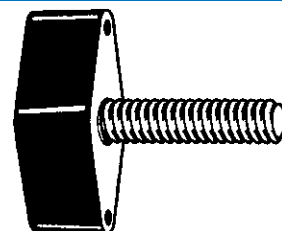
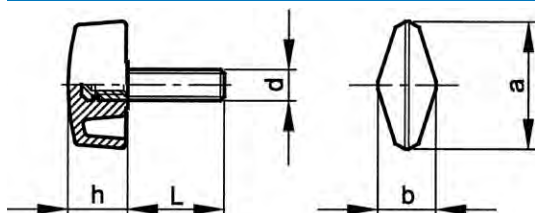

Informacje techniczne

d	a	b	h	P
M5	33	15	16.5	0.8
M6	33	15	16.5	1
M8	33	15	16.5	1.25
M10	45	19	17	1.5

57050 Śruby skrzydełkowe z cynkowaną końcówką gwintowaną

W03A

Gwint Metryczny
Materiał Tworzywo sztuczne wzmocnione włóknem szklanym
Kolor Czarny

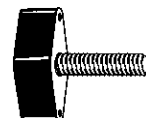

d x L	☒	Kod artykułu	d x L	☒	Kod artykułu	d x L	☒	Kod artykułu
M5X15	10	57050.050.015	M8X25	10	57050.080.025	M10X30	5	57050.100.030
M6X20	10	57050.060.020						

- Kształt rozmiaru M10 odbiega od normy.

Uchwyty w kształcie T, plastikowe

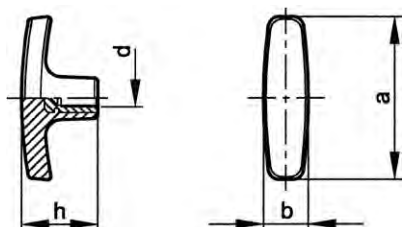

Informacje techniczne

d	a	b	h	P
M5	50	15	24	0.8
M6	60	17	33	1
M8	60	17	33	1.25
M10	72	18	35	1.5

Grupy katalogowe

Gwint	Materiał	Kolor	Kod	Strona	
M	GRP	z tuleją gwintowaną	Czarny	57053	12-89
M	GRP	ze szpilką gwintowaną	Czarny	57054	12-89

57053 Uchwyty w kształcie T z mosiężną tuleją gwintowaną

W03A

Gwint	Metryczny
Materiał	Tworzywo sztuczne wzmocnione włóknem szklanym
Kolor	Czarny



d	☒	Kod artykułu	d	☒	Kod artykułu	d	☒	Kod artykułu
M5	10	57053.050.001	M8	10	57053.080.001	M10	5	57053.100.001
M6	10	57053.060.001						

57054 Rączki w kształcie T z cynkową końcówką gwintowaną

W03A

Gwint	Metryczny
Materiał	Tworzywo sztuczne wzmocnione włóknem szklanym
Kolor	Czarny



d x L	☒	Kod artykułu	d x L	☒	Kod artykułu	d x L	☒	Kod artykułu
M5X20	10	57054.050.020	M8X20	10	57054.080.020	M10X30	5	57054.100.030
M6X20	10	57054.060.020						

Uchwyty mostkowe z tulejami gwintowanymi, metryczne

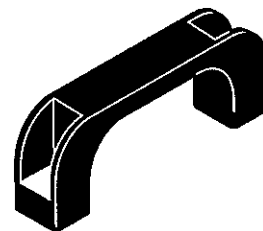
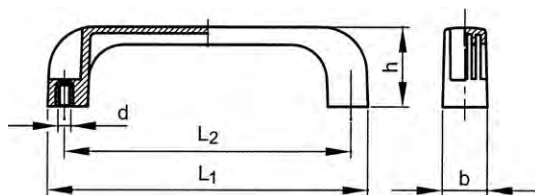

Informacje techniczne

d x L ₁	b	h	L ₂	P
M5x110	21	37	94	0.8
M6x139	24	40	120	1
M6x151	26	43	132	1
M8x200	28	50	180	1.25
M10x260	32	53	235	1.5

57067 Uchwyty mostkowe z tulejami gwintowanymi, metryczne

W03A

Gwint Metryczny
Materiał Tworzywo sztuczne wzmocnione włóknem szklanym



d x L ₁	☒	Kod artykułu	d x L ₁	☒	Kod artykułu	d x L ₁	☒	Kod artykułu
M5X110	5	57067.050.110	M6X151	5	57067.060.151	M10X260	2	57067.100.260
M6X139	5	57067.060.139	M8X200	2	57067.080.200			

Rączki mostkowe, niemetryczne

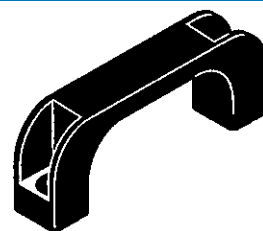
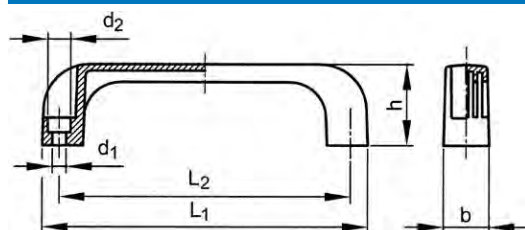

Informacje techniczne

d ₁ x L ₁	b	d ₂	h	L ₂
6.5x110	21	11	37	94
6.5x139	24	14	40	120
8.5x151	26	14	43	132
8.5x200	28	14.5	50	180
10.5x260	32	17	53	235

57066 Uchwyty mostkowe, niemetryczne

W03A

Materiał Tworzywo sztuczne wzmocnione włóknem szklanym
Kolor Czarny



d ₁ x L ₁	☒	Kod artykułu	d ₁ x L ₁	☒	Kod artykułu	d ₁ x L ₁	☒	Kod artykułu
6,5X110MM	5	57066.065.110	8,5X151MM	5	57066.085.151	10,5X260MM	2	57066.105.260
6,5X139MM	5	57066.065.139	8,5X200MM	2	57066.085.200			

Rączki mostkowe pełne, metryczne

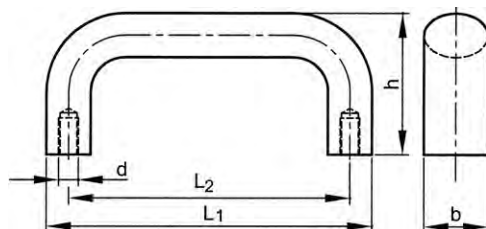

Informacje techniczne

d x L ₁	b	h	L ₂	P
M5x106.5	20	40.5	94	0.8
M6x134	25	50	117	1
M6x148	25	50	132	1
M8x168	29	58	150	1.25
M8x197	29	58	179	1.25

57014 Uchwyty mostkowe pełne

W03A

Gwint Metryczny
Material Tworzywo sztuczne wzmocnione włóknem szklanym
Kolor Czarny



d x L ₁	☒	Kod artykułu	d x L ₁	☒	Kod artykułu	d x L ₁	☒	Kod artykułu
M5X106	5	57014.050.106	M6X148	5	57014.060.148	M8X197	2	57014.080.197
M6X134	5	57014.060.134	M8X168	2	57014.080.168			

Uchwyty mostkowe, niemetryczne

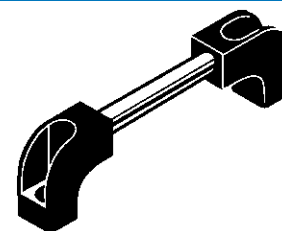
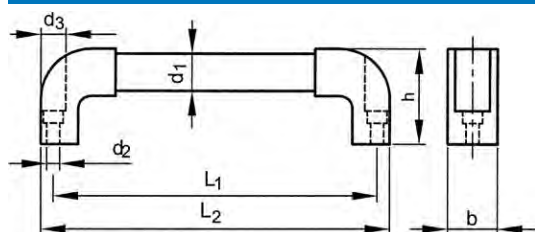

Informacje techniczne

d ₁ x L ₁	b	d ₂	d ₃	h	L ₂
20x200	30	8.5	14	62	220
20x250	30	8.5	14	62	270
20x300	30	8.5	14	62	320
30x350	40	10.5	16	77	374
30x400	40	10.5	16	77	424
30x500	40	10.5	16	77	524

57015 Uchwyty mostkowe, niemetryczne

W03A

Material Tworzywo sztuczne wzmocnione włóknem szklanym
Kolor Czarny

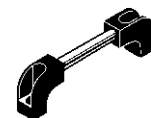

d ₁ x L ₁	☒	Kod artykułu	d ₁ x L ₁	☒	Kod artykułu	d ₁ x L ₁	☒	Kod artykułu
20X200MM	2	57015.020.200	20X300MM	2	57015.020.300	30X400MM	2	57015.030.400
20X250MM	2	57015.020.250	30X350MM	2	57015.030.350	30X500MM	2	57015.030.500

- Z uchwytem rurowym z anodowanego aluminium

Uchwyty stożkowe płaskie, plastikowe

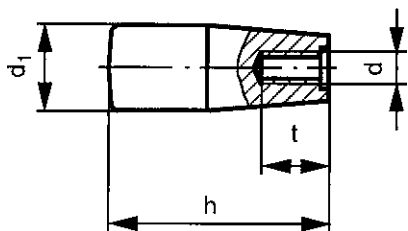

Informacje techniczne

d	d ₁	h	P
M6	17	45	1
M8	17	45	1.25
M10	28	70	1.5

56955 Uchwyty stożkowe płaskie, plastikowe

W03A

Gwint Metryczny
Materiał Plastik Fenoloformaldehyd (bakelit)
Klasa FS31
Kolor Czarny



d x t	☒	Kod artykułu	d x t	☒	Kod artykułu	d x t	☒	Kod artykułu
M6X14	10	56955.060.014	M8X16	10	56955.080.016	M10X28	5	56955.100.028

Rączki stożkowe okrągłe, plastikowe

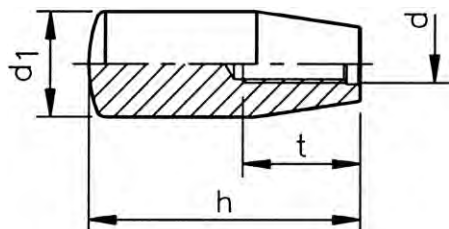

Informacje techniczne

d	d ₁	h	P	t
M5	18	40	0.8	20
M6	20	50	1	20
M8	23	60	1.25	27
M10	27	80	1.5	34
M12	29	90	1.75	42

57030 Rączki stożkowe okrągłe, plastikowe

W03A

Gwint Metryczny
Materiał Tworzywo sztuczne wzmocnione włóknem szklanym
Kolor Czarny



d	☒	Kod artykułu	d	☒	Kod artykułu	d	☒	Kod artykułu
M5	10	57030.050.001	M8	10	57030.080.001	M12	5	57030.120.001
M6	10	57030.060.001	M10	5	57030.100.001			

Uchwyty wkrętakowe do nasadek

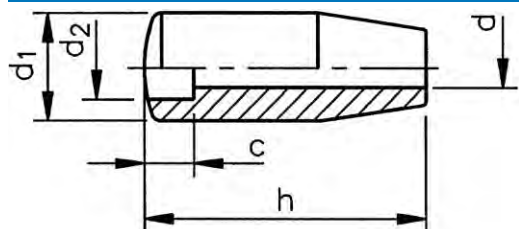

Informacje techniczne

d	c	d ₁	d ₂	h
6.5	6.5	20	10.5	50
8.5	8.5	23	13.5	60
10.5	10.5	27	16.5	80
12.5	12.5	29	19.5	90

57031 Uchwyty wkrętakowe do nasadek

W03A

Materiał Tworzywo sztuczne wzmocnione włóknem szklanym
Kolor Czarny



d	☒	Kod artykułu	d	☒	Kod artykułu	d	☒	Kod artykułu
6,5MM	10	57031.065.001	10,5MM	5	57031.105.001	12,5MM	5	57031.125.001
8,5MM	10	57031.085.001						

Uchwyty bez możliwości obrotu, plastikowe

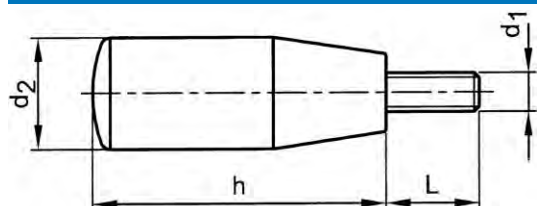

Informacje techniczne

d ₁	d ₂	h	P	d ₁	d ₂	h	P
M6	20	50	1	M10	27	80	1.5
M8	23	60	1.25	M12	29	90	1.75

57033 Rączki ze szpilką ze stali cynkowanej bez możliwości obrotu

W03A

Gwint Metryczny
Materiał Tworzywo sztuczne wzmocnione włóknem szklanym
Kolor Czarny



d ₁ x L	☒	Kod artykułu	d ₁ x L	☒	Kod artykułu	d ₁ x L	☒	Kod artykułu
M6X20	10	57033.060.020	M10X30	5	57033.100.030	M12X30	5	57033.120.030
M8X30	10	57033.080.030						

Rączki z możliwością obrotu, plastikowe

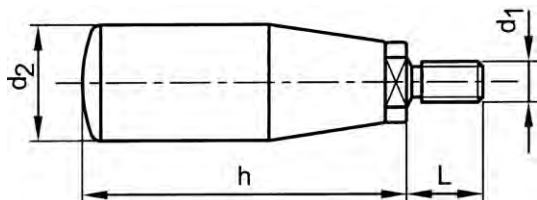

Informacje techniczne

$d_1 \times h$	d_2	L	P	$d_1 \times h$	d_2	L	P
M6x55	20	12	1	M10x100	30	16	1.5
M8x67	23	15	1.25	M12x97	29	15	1.75
M8x73	23	12	1.25	M12x104	31	23	1.75
M10x87	25	15	1.5				

Grupy katalogowe

Gwint	Materiał	Klasa	Kolor	Kod	Strona
M	Plastik PF	FS31	Czarny	56988	12-94
M	GRP		Czarny	57035	12-94

56988 Rączki z możliwością obrotu, plastikowe W03F

Gwint	Metryczny
Materiał	Plastik Fenoloformaldehyd (bakelit)
Klasa	FS31
Kolor	Czarny



$d_1 \times h$	☒	Kod artykułu	$d_1 \times h$	☒	Kod artykułu	$d_1 \times h$	☒	Kod artykułu
M8x73	10	56988.080.001	M10x100	5	56988.100.001	M12x104	5	56988.120.001

- Z końcówką gwintową ze stali ocynkowanej z możliwością obrotu.

57035 Uchwyt z możliwością obrotu, plastikowe W03A

Gwint	Metryczny
Materiał	Tworzywo sztuczne wzmocnione włóknem szklanym
Kolor	Czarny



$d_1 \times h$	☒	Kod artykułu	$d_1 \times h$	☒	Kod artykułu	$d_1 \times h$	☒	Kod artykułu
M6x55	10	57035.060.001	M10x87	5	57035.100.001	M12x97	5	57035.120.001
M8x67	10	57035.080.001						

- Z końcówką gwintową ze stali ocynkowanej z możliwością obrotu.

Uchwyty stożkowe z możliwością obrotu, plastikowe

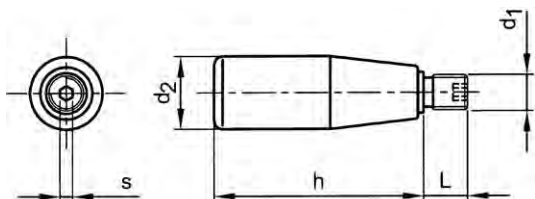

Informacje techniczne

d ₁	d ₂	h	L	P	s
M6	23	62	15	1	4
M8	23	62	15	1.25	4
M10	26	82	15	1.5	5
M12	26	82	15	1.75	5

57049 Uchwyty stożkowe z możliwością obrotu, plastikowe

W03A

Gwint Metryczny
Materiał Tworzywo sztuczne wzmocnione włóknem szklanym
Kolor Czarny



d ₁	☒	Kod artykułu	d ₁	☒	Kod artykułu	d ₁	☒	Kod artykułu
M6	10	57049.060.001	M10	5	57049.100.001	M12	5	57049.120.001
M8	10	57049.080.001						

- Z końcówką gwintowaną ze stali ocynkowanej z możliwością obrotu, z gniazdem sześciokątnym.

Uchwyty z możliwością obrotu, chowane, plastikowe

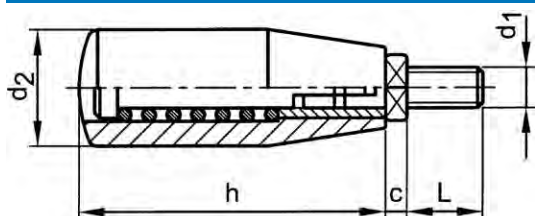

Informacje techniczne

d ₁	c	d ₂	h	L	P
M6	6	20	50	9	1
M8	6.5	25	78	16	1.25
M10	7.5	25	82	17	1.5

57037 Uchwyty z możliwością obrotu, chowane, plastikowe

W03A

Gwint Metryczny
Materiał Tworzywo sztuczne wzmocnione włóknem szklanym
Kolor Czarny



d ₁	☒	Kod artykułu	d ₁	☒	Kod artykułu	d ₁	☒	Kod artykułu
M6	10	57037.060.001	M8	10	57037.080.001	M10	5	57037.100.001

- Z końcówką gwintową ze stali ocynkowanej z możliwością obrotu.
- Kształt rozmiaru M10 odbiega od normy.

Korby ręczne z chowanym uchwytem, plastikowe

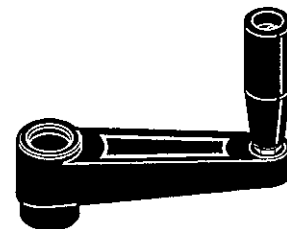
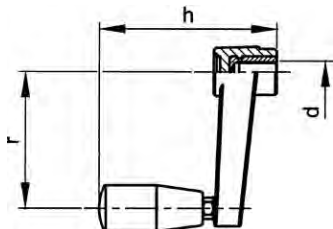

Informacje techniczne

d	h	P	r	d	h	P	r
M8	86	1.25	65	M14	127	2	140
M10	87	1.5	80	M16	141	2	185
M12	105	1.75	110				

57063 Korby ręczne z uchwytem z mosiężną tuleją gwintową

W03A

Gwint Metryczny
Materiał Tworzywo sztuczne wzmocnione włóknem szklanym
Kolor Czarny

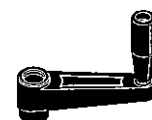

d	☒	Kod artykułu	d	☒	Kod artykułu	d	☒	Kod artykułu
M8	2	57063.080.001	M12	2	57063.120.001	M16	1	57063.160.001
M10	2	57063.100.001	M14	1	57063.140.001			

Korby ręczne z uchwytem, plastikowe

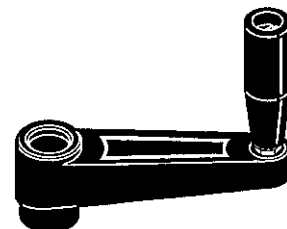
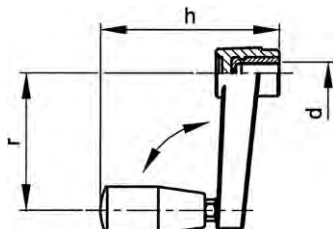

Informacje techniczne

d	h	P	r	d	h	P	r
M8	86	1.25	65	M14	137	2	140
M10	87	1.5	80	M16	151	2	185
M12	115	1.75	110				

57064 Korby ręczne z uchwytem z mosiężną tuleją gwintowaną

W03A

Gwint Metryczny
Materiał Tworzywo sztuczne wzmocnione włóknem szklanym
Kolor Czarny

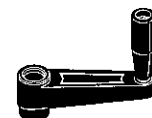

d	☒	Kod artykułu	d	☒	Kod artykułu	d	☒	Kod artykułu
M8	2	57064.080.001	M12	2	57064.120.001	M16	1	57064.160.001
M10	2	57064.100.001	M14	1	57064.140.001			

Uchwyty dźwigni przekładni z uchwytem kulowym

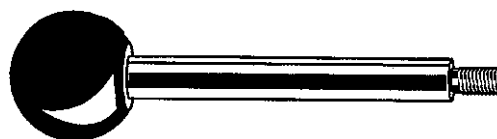
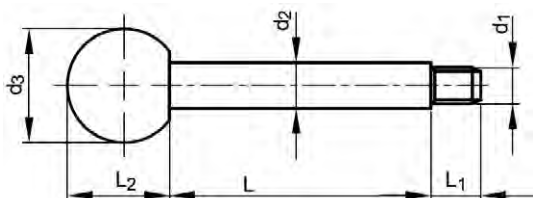

Informacje techniczne

d_1	d_2	d_3	L_1	L_2	P
M6	8	20	9	18	1
M8	10	25	13	22.5	1.25
M10	12	32	15	29	1.5

57003 Uchwyty dźwigni przekładni z uchwytem kulowym, typ A

W03A

Gwint Metryczny
Materiał Stal automatowa

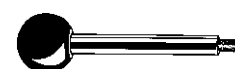

$d_1 \times L$	☒	Kod artykułu	$d_1 \times L$	☒	Kod artykułu	$d_1 \times L$	☒	Kod artykułu
M6X65	5	57003.060.065	M8X80	5	57003.080.080	M10X80	5	57003.100.080

- Z plastikowym (FS31) uchwytem kulowym.

Dźwignie napinające, płaskie, umożliwiające podnoszenie

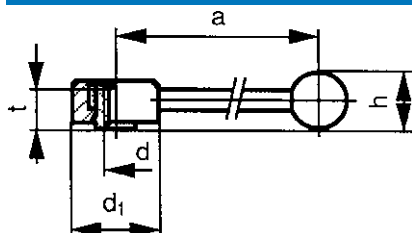

Informacje techniczne

$d_1 \times a$	a	d_2	h	P
M8x97	97	33	25	1.25
M8x102	102	33	25	1.25
M10x118	118	41	32	1.5
M10x130	130	41	30	1.5
M12x118	11	41	8	1.75
M12x130	130	41	30	1.75
M16x143	143	45	32	2
M16x148	148	45	37	2

- Z czarnym plastikowym uchwytem kulowym (FS31)

Grupy katalogowe

Gwint	Materiał	Kod	Strona
M	Stal automatowa	56958	12-98
M	Stal automatowa ze szpilką gwintowaną	56959	12-98

56958	Dźwignie napinające, płaskie, umożliwiające podnoszenie	W03A
Gwint	Metryczny	
Materiał	Stal automatowa	

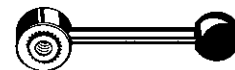

d₁ x a x L	☒	Kod artykułu	d₁ x a x L	☒	Kod artykułu	d₁ x a x L	☒	Kod artykułu
M8x97x18	3	56958.080.018	M12x118x21	3	56958.120.021	M16x143x27	2	56958.160.027
M10x118x21	3	56958.100.021						

56959	Dźwignie przestawne, umożliwiające podnoszenie z gwintowaną szpilką	W03A
Gwint	Metryczny	
Materiał	Stal automatowa	

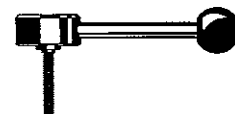

d₁ x a x L	☒	Kod artykułu	d₁ x a x L	☒	Kod artykułu	d₁ x a x L	☒	Kod artykułu
M8x102x30	3	56959.080.030	M12x130x40	2	56959.120.040	M16x148x40	2	56959.160.040
M10x130x30	3	56959.100.030						

Dźwignie napinające, umożliwiające podnoszenie

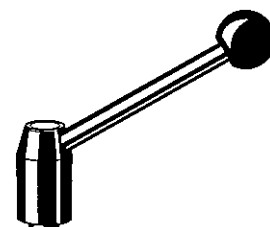
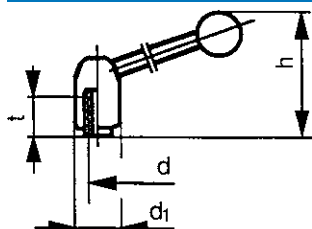

Informacje techniczne

d	a	d ₂	h	P
M8	87	24	70.5	1.25
M10	87	24	70.5	1.5
M12	106	28	84	1.75
M16	128	33	96	2

- Z czarnym plastikowym uchwytem kulowym (FS31)

Grupy katalogowe

Gwint	Materiał	Kod	Strona
M	Stal automatowa	56956	12-98
M	Stal automatowa ze szpilką gwintowaną	56957	12-98

56956	Dźwignie napinające, umożliwiające podnoszenie	W03A
Gwint	Metryczny	
Materiał	Stal automatowa	



d x t	☒	Kod artykułu	d x t	☒	Kod artykułu	d x t	☒	Kod artykułu
M8X14	3	56956.080.023	M12X17	2	56956.120.026	M16X23	1	56956.160.030
M10X14	3	56956.100.023						

56957	Dźwignie przestawne, umożliwiające podnoszenie z gwintowaną szpilką		W03A
Gwint	Metryczny		
Materiał	Stal automatowa		

d x L	☒	Kod artykułu	d x L	☒	Kod artykułu	d x L	☒	Kod artykułu
M8X30	3	56957.080.030	M12X40	2	56957.120.040	M16X50	1	56957.160.050
M10X30	3	56957.100.030						

Dźwignie zaciskowe, stalowe

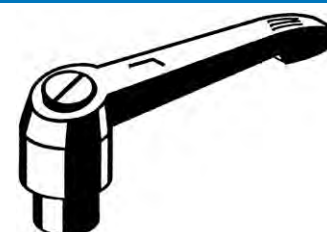
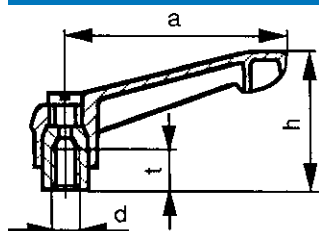

Informacje techniczne

d	a	h	P	d	a	h	P
M4	30	30	0.7	M10	65	42.5	1.5
M5	40	31	0.8	M12	95	63	1.75
M6	40	31	1	M16	110	73	2
M8	65	42.5	1.25				

Grupy katalogowe

Gwint	Materiał	Klasa	Kolor	Kod	Strona
M	Stal automatowa		z tuleją gwintowaną	Czarny	56960 12-99
M	Stal automatowa			Czarny	56961 12-99
M	GRP	6.6	z tuleją gwintowaną	Czarny	56964 12-100
M	GRP	6.6		Czarny	56965 12-100
M	GRP	6.6	z tuleją gwintowaną	Pomarańczowy	56973 12-100
M	GRP	6.6		Pomarańczowy	56974 12-100

56960	Dźwignie zaciskowe, stalowe		W03A
Gwint	Metryczny		
Materiał	Stal automatowa		
Kolor	Czarny		

d x t	☒	Kod artykułu	d x t	☒	Kod artykułu	d x t	☒	Kod artykułu
M4X9	5	56960.040.009	M8X12	5	56960.080.012	M12X17	3	56960.120.017
M5X9	5	56960.050.009	M10X14	3	56960.100.014	M16X23	1	56960.160.023
M6X9	5	56960.060.009						

- Stal automatowa z tuleją gwintowaną i rączką z cynku odlewanego pod ciśnieniem (zgodn. z DIN 1743).
- Kolor czarny.

56961	Dźwignie zaciskowe, stalowe		W03A
Gwint	Metryczny		
Materiał	Stal automatowa		
Kolor	Czarny		

d x L	☒	Kod artykułu	d x L	☒	Kod artykułu	d x L	☒	Kod artykułu
M5X30	5	56961.050.030	M8X40	5	56961.080.040	M12X50	3	56961.120.050
M6X30	5	56961.060.030	M10X50	3	56961.100.050	M16X60	1	56961.160.060

- Wolna stal narzędziowa z końcem gwintowanym i rączką z cynku odlewanego pod ciśnieniem (zgodn. z DIN 1743).
- Kolor czarny.

56964	Dźwignie zaciskowe, stalowe	W03A
Gwint	Metryczny	
Materiał	Tworzywo sztuczne wzmocnione włóknem szklanym	
Klasa	6.6	
Kolor	Czarny	

d x t	☒	Kod artykułu	d x t	☒	Kod artykułu	d x t	☒	Kod artykułu
M4X9	10	56964.040.009	M8X12	5	56964.080.012	M12X17	3	56964.120.017
M5X9	10	56964.050.009	M10X14	3	56964.100.014	M16X23	1	56964.160.023
M6X9	10	56964.060.009						

- Z uchwytem wzmocnianym włóknem szklanym i stalową tuleją gwintowaną.
- Kolor czarny RAL 7021.

56965	Dźwignie zaciskowe, stalowe	W03A
Gwint	Metryczny	
Materiał	Tworzywo sztuczne wzmocnione włóknem szklanym	
Klasa	6.6	
Kolor	Czarny	

d x L	☒	Kod artykułu	d x L	☒	Kod artykułu	d x L	☒	Kod artykułu
M5X30	5	56965.050.030	M8X40	5	56965.080.040	M12X50	3	56965.120.050
M6X30	5	56965.060.030	M10X50	3	56965.100.050	M16X60	1	56965.160.060

- Z uchwytem wzmocnianym włóknem szklanym i stalowym końcem gwintowanym.
- Kolor czarny RAL 7021.

56973	Dźwignie zaciskowe, stalowe	W03A
Gwint	Metryczny	
Materiał	Tworzywo sztuczne wzmocnione włóknem szklanym	
Klasa	6.6	
Kolor	Pomarańczowy	

d x t	☒	Kod artykułu	d x t	☒	Kod artykułu	d x t	☒	Kod artykułu
M4X9	10	56973.040.009	M8X12	5	56973.080.012	M12X17	3	56973.120.017
M5X9	10	56973.050.009	M10X14	3	56973.100.014	M16X23	1	56973.160.023
M6X9	10	56973.060.009						

- Z uchwytem wzmocnianym włóknem szklanym i stalową tuleją gwintowaną.
- Kolor pomarańczowy = RAL 2004.

56974	Dźwignie zaciskowe, stalowe	W03A
Gwint	Metryczny	
Materiał	Tworzywo sztuczne wzmocnione włóknem szklanym	
Klasa	6.6	
Kolor	Pomarańczowy	

d x L	☒	Kod artykułu	d x L	☒	Kod artykułu	d x L	☒	Kod artykułu
M5X30	5	56974.050.030	M8X40	5	56974.080.040	M12X50	3	56974.120.050
M6X30	5	56974.060.030	M10X50	3	56974.100.050	M16X60	1	56974.160.060

- Z uchwytem wzmocnianym włóknem szklanym i stalowym końcem gwintowanym.
- Kolor czarny RAL 7021.

Dźwignie zaciskowe, stalowe, umożliwiające podnoszenie

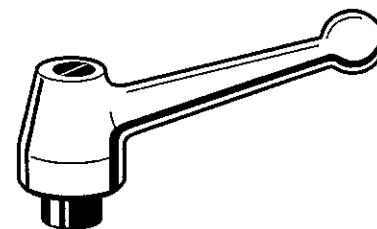
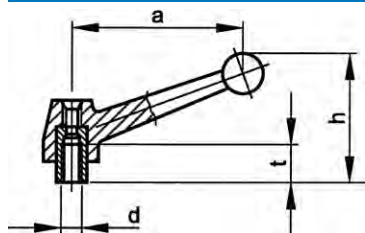

Informacje techniczne

d	a	h	P
M8	83	64	1.25
M10	83	64	1.5
M12	108	81.5	1.75
M16	132	93	2

Grupy katalogowe

Gwint	Materiał	Kolor	Kod	Strona
M	Stal kuta C35	Szary	57004	12-101
M	Stal kuta C35 z tuleją gwintowaną	Szary	57005	12-101

57004 Dźwignie zaciskowe, stalowe, umożliwiające podnoszenie

W03A

Gwint	Metryczny
Materiał	Stal kuta C35
Kolor	Szary

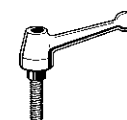

d x L	☒	Kod artykułu	d x L	☒	Kod artykułu	d x L	☒	Kod artykułu
M10X30	2	57004.100.030	M12X40	2	57004.120.040	M16X50	1	57004.160.050

- Z końcem gwintowanym ze stali klasy 5.8.

57005 Dźwignie zaciskowe, stalowe, umożliwiające podnoszenie, z gwintowaną tuleją

W03A

Gwint	Metryczny
Materiał	Stal kuta C35
Kolor	Szary

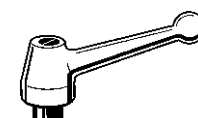

d x t	☒	Kod artykułu	d x t	☒	Kod artykułu	d x t	☒	Kod artykułu
M8X17	2	57005.080.017	M12X23	2	57005.120.023	M16X27	1	57005.160.027
M10X17	2	57005.100.017						

- Z tuleją gwintowaną ze stali klasy 5.8.

Dźwignie zaciskowe umożliwiające podnoszenie

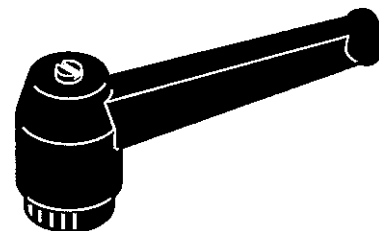
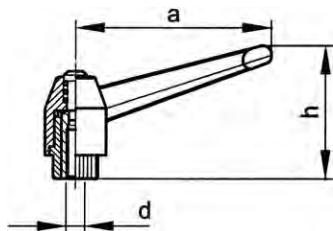

Informacje techniczne

d	a	h	P	d	a	h	P
M4	43	35	0.7	M10	83	57	1.5
M5	43	35	0.8	M12	104	70	1.75
M6	43	35	1	M16	104	70	2
M8	65	46	1.25				

Grupy katalogowe

Gwint	Materiał	Kolor	Kod	Strona
M	GRP	Czarny	57070	12-102
M	GRP ze szpilką gwintowaną	Czarny	57071	12-102

57070 Dźwignie zaciskowe, umożliwiające podnoszenie, z cynkowaną tuleją gwintowaną W03A

Gwint	Metryczny
Materiał	Tworzywo sztuczne wzmocnione włóknem szklanym
Kolor	Czarny

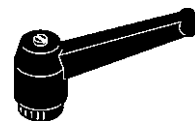

d	☒	Kod artykułu	d	☒	Kod artykułu	d	☒	Kod artykułu
M4	10	57070.040.001	M8	10	57070.080.001	M12	5	57070.120.001
M5	10	57070.050.001	M10	5	57070.100.001	M16	5	57070.160.001
M6	10	57070.060.001						

57071 Dźwignie zaciskowe umożliwiające podnoszenie z ocynkowaną szpilką gwintowaną W03A

Gwint	Metryczny
Materiał	Tworzywo sztuczne wzmocnione włóknem szklanym
Kolor	Czarny



d x L	☒	Kod artykułu	d x L	☒	Kod artykułu	d x L	☒	Kod artykułu
M4X15	10	57071.040.015	M8X30	10	57071.080.030	M12X50	5	57071.120.050
M5X20	10	57071.050.020	M10X40	5	57071.100.040	M16X50	5	57071.160.050
M6X25	10	57071.060.025						

Dźwignie zaciskowe, mocne, wysokie

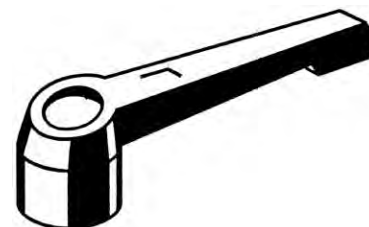
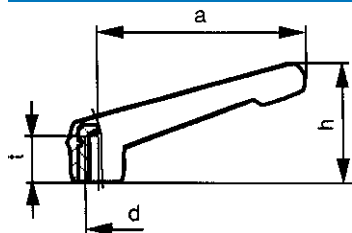

Informacje techniczne

d	a	h	P	d	a	h	P
M4	40	27	0.7	M10	80	45	1.5
M5	40	27	0.8	M12	95	54	1.75
M6	40	27	1	M16	110	63	2
M8	65	36.5	1.25				

56971 Dźwignie zaciskowe, mocne, wysokie

W03A

Gwint	Metryczny
Materiał	Plastik Poliamid (nylon)
Klasa	PA 6.6
Kolor	Czarny



d x t	☒	Kod artykułu	d x t	☒	Kod artykułu	d x t	☒	Kod artykułu
M4X11	10	56971.040.011	M8X12	5	56971.080.012	M12X20	3	56971.120.020
M5X11	10	56971.050.011	M10X16	3	56971.100.016	M16X24	1	56971.160.024
M6X11	10	56971.060.011						

- Z tuleją gwintowaną ze stali cynkowanej, pasywacja na żółto.

Dźwignie zaciskowe, mocne

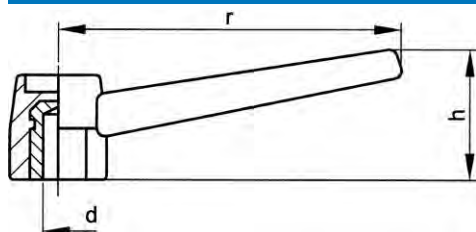

Informacje techniczne

d	h	P	r	d	h	P	r
M5	21	0.8	43	M8	26	1.25	68
M6	21	1	43	M10	39	1.5	83

Grupy katalogowe

Gwint	Materiał	Kolor	Kod	Strona
M	GRP	Czarny	57076	12-103
M	GRP	ze szpilką gwintowaną	57077	12-104

57076 Dźwignie zaciskowe, mocne, z mosiężną tuleją gwintowaną

W03A

Gwint	Metryczny
Materiał	Tworzywo sztuczne wzmocnione włóknem szklanym
Kolor	Czarny

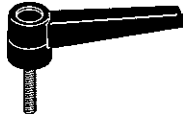

d	☒	Kod artykułu	d	☒	Kod artykułu	d	☒	Kod artykułu
M5	10	57076.050.001	M8	10	57076.080.001	M10	5	57076.100.001
M6	10	57076.060.001						

57077	Dźwignie zaciskowe mocne z ocynkowaną szpilką gwintowaną		W03A
Gwint	Metryczny		
Materiał	Tworzywo sztuczne wzmocnione włóknem szklanym		
Kolor	Czarny		

d x L	☒	Kod artykułu	d x L	☒	Kod artykułu	d x L	☒	Kod artykułu
M5X20	10	57077.050.020	M8X30	10	57077.080.030	M10X40	5	57077.100.040
M6X20	10	57077.060.020						

Pokręta plastikowe

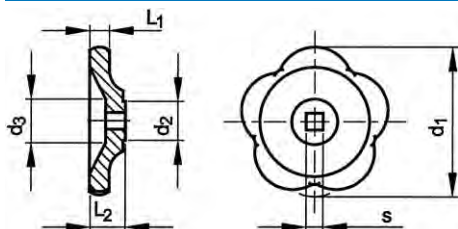

DIN 388-1C



Informacje techniczne

s (H11) x d ₁	d ₂	d ₃	L ₁	L ₂	s (H11) x d ₁	d ₂	d ₃	L ₁	L ₂
5x50 (#DIN)	22	21	10	18	7x80 (#DIN)	28	30	12	22
5x63 (#DIN)	22	24	11	20	8x63 (#DIN)	22	24	11	20
6x50 (#DIN)	22	22	10	18	8x80	28	28	12	22
6x63 (#DIN)	22	24	11	20	9x100	28	30	14	25
7x63	22	24	11	20					

56901	Pokręta plastikowe		W03F
Materiał	Plastik Fenoloformaldehyd (bakelit)		
Klasa	FS31		
Kolor	Czarny		

s x d ₁	☒	Kod artykułu	s x d ₁	☒	Kod artykułu	s x d ₁	☒	Kod artykułu
5X50MM	10	56901.050.050	6X63MM	10	56901.060.063	8X63MM	10	56901.080.063
5X63MM	10	56901.050.063	7X63MM	10	56901.070.063	8X80MM	10	56901.080.080
6X50MM	10	56901.060.050	7X80MM	10	56901.070.080	9X100MM	5	56901.090.100

Pokręta aluminiowe

DIN 950

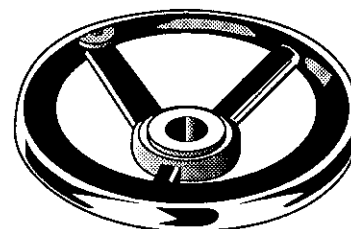
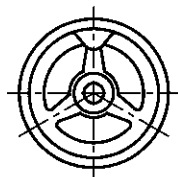
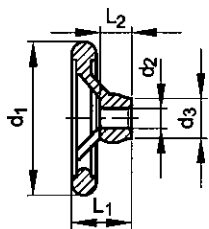

Informacje techniczne

d_2 (H7) x d_1	d_3	$L_1 \approx$	L_2	Szprychy
10x80	24	29	16	3
10x100	26	36	18	3
12x125	28	36	18	3
14x140	30	39	19	3
16x160	32	40	20	3
18x180 (≠DIN)	35	43	22	3
20x200 (≠DIN)	38	45	24	3
20x225 (≠DIN)	42	48	26	5
24x250 (≠DIN)	45	50	28	5
24x280 (≠DIN)	50	53	30	5
26x315	53	56	33	5
28x360 (≠DIN)	60	59	35	5
30x400	65	63	38	5
34x500	78	72	45	5

56940 Pokręta aluminiowe

W03F

Material Aluminium

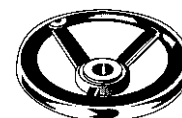

d_2 x d_1	☒	Kod artykułu	d_2 x d_1	☒	Kod artykułu	d_2 x d_1	☒	Kod artykułu
10X80MM 3-SZPRYCH	1	56940.100.080	18X180MM 3-SZ-PRYCH	1	56940.180.001	26X315MM 5-SZ-PRYCH	1	56940.315.001
10X100MM 3-SZ-PRYCH	1	56940.100.100	20X200MM 3-SZ-PRYCH	1	56940.200.001	28X360MM 5-SZ-PRYCH	1	56940.360.001
12X125MM 3-SZ-PRYCH	1	56940.120.125	20X225MM 5-SZ-PRYCH	1	56940.225.001	30X400MM 5-SZ-PRYCH	1	56940.400.001
14X140MM 3-SZ-PRYCH	1	56940.140.140	24X250MM 5-SZ-PRYCH	1	56940.250.001	34X500MM 5-SZ-PRYCH	1	56940.500.001
16X160MM 3-SZ-PRYCH	1	56940.160.001	24X280MM 5-SZ-PRYCH	1	56940.280.001			

Pokręta dwuramienna, plastikowe

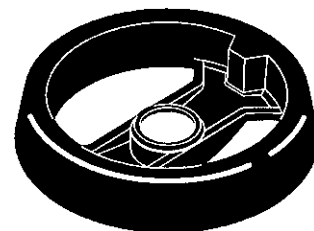
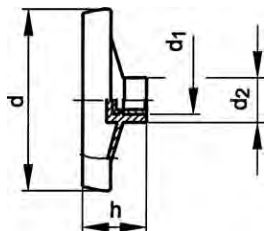

Informacje techniczne

d	d ₁ (H7)	d ₂	h	d	d ₁ (H7)	d ₂	h
80	8	24	34	164	14	40	56
100	10	28	42	200	16	50	61
130	12	32	50	255	20	56	71

57060 Pokręta dwuramienna, plastikowe

W03A

Materiał Tworzywo sztuczne wzmocnione włóknem szklanym
Kolor Czarny

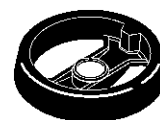

d	☒	Kod artykułu	d	☒	Kod artykułu	d	☒	Kod artykułu
80MM	2	57060.080.001	130MM	2	57060.130.001	200MM	1	57060.200.001
100MM	2	57060.100.001	164MM	2	57060.160.001	255MM	1	57060.250.001

- Z wkładką ze stali cynkowanej.

Pokręta dwuramienna z chowanym uchwytem, plastikowe

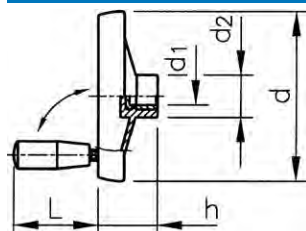

Informacje techniczne

d	d ₁ (H7)	d ₂	h	L	d	d ₁ (H7)	d ₂	h	L
80	8	24	34	56	164	14	40	56	76
100	10	28	43	56	200	16	50	61	76
130	12	32	50	76	255	20	56	71	98

57061 Pokręta dwuramienna z chowanym uchwytem, plastikowe

W03A

Materiał Tworzywo sztuczne wzmocnione włóknem szklanym
Kolor Czarny



d	☒	Kod artykułu	d	☒	Kod artykułu	d	☒	Kod artykułu
80MM	2	57061.080.001	130MM	2	57061.130.001	200MM	1	57061.200.001
100MM	2	57061.100.001	164MM	2	57061.160.001	255MM	1	57061.250.001

- Z wkładką ze stali cynkowanej.

Pokręta pełne bez uchwytu, plastikowe

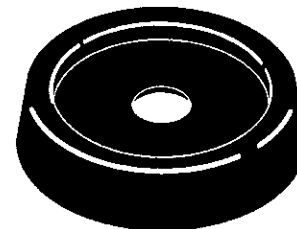
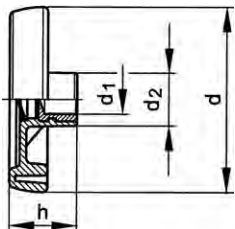

Informacje techniczne

d	d ₁	d ₂	h	d	d ₁	d ₂	h
80	8	25	33	150	14	38	54
100	10	30	39	173	16	40	57
126	125	36	44	203	18	44	59

57080 Pokręta pełne bez uchwytu, plastikowe

W03A

Materiał Tworzywo sztuczne wzmocnione włóknem szklanym
Kolor Czarny



d	☒	Kod artykułu	d	☒	Kod artykułu	d	☒	Kod artykułu
80MM	2	57080.080.001	126MM	2	57080.125.001	173MM	1	57080.175.001
100MM	2	57080.100.001	150MM	2	57080.150.001	203MM	1	57080.200.001

- Z wkładką ze stali cynkowanej.

Pokręta pełne z rączką, plastikowe

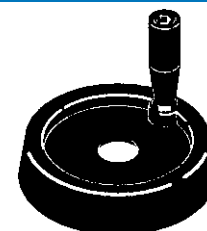
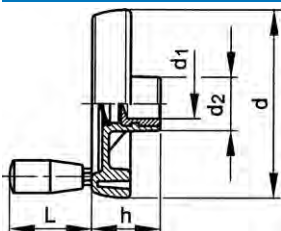

Informacje techniczne

d	d ₁	d ₂	h	L	d	d ₁	d ₂	h	L
80	8	24	33	55	150	14	38	53	76
100	10	30	39	55	173	16	40	56	86
126	12	36	44	66	203	18	44	59	86

57081 Pokręta pełne z uchwytem, plastikowe

W03A

Materiał Tworzywo sztuczne wzmocnione włóknem szklanym
Kolor Czarny



d	☒	Kod artykułu	d	☒	Kod artykułu	d	☒	Kod artykułu
80MM	2	57081.080.001	126MM	2	57081.125.001	173MM	1	57081.175.001
100MM	2	57081.100.001	150MM	2	57081.150.001	203MM	1	57081.200.001

- Z wkładką ze stali cynkowanej.

Pokręta pełne z chowanym uchwytem, plastikowe

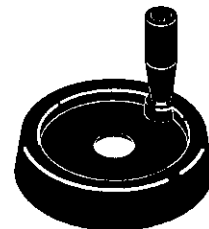
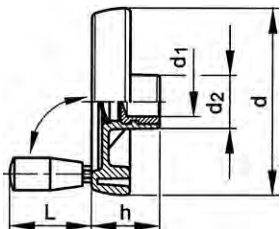

Informacje techniczne

d	d ₁	d ₂	h	L
80	8	24	33	55
100	10	30	39	55
126	12	36	44	76

57083 Pokręta pełne z chowanym uchwytem, plastikowe

W03A

Materiał Tworzywo sztuczne wzmocnione włóknem szklanym
Kolor Czarny



d	☒	Kod artykułu	d	☒	Kod artykułu	d	☒	Kod artykułu
80MM	2	57083.080.001	100MM	2	57083.100.001	126MM	2	57083.125.001

- Z wkładką ze stali cynkowanej.

Pokręta pełne z wgłębieniem do chowania uchwyty, plastikowe

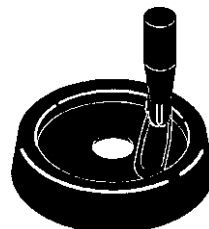
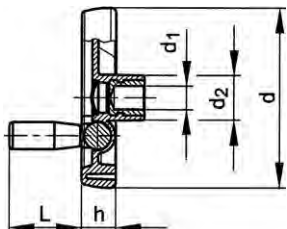

Informacje techniczne

d	d ₁ (H7)	d ₂	h	L	d	d ₁ (H7)	d ₂	h	L
80	8	24	33	39	150	14	38	53	60
100	10	30	42	49	175	16	40	58	80
125	12	36	47	58	200	18	44	63	90

57084 Pokręta pełne z wgłębieniem do chowania uchwyty, plastikowe

W03A

Materiał Tworzywo sztuczne wzmocnione włóknem szklanym
Kolor Czarny

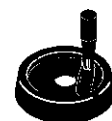

d	☒	Kod artykułu	d	☒	Kod artykułu	d	☒	Kod artykułu
80MM	2	57084.080.001	125MM	2	57084.125.001	175MM	1	57084.175.001
100MM	2	57084.100.001	150MM	2	57084.150.001	200MM	1	57084.200.001

- Z wkładką ze stali cynkowanej.

Pokrętła pełne z chowanym uchwytem, plastikowe

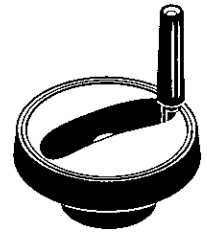
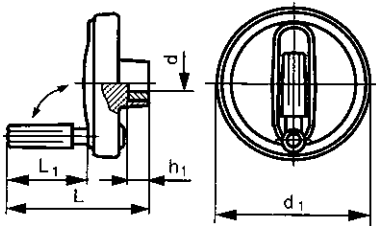

Informacje techniczne

d (H7) x d ₁	h ₁	L	L ₁	d (H7) x d ₁	h ₁	L	L ₁
8x80	13	75	40	12x125	18.5	109	59.9
10x100	13	90	49	14x160	18.5	144	83.5

56954 Pokrętła pełne z chowanym uchwytem, plastikowe

W03A

Materiał Thermoplastic Poliamid (nylon)
Klasa 6
Kolor Czarny



d x d ₁	☒	Kod artykułu	d x d ₁	☒	Kod artykułu	d x d ₁	☒	Kod artykułu
8X80MM	1	56954.080.080	12X125MM	1	56954.120.125	14X160MM	1	56954.140.160
10X100MM	1	56954.100.100						

- Z wkładką stalową.

FABORY Kule techniczne

Standardyzacja

Znormalizowane kule techniczne FABORY są zgodnie z DIN 5401-1 i DIN 5401-2, co odpowiada ISO 3290. Nieznormalizowane kule techniczne FABORY, odpowiadają normą najwyższej jakości.

Zapasy magazynowe

Kule techniczne FABORY są dostępne z magazynu w wielu średnicach, tolerancjach wykonania i twardości. wykonane z następujących materiałów: stal chromowa, stal węglowa, stal nierdzewna, tworzywo sztuczne, szkło itd.

Specjalne

Na żądanie dostępne są produkty specjalne.

Zastosowania

Kule techniczne FABORY stosuje się np. do zabezpieczeń walcowych, długopisów kulkowych, zapalniczek cygar, przewodnic szuflad, pistoletów natryskowych, kutech poręczy i balustrad, magnetowidów, a także do mielenia, łożyskowania, uszczelniania, stępienia ostrych krawędzi i polerowania.

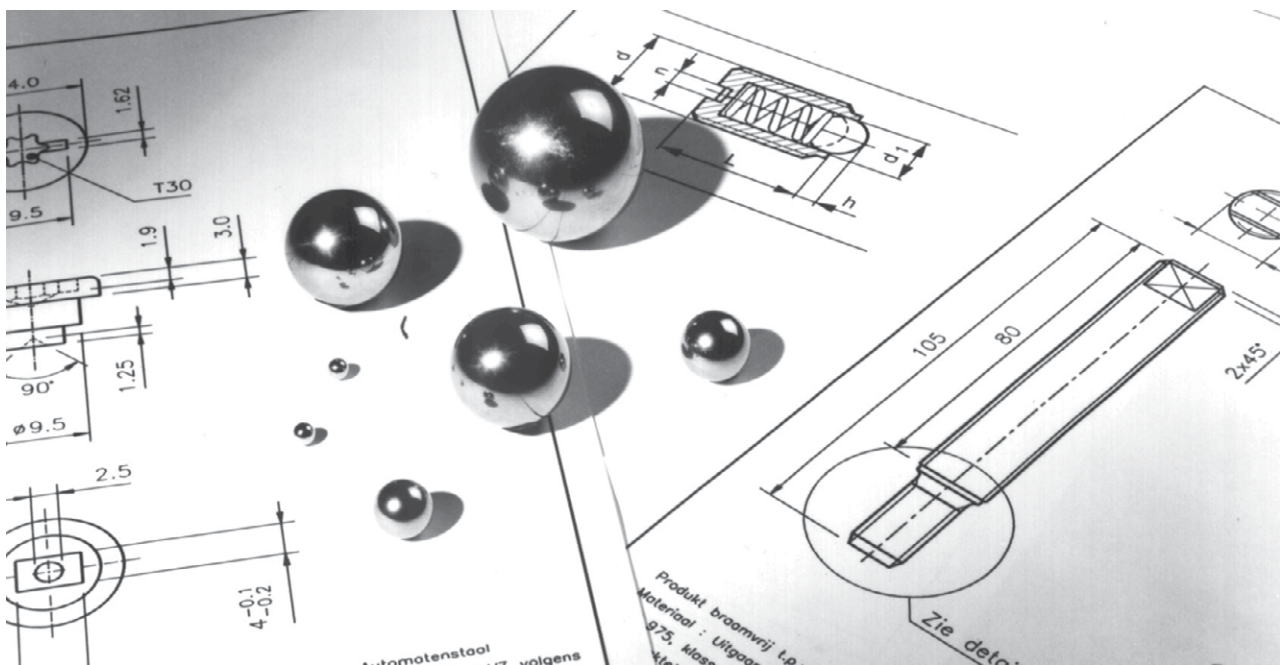

Kule techniczne

DIN ≈5401
ISO 3290

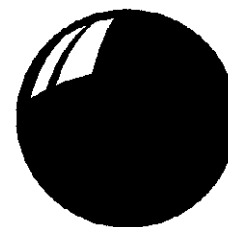

Grupy katalogowe

Material	Klasa		Kod	Strona
Stal chromowa HRc 60-67	G20	Pojedyncze Pakowanie	66813	12-111
Stal chromowa HRc 60-67	G28	Pojedyncze Pakowanie	66816	12-111
Stal chromowa HRc 60-67	G40	Pojedyncze Pakowanie	66819	12-112
Stal węglowa niehartowana HRc 25		Pojedyncze Pakowanie	66860	12-112
St.St. AISI304 niehartowana HRc 25-29		Pojedyncze Pakowanie	66910	12-112
St.St. AISI316 niehartowana HRc 25-29		Pojedyncze Pakowanie	66920	12-112
St.St. AISI420 zahartowana HRC 52-55	G100	Pojedyncze Pakowanie	66930	12-112

66813 Kule techniczne

S50A

Material Stal chromowa HRc 60-67
Klasa G20



d	☒	Kod artykułu	d	☒	Kod artykułu	d	☒	Kod artykułu
1,000MM	1	66813.001.000	6,747MM	1	66813.006.747	15,081MM	1	66813.015.081
1,500MM	1	66813.001.500	7,000MM	1	66813.007.000	15,875MM	1	66813.015.875
1,588MM	1	66813.001.588	7,144MM	1	66813.007.144	16,000MM	1	66813.016.000
1,984MM	1	66813.001.984	7,938MM	1	66813.007.938	16,669MM	1	66813.016.669
2,000MM	1	66813.002.000	8,000MM	1	66813.008.000	17,000MM	1	66813.017.000
2,381MM	1	66813.002.381	8,500MM	1	66813.008.500	17,462MM	1	66813.017.462
2,500MM	1	66813.002.500	8,731MM	1	66813.008.731	18,000MM	1	66813.018.000
2,778MM	1	66813.002.778	9,000MM	1	66813.009.000	18,256MM	1	66813.018.256
3,000MM	1	66813.003.000	9,525MM	1	66813.009.525	19,050MM	1	66813.019.050
3,175MM	1	66813.003.175	10,000MM	1	66813.010.000	19,844MM	1	66813.019.844
3,500MM	1	66813.003.500	10,319MM	1	66813.010.319	20,000MM	1	66813.020.000
3,969MM	1	66813.003.969	11,000MM	1	66813.011.000	20,637MM	1	66813.020.637
4,000MM	1	66813.004.000	11,112MM	1	66813.011.112	21,000MM	1	66813.021.000
4,500MM	1	66813.004.500	11,906MM	1	66813.011.906	21,431MM	1	66813.021.431
4,762MM	1	66813.004.762	12,000MM	1	66813.012.000	22,000MM	1	66813.022.000
5,000MM	1	66813.005.000	12,700MM	1	66813.012.700	22,225MM	1	66813.022.225
5,500MM	1	66813.005.500	13,000MM	1	66813.013.000	23,000MM	1	66813.023.000
5,556MM	1	66813.005.556	13,494MM	1	66813.013.494	23,019MM	1	66813.023.019
6,000MM	1	66813.006.000	14,000MM	1	66813.014.000	24,000MM	1	66813.024.000
6,350MM	1	66813.006.350	14,287MM	1	66813.014.287	24,606MM	1	66813.024.606
6,500MM	1	66813.006.500	15,000MM	1	66813.015.000	25,000MM	1	66813.025.000

66816 Kule techniczne

S50A

Material Stal chromowa HRc 60-67
Klasa G28



d	☒	Kod artykułu	d	☒	Kod artykułu	d	☒	Kod artykułu
25,400MM	1	66816.025.400	31,750MM	1	66816.031.750	41,275MM	1	66816.041.275
26,000MM	1	66816.026.000	33,337MM	1	66816.033.337	42,863MM	1	66816.042.863
26,988MM	1	66816.026.988	34,925MM	1	66816.034.925	44,450MM	1	66816.044.450
28,000MM	1	66816.028.000	35,000MM	1	66816.035.000	45,000MM	1	66816.045.000
28,575MM	1	66816.028.575	36,512MM	1	66816.036.512	46,038MM	1	66816.046.038
30,000MM	1	66816.030.000	38,100MM	1	66816.038.100	47,625MM	1	66816.047.625
30,162MM	1	66816.030.162	40,000MM	1	66816.040.000	50,000MM	1	66816.050.000

66819		Kule techniczne				S50A			
Materiał	Stal chromowa HRc 60-67								
Klasa	G40								
d	☒	Kod artykułu	d	☒	Kod artykułu	d	☒	Kod artykułu	
50,800MM	1	66819.050.800	63,500MM	1	66819.063.500	80,000MM	1	66819.080.000	
52,500MM	1	66819.052.500	69,850MM	1	66819.069.850	100,000MM	1	66819.100.000	
60,000MM	1	66819.060.000	70,000MM	1	66819.070.000				

66860		Kule techniczne				S51A			
Materiał	Stal węglowa niehartowana HRc 25								
d	☒	Kod artykułu	d	☒	Kod artykułu	d	☒	Kod artykułu	
7,144MM	1	66860.007.144	9,525MM	1	66860.009.525	15,875MM	1	66860.015.875	

66910		Kule techniczne				S52A			
Materiał	Stal nierdzewna AISI304 niehartowana HRc 25-29								
d	☒	Kod artykułu	d	☒	Kod artykułu	d	☒	Kod artykułu	
2,500MM	1	66910.002.500	6,000MM	1	66910.006.000	10,000MM	1	66910.010.000	
3,969MM	1	66910.003.969	6,350MM	1	66910.006.350	12,000MM	1	66910.012.000	
4,000MM	1	66910.004.000	8,000MM	1	66910.008.000				

66920		Kule techniczne				S52A			
Materiał	Stal nierdzewna AISI316 niehartowana HRc 25-29								
d	☒	Kod artykułu	d	☒	Kod artykułu	d	☒	Kod artykułu	
1,000MM	1	66920.001.000	6,000MM	1	66920.006.000	12,700MM	1	66920.012.700	
2,000MM	1	66920.002.000	6,350MM	1	66920.006.350	14,000MM	1	66920.014.000	
2,381MM	1	66920.002.381	7,144MM	1	66920.007.144	15,875MM	1	66920.015.875	
2,500MM	1	66920.002.500	7,938MM	1	66920.007.938	19,050MM	1	66920.019.050	
3,000MM	1	66920.003.000	8,000MM	1	66920.008.000	20,000MM	1	66920.020.000	
3,175MM	1	66920.003.175	9,525MM	1	66920.009.525	25,000MM	1	66920.025.000	
3,969MM	1	66920.003.969	10,000MM	1	66920.010.000	25,400MM	1	66920.025.400	
4,000MM	1	66920.004.000	11,112MM	1	66920.011.112				
4,762MM	1	66920.004.762	12,000MM	1	66920.012.000				

66930		Kule techniczne				S52A			
Materiał	Stal nierdzewna AISI420 zahartowana HRC 52-55								
Klasa	G100								
d	☒	Kod artykułu	d	☒	Kod artykułu	d	☒	Kod artykułu	
1,000MM	1	66930.001.000	4,762MM	1	66930.004.762	9,525MM	1	66930.009.525	
1,500MM	1	66930.001.500	5,000MM	1	66930.005.000	10,000MM	1	66930.010.000	
2,000MM	1	66930.002.000	5,556MM	1	66930.005.556	11,112MM	1	66930.011.112	
2,381MM	1	66930.002.381	6,000MM	1	66930.006.000	12,000MM	1	66930.012.000	
2,500MM	1	66930.002.500	6,350MM	1	66930.006.350	12,700MM	1	66930.012.700	
3,000MM	1	66930.003.000	7,000MM	1	66930.007.000	13,000MM	1	66930.013.000	
3,175MM	1	66930.003.175	7,144MM	1	66930.007.144	14,000MM	1	66930.014.000	
3,500MM	1	66930.003.500	7,938MM	1	66930.007.938	14,287MM	1	66930.014.287	
3,969MM	1	66930.003.969	8,000MM	1	66930.008.000	15,000MM	1	66930.015.000	
4,000MM	1	66930.004.000	8,731MM	1	66930.008.731	15,875MM	1	66930.015.875	
4,500MM	1	66930.004.500	9,000MM	1	66930.009.000	16,000MM	1	66930.016.000	

66930		Kule techniczne						
d	☒	Kod artykułu	d	☒	Kod artykułu	d	☒	Kod artykułu
18,000MM	1	66930.018.000	25,000MM	1	66930.025.000	40,000MM	1	66930.040.000
19,050MM	1	66930.019.050	25,400MM	1	66930.025.400	50,000MM	1	66930.050.000
20,000MM	1	66930.020.000	30,000MM	1	66930.030.000	60,000MM	1	66930.060.000
22,000MM	1	66930.022.000	30,162MM	1	66930.030.162			
22,225MM	1	66930.022.225	34,925MM	1	66930.034.925			

Kule techniczne nieżelazne

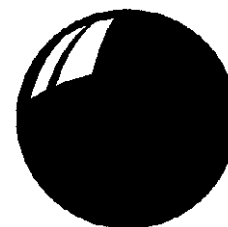

Grupy katalogowe				
Materiał	Klasa	Kolor	Kod	Strona
Plastik PP		pakowane po sztuce	66950	12-113
Plastik PA	PA 6.6	pakowane po sztuce	Naturalny 66955	12-113
Plastik POM		pakowane po sztuce	Biały 66960	12-114
Plastik PTFE		pakowane po sztuce	Biały 66970	12-114
Szkło		pakowane po sztuce	66990	12-114

66950		Kule techniczne nieżelazne		S54A	
Materiał	Plastik Polipropylen				

d	☒	Kod artykułu	d	☒	Kod artykułu	d	☒	Kod artykułu
2,000MM	1	66950.002.000	6,500MM	1	66950.006.500	15,875MM	1	66950.015.875
2,381MM	1	66950.002.381	7,000MM	1	66950.007.000	16,000MM	1	66950.016.000
2,500MM	1	66950.002.500	7,938MM	1	66950.007.938	17,000MM	1	66950.017.000
3,000MM	1	66950.003.000	8,000MM	1	66950.008.000	18,000MM	1	66950.018.000
3,175MM	1	66950.003.175	9,000MM	1	66950.009.000	19,000MM	1	66950.019.000
3,500MM	1	66950.003.500	9,525MM	1	66950.009.525	20,000MM	1	66950.020.000
3,969MM	1	66950.003.969	10,000MM	1	66950.010.000	22,000MM	1	66950.022.000
4,000MM	1	66950.004.000	11,000MM	1	66950.011.000	25,000MM	1	66950.025.000
4,500MM	1	66950.004.500	12,000MM	1	66950.012.000	25,400MM	1	66950.025.400
5,000MM	1	66950.005.000	13,000MM	1	66950.013.000	30,000MM	1	66950.030.000
6,000MM	1	66950.006.000	14,000MM	1	66950.014.000	35,000MM	1	66950.035.000
6,350MM	1	66950.006.350	15,000MM	1	66950.015.000	38,000MM	1	66950.038.000

W zależności od wielkości, kolory kul mogą się różnić między zielonym, szarym i naturalnym.

66955		Kule techniczne nieżelazne		S54A	
Materiał	Plastik Poliamid (nylon)				
Klasa	PA 6.6				
Kolor	Naturalny				

d	☒	Kod artykułu	d	☒	Kod artykułu	d	☒	Kod artykułu
2,000MM	1	66955.002.000	5,000MM	1	66955.005.000	13,000MM	1	66955.013.000
2,381MM	1	66955.002.381	6,000MM	1	66955.006.000	14,000MM	1	66955.014.000
2,500MM	1	66955.002.500	6,350MM	1	66955.006.350	15,000MM	1	66955.015.000
3,000MM	1	66955.003.000	7,000MM	1	66955.007.000	18,000MM	1	66955.018.000
3,175MM	1	66955.003.175	8,000MM	1	66955.008.000	20,000MM	1	66955.020.000
3,500MM	1	66955.003.500	10,000MM	1	66955.010.000	30,000MM	1	66955.030.000
3,969MM	1	66955.003.969	11,112MM	1	66955.011.112			
4,000MM	1	66955.004.000	12,700MM	1	66955.012.700			

66960	Kule techniczne nieżelazne	S54A
Materiał	Plastik Polioksymetylen	
Kolor	Biały	

d	☒	Kod artykułu	d	☒	Kod artykułu	d	☒	Kod artykułu
2,000MM	1	66960.002.000	6,350MM	1	66960.006.350	13,000MM	1	66960.013.000
2,500MM	1	66960.002.500	6,500MM	1	66960.006.500	14,000MM	1	66960.014.000
3,000MM	1	66960.003.000	8,000MM	1	66960.008.000	15,000MM	1	66960.015.000
3,175MM	1	66960.003.175	9,000MM	1	66960.009.000	15,875MM	1	66960.015.875
3,500MM	1	66960.003.500	10,000MM	1	66960.010.000	16,000MM	1	66960.016.000
4,000MM	1	66960.004.000	11,000MM	1	66960.011.000	19,000MM	1	66960.019.000
5,000MM	1	66960.005.000	12,000MM	1	66960.012.000	20,000MM	1	66960.020.000
6,000MM	1	66960.006.000						

66970	Kule techniczne nieżelazne	S54A
Materiał	Plastik Policzterofluoroetylen	
Kolor	Biały	

d	☒	Kod artykułu	d	☒	Kod artykułu	d	☒	Kod artykułu
2,000MM	1	66970.002.000	5,000MM	1	66970.005.000	12,700MM	1	66970.012.700
2,500MM	1	66970.002.500	8,000MM	1	66970.008.000	15,000MM	1	66970.015.000
3,000MM	1	66970.003.000	10,000MM	1	66970.010.000	16,000MM	1	66970.016.000
3,175MM	1	66970.003.175	12,000MM	1	66970.012.000	20,000MM	1	66970.020.000
4,000MM	1	66970.004.000						

66990	Kule techniczne nieżelazne	S54A
Materiał	Szkło	

d	☒	Kod artykułu	d	☒	Kod artykułu	d	☒	Kod artykułu
3,000MM	1	66990.003.000	5,000MM	1	66990.005.000	10,000MM	1	66990.010.000

Pierścienie uszczelniające

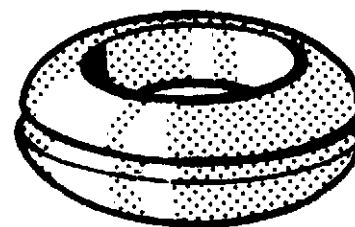
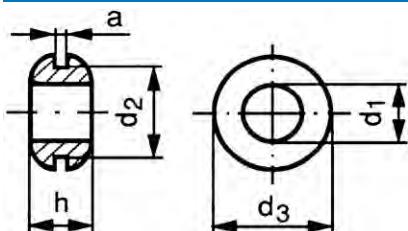

Informacje techniczne

$d_1 \times d_2$	a	d_3	h	$d_1 \times d_2$	a	d_3	h
3.2x4.75	1.6	8	6.4	12.5x17.5	1.6	22	6.4
4.0x6.4	1.6	9.5	6.3	12.5x20	1.6	25.5	6.4
4.75x9.5	1.6	12.5	7	14.2x17.5	1.6	22	4.8
4.8x9.5	1.6	12.5	6.8	15.5x20	1.6	24	7.5
5.5x8	1.6	11	5.5	16.0x19	1.6	24	6
6.4x9.5	1.6	14.2	6.4	16.0x20	1.6	24	7.5
8.0x9.5	1.6	14.2	8	17.5x19	1.6	24	4.8
8.0x11	1.6	14.2	4.8	18.5x25.2	1.6	31.4	8
8.0x12.5	1.6	16	6.4	22.0x25.5	1.6	30	8
9.5x12.5	1.6	17	7	24.7x32	1.6	38	7.8
9.5x14.2	1.6	19	6.4	32.0x38	1.6	46	9.5
11.0x12.5	1.6	19	6.4	45.0x50	1.6	60	10

- Cechy szczególne pierścieni uszczelniających:
- Chronią przewód elektryczny w stalowej blaszce.
- Doskonała izolacja.
- Mocne i bezpieczne.
- Zmniejszają wibrację.

38900 Pierścienie uszczelniające

W05D

Materiał Plastik Poliwinylchlorok
Kolor Czarny

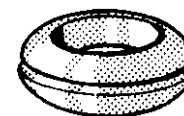

$d_1 \times d_2$	☒	Kod artykułu	$d_1 \times d_2$	☒	Kod artykułu	$d_1 \times d_2$	☒	Kod artykułu
3,2X4,75MM	100	38900.032.047	9,5X12,5MM	100	38900.095.125	16,0X20,0MM	50	38900.160.200
4,0X6,4MM	100	38900.040.064	9,5X14,2MM	100	38900.095.142	17,5X19,0MM	50	38900.175.190
4,8X9,5MM	100	38900.048.095	11,0X12,5MM	100	38900.110.125	18,5X25,2MM	25	38900.185.252
5,5X8,0MM	100	38900.055.080	12,5X17,5MM	100	38900.125.175	22,0X25,5MM	25	38900.220.255
6,4X9,5MM	100	38900.064.095	12,5X20,0MM	100	38900.125.200	24,7X32,0MM	25	38900.249.310
8,0X9,5MM	100	38900.080.095	14,2X17,5MM	50	38900.142.175	32,0X38,0MM	25	38900.320.380
8,0X11,0MM	100	38900.080.110	16,0X19,0MM	50	38900.160.190	45,0X50,0MM	25	38900.450.500
8,0X12,5MM	100	38900.080.125						

Korki zaślepiające

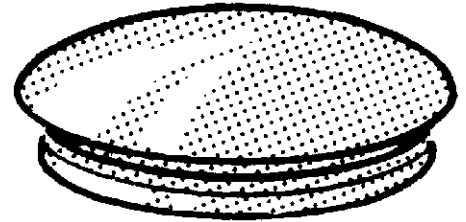
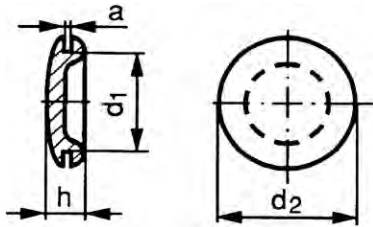

Informacje techniczne

$d_1 \times d_2$	a	h	$d_1 \times d_2$	a	h
4.7x9.3	1.6	4.6	19.0x25.5	1.6	6.5
6.4x9.5	1.6	5	20.0x25.5	1.6	6.7
8.0x14.2	1.6	5	22.5x28.4	1.6	9.3
9.5x15.4	1.6	7.3	25.4x32	1.6	9
11.2x17.7	1.6	6.2	31.5x38.2	1.6	7.5
12.5x18.7	1.6	5.6	38.2x43.3	1.6	8.2
15.5x22	1.6	7.5	51.5x57.5	1.6	11.4

38950 Korki zaślepiające

W05D

Materiał Plastik Poliwinylchlorerek
Kolor Czarny

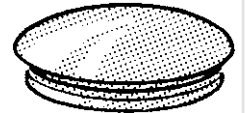

$d_1 \times d_2$	☒	Kod artykułu	$d_1 \times d_2$	☒	Kod artykułu	$d_1 \times d_2$	☒	Kod artykułu
4,7X9,3MM	100	38950.047.093	12,5X18,7MM	100	38950.125.187	25,4X32,0MM	25	38950.254.320
6,4X9,5MM	100	38950.064.095	15,5X22,0MM	100	38950.155.220	31,5X38,2MM	25	38950.315.382
8,0X14,2MM	100	38950.080.142	19,0X25,5MM	100	38950.190.255	38,2X43,3MM	25	38950.382.433
9,5X15,4MM	100	38950.095.154	20,0X25,5MM	50	38950.200.255	51,5X57,5MM	25	38950.515.575
11,2X17,7MM	100	38950.112.177	22,5X28,4MM	50	38950.225.284			

Zacisk z pojedynczym mocowaniem

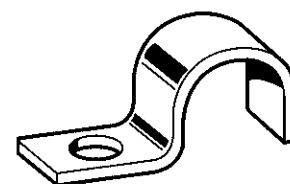
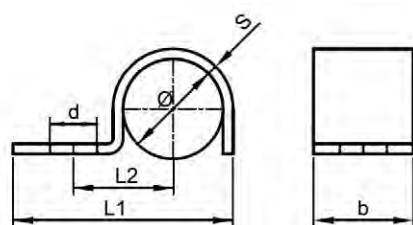

Informacje techniczne

Rury ø	b	d	L ₁	L ₂	s	ø
1x4	10	4.8	18	9	1	4
1x5	10	4.8	18.5	9	1	5
1x6	10	4.8	20	10	1	6
1x7	10	4.8	20.5	10	1	7
1x8	10	4.8	22	11	1	8
1x10	10	4.8	23	11	1	10
1x12	12	5.8	30.5	16	1.5	12
1x15	12	5.8	34	18	1.5	15
1x16	12	5.8	35	18	1.5	16
1x18	12	7	35.5	18	1.5	18
1x20	12	7	37.5	18	1.5	20
1x22	12	7	39.5	20	1.5	22
2x6	10	4.8	26.5	13	1	6
2x8	10	4.8	30.5	15	1	8
2x10	10	4.8	33.5	16	1	10
2x12	12	5.8	43	22	1.5	12

43213 Zacisk z pojedynczym mocowaniem

Y61A

Materiał Stal
Obróbka powierzchni Ocynkowane



Dla rury ø	☒	Kod artykułu	Dla rury ø	☒	Kod artykułu	Dla rury ø	☒	Kod artykułu
1X4	100	43213.010.004	1X12	100	43213.010.012	2X6	100	43213.020.006
1X5	100	43213.010.005	1X15	100	43213.010.015	2X8	100	43213.020.008
1X6	100	43213.010.006	1X16	100	43213.010.016	2X10	100	43213.020.010
1X7	100	43213.010.007	1X18	100	43213.010.018	2X12	100	43213.020.012
1X8	100	43213.010.008	1X20	100	43213.010.020			
1X10	100	43213.010.010	1X22	100	43213.010.022			

Zacisk z podwójnym mocowaniem

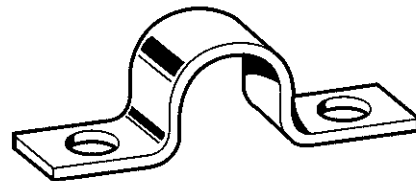
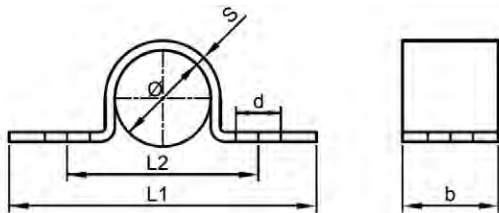

Informacje techniczne

Rury \varnothing	b	d	L ₁	L ₂	s	\varnothing
1x6	10	4.8	32	20	1	6
1x8	10	4.8	34	22	1	8
1x10	10	4.8	34	22	1	10
1x12	12	5.8	46	32	1.5	12
1x15	12	5.8	50	36	1.5	15
1x18	12	7	50	36	1.5	18
1x20	12	7	52	38	1.5	20
1x22	12	7	54	40	1.5	22
2x6	10	4.8	38	26	1	6
2x8	10	4.8	42	30	1	8
2x10	10	4.8	44	32	1	10
2x12	12	5.8	58	44	1.5	12
2x18	12	7	69	55	1.5	18

43214 Zacisk z podwójnym mocowaniem

Y61A

Materiał Stal
Obróbka powierzchni O cynkowane



Dla rury \varnothing	☒	Kod artykułu	Dla rury \varnothing	☒	Kod artykułu	Dla rury \varnothing	☒	Kod artykułu
1X6	100	43214.010.006	1X18	100	43214.010.018	2X8	100	43214.020.008
1X8	100	43214.010.008	1X20	100	43214.010.020	2X10	100	43214.020.010
1X10	100	43214.010.010	1X22	100	43214.010.022	2X12	100	43214.020.012
1X12	100	43214.010.012	2X6	100	43214.020.006	2X18	100	43214.020.018
1X15	100	43214.010.015						

Nowe opaski zaciskowe MaxxFast

Firma MaxxFast wprowadza na rynek całkowicie nową serię wysokiej jakości opasek zaciskowych, wraz z akcesoriami. Seria ta zawiera standardowe nylonowe opaski zaciskowe (białe i czarne), kolorowe nylonowe opaski zaciskowe (niebieskie, żółte, zielone, szare, czerwone, pomarańczowe), rozluźniane opaski nylonowe (białe i czarne), elementy mocujące opasek zaciskowych oraz wytrzymałe opaski zaciskowe ze stali nierdzewnej A2. Te wysokiej jakości produkty spełnią Państwa oczekiwania związane z najbardziej wymagającymi zastosowaniami.

Nasze standardowe, poliamidowe, czarne i białe opaski zaciskowe 6.6 dostępne są w najpopularniejszych rozmiarach i są wytrzymałe na oleje, smary, sól i rozcieńczone kwasy.

Kolorowe opaski zaciskowe dostępne są w 6 kolorach i są idealnym rozwiązaniem w okablowaniu bazującym na kodowaniu kolorami lub na kablach o takim samym kolorze izolacji w celu zwiększenia estetyki montażu.

Rozluźniane opaski zaciskowe mogą być używane wielokrotnie, co zmniejsza ilość odpadów i koszty montażowe, na przykład przy mocowaniu oświetlenia tymczasowego.

Różne elementy mocujące poliamidowych opasek zaciskowych 6.6 można zaadoptować do wielu sytuacji montażowych, w których zapewnią mocne i szybkie mocowanie kabli w odpowiednie wiązki.

Nowe opaski zaciskowe MaxxFast ze stali nierdzewnej A2

- Nasze wytrzymałe metalowe opaski zaciskowe wykonane są z wysokogatunkowej stali nierdzewnej A2.
- Zaprojektowano je do zastosowań, w których mają wytrzymać wpływ korodujących chemikaliów, słonej wody, promieniowania oraz kontakt z ekstremalnymi temperaturami (-85°C/+500°C).
- Kulkowy mechanizm blokujący zwiększa ich wytrzymałość na rozciąganie, zapewniając łatwość wprowadzania opaski i przyjazną dla użytkownika instalację.
- Szeroki wybór tych opasek powoduje, że znajdują one zastosowanie w przemyśle morskim, mechanicznym, spożywczym i w środowiskach sterylnych.



Opaski zaciskowe kablowe

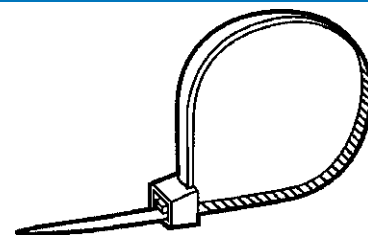
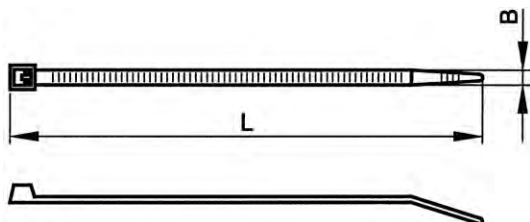

Informacje techniczne

L x B	Maks. ø wiązki	Wytrzymałość na rozciąganie w N
100x2.5	22	80
200x2.5	50	80
140x3.6	33	180
200x3.6	53	180
160x4.8	38	220
200x4.8	50	220
250x4.8	60	220
300x4.8	76	220
368x4.8	102	220
430x4.8	110	220
300x7.6	76	533
368x7.6	102	533
450x7.6	132	533
540x7.6	105	533
430x9.0	110	778
530x9.0	140	778
710x9.0	190	778
780x9.0	228	778
830x9.0	239	778
500x12.5	140	1 118

- W zależności od dostępności wymiary mogą się różnić.

Grupy katalogowe

Material	Klasa	Kolor	Kod	Strona
Plastik PA	PA 6.6	Biały	30900	12-120
Plastik PA	PA 6.6	Czarny	30901	12-120
Plastik PA	PA 6.6	Różny	30902	12-121
Plastik PA	PA 6.6	Duże Opakowanie	43317	12-121

30900 MAXXFAST Opaski zaciskowe białe

MF8A

Material	Plastik Poliamid (nylon)
Klasa	PA 6.6
Kolor	Biały

MAXXFAST
PROFESSIONAL HARDWARE

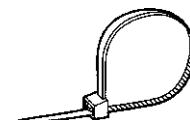

L x B	☒	Kod artykułu	L x B	☒	Kod artykułu	L x B	☒	Kod artykułu
100X2,5	100	30900.100.025	250X4,8	100	30900.250.048	430X9,0	100	30900.430.090
140X3,6	100	30900.140.036	300X4,8	100	30900.300.048	450X7,6	100	30900.450.076
160X4,8	100	30900.160.048	300X7,6	100	30900.300.076	540X7,6	100	30900.540.076
200X2,5	100	30900.200.025	368X4,8	100	30900.368.048	780X9,0	100	30900.780.090
200X3,6	100	30900.200.036	368X7,6	100	30900.368.076			
200X4,8	100	30900.200.048	430X4,8	100	30900.430.048			

- Tylko pełne opakowania.

30901 MAXXFAST Opaski zaciskowe czarne

MF8A

Material	Plastik Poliamid (nylon)
Klasa	PA 6.6
Kolor	Czarny

MAXXFAST
PROFESSIONAL HARDWARE

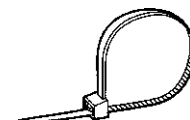

L x B	☒	Kod artykułu	L x B	☒	Kod artykułu	L x B	☒	Kod artykułu
100X2,5	100	30901.100.025	300X4,8	100	30901.300.048	500X12,5	100	30901.500.125
140X3,6	100	30901.140.036	300X7,6	100	30901.300.076	530X9,0	100	30901.530.090
160X4,8	100	30901.160.048	368X4,8	100	30901.368.048	540X7,6	100	30901.540.076
200X2,5	100	30901.200.025	368X7,6	100	30901.368.076	710X9,0	100	30901.710.090
200X3,6	100	30901.200.036	430X4,8	100	30901.430.048	780X9,0	100	30901.780.090
200X4,8	100	30901.200.048	430X9,0	100	30901.430.090	830X9,0	100	30901.830.090
250X4,8	100	30901.250.048	450X7,6	100	30901.450.076			

- Tylko pełne opakowania.

30902 MAXXFAST Opaski zaciskowe kolorowe						MF8A		
Materiał	Plastik Poliamid (nylon)							
Klasa	PA 6.6							
Kolor	Różny							

L x B	☒	Kod artykułu	L x B	☒	Kod artykułu	L x B	☒	Kod artykułu
Niebieski 200X4,8	100	30902.000.002	Zielony 200X4,8	100	30902.000.005	Czerwony 200X4,8	100	30902.000.009
Żółty 200X4,8	100	30902.000.004	Szary 200X4,8	100	30902.000.006	Pomarańczowy 200X4,8	100	30902.000.030

- Tylko pełne opakowania.

43317 Opaski zaciskowe czarne						W050		
Materiał	Plastik Poliamid (nylon)							
Klasa	PA 6.6							
Kolor	Czarny							

L x B	☒	Kod artykułu	L x B	☒	Kod artykułu	L x B	☒	Kod artykułu
100X2,5	1000	43317.100.025	200X4,8	1000	43317.200.048	300X4,8	1000	43317.300.048

Opaski zaciskowe ze stali nierdzewnej

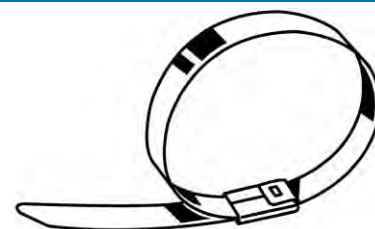
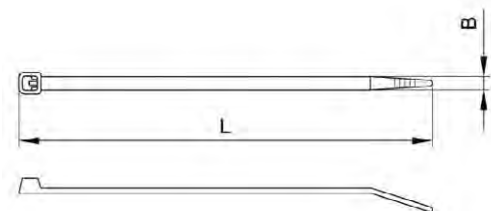

Informacje techniczne		
L x B	Maks. ø wiązki	Wytrzymałość na rozciąganie w N
125x4.6	33	451
200x4.6	50	451
290x4.6	76	451
360x4.6	102	451
520x4.6	156	451
680x4.6	207	451
840x4.6	257	451
200x7.94	50	1 118
290x7.94	76	1 118
360x7.94	102	1 118
520x7.94	150	1 118
680x7.94	207	1 118
840x7.94	257	1 118
1020x9.0	312	1 118

30905	MAXXFAST Opaski zaciskowe ze stali nierdzewnej	MF9A
Materiał	Stal nierdzewna A2	

L x B	☒	Kod artykułu	L x B	☒	Kod artykułu	L x B	☒	Kod artykułu
125X4,6	100	30905.125.046	360X4,6	100	30905.360.046	680X7,94	100	30905.680.079
200X4,6	100	30905.200.046	360X7,94	100	30905.360.079	840X4,6	100	30905.840.046
200X7,94	100	30905.200.079	520X4,6	100	30905.520.046	840X7,94	100	30905.840.079
290X4,6	100	30905.290.046	520X7,94	100	30905.520.079	1020X9,0	100	30905.920.090
290X7,94	100	30905.290.079	680X4,6	100	30905.680.046			

- Tylko pełne opakowania.

Opaski zaciskowe z zaciskiem ze stali nierdzewnej

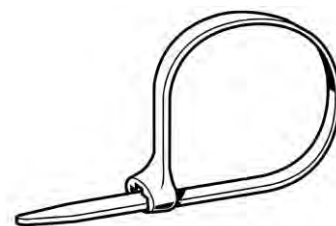
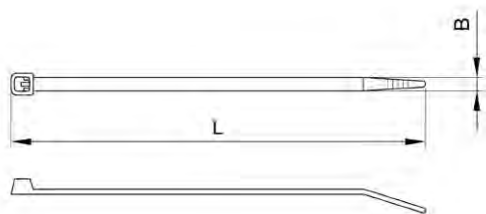

Informacje techniczne

L x B	Maks. ø wiązki	Wytrzymałość na rozciąganie w N
92x2.4	16	81
140x3.6	29	180
186x4.8	45	225
281x3.6	76	180
338x7.0	90	544
360x4.8	102	225
762x7.0	229	544
200x2.4	50	81
356x2.4	102	81
208x3.6	50	180
368x3.6	103	180
293x4.8	78	225
223x7.0	50	544

Grupy katalogowe

Materiał	Klasa	Kolor	Kod	Strona	
Plastik PA	PA 6.6	Odporne na promieniowanie UV	Czarny	43295	12-122
Plastik PA	PA 6.6		Naturalny	43299	12-123

43295	Opaski zaciskowe z zaciskiem ze stali nierdzewnej	Y70A
Materiał	Plastik Poliamid (nylon)	
Klasa	PA 6.6	
Kolor	Czarny	

L x B	☒	Kod artykułu	L x B	☒	Kod artykułu	L x B	☒	Kod artykułu
92X2,4	100	43295.000.023	360X4,8	100	43295.000.028	208X3,6	100	43295.000.242
140X3,6	100	43295.000.024	762X7,0	50	43295.000.029	368X3,6	100	43295.000.244
186X4,8	100	43295.000.025	200X2,4	100	43295.000.232	293X4,8	100	43295.000.253
281X3,6	100	43295.000.026	356X2,4	100	43295.000.234	223X7,0	50	43295.005.272
338X7,0	50	43295.000.027						

43299	Opaski zaciskowe z zaciskiem ze stali nierdzewnej	Y70A
Materiał	Plastik Poliamid (nylon)	Ty-Rap®
Klasa	PA 6.6	
Kolor	Naturalny	



L x B	☒	Kod artykułu	L x B	☒	Kod artykułu	L x B	☒	Kod artykułu
92x2,4	100	43299.000.023	338x7,0	50	43299.000.027	208x3,6	100	43299.000.242
140x3,6	100	43299.000.024	360x4,8	100	43299.000.028	368x3,6	100	43299.000.244
186x4,8	100	43299.000.025	762x7,0	100	43299.000.029	293x4,8	100	43299.000.253
281x3,6	100	43299.000.026	200x2,4	100	43299.000.232	223x7,0	100	43299.005.272

Zestawy opasek zaciskowych



43310	Zestawy opasek zaciskowych	Y94A
Materiał	Plastik Poliamid (nylon)	
Klasa	PA 6.6	



Typ	☒	Kod artykułu	
Asortyment	1	43310.001.700	<ul style="list-style-type: none"> • Zawartość: • 100 x 2,5 mm - 500 sztuk • 140 x 3,6 mm - 300 sztuk • 200 x 4,8 mm - 300 sztuk • 300 x 4,8 mm - 300 sztuk • 368 x 4,8 mm - 200 sztuk



Opaski zaciskowe z oczkiem do przytwierdzenia do podłoża

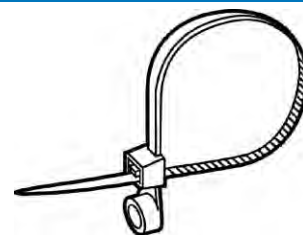
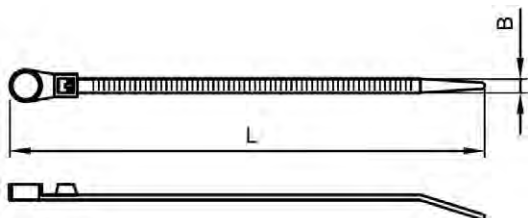

Informacje techniczne

L x B	Maks. ø wiązki	Wytrzymałość na rozciąganie w N	Średnica oczka ø
110x2.5	22	81	3.2
150x3.6	32	182	4.2
200x4.8	50	222	5.5
377x4.8	102	222	5.5
380x7.6	98	544	6.3

- W zależności od dostępności wymiary mogą się różnić.

43323 Opaski zaciskowe z oczkiem do przytwierdzenia do podłoża

W050

Materiał Plastik Poliamid (nylon)
Klasa PA 6.6
Kolor Biały



L x B	☒	Kod artykułu	L x B	☒	Kod artykułu	L x B	☒	Kod artykułu
110X2,5	100	43323.110.025	200X4,8	100	43323.200.048	380X7,6	100	43323.368.076
150X3,6	100	43323.150.036	377X4,8	100	43323.368.048			

Opaski zaciskowe z tabliczką opisową

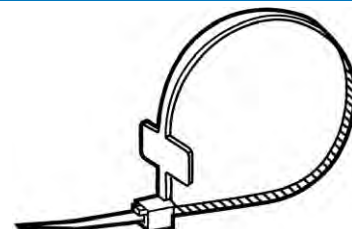
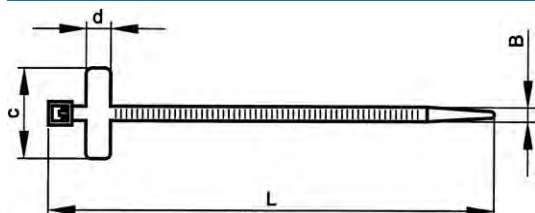

Informacje techniczne

L x B	c	d	Maks. ø wiązki	Typ nr.	Wytrzymałość na rozciąganie w N
100x2.5	25.4	8	18	1	81
110x2.5	20.4	9.1	18	2	81
200x2.5	25.4	8	50	1	81
220x4.8	28	13	54	3	225
200x4.8 - 4	30	28	54	4	225
270x4.8	28	13	65	3	225
270x4.8 - 4	30	28	65	4	225

- W zależności od dostępności wymiary mogą się różnić.

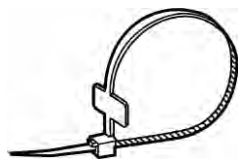
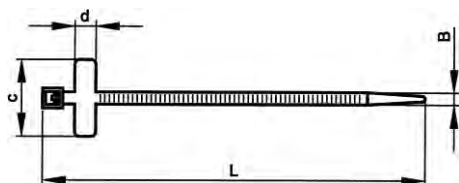

TYP 1

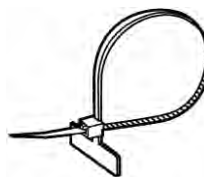
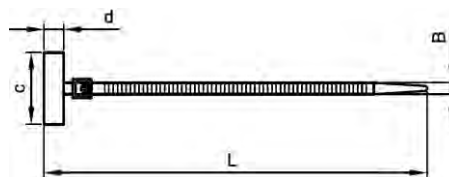

TYP 2

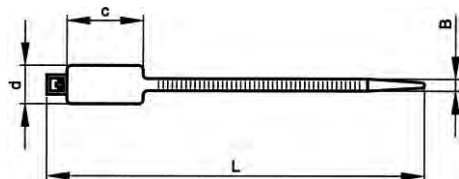

TYP 3

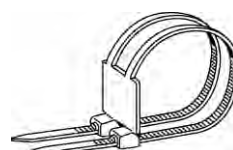
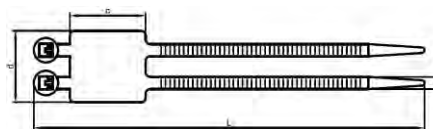

TYP 4

Grupy katalogowe

Material	Klasa	Kolor	Kod	Strona
Plastik PA	PA 6.6	Biały	43324	12-125
Plastik PA	PA 6.6	Biały	43325	12-125

43324 Opaski zaciskowe z tabliczką opisową

W050

Material Plastik Poliamid (nylon)
Klasa PA 6.6
Kolor Biały



L x B	☒	Kod artykułu	L x B	☒	Kod artykułu	L x B	☒	Kod artykułu
100X2,5MT	100	43324.100.025	200X2,5MT	100	43324.200.025	270X4,8MT	100	43324.270.048
110X2,5MT	100	43324.110.025	220X4,8MT	100	43324.220.048			

43325 Opaski zaciskowe z tabliczką opisową

W050

Material Plastik Poliamid (nylon)
Klasa PA 6.6
Kolor Biały

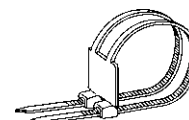

L x B	☒	Kod artykułu
270X4,8MT2	100	43325.270.048

Opaski zaciskowe wielokrotnego użytku (z możliwością luzowania)

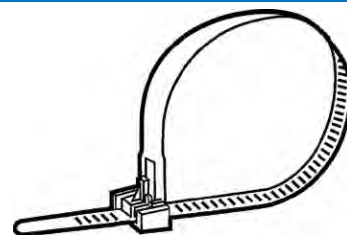
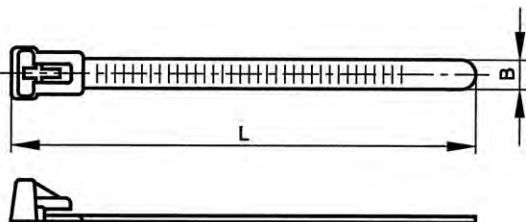

Informacje techniczne

L x B	Maks. ø wiązki	Wytrzymałość na rozciąganie w N
140x3.6	33	180
200x4.8	50	220
300x4.8	86	220
368x4.8	102	220
100x7.6	20	220
150x7.6	35	220
200x7.6	50	220
300x7.6	80	220

- W zależności od dostępności wymiary mogą się różnić.

Grupy katalogowe

Materiał	Klasa	Kolor	Kod	Strona
Plastik PA	PA 6.6	Czarny	30903	12-126
Plastik PA	PA 6.6	Biały	30904	12-126

30903 MAXXFAST Opaski zaciskowe wielokrotnego użytku (z możliwością luzowania) MF8A

Materiał Plastik Poliamid (nylon) **MAXXFAST**
PROFESSIONAL HARDWARE
Klasa PA 6.6
Kolor Czarny

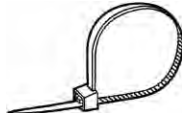

L x B	☒	Kod artykułu	L x B	☒	Kod artykułu	L x B	☒	Kod artykułu
100X7,6	100	30903.100.076	200X7,6	100	30903.200.076	300X7,6	100	30903.300.076
150X7,6	100	30903.150.076						

- Tylko pełne opakowania.

30904 MAXXFAST Opaski zaciskowe wielokrotnego użytku (z możliwością luzowania) MF8A

Materiał Plastik Poliamid (nylon) **MAXXFAST**
PROFESSIONAL HARDWARE
Klasa PA 6.6
Kolor Biały



L x B	☒	Kod artykułu	L x B	☒	Kod artykułu	L x B	☒	Kod artykułu
140X3,6	100	30904.140.036	300X4,8	100	30904.300.048	368X4,8	100	30904.368.048
200X4,8	100	30904.200.048						

- Tylko pełne opakowania.

Opaski zaciskowe z podstawą do mocowania

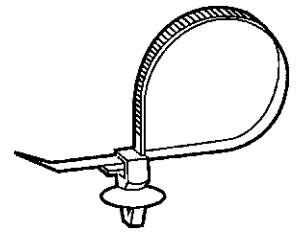
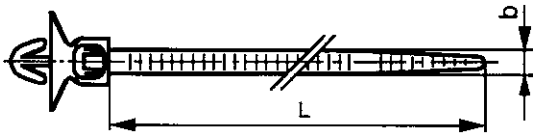

Informacje techniczne

Nr	2781
b	4.5
Grubość materiału	0.6-1.6
L	140
Maks. \varnothing wiązki	8-35
Otwór \varnothing	6.5
Wytrzymałość na rozciąganie w N	140

- W zależności od dostępności wymiary mogą się różnić.

56834 Opaski zaciskowe z podstawą do mocowania

W05B

Materiał Plastik Poliamid (nylon)
Klasa PA 6.6
Kolor Czarny

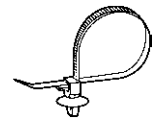

Nr	<input type="checkbox"/>	Kod artykułu
2781 Czarny	100	56834.278.101

Podstawy mocujące do opasek zaciskowych

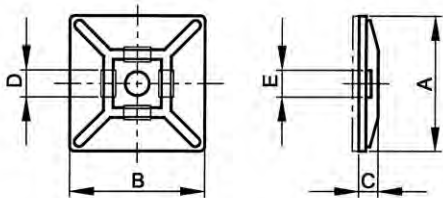

Informacje techniczne

Typ	A	B	C	D	E
19X19	19	19	4	3.8	3
28X28	28	28	5	5.5	5
2.4-4.8	9	14	7	5	3.5
2.4-9.0	10	37	6.5	9.2	-

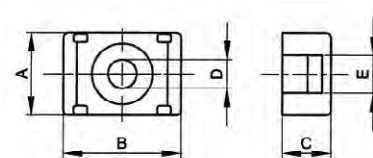
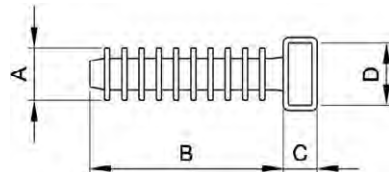
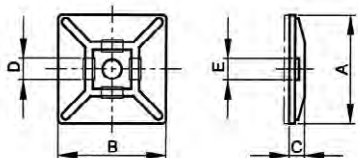
1
2
3

Materiał Plastik Poliamid (nylon)



Wymiary	☒	Kod artykułu	Wymiary	☒	Kod artykułu	Wymiary	☒	Kod artykułu
Type-1-Biały19X19	100	30908.001.019	Type-1-Czarny19X19	100	30908.002.019	Type-3-Czarny2,4-4,8	100	30908.102.024
Type-1-Biały28X28	100	30908.001.028	Type-1-Czarny28X28	100	30908.002.028	Type-2-Czarny2,4-9,0	100	30908.770.024

- (1) Element mocujący poliamidowe opaski zaciskowe, wymiary 19x19mm PA 6.6, do mocowania kabli o maksymalnej szerokości 3,6 mm. Element mocujący poliamidowe opaski zaciskowe, wymiary 28x28mm PA 6.6, do mocowania kabli o maksymalnej szerokości 4,8 mm. Dostępny w kolorze białym lub czarnym odpornym na promieniowanie UV. Bardzo mocna samoprzylepna guma po stronie przylegającej do powierzchni mocowania, zapewnia szybki i łatwy montaż. Może być alternatywnie dokręcany śrubą.
- (2) Kolek mocujący poliamidowe opaski zaciskowe PA 6.6, dostępny w ochronnym kolorze czarnym, odpornym na promieniowanie UV. W celu zainstalowania należy wywiercić otwór (średnica: 7mm -głębokość: 40mm) w ścianie muranowej i wprowadzić kolek dobijając młotkiem. Do mocowania kabli o maksymalnej szerokości 9mm.
- (3) Blok mocujący poliamidowe opaski zaciskowe PA 6.6, dostępny w kolorze czarnym, odpornym na promieniowanie UV. Dokręcany prostą śrubą. Do mocowania kabli o maksymalnej szerokości 4,8 mm.

Podstawy mocujące do opasek zaciskowych

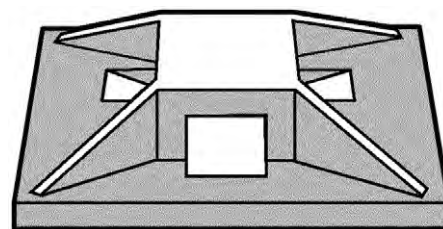
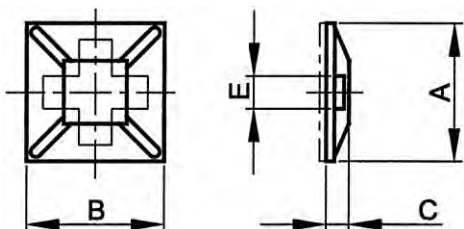

Informacje techniczne

Nr	A	B	C	D ø	Do opasek zaciskowych	E
100	12.5	12.5	3.2	-	3.2	3.2
101	21	21	3.5	-	4.6	4.7
101-S	19	19	3.9	3.2	4.2	4.5
102	28	28	4	5	4.7/4.8	5
103	28	28	4	5	4.8	5
1675	25.4	25.4	6.8	4	2.5	3.6
1676	25.4	25.4	6.8	4	6.5	7.8
1708	9	13	6	3.1	3.6	4

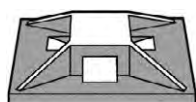
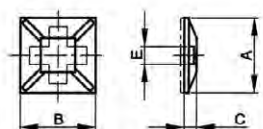

No. 100/101

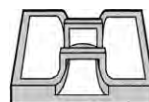
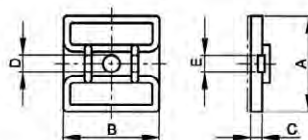

No. 103

56833	Podstawy mocujące do opasek zaciskowych	W05B
Materiał	Plastik Poliamid (nylon)	
Kolor	Biały	

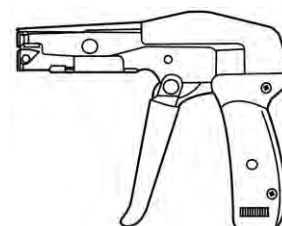

Nr	✉	Kod artykułu	Nr	✉	Kod artykułu
100 SAMOPRZYLEPNE	100	56833.100.001	103 SAMOPRZYLEPNE	100	56833.103.001

Szczypce ręczne do plastikowych / metalowych opasek





Grupy katalogowe

Kod	Strona
30906	12-129
30907	12-129

30906	MAXXFAST Szczypce ręczne do plastikowych opasek	MFNA
		

Dla wymiaru nominalnego	✉	Kod artykułu	Dla wymiaru nominalnego	✉	Kod artykułu
2,4-4,8MM	1	30906.024.048	3,6-9,5MM	1	30906.036.095

- Ręczne narzędzie do mocowania poliamidowych opasek zaciskowych PA 6.6 o maksymalnej szerokości do 4,8mm. Automatycznie zaciska i docina opaski zaciskowe za pomocą jednego prostego działania.

30907	MAXXFAST Szczypce ręczne do metalowych opasek	MFNA
		

Dla średnicy liny	✉	Kod artykułu
4,6-7,94MM	1	30907.046.079

- Ręczne narzędzie do mocowania opasek zaciskowych ze stali nierdzewnej o maksymalnej szerokości do 7,94 mm. Automatycznie zaciska i docina opaski zaciskowe za pomocą jednego prostego działania.

Opaski zaciskowe do węży, plastikowe

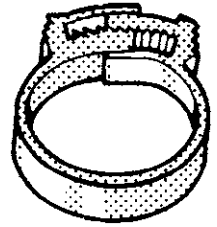
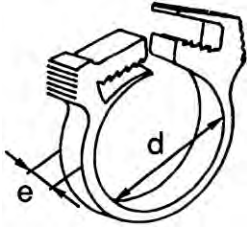

Informacje techniczne

d	e	d	e
8-9.2	5	20.5-23	7
9.5-10.5	5	22-25	7
10.2-12	6	25-28	7
12-13.5	6	27-30	7.5
12.8-15	7	29.5-32.5	7.5
15-17.2	7	32.5-35.5	8
17-18.5	7	35-38.5	8
18.2-20.5	7		

- d = zakres uchwytu.

56672 Opaski zaciskowe do węży, plastikowe

W02A

Materiał Plastik Poliamid (nylon)
Klasa PA 6.6



d	☒	Kod artykułu	d	☒	Kod artykułu	d	☒	Kod artykułu
8,0-9,2MM	50	56672.008.009	15,0-17,2MM	50	56672.015.017	25,0-28,0MM	25	56672.025.028
9,2-10,5MM	50	56672.009.011	17,0-18,5MM	25	56672.017.019	27,0-30,0MM	25	56672.027.030
10,2-12,0MM	50	56672.010.012	18,2-20,5MM	25	56672.018.021	29,5-32,5MM	10	56672.029.033
12,0-13,5MM	50	56672.012.014	20,5-23,0MM	25	56672.020.023	32,5-35,5MM	10	56672.032.035
12,8-15,0MM	50	56672.012.015	22,0-25,0MM	25	56672.022.025	35,0-38,5MM	10	56672.035.038

Zaciski z końcówką mocującą wciskaną

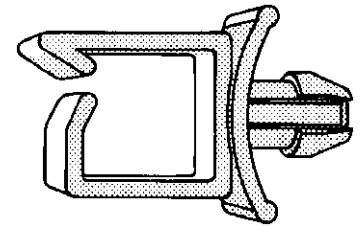
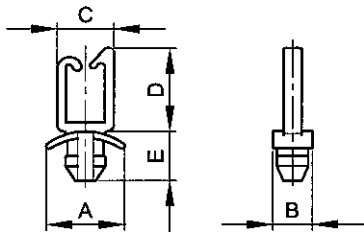

Informacje techniczne

Nr	0320	1590
A	13.4	12.4
B	5.7	5.5
C	11	11.9
D	13	2.4
E	7.8	8.5
F	-	7.5
Grubość materiału	0.4-1.5	0.4-1.8
Maks. \varnothing przewodu	8	5
Otwór \varnothing/\square	4.8 \varnothing	4.8 \varnothing
Typ nr.	1	2

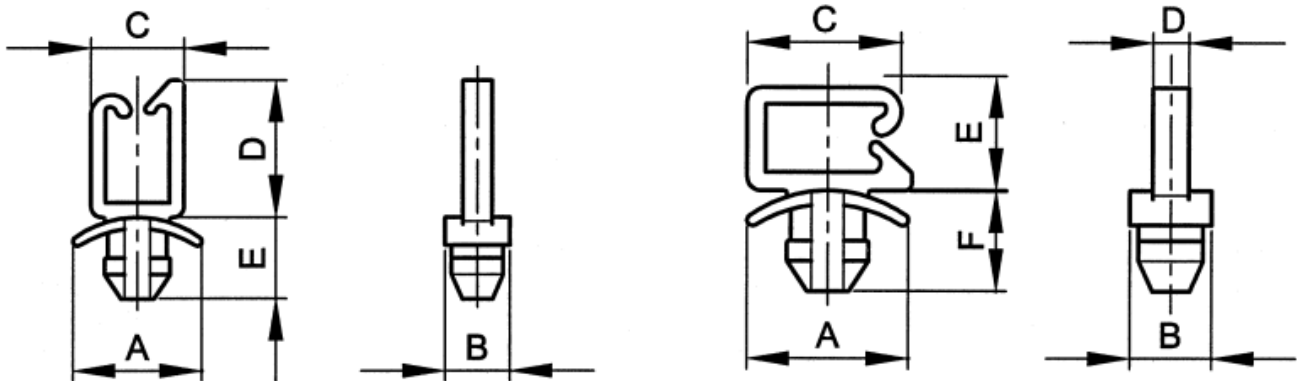

56840 Zaciski z końcówką mocującą wciskaną

W05B

Materiał Plastik Poliamid (nylon)
Klasa PA 6.6
Kolor Biały

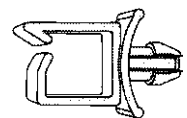

Nr	✉	Kod artykułu	Nr	✉	Kod artykułu
0320 NATURALNY	100	56840.032.001	1590 NATURALNY	100	56840.159.001

Zaciski do kabli, samoprzylepne

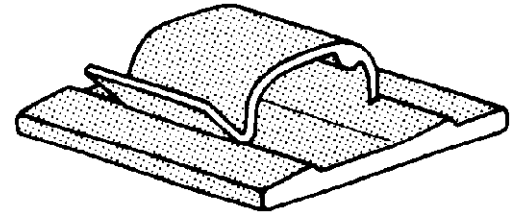
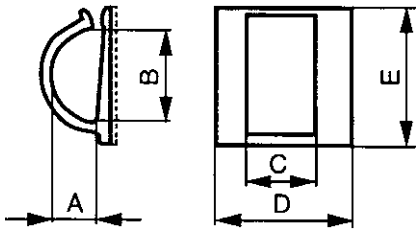

Informacje techniczne

Nr	1030	1061	1087	1818	2748
A	7	13.5	4	8	6.4
B	11.7	21	4.6	11.7	8
C	12.4	25.4	9.5	9.5	5.5
D	25.4	31.8	16	19	8.8
E	25.4	31.8	16	19	18
Maks. \varnothing przewodu	8	16	5	8	6.5
Typ nr.	1	1	1	1	2

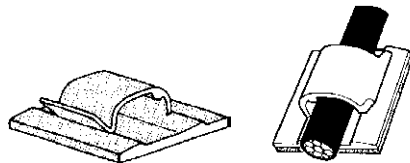
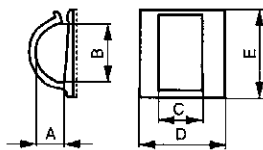

TYP 1

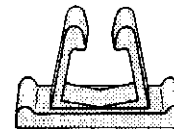
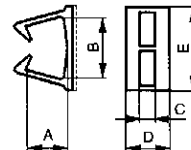

TYP 2

56835 Zaciski do kabli, samoprzylepne

W05B

Materiał Plastik Poliamid (nylon)
Klasa PA 6.6
Kolor Biały

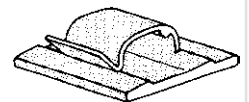

Nr	☒	Kod artykułu	Nr	☒	Kod artykułu	Nr	☒	Kod artykułu
1030 NATURALNY	100	56835.103.001	1087 NATURALNY	100	56835.108.701	2748 NATURALNY	100	56835.274.801
1061 NATURALNY	100	56835.106.101	1818 NATURALNY	100	56835.181.801			

Zaciski do kabli płaskich, samoprzylepne

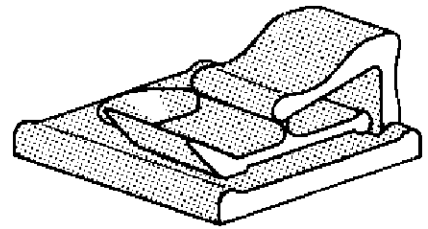
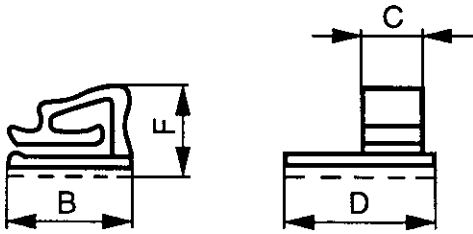

Informacje techniczne

Nr	A	B	C	D	F
2622	-	16	7	16	10
7122	51	62	8	16	14
7255	-	16	7	16	10

- 2622 - 7122 = z otworem w płycie dolnej.

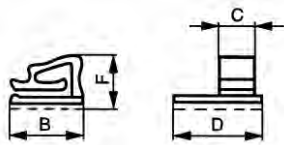

Nr. 2622

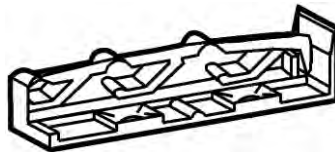
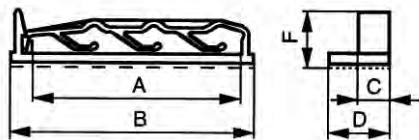

Nr. 7122

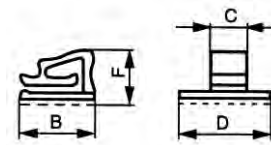

Nr. 7255

56832 Zaciski do kabli płaskich, samoprzylepne

W05B

Materiał Plastik Poliamid (nylon)
Klasa PA 6.6
Kolor Biały



Nr	☒	Kod artykułu	Nr	☒	Kod artykułu	Nr	☒	Kod artykułu
2622 NATURALNY	100	56832.262.201	7122 NATURALNY	50	56832.712.201	7255 NATURALNY	100	56832.725.501

Uchwyty kablowe

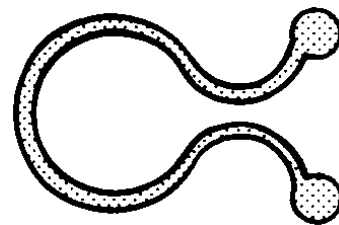
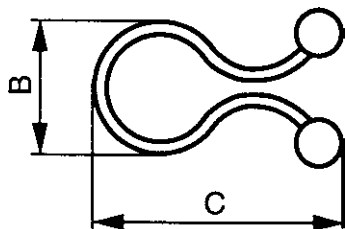

Informacje techniczne

Nr	B	C	Przewód \varnothing	Typ nr.
0787	8.5	20	4-6.9	1
0788	12.5	25	7-9.5	1
0789	15	30	10-12.5	1
0794	23	40	17-20	1
0960	12	25	7-9.5	2
1334	11.9	25	7.5-10	3
1650	19	35	13.5-16	2
1651	23	40	17-20	2
1652	30	46	25-27.5	2

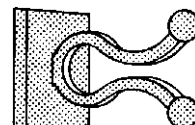
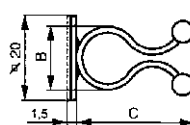
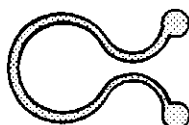
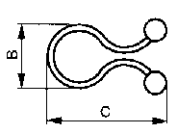

56837 Uchwyty kablowe

W05B

Materiał Plastik Poliamid (nylon)
Klasa PA 6.6

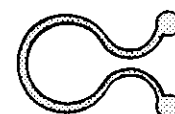

Nr barwy	☒	Kod artykułu	Nr barwy	☒	Kod artykułu	Nr barwy	☒	Kod artykułu
0787 NATURALNY	100	56837.078.701	0794 CZARNY	100	56837.079.402	1650 NATURALNY	100	56837.165.001
0788 NATURALNY	100	56837.078.801	0960 NATURALNY	100	56837.096.001	1650 CZARNY	100	56837.165.002
0788 CZARNY	100	56837.078.802	1334 NATURALNY	100	56837.133.401	1651 NATURALNY	100	56837.165.101
0789 NATURALNY	100	56837.078.901	1334 SAMOPRZYLEP- NY	100	56837.133.402	1652 NATURALNY	100	56837.165.201
0794 NATURALNY	100	56837.079.401						

Elementy dystansowe, plastikowe

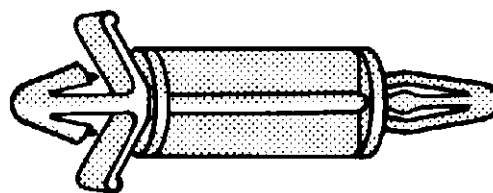
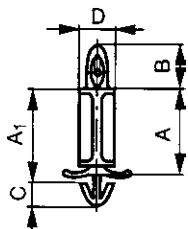

Informacje techniczne

Nr	7061	7062	7065	7112	7115	7192	7193
A	4.8	6.4	6.4	13.2	10.2	9.5	6.4
A ₁	8.4	9.9	7.9	19.6	13.2	-	-
B	10	10	9.5	4	10	10	10
C	5.5	5.5	1.5	4	7	6.4	6.4
D ø	7	7	5.8	10	7.1	9	9
Grubość płyty druku	1.6	1.6	1.6	1.4-1.8	0.8-2.5	1.6	1.6
Grubość płyty podstawowej	0.4-2	0.4-2	1.6	1.4-1.8	0.8-3	0.4-3	0.4-3
Otwór płyty druku ø	4	4	4	4.9	3.5	4	4
Otwór płyty podstawowej ø/□	4.8 ø	4.8 ø	6.3 □	4.9 ø	4.8 ø	4 ø	4 ø
Typ nr.	1	1	3	5	6	2	2

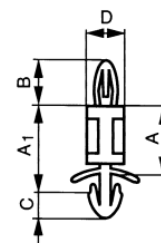
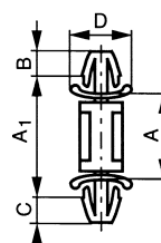
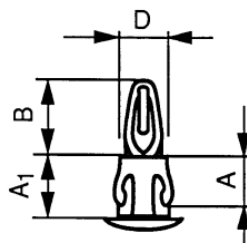
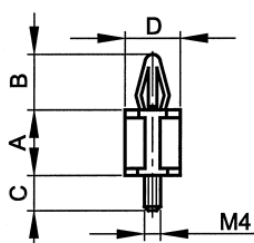
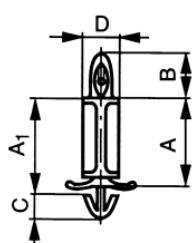

56839 Elementy dystansowe, plastikowe

W05B

Materiał Plastik Poliamid (nylon)
Klasa PA 6.6
Kolor Biały

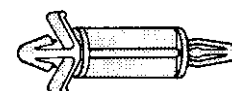

Nr	☒	Kod artykułu	Nr	☒	Kod artykułu	Nr	☒	Kod artykułu
7061 NATURALNY	100	56839.706.101	7112 NATURALNY	100	56839.711.201	7192 NATURALNY	100	56839.719.201
7062 NATURALNY	100	56839.706.201	7115 NATURALNY	100	56839.711.501	7193 NATURALNY	100	56839.719.301
7065 NATURALNY	100	56839.706.501						

Nity wbijane

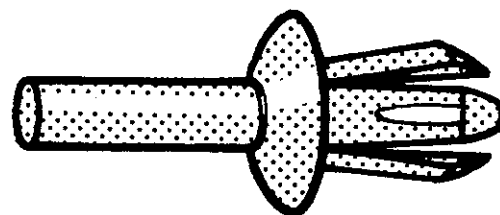
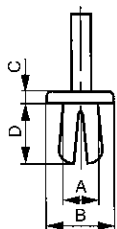

Informacje techniczne

Nr	0164	0756	0765	0780	1283	7005
A \varnothing	4.2	3.5	6.2	4.8	4.8	3.8
B \varnothing	6	6.3	11	8.7	7.1	7.5
C	1.5	1.8	2	2.5	1.2	1.3
D	5	6.6	12.3	7.4	11.1	8.2
Grubość materiału	1-3.5	3.2-4.8	5.5-9.5	1.6-4.75	4-8.7	4-6.5
Otwór \varnothing	4.3-4.8	3.4-3.6	6.4-7	4.75	4.8-5.4	4-4.2
Typ nr.	1	2	1	1	3	3

- Zalecana jest większa średnica do zastosowania w grubych arkuszach materiału.
- Zalecane jest, aby wyboru dokładnej średnicy dokonać na podstawie testów.

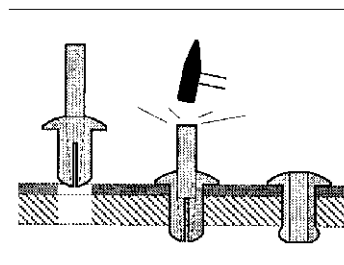
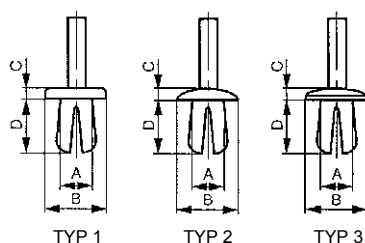

56819 Nity wbijane

W05B

Materiał Plastik Poliamid (nylon)
Klasa PA 6.6
Kolor Różny

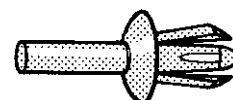

Nr barwy	☒	Kod artykułu	Nr barwy	☒	Kod artykułu	Nr barwy	☒	Kod artykułu
0756 Naturalny	100	56819.075.601	0780 Naturalny	100	56819.078.001	1283 Czarny	100	56819.128.302
0756 Czarny	100	56819.075.602	0780 Czarny	100	56819.078.002	7005 Naturalny	100	56819.700.501
0765 Naturalny	100	56819.076.501	1283 Naturalny	100	56819.128.301	7005 Czarny	100	56819.700.502
0765 Czarny	100	56819.076.502						

Nity wkręcane

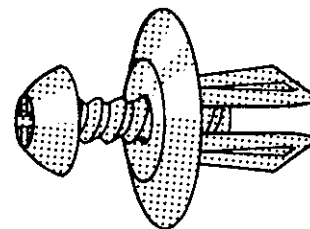
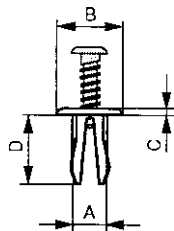

Informacje techniczne

Nr	2384	2710	3008
A \varnothing	6	5	8
B \varnothing	16	12	20
C	1.5	1.5	1.3
D	11	11	14
Grubość materiału	4	3.75-6	3-10
Otwór \varnothing	6.5	5	8

- Zalecana jest większa średnica do zastosowania w grubych arkuszach materiału.
- Zalecane jest, aby wyboru dokładnej średnicy dokonać na podstawie testów.

Dane montażowe

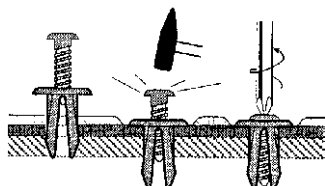

56818 Nity wkręcane		W05B
Materiał	Plastik Poliamid (nylon)	
Klasa	PA 6.6	
Kolor	Czarny	

Nr	✉	Kod artykułu	Nr	✉	Kod artykułu	Nr	✉	Kod artykułu
2384 CZARNY	100	56818.238.401	2710 CZARNY	100	56818.271.001	3008 CZARNY	100	56818.300.801

Nity zapadkowe

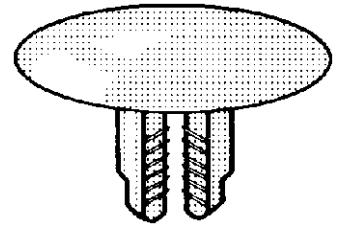
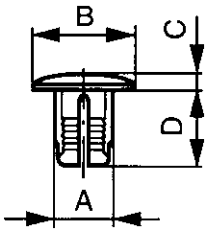

Informacje techniczne

Nr	7012	7013	7015
A \varnothing	7	7	7
B \varnothing	19.1	19.1	10.3
C	2.4	2.4	1.6
D	8.7	12.4	5.7
Grubość materiału	8.8-12.7	12.7-20.6	6-7.5
Otwór	7.1	7.1	7.1

Dane montażowe

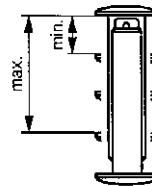
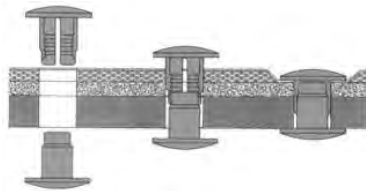

56830 Nity zapadkowe		W05B
Materiał	Plastik Poliamid (nylon)	
Klasa	PA 6.6	
Kolor	Biały	

Nr	☒	Kod artykułu	Nr	☒	Kod artykułu	Nr	☒	Kod artykułu
7012 NATURALNY	100	56830.701.201	7013 NATURALNY	100	56830.701.301	7015 NATURALNY	100	56830.701.501

- UWAGA: opakowanie 100 sztuk = 50 połączeń.

Nity wciskane

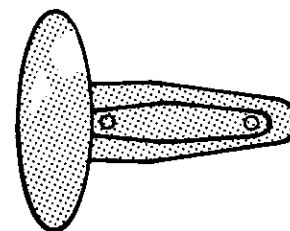
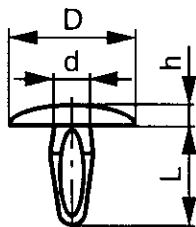

Informacje techniczne

Nr	0001	0130	0796	1840	1854
D \varnothing	14	14	14	7.9	9.5
d \varnothing	4.7	6	4.6	2.6	4.6
Grubość materiału	3-6	3-7	2	0.8-3.6	0.8-4
h	2.2	2.5	3	1.3	1.5
L	15	19	14.5	12.3	11.1
Otwór \varnothing	4.8	6	5	2.7	4.8

Dane montażowe

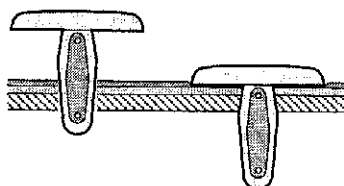

56824 Nity wciskane		W05B
Materiał	Plastik Poliamid (nylon)	
Klasa	PA 6.6	
Kolor	Różny	

Nr barwy	☒	Kod artykułu	Nr barwy	☒	Kod artykułu	Nr barwy	☒	Kod artykułu
0001 CZARNY	100	56824.000.101	0796 BIAŁY	100	56824.079.602	1854 NATURALNY	100	56824.185.401
0130 BIAŁY	100	56824.013.001	1840 CZARNY	100	56824.184.001	1854 CZARNY	100	56824.185.402
0796 CZARNY	100	56824.079.601						

Przelotki

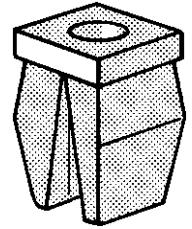
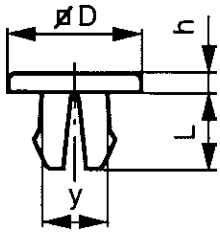

Informacje techniczne

Nr	0012	0013	0916	1378
D ø/□	13 ø	9.5 ø	10 □	5.6 □
Do śruby	ST4.2	ST4.2	ST4.2	ST2.9
Grubość materiału	0.8-4	0.8-4	0.8-4.5	0.8-2
h	1.5	1.2	3	1.3
L	8.3	8.3	8	5.6
Otwór ø/□	7 □	7 □	6 ø	4.3 □
Typ nr.	1	1	2	2
Y	6.9	6.9	5.6	4.3

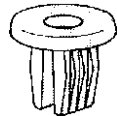
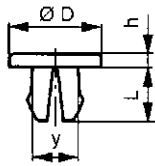

TYP 1

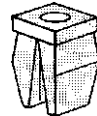
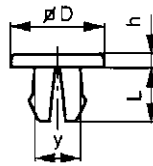

TYP 2



56210 Przelotki

W05B

Materiał Plastik Poliamid (nylon)
 Klasa PA 6.6
 Kolor Naturalny

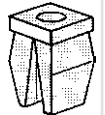

Nr	☒	Kod artykułu	Nr	☒	Kod artykułu	Nr	☒	Kod artykułu
0012	100	56210.012.001	0916	100	56210.091.601	1378	100	56210.137.801
0013	100	56210.013.001						

Ślizgacze, plastikowe

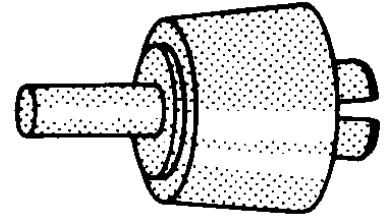
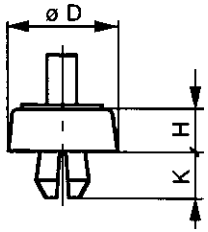

Informacje techniczne

Nr	0897	1024	1162	1806	2243
D ø	17	16	12	16	21
Grubość materiału	1-2.5	1.5-3	0.8-2	0.9-1.5	0.8-4
H	10.5+0.5	6.5+0.5	3.6	12	15
K	4	7	5.5	8	7
Otwór ø. drewno	7+0.2	7+0.2	6+0.2	8+0.1	8+0.2
Otwór ø. stal	7+0.1	7+0.2	6+0.2	7.7+0.1	7.7+0.1

- Materiał nr 0897: polistyren, poliamidy innych liczb PA 6.6

Dane montażowe

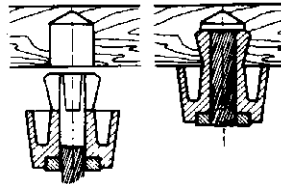

56843 Ślizgacze, plastikowe		W05B
Materiał	Plastik Poliamid (nylon)	
Klasa	PA 6.6	
Kolor	Czarny	

Nr	☒	Kod artykułu	Nr	☒	Kod artykułu	Nr	☒	Kod artykułu
0897 CZARNY	50	56843.089.701	1162 CZARNY	50	56843.116.201	2243 CZARNY	50	56843.224.301
1024 CZARNY	50	56843.102.401	1806 CZARNY	50	56843.180.601			

Odbojniki samoprzylepne

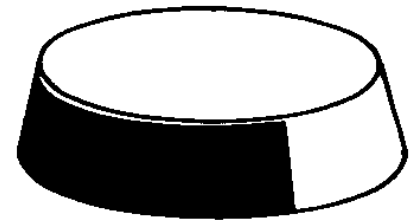
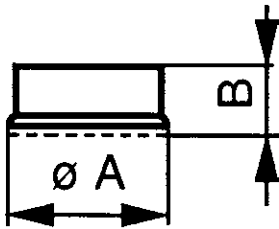

Informacje techniczne

Nr	A \varnothing /□	B	Typ nr.
7220	12.7 \varnothing	3.5	1
7224	12.7 \varnothing	1.5	1
7229	22.3 \varnothing	10.2	3
7231	20.6 \varnothing	7.6	2
7239	12.7 \varnothing	3.0	2

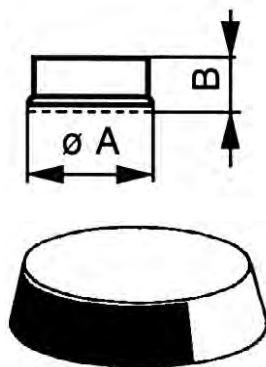

TYP 1

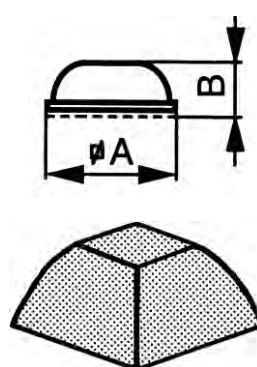

TYP 2

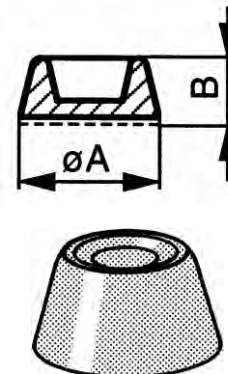

TYP 3

56890	Odbojniki samoprzylepne	W05B
Materiał	Plastik Poliuretan	
Kolor	Czarny	



Nr	☒	Kod artykułu	Nr	☒	Kod artykułu	Nr	☒	Kod artykułu
7220 CZARNY	100	56890.722.001	7229 CZARNY	100	56890.722.901	7239 CZARNY	100	56890.723.901
7224 CZARNY	100	56890.722.401	7231 CZARNY	100	56890.723.101			

Odbojniki ochronne

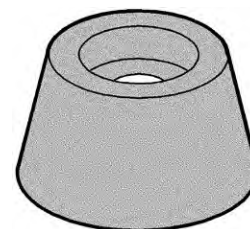
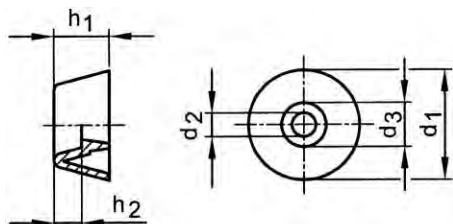

Informacje techniczne

d ₁	d ₂	d ₃	h ₁	h ₂
15	3.2	6	7.5	4
20	4.3	8	10	5
25	4.3	10	12.5	6.5
30	5.3	12	15	7.5

- Cechy szczególne odbojników ochronnych:
- Miękkie, ale bardzo mocne elastyczne odbojniki.
- Do montowania w wyrobach ze stali, przesuwnych fasadach itp.
- Niska wysokość wznoszenia i eleganckie wykończenie.
- Prosta instalacja przy pomocy jednego połączenia wkrętem lub nitem wbijającym.

56799 Odbojniki ochronne

W05E

Materiał Plastik Poliwinylchlorok
Kolor Czarny



d ₁	☒	Kod artykułu	d ₁	☒	Kod artykułu	d ₁	☒	Kod artykułu
15MM	25	56799.150.001	25MM	25	56799.250.001	30MM	25	56799.300.001
20MM	25	56799.200.001						

Rozety zamknięte plastikowe

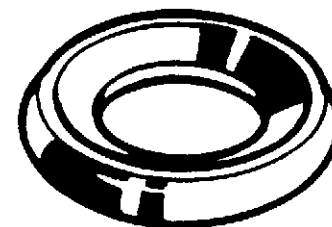
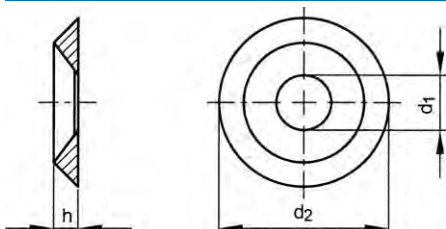

Informacje techniczne

Dla wymiaru nominalnego	d ₁	d ₂	h	Dla wymiaru nominalnego	d ₁	d ₂	h
M3	3.2	10.2	2.8	M5	5.3	14	3.8
M4	4.3	12	3.2	M6	6.4	16	4.5

Grupy katalogowe

Materiał	Klasa	Kolor	Kod	Strona
Plastik PA	PA 6.6	Biały	56680	12-143
Plastik PA	PA 6.6	Czarny	56690	12-144

56680 Rozety zamknięte plastikowe

W02A

Materiał Plastik Poliamid (nylon)
Klasa PA 6.6
Kolor Biały



Dla wymiaru nominalnego	☒	Kod artykułu	Dla wymiaru nominalnego	☒	Kod artykułu	Dla wymiaru nominalnego	☒	Kod artykułu
M3	100	56680.030.001	M5	50	56680.050.001	M6	25	56680.060.001
M4	50	56680.040.001						

56690	Rozety zamknięte plastikowe	W02A
Materiał	Plastik Poliamid (nylon)	
Klasa	PA 6.6	
Kolor	Czarny	

Dla wymiaru nominalnego	☒	Kod artykułu	Dla wymiaru nominalnego	☒	Kod artykułu	Dla wymiaru nominalnego	☒	Kod artykułu
M3	100	56690.030.001	M5	50	56690.050.001	M6	25	56690.060.001
M4	50	56690.040.001						

Podkładki zabezpieczające plastikowe

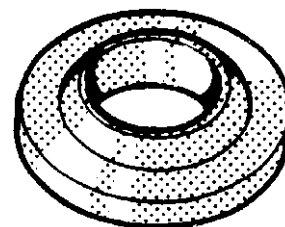
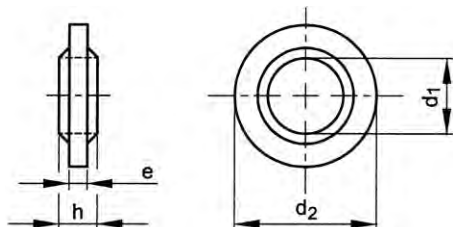

Informacje techniczne

Dla wymiaru nominalnego	d ₁	d ₂	e	h	Dla wymiaru nominalnego	d ₁	d ₂	e	h
M3	3.1	7	0.6	12	M12	12.1	22	2.2	5
M4	4.2	9	1.2	2.8	M14	14.2	25.4	2.4	5.5
M5	5.2	10.6	1.4	3	M16	16.2	29.4	2.5	6.2
M6	6.1	12	1.6	3.8	M18	18.2	32	2.5	6.8
M8	8.1	16.2	1.8	4	M20	20.3	35.7	2.7	7
M10	10.2	19.6	2.1	5					

56770	Podkładki zabezpieczające plastikowe	W02A
Materiał	Plastik Poliamid (nylon)	
Klasa	PA 6.6	
Kolor	Biały	

Dla wymiaru nominalnego	☒	Kod artykułu	Dla wymiaru nominalnego	☒	Kod artykułu	Dla wymiaru nominalnego	☒	Kod artykułu
M3	100	56770.030.001	M8	50	56770.080.001	M16	25	56770.160.001
M4	100	56770.040.001	M10	50	56770.100.001	M20	10	56770.200.001
M5	100	56770.050.001	M12	50	56770.120.001			
M6	100	56770.060.001	M14	25	56770.140.001			

Podkładki kołnierzowe

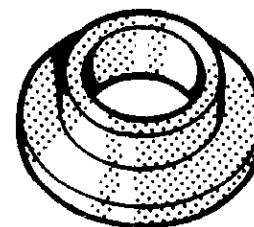
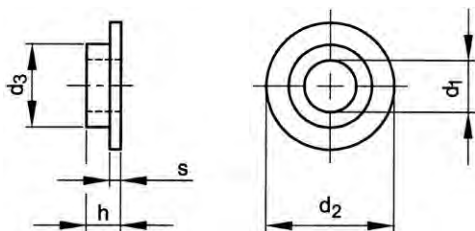

Informacje techniczne

Dla wymiaru nominalnego	d_1	d_2	d_3	h	s
M3	3.1	8.1	6.1	2	1.2
M4	4.3	12	6.5	2.6	1.5
M5	5	12	9	4.9	2
M6	6.5	15.8	9.6	4.4	1.6

56710 Podkładki kołnierzowe

W02A

Materiał Plastik Poliamid (nylon)
Klasa PA 6.6
Kolor Biały

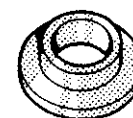

Dla wymiaru nominalnego	☒	Kod artykułu	Dla wymiaru nominalnego	☒	Kod artykułu	Dla wymiaru nominalnego	☒	Kod artykułu
M3	100	56710.030.001	M5	100	56710.050.001	M6	50	56710.060.001
M4	100	56710.040.001						

Tulejki izolacyjne

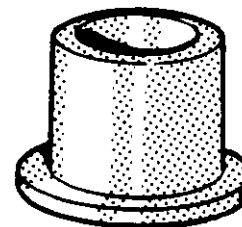
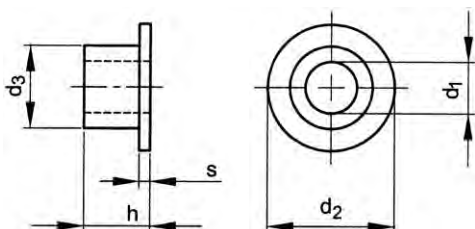

Informacje techniczne

Dla wymiaru nominalnego	d_1	d_2	d_3	h	s
M5	5	10.5	8.5	4.8	1.5
M6	6.1	12.2	8	6	2
M8	8.1	20	14.2	11.9	2.6
M10	10.1	19.8	14.9	11.8	2.6
M12	12.1	23.9	17.7	15.6	2.6
M14	14.1	25.9	19.8	17.8	2.7
M16	16.1	27.7	21.7	19.7	3.1
M20	20.1	31.9	26.7	23.9	3.1

Przykład izolacji przeciwko korozji stykowej połączenia śrubowego

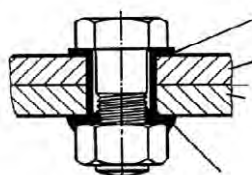

Tulejka izolacyjna
 Mosiądz
 Cienka warstwa nylonowa
 Stal
 Pierścień uszczelniający DUBO

56760	Tulejki izolacyjne	W02A
Materiał	Plastik Poliamid (nylon)	
Klasa	PA 6.6	
Kolor	Biały	

Dla wymiaru nominalnego	☒	Kod artykułu	Dla wymiaru nominalnego	☒	Kod artykułu	Dla wymiaru nominalnego	☒	Kod artykułu
M5	100	56760.050.001	M10	50	56760.100.001	M16	10	56760.160.001
M6	100	56760.060.001	M12	50	56760.120.001	M20	10	56760.200.001
M8	50	56760.080.001	M14	25	56760.140.001			

Łożyska ślizgowe plastikowe

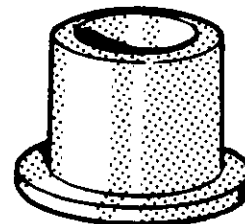
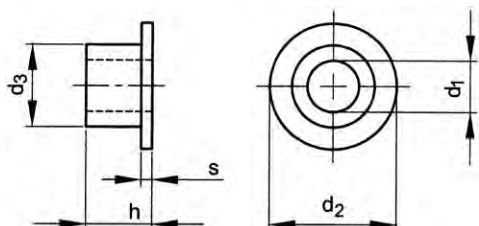

Informacje techniczne

d ₁	d ₂	d ₃	h	s	d ₁	d ₂	d ₃	h	s
3	8	5	7	2	18	30	22	25	2.5
4	9	6	8	2	20	30	24	26	2
5	11	8	10	2	25	37	30	30	2.5
6	12	9	11	2	28	40	33	33	2.5
8	16	11	13	2	30	42	35	35	2.5
10	18	13	15	2	32	45	38	38	3
12	21	16	19	2	40	55	46	46	3
14	28	18	21	3	50	67	56	50	3.5
16	28	20	22	2.5	60	81	68	50	4

- Cechy szczególne łożysk ślizgowych:
- Wyprodukowane z samosmarującego się nylonu 6.6 i zaprojektowane z kołnierzem ochronnym
- Niewrażliwe na brud, wpływ pogody i większość środków chemicznych
- Bardzo odpowiednie do bezgłośnych zawiasów i urządzeń o niskiej prędkości obrotowej
- Zapewnia izolację elektryczną między osią a obudową łożyska
- Odpowiednie do pasowania h6-H7
- Po montażu prześwit łożyska powinien wynosić około 1% średnicy wału

56806	Łożyska ślizgowe plastikowe	W03E
Materiał	Plastik Poliamid (nylon)	
Klasa	PA 6.6	
Kolor	Naturalny	

d ₁	☒	Kod artykułu	d ₁	☒	Kod artykułu	d ₁	☒	Kod artykułu
3MM	100	56806.030.001	12MM	100	56806.120.001	28MM	10	56806.280.001
4MM	100	56806.040.001	14MM	100	56806.140.001	30MM	10	56806.300.001
5MM	100	56806.050.001	16MM	100	56806.160.001	32MM	10	56806.320.001
6MM	100	56806.060.001	18MM	50	56806.180.001	40MM	5	56806.400.001
8MM	100	56806.080.001	20MM	50	56806.200.001	50MM	5	56806.500.001
10MM	100	56806.100.001	25MM	25	56806.250.001	60MM	3	56806.600.001

Tulejki izolacyjne

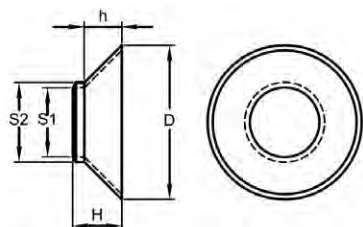

Informacje techniczne

Dla wymiaru nominalnego	D	h	H	s ₁	s ₂
M3	8.2	1.7	3.7	3.1	4.9
M4	10.4	2.3	4.3	4.1	5.9
M5	12.4	2.8	4.8	5.1	6.9
M6	14.4	3.3	5.3	6.1	7.9
M8	18.6	4.4	6.4	8.1	9.9
M10	22.5	5.0	10.3	10.2	12.4
M12	26.8	6.5	8.5	12.1	13.9

56767 Tulejki izolacyjne

W05E

Materiał Plastik Poliamid (nylon)
Klasa PA 6.6
Kolor Naturalny



Dla wymiaru nominalnego	☒	Kod artykułu	Dla wymiaru nominalnego	☒	Kod artykułu	Dla wymiaru nominalnego	☒	Kod artykułu
M3	100	56767.030.002	M6	100	56767.060.002	M12	100	56767.120.002
M4	100	56767.040.002	M8	100	56767.080.002			
M5	100	56767.050.002	M10	100	56767.100.002			

Elementy dystansowe, plastikowe

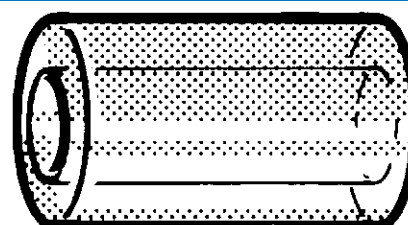
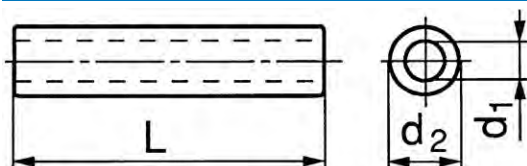

Informacje techniczne

Dla wymiaru nominalnego	d ₁	Dla wymiaru nominalnego	d ₁
2.5	2.6	6	6.2
3	3.1	8	8.2
3.5	3.6	10	10.3
4	4.2	12	12.8
5	5.2		

56800 Elementy dystansowe, plastikowe

W02A

Materiał Plastik Poliamid (nylon)
Klasa PA 6.6
Kolor Biały



Dla wymiaru nominalnego x d ₂ x L	☒	Kod artykułu	Dla wymiaru nominalnego x d ₂ x L	☒	Kod artykułu	Dla wymiaru nominalnego x d ₂ x L	☒	Kod artykułu
2,5X4X2MM	500	56800.024.002	2,5X5X20MM	500	56800.025.020	3X5X10MM	500	56800.029.010
2,5X5X2MM	500	56800.025.002	2,5X5X25MM	500	56800.025.025	3X5X15MM	500	56800.029.015
2,5X5X3MM	500	56800.025.003	2,5X5X30MM	500	56800.025.030	3X5X20MM	500	56800.029.020
2,5X5X5MM	500	56800.025.005	3X5X2MM	500	56800.029.002	3X5X25MM	500	56800.029.025
2,5X5X7,5MM	500	56800.025.007	3X5X3MM	500	56800.029.003	3X5X30MM	500	56800.029.030
2,5X5X10MM	500	56800.025.010	3X5X5MM	500	56800.029.005	3X8X2,5MM	500	56800.030.002
2,5X5X15MM	500	56800.025.015	3X5X7,5MM	500	56800.029.007	3X8X3MM	500	56800.030.003

56800		Elementy dystansowe, plastikowe						
Dla wymiaru nominalnego x d ₂ x L	☒	Kod artykułu	Dla wymiaru nominalnego x d ₂ x L	☒	Kod artykułu	Dla wymiaru nominalnego x d ₂ x L	☒	Kod artykułu
3X8X5MM	500	56800.030.005	5X10X3MM	200	56800.050.003	8X12X25MM	200	56800.080.025
3X8X7,5MM	500	56800.030.007	5X10X5MM	200	56800.050.005	8X12X30MM	200	56800.080.030
3X8X10MM	500	56800.030.010	5X10X7,5MM	200	56800.050.007	8X15X15MM	200	56800.081.515
3X8X15MM	500	56800.030.015	5X10X10MM	200	56800.050.010	8,2X18X5MM	100	56800.082.005
3X8X20MM	500	56800.030.020	5X10X15MM	200	56800.050.015	10X15X3MM	200	56800.100.003
3X8X25MM	500	56800.030.025	5X10X20MM	200	56800.050.020	10X15X5MM	200	56800.100.005
3X8X30MM	500	56800.030.030	5X10X25MM	200	56800.050.025	10X15X7,5MM	200	56800.100.007
3,5X6X3MM	200	56800.035.003	5X10X30MM	200	56800.050.030	10X15X10MM	200	56800.100.010
3,5X6X5MM	200	56800.035.005	6X10X2,5MM	200	56800.060.002	10X15X15MM	200	56800.100.015
3,5X6X7,5MM	200	56800.035.007	6X10X3MM	200	56800.060.003	10X15X20MM	200	56800.100.020
3,5X6X10MM	200	56800.035.010	6X10X5MM	200	56800.060.005	10X15X25MM	200	56800.100.025
3,5X6X15MM	200	56800.035.015	6X10X7,5MM	200	56800.060.007	10X15X30MM	200	56800.100.030
3,5X6X20MM	200	56800.035.020	6X10X10MM	200	56800.060.010	10X22X20MM	200	56800.102.020
3,5X6X25MM	200	56800.035.025	6X10X15MM	200	56800.060.015	12X18X3MM	200	56800.120.003
3,5X6X30MM	200	56800.035.030	6X10X20MM	200	56800.060.020	12X18X5MM	200	56800.120.005
4X8X2,5MM	200	56800.040.002	6X10X25MM	200	56800.060.025	12X18X7,5MM	200	56800.120.007
4X8X3MM	200	56800.040.003	6X10X30MM	200	56800.060.030	12X18X10MM	200	56800.120.010
4X8X5MM	200	56800.040.005	8X12X3MM	200	56800.080.003	12X18X15MM	200	56800.120.015
4X8X7,5MM	200	56800.040.007	8X12X5MM	200	56800.080.005	12X18X20MM	200	56800.120.020
4X8X10MM	200	56800.040.010	8X12X7,5MM	200	56800.080.007	12X18X25MM	200	56800.120.025
4X8X15MM	200	56800.040.015	8X12X10MM	200	56800.080.010	12X18X30MM	200	56800.120.030
4X8X20MM	200	56800.040.020	8X12X15MM	200	56800.080.015			
4X8X25MM	200	56800.040.025	8X12X20MM	200	56800.080.020			
4X8X30MM	200	56800.040.030						

Rurki izolacyjne

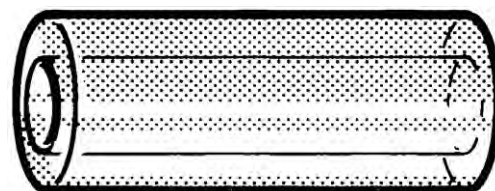
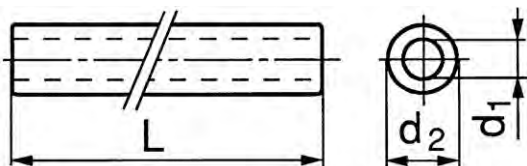

56772		Rurki izolacyjne 2 m				W03G		
Materiał	Plastik Poliamid (nylon)	Klasa	PA 6.6					
Dla wymiaru nominalnego	☒	Kod artykułu	Dla wymiaru nominalnego	☒	Kod artykułu	Dla wymiaru nominalnego	☒	Kod artykułu
4X5MM	100	56772.040.005	8X5MM	100	56772.080.005	12X5MM	100	56772.120.005
5X5MM	100	56772.050.005	8X6MM	100	56772.080.006	12X10MM	100	56772.120.010
5X10MM	100	56772.050.010	8X10MM	50	56772.080.010	16X5MM	100	56772.160.005
6X5MM	100	56772.060.005	10X5MM	100	56772.100.005	16X25MM	25	56772.160.025
			10X8MM	100	56772.100.008	20X5MM	100	56772.200.005

Korki plastikowe

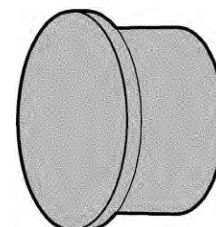
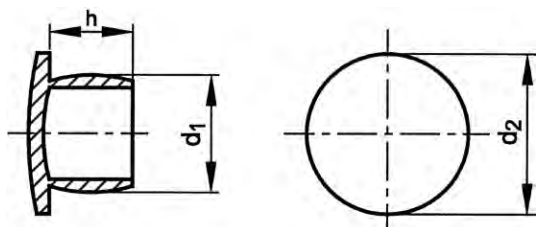

Informacje techniczne

d ₁	d ₂	h	d ₁	d ₂	h
2.1	3.5	7	19.6	26	9
2.6	12	4	20.0	25.5	9
2.7	12	6	21.0	26	13
3.3	12	6	22.3	29	9
4.4	9	5.5	23.0	27.3	19.3
4.7	7	5	24.0	27	12.5
5.2	11	6	24.5	32	13
5.4	12	7.5	25.0	31.5	6
6.0	11	7	26.0	31.5	12
6.6	7.5	5	27.2	29.6	15
7.2	11	6.5	28.6	34.5	15
7.3	11	6	31.2	38	13
8.0	12	7	33.5	41	11.5
8.5	12	8	34.0	40	20
8.8	11.5	8	35.5	47	15
9.3	12.5	9	36.5	47	18
10.0	15	9	39.5	46	15
10.1	12	4	42.0	44.5	13
10.7	14.5	9	43.3	50	15
11.9	14.2	8	45.5	51	16
12.8	17.5	9	45.8	51	16
13.2	17.5	8	50.5	57	14
13.6	19	8.5	52.0	60	16
14.6	18.5	9.5	55.5	60	16
15.4	19	8.5	58.0	63	18
15.7	19	8.5	61.5	74	20
16.8	20	9	70.0	80	18
17.2	23	10	85.0	95	18
18.8	21.5	9	110.0	130	18

- Dokładny korek cylindryczny zapewniający wysoką szczelność.
- Do czasowego uszczelniania otworów po wierceniu lub otworów na gwint, ale również do dłuższej ochrony.
- Doskonała zdolność zacisku, w związku z czym jest bardzo niezawodny w prawie każdej trudnej sytuacji.

56780 Korki plastikowe

W05E

Materiał Plastik Polietylen
Kolor Naturalny

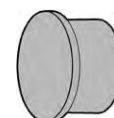

d ₁	☒	Kod artykułu	d ₁	☒	Kod artykułu	d ₁	☒	Kod artykułu
2,1MM	100	56780.021.001	10,1MM	100	56780.101.001	24,5MM	50	56780.245.001
2,6MM	100	56780.026.001	10,7MM	100	56780.107.001	25,0MM	50	56780.250.001
2,7MM	100	56780.027.001	11,9MM	100	56780.119.001	26,0MM	50	56780.260.001
3,3MM	100	56780.033.001	12,8MM	100	56780.128.001	27,2MM	50	56780.272.001
4,4MM	100	56780.044.001	13,2MM	100	56780.132.001	28,6MM	50	56780.286.001
4,7MM	100	56780.047.001	13,6MM	100	56780.136.001	31,2MM	50	56780.312.001
5,2MM	100	56780.052.001	14,6MM	100	56780.146.001	33,5MM	25	56780.335.001
5,4MM	100	56780.054.001	15,4MM	100	56780.154.001	34,0MM	25	56780.340.001
6,0MM	100	56780.060.001	15,7MM	100	56780.157.001	35,5MM	100	56780.355.001
6,6MM	100	56780.066.001	16,8MM	100	56780.168.001	36,5MM	25	56780.365.001
7,0MM	100	56780.070.001	17,2MM	100	56780.172.001	39,5MM	25	56780.395.001
7,2MM	100	56780.072.001	18,8MM	100	56780.188.001	42,0MM	25	56780.420.001
7,3MM	100	56780.073.001	19,6MM	100	56780.196.001	43,3MM	25	56780.433.001
8,0MM	100	56780.080.001	20,0MM	50	56780.200.001	45,5MM	25	56780.455.001
8,5MM	100	56780.085.001	21,0MM	50	56780.210.001	45,8MM	25	56780.458.001
8,8MM	100	56780.088.001	22,3MM	50	56780.223.001	50,5MM	25	56780.505.001
9,3MM	100	56780.093.001	23,0MM	100	56780.230.001	52,0MM	25	56780.520.001
10,0MM	100	56780.100.001	24,0MM	50	56780.240.001	55,5MM	25	56780.555.001

56780		Korki plastikowe						
d_1	☒	Kod artykułu	d_1	☒	Kod artykułu	d_1	☒	Kod artykułu
58,0MM	25	56780.580.001	70,0MM	25	56780.700.001	110,0MM	25	56780.960.001
61,5MM	25	56780.615.001	85,0MM	25	56780.850.001			

Zaślepki i korki ochronne

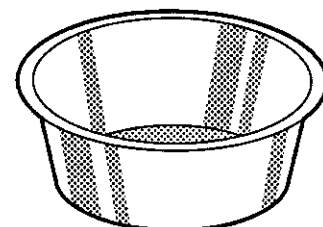
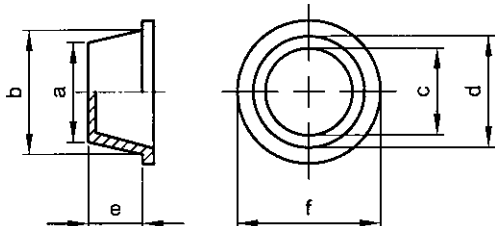

Informacje techniczne

Typ	a	b	c	d	e	f
M4CAP-M6PLUG	4.4	6.1	2.8	4.5	9.5	9.5
M6CAP-M8PLUG	6.2	7.7	5	5.9	9.5	11.1
M8CAP-M10PLUG	8.4	10	6.9	8.2	9.5	13.5
M10CAP-M12PLUG	10	11.3	8.5	10	9.5	15
M12CAP	12.1	13.9	10.6	12.3	11	17.5
M14CAP	14.2	16	12.7	14.4	12.1	19
M14PLUG	11.5	13	10	11.5	9.5	16.7
M16PLUG	13.6	15.4	12.1	13.7	11.2	19
M16CAP-M20PLUG	16.4	18.3	14.8	16.9	12.7	22.2
M18CAP	17.8	20	16.4	18.3	14.4	23.8
M18PLUG	14.7	17	13.2	15.4	12.7	20.6
M20CAP	21.3	23.2	19.2	21.5	15.9	27
M20PLUG	17.7	19.6	15.2	17.3	12.7	22.2
M22CAP	22	25	20.5	23	15.9	28.5
M22PLUG	18.5	20.9	17.1	19.3	14.3	24.6
M24PLUG	21.2	23.2	19.3	21.7	12.3	27.3
M24CAP-M27PLUG	23.4	26.4	21.4	24.4	17.5	29.3
M27CAP-M30PLUG	24.7	27.7	23.2	26.1	19	32
M30CAP-M33PLUG	30	32.6	27.5	30.9	15.5	36.7
M33CAP-M35PLUG	31.1	34.3	29.8	32.8	19	38.1
M35CAP-M36PLUG	33.3	37.2	32	35.6	22.6	41.5
M38CAP-M40PLUG	36.9	40.6	35	39	22.5	44
M39CAP-M45PLUG	39.4	42.7	38.2	41.1	19	47.6
M42CAP-M45PLUG	41.4	44.8	39.7	43	19	49.2
M45CAP-M48PLUG	44.5	47.3	42.9	46.2	19	50.8
M48PLUG	45.2	49.5	43.6	47.9	24.5	54
M48CAP-M52PLUG	48.6	51.2	46.7	48.9	18.7	55.5
M52CAP-M56PLUG	53.5	57	51.2	55.3	25.2	62.4
M56CAP-M60PLUG	54.5	61	52.2	59	25	65.1
M60CAP-M62PLUG	59.6	62.6	57	61	24.6	66.7
M75PLUG	70	75.8	68.1	74	25.4	79.4

- Stożkowy kształt pozwala na wykorzystanie jako zaślepka lub korek, zapewniając łatwy montaż i demontaż w większości zastosowań. Zapewniają one doskonałą ochronę przed uszkodzeniami, brudem, wilgocią i korozją podczas magazynowania i transportu.
- Przy stosowaniu jako korek wymiar b powinien o min. 5% przekraczać rozmiar otworu, średnice powyżej 30 mm mogą wymagać dodatkowych działań.
- Przy stosowaniu jako zaślepka wymiar c powinien być o min. 5% mniejszy niż średnica zaślepianego otworu, średnice ponad 30 mm mogą wymagać dodatkowych działań.

56783		Zaślepki i korki ochronne				W05B	
Materiał		Plastik Polietylen					
Kolor		Czerwony					



Typ	☒	Kod artykułu	Typ	☒	Kod artykułu	Typ	☒	Kod artykułu
M4ZAŚLEPKA-M6KOREK	500	56783.040.060	M12ZAŚLEPKA	250	56783.120.000	M18KOREK	250	56783.180.002
M6ZAŚLEPKA-M8KOREK	500	56783.060.080	M14ZAŚLEPKA	250	56783.140.000	M20ZAŚLEPKA	100	56783.200.000
M8ZAŚLEPKA-M10KOREK	500	56783.080.100	M14KOREK	250	56783.140.002	M20KOREK	100	56783.200.002
M10ZAŚLEPKA-M12KOREK	500	56783.100.120	M16KOREK	250	56783.160.002	M22KOREK	100	56783.220.002
			M16ZAŚLEPKA-M20KOREK	250	56783.160.200	M24KOREK	100	56783.240.002
			M18ZAŚLEPKA	250	56783.180.000	M24ZAŚLEPKA-M27KOREK	100	56783.240.270

56783 Zaślepki i korki ochronne								
Typ	☒	Kod artykułu	Typ	☒	Kod artykułu	Typ	☒	Kod artykułu
M27ZAŚLEP-KA-M30KOREK	100	56783.270.300	M38ZAŚLEP-KA-M40KOREK	50	56783.380.400	M48ZAŚLEP-KA-M52KOREK	25	56783.480.520
M30ZAŚLEP-KA-M33KOREK	100	56783.300.330	M39ZAŚLEP-KA-M45KOREK	50	56783.390.450	M52ZAŚLEP-KA-M56KOREK	25	56783.520.560
M33ZAŚLEP-KA-M35KOREK	50	56783.330.350	M42ZAŚLEP-KA-M45KOREK	50	56783.420.450	M58ZAŚLEP-KA-M60KOREK	25	56783.580.600
M35ZAŚLEP-KA-M36KOREK	50	56783.350.360	M45ZAŚLEP-KA-M48KOREK	25	56783.450.480	M60ZAŚLEP-KA-M62KOREK	25	56783.600.620
			M48KOREK	25	56783.480.002	M75KOREK	25	56783.750.002

Zacisk przegubowy, pionowy



Grupy katalogowe

Material	Obróbka powierzchni		Kod	Strona
St	Ocynk.	z poziomą podstawą	15900	12-152
St	Ocynk.	z nachyloną podstawą	15905	12-153

15900 Zacisk przegubowy, pionowy, typ 6800
F97A
Materiał Stal
Obróbka powierzchni Ocynkowane

Typ	A	B	C	D	E	F	F1 [kN]	F2 [kN]	H	H1	HW min.	HW maks.	I	K	L	L1	L2	M	M1	N	P	α	α^*	Śruba blokująca
0	4	31	11,0	4,5	14	5,5	0,5	0,7	18,0	81,0	-1,5	3,5	8	5,5	-	49	50	23	-	32	22	95°	-	M 4x 25
1	5	39	16,0	4,5	18	6,0	0,6	1,1	19,0	98,5	-4,0	2,0	10	5,5	-	61	59	24	-	35	27	95°	-	M 5x 30
2	6	52	20,0	5,5	25	11,0	0,8	1,2	23,0	130	-3,0	4,5	12	6,0	12,5	78	80	27	27	43	32	105°	60°	M 6x 35
3	8	79	20,0	7,5	36	19,0	1,2	2,5	33,0	186	2,0	11,0	18	7,5	-	112	112	32	-	46	35	105°	60°	M 8x 45
4	10	101	32,0	8,6	54	16,0	1,7	3,0	42,5	221	-6,0	22,5	20	13,0	-	141	130	45	-	64	53	105°	60°	M 8x 65
5	14	140	45,0	8,5	73	34,0	3,0	5,0	55,8	281	-3,0	27,5	25	9,5	29,0	195	185	49	45	70	65	115°	60°	M12x 80
6	14	165	50,5	13,0	89	26,0	3,4	5,5	81,0	332	-2,5	55,0	30	24,5	-	231	207	71	-	100	90	140°	60°	M12x110

* Kąt otwarcia może być zmieniony poprzez użycie przycisku blokującego.

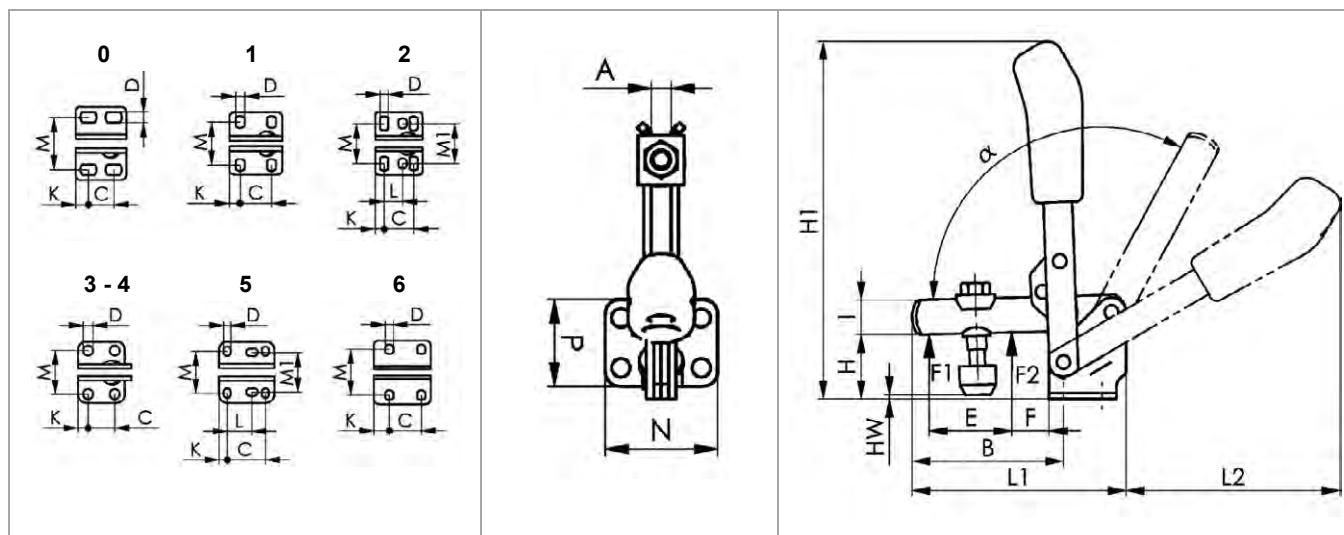

Typ	☒	Kod artykułu	Typ	☒	Kod artykułu	Typ	☒	Kod artykułu
NO.0	1	15900.000.100	NO.3	1	15900.000.103	NO.5	1	15900.000.105
NO.1	1	15900.000.101	NO.4	1	15900.000.104	NO.6	1	15900.000.106
NO.2	1	15900.000.102						

- Z otwartym ramieniem zaciskowym i podstawą poziomą.
- Dostarczane razem z hartowaną, cynkowaną śrubą zaciskową.

15905 Zacisk przegubowy, pionowy, typ 6803
F97A
Materiał Stal
Obróbka powierzchni Ocynkowane

Typ	A	B	C	D	E	F	F1 [kN]	F2 [kN]	H	H1	HW min.	HW maks.	I	K	L1	L2	M	N	O	P	α	α^*	Śruba blokująca
1	5	34	14	4,5	19	8	0,8	1,1	47	132	-1,5	5,5	10	10	60	58	20,0	30	5	30	105°	-	M5x30
2	6	40	20	5,5	25	9	1,0	1,2	61	180	2,0	11,0	12	6	78	63	25,5	38	5	32	105°	60°	M6x35
3	8	65	24	6,5	43	11	1,4	2,5	71	243	6,0	18,0	18	7	112	111	28,5	43	6	38	105°	60°	M8x45
4	10	84	32	8,5	50	17	2,0	3,0	102	280	11,0	40,0	20	54	140	129	32,0	52	8	96	105°	60°	M8x65

* Kąt otwarcia może być zmieniony poprzez użycie przycisku blokującego.

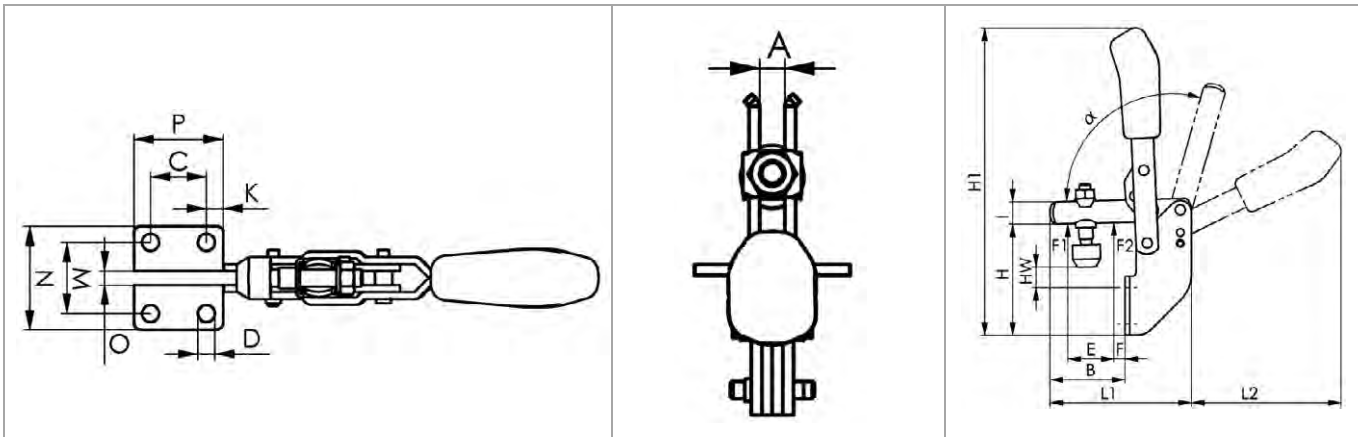

Typ	☒	Kod artykułu	Typ	☒	Kod artykułu	Typ	☒	Kod artykułu
NO.1	1	15905.000.101	NO.3	1	15905.000.103	NO.4	1	15905.000.104
NO.2	1	15905.000.102						

- Z otwartym ramieniem zaciskowym i podstawą nachyloną.
- Dostarczane razem z hartowaną, cynkowaną śrubą zaciskową.

Zaciski przegubowe, poziome



Grupy katalogowe

Material	Obróbka powierzchni		Kod	Strona
St	Ocynk.	z poziomą podstawą	15910	12-154
St	Ocynk.	z poziomą podstawą	15916	12-155
St	Ocynk.	z nachyloną podstawą	15915	12-156

15910 Zaciski przegubowe, poziome, typ 6830

F97A

Material Stal
Obróbka powierzchni Ocynkowane



Typ	A	B	C	D	D1	E	F	F1 [kN]	F2 [kN]	H	H1	H2	HW min.	HW maks.	I	K	L	L1	M	M1	N	P	α	Śruba blokująca
0	5	28	13,5	4,6	-	9,0	5	0,25	0,4	14,5	23,0	34	-5,0	1	7,5	6,3	-	79	16,0	-	25,0	25,5	90°	M4x25
1	5	42	14,0	5,2	-	18,5	8	0,8	1,1	19,0	30,0	49	-4,0	2	10,0	5,5	-	120	20,3	-	34,0	34,0	90°	M5x30
2	6	64	26,0	5,6	5,6	32,0	16	1,0	1,2	24,0	45,0	68	-1,5	5	13,0	6,0	12,7	162	24,5	28,5	42,0	38,0	90°	M6x35
3	8	73	25,7	6,5	5,1	36,0	15	1,8	2,5	32,0	48,5	86	-2,0	9,0	15,0	7,0	13	206	26,8	31,6	44,5	50,0	90°	M8x45
4	10	113	41,0	8,5	8,5	63,0	27	2,0	3,0	45,0	75,0	115	-4,0	24	20,0	8,0	20,5	281	36,0	43,0	58,0	57,0	90°	M8x65
5	10	123	41,5	8,5	-	78,0	16	3,0	5,0	46,0	73,0	128	-1,5	25	25,0	12,5	-	321	41,5	-	58,0	77,0	90°	M8x65

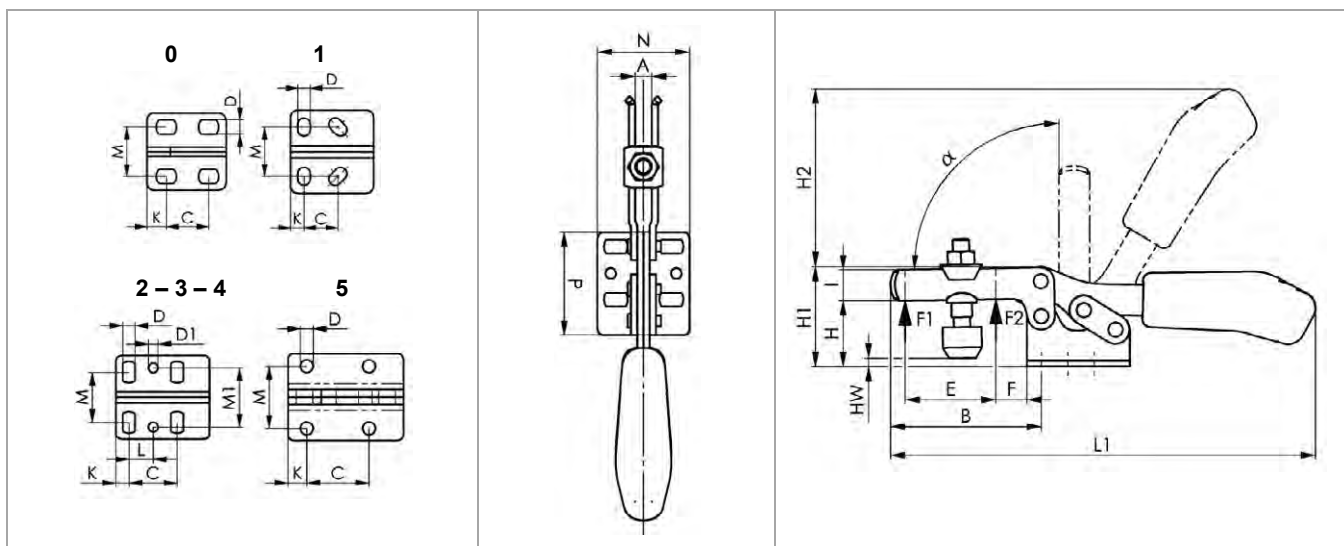

Typ	☒	Kod artykułu	Typ	☒	Kod artykułu	Typ	☒	Kod artykułu
NO.0	1	15910.000.100	NO.2	1	15910.000.102	NO.4	1	15910.000.104
NO.1	1	15910.000.101	NO.3	1	15910.000.103	NO.5	1	15910.000.105

- Z otwartym ramieniem zaciskowym i podstawą poziomą.
- Dostarczane razem z hartowaną, cynkowaną śrubą zaciskową.

15916 Zaciski przegubowe, poziome, typ 6833
F97A
Materiał Stal
Obróbka powierzchni Ocynkowane

Typ	A	B	C	D	D1	E	F	F1 [kN]	F2 [kN]	H	H1	H2	HW min.	HW maks.	I	K	L	L1	M	M1	N	P	α	Śruba blokująca
2	5	63	26,0	5,6	5,6	35	16,0	1,0	1,2	24	45,0	68	-4,0	4	13	6,0	12,7	161	24,5	28,5	42	38	90°	M 6x35
3	6	72	26,0	6,5	5,1	44	15,0	1,8	2,5	32	48,5	86	-3,5	9	15	7,0	13,0	205	27,0	32,0	45	50	90°	M 8x45
4	8	111	41,0	8,5	8,5	66	26,0	2,0	3,0	45	75,0	114	-6,0	22	20	8,0	20,5	280	36,0	43,0	58	57	90°	M 8x65
5	10	121	41,5	8,0	-	78	17,5	3,0	5,0	46	73,0	128	-13,0	12	25	12,5	-	320	41,5	-	58	77	90°	M12x80

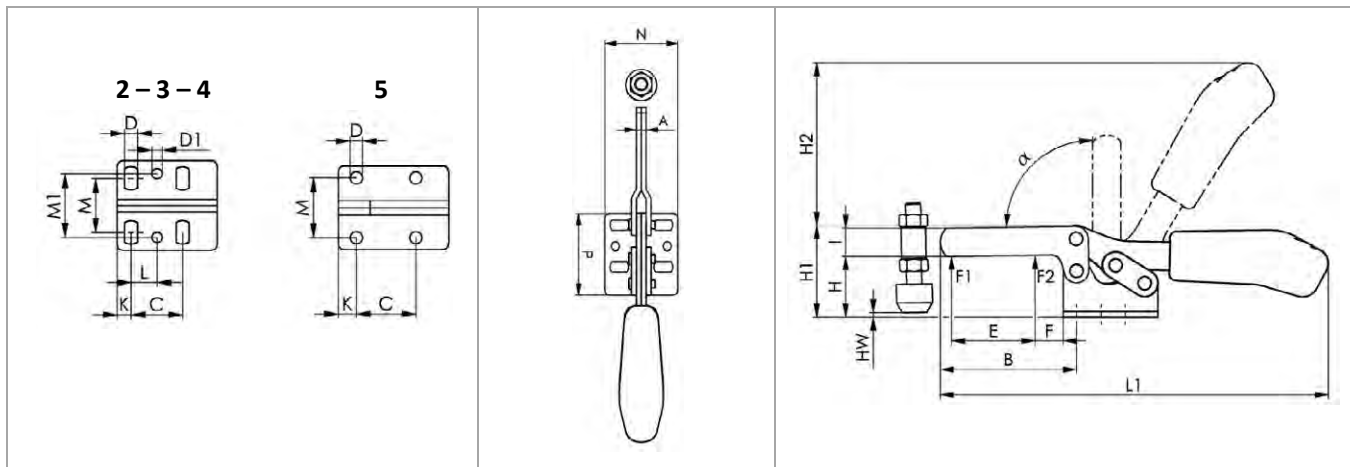

Typ	☒	Kod artykułu	Typ	☒	Kod artykułu	Typ	☒	Kod artykułu
NO.2	1	15916.000.102	NO.4	1	15916.000.104	NO.5	1	15916.000.105
NO.3	1	15916.000.103						

- Z solidnym ramieniem zaciskowym i podstawą.
- Dostarczane kompletne z hartowaną, ocynkowaną śrubą zaciskową nr 6885 oraz kołnierzem.

15915 Zaciski przegubowe, poziome, typ 6833
F97A
Materiał Stal
Obróbka powierzchni Ocynkowane

Typ	A	B	C	D	E	F	F1 [kN]	F2 [kN]	H	H1	H2	HW min.	HW maks.	I	K	L1	M	N	P	α	Śruba blokująca
1	5	32	13,5	5,2	18,5	4,0	0,8	1,1	57	68	49	14	20	10	8	120	19,0	31	28	90°	M5x30
2	6	52	20,0	5,6	32,0	10,5	1,0	1,2	73	94	68	22	29	13	6	162	25,5	37	32	90°	M6x35
3	8	59	24,0	6,8	37,0	8,0	1,8	2,5	70	86	86	5	16	15	7	206	29,0	43	38	90°	M8x45
4	10	93	32,0	8,5	63,0	15,0	2,0	3,0	102	133	115	11	40	20	40	282	32,0	52	82	90°	M8x65

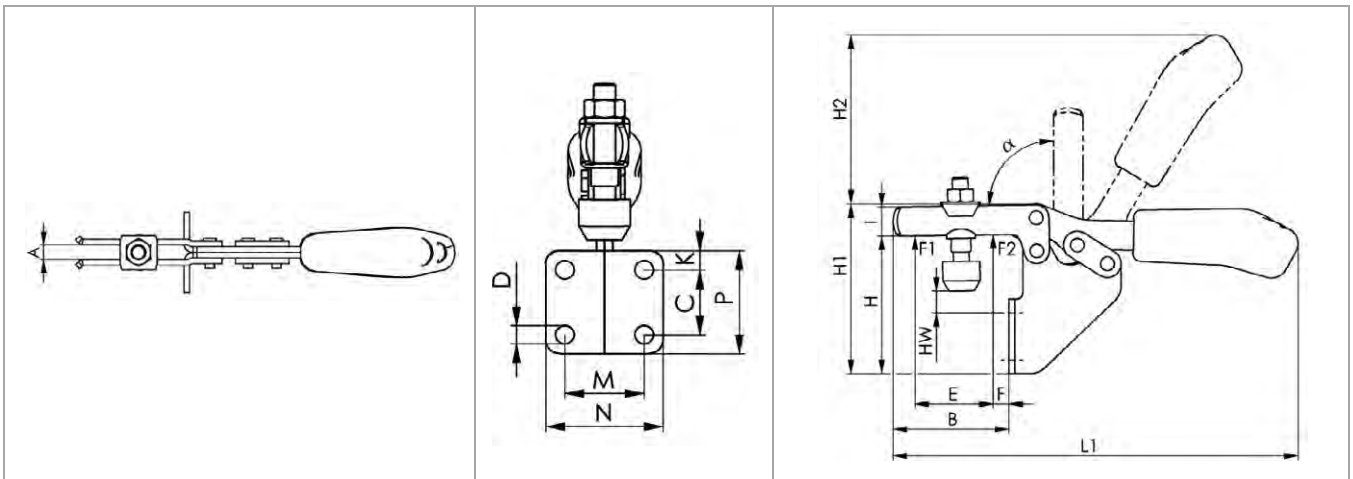

Typ	☒	Kod artykułu	Typ	☒	Kod artykułu	Typ	☒	Kod artykułu
NO.1	1	15915.000.101	NO.3	1	15915.000.103	NO.4	1	15915.000.104
NO.2	1	15915.000.102						

- Z otwartym ramieniem zaciskowym i podstawą nachyloną.
- Dostarczane razem z hartowaną, cynkowaną śrubą zaciskową.

Zaciski przegubowe przeciwsobne



Grupy katalogowe

Material	Obróbka powierzchni		Kod	Strona
St	Ocynk.	z lekko nachyloną podstawą	15920	12-157
St	Ocynk.	wersja krótka	15925	12-158
St	Ocynk.	do dużych obciążeń	15930	12-159

15920 Zaciski przegubowe przeciwsobne, typ 6841

F97A

Material Stal
Obróbka powierzchni Ocynkowane



Typ	A	B min.	B maks.	D	E	F1 [kN]	F2 [kN]	H	H1	HUB	HW min.	HW maks.	K	L1	L2	L3	M min.	M maks.	M2	N	P	Śruba blokująca
0	6,5	17,0	33,0	4,5	13	0,8	0,8	12	47	16	12	20	6,5	66,0	10	52	-	16,0	M10x1,0	25	16	M 4x20
1	8,0	24,5	44,5	4,5	20	1,0	1,0	15	60	20	12	20	7,0	91,0	16	72	16	19,5	M12x1,5	30	20	M 4x20
2	10,0	32,5	57,5	5,6	25	2,0	2,0	20	95	26	17	25	12,5	114,0	19	105	-	36,0	M16x1,5	50	34	M 6x25
3	12,0	37,0	69,0	6,5	30	2,5	2,5	25	110	32	22	35	13,0	140,0	22	129	30	42,0	M20x1,5	60	30	M 8x35
5-M27	16,0	41,5	81,5	8,5	50	4,5	4,5	30	126	40	30	50	15,0	171,5	25	142	30	45,0	M27x2,0	65	35	M12x50

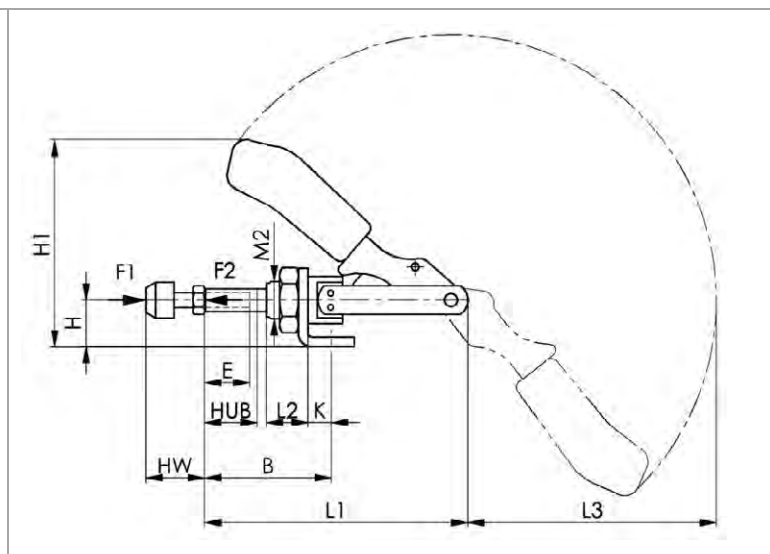
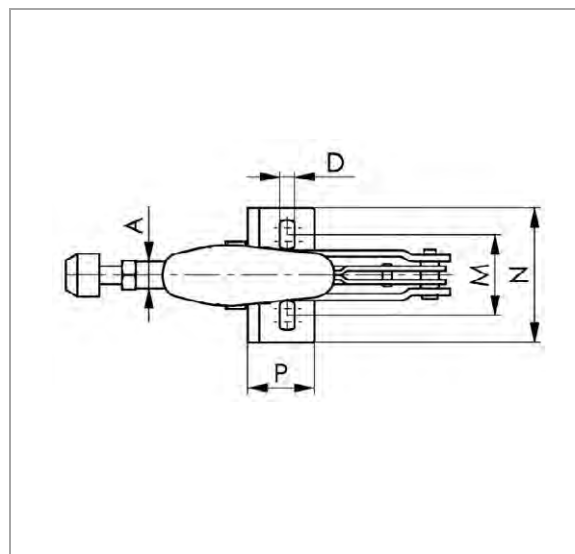

Typ	☒	Kod artykułu	Typ	☒	Kod artykułu	Typ	☒	Kod artykułu
NO.0	1	15920.000.100	NO.2	1	15920.000.102	NO.5	1	15920.000.105
NO.1	1	15920.000.101	NO.3	1	15920.000.103	NO.5-M27	1	15920.000.527

- Z lekko nachyloną podstawą.
- Do zaciskania przeciwsobnego.
- Dostarczane razem z hartowaną, cynkowaną śrubą zaciskową.

Materiał Stal
Obróbka powierzchni Ocynkowane



Typ	A	B	E	F1 [kN]	F2 [kN]	H	H1	HUB	HW min.	HW maks.	L1	L2	L3	M	M2	N	Śruba blokująca
2	10	35	15	1,0	1,0	24	76	21	18	27	70	13	82	M 6	M16x1,5	31	M 6x25
3	12	56	25	2,5	2,5	33	128	40	22	35	110	16	130	M 8	M20x1,5	33	M 8x35
5-M27	16	92	35	4,0	4,0	37	148	67	30	50	175	24	138	M12	M27x2,0	50	M12x50

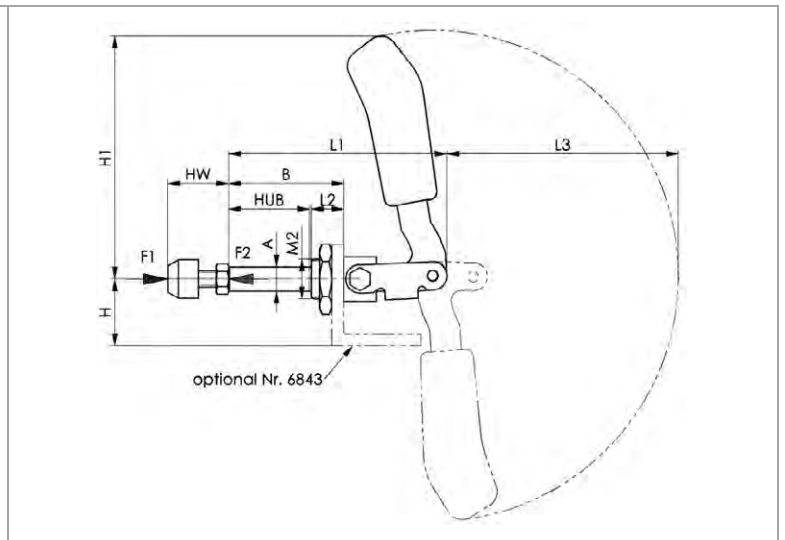
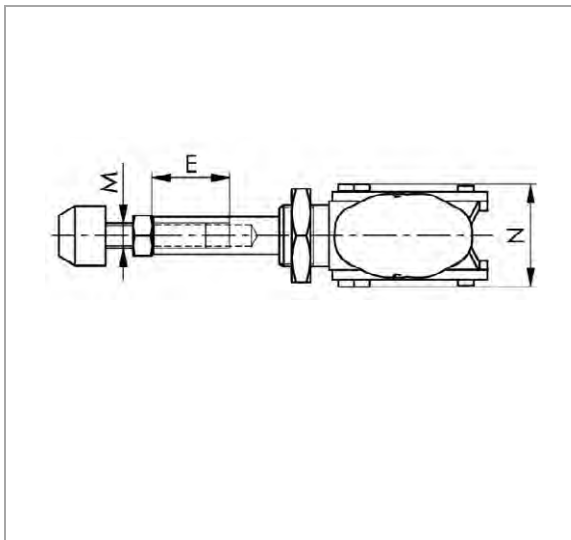

Typ	☒	Kod artykułu	Typ	☒	Kod artykułu	Typ	☒	Kod artykułu
NO.2	1	15925.000.102	NO.5	1	15925.000.105	NO.5-M27	1	15925.000.527
NO.3	1	15925.000.103						

- Wersja krótka.
- Do zaciskania przeciwsobnego.
- Dostarczane razem z hartowaną, cynkowaną śrubą zaciskową.

15930 Zaciski przegubowe przeciwsobne, typ 6842
F97A
Materiał Stal
Obróbka powierzchni Ocynkowane

Typ	A	B min.	B max.	C	D	E	F1 [kN]	F2 [kN]	H	H1	HUB	HW min.	HW maks.	K	L1	L2	M min.	M maks.	N	P	Śruba blokująca
3	12	40	72	41	6,5	30	4	4	30	115	32	35	48	28	140	130	36	44	60	96	M 8x35
5	16	58	98	41	8,5	50	10	10	38	134	40	30	50	46	172	140	41	50	70	122	M12x50
7	22	59	105	70	11,0	50	25	25	55	180	50	30	50	45	218	192	57	65	93	158	M12x50

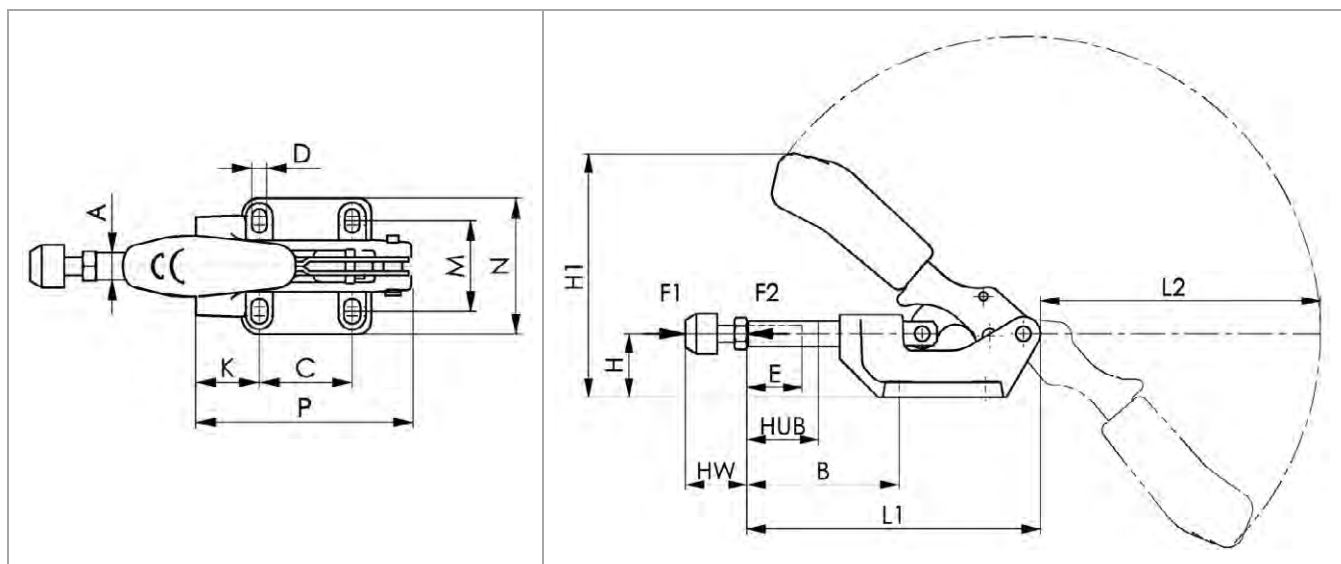

Typ	☒	Kod artykułu	Typ	☒	Kod artykułu	Typ	☒	Kod artykułu
NO.3	1	15930.000.103	NO.5	1	15930.000.105	NO.7	1	15930.000.107

- Do zaciskania przez wciskanie i przez wyciąganie.
- Typ ciężki z prętem prowadzącym.
- Dostarczane razem z hartowaną, cynkowaną śrubą zaciskową.

Zaciski przegubowe hakowe



15935 Zaciski przegubowe hakowe, typ 6847

F97A

Materiał Stal
Obróbka powierzchni Ocynkowane



Typ	B1	B2	C	D	E1	E2	F1 [kN]	G	H	H1	K	L	L1	M	N	R	S	Odległość regulacji [mm]
1	15-23	34-42	19	5,3	15-23	34,0-42,0	2	4,5	22,5	33	6	31	130	28	41	4,5	45	8
3	32-44	67-79	19	7,1	40-52	74,5-86,5	3	5,5	23,0	36	13	40	230	32-35	46	5,5	98	12
5	26-40	57-71	29	12,0	28-42	58,5-72,5	5	11,0	49,0	70	13	55	308	60	88	8,0	144	14

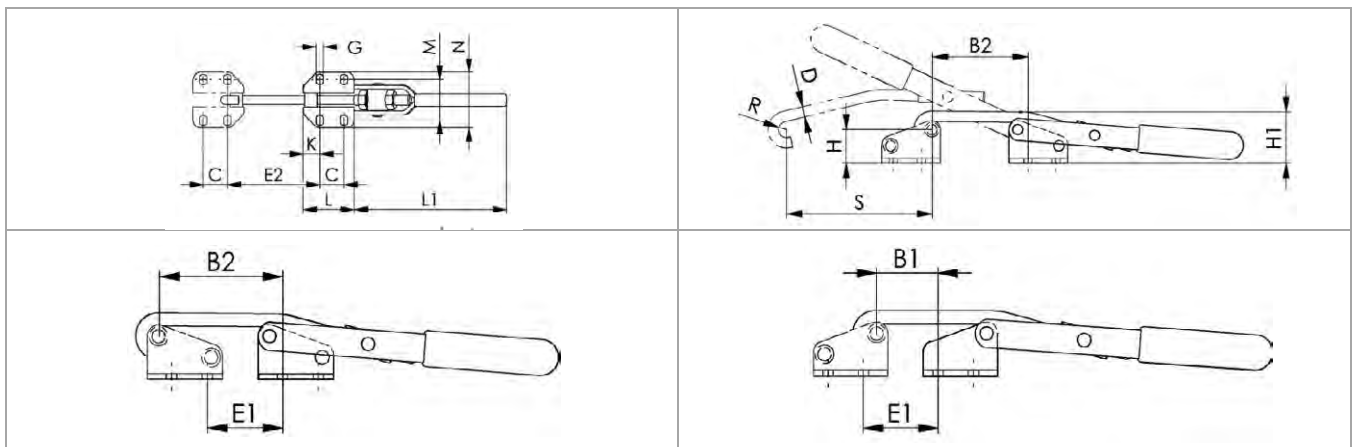

Typ	☒	Kod artykułu	Typ	☒	Kod artykułu	Typ	☒	Kod artykułu
NO.1	1	15935.000.101	NO.3	1	15935.000.103	NO.5	1	15935.000.105

- Przeciwwzaczepty: patrz grupa artykułów 15940.

Zaciski przegubowe hakowe poziome



15945 Zaciski przegubowe hakowe poziome, typ 6848H

F97A

Materiał Stal
Obróbka powierzchni Ocynkowane



Typ	B min.	B max.	C	D	D1	E min.	E maks.	F	F1 [kN]	G	H	H1	K	L1	L5	M	N	P	S
2	42	74	13	5,2	4	38	70	11	1,6	19	12	47	6,5	156	70	24	38	26	23
3	53	95	19	6,5	6	48	90	14	3,2	25	19	70	8,0	210	95	32	48	35	30
4	72	127	32	8,5	8	65	120	19	7,0	36	25	92	9,5	270	113	45	65	51	44

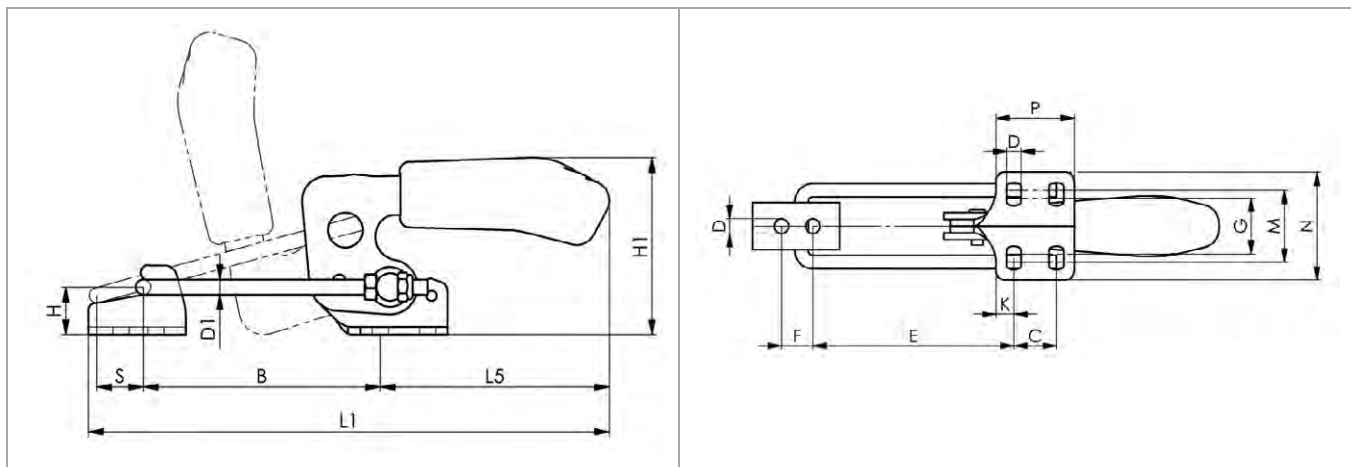

Typ	☒	Kod artykułu	Typ	☒	Kod artykułu	Typ	☒	Kod artykułu
NO.2	1	15945.000.102	NO.3	1	15945.000.103	NO.4	1	15945.000.104

- Dostarczane w całości, z przeciwwzajemcami.

Zaciski przegubowe hakowe pionowe



15950 Zaciski przegubowe hakowe pionowe, typ 6848V

F97A

Materiał Stal
Obróbka powierzchni Ocynkowane



Typ	B min.	B maks.	C	D	D1	E min.	E maks.	F1 [kN]	F	G	H	H1	K	L1	M	N	P	S
2	24	47	13	5,2	4	5	28	1,6	11	19	4,5	47	7,0	90	24	38	26	23
3	33	61	19	6,5	6	7	35	3,2	14	25	6,0	70	8,0	127	32	48	35	30
4	43	79	32	8,5	8	9	45	7,0	19	36	8,0	92	9,5	150	45	65	51	40

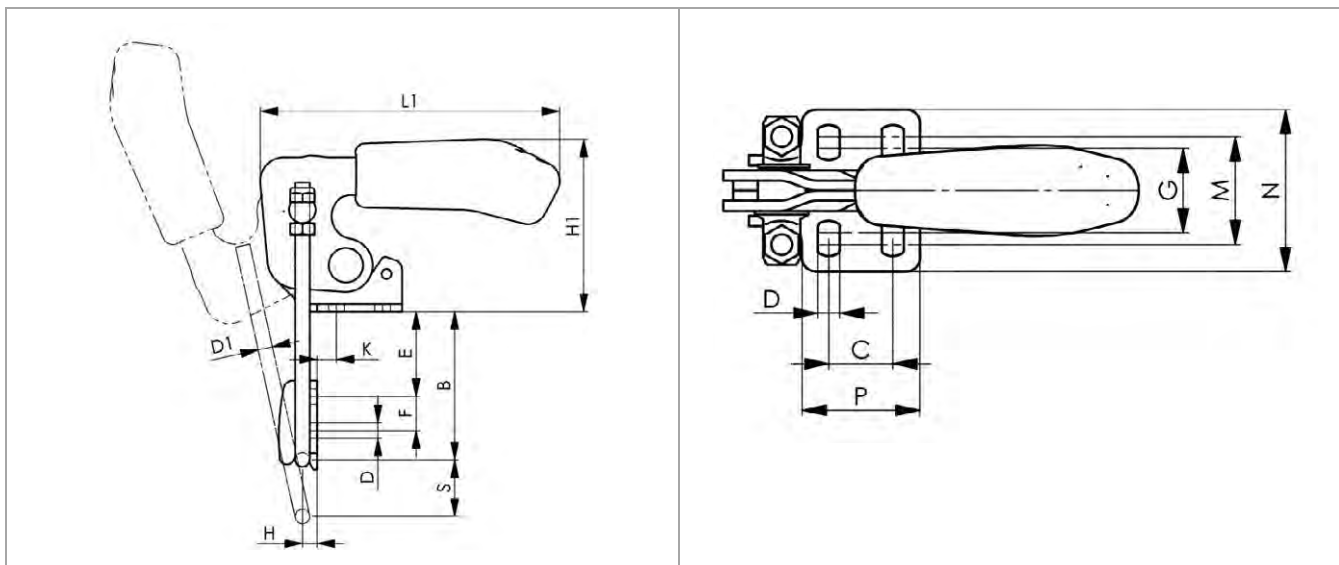

Typ	☒	Kod artykułu	Typ	☒	Kod artykułu	Typ	☒	Kod artykułu
NO.2	1	15950.000.102	NO.3	1	15950.000.103	NO.4	1	15950.000.104

- Dostarczane w całości, z przeciwczerwieniami.

Przeciwnaczepy do zacisków przegubowych hakowych



15940 Przeciwnaczepy do zacisków przegubowych hakowych 6847

F97A

Materiał Stal
Obróbka powierzchni Ocynkowane



Typ	B	C	D	G	H	K	L	M	N	O
1	6	19	8	4,5	22,5	6	31	28	41	6,8
3	6	19	10	5,5	23,0	13	40	32-35	46	10,8
5	12	29	15	11,0	49,0	13	55	60	88	13,7

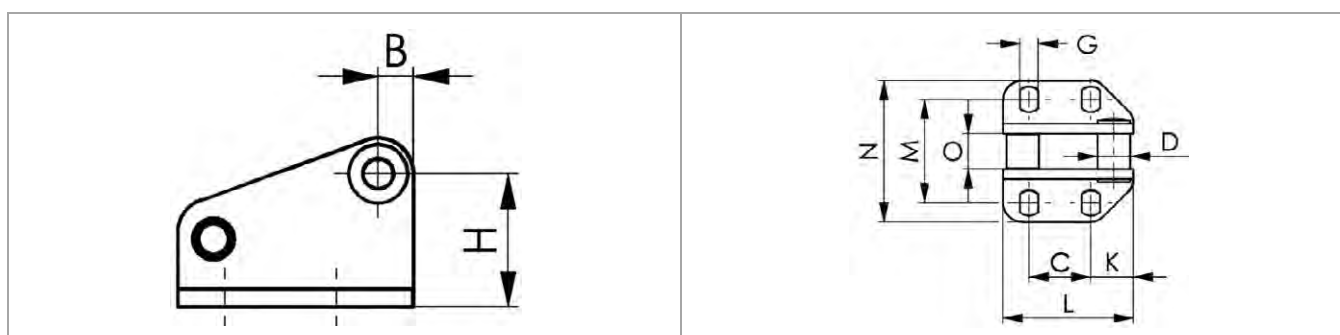

Typ	☒	Kod artykułu	Typ	☒	Kod artykułu	Typ	☒	Kod artykułu
NO.1	1	15940.000.101	NO.3	1	15940.000.103	NO.5	1	15940.000.105

- Odpowiednie do zacisków przegubowych hakowych, patrz grupa artykułów 15935.

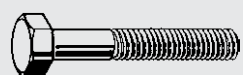

1 Śruby



2 Produkty z gniazdem sześciokątnym



3 Nakrętki, nitonakrętki & wkładki



4 Pręty gwintowane & śruby dwustronne



5 Haki & śruby oczkowe



6 Wkręty

I Index



7 Podkładki & pierścienie uszczelniające typu “O-ring”



8 Kotwy, kołki, dyble

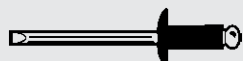

9 Nity, kołki & wpusty



10 Elementy łączące systemowe, meblowe & zabezpieczające



11 Zestawy

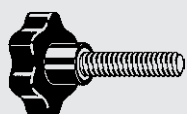

12 Części konstrukcyjne & części maszynowe



13 Przemysł morski

T Technologia łączenia

Przemysł morski 13

 Strona 13-3 Hak obrotowy z zabezpieczeniem	 Strona 13-4 Szekała typ D	 Strona 13-8 Szekała łukowa	 Strona 13-10 Szekała D skręcona	 Strona 13-11 Szekała D z przetyczką
 Strona 13-12 Szekała wielozadaniowa (szekłownik)	 Strona 13-13 Karabińczyk	 Strona 13-16 Karabińczyk boi	 Strona 13-17 Karabińczyk	 Strona 13-18 Karabińczyk asymetryczny
 Strona 13-20 Karabińczyk z nakrętką	 Strona 13-21 Karabińczyk z zamknięciem sprężynowym	 Strona 13-22 Karabińczyk ze specjalnym zamknięciem	 Strona 13-23 Karabińczyk krętlikowy	 Strona 13-24 Karabińczyk z podwójną blokadą
 Strona 13-25 Szekała zatrzaskowa	 Strona 13-27 Szekała zatrzaskowa krętlikowa	 Strona 13-28 Szekała krętlikowa	 Strona 13-31 Hak zatrzaskowy Waterski	 Strona 13-32 Karabińczyk aluminium
 Strona 13-33 Ósemka oczkowa	 Strona 13-34 Karabińczyk Simplex	 Strona 13-35 Zacisk do lin	 Strona 13-36 Ściągacze do lin	 Strona 13-38 Hak poślizgowy z pierścieniem
 Strona 13-39 Nakrętka ściągacza pełna	 Strona 13-40 Ściągacze do lin	 Strona 13-42 Ściągacz do lin	 Strona 13-43 Końcówki do zawalcowania	 Strona 13-46 Końcówki hakowe T do zawalcowania
 Strona 13-47 Końcówki widelkowe do zawalcowania	 Strona 13-49 Końcówka do ściągacza linowego	 Strona 13-50 Mocowanie regulowane	 Strona 13-51 Pelikan hak z gwintem	 Strona 13-52 Pelikan hak
 Strona 13-53 Końcówka skręcana	 Strona 13-54 Liny	 Strona 13-56 Ucinaki do lin	 Strona 13-56 Kausze	 Strona 13-58 Zaciski do lin
 Strona 13-60 Tuleje do zaciskania	 Strona 13-62 Zaciskarka ręczna z wymiennymi wkładkami	 Strona 13-63 Sworzeń	 Strona 13-66 Lina zabezpieczająca	 Strona 13-67 Zawleczka
 Strona 13-68 Zawleczka do kluczy	 Strona 13-69 ESS Uniwersalny ściągacz wahlivy	 Strona 13-70 ESS Końcówki do ściągaczy linowych	 Strona 13-74 ESS Końcówki do ściągaczy linowych z główką	 Strona 13-75 ESS Wkręty dwugwintowe

 <p>Strona 13-76</p> <p>ESS Nakrętka do ściągacza linowego</p>	 <p>Strona 13-77</p> <p>ESS Zaciski linowe z gwintem</p>	 <p>Strona 13-78</p> <p>ESS Kule pełne z gwintem wewnętrznym</p>	 <p>Strona 13-79</p> <p>ESS Trójkąt dystansowy na ścianę</p>	 <p>Strona 13-80</p> <p>ESS Podkładka pod trójkąt dystansowy</p>
 <p>Strona 13-81</p> <p>Zawias</p>	 <p>Strona 13-84</p> <p>Zawias niesymetryczny</p>	 <p>Strona 13-87</p> <p>Zawias odgięty</p>	 <p>Strona 13-88</p> <p>Zawias</p>	 <p>Strona 13-91</p> <p>Zawias specjalny</p>
 <p>Strona 13-92</p> <p>Zawias dwuczściowy</p>	 <p>Strona 13-93</p> <p>Zawias</p>	 <p>Strona 13-95</p> <p>Zawias</p>	 <p>Strona 13-96</p> <p>Zawias</p>	 <p>Strona 13-97</p> <p>Zawias</p>
 <p>Strona 13-98</p> <p>Zawias odlewany</p>	 <p>Strona 13-101</p> <p>Zawias odlewany, z gwintem</p>	 <p>Strona 13-104</p> <p>Zawias kryty</p>	 <p>Strona 13-105</p> <p>Zawias ciągły</p>	 <p>Strona 13-106</p> <p>Zamknięcia ryglowe</p>
 <p>Strona 13-107</p> <p>Zatrzask ryglowy</p>	 <p>Strona 13-109</p> <p>Zasuwa</p>	 <p>Strona 13-110</p> <p>Podnośnik denny</p>	 <p>Strona 13-112</p> <p>Podnośnik denny</p>	 <p>Strona 13-113</p> <p>Hak bramkowy</p>
 <p>Strona 13-114</p> <p>Hak na płaszcz</p>	 <p>Strona 13-117</p> <p>Hak wkręcany</p>	 <p>Strona 13-118</p> <p>Hak S-kształtny</p>	 <p>Strona 13-120</p> <p>Hak prosty otwarty</p>	 <p>Strona 13-121</p> <p>Hak do zasłon, zamknięte oko</p>
 <p>Strona 13-122</p> <p>Wspornik</p>	 <p>Strona 13-123</p> <p>Hak elastyczny wielowojowy</p>	 <p>Strona 13-124</p> <p>Hak otwarty z gwintem</p>	 <p>Strona 13-125</p> <p>Przeplot do lin</p>	 <p>Strona 13-126</p> <p>Blokada (zatrzask) do drzwi</p>
 <p>Strona 13-128</p> <p>Uchwyt do haka</p>	 <p>Strona 13-129</p> <p>Oczko ruchome do przykręcania</p>	 <p>Strona 13-130</p> <p>Pierścień</p>	 <p>Strona 13-133</p> <p>Pierścień z gwoździem</p>	 <p>Strona 13-134</p> <p>Uchwyt</p>
 <p>Strona 13-135</p> <p>Łańcuchy</p>	 <p>Strona 13-136</p> <p>Karabińczyk zakręcany</p>			

Hak obrotowy z zabezpieczeniem



Informacje techniczne

Nr	A	B	C	D	E	≈ Obciążenie niszczące w N
54100.028.001	28	17	18	69	147	20 000
54100.036.001	36	36	33	97	193	37 000
54101.019.001	19	33.5	100	20.5	-	15 000
54101.028.001	28	44.5	115	23	-	18 000

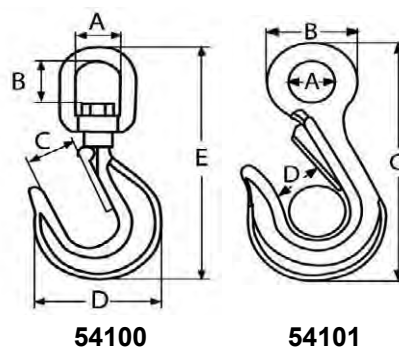

Grupy katalogowe

Material	Kod	Strona
St.St. A4	54100	13-3
St.St. A4	54101	13-3

54100 Hak obrotowy z zabezpieczeniem, z krętlikiem

MH11

Material Stal nierdzewna A4



A	☒	Kod artykułu	A	☒	Kod artykułu
28MM*	1	54100.028.001	36MM*	1	54100.036.001

54101 Hak obrotowy z zabezpieczeniem

MH11

Material Stal nierdzewna A4



A	☒	Kod artykułu	A	☒	Kod artykułu
19MM*	5	54101.019.001	28MM*	5	54101.028.001

Szklą typ D



Informacje techniczne

Nr	A	B	L	ø	≈ Obciążenie niszczące w N
54102.050.001	25	-	20	5	7 500
54102.060.001	24	-	33	6	13 500
54102.080.001	26	-	31	8	25 000
54102.100.001	41	-	55	10	33 500
54102.120.001	50	-	66	12	40 000
54104.040.001	8	16	14	4	7 000
54104.050.001	19	20	14.5	5	10 000
54104.060.001	12	24	21	6	15 000
54104.080.001	16	32	28	8	30 000
54104.100.001	20	40	36	10	45 000
54104.120.001	24	48	44	12	70 000
54104.160.001	32	64	56	16	100 000
54104.190.001	35	76	65.5	19	160 000
54105.050.001	10	20	16.5	5	11 000
54105.060.001	12	24	21	6	16 000
54105.080.001	16	32	28	8	32 000
54105.100.001	20	40	34	10	49 000
54105.120.001	24	48	36	12	66 000
54106.050.001	10	20	16.5	5	10 000
54106.060.001	12	24	18	6	15 000
54106.080.001	16	32	28	8	22 000
54106.100.001	20	40	35	10	37 000
54106.120.001	24	48	45	12	54 000
54106.140.001	28	56	49	14	65 000
54106.160.001	32	64	52	16	88 000
54106.190.001	38	76	63.5	19	160 000
54106.220.001	44	88	76	22	190 000
54107.040.001	8	16	15	4	10 800
54107.050.001	10	20	17.5	5	15 500
54107.060.001	12	24	21	6	18 600
54107.080.001	16	32	29	8	43 800
54107.100.001	20	40	35	10	58 000
54107.120.001	24	48	43	12	81 000
54109.048.001	9.7	5	19	6.4	13 200
54109.064.001	12	6	22	8	20 000
54109.080.001	13.5	8	26	9.5	30 000
54109.096.001	17	10	32	11	40 000
54109.127.001	21	12	41	16	80 000
54109.160.001	27	16	51	19	120 000
54109.190.001	32	20	60	22	160 000
54109.220.001	36	22	71	25	200 000
54112.040.001	8.5	-	31.3	4	7 000
54112.050.001	10	-	40	5	10 000
54112.060.001	12	-	48	6	15 000
54112.080.001	16	-	64	8	32 000
54112.100.001	20	-	80	10	49 000
54112.120.001	24	-	96	12	70 000
54113.050.001	10	-	37.5	5	11 000
54113.060.001	12	-	43	6	16 000
54113.080.001	16	-	60	8	32 000
54113.100.001	20	-	75	10	49 000
54113.120.001	24	-	90	12	66 000
54115.050.001	12	2.6	18.5	5	4 000
54115.060.001	14	3	22	6	5 000
54115.080.001	18	3.7	28	8	9 000
54116.040.001	10	-	15	4	8 000
54116.050.001	12	-	17.5	5	11 000

Informacje techniczne

Nr	A	B	L	∅	≈ Obciążenie niszczące w N
54116.060.001	16	-	21	6	20 000
54117.040.001	12	-	24	4	8 000
54117.050.001	16	-	21	5	11 000
54117.060.001	17	-	26	6	20 000

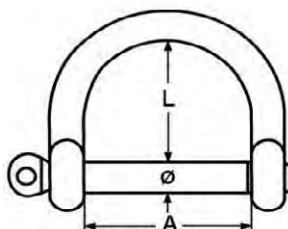

54102

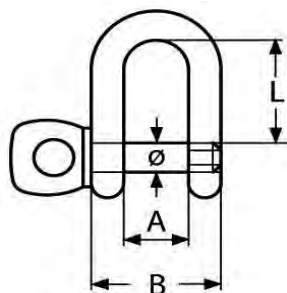

54104-5-7

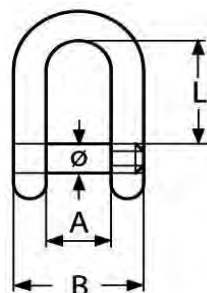

54106

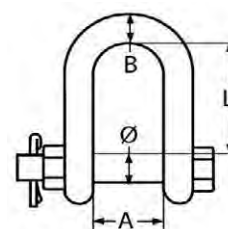

54109

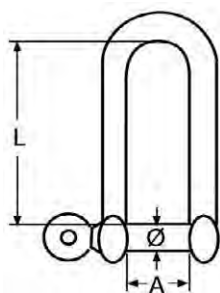

54112-3

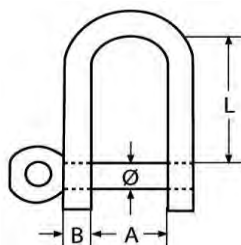

54115

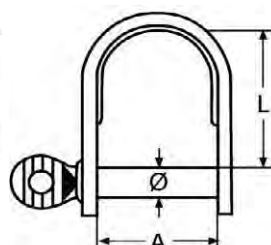

54116

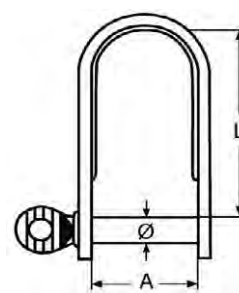

54117

Grupy katalogowe

Material	Kod	Strona
St.St. A4	54102	13-5
St.St. A4	54104	13-6
St.St. A4	54105	13-6
St.St. A4	54106	13-6
St.St. A4	54107	13-6
St.St. A4	54109	13-6
St.St. A4	54112	13-6
St.St. A4	54113	13-7
St.St. A4	54115	13-7
St.St. A4	54116	13-7
St.St. A4	54117	13-7

54102 Szekla okrągła, szeroka

MH11



Material Stal nierdzewna A4



∅	☒	Kod artykułu	∅	☒	Kod artykułu	∅	☒	Kod artykułu
5MM*	10	54102.050.001	8MM*	10	54102.080.001	12MM*	5	54102.120.001
6MM*	10	54102.060.001	10MM*	5	54102.100.001			

54104	Szekla okrągła, krótka	MH11
Materiał	Stal nierdzewna A4	
		

Ø	☒	Kod artykułu	Ø	☒	Kod artykułu	Ø	☒	Kod artykułu
4MM*	50	54104.040.001	8MM*	20	54104.080.001	16MM*	10	54104.160.001
5MM*	50	54104.050.001	10MM*	20	54104.100.001	19MM*	10	54104.190.001
6MM*	50	54104.060.001	12MM*	20	54104.120.001			

54105	Szekla okrągła ze śrubą zabezpieczającą, przed wypadnięciem	MH11
Materiał	Stal nierdzewna A4	
		



Ø	☒	Kod artykułu	Ø	☒	Kod artykułu	Ø	☒	Kod artykułu
5MM*	10	54105.050.001	8MM*	10	54105.080.001	12MM*	5	54105.120.001
6MM*	10	54105.060.001	10MM*	5	54105.100.001			

54106	Szekla okrągła, skręcana	MH11
Materiał	Stal nierdzewna A4	
		

Ø	☒	Kod artykułu	Ø	☒	Kod artykułu	Ø	☒	Kod artykułu
5MM*	10	54106.050.001	10MM*	5	54106.100.001	16MM*	5	54106.160.001
6MM*	10	54106.060.001	12MM*	5	54106.120.001	19MM*	1	54106.190.001
8MM*	10	54106.080.001	14MM*	5	54106.140.001	22MM*	1	54106.220.001

54107	Szekla okrągła, kuta	MH11
Materiał	Stal nierdzewna A4	
		

Ø	☒	Kod artykułu	Ø	☒	Kod artykułu	Ø	☒	Kod artykułu
4MM*	10	54107.040.001	6MM*	10	54107.060.001	10MM*	5	54107.100.001
5MM*	10	54107.050.001	8MM*	10	54107.080.001	12MM*	5	54107.120.001

54109	Szekla okrągła ze śrubą zabezpieczającą, kuta	MH11
Materiał	Stal nierdzewna A4	
		

Ø	☒	Kod artykułu	Ø	☒	Kod artykułu	Ø	☒	Kod artykułu
4,8MM*	10	54109.048.001	9,5MM*	5	54109.096.001	19MM*	1	54109.190.001
6,4MM*	10	54109.064.001	12,7MM*	5	54109.127.001	22MM*	1	54109.220.001
8MM*	10	54109.080.001	16MM*	5	54109.160.001			

54112	Szekla okrągła, długa	MH11
Materiał	Stal nierdzewna A4	
		

∅	☒	Kod artykułu	∅	☒	Kod artykułu	∅	☒	Kod artykułu
4MM*	10	54112.040.001	6MM*	10	54112.060.001	10MM*	5	54112.100.001
5MM*	10	54112.050.001	8MM*	10	54112.080.001	12MM*	5	54112.120.001

54113 Szekla okrągła, długa ze śrubą zabezp. przed wypadn. MH11							
Materiał		Stal nierdzewna A4					

∅	☒	Kod artykułu	∅	☒	Kod artykułu	∅	☒	Kod artykułu
5MM*	10	54113.050.001	8MM*	10	54113.080.001	12MM*	5	54113.120.001
6MM*	10	54113.060.001	10MM*	5	54113.100.001			

54115 Szekla płaska, okrągła MH11							
Materiał		Stal nierdzewna A4					

∅	☒	Kod artykułu	∅	☒	Kod artykułu	∅	☒	Kod artykułu
5MM*	10	54115.050.001	6MM*	10	54115.060.001	8MM*	10	54115.080.001

54116 Szekla płaska z przetyczką, krótka MH11							
Materiał		Stal nierdzewna A4					

∅	☒	Kod artykułu	∅	☒	Kod artykułu	∅	☒	Kod artykułu
4MM*	10	54116.040.001	5MM*	10	54116.050.001	6MM*	10	54116.060.001

54117 Szekla płaska z przetyczką, długa MH11							
Materiał		Stal nierdzewna A4					



∅	☒	Kod artykułu	∅	☒	Kod artykułu	∅	☒	Kod artykułu
4MM*	10	54117.040.001	5MM*	10	54117.050.001	8MM*	10	54117.060.001

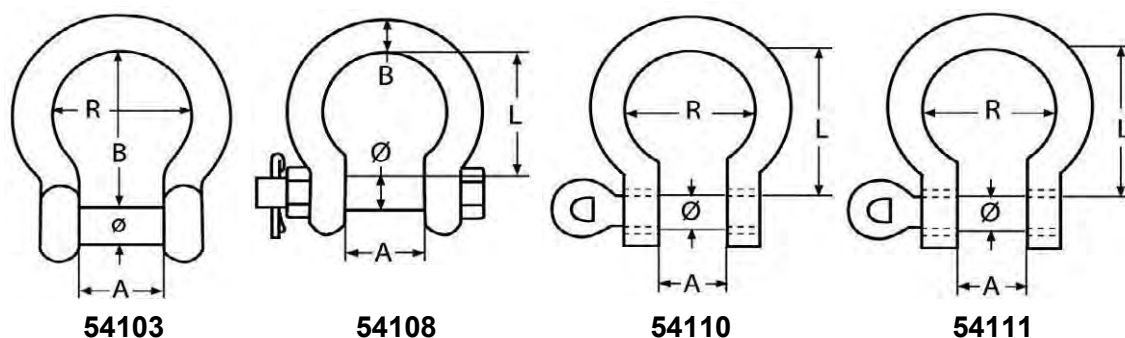

Informacje techniczne



Nr	A	B	L	R	∅	≈ Obciążenie niszczące w N
54103.050.001	11	25	-	17	5	12 000
54103.060.001	12	30	-	21	6	17 000
54103.080.001	16	44	-	28	8	25 000
54103.100.001	21	49	-	34	10	43 000
54103.120.001	25	57	-	42	12	62 000
54103.160.001	31	80	-	56	16	70 000
54103.190.001	36	96	-	66	19	140 000
54108.048.001	9.7	5	22	-	6.4	13 200
54108.064.001	12	6	29	-	8	20 000
54108.080.001	13.5	8	31	-	9.5	30 000
54108.096.001	17	10	36	-	11	40 000
54108.127.001	21	12	48	-	16	80 000
54108.160.001	27	16	60	-	19	120 000
54108.190.001	32	20	71	-	22	160 000
54108.220.001	36	22	84	-	25	200 000
54110.040.001	8	-	14	14	4	8 000
54110.050.001	10	-	17.5	17	7	12 000
54110.060.001	12	-	21	21	6	19 000
54110.080.001	16	-	28	28	8	28 000
54110.100.001	20	-	35	34	10	43 000
54110.120.001	24	-	42	42	12	65 000
54110.130.001	26	-	39	45	13	75 000
54110.160.001	32	-	56	56	16	120 000
54110.190.001	38	-	78.5	66	19	182 000
54110.220.001	44	-	77	78	22	210 000
54111.050.001	10	-	17.5	17	5	13 000
54111.060.001	12	-	21	21	6	18 000
54111.080.001	16	-	28	28	8	35 000
54111.100.001	20	-	35	34	10	54 000



Grupy katalogowe

Material	Kod	Strona
St.St. A4	54103	13-9
St.St. A4	54108	13-9
St.St. A4	54110	13-9
St.St. A4	54111	13-9

54103 Szekla okrągła, kuta z napędem sześciokątnym							MH11	
Materiał		Stal nierdzewna A4						
								
∅	⊠	Kod artykułu	∅	⊠	Kod artykułu	∅	⊠	Kod artykułu
5MM*	10	54103.050.001	10MM*	5	54103.100.001	16MM*	5	54103.160.001
6MM*	10	54103.060.001	12MM*	5	54103.120.001	19MM*	1	54103.190.001
8MM*	10	54103.080.001						

54108 Szekla okrągła ze śrubą zabezpieczającą, kuta							MH11	
Materiał		Stal nierdzewna A4						
								
∅	⊠	Kod artykułu	∅	⊠	Kod artykułu	∅	⊠	Kod artykułu
4,8MM*	10	54108.048.001	9,5MM*	5	54108.096.001	19MM*	1	54108.190.001
6,4MM*	10	54108.064.001	12,7MM*	5	54108.127.001	22MM*	1	54108.220.001
8MM*	10	54108.080.001	16MM*	5	54108.160.001			

54110 Szekla typu „omega”							MH11	
Materiał		Stal nierdzewna A4						
								
∅	⊠	Kod artykułu	∅	⊠	Kod artykułu	∅	⊠	Kod artykułu
4MM*	20	54110.040.001	10MM*	10	54110.100.001	16MM*	5	54110.160.001
5MM*	20	54110.050.001	12MM*	5	54110.120.001	19MM*	1	54110.190.001
6MM	20	54110.060.001	13MM*	5	54110.130.001	22MM*	1	54110.220.001
8MM	10	54110.080.001						

54111 Szekla okrągła ze śrubą zabezp. przed wypadn.							MH11	
Materiał		Stal nierdzewna A4						
								
∅	⊠	Kod artykułu	∅	⊠	Kod artykułu	∅	⊠	Kod artykułu
5MM*	10	54111.050.001	8MM*	10	54111.080.001	10MM*	5	54111.100.001
6MM*	10	54111.060.001						

Szekła D skręcona



Informacje techniczne

Nr	A	L	ø	≈ Obciążenie niszczące w N
54114.050.001	10	27	5	12 000
54114.060.001	12	30	6	17 500
54114.080.001	16	42	8	30 000
54114.100.001	20	55	10	58 000
54114.120.001	24	65	12	70 000
54118.040.001	11	24	4	8 000
54118.050.001	12	40	5	14 000

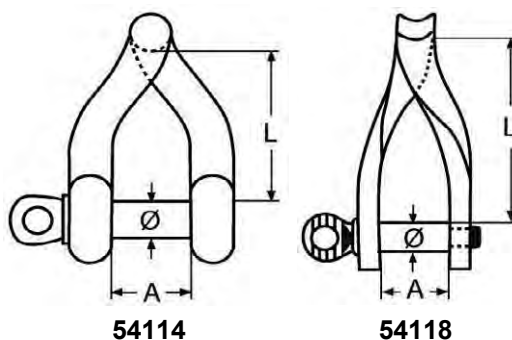

Grupy katalogowe

Material	Kod	Strona
St.St. A4	54114	13-10
St.St. A4	54118	13-10

54114 Szekła D skręcona MH11

Material Stal nierdzewna A4



ø	⊗	Kod artykułu	ø	⊗	Kod artykułu	ø	⊗	Kod artykułu
5MM*	10	54114.050.001	8MM*	10	54114.080.001	12MM*	5	54114.120.001
6MM*	10	54114.060.001	10MM*	5	54114.100.001			

54118 Szekła płaska z przetyczką, skręcona MH11

Material Stal nierdzewna A4



ø	⊗	Kod artykułu	ø	⊗	Kod artykułu
4MM*	10	54118.040.001	5MM*	10	54118.050.001

Szekla D z przetyczką



Informacje techniczne

Nr	A	B	C	L	∅	≈ Obciążenie niszczące w N
54119.050.001	13	-	-	40	5	9 540
54119.060.001	16	-	-	49	6	13 630
54119.080.001	22	-	-	62	8	22 720
54120.050.001	13	40	12.5	-	5	9 540
54120.060.001	16	49	15.0	-	6	13 630
54120.080.001	21.5	66	20.5	-	8	22 710

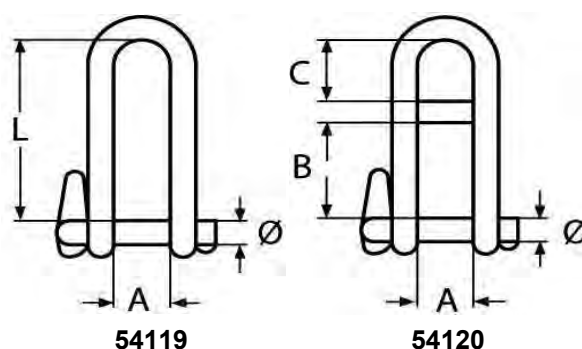

Grupy katalogowe

Material	Kod	Strona
St.St. A4	54119	13-11
St.St. A4	54120	13-11

54119 Szekla D z przetyczką

MH11

Material Stal nierdzewna A4



∅	✉	Kod artykułu	∅	✉	Kod artykułu	∅	✉	Kod artykułu
5MM*	10	54119.050.001	6MM*	10	54119.060.001	8MM*	10	54119.080.001

54120 Szekla D z przetyczka i mostkiem

MH11

Material Stal nierdzewna A4



∅	✉	Kod artykułu	∅	✉	Kod artykułu	∅	✉	Kod artykułu
5MM*	10	54120.050.001	6MM*	10	54120.060.001	8MM*	10	54120.080.001

Szekla wielozadaniowa (szeklownik)



Informacje techniczne

Nr	A	L
54121.032.100	2.0	100
54122.050.086	5.0	86

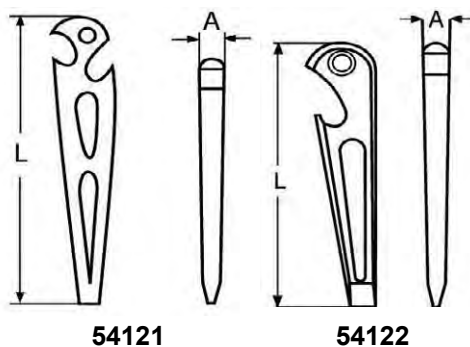

54121

54122

Grupy katalogowe

Material	Kod	Strona
St.St. A2	54121	13-12
St.St. A4	54122	13-12

54121 Szekla wielozadaniowa (szeklownik) MH11

Material Stal nierdzewna A2



A [Kod artykułu](#)

2MM* 5 [54121.032.100](#)

54122 Szekla wielozadaniowa (szeklownik) MH11

Material Stal nierdzewna A4



A [Kod artykułu](#)

5MM* 10 [54122.050.086](#)

Karabińczyk



Informacje techniczne

Nr	A	B	C	D	D ₁	L	ø	≈ Obciążenie niszczące w N
54123.050.050	6	-	8	-	10	50	5	5 700
54123.060.060	8	-	9	-	11	60	6	6 700
54123.070.070	8	-	9	-	13	70	7	7 500
54123.080.080	8	-	9	-	13	80	8	8 700
54123.100.100	10	-	12	-	16	100	10	11 500
54123.110.120	11	-	16	-	18	120	11	12 500
54124.040.040	5	-	7	5	-	40	4	2 000
54124.050.050	6	-	8	6.5	-	50	5	4 000
54124.060.060	8	-	9	7.2	-	60	6	6 000
54124.070.070	8	-	9	9	-	70	7	9 000
54124.080.080	8	-	9	10.2	-	80	8	11 500
54124.100.100	10	-	12	13	-	100	10	14 500
54124.110.120	11	-	16	15	-	120	11	15 500
54124.120.140	13	-	19	18	-	140	12	16 500
54125.040.040	6.5	-	7	5	-	40	4	4 000
54125.050.050	7.5	-	8	9	-	50	5	6 000
54125.060.060	7.5	-	9	10	-	60	6	9 000
54125.070.070	9	-	9	11	-	70	7	10 000
54125.080.080	8	-	8	13	-	80	8	12 000
54125.100.100	10	-	10	16	-	100	10	14 000
54125.110.120	11	-	15	18	-	120	11	15 000
54126.040.040	5	-	7	5	-	40	4	4 000
54126.050.050	6	-	8	9	-	50	5	6 000
54126.060.060	8	-	9	10	-	60	6	9 000
54126.070.070	8	-	9	11	-	70	7	10 000
54126.080.080	8	-	8	13	-	80	8	12 000
54126.100.100	10	-	10	16	-	100	10	14 000
54126.110.120	11	-	15	18	-	120	11	15 000
54129.060.060	-	30	7.5	8.5	-	60	6	2 720
54129.080.080	-	40	10	12	-	80	8	5 080
54129.100.100	-	50	12	15	-	100	10	7 280
54130.050.050	-	26	15	8	-	50	5	3 870
54130.060.060	-	30	16	8.5	-	60	6	4 170
54130.080.080	-	40	23	12	-	80	8	9 900
54130.100.100	-	50	27	15	-	100	10	13 000
54131.050.050	-	26	15	7.8	-	50	5	3 870
54131.060.060	-	30	16	7.8	-	60	6	4 170
54131.080.080	-	40	23	10.8	-	80	8	9 900
54131.100.100	-	50	27	14	-	100	10	13 000
54138.060.060	-	30	8.5	-	-	60	6	2 720
54138.080.080	-	40	10	-	-	80	8	5 080
54138.100.100	-	50	12	-	-	100	10	7 280
54138.110.120	-	60	17	-	-	120	11	8 160

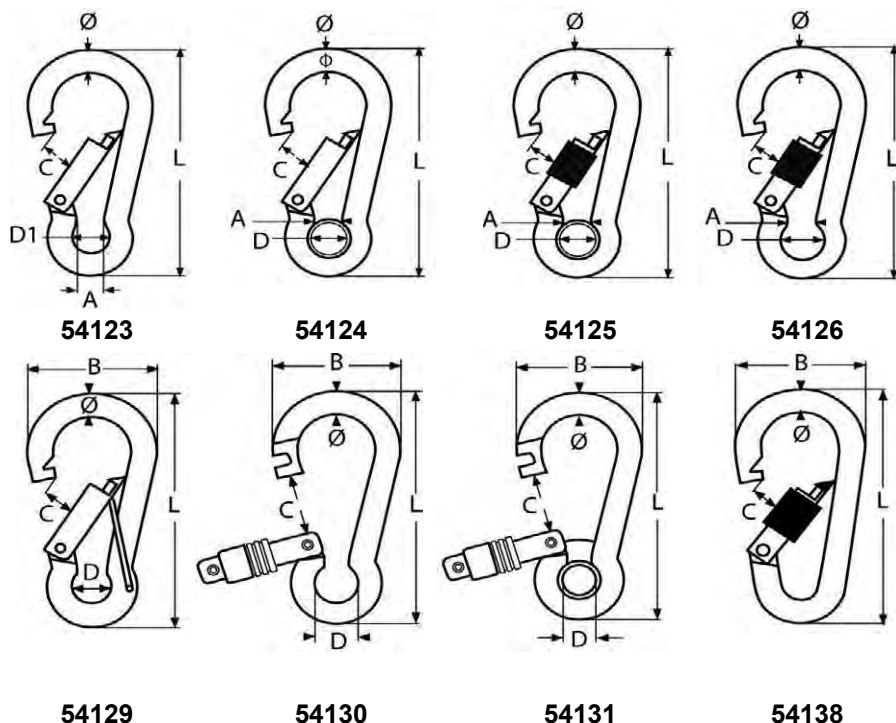

Grupy katalogowe

Material	Kod	Strona
St.St. A4	54123	13-14
St.St. A4	54124	13-14
St.St. A4	54125	13-15
St.St. A4	54126	13-15
St.St. A4	54129	13-15
St.St. A4	54130	13-15
St.St. A4	54131	13-15
St.St. A4	54138	13-15

54123 Karabińczyk MH11

Material Stal nierdzewna A4















ø x L	☒	Kod artykułu	ø x L	☒	Kod artykułu	ø x L	☒	Kod artykułu
5X50MM	20	54123.050.050	7X70MM*	20	54123.070.070	10X100MM*	10	54123.100.100
6X60MM	20	54123.060.060	8X80MM	20	54123.080.080	11X120MM*	10	54123.110.120

54124 Karabińczyk z kauszą MH11

Material Stal nierdzewna A4



ø x L	☒	Kod artykułu	ø x L	☒	Kod artykułu	ø x L	☒	Kod artykułu
4X40MM*	10	54124.040.040	7X70MM*	10	54124.070.070	11X120MM*	5	54124.110.120
5X50MM*	10	54124.050.050	8X80MM*	10	54124.080.080	12X140MM*	5	54124.120.140
6X60MM*	10	54124.060.060	10X100MM*	5	54124.100.100			

54125	Karabińczyk z nakrętką zabezpieczającą i kauszą	MH11
Materiał	Stal nierdzewna A4	
		
ø x L	<input type="checkbox"/> Kod artykułu	ø x L
4X40MM*	10 54125.040.040	7X70MM*
5X50MM*	10 54125.050.050	8X80MM*
6X60MM*	10 54125.060.060	
		ø x L
		10X100MM*
		11X120MM*
		5 54125.100.100
		5 54125.110.120
54126	Karabińczyk z nakrętką zabezpieczającą	MH11
Materiał	Stal nierdzewna A4	
		
ø x L	<input type="checkbox"/> Kod artykułu	ø x L
4X40MM*	10 54126.040.040	7X70MM*
5X50MM*	10 54126.050.050	8X80MM*
6X60MM*	10 54126.060.060	
		ø x L
		10X100MM*
		11X120MM*
		5 54126.100.100
		5 54126.110.120
54129	Karabińczyk z zamknięciem zabezpieczającym	MH11
Materiał	Stal nierdzewna A4	
		
ø x L	<input type="checkbox"/> Kod artykułu	ø x L
6X60MM*	10 54129.060.060	8X80MM*
		10X100MM*
		5 54129.100.100
54130	Karabińczyk z zamknięciem sprężynowym	MH11
Materiał	Stal nierdzewna A4	
		
ø x L	<input type="checkbox"/> Kod artykułu	ø x L
5X50MM*	10 54130.050.050	8X80MM*
6X60MM*	10 54130.060.060	
		ø x L
		10X100MM*
		5 54130.100.100
54131	Karabińczyk z zamknięciem sprężynowym i kauszą	MH11
Materiał	Stal nierdzewna A4	
		
ø x L	<input type="checkbox"/> Kod artykułu	ø x L
5X50MM*	10 54131.050.050	8X80MM*
6X60MM*	10 54131.060.060	
		ø x L
		10X100MM*
		5 54131.100.100
54138	Karabińczyk z nakrętką zabezpieczającą	MH11
Materiał	Stal nierdzewna A4	
		
ø x L	<input type="checkbox"/> Kod artykułu	ø x L
6X60MM*	10 54138.060.060	10X100MM*
8X80MM*	10 54138.080.080	
		ø x L
		5 54138.100.100
		5 54138.110.120

Karabińczyk boi



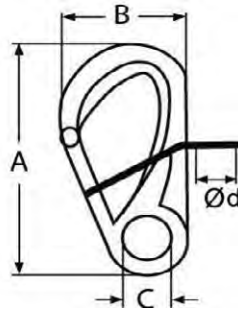

Informacje techniczne

Nr	A	B	C	ø d	≈ Obciążenie niszczące w N
54127.108.063	108	63	21	35	9 100



54127

54127	Karabińczyk boi	MH11
Materiał	Stal nierdzewna A4	
		 

A x B	✉	Kod artykułu
108X63MM*	5	54127.108.063

Karabińczyk



Informacje techniczne

Nr	B	D	E	L	∅	≈ Obciążenie niszczące w N
54128.060.001	35	7	10	61	6	6 000
54128.080.001	48	11	13	81	8	16 000
54128.100.001	58	13	15	102	10	25 000
54128.120.001	70	16	21	122	12	30 000
54128.160.001	97	25	27	165	16	33 000

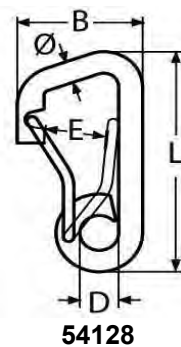

54128	Karabińczyk	MH11
Materiał	Stal nierdzewna A4	

∅	☒	Kod artykułu	∅	☒	Kod artykułu	∅	☒	Kod artykułu
6MM*	10	54128.060.001	10MM*	5	54128.100.001	16MM*	5	54128.160.001
8MM*	10	54128.080.001	12MM*	5	54128.120.001			

Karabińczyk asymetryczny



Informacje techniczne

Nr	B	C	D	E	L	∅	≈ Obciążenie niszczące w N
54132.060.060	35	9	8	-	60	6	4 560
54132.080.080	46	12.5	11	-	80	8	7 280
54132.100.100	60	16	14	-	100	10	10 920
54132.110.120	70	21.5	18	-	120	11	12 600
54133.110.120	70	24	-	-	120	11	16 000
54134.110.120	70	24	-	-	120	11	16 000
54135.100.115	60	19	-	-	115	10	27 200
54136.080.080	45	12	1.7	13	80	8	13 300
54136.100.100	55	14	2	16	100	10	25 100
54137.080.064	45	11.5	-	-	80	8	15 900
54137.100.080	55	14	-	-	100	10	16 800
54142.080.080	45	13	11	-	80	8	8 700
54142.100.100	58	18	14	-	100	10	13 500
54142.110.120	70	24	18	-	120	11	15 000

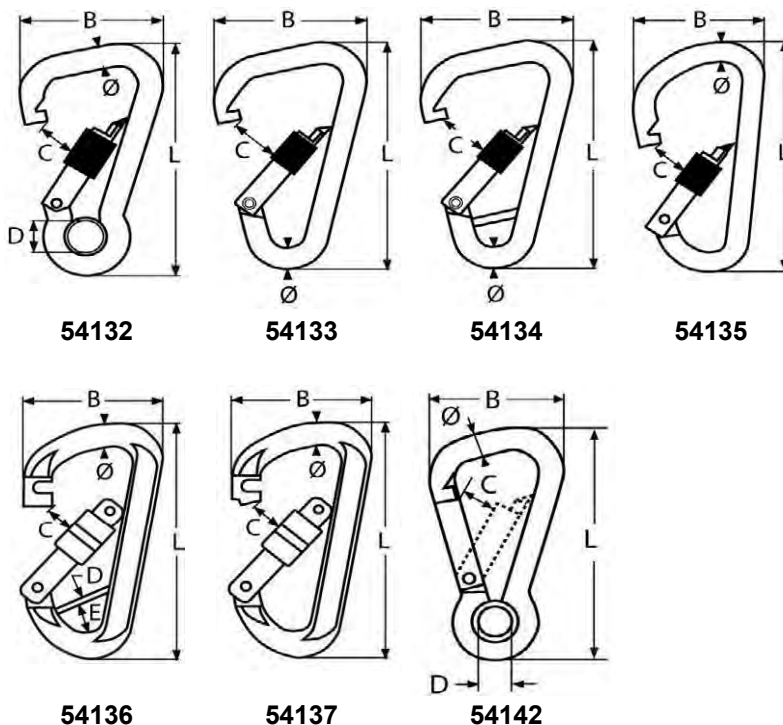



Grupy katalogowe

Material	Kod	Strona
St.St. A4	54132	13-19
St.St. A4	54133	13-19
St.St. A4	54134	13-19
St.St. A4	54135	13-19
St.St. A4	54136	13-19
St.St. A4	54137	13-19
St.St. A4	54142	13-20

54132 Karabińczyk asymetryczny z nakrętką zabezpieczającą i kauszą MH11



Materiał Stal nierdzewna A4

ø x L	⊠	Kod artykułu	ø x L	⊠	Kod artykułu	ø x L	⊠	Kod artykułu
6X60MM*	10	54132.060.060	10X100MM*	5	54132.100.100	11X120MM*	5	54132.110.120
8X80MM*	10	54132.080.080						

54133 Karabińczyk asymetryczny z nakrętką zabezpieczającą MH11

Materiał Stal nierdzewna A4

ø x L	⊠	Kod artykułu
11X120MM*	5	54133.110.120

54134 Karabińczyk z nakrętką zabezpieczającą i mostkiem MH11

Materiał Stal nierdzewna A4



ø x L	⊠	Kod artykułu
11X120MM*	5	54134.110.120

54135 Karabińczyk z nakrętką zabezpieczającą MH11



Materiał Stal nierdzewna A4



ø x L	⊠	Kod artykułu
10X115MM*	5	54135.100.115

54136 Karabińczyk z zamknięciem sprężynowym i mostkiem MH11

Materiał Stal nierdzewna A4





ø x L	⊠	Kod artykułu	ø x L	⊠	Kod artykułu
8X80MM*	10	54136.080.080	10X100MM*	5	54136.100.100

54137 Karabińczyk z zamknięciem sprężynowym MH11

Materiał Stal nierdzewna A4



ø x L	⊠	Kod artykułu	ø x L	⊠	Kod artykułu
8X64MM*	10	54137.080.064	10X80MM*	5	54137.100.080

54142	Karabińczyk asymetryczny z kauszą	MH11
Materiał	Stal nierdzewna A4	
		
ø x L	 Kod artykułu	ø x L
8X80*	10 54142.080.080	10X100*
	 Kod artykułu	ø x L
	5 54142.100.100	11X120*
	 Kod artykułu	
		5 54142.110.120

Karabińczyk z nakrętką zabezpieczającą





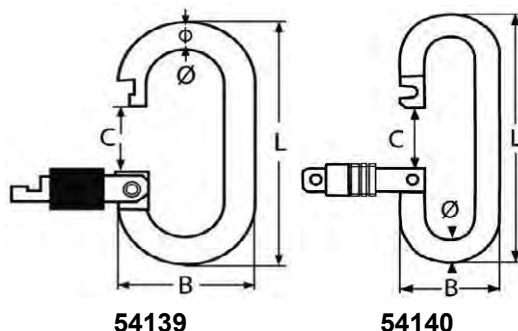

Informacje techniczne

Nr	B	C	L	ø	≈ Obciążenie niszczące w N
54139.060.052	30	14	55	6	4 400
54139.080.070	35	18	70	8	9 050
54140.050.070	25	15	70	5	3 700
54140.060.080	30	16	80	6	4 400
54140.060.090	35	23	90	8	9 050
54140.100.110	40	27	110	10	13 950



Grupy katalogowe

Materiał	Kod	Strona
St.St. A4	54139	13-20
St.St. A4	54140	13-21

54139	Karabińczyk z nakrętką zabezpieczającą	MH11
Materiał	Stal nierdzewna A4	
		
ø x L	 Kod artykułu	ø x L
6X52MM*	10 54139.060.052	8X70MM*
	 Kod artykułu	
	10 54139.080.070	

54140	Karabińczyk z nakrętką zabezpieczającą	MH11
Materiał	Stal nierdzewna A4	
		

ø x L	⊗	Kod artykułu	ø x L	⊗	Kod artykułu	ø x L	⊗	Kod artykułu
5X70MM*	10	54140.050.070	8X90MM*	10	54140.060.090	10X110MM*	5	54140.100.110
6X80MM*	10	54140.060.080						

Karabińczyk z zamknięciem sprężynowym



Informacje techniczne

Nr	A	B	C	D	L	≈ Obciążenie niszczące w N
54143.050.001	-	24	10	10.5	50	2 000
54143.070.001	-	31	12	13	70	7 000
54143.100.001	-	46	22	21	100	18 000
54157.050.001	6.5	25	-	-	50	2 500
54157.065.001	10	35	-	-	65	5 500
54157.090.001	13	49	-	-	90	10 000

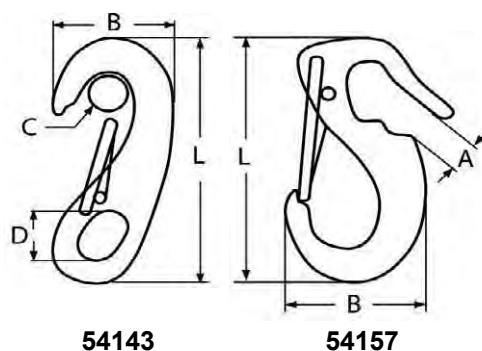





Grupy katalogowe

Materiał	Kod	Strona
St.St. A4	54143	13-21
St.St. A4	54157	13-22

54143	Karabińczyk z zamknięciem sprężynowym	MH11
Materiał	Stal nierdzewna A4	
		

L	⊗	Kod artykułu	L	⊗	Kod artykułu	L	⊗	Kod artykułu
50MM*	10	54143.050.001	70MM*	10	54143.070.001	100MM*	5	54143.100.001

54157	Karabińczyk z zamknięciem sprężynowym	MH11			
Materiał	Stal nierdzewna A4				
					
L	 Kod artykułu	L	 Kod artykułu	L	 Kod artykułu
50MM*	10 54157.050.001	65MM*	10 54157.065.001	90MM*	5 54157.090.001

Spring hook with special closure





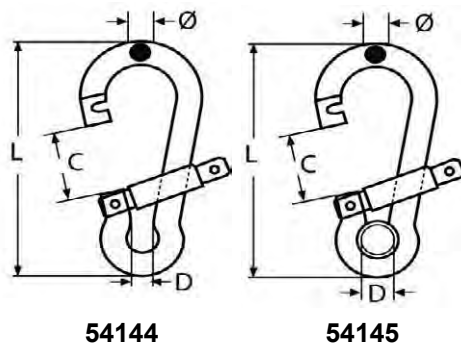

Informacje techniczne

Nr	C	D	L	ø	≈ Obciążenie niszczące w N
54144.080.080	19	8	80	8	8 000
54144.100.100	22	11	100	10	12 000
54144.110.120	26	12	120	11	20 000
54145.080.080	19	10	80	8	8 000
54145.100.100	22	14	100	10	12 000
54145.110.120	26	17	120	11	20 000



Grupy katalogowe

Materiał	Kod	Strona
St.St. A4	54144	13-22
St.St. A4	54145	13-23

54144	Spring hook with special closure	MH11			
Materiał	Stal nierdzewna A4				
					
ø x L	 Kod artykułu	ø x L	 Kod artykułu	ø x L	 Kod artykułu
8X80*	10 54144.080.080	10X100*	10 54144.100.100	11X120*	10 54144.110.120

54145 Karabińczyk ze specjalnym zamknięciem i kauszą							MH11	
Materiał Stal nierdzewna A4								
ø x L	✉	Kod artykułu	ø x L	✉	Kod artykułu	ø x L	✉	Kod artykułu
8X80*	10	54145.080.080	10X100*	5	54145.100.100	11X120*	5	54145.110.120

Karabińczyk krętlikowy



Informacje techniczne

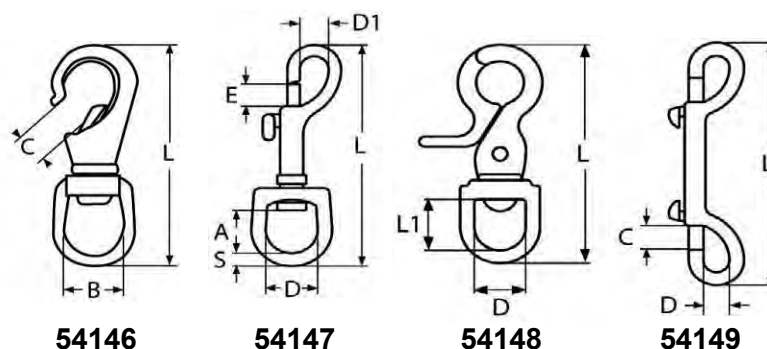

Nr	A	B	C	D	D ₁	E	L	L ₂	S
54146.160.001	-	21	11	-	-	-	86	-	-
54146.190.001	-	21	12	-	-	-	99.5	-	-
54146.220.001	-	21	16	-	-	-	117.5	-	-
54147.090.001	10.5	-	-	9	7	7	62	-	3
54147.120.001	13.5	-	-	12	8	8	75	-	4
54147.160.001	15.5	-	-	16	9	9	87	-	4
54147.190.001	19	-	-	19	9	9	90	-	5
54148.130.001	-	-	-	13	-	-	65	16	-
54148.160.001	-	-	-	16	-	-	65	19	-
54149.011.115	-	-	10	11	-	-	115	-	-







Grupy katalogowe

Materiał	Kod	Strona
St.St. A4	54146	13-23
St.St. A4	54147	13-24
St.St. A4	54148	13-24
St.St. A4	54149	13-24

54146 Hak zatrzaskowy z krętlikiem							MH11	
Materiał Stal nierdzewna A4								
C	✉	Kod artykułu	C	✉	Kod artykułu	C	✉	Kod artykułu
11MM*	5	54146.160.001	12MM*	5	54146.190.001	16MM*	5	54146.220.001

54147 Karabińczyk krętlikowy				MH11	
Materiał		Stal nierdzewna A4			
					
					
D	☒	Kod artykułu	D	☒	Kod artykułu
9MM*	10	54147.090.001	16MM*	5	54147.160.001
12MM	10	54147.120.001			
					54147.190.001

54148 Hak zatrzaskowy z krętlikiem				MH11	
Materiał		Stal nierdzewna A4			
					
					
D	☒	Kod artykułu	D	☒	Kod artykułu
13MM*	5	54148.130.001	16MM*	5	54148.160.001

54149 Karabińczyk podwójny				MH11	
Materiał		Stal nierdzewna A4			
					
					
D x L	☒	Kod artykułu			
11X115MM*	5	54149.011.115			

Karabińczyk z podwójną blokadą



Informacje techniczne

Nr	B	C	D	L	≈ Obciążenie niszczące w N
54150.100.110	62	19	20	110	14 000

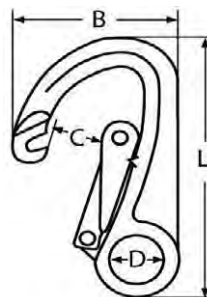

54150

54150	Karabińczyk z podwójną blokadą	MH11
Materiał	Stal nierdzewna A4	
		

L		Kod artykułu
110MM*	5	54150.100.110

Szklą zatraskowa



Informacje techniczne

Nr	A	B	C	d	D	H	L
54151.070.001	12	33	12	-	-	9	70
54151.087.001	13	42	16	-	-	15	87
54151.128.001	22	58	22	-	-	20	128
54152.070.001	-	33	12	-	12	-	70
54152.087.001	-	42	16	-	16	-	87
54152.128.001	-	58	22	-	22	-	128
54153.052.001	-	35	12	-	9	-	52
54153.066.001	-	45	16	-	12	-	66
54153.096.001	-	60	22	-	16	-	96
54154.012.052	10	12	-	-	-	-	52
54154.015.066	14	15	-	-	-	-	66
54154.025.096	18	25	-	-	-	-	96
54155.060.001	12	30	-	M6	-	-	42
54155.080.001	16	40	-	M8	-	-	53
54155.100.001	22	62	-	M10	-	-	75

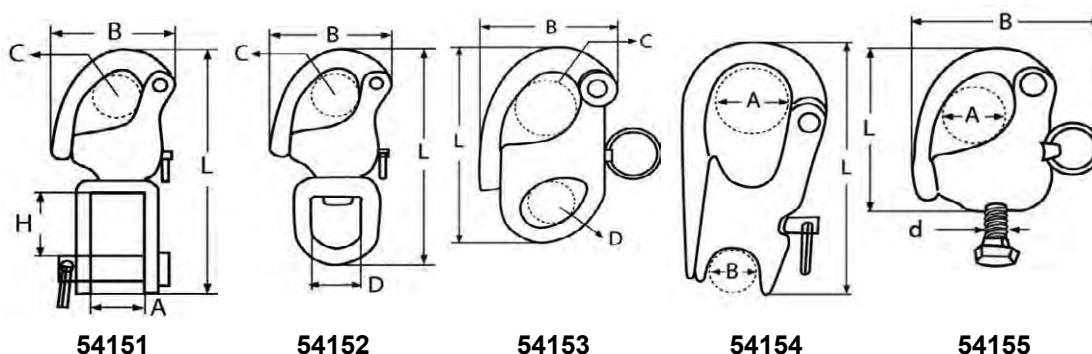

Grupy katalogowe

Materiał	Kod	Strona
St.St. A4	54151	13-26
St.St. A4	54152	13-26
St.St. A4	54153	13-26
St.St. A4	54154	13-26
St.St. A4	54155	13-26

54151	Szekla zatrzaskowa, krętkowa	MH11
Materiał	Stal nierdzewna A4	
		



L		Kod artykułu	L		Kod artykułu	L		Kod artykułu
70MM*	5	54151.070.001	87MM*	5	54151.087.001	128MM*	5	54151.128.001

54152	Szekla zatrzaskowa, krętkowa	MH11
Materiał	Stal nierdzewna A4	
		

L		Kod artykułu	L		Kod artykułu	L		Kod artykułu
70MM*	5	54152.070.001	87MM*	5	54152.087.001	128MM*	5	54152.128.001

54153	Szekla zatrzaskowa	MH11
Materiał	Stal nierdzewna A4	
		

L		Kod artykułu	L		Kod artykułu	L		Kod artykułu
52MM*	5	54153.052.001	66MM*	5	54153.066.001	96MM*	5	54153.096.001

54154	Szekla zatrzaskowa szotowa	MH11
Materiał	Stal nierdzewna A4	
		

B x L		Kod artykułu	B x L		Kod artykułu	B x L		Kod artykułu
12X52*	5	54154.012.052	15X66*	5	54154.015.066	25X96*	5	54154.025.096

54155	Szekla zatrzaskowa ze śrubą	MH11
Materiał	Stal nierdzewna A4	
		

L		Kod artykułu	L		Kod artykułu	L		Kod artykułu
6MM*	5	54155.060.001	8MM*	5	54155.080.001	10MM*	5	54155.100.001

Szekla zatrzaskowe krętkowa



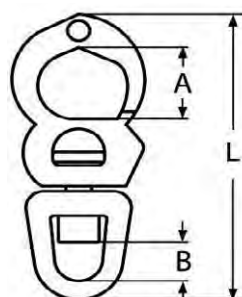

Informacje techniczne

Nr	A	B	L	≈ Obciążenie niszczące w N
54156.085.001	18	12	85	15 000
54156.105.001	24	14	105	25 000
54156.125.001	27	18	125	35 000



54156

54156	Szekla zatrzaskowe krętkowa	MH11
Materiał	Stal nierdzewna A4	
		

L	☒	Kod artykułu	L	☒	Kod artykułu	L	☒	Kod artykułu
85MM*	1	54156.085.001	105MM*	1	54156.105.001	125MM*	1	54156.125.001

Informacje techniczne

Nr	A	B	C	H	L	ø
54158.050.001	13	13	-	-	60	5
54158.060.001	15	15	-	-	65	6
54158.080.001	20	22	-	-	90	8
54158.100.001	24	27	-	-	115	10
54158.130.001	32	35	-	-	154	13
54158.160.001	39	45	-	-	188	16
54158.190.001	41	50	-	-	231	19
54159.060.001	11	12	-	-	66	6
54159.080.001	16	16	-	-	94	8
54159.100.001	22	22	-	-	118	10
54159.130.001	28	28	-	-	152	13
54159.160.001	37	34	-	-	188	16
54159.190.001	45	38	-	-	229	19
54160.050.001	11	10	-	-	60	5
54160.060.001	11	12	-	-	66	6
54160.080.001	16	16	-	-	94	8
54160.100.001	22	20	-	-	118	10
54160.130.001	28	28	-	-	152	13
54160.160.001	37	34	-	-	188	16
54160.190.001	45	38	-	-	229	19
54161.050.001	-	10	11	-	60	5
54161.060.001	-	12	11	-	66	6
54161.080.001	-	16	16	-	94	8
54161.100.001	-	20	22	-	118	10
54161.130.001	-	26	28	-	152	13
54161.160.001	-	34	37	-	188	16
54161.190.001	-	38	45	-	229	19
54162.120.047	12	-	-	10	47	5
54162.140.055	14	-	-	11	55	6
54163.050.001	11	10	-	-	60	5
54163.060.001	12	12	-	-	66	6
54163.080.001	16	16	-	-	92	8
54163.100.001	22	20	-	-	118	10
54163.130.001	28	26	-	-	152	13
54163.160.001	34	32	-	-	188	16
54163.190.001	44	38	-	-	229	19

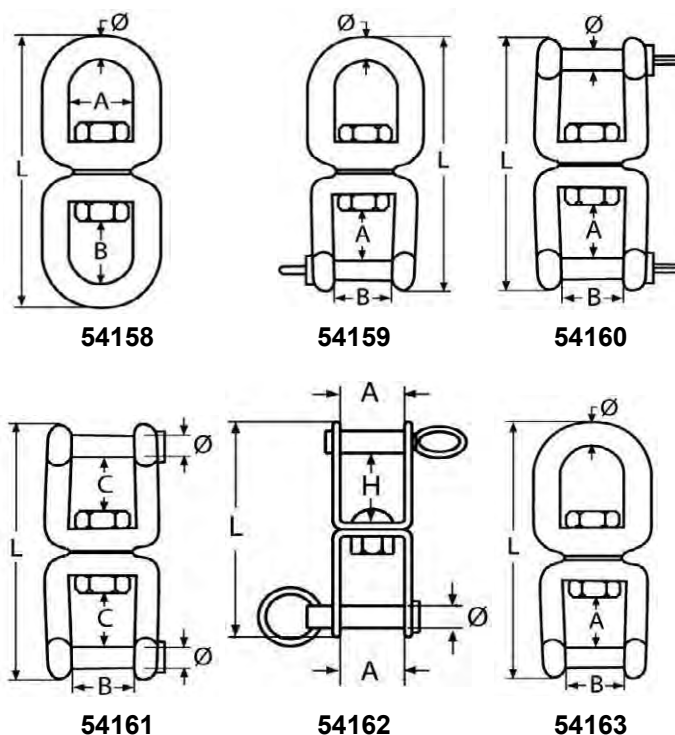

Grupy katalogowe

Material	Kod	Strona
St.St. A4	54158	13-29
St.St. A4	54159	13-29
St.St. A4	54160	13-30
St.St. A4	54161	13-30
St.St. A2	54162	13-30
St.St. A4	54163	13-30

54158 Krętlik oczko-oczko

MH11

Material Stal nierdzewna A4



Ø	☒	Kod artykułu	Ø	☒	Kod artykułu	Ø	☒	Kod artykułu
5MM*	10	54158.050.001	10MM*	5	54158.100.001	16MM*	1	54158.160.001
6MM*	10	54158.060.001	13MM*	1	54158.130.001	19MM*	1	54158.190.001
8MM*	10	54158.080.001						

54159 Szekła krętlikowa, oczko-widelki

MH11

Material Stal nierdzewna A4



Ø	☒	Kod artykułu	Ø	☒	Kod artykułu	Ø	☒	Kod artykułu
6MM*	10	54159.060.001	10MM*	5	54159.100.001	16MM*	1	54159.160.001
8MM*	10	54159.080.001	13MM*	1	54159.130.001	19MM*	1	54159.190.001

54160 Szekla krętlkowa, widełki-widełki MH11



Materiał Stal nierdzewna A4

Ø	☒	Kod artykułu	Ø	☒	Kod artykułu	Ø	☒	Kod artykułu
5MM*	10	54160.050.001	10MM*	5	54160.100.001	16MM*	1	54160.160.001
6MM*	10	54160.060.001	13MM*	1	54160.130.001	19MM*	1	54160.190.001
8MM*	10	54160.080.001						

54161 Szekla krętlkowa, widełki-widełki, skręcana MH11

Materiał Stal nierdzewna A4

Ø	☒	Kod artykułu	Ø	☒	Kod artykułu	Ø	☒	Kod artykułu
5MM*	10	54161.050.001	10MM*	5	54161.100.001	16MM*	1	54161.160.001
6MM*	10	54161.060.001	13MM*	1	54161.130.001	19MM*	1	54161.190.001
8MM*	10	54161.080.001						

54162 Szekla krętlkowa, płaska, widełki-widełki MH11



Materiał Stal nierdzewna A2



A x L	☒	Kod artykułu	A x L	☒	Kod artykułu
12X47*	10	54162.120.047	14X55*	10	54162.140.055

54163 Szekla krętlkowa, oczko-widełki MH11

Materiał Stal nierdzewna A4

Ø	☒	Kod artykułu	Ø	☒	Kod artykułu	Ø	☒	Kod artykułu
5MM*	10	54163.050.001	10MM*	5	54163.100.001	16MM*	1	54163.160.001
6MM*	10	54163.060.001	13MM*	1	54163.130.001	19MM*	1	54163.190.001
8MM*	10	54163.080.001						

Hak zatrzaskowy Waterski



Informacje techniczne

Nr	B	C	L	≈ Obciążenie niszczące w N
54164.060.001	37	16	60	8 000

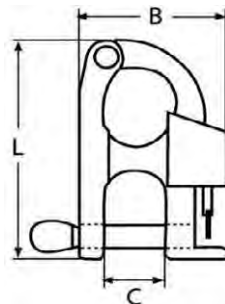

54164

54164	Hak zatrzaskowy Waterski	MH11
Materiał	Stal nierdzewna A4	

L		Kod artykułu
60MM*	5	54164.060.001

Karabińczyk z aluminium



Informacje techniczne

Nr	A	A ₁	B	C	D	L	ø	≈ Obciążenie niszczące w N
54165.050.050	10	6	-	8	-	50	5	1 000
54165.060.060	11	8	-	9	-	60	6	1 600
54165.080.080	13	8	-	9	-	80	8	3 500
54167.110.116	-	-	64	22	-	116	11	22 000
54168.130.001	-	-	80	21	21	130	-	20 000
54169.120.120	-	-	80	25	-	120	12	24 000
54169.140.190	-	-	104	46	-	190	14	26 000

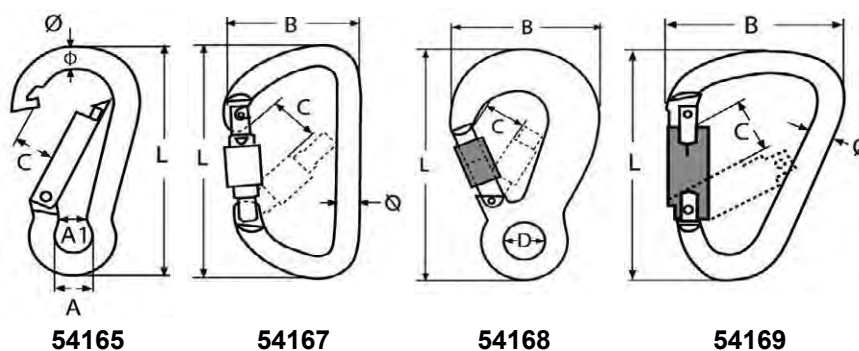

Grupy katalogowe

Material	Kod	Strona
Al	54165	13-32
Al	54167	13-32
Al	54168	13-33
Al	54169	13-33

54165	Karabińczyk - różne kolory	MH11
Material	Aluminium	

ø x L	☒	Kod artykułu	ø x L	☒	Kod artykułu	ø x L	☒	Kod artykułu
5X50MM*	10	54165.050.050	6X60MM	10	54165.060.060	8X80MM*	10	54165.080.080

54167	Karabińczyk z jednopunktowym zabezpieczeniem	MH11
Material	Aluminium	

ø x L	☒	Kod artykułu
11X116MM*	5	54167.110.116

54168	Karabińczyk zabezpieczającym	MH11
Materiał	Aluminium	

L	✉ Kod artykułu
130MM*	5 54168.130.001

54169	Karabińczyk z jednopunktowym zabezpieczeniem	MH11
Materiał	Aluminium	

ø x L	✉ Kod artykułu	ø x L	✉ Kod artykułu
12X120MM*	5 54169.120.120	14X190MM*	5 54169.140.190

Ósemka oczkowa



Informacje techniczne						
Nr	A	B	C	E	L	≈ Obciążenie niszczące w N
54170.145.001	51	26	48	76	145	30 000

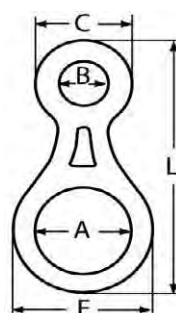

54170

54170	Ósemka oczkowa	MH11
Materiał	Aluminium	

L	✉ Kod artykułu
145MM*	5 54170.145.001

Karabińczyk Simplex



Informacje techniczne

Nr	C	D	E	F	L
54166.030.001	3.3	1.4	2.8	3.6	30
54166.040.001	4.5	1.9	4.1	5.0	40
54166.050.001	5.4	2.3	4.6	6.4	50
54166.060.001	6.2	2.8	5.6	7.1	60

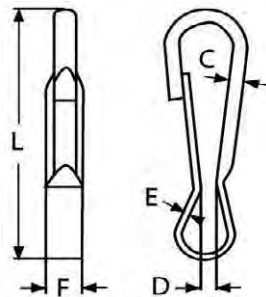

54166

54166	Karabińczyk Simplex	MH11
Materiał	Stal nierdzewna A2	
		 

L	☒	Kod artykułu	L	☒	Kod artykułu	L	☒	Kod artykułu
30MM	100	54166.030.001	50MM*	50	54166.050.001	60MM*	50	54166.060.001
40MM*	100	54166.040.001						

Zacisk do lin



Informacje techniczne

Nr	B	D	L	WR-ø
54171.120.001	78	22	122	12
54171.160.001	78	22	122	16

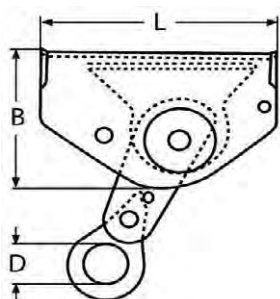

54171

54171	Zacisk do lin	MH11
Materiał	Stal nierdzewna A2	

WR-ø	☒	Kod artykułu	WR-ø	☒	Kod artykułu
12MM*	1	54171.120.001	16MM*	1	54171.160.001

Ściągacz do lin



Informacje techniczne

Nr	A	D	Gwint	L ₁	L ₂	WR-ø
54200.040.001	5.5	4	M4	110	170	-
54200.050.001	6.5	5	M5	130	190	-
54200.060.001	7.5	6	M6	150	220	-
54200.080.001	11	8	M8	165	240	-
54200.100.001	12	9	M10	190	280	-
54200.120.001	14	12	M12	245	360	-
54200.140.001	15	12	M14	270	390	-
54200.160.001	17	16	M16	310	450	-
54200.200.001	20	19	M20	360	510	-
54201.050.025	6	5	M5	155	215	2.5
54201.060.030	7.5	6	M6	175	245	3
54201.060.040	7.5	6	M6	185	255	4
54201.080.040	11	8	M8	200	275	4
54201.080.050	11	8	M8	205	280	5
54201.100.050	12	9	M10	230	320	5
54201.100.060	12	9	M10	245	355	6
54201.120.060	14	12	M12	285	400	6
54201.120.080	14	12	M12	305	420	8
54201.140.070	15	15	M14	315	435	7
54201.160.080	17	17	M16	360	500	8
54201.160.100	17	16	M16	370	510	10
54201.200.100	20	20	M20	410	560	10
54201.200.120	20	20	M20	410	560	12
54202.060.030	7	6	M6	180	250	3
54202.060.040	7	6	M6	190	260	4
54202.080.040	10	8	M8	210	285	4
54202.080.050	10	8	M8	215	290	5
54202.100.050	12	9	M10	250	340	5
54202.100.060	12	9	M10	265	355	6
54202.120.060	13	12	M12	300	410	6
54202.120.080	13	12	M12	320	430	8
54202.140.070	15	14	M14	328	453	7
54202.160.080	17	16	M16	390	530	8
54202.160.100	17	16	M16	400	540	10
54202.200.100	20	19	M20	450	590	10

• WR-ø = średnica liny pasująca.

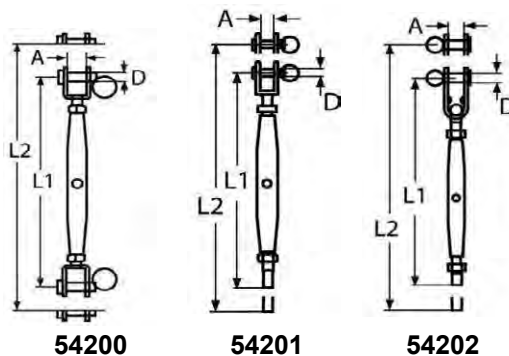

Grupy katalogowe

Material	Kod	Strona
St.St. A4	54200	13-37
St.St. A4	54201	13-37
St.St. A4	54202	13-37

54200 Ściągacz widełki-widelki				MH11				
Materiał		Stal nierdzewna A4						
Gwint	☒	Kod artykułu	Gwint	☒	Kod artykułu	Gwint	☒	Kod artykułu
M4*	10	54200.040.001	M8*	10	54200.080.001	M14*	1	54200.140.001
M5*	10	54200.050.001	M10	5	54200.100.001	M16*	1	54200.160.001
M6*	10	54200.060.001	M12*	5	54200.120.001	M20*	1	54200.200.001

54201 Ściągacz widełki-końcówka				MH11				
Materiał		Stal nierdzewna A4						
Gwint / WR-ø	☒	Kod artykułu	Gwint / WR-ø	☒	Kod artykułu	Gwint / WR-ø	☒	Kod artykułu
M5/2,5MM*	10	54201.050.025	M10/5MM*	5	54201.100.050	M16/8MM*	1	54201.160.080
M6/3MM*	10	54201.060.030	M10/6MM*	5	54201.100.060	M16/10MM*	1	54201.160.100
M6/4MM*	10	54201.060.040	M12/6MM*	5	54201.120.060	M20/10MM*	1	54201.200.100
M8/4MM*	10	54201.080.040	M12/8MM*	5	54201.120.080	M20/12MM*	1	54201.200.120
M8/5MM*	10	54201.080.050	M14/7MM*	1	54201.140.070			

54202 Ściągacz widełki przegubowe-końcówka				MH11				
Materiał		Stal nierdzewna A4						
Gwint / WR-ø	☒	Kod artykułu	Gwint / WR-ø	☒	Kod artykułu	Gwint / WR-ø	☒	Kod artykułu
M6/3MM*	5	54202.060.030	M10/5MM*	5	54202.100.050	M14/7MM*	1	54202.140.070
M6/4MM*	5	54202.060.040	M10/6MM*	5	54202.100.060	M16/8MM*	1	54202.160.080
M8/4MM*	5	54202.080.040	M12/6MM*	5	54202.120.060	M16/10MM*	1	54202.160.100
M8/5MM*	5	54202.080.050	M12/8MM*	5	54202.120.080	M20/10MM*	1	54202.200.100

Hak poślizgowy z pierścieniem



Informacje techniczne

Nr	D ₁	L	ø	ø łba nitu
54203.132.001	5.1	132	5	7.1
54203.142.001	6.2	142	6	9.6
54203.192.001	8.5	192	8	11.3
54203.235.001	13.0	235	12	14.4

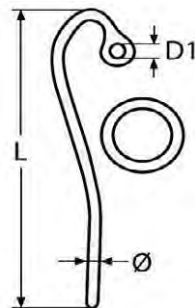

54203

54203 Hak poślizgowy z pierścieniem

MH11

Materiał Stal nierdzewna A4



L	☒	Kod artykułu	L	☒	Kod artykułu	L	☒	Kod artykułu
132MM*	5	54203.132.001	192MM*	2	54203.192.001	235MM*	2	54203.235.001
142MM*	5	54203.142.001						

Nakrętka ściągacza pełna



Informacje techniczne

Nr	d	L
54204.050.001	M5	80
54204.060.001	M6	95
54204.080.001	M8	105
54204.100.001	M10	125
54204.120.001	M12	150
54204.140.001	M14	165
54204.160.001	M16	190
54204.200.001	M20	200

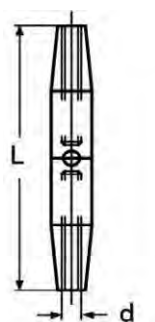

54204

54204 Nakrętka ściągacza pełna

MH11

Materiał Stal nierdzewna A4



d	☒	Kod artykułu	d	☒	Kod artykułu	d	☒	Kod artykułu
M5*	10	54204.050.001	M10*	5	54204.100.001	M16*	1	54204.160.001
M6*	10	54204.060.001	M12*	5	54204.120.001	M20*	1	54204.200.001
M8*	10	54204.080.001	M14*	1	54204.140.001			



Informacje techniczne

Nr	A	D	Gwint	L	L ₁	L ₂	WR-ø
54206.050.001	6.5	5	M5	-	120	70	-
54206.060.001	7.5	6	M6	-	140	90	-
54206.080.001	11	8	M8	-	180	120	-
54206.100.001	12	9	M10	-	220	150	-
54206.120.001	14	12	M12	-	300	200	-
54206.140.001	15	12	M14	-	325	220	-
54206.160.001	17	16	M16	-	375	250	-
54206.200.001	20	19	M20	-	450	300	-
54207.050.001	6.5	5	M5	-	135	195	-
54207.060.001	7.5	6	M6	-	160	230	-
54207.080.001	11	8	M8	-	180	255	-
54207.100.001	12	9	M10	-	210	300	-
54207.120.001	14	12	M12	-	270	380	-
54207.140.001	15	12	M14	-	295	415	-
54207.160.001	17	16	M16	-	340	480	-
54208.050.025	6.5	5	M5	-	155	215	2.5
54208.060.030	7.5	6	M6	-	180	250	3
54208.060.040	7.5	6	M6	-	190	260	4
54208.080.040	11	8	M8	-	210	285	4
54208.080.050	11	8	M8	-	215	290	5
54208.100.050	12	9	M10	-	240	330	5
54208.100.060	12	9	M10	-	255	345	6
54208.120.060	14	12	M12	-	300	410	6
54208.120.080	14	12	M12	-	320	430	8
54208.140.070	15	12	M14	-	330	450	7
54208.160.080	17	16	M16	-	370	510	8
54208.160.100	17	16	M16	-	380	520	10
54209.060.001	-	-	M6	90	-	-	-
54209.080.001	-	-	M8	120	-	-	-
54209.100.001	-	-	M10	150	-	-	-
54209.120.001	-	-	M12	200	-	-	-
54209.160.001	-	-	M16	250	-	-	-
54209.200.001	-	-	M20	300	-	-	-

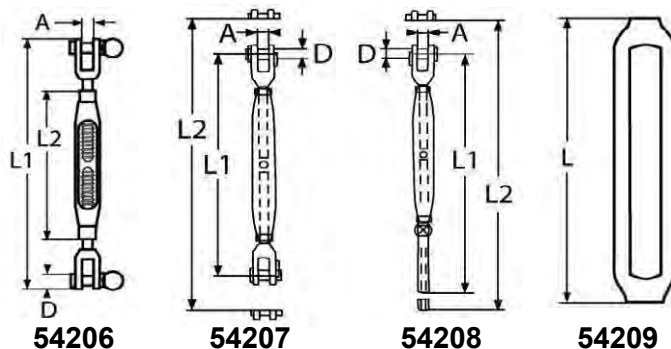

Grupy katalogowe

Material	Kod	Strona
St.St. A4	54206	13-41
St.St. A4	54207	13-41
St.St. A4	54208	13-41
St.St. A4	54209	13-41

54206 Ściągacz widelki-widelki MH11
Material Stal nierdzewna A4

Gwint	☒	Kod artykułu	Gwint	☒	Kod artykułu	Gwint	☒	Kod artykułu
M5*	10	54206.050.001	M10*	5	54206.100.001	M16*	1	54206.160.001
M6*	10	54206.060.001	M12*	5	54206.120.001	M20*	1	54206.200.001
M8*	10	54206.080.001	M14*	1	54206.140.001			

54207 Ściągacz widelki-widelki, widelki toczone MH11
Material Stal nierdzewna A4

Gwint	☒	Kod artykułu	Gwint	☒	Kod artykułu	Gwint	☒	Kod artykułu
M5*	10	54207.050.001	M10*	5	54207.100.001	M14*	1	54207.140.001
M6*	10	54207.060.001	M12*	5	54207.120.001	M16*	1	54207.160.001
M8*	10	54207.080.001						

54208 Ściągacz widelki-końcówka, widelki toczone MH11
Material Stal nierdzewna A4

Gwint / WR-ø	☒	Kod artykułu	Gwint / WR-ø	☒	Kod artykułu	Gwint / WR-ø	☒	Kod artykułu
M5/2,5MM*	10	54208.050.025	M8/5MM*	10	54208.080.050	M12/8MM*	5	54208.120.080
M6/3MM*	10	54208.060.030	M10/5MM*	5	54208.100.050	M14/7MM*	1	54208.140.070
M6/4MM*	10	54208.060.040	M10/6MM*	5	54208.100.060	M16/8MM*	1	54208.160.080
M8/4MM*	10	54208.080.040	M12/6MM*	5	54208.120.060	M16/10MM*	1	54208.160.100

54209 Nakrętka ściągacza MH11
Material Stal nierdzewna A4



Gwint	☒	Kod artykułu	Gwint	☒	Kod artykułu	Gwint	☒	Kod artykułu
M6*	10	54209.060.001	M10*	5	54209.100.001	M16*	1	54209.160.001
M8*	10	54209.080.001	M12*	5	54209.120.001	M20*	1	54209.200.001

Ściągacz do lin

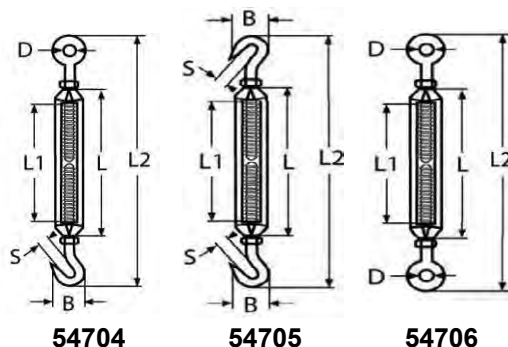

Informacje techniczne

Nr	B	D	Gwint	L	L ₁	L ₂	S	≈ Obciążenie niszczące w N
54704.060.001	16	10	M6	90	66	160	10	3 200
54704.080.001	20	14	M8	120	94	200	11	5 600
54704.100.001	28	16	M10	150	120	240	12	8 800
54704.120.001	36	18	M12	200	168	300	14	12 000
54704.160.001	40	26	M16	250	210	390	16	24 000
54704.200.001	50	30	M20	300	245	440	18	36 000
54705.060.001	16	10	M6	90	66	160	10	3 200
54705.080.001	20	14	M8	120	94	200	11	5 600
54705.100.001	28	16	M10	150	120	240	12	8 800
54705.120.001	36	18	M12	200	168	300	14	12 000
54705.160.001	40	26	M16	250	210	390	16	24 000
54705.200.001	50	30	M20	300	245	440	18	36 000
54706.060.001	16	10	M6	90	66	160	10	3 200
54706.080.001	20	14	M8	120	94	200	11	5 600
54706.100.001	28	16	M10	150	120	240	12	8 800
54706.120.001	36	18	M12	200	168	300	14	12 000
54706.160.001	40	26	M16	250	210	390	16	24 000
54706.200.001	50	30	M20	300	245	440	18	36 000



Grupy katalogowe

Material	Kod	Strona
St.St. A4	54704	13-42
St.St. A4	54705	13-43
St.St. A4	54706	13-43

54704 Ściągacz ucho-hak

MH11

Material Stal nierdzewna A4



Gwint	☒	Kod artykułu	Gwint	☒	Kod artykułu	Gwint	☒	Kod artykułu
M6*	1	54704.060.001	M10*	1	54704.100.001	M16*	1	54704.160.001
M8*	1	54704.080.001	M12*	1	54704.120.001	M20*	1	54704.200.001

54705	Ściągacz hak-hak	MH11
Materiał	Stal nierdzewna A4	

Gwint	☒	Kod artykułu	Gwint	☒	Kod artykułu	Gwint	☒	Kod artykułu
M6*	1	54705.060.001	M10*	1	54705.100.001	M16*	1	54705.160.001
M8*	1	54705.080.001	M12*	1	54705.120.001	M20*	1	54705.200.001

54706	Ściągacz ucho-ucho	MH11
Materiał	Stal nierdzewna A4	

Gwint	☒	Kod artykułu	Gwint	☒	Kod artykułu	Gwint	☒	Kod artykułu
M6*	1	54706.060.001	M10*	1	54706.100.001	M16*	1	54706.160.001
M8*	1	54706.080.001	M12*	1	54706.120.001	M20*	1	54706.200.001

Końcówka do zawalcowania



Informacje techniczne

Nr	A	D	D ₁	Gwint	H	K	L	L ₁	L ₂	NV	WR-ø
54210.050.025	-	-	-	M5	-	-	-	40	86	4	2.5
54210.060.030	-	-	-	M6	-	-	-	48	100	5	3
54210.060.040	-	-	-	M6	-	-	-	48	110	6	4
54210.080.040	-	-	-	M8	-	-	-	57	117	6	4
54210.080.050	-	-	-	M8	-	-	-	57	124	7	5
54210.100.050	-	-	-	M10	-	-	-	63	130	7	5
54210.100.060	-	-	-	M10	-	-	-	63	145	10	6
54210.120.060	-	-	-	M12	-	-	-	80	162	10	6
54210.120.080	-	-	-	M12	-	-	-	80	180	14	8
54210.140.070	-	-	-	M14	-	-	-	90	180	12	7
54210.160.080	-	-	-	M16	-	-	-	100	200	14	8
54210.160.100	-	-	-	M16	-	-	-	100	210	15	10
54210.200.100	-	-	-	M20	-	-	-	119	230	15	10
54210.200.120	-	-	-	M20	-	-	-	120	245	17	12
54210.220.140	-	-	-	M22	-	-	-	140	308	22	14
54210.240.160	-	-	-	M24	-	-	-	170	363	24	16
54211.050.025	-	-	-	M5	-	-	-	40	86	4	2.5
54211.060.030	-	-	-	M6	-	-	-	48	100	5	3
54211.060.040	-	-	-	M6	-	-	-	48	110	6	4
54211.080.040	-	-	-	M8	-	-	-	57	117	6	4
54211.080.050	-	-	-	M8	-	-	-	57	124	7	5
54211.100.050	-	-	-	M10	-	-	-	63	130	7	5
54211.100.060	-	-	-	M10	-	-	-	63	145	10	6
54211.120.060	-	-	-	M12	-	-	-	80	162	10	6
54211.120.080	-	-	-	M12	-	-	-	80	180	14	8
54211.140.070	-	-	-	M14	-	-	-	90	180	12	7
54211.160.080	-	-	-	M16	-	-	-	100	200	14	8
54211.160.100	-	-	-	M16	-	-	-	100	210	15	10
54211.200.100	-	-	-	M20	-	-	-	119	230	15	10
54211.200.120	-	-	-	M20	-	-	-	120	245	17	12
54212.030.001	-	6	-	-	8	5	97	48	38	-	3
54212.040.001	-	8	-	-	10	6	115	54	45	-	4
54212.050.001	-	10	-	-	10	7	128	61	52	-	5

Informacje techniczne

Nr	A	D	D ₁	Gwint	H	K	L	L ₁	L ₂	NV	WR-ø
54212.060.001	-	12	-	-	10	10	162	79	63	-	6
54213.030.001	-	6	-	-	8	5	97	48	38	-	3
54213.040.001	-	8	-	-	10	6	115	54	45	-	4
54213.050.001	-	10	-	-	10	7	128	61	52	-	5
54213.060.001	-	12	-	-	10	10	162	79	63	-	6
54214.050.001	40	4.4	-	M5	-	-	85	-	-	-	-
54214.060.001	45	5.2	-	M6	-	-	100	-	-	-	-
54214.080.001	52	7.0	-	M8	-	-	112	-	-	-	-
54214.100.001	62	8.8	-	M10	-	-	127	-	-	-	-
54214.120.001	75	10.7	-	M12	-	-	140	-	-	-	-
54214.140.001	82	12.5	-	M14	-	-	150	-	-	-	-
54214.160.001	95	14.2	-	M16	-	-	170	-	-	-	-
54214.200.001	105	18.1	-	M20	-	-	185	-	-	-	-
54215.050.001	40	4.4	-	M5	-	-	85	-	-	-	-
54215.060.001	45	5.2	-	M6	-	-	100	-	-	-	-
54215.080.001	52	7.0	-	M8	-	-	112	-	-	-	-
54215.100.001	62	8.8	-	M10	-	-	127	-	-	-	-
54215.120.001	75	10.7	-	M12	-	-	140	-	-	-	-
54215.140.001	82	12.5	-	M14	-	-	150	-	-	-	-
54215.160.001	95	14.2	-	M16	-	-	170	-	-	-	-
54215.200.001	105	18.1	-	M20	-	-	185	-	-	-	-
54216.025.001	-	5.4	5.5	-	-	-	48.5	-	-	-	2.5
54216.030.001	-	6.5	6.35	-	-	-	55	-	-	-	3
54216.040.001	-	8.5	7.5	-	-	-	65	-	-	-	4
54216.050.001	-	10.5	9.0	-	-	-	80	-	-	-	5
54216.060.001	-	12.5	12.5	-	-	-	94	-	-	-	6
54216.070.001	-	12.7	14	-	-	-	105	-	-	-	7
54216.080.001	-	14.5	16.0	-	-	-	124	-	-	-	8
54216.100.001	-	16.4	17.8	-	-	-	142	-	-	-	10
54216.120.001	-	19.3	19.5	-	-	-	160	-	-	-	12

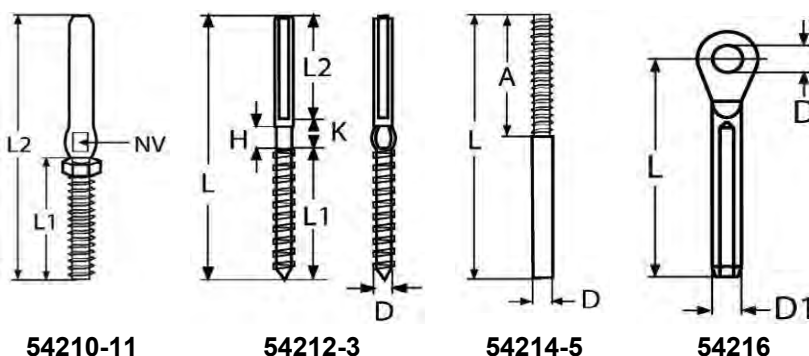

Grupy katalogowe

Material	Kod	Strona
St.St. A4	54210	13-44
St.St. A4	54211	13-45
St.St. A4	54212	13-45
St.St. A4	54213	13-45
St.St. A4	54214	13-45
St.St. A4	54215	13-45
St.St. A4	54216	13-46

54210 Końcówka z prawym gwintem z nakrętką, prawa

MH11

Material Stal nierdzewna A4





Gwint / WR-ø	☒	Kod artykułu	Gwint / WR-ø	☒	Kod artykułu	Gwint / WR-ø	☒	Kod artykułu
M5/2,5MM*	10	54210.050.025	M8/5MM*	10	54210.080.050	M12/8MM*	5	54210.120.080
M6/3MM*	10	54210.060.030	M10/5MM*	5	54210.100.050	M14/7MM*	1	54210.140.070
M6/4MM*	10	54210.060.040	M10/6MM*	5	54210.100.060	M16/8MM*	1	54210.160.080
M8/4MM*	10	54210.080.040	M12/6MM*	5	54210.120.060	M16/10MM*	1	54210.160.100

54210 Końcówka z prawym gwintem z nakrętką, prawa

Gwint / WR- \varnothing	☒	Kod artykułu	Gwint / WR- \varnothing	☒	Kod artykułu
M20/10MM*	1	54210.200.100	M22/14MM*	1	54210.220.140
M20/12MM*	1	54210.200.120	M24/16MM*	1	54210.240.160

54211 Końcówka gwintowana z nakrętką, z lewym gwintem
MH11

Materiał Stal nierdzewna A4

Gwint / WR- \varnothing	☒	Kod artykułu	Gwint / WR- \varnothing	☒	Kod artykułu	Gwint / WR- \varnothing	☒	Kod artykułu
M5/2,5MM*	10	54211.050.025	M10/5MM*	5	54211.100.050	M16/8MM*	1	54211.160.080
M6/3MM*	10	54211.060.030	M10/6MM*	5	54211.100.060	M16/10MM*	1	54211.160.100
M6/4MM*	10	54211.060.040	M12/6MM*	5	54211.120.060	M20/10MM*	1	54211.200.100
M8/4MM*	10	54211.080.040	M12/8MM*	5	54211.120.080	M20/12MM*	1	54211.200.120
M8/5MM*	10	54211.080.050	M14/7MM*	1	54211.140.070			

54212 Końcówka z gwintem do drewna, z prawym gwintem
MH11

Materiał Stal nierdzewna A4



WR- \varnothing	☒	Kod artykułu	WR- \varnothing	☒	Kod artykułu	WR- \varnothing	☒	Kod artykułu
3MM*	10	54212.030.001	5MM*	5	54212.050.001	6MM*	5	54212.060.001
4MM*	10	54212.040.001						

54213 Końcówka z gwintem do drewna, z lewym gwintem
MH11

Materiał Stal nierdzewna A4



WR- \varnothing	☒	Kod artykułu	WR- \varnothing	☒	Kod artykułu	WR- \varnothing	☒	Kod artykułu
3MM*	10	54213.030.001	5MM*	5	54213.050.001	6MM*	5	54213.060.001
4MM*	10	54213.040.001						

54214 Końcówki do przyspawania, z prawym gwintem
MH11

Materiał Stal nierdzewna A4



Gwint	☒	Kod artykułu	Gwint	☒	Kod artykułu	Gwint	☒	Kod artykułu
M5*	10	54214.050.001	M10*	5	54214.100.001	M16*	1	54214.160.001
M6*	10	54214.060.001	M12*	5	54214.120.001	M20*	1	54214.200.001
M8*	10	54214.080.001	M14*	1	54214.140.001			

54215 Końcówka do przyspawania, z lewym gwintem
MH11

Materiał Stal nierdzewna A4



Gwint	☒	Kod artykułu	Gwint	☒	Kod artykułu	Gwint	☒	Kod artykułu
M5*	10	54215.050.001	M10*	5	54215.100.001	M16*	1	54215.160.001
M6*	10	54215.060.001	M12*	5	54215.120.001	M20*	1	54215.200.001
M8*	10	54215.080.001	M14*	1	54215.140.001			

54216	Koncówka oczkowa	MH11
Materiał	Stal nierdzewna A4	
		

WR- ϕ	☒	Kod artykułu	WR- ϕ	☒	Kod artykułu	WR- ϕ	☒	Kod artykułu
2,5MM*	10	54216.025.001	5MM*	5	54216.050.001	8MM*	1	54216.080.001
3MM	10	54216.030.001	6MM*	5	54216.060.001	10MM*	1	54216.100.001
4MM*	10	54216.040.001	7MM*	5	54216.070.001	12MM*	1	54216.120.001

Koncówki hakowe T do zawalcowania



Informacje techniczne

Nr	B	D	D ₁	L	L ₁	WR- ϕ
54217.030.001	-	-	-	85	-	3
54217.040.001	-	-	-	100	-	4
54217.050.001	-	-	-	115	-	5
54217.060.001	-	-	-	140	-	6
54217.070.001	-	-	-	145	-	7
54217.080.001	-	-	-	185	-	8
54217.100.001	-	-	-	215	-	10
54218.040.001	27	5.0	9.9	88	27	4
54218.050.001	27	5.0	9.9	88	27	5
54218.060.001	39	6.3	15.6	122	35	6
54218.070.001	39	6.4	15.9	122	35	7
54218.080.001	39	6.5	18.8	151	41	8
54218.100.001	39	6.5	18.8	151	41	10

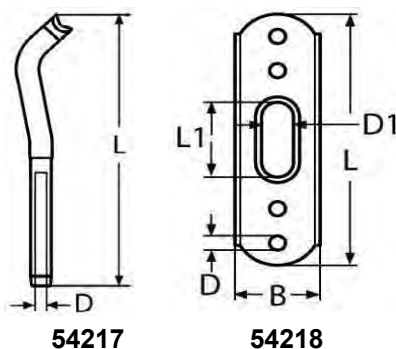

Grupy katalogowe

Materiał	Kod	Strona
St.St. A4	54217	13-47
St.St. A4	54218	13-47

54217	Końcówki hakowe T do zawalcowania	MH11
Materiał	Stal nierdzewna A4	
		

WR-ø	☒	Kod artykułu	WR-ø	☒	Kod artykułu	WR-ø	☒	Kod artykułu
3MM*	1	54217.030.001	6MM*	1	54217.060.001	8MM*	1	54217.080.001
4MM*	1	54217.040.001	7MM*	1	54217.070.001	10MM*	1	54217.100.001
5MM*	1	54217.050.001						

54218	Zaczep końcówki hakowej typu T	MH11
Materiał	Stal nierdzewna A4	
		

WR-ø	☒	Kod artykułu	WR-ø	☒	Kod artykułu	WR-ø	☒	Kod artykułu
4MM*	1	54218.040.001	6MM*	1	54218.060.001	8MM*	1	54218.080.001
5MM*	1	54218.050.001	7MM*	1	54218.070.001	10MM*	1	54218.100.001

Końcówka widelkowa do zawalcowania



Informacje techniczne						
Nr	A	d	D	H	L ₁	L ₂
54219.030.001	7	-	6	15	-	-
54219.040.001	10	-	8	20	-	-
54219.050.001	12	-	9	25	-	-
54219.060.001	13	-	12	30	-	-
54219.080.001	17	-	16	40	-	-
54219.100.001	20	-	19	45	-	-
54220.025.001	6.5	-	5	-	-	-
54220.030.001	7.5	-	6	-	-	-
54220.040.001	11	-	8	-	-	-
54220.050.001	12	-	9	-	-	-
54220.060.001	14	-	12	-	-	-
54220.070.001	15	-	12	-	-	-
54220.080.001	17	-	16	-	-	-
54220.100.001	20	-	18	-	-	-
54220.120.001	23	-	19	-	-	-
54220.140.001	30	-	22	-	-	-
54220.160.001	30	-	25	-	-	-
54221.030.001	7.5	-	6	-	73	-
54221.040.001	11	-	8	-	86	-
54221.050.001	12	-	9	-	100	-
54221.060.001	14	-	12	-	128	-
54221.070.001	15	-	12	-	135	-
54221.080.001	17	-	16	-	155	-
54223.050.001	6	M5	5	13	62	42
54223.060.001	7	M6	6	15	77	48
54223.080.001	10	M8	8	20	94	56
54223.100.001	12	M10	9	25	115	67
54223.120.001	13	M12	12	30	136	81
54223.140.001	15	M14	14	35	140	89
54223.160.001	17	M16	16	40	163	103
54223.200.001	20	M20	19	45	198	115
54224.050.001	6	M5	5	13	62	42
54224.060.001	7	M6	6	15	77	48

Informacje techniczne

Nr	A	d	D	H	L ₁	L ₂
54224.080.001	10	M8	8	20	94	56
54224.100.001	12	M10	9	25	116	67
54224.120.001	13	M12	12	30	136	81
54224.140.001	15	M14	14	35	140	89
54224.160.001	17	M16	16	40	163	103
54224.200.001	20	M20	19	45	198	115

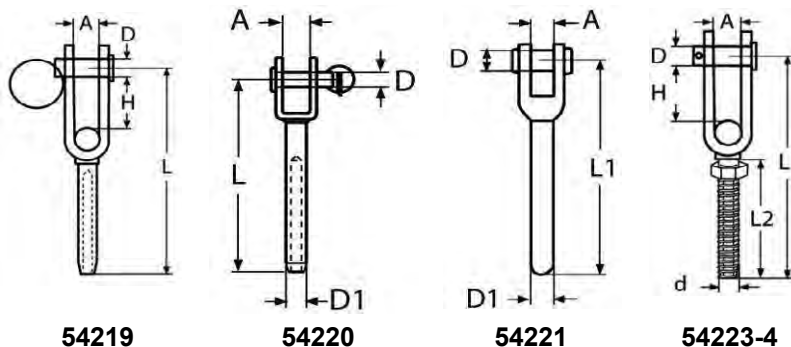

Grupy katalogowe

Material	Kod	Strona
St.St. A4	54219	13-48
St.St. A4	54220	13-48
St.St. A4	54221	13-48
St.St. A4	54223	13-49
St.St. A2	54224	13-49

54219 Końcówka kolankowa MH11

Material: Stal nierdzewna A4

WR-ø	☒	Kod artykułu	WR-ø	☒	Kod artykułu	WR-ø	☒	Kod artykułu
3MM*	5	54219.030.001	5MM*	5	54219.050.001	8MM*	1	54219.080.001
4MM*	5	54219.040.001	6MM*	5	54219.060.001	10MM*	1	54219.100.001

54220 Końcówka widełkowa MH11

Material: Stal nierdzewna A4

WR-ø	☒	Kod artykułu	WR-ø	☒	Kod artykułu	WR-ø	☒	Kod artykułu
2,5MM*	10	54220.025.001	6MM*	5	54220.060.001	12MM*	1	54220.120.001
3MM*	10	54220.030.001	7MM*	5	54220.070.001	14MM*	1	54220.140.001
4MM*	10	54220.040.001	8MM*	5	54220.080.001	16MM*	1	54220.160.001
5MM*	5	54220.050.001	10MM*	1	54220.100.001			

54221 Końcówka widełkowa, frezowana MH11

Material: Stal nierdzewna A4

WR-ø	☒	Kod artykułu	WR-ø	☒	Kod artykułu	WR-ø	☒	Kod artykułu
3MM*	10	54221.030.001	5MM*	5	54221.050.001	7MM*	5	54221.070.001
4MM*	10	54221.040.001	6MM*	5	54221.060.001	8MM*	5	54221.080.001

54223	Końcówka kolankowa z prawym gwintem	MH11
Materiał	Stal nierdzewna A4	
		 

d	☒	Kod artykułu	d	☒	Kod artykułu	d	☒	Kod artykułu
M5*	10	54223.050.001	M10*	5	54223.100.001	M16*	1	54223.160.001
M6*	10	54223.060.001	M12*	5	54223.120.001	M20*	1	54223.200.001
M8*	5	54223.080.001	M14*	1	54223.140.001			

54224	Końcówka kolankowa z lewym gwintem	MH11
Materiał	Stal nierdzewna A2	
		 

d	☒	Kod artykułu	d	☒	Kod artykułu	d	☒	Kod artykułu
M5*	10	54224.050.001	M10*	5	54224.100.001	M16*	1	54224.160.001
M6*	10	54224.060.001	M12*	5	54224.120.001	M20*	1	54224.200.001
M8*	5	54224.080.001	M14*	1	54224.140.001			



Końcówka do ściągacza linowego

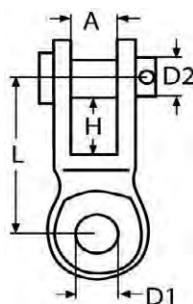

Informacje techniczne					
Nr	A	D ₁	D ₂	H	L
54222.050.001	6	5.5	5.2	7	22
54222.060.001	7	6.6	6.3	9	27
54222.080.001	10	8.5	8.3	10	31
54222.100.001	12	10.0	9.3	12	36
54222.120.001	13	13.0	12.4	17	50
54222.140.001	14	15.0	15.0	20	60
54222.160.001	15	16.5	17.0	29	80



54222

54222	Końcówka do ściągacza linowego	MH11
Materiał	Stal nierdzewna A4	
		

A	☒	Kod artykułu	A	☒	Kod artykułu	A	☒	Kod artykułu
6MM*	5	54222.050.001	12MM*	1	54222.100.001	14MM*	1	54222.140.001
7MM*	5	54222.060.001	13MM*	1	54222.120.001	15MM*	1	54222.160.001
10MM*	5	54222.080.001						

Mocowanie regulowane



Informacje techniczne

Nr	B	L	Śruba
54225.104.001	15	104	5
54226.100.001	15	100	5
54226.155.001	15	155	5
54226.200.001	15	200	5

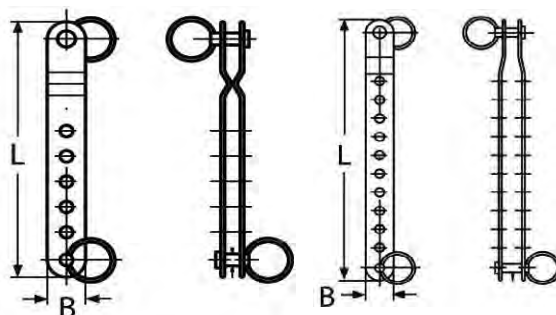



54225

54226

Grupy katalogowe

Materiał	Kod	Strona
St.St. A2	54225	13-50
St.St. A2	54226	13-51

54225	Mocowanie regulowane	MH11
Materiał	Stal nierdzewna A2	
		

L	☒	Kod artykułu
104MM*	5	54225.104.001

54226		Mocowanie regulowane		MH11	
Materiał		Stal nierdzewna A2			
L	✉ Kod artykułu	L	✉ Kod artykułu	L	✉ Kod artykułu
100MM*	5 54226.100.001	155MM*	5 54226.155.001	200MM*	5 54226.200.001

Pelikan hak z gwintem



Informacje techniczne				
Nr	d	D	L	≈ Obciążenie niszczące w N
54227.060.001	M6	18.5	75	12 000
54227.080.001	M8	27.0	100	15 000
54227.100.001	M10	35.0	144	35 000
54227.120.001	M12	39.0	150	35 000

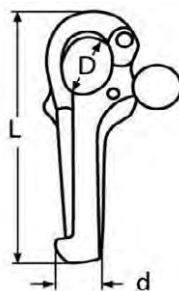

54227

54227		Pelikan hak z gwintem		MH11	
Materiał		Stal nierdzewna A4			
d	✉ Kod artykułu	d	✉ Kod artykułu	d	✉ Kod artykułu
6MM*	1 54227.060.001	10MM*	1 54227.100.001	12MM*	1 54227.120.001
8MM*	1 54227.080.001				

Pelikan hak



Informacje techniczne

Nr	D	L
54228.100.001	18	100
54228.150.001	22	150

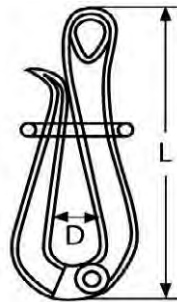

54228

54228	Pelikan hak	MH11
Materiał	Stal nierdzewna A4	
		

L	✉	Kod artykułu	L	✉	Kod artykułu
100MM*	5	54228.100.001	150MM*	5	54228.150.001

Końcówka skręcana



Informacje techniczne

Nr	B	C	d	D	H	L	WR-ø
54229.040.001	8	6.5	-	-	-	67	4
54229.050.001	10	8	-	-	-	80	5
54229.060.001	12	9	-	-	-	95	6
54229.080.001	14	10	-	-	-	119	8
54230.040.001	-	8	-	8	8	72	4
54230.050.001	-	10	-	10	10	82	5
54230.060.001	-	12	-	12	12	94	6
54230.080.001	-	14	-	14	14	116	8
54231.040.001	-	57	M8	-	-	100	4
54231.050.001	-	63	M10	-	-	117	5
54231.060.001	-	80	M12	-	-	145	6
54231.080.001	-	100	M16	-	-	182	8

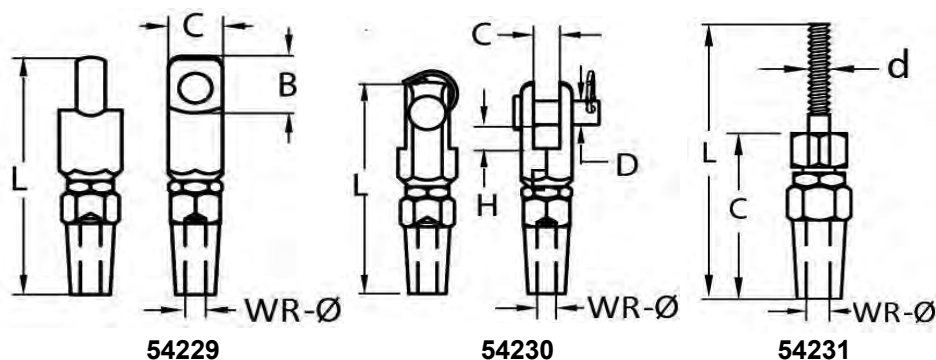

Grupy katalogowe

Material	Kod	Strona
St.St. A4	54229	13-53
St.St. A4	54230	13-53
St.St. A4	54231	13-54

54229 Końcówka skręcana oczkowa MH11

Material Stal nierdzewna A4

WR-ø	☒	Kod artykułu	WR-ø	☒	Kod artykułu	WR-ø	☒	Kod artykułu
4MM*	1	54229.040.001	6MM*	1	54229.060.001	8MM*	1	54229.080.001
5MM*	1	54229.050.001						

54230 Końcówka skręcana widelkowa MH11

Material Stal nierdzewna A4

WR-ø	☒	Kod artykułu	WR-ø	☒	Kod artykułu	WR-ø	☒	Kod artykułu
4MM*	1	54230.040.001	6MM*	1	54230.060.001	8MM*	1	54230.080.001
5MM*	1	54230.050.001						

54231	Końcówka skręcana prosta	MH11
Materiał	Stal nierdzewna A4	
		

WR-ø	☒	Kod artykułu	WR-ø	☒	Kod artykułu	WR-ø	☒	Kod artykułu
4MM*	1	54231.040.001	6MM*	1	54231.060.001	8MM*	1	54231.080.001
5MM*	1	54231.050.001						

Lina

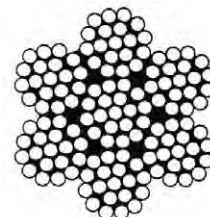

Informacje techniczne

Nr	Waga kg/m	WR-ø	≈ Obciążenie niszczące min. w N
54232.020.001	0.015	2	2 330
54232.030.001	0.035	3	4 690
54232.040.001	0.061	4	8 340
54232.050.001	0.096	5	13 000
54232.060.001	0.138	6	18 800
54232.070.001	0.187	7	25 500
54232.080.001	0.243	8	33 300
54232.100.001	0.381	10	52 100
54232.120.001	0.548	12	75 000
54232.140.001	0.764	14	102 000
54233.020.001	0.016	2	2 250
54233.030.001	0.035	3	5 070
54233.040.001	0.063	4	9 010
54233.050.001	0.098	5	14 100
54233.060.001	0.142	6	20 300
54233.070.001	0.193	7	27 600
54233.080.001	0.252	8	36 100
54233.100.001	0.303	10	56 300
54234.040.601	-	4/6	-
54234.040.701	-	4/7	-
54235.010.015	0.012	1/1.5	630
54235.012.020	0.014	1.25/2	880
54235.020.030	0.023	2/3	2 250
54235.030.040	0.044	3/4	5 070
54235.040.050	0.072	4/5	9 010
54235.050.070	0.117	5/7	14 100
54236.010.001	0.005	1	830
54236.020.001	0.02	2	3 300
54236.030.001	0.045	3	7 420
54236.040.001	0.08	4	13 200
54236.050.001	0.124	5	20 600
54236.060.001	0.178	6	29 700
54236.070.001	0.243	7	40 400
54236.080.001	0.317	8	52 800
54236.100.001	0.495	10	82 500
54236.120.001	0.713	12	119 000
54236.140.001	0.971	14	162 000
54236.160.001	1.27	16	211 000

Grupy katalogowe

Materiał	Kolor	Kod	Strona
St.St. A4		54232	13-55
St.St. A4		54233	13-55
St.St. A4	Biały	54234	13-55

Grupy katalogowe

Material	Kolor	Kod	Strona
St.St. A4	Przezroczysty	54235	13-55
St.St. A4		54236	13-55

54232 Lina o splecie 7X19 miękka MH11

Material Stal nierdzewna A4

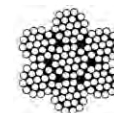

WR-ø	☒	Kod artykułu	WR-ø	☒	Kod artykułu	WR-ø	☒	Kod artykułu
2MM-250MTR*	1	54232.020.001	6MM-250MTR*	1	54232.060.001	10MM-250MTR*	1	54232.100.001
3MM-250MTR	1	54232.030.001	7MM-250MTR*	1	54232.070.001	12MM-250MTR*	1	54232.120.001
4MM-250MTR*	1	54232.040.001	8MM-250MTR*	1	54232.080.001	14MM-250MTR*	1	54232.140.001
5MM-250MTR*	1	54232.050.001						

54233 Lina o splecie 7X7, półmiękka MH11

Material Stal nierdzewna A4

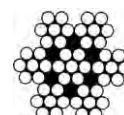

WR-ø	☒	Kod artykułu	WR-ø	☒	Kod artykułu	WR-ø	☒	Kod artykułu
2MM-250MTR*	1	54233.020.001	5MM-250MTR*	1	54233.050.001	8MM-250MTR*	1	54233.080.001
3MM-250MTR*	1	54233.030.001	6MM-250MTR*	1	54233.060.001	10MM-250MTR*	1	54233.100.001
4MM-250MTR*	1	54233.040.001	7MM-250MTR*	1	54233.070.001			

54234 Lina o splecie 7X7 w białej powłoce PVC MH11

Material Stal nierdzewna A4
Kolor Biały

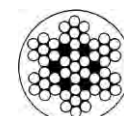

WR-ø	☒	Kod artykułu	WR-ø	☒	Kod artykułu
4/6-250MTR*	1	54234.040.601	4/7-250MTR*	1	54234.040.701

54235 Lina o splecie 7X7 w przezroczystej powłoce PVC MH11

Material Stal nierdzewna A4
Kolor Przezroczysty

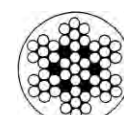

WR-ø	☒	Kod artykułu	WR-ø	☒	Kod artykułu	WR-ø	☒	Kod artykułu
1/1,5 250MTR*	1	54235.010.015	2/3 250MTR*	1	54235.020.030	4/5 -250MTR*	1	54235.040.050
1,25/2 250MTR*	1	54235.012.020	3/4 250MTR*	1	54235.030.040	5/7 250MTR*	1	54235.050.070

54236 Lina o splecie 1X19, mocna MH11

Material Stal nierdzewna A4



WR-ø	☒	Kod artykułu	WR-ø	☒	Kod artykułu	WR-ø	☒	Kod artykułu
1MM-250MTR*	1	54236.010.001	5MM-250MTR*	1	54236.050.001	10MM-250MTR*	1	54236.100.001
2MM-250MTR*	1	54236.020.001	6MM-250MTR*	1	54236.060.001	12MM-250MTR*	1	54236.120.001
3MM-250MTR*	1	54236.030.001	7MM-250MTR*	1	54236.070.001	14MM-250MTR*	1	54236.140.001
4MM-250MTR*	1	54236.040.001	8MM-250MTR*	1	54236.080.001	16MM-250MTR*	1	54236.160.001

Ucinaki do lin



Informacje techniczne

Nr	L	Ø drutu maks.
54258.050.001	195	5
54258.120.001	470	12
54258.160.001	800	16
54258.120.100	-	12
54258.160.100	-	16

54258 Ucinaki do lin

MH11



Wymiary	✉	Kod artykułu	Wymiary	✉	Kod artykułu	Wymiary	✉	Kod artykułu
5MM*	1	54258.050.001	Spare blade 12MM*	1	54258.120.100	Spare blade 16MM*	1	54258.160.100
12MM*	1	54258.120.001	16MM*	1	54258.160.001			

Kausza



Informacje techniczne

Nr	B	C	D	E	K	L	L ₁	S	WR-Ø
54237.060.001	23	-	-	-	-	37	11	-	6
54237.080.001	31	-	-	-	-	50	15	-	8
54237.100.001	39	-	-	-	-	53	21	-	10
54237.120.001	42	-	-	-	-	60	25	-	12
54237.140.001	51	-	-	-	-	74	30	-	14
54238.040.001	11	18	-	-	-	-	-	1.0	4
54238.050.001	14	20	-	-	-	-	-	1.2	5
54238.060.001	15	23	-	-	-	-	-	1.2	6
54238.080.001	18	29	-	-	-	-	-	1.5	8
54238.100.001	24	37	-	-	-	-	-	1.5	10
54239.020.001	5	15	21	15	6.4	-	-	-	2
54239.030.003	6	20	26	18	8.4	-	-	-	3
54239.040.001	7	25	32	21	11	-	-	-	4
54239.050.001	9	31	42	28	12	-	-	-	5
54239.060.001	10	32	43	28	12	-	-	-	6
54239.080.001	11	41	58	43	13	-	-	-	8
54239.100.001	13	50	72	51	14	-	-	-	10
54239.120.001	16	60	86	62	16	-	-	-	12
54239.160.001	20	75	110	82	21	-	-	-	16
54239.190.001	24	90	124	94	31	-	-	-	19
54239.220.001	28	100	130	100	38	-	-	-	22
54239.250.001	32	116	148	115	48	-	-	-	25
54240.040.001	13	19	-	-	-	-	-	2	4
54240.060.001	16	22	-	-	-	-	-	2	6
54240.080.001	23	38	-	-	-	-	-	2	8

Informacje techniczne									
Nr	B	C	D	E	K	L	L ₁	S	WR-ø
54240.100.001	24	40	-	-	-	-	-	3	10
54240.120.001	24	41	-	-	-	-	-	3	12
54240.140.001	26	44	-	-	-	-	-	3	14
54240.160.001	34	54	-	-	-	-	-	5	16
54240.180.001	34	56	-	-	-	-	-	6	18
54240.200.001	35	57	-	-	-	-	-	6	20

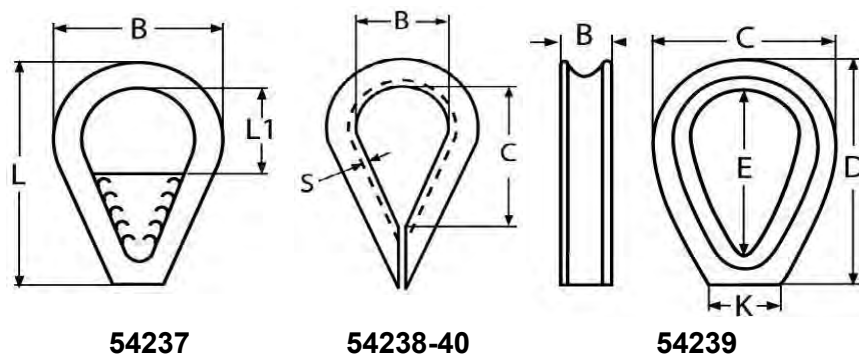



Grupy katalogowe		
Material	Kod	Strona
St.St. A4	54237	13-57
St.St. A4	54238	13-57
St.St. A4	54239	13-57
Plastik	54240	13-58

54237	Kausza z mostkiem	MH11
Material	Stal nierdzewna A4	
		

WR-ø	☒	Kod artykułu	WR-ø	☒	Kod artykułu	WR-ø	☒	Kod artykułu
6MM*	10	54237.060.001	10MM*	10	54237.100.001	14MM*	5	54237.140.001
8MM*	10	54237.080.001	12MM*	5	54237.120.001			

54238	Kausza	MH11
Material	Stal nierdzewna A4	
		

WR-ø	☒	Kod artykułu	WR-ø	☒	Kod artykułu	WR-ø	☒	Kod artykułu
4MM	50	54238.040.001	6MM	20	54238.060.001	10MM*	20	54238.100.001
5MM	50	54238.050.001	8MM*	20	54238.080.001			

54239	Kausza wzmocniona, zamknięta	MH11
Material	Stal nierdzewna A4	
		

WR-ø	☒	Kod artykułu	WR-ø	☒	Kod artykułu	WR-ø	☒	Kod artykułu
2MM*	10	54239.020.001	6MM*	10	54239.060.001	16MM*	1	54239.160.001
3MM	10	54239.030.003	8MM*	5	54239.080.001	19MM*	1	54239.190.001
4MM*	10	54239.040.001	10MM*	5	54239.100.001	22MM*	1	54239.220.001
5MM*	10	54239.050.001	12MM*	5	54239.120.001	25MM*	1	54239.250.001

54240	Kausza nylonowa	MH11
Materiał	Plastik	

WR- ϕ	☒	Kod artykułu	WR- ϕ	☒	Kod artykułu	WR- ϕ	☒	Kod artykułu
4MM*	20	54240.040.001	10MM*	10	54240.100.001	16MM*	5	54240.160.001
6MM*	20	54240.060.001	12MM*	10	54240.120.001	18MM*	5	54240.180.001
8MM*	20	54240.080.001	14MM*	10	54240.140.001	20MM*	5	54240.200.001

Zacisk do lin



Informacje techniczne

Nr	A	B	C	d	H	L	Nasadka	WR- ϕ
54241.030.001	-	-	-	M3	-	-	-	3
54241.050.001	-	-	-	M5	-	-	-	5
54241.060.001	-	-	-	M6	-	-	-	6
54241.080.001	-	-	-	M6	-	-	-	8
54241.100.001	-	-	-	M8	-	-	-	10
54241.120.001	-	-	-	M10	-	-	-	13
54241.160.001	-	-	-	M10	-	-	-	16
54242.020.001	-	-	-	-	11	28	T20	2
54242.030.001	-	-	-	-	12	28	T25	3
54242.040.001	-	-	-	-	14	34	T30	4
54242.050.001	-	-	-	-	15	34	T30	5
54242.060.001	-	-	-	-	15	35	T30	6
54243.020.001	11.5	33	-	M4	-	-	-	2
54243.030.001	14.5	38	-	M4	-	-	-	3
54243.040.001	16.5	43	-	M5	-	-	-	4
54243.050.001	20.0	51	-	M5	-	-	-	5
54243.060.001	24.5	63	-	M6	-	-	-	6
54243.080.001	31.5	78	-	M8	-	-	-	8
54243.100.001	38.0	96	-	M10	-	-	-	10
54244.020.001	4	11.5	15	M4	-	-	-	2
54244.030.001	6	14.5	18	M4	-	-	-	3
54244.040.001	8	16.5	20	M5	-	-	-	4
54244.050.001	10	20.0	24	M5	-	-	-	5
54244.060.001	12	24.5	29	M6	-	-	-	6
54244.080.001	16	31.5	35	M8	-	-	-	8
54244.100.001	20	38.0	48	M10	-	-	-	10

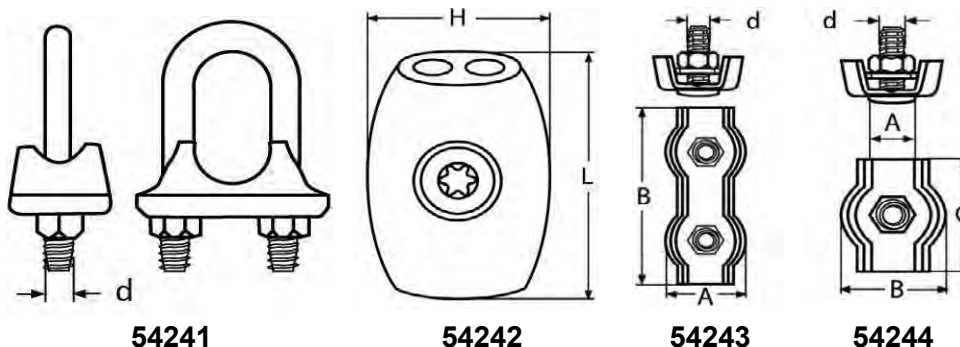

Grupy katalogowe

Materiał	Kod	Strona
St.St. A4	54241	13-59

Grupy katalogowe

Material	Kod	Strona
St.St. A4	54242	13-59
St.St. A4	54243	13-59
St.St. A4	54244	13-59

54241 Zacisk do lin MH11

Material Stal nierdzewna A4



WR-ø	☒	Kod artykułu	WR-ø	☒	Kod artykułu	WR-ø	☒	Kod artykułu
3MM	20	54241.030.001	8MM*	10	54241.080.001	12MM*	10	54241.120.001
5MM	20	54241.050.001	10MM*	10	54241.100.001	16MM*	5	54241.160.001
6MM	20	54241.060.001						

54242 Zacisk linowy kublejkowy MH11

Material Stal nierdzewna A4



WR-ø	☒	Kod artykułu	WR-ø	☒	Kod artykułu	WR-ø	☒	Kod artykułu
2MM*	10	54242.020.001	4MM*	10	54242.040.001	6MM*	5	54242.060.001
3MM	10	54242.030.001	5MM*	5	54242.050.001			

54243 Zacisk linowy Duplex MH11

Material Stal nierdzewna A4



WR-ø	☒	Kod artykułu	WR-ø	☒	Kod artykułu	WR-ø	☒	Kod artykułu
2MM*	20	54243.020.001	5MM*	10	54243.050.001	8MM*	5	54243.080.001
3MM*	20	54243.030.001	6MM*	10	54243.060.001	10MM*	5	54243.100.001
4MM*	20	54243.040.001						

54244 Zacisk linowy Simplex MH11

Material Stal nierdzewna A4



WR-ø	☒	Kod artykułu	WR-ø	☒	Kod artykułu	WR-ø	☒	Kod artykułu
2MM*	20	54244.020.001	5MM*	10	54244.050.001	8MM*	10	54244.080.001
3MM*	20	54244.030.001	6MM*	10	54244.060.001	10MM*	10	54244.100.001
4MM*	20	54244.040.001						

Tuleja do zaciskania



Informacje techniczne

Nr	A	B	L	Rozmiar mocowania	S	WR- ϕ
54245.010.001	1.7	3.4	6	1.5	0.75	1
54245.015.001	2.4	4.8	7	2.0	0.85	1.5
54245.020.001	2.7	5.4	9	2.5	1.0	2
54245.030.001	3.8	7.6	13	3.5	1.5	3
54245.040.001	4.9	9.8	16	4.5	1.9	4
54245.050.001	6.6	13.2	21	6.0	2.5	5
54245.060.001	7.2	14.4	23	6.5	2.7	6
54245.070.001	8.8	17.6	28	8.0	3.3	7
54245.080.001	9.9	19.8	32	9.0	3.7	8
54245.100.001	12.1	24.2	39	11.0	4.5	10
54245.120.001	14.2	28.4	46	13.0	5.4	12
54245.160.001	19.6	39.2	63	18.0	7.6	16
54246.010.001	1.2	2.4	5	1.0	0.65	1
54246.020.001	2.5	4.5	9	2.0	1.0	2
54246.030.001	3.5	7.5	11	3.0	1.0	3
54246.040.001	4.5	9.2	14	4.0	1.5	4
54246.050.001	5.6	11.5	18	5.0	2.0	5
54246.060.001	6.8	13.5	21	6.0	2.5	6
54246.070.001	8.0	16.5	25	7.0	2.5	7
54246.080.001	9.0	18	28	8.0	3.0	8
54246.100.001	11.5	22.5	35	10.0	3.2	10
54246.120.001	14.2	28.5	42	12.0	4.0	12
54247.010.001	1.7	3.4	6	1.5	0.75	1
54247.015.001	2.4	4.8	7	2.0	0.85	1.5
54247.020.001	2.7	5.4	9	2.5	1.0	2
54247.030.001	3.8	7.6	13	3.5	1.5	3
54247.040.001	4.9	9.8	16	4.5	1.9	4
54247.050.001	6.6	13.2	21	6.0	2.5	5
54247.060.001	7.2	14.4	23	6.5	2.7	6
54247.070.001	8.8	17.6	28	8.0	3.3	7
54247.080.001	9.9	19.8	32	9.0	3.7	8
54247.100.001	12.1	24.2	39	11.0	4.5	10
54247.120.001	14.2	28.4	46	13.0	5.4	12

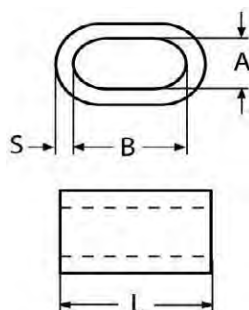

54245-6-7

Grupy katalogowe

Materiał	Kod	Strona
Miedź	54245	13-61
St.St. A4	54246	13-61
Al	54247	13-61

54245 Tuleja do zaciskania z miedzi MH11
Materiał Miedź

WR-ø	☒	Kod artykułu	WR-ø	☒	Kod artykułu	WR-ø	☒	Kod artykułu
1MM*	100	54245.010.001	4MM*	100	54245.040.001	8MM*	5	54245.080.001
1,5MM*	100	54245.015.001	5MM*	50	54245.050.001	10MM*	1	54245.100.001
2MM*	100	54245.020.001	6MM*	50	54245.060.001	12MM*	1	54245.120.001
3MM*	100	54245.030.001	7MM*	5	54245.070.001	16MM*	10	54245.160.001

54246 Tuleja do zaciskania ze stali kwasoodpornej MH11
Materiał Stal nierdzewna A4

WR-ø	☒	Kod artykułu	WR-ø	☒	Kod artykułu	WR-ø	☒	Kod artykułu
1MM*	10	54246.010.001	5MM*	10	54246.050.001	8MM*	5	54246.080.001
2MM*	10	54246.020.001	6MM*	10	54246.060.001	10MM*	1	54246.100.001
3MM*	10	54246.030.001	7MM*	5	54246.070.001	12MM*	1	54246.120.001
4MM*	10	54246.040.001						

54247 Tuleja do zaciskania z aluminium MH11
Materiał Aluminium

WR-ø	☒	Kod artykułu	WR-ø	☒	Kod artykułu	WR-ø	☒	Kod artykułu
1MM	100	54247.010.001	4MM*	100	54247.040.001	8MM*	10	54247.080.001
1,5MM	100	54247.015.001	5MM*	50	54247.050.001	10MM*	10	54247.100.001
2MM	100	54247.020.001	6MM*	50	54247.060.001	12MM*	5	54247.120.001
3MM*	100	54247.030.001	7MM*	10	54247.070.001			

Zaciskarka ręczna z wymiennymi wkładkami



Informacje techniczne

Nr	Rozmiar mocowania
54259.010.045	1.0-4.5
54259.010.001	1.0
54259.015.001	1.5
54259.020.001	2.0
54259.025.001	2.5
54259.030.001	3.0
54259.035.001	3.5
54259.040.001	4.0
54259.045.001	4.5

54259 Zaciskarka ręczna z wymiennymi wkładkami

MH11



Wymiary	☒	Kod artykułu	Wymiary	☒	Kod artykułu	Wymiary	☒	Kod artykułu
1,0 wkładki*	1	54259.010.001	2,0 wkładki*	1	54259.020.001	3,5 wkładki*	1	54259.035.001
1,0-4,5 narzędzie*	1	54259.010.045	2,5 wkładki*	1	54259.025.001	4,0 wkładki*	1	54259.040.001
1,5 wkładki*	1	54259.015.001	3,0 wkładki*	1	54259.030.001	4,5 wkładki*	1	54259.045.001

Sworzeń



Informacje techniczne

Nr	A	B	C	D	E	F	L	L ₁	N	ø
54248.040.014	-	-	-	4	-	-	14	-	11	-
54248.040.020	-	-	-	4	-	-	20	-	16	-
54248.050.015	-	-	-	5	-	-	15	-	11	-
54248.050.018	-	-	-	5	-	-	18	-	14	-
54248.050.021	-	-	-	5	-	-	21	-	17	-
54248.060.015	-	-	-	6	-	-	15	-	11	-
54248.060.020	-	-	-	6	-	-	20	-	16	-
54248.060.024	-	-	-	6	-	-	24	-	20	-
54248.060.025	-	-	-	6	-	-	25	-	21	-
54248.060.029	-	-	-	6	-	-	29	-	25	-
54248.060.034	-	-	-	6	-	-	34	-	30	-
54248.060.036	-	-	-	6	-	-	36	-	32	-
54248.060.044	-	-	-	6	-	-	44	-	40	-
54248.060.045	-	-	-	6	-	-	45	-	41	-
54248.060.054	-	-	-	6	-	-	54	-	50	-
54248.060.064	-	-	-	6	-	-	64	-	60	-
54248.080.021	-	-	-	8	-	-	21	-	17	-
54248.080.024	-	-	-	8	-	-	24	-	20	-
54248.080.027	-	-	-	8	-	-	27	-	23	-
54248.080.032	-	-	-	8	-	-	32	-	28	-
54248.080.034	-	-	-	8	-	-	34	-	30	-
54248.080.044	-	-	-	8	-	-	44	-	40	-
54248.080.054	-	-	-	8	-	-	54	-	50	-
54248.080.064	-	-	-	8	-	-	64	-	60	-
54248.080.074	-	-	-	8	-	-	74	-	70	-
54248.080.084	-	-	-	8	-	-	84	-	80	-
54248.095.026	-	-	-	9.5	-	-	26	-	22	-
54248.095.030	-	-	-	9.5	-	-	30	-	26	-
54248.100.034	-	-	-	10	-	-	34	-	30	-
54248.100.044	-	-	-	10	-	-	44	-	40	-
54248.100.054	-	-	-	10	-	-	54	-	50	-
54248.100.064	-	-	-	10	-	-	64	-	60	-
54248.100.074	-	-	-	10	-	-	74	-	70	-
54248.100.084	-	-	-	10	-	-	84	-	80	-
54248.100.094	-	-	-	10	-	-	94	-	90	-
54248.100.104	-	-	-	10	-	-	104	-	100	-
54248.110.029	-	-	-	11	-	-	29	-	25	-
54248.120.030	-	-	-	12	-	-	30	-	26	-
54248.120.045	-	-	-	12	-	-	45	-	40	-
54248.120.055	-	-	-	12	-	-	55	-	50	-
54248.120.065	-	-	-	12	-	-	65	-	60	-
54248.120.075	-	-	-	12	-	-	75	-	70	-
54248.120.085	-	-	-	12	-	-	85	-	80	-
54248.120.095	-	-	-	12	-	-	95	-	90	-
54248.120.105	-	-	-	12	-	-	105	-	100	-
54248.120.115	-	-	-	12	-	-	115	-	110	-
54248.120.125	-	-	-	12	-	-	125	-	120	-
54248.140.041	-	-	-	14	-	-	41	-	36	-
54249.044.001	49.6	7.5	4.4	-	2.4	39.0	-	-	-	-
54249.060.001	56.2	8.0	6.0	-	3.2	44.8	-	-	-	-
54249.074.001	56.5	8.4	7.4	-	3.1	44.9	-	-	-	-
54249.106.001	56.5	10.7	10.6	-	3.2	43.4	-	-	-	-
54250.060.020	-	-	-	6	-	-	20	12	-	-
54250.060.025	-	-	-	6	-	-	26	18	-	-
54250.060.031	-	-	-	6	-	-	31	23	-	-
54250.060.056	-	-	-	6	-	-	56	48	-	-
54250.060.065	-	-	-	6	-	-	65	57	-	-

Informacje techniczne

Nr	A	B	C	D	E	F	L	L ₁	N	ø
54250.080.028	-	-	-	8	-	-	28	20	-	-
54250.080.034	-	-	-	8	-	-	34	25	-	-
54250.080.038	-	-	-	8	-	-	38	30	-	-
54250.080.043	-	-	-	8	-	-	43	35	-	-
54250.100.035	-	-	-	10	-	-	35	25	-	-
54250.100.045	-	-	-	10	-	-	45	35	-	-
54250.100.055	-	-	-	10	-	-	55	45	-	-
54251.050.028	-	-	-	-	-	-	28	-	13	5
54251.060.035	-	-	-	-	-	-	35	-	22	6
54251.080.033	-	-	-	-	-	-	33	-	22	8
54251.080.046	-	-	-	-	-	-	46	-	36	8

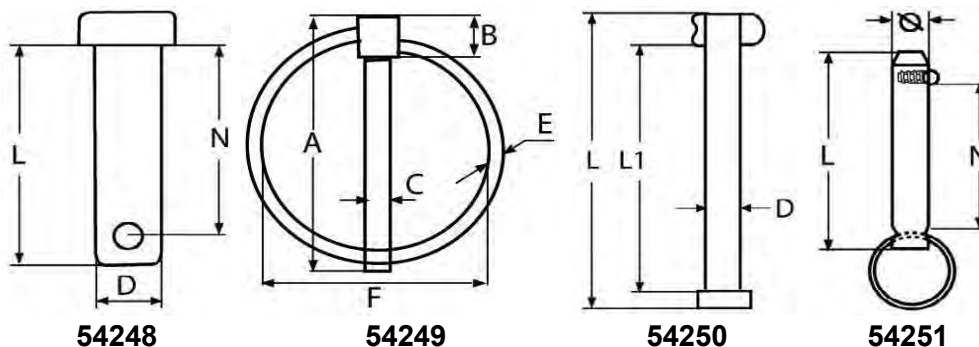

Grupy katalogowe

Material	Kod	Strona
St.St. A4	54248	13-64
St.St. A4	54249	13-65
St.St. A2	54250	13-65
St.St. A2	54251	13-65

54248 Sworzeń z otworem



MH11



Material Stal nierdzewna A4



D x L	☒	Kod artykułu	D x L	☒	Kod artykułu	D x L	☒	Kod artykułu
4X14*	20	54248.040.014	8X21*	20	54248.080.021	10X84*	1	54248.100.084
4X20*	20	54248.040.020	8X24*	20	54248.080.024	10X94*	1	54248.100.094
			8X27*	20	54248.080.027	10X104*	1	54248.100.104
5X15*	20	54248.050.015	8X32*	20	54248.080.032			
5X18*	20	54248.050.018	8X34*	2	54248.080.034	11X29*	10	54248.110.029
5X21*	20	54248.050.021	8X44*	2	54248.080.044			
			8X54*	2	54248.080.054	12X30*	10	54248.120.030
6X15*	20	54248.060.015	8X64*	2	54248.080.064	12X45*	1	54248.120.045
6X20*	20	54248.060.020	8X74*	2	54248.080.074	12X55*	1	54248.120.055
6X24*	5	54248.060.024	8X84*	2	54248.080.084	12X65*	1	54248.120.065
6X25*	20	54248.060.025				12X75*	1	54248.120.075
6X29*	20	54248.060.029	9,5X26*	10	54248.095.026	12X85*	1	54248.120.085
6X34*	5	54248.060.034	9,5X30*	1	54248.095.030	12X95*	1	54248.120.095
6X36*	20	54248.060.036				12X105*	1	54248.120.105
6X44*	5	54248.060.044	10X34*	1	54248.100.034	12X115*	1	54248.120.115
6X45*	20	54248.060.045	10X44*	1	54248.100.044	12X125*	1	54248.120.125
6X54*	5	54248.060.054	10X54*	1	54248.100.054			
6X64*	5	54248.060.064	10X64*	1	54248.100.064	14X41*	10	54248.140.041
			10X74*	1	54248.100.074			

54249		Zawlecza składana z pierścieniem		MH11	
Materiał		Stal nierdzewna A4		 	
C	✉	Kod artykułu	C	✉	Kod artykułu
4,4MM	10	54249.044.001	7,4MM*	5	54249.074.001
6,0MM*	10	54249.060.001			54249.106.001

54250		Sworzeń z łbem płaskim i otworem na zawleczkę		MH11	
Materiał		Stal nierdzewna A2		 	
D x L	✉	Kod artykułu	D x L	✉	Kod artykułu
6X20*	5	54250.060.020	8X28*	2	54250.080.028
6X26*	5	54250.060.025	8X34*	2	54250.080.034
6X31*	5	54250.060.031	8X38*	2	54250.080.038
6X56*	5	54250.060.056	8X43*	2	54250.080.043
6X65*	5	54250.060.065			
					54250.100.035
					54250.100.045
					54250.100.055

54251		Sworzeń z zabezpieczeniem kulkowym		MH11	
Materiał		Stal nierdzewna A2		 	
ø x L	✉	Kod artykułu	ø x L	✉	Kod artykułu
5X28*	10	54251.050.028	8X33*	10	54251.080.033
6X35*	10	54251.060.035			54251.080.046

Lina zabezpieczająca



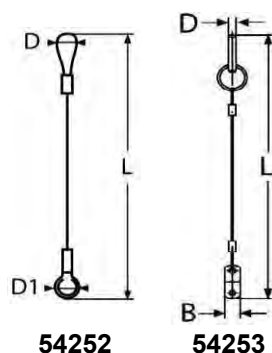

Informacje techniczne

Nr	B	D	D ₁	L
54252.145.001	-	8	5.4	145
54253.060.025	13	6	-	25





Grupy katalogowe

Material	Kod	Strona
St.St. A2	54252	13-66
St.St. A2	54253	13-66

54252	Lina zabezpieczająca	MH11
Material	Stal nierdzewna A2	
		

L		Kod artykułu
145MM*	10	54252.145.001

54253	Sworzeń z liną zabezpieczającą	MH11
Material	Stal nierdzewna A2	
		

D x L		Kod artykułu
6X25MM*	10	54253.060.025

Zawleczka



Informacje techniczne

Nr	L	Wiercio \emptyset	\emptyset
54254.020.001	48	2.5	2.0
54254.025.001	48	3.0	2.5
54254.030.001	70	3.5	3.0
54254.040.001	76	4.5	4.0
54254.050.001	100	6.0	5.0
54254.060.001	125	7.0	6.0
54255.025.001	54	1.5	2.25
54255.032.001	61	3.2	2.8
54255.040.001	78	4.0	3.6
54255.050.001	97	5.0	4.5
54255.063.001	115	6.3	5.6
54255.070.001	146	7.0	6.3
54255.080.001	172	8.0	7.0

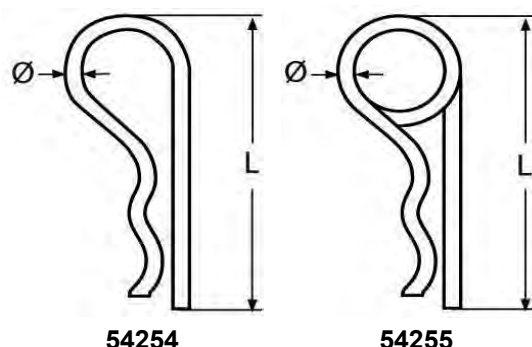

Grupy katalogowe

Material	Kod	Strona
St.St. A4	54254	13-67
St.St. A4	54255	13-67

54254 Zawleczka pojedyncza MH11



Material: Stal nierdzewna A4



\emptyset	☒	Kod artykułu	\emptyset	☒	Kod artykułu	\emptyset	☒	Kod artykułu
2MM	50	54254.020.001	3MM	50	54254.030.001	5MM*	20	54254.050.001
2,5MM*	50	54254.025.001	4MM	20	54254.040.001	6MM	10	54254.060.001

54255 Zawleczka podwójna MH11

Material: Stal nierdzewna A4

\emptyset	☒	Kod artykułu	\emptyset	☒	Kod artykułu	\emptyset	☒	Kod artykułu
2,5MM*	10	54255.025.001	5,0MM*	5	54255.050.001	7,0MM*	1	54255.070.001
3,2MM*	10	54255.032.001	6,3MM*	5	54255.063.001	8,0MM*	1	54255.080.001
4,0MM*	10	54255.040.001						

Zawleczka do kluczy





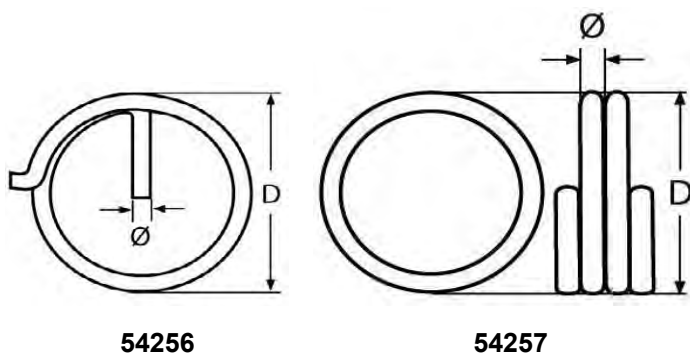

Informacje techniczne





Nr	D	ø
54256.010.010	10	1.0
54256.012.015	15	1.2
54256.015.020	20	1.5
54256.018.025	25	1.8
54257.100.001	10	1.5
54257.160.001	16	1.5



Grupy katalogowe

Materiał	Kod	Strona
St.St. A4	54256	13-68
St.St. A2	54257	13-68

54256		Zawleczka do kluczy				MH11		
Materiał		Stal nierdzewna A4						
								
ø x D		Kod artykułu	ø x D		Kod artykułu	ø x D		Kod artykułu
1,0X10*	50	54256.010.010	1,5X20*	20	54256.015.020	1,8X25*	20	54256.018.025
1,2X15*	50	54256.012.015						

54257		Zawleczka 2,5 obrotu				MH11	
Materiał		Stal nierdzewna A2					
							
D		Kod artykułu	D		Kod artykułu		
10MM*	50	54257.100.001	16MM*	50	54257.160.001		

ESS Uniwersalny ściągnacz wahliwy



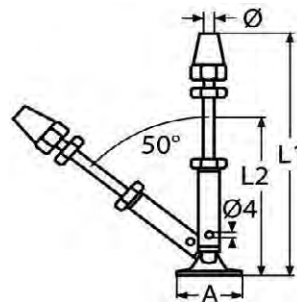

Informacje techniczne

Nr	A	L ₁	L ₂	Typ	WR-ø
54300.000.005	38	143	200	square	4
54300.000.010	38	143	200	round	4



54300

54300	ESS Uniwersalny ściągnacz wahliwy	MH11
Material	Stal nierdzewna A4	
		

Typ	☒	Kod artykułu	Typ	☒	Kod artykułu
SQUARE*	1	54300.000.005	ROUND*	1	54300.000.010

ESS Końcówka do ściągaczy linowych



Informacje techniczne

Nr	A	A ₁	A ₂	B	d	D	D ₁	D ₂	H	WR-ø	ø
54301.050.030	50	18	27	-	M5	6.3	-	-	-	-	3
54301.060.040	60	25	30	-	M6	7.5	-	-	-	-	4
54301.080.050	70	31	31	-	M8	9.0	-	-	-	-	5
54301.100.060	85	37	40	-	M10	12.5	-	-	-	-	6
54302.050.030	50	18	27	-	M5	6.3	-	-	-	-	3
54302.060.040	60	25	30	-	M6	7.5	-	-	-	-	4
54302.080.050	70	31	31	-	M8	9.0	-	-	-	-	5
54302.100.060	85	37	40	-	M10	12.5	-	-	-	-	6
54303.050.030	55	20	28	-	M5	6.3	-	-	-	-	3
54303.060.040	65	22	36	-	M6	7.5	-	-	-	-	4
54303.060.050	70	22	41	-	M8	9.0	-	-	-	-	5
54303.080.060	85	25	53	-	M10	12.5	-	-	-	-	6
54304.050.030	55	20	28	-	M5	6.3	-	-	-	-	3
54304.060.040	65	22	36	-	M6	7.5	-	-	-	-	4
54304.060.050	70	22	41	-	M6	9.0	-	-	-	-	5
54304.080.060	85	25	53	-	M8	12.5	-	-	-	-	6
54305.050.001	40	20	-	8	M5	5	-	-	10	-	-
54305.060.001	47	25	-	8	M6	6	-	-	10	-	-
54305.080.001	52	25	-	10	M8	8	-	-	12	-	-
54305.100.001	72	45	-	12	M10	10	-	-	14	-	-
54306.050.001	40	20	-	8	M5	5	-	-	10	-	-
54306.060.001	47	25	-	8	M6	6	-	-	10	-	-
54306.080.001	52	25	-	10	M8	8	-	-	12	-	-
54306.100.001	72	45	-	12	M10	10	-	-	14	-	-
54307.050.001	45	23	-	-	M5	5.5	-	-	3	-	-
54307.060.001	47	28	-	-	M6	6.5	-	-	4	-	-
54307.080.001	55	40	-	-	M8	8.5	-	-	5	-	-
54307.100.001	65	47	-	-	M10	10.5	-	-	6	-	-
54308.050.001	45	23	-	-	M5	5.5	-	-	3	-	-
54308.060.001	47	28	-	-	M6	6.5	-	-	4	-	-
54308.080.001	55	40	-	-	M8	8.5	-	-	5	-	-
54308.100.001	65	47	-	-	M10	10.5	-	-	6	-	-
54309.050.001	55	27	-	8	M5	7.5	5	-	10	-	-
54309.060.001	60	30	-	9	M6	8	6	-	10	-	-
54309.080.001	65	31	-	10	M8	12	8	-	12	-	-
54309.100.001	75	40	-	12	M10	14	10	-	12	-	-
54310.050.001	55	27	-	8	M5	7.5	5	-	10	-	-
54310.060.001	60	30	-	9	M6	8	6	-	10	-	-
54310.080.001	65	31	-	10	M8	12	8	-	12	-	-
54310.100.001	75	40	-	12	M10	14	10	-	12	-	-
54311.050.001	55	-	-	-	M5	-	-	-	-	-	-
54311.060.001	65	-	-	-	M6	-	-	-	-	-	-
54311.080.001	70	-	-	-	M8	-	-	-	-	-	-
54311.100.001	85	-	-	-	M10	-	-	-	-	-	-
54312.000.005	80	45	30	-	M6 L	12	-	-	-	3+4	-
54312.100.005	80	45	30	-	M6 R	12	-	-	-	3+4	-
54313.050.001	65	30	30	-	M5	-	-	-	-	-	-
54313.060.001	65	30	30	-	M6	-	-	-	-	-	-
54313.080.001	65	30	30	-	M8	-	-	-	-	-	-
54313.100.001	85	40	40	-	M10	-	-	-	-	-	-
54313.120.001	105	50	50	-	M12	-	-	-	-	-	-
54314.030.001	40	18	-	-	-	6.3	-	6.5	5	-	3
54314.040.001	52	24	-	-	-	7.5	-	8.5	6	-	4
54314.050.001	62	30	-	-	-	9.0	-	9.5	7	-	5
54314.060.001	75	36	-	-	-	12.5	-	13	8	-	6
54315.030.001	55	-	-	8	-	6.3	5	-	10	-	3
54315.040.001	65	-	-	8	-	7.5	6	-	10	-	4

Informacje techniczne

Nr	A	A ₁	A ₂	B	d	D	D ₁	D ₂	H	WR-ø	ø
54315.050.001	70	-	-	10	-	8.9	6	-	12	-	5
54315.060.001	85	-	-	12	-	12.4	10	-	14	-	6

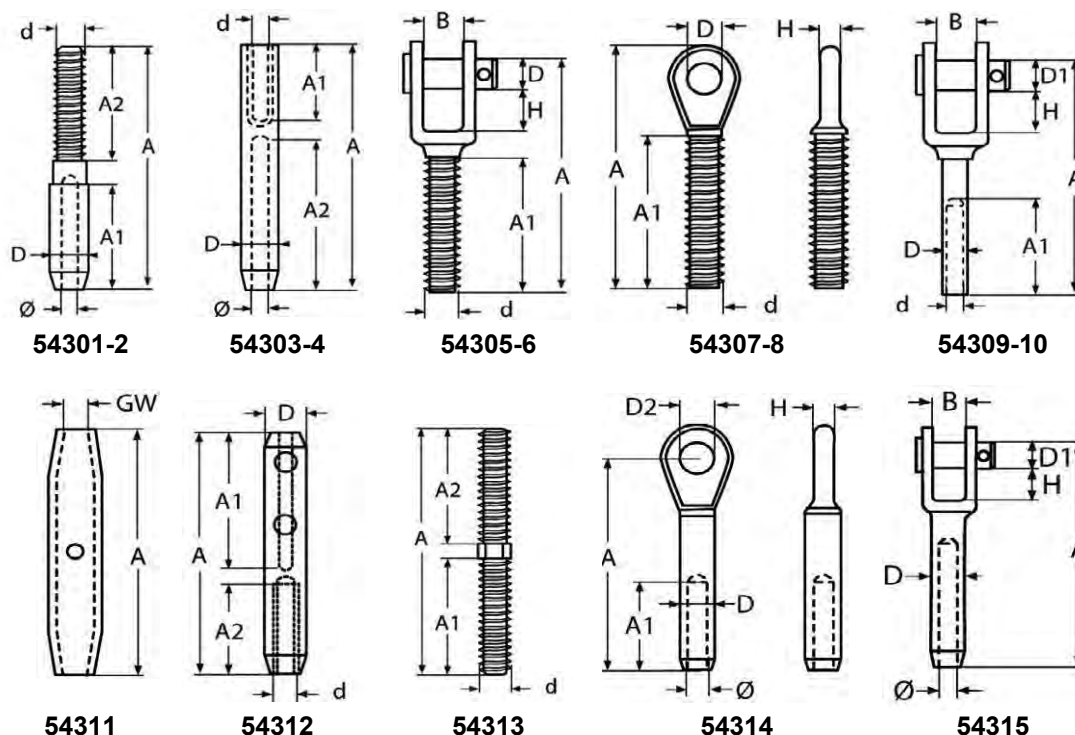

Grupy katalogowe

Material	Kod	Strona
St.St. A4	54301	13-71
St.St. A4	54302	13-72
St.St. A4	54303	13-72
St.St. A4	54304	13-72
St.St. A4	54305	13-72
St.St. A4	54306	13-72
St.St. A4	54307	13-72
St.St. A4	54308	13-73
St.St. A4	54309	13-73
St.St. A4	54310	13-73
St.St. A4	54311	13-73
St.St. A4	54312	13-73
St.St. A4	54313	13-73
St.St. A4	54314	13-74
St.St. A4	54315	13-74

54301 SLN Końcówka gwintowana, z prawym gwintem

MH11

Material Stal nierdzewna A4



d / WR-ø	☒	Kod artykułu	d / WR-ø	☒	Kod artykułu	d / WR-ø	☒	Kod artykułu
M5/3MM*	10	54301.050.030	M8/5MM*	5	54301.080.050	M10/6MM*	5	54301.100.060
M6/4MM*	10	54301.060.040						

54302 SLN Końcówka gwintowana, z lewym gwintem MH11



Materiał Stal nierdzewna A4



d / WR-ø	☒	Kod artykułu	d / WR-ø	☒	Kod artykułu	d / WR-ø	☒	Kod artykułu
M5/3MM*	10	54302.050.030	M8/5MM*	5	54302.080.050	M10/6MM*	5	54302.100.060
M6/4MM*	10	54302.060.040						

54303 SLN Końcówka z prawym gwintem wewnętrznym MH11

Materiał Stal nierdzewna A4

d / WR-ø	☒	Kod artykułu	d / WR-ø	☒	Kod artykułu	d / WR-ø	☒	Kod artykułu
M5/3MM RI*	10	54303.050.030	M6/5MM RI*	5	54303.060.050	M8/6MM RI*	5	54303.080.060
M6/4MM RI*	10	54303.060.040						

54304 SLN Końcówka z lewym gwintem wewnętrznym MH11

Materiał Stal nierdzewna A4



d / WR-ø	☒	Kod artykułu	d / WR-ø	☒	Kod artykułu	d / WR-ø	☒	Kod artykułu
M5/3MM LE*	10	54304.050.030	M6/5MM LE*	5	54304.060.050	M8/6MM LE*	5	54304.080.060
M6/4MM LE*	10	54304.060.040						

54305 SLN Końcówka widelki z prawym gwintem MH11



Materiał Stal nierdzewna A4



d	☒	Kod artykułu	d	☒	Kod artykułu	d	☒	Kod artykułu
M5*	10	54305.050.001	M8*	5	54305.080.001	M10*	5	54305.100.001
M6*	10	54305.060.001						

54306 SLN Końcówka widelki z lewym gwintem MH11



Materiał Stal nierdzewna A4

d	☒	Kod artykułu	d	☒	Kod artykułu	d	☒	Kod artykułu
M5*	10	54306.050.001	M8*	5	54306.080.001	M10*	5	54306.100.001
M6*	1	54306.060.001						

54307 SLN Końcówka oczkowa z prawym gwintem MH11

Materiał Stal nierdzewna A4

d	☒	Kod artykułu	d	☒	Kod artykułu	d	☒	Kod artykułu
M5*	10	54307.050.001	M8*	5	54307.080.001	M10*	5	54307.100.001
M6*	10	54307.060.001						

54308 SLN Końcówka oczkowa z lewym gwintem MH11



Materiał Stal nierdzewna A4



d	☒	Kod artykułu	d	☒	Kod artykułu	d	☒	Kod artykułu
M5*	10	54308.050.001	M8*	5	54308.080.001	M10*	5	54308.100.001
M6*	10	54308.060.001						

54309 SLN Końcówka widełki z prawym gwintem wewnętrznym MH11



Materiał Stal nierdzewna A4

d	☒	Kod artykułu	d	☒	Kod artykułu	d	☒	Kod artykułu
M5*	10	54309.050.001	M8*	5	54309.080.001	M10*	5	54309.100.001
M6*	10	54309.060.001						

54310 SLN Końcówka widełki z lewym gwintem wewnętrznym MH11



Materiał Stal nierdzewna A4

d	☒	Kod artykułu	d	☒	Kod artykułu	d	☒	Kod artykułu
M5*	10	54310.050.001	M8*	5	54310.080.001	M10*	5	54310.100.001
M6*	10	54310.060.001						

54311 Ściągacz liny stalowej nierdzewnej, część środkowa MH11



Materiał Stal nierdzewna A4

d	☒	Kod artykułu	d	☒	Kod artykułu	d	☒	Kod artykułu
M5*	10	54311.050.001	M8*	5	54311.080.001	M10*	5	54311.100.001
M6*	10	54311.060.001						

54312 SLN Końcówka śruby, samodzielny montaż, gwint lewy lub prawy DS 3+4mm MH11

Materiał Stal nierdzewna A4



d / WR-ø	☒	Kod artykułu	d / WR-ø	☒	Kod artykułu
M6/3+4MM LE*	5	54312.000.005	M6/3+4MM RI*	5	54312.100.005



54313 SLN Tuleja z gwintem zewnętrznym prawym i lewym MH11

Materiał Stal nierdzewna A4





d	☒	Kod artykułu	d	☒	Kod artykułu	d	☒	Kod artykułu
M5*	10	54313.050.001	M8*	5	54313.080.001	M12*	5	54313.120.001
M6*	10	54313.060.001	M10*	5	54313.100.001			

54314	SLN Końcówka oczkowa	MH11						
Materiał	Stal nierdzewna A4							
								
								
WR-ϕ	<input checked="" type="checkbox"/>	Kod artykułu	WR-ϕ	<input checked="" type="checkbox"/>	Kod artykułu	WR-ϕ	<input checked="" type="checkbox"/>	Kod artykułu
3MM*	10	54314.030.001	5MM*	5	54314.050.001	6MM*	5	54314.060.001
4MM*	10	54314.040.001						

54315	SLN Końcówka widelki	MH11						
Materiał	Stal nierdzewna A4							
								
								
WR-ϕ	<input checked="" type="checkbox"/>	Kod artykułu	WR-ϕ	<input checked="" type="checkbox"/>	Kod artykułu	WR-ϕ	<input checked="" type="checkbox"/>	Kod artykułu
3MM*	10	54315.030.001	5MM*	5	54315.050.001	6MM*	5	54315.060.001
4MM*	10	54315.040.001						

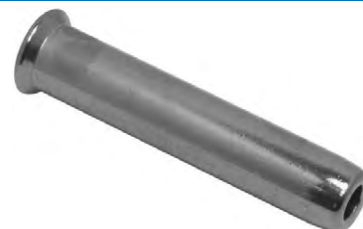
ESS Końcówka do ściągaczy linowych, z łbem



Informacje techniczne

Nr	A	A ₁	A ₂	d	D	D ₁	D ₂	ϕ
54316.030.001	34	27	2	-	8	6.3	-	3
54316.040.001	43	35	2	-	9.5	7.5	-	4
54316.050.001	50	40	3	-	13	9	-	5
54316.060.001	64	50	3	-	16.5	12.5	-	6
54317.030.001	25	18	2	-	9	5.5	3.3	3
54317.040.001	30	24	2	-	11	6.5	4.3	4
54317.050.001	35	28	2.5	-	13	7.5	5.3	5
54317.060.001	40	32	3	-	16	9	6.3	6
54318.050.001	25	18	4	M5	12	7.5	-	-
54318.060.001	30	24	4	M6	12	8	-	-
54318.080.001	35	28	5	M8	16	12	-	-
54318.100.001	40	32	6	M10	20	14	-	-

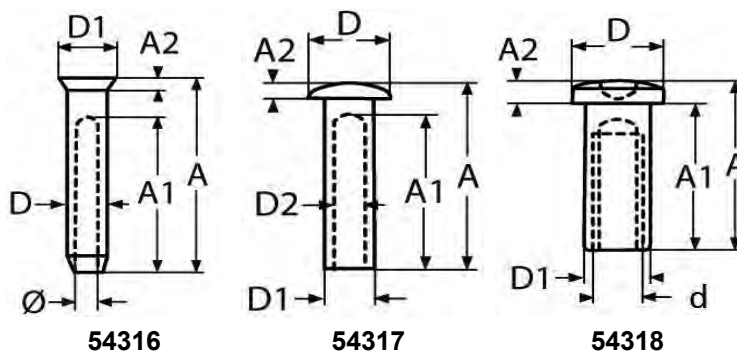



Grupy katalogowe



Materiał	Kod	Strona
St.St. A4	54316	13-75
St.St. A4	54317	13-75
St.St. A4	54318	13-75

54316	SLN Końcówka z łbem stożkowym płaskim	MH11
Materiał	Stal nierdzewna A4	
		

WR-ø	☒	Kod artykułu	WR-ø	☒	Kod artykułu	WR-ø	☒	Kod artykułu
3MM*	10	54316.030.001	5MM*	5	54316.050.001	6MM*	5	54316.060.001
4MM*	10	54316.040.001						

54317	SLN Końcówka z łbem stożkowo-wypukłym	MH11
Materiał	Stal nierdzewna A4	
		

WR-ø	☒	Kod artykułu	WR-ø	☒	Kod artykułu	WR-ø	☒	Kod artykułu
3MM*	10	54317.030.001	5MM*	5	54317.050.001	6MM*	5	54317.060.001
4MM*	10	54317.040.001						

54318	SLN Nakrętka tulejowa łeb stożkowo-wypukły, gwint wewnętrzny prawy, gniazdo sześciokątne	MH11
Materiał	Stal nierdzewna A4	
		

d	☒	Kod artykułu	d	☒	Kod artykułu	d	☒	Kod artykułu
M5*	10	54318.050.001	M8*	5	54318.080.001	M10*	5	54318.100.001
M6*	10	54318.060.001						

ESS Wkręt dwugwintowy



Informacje techniczne				
Nr	d	L	L ₁	L ₂
54319.050.001	M5	80	43	32
54319.060.001	M6	90	50	35
54319.080.001	M8	130	65	55
54319.100.001	M10	150	75	55
54320.050.001	M5	80	43	32
54320.060.001	M6	90	50	35
54320.080.001	M8	130	65	55
54320.100.001	M10	150	75	55

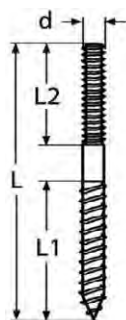

54319-20

Grupy katalogowe

Material	Kod	Strona
St.St. A4	54319	13-76
St.St. A4	54320	13-76

54319 Śruba dwugwintowa z prawym gwintem MH11

Material	Stal nierdzewna A4			
----------	--------------------	--	---	---

d	☒	Kod artykułu	d	☒	Kod artykułu	d	☒	Kod artykułu
M5*	5	54319.050.001	M8*	5	54319.080.001	M10*	5	54319.100.001
M6*	5	54319.060.001						

54320 Śruba dwugwintowa z lewym gwintem MH11

Material	Stal nierdzewna A4			
----------	--------------------	--	---	---

d	☒	Kod artykułu	d	☒	Kod artykułu	d	☒	Kod artykułu
M5*	5	54320.050.001	M8*	5	54320.080.001	M10*	5	54320.100.001
M6*	5	54320.060.001						

ESS Nakrętka ściągacza linowego



Informacje techniczne

Nr	A	d	S	Typ
54321.050.001	7.9	M5	3.8	R5
54321.050.002	7.9	M5	3.8	L5
54321.060.001	9.8	M6	4.8	R6
54321.060.002	9.8	M6	4.8	L6
54321.080.001	10.0	M8	5.0	R8
54321.080.002	10.0	M8	5.0	L8
54321.100.001	12.7	M10	6.2	R10
54321.100.002	12.7	M10	6.2	L10
54321.120.001	17.0	M12	8.0	R12
54321.120.002	17.0	M12	8.0	L12
54321.140.001	22.0	M14	11.0	R14
54321.140.002	22.0	M14	11.0	L14
54321.160.001	24.0	M16	13.0	R16
54321.160.002	24.0	M16	13.0	L16
54321.200.001	26.5	M20	14.5	R20
54321.200.002	26.5	M20	14.5	L20

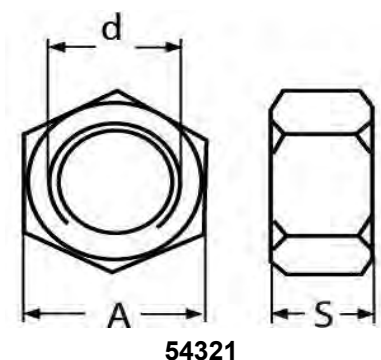

54321

54321	ESS Nakrętka ściągacza linowego	MH11
Materiał	Stal nierdzewna A4	
		

Typ	☒	Kod artykułu	Typ	☒	Kod artykułu	Typ	☒	Kod artykułu
M5 LE*	10	54321.050.001	M10 LE*	10	54321.100.001	M16 LE*	5	54321.160.001
M5 RI*	10	54321.050.002	M10 RI*	10	54321.100.002	M16 RI*	5	54321.160.002
M6 LE*	10	54321.060.001	M12 LE*	10	54321.120.001	M20 LE*	5	54321.200.001
M6 RI*	10	54321.060.002	M12 RI*	10	54321.120.002	M20 RI*	5	54321.200.002
M8 LE*	10	54321.080.001	M14 LE*	5	54321.140.001			
M8 RI*	10	54321.080.002	M14 RI*	5	54321.140.002			

ESS Zacisk linowy z gwintem



Informacje techniczne						
Nr	A	A ₁	A ₂	d	D	WR-ø
54322.030.001	19	11	14	M12	20	3
54322.040.001	21	13	16	M12	20	4
54322.050.001	23	13	18	M12	20	5
54322.060.001	25	15	20	M12	20	6

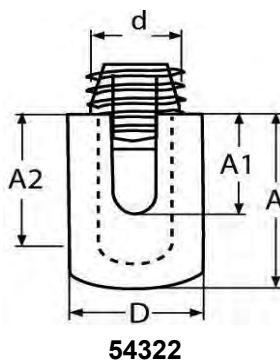

54322

54322	ESS Zacisk linowy z gwintem	MH11
Materiał	Stal nierdzewna A4	
		

WR-ø	☒	Kod artykułu	WR-ø	☒	Kod artykułu	WR-ø	☒	Kod artykułu
3MM*	10	54322.030.001	5MM*	5	54322.050.001	6MM*	5	54322.060.001
4MM*	10	54322.040.001						

ESS Kule pełne z gwintem wewnętrznym



Informacje techniczne

Nr	A	d	D
54323.015.001	6	M6	15
54323.020.001	17	M6	20
54323.025.001	17	M6	25
54323.030.001	18	M6	30
54323.040.001	24	M8	40
54323.050.001	24	M8	50
54324.015.001	6	M6	15
54324.020.001	17	M6	20
54324.025.001	17	M6	25
54324.030.001	18	M6	30
54324.040.001	24	M8	40
54324.050.001	24	M8	50

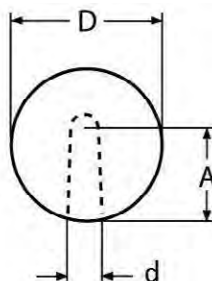



54323-24

Grupy katalogowe

Materiał	Kod	Strona
St.St. A2	54323	13-78
St.St. A2	54324	13-79

54323	SLN Kulka masywna z gwintem wewnętrznym	MH11
Materiał	Stal nierdzewna A2	
		

D	☒	Kod artykułu	D	☒	Kod artykułu	D	☒	Kod artykułu
15MM Blank*	10	54323.015.001	25MM Blank*	10	54323.025.001	40MM Blank*	5	54323.040.001
20MM Blank*	10	54323.020.001	30MM Blank*	10	54323.030.001	50MM Blank*	5	54323.050.001

54324	SLN Kulka masywna z gwintem wewnętrznym, polerowana	MH11
Materiał	Stal nierdzewna A2	
		

D	☒	Kod artykułu	D	☒	Kod artykułu	D	☒	Kod artykułu
15MM POLISHED*	10	54324.015.001	25MM POLISHED*	10	54324.025.001	40MM POLISHED*	5	54324.040.001
20MM POLISHED*	10	54324.020.001	30MM POLISHED*	10	54324.030.001	50MM POLISHED*	5	54324.050.001

ESS Trójkąt dystansowy na ścianę



Informacje techniczne

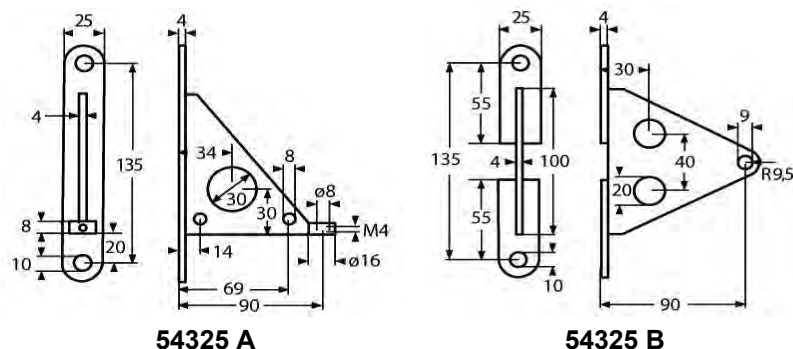

Nr	Typ
54325.000.005	A
54325.100.005	B



54325 A

54325 B

54325	ESS Trójkąt dystansowy na ścianę	MH11
Materiał	Stal nierdzewna A4	
		

Typ	☒	Kod artykułu	
TYPE A 135X90	1	54325.000.005	
TYPE B 135X90	1	54325.100.005	

ESS Podkładka pod trójkąt dystansowy



Informacje techniczne

Nr	D	D ₁	S
54326.058.001	58	14	6

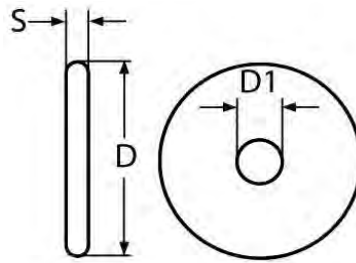

54326

54326	ESS Podkładka pod trójkąt dystansowy	MH11
Materiał	Stal nierdzewna A2	
		

D	 Kod artykułu
58MM*	10 54326.058.001

Hinge



Informacje techniczne

Nr	B	D	L	L ₁	S	S ₁	Typ
54500.076.001	38	-	76	-	4	-	-
54500.100.001	38	-	100	-	4	-	-
54502.100.025	25	-	100	-	4	-	-
54503.160.027	27	-	160	-	4	-	-
54514.180.040	40	5	180	-	2	9	A
54514.180.041	40	5	180	-	2	9	B
54515.160.028	28	4.5	160	80	3	8	-
54517.105.028	28	4.5	105	53	3	8	-
54531.145.038	38	5.5	145	72.5	2	9	-
54532.100.028	28	5.5	100	50	2	9	-
54533.075.038	38	5.5	75	37.5	2	9	-
54533.097.038	38	5.5	97	48.5	2	9	-
54539.102.027	27	3.8	102	51	2	-	-

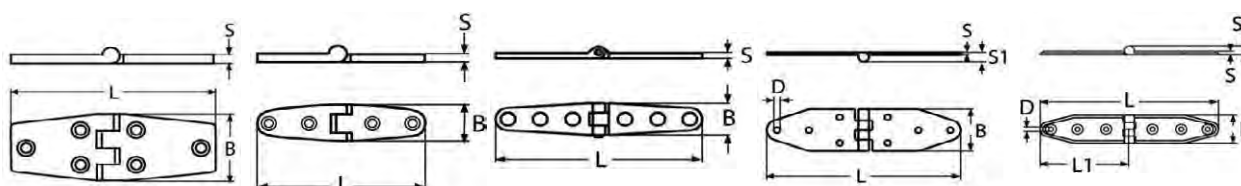

54500

54502

54503

54514

54515

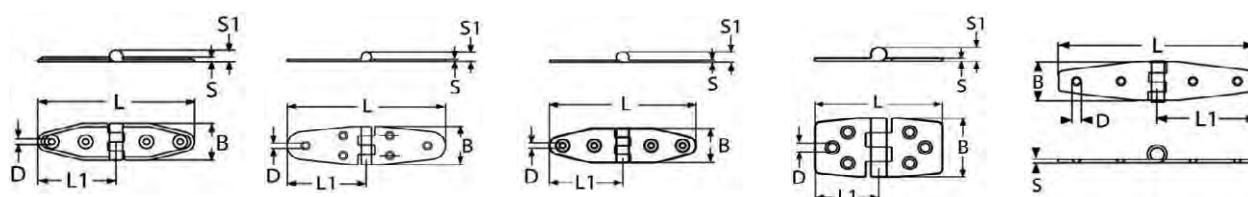

54517

54531

54532

54533

54539

Grupy katalogowe

Material	Kod	Strona
St.St. A4	54500	13-82
St.St. A4	54502	13-82
St.St. A4	54503	13-82
St.St. A2	54514	13-82
St.St. A2	54515	13-82
St.St. A2	54517	13-82
St.St. A2	54531	13-83
St.St. A2	54532	13-83
St.St. A2	54533	13-83
St.St. A2	54539	13-83

54500	Hinge				MH11	
Materiał	Stal nierdzewna A4					



L	<input type="checkbox"/>	Kod artykułu	L	<input type="checkbox"/>	Kod artykułu
76MM	5	54500.076.001	100MM*	5	54500.100.001

54502	Hinge				MH11	
Materiał	Stal nierdzewna A4					



L x B	<input type="checkbox"/>	Kod artykułu
100X25*	5	54502.100.025

54503	Hinge				MH11	
Materiał	Stal nierdzewna A4					



L x B	<input type="checkbox"/>	Kod artykułu
160X27*	5	54503.160.027

54514	Zawias typ A / typ B				MH11	
Materiał	Stal nierdzewna A2					

L x B	<input type="checkbox"/>	Kod artykułu	L x B	<input type="checkbox"/>	Kod artykułu
TYPE A 180X40*	5	54514.180.040	TYPE B 180X40*	5	54514.180.041

54515	Hinge				MH11	
Materiał	Stal nierdzewna A2					

L x B	<input type="checkbox"/>	Kod artykułu
160X28*	5	54515.160.028

54517	Hinge				MH11	
Materiał	Stal nierdzewna A2					

L x B	<input type="checkbox"/>	Kod artykułu
105X28*	5	54517.105.028

54531	Hinge	MH11
Material	Stal nierdzewna A2	
		 

L x B		Kod artykułu
145X38*	5	54531.145.038

54532	Hinge	MH11
Material	Stal nierdzewna A2	
		 

L x B		Kod artykułu
100X28*	5	54532.100.028

54533	Hinge	MH11
Material	Stal nierdzewna A2	
		 

L x B		Kod artykułu	L x B		Kod artykułu
75X38*	5	54533.075.038	97X38*	5	54533.097.038

54539	Hinge	MH11
Material	Stal nierdzewna A2	
		 

L x B		Kod artykułu
102X27*	5	54539.102.027

Zawias niesymetryczny



Informacje techniczne

Nr	B	D	L	L ₁	S	S ₁	Typ
54501.056.038	38	-	56	-	4	-	-
54501.076.038	38	-	76	-	4	-	-
54513.129.040	40	5	129	38	2	9	A
54513.129.041	40	5	129	38	2	9	B
54516.133.028	28	4.5	133	80	3	8	-
54527.058.038	38	5.5	58	40	2	9	-
54527.068.038	38	5.5	68	49	2	9	-
54528.087.038	38	5.5	87	38	2	9	-
54528.097.038	38	5.5	97	40	2	9	-
54530.110.038	38	5.5	110	38	2	9	-
54537.100.054	54	-	100	60	4	-	-
54537.100.075	75	-	152	100	4	-	-
54537.197.098	98	-	197	140	4	-	-
54540.135.027	27	3.8	135	50	2	-	-
54544.180.038	38	-	180	60	2	-	-
54545.070.038	38	-	70	35	2	-	-

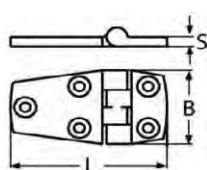

54501

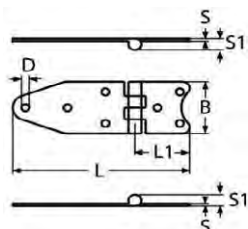

54513

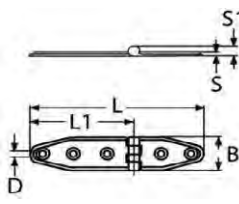

54516

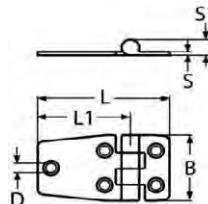

54527

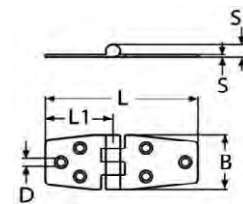

54528

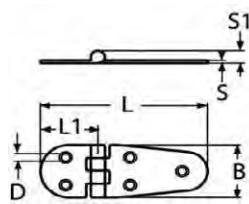

54530

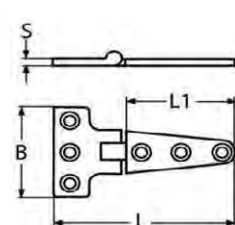

54537

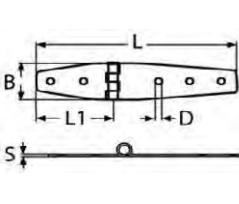

54540

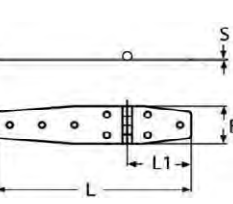

54544

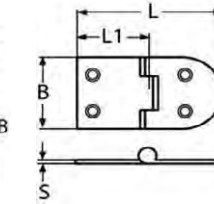

54545

Grupy katalogowe

Material	Kod	Strona
St.St. A4	54501	13-85
St.St. A2	54513	13-85
St.St. A2	54516	13-85
St.St. A2	54527	13-85
St.St. A2	54528	13-85
St.St. A2	54530	13-85
St.St. A4	54537	13-86
St.St. A2	54540	13-86
St.St. A2	54544	13-86

Grupy katalogowe

Material	Kod	Strona
St.St. A2	54545	13-86

54501 Zawias niesymetryczny MH11

Material Stal nierdzewna A4



L x B	☒	Kod artykułu	L x B	☒	Kod artykułu
56X38*	5	54501.056.038	76X38	1	54501.076.038

54513 Zawias niesymetryczny typ A / typ B MH11

Material Stal nierdzewna A2



L x B	☒	Kod artykułu	L x B	☒	Kod artykułu
TYPE A 129X40*	5	54513.129.040	TYPE B 129X40*	5	54513.129.041

54516 Zawias niesymetryczny MH11

Material Stal nierdzewna A2



L x B	☒	Kod artykułu
133X28*	5	54516.133.028

54527 Zawias niesymetryczny MH11

Material Stal nierdzewna A2



L x B	☒	Kod artykułu	L x B	☒	Kod artykułu
58X38*	5	54527.058.038	68X38	5	54527.068.038

54528 Zawias niesymetryczny MH11

Material Stal nierdzewna A2



L x B	☒	Kod artykułu	L x B	☒	Kod artykułu
87X38*	5	54528.087.038	97X38*	5	54528.097.038

54530 Zawias niesymetryczny MH11



Material Stal nierdzewna A2



L x B	☒	Kod artykułu
110X38*	5	54530.110.038

54537	Zawias niesymetryczny	MH11
Materiał	Stal nierdzewna A4	
		 

L x B	✉	Kod artykułu	L x B	✉	Kod artykułu	L x B	✉	Kod artykułu
100X54*	1	54537.100.054	152X75*	1	54537.100.075	197X98*	1	54537.197.098

54540	Zawias niesymetryczny	MH11
Materiał	Stal nierdzewna A2	
		 

L x B	✉	Kod artykułu
135X27*	5	54540.135.027

54544	Zawias niesymetryczny	MH11
Materiał	Stal nierdzewna A2	
		 

L x B	✉	Kod artykułu
180X38*	5	54544.180.038

54545	Zawias niesymetryczny	MH11
Materiał	Stal nierdzewna A2	
		 

L x B	✉	Kod artykułu
70X38*	5	54545.070.038

Zawias odgięty



Informacje techniczne

Nr	B	H	L	L ₁	S
54504.056.038	38	9.5	56	-	4
54504.070.038	38	9.5	76	-	4
54523.152.001	76	-	152	22	3
54526.100.001	87	-	100	33	3
54547.653.821	38	21	65	45	2
54547.653.835	38	35	76	45	2
54548.035.038	38	20	35	15	2

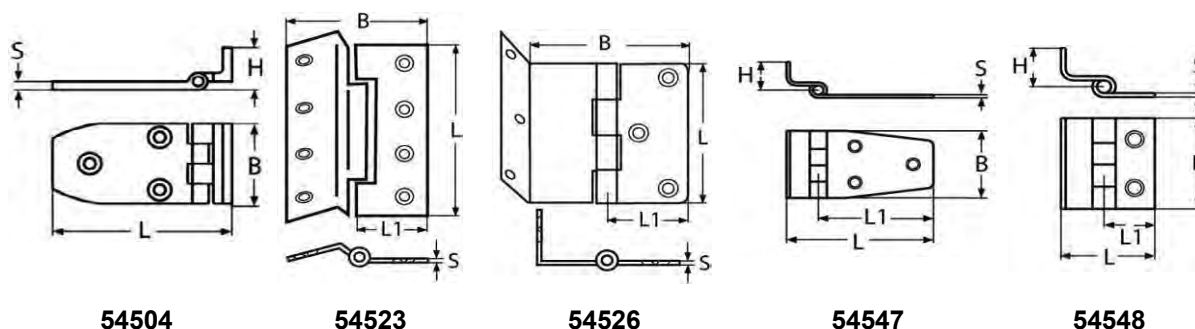

Grupy katalogowe

Material	Kod	Strona
St.St. A4	54504	13-87
St.St. A2	54523	13-87
St.St. A4	54526	13-88
St.St. A2	54547	13-88
St.St. A2	54548	13-88

54504 Zawias odgięty

MH11

Material Stal nierdzewna A4



L x B	☒	Kod artykułu	L x B	☒	Kod artykułu
56X38*	5	54504.056.038	70X38*	5	54504.070.038

54523 Zawias odgięty

MH11

Material Stal nierdzewna A2



L	☒	Kod artykułu
152MM*	1	54523.152.001

54526	Zawias odgięty	MH11
Materiał	Stal nierdzewna A4	 

L	<input type="checkbox"/>	Kod artykułu
100MM*	1	54526.100.001

54547	Zawias odgięty	MH11
Materiał	Stal nierdzewna A2	 

L x B x H	<input type="checkbox"/>	Kod artykułu	L x B x H	<input type="checkbox"/>	Kod artykułu
65X38X21*	5	54547.653.821	65X38X35*	5	54547.653.835

54548	Zawias odgięty	MH11
Materiał	Stal nierdzewna A2	 

L x B	<input type="checkbox"/>	Kod artykułu
35X38*	5	54548.035.038

Zawias



Informacje techniczne

Nr	B	D	L	L ₁	S	S ₁
54505.038.038	38	-	38	-	4	-
54505.050.050	50	-	50	-	4	-
54506.090.038	38	-	90	-	3	-
54508.075.075	75	10	75	-	2	-
54509.100.075	75	11	100	-	2.5	-
54518.038.038	38	5.5	38	19	2	9
54518.068.038	38	5.5	68	34	2	9
54520.049.001	37	-	49	24.5	2	-
54521.050.001	50	-	50	25	2	-
54524.075.001	70	-	75	35	3	-
54525.100.001	71	-	152	35.5	3.5	-
54529.075.038	38	5.5	75	37.5	2	9
54534.050.035	35	3.3	50	-	1.7	8
54534.062.040	40	3.3	62	-	1.7	8
54534.075.048	48	5.5	75	-	1.7	8
54534.100.054	54	6.6	100	-	1.7	8

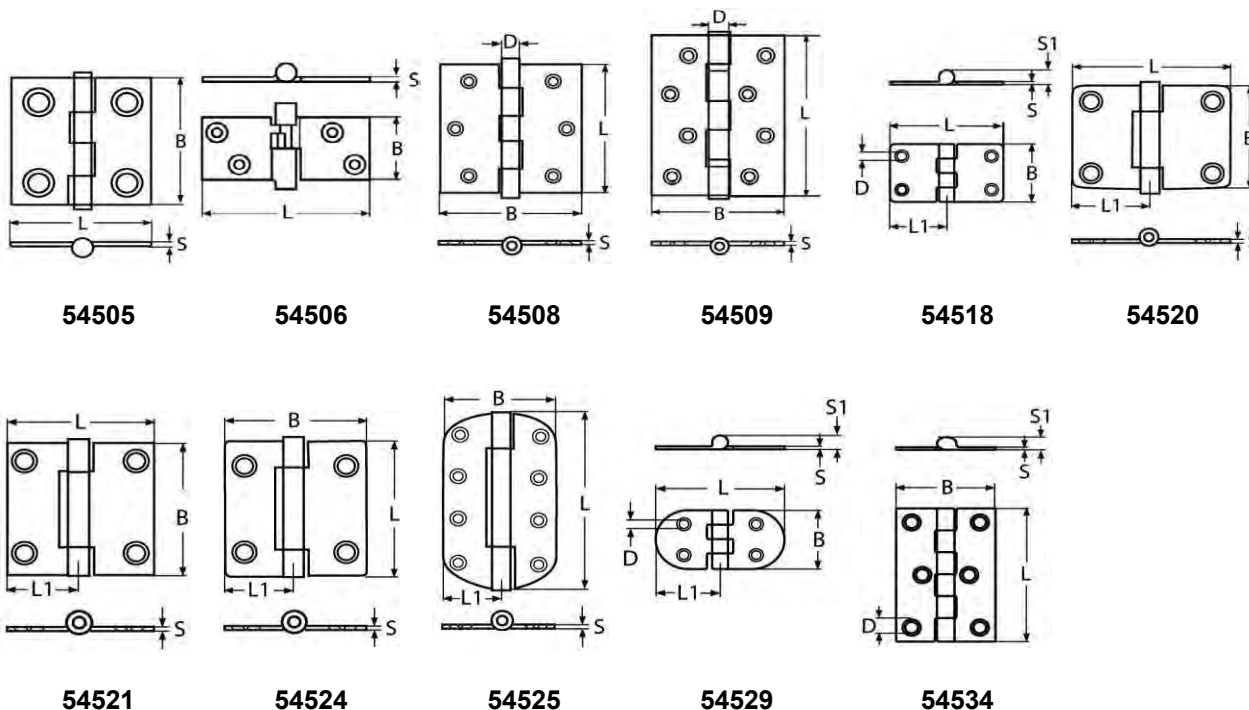

Grupy katalogowe

Material	Kod	Strona
St.St. A4	54505	13-89
St.St. A4	54506	13-89
St.St. A2	54508	13-90
St.St. A2	54509	13-90
St.St. A2	54518	13-90
St.St. A2	54520	13-90
St.St. A2	54521	13-90
St.St. A4	54524	13-90
St.St. A4	54525	13-91
St.St. A2	54529	13-91
St.St. A2	54534	13-91

54505 **Zawias** **MH11**

Material Stal nierdzewna A4



L x B	☒	Kod artykułu	L x B	☒	Kod artykułu
38X38	5	54505.038.038	50X50	5	54505.050.050

54506 **Zawias pokrywy silnika** **MH11**

Material Stal nierdzewna A4



L x B	☒	Kod artykułu
90X38*	5	54506.090.038

54508	Zawias wzmocniony	MH11
Materiał	Stal nierdzewna A2	
		

L x B	<input type="checkbox"/>	Kod artykułu
75X75	5	54508.075.075

54509	Zawias wzmocniony, łożyskowy	MH11
Materiał	Stal nierdzewna A2	
		

L x B	<input type="checkbox"/>	Kod artykułu
100X75*	5	54509.100.075

54518	Zawias	MH11
Materiał	Stal nierdzewna A2	
		

L x B	<input type="checkbox"/>	Kod artykułu	L x B	<input type="checkbox"/>	Kod artykułu
38X38*	5	54518.038.038	68X38*	5	54518.068.038

54520	Zawias	MH11
Materiał	Stal nierdzewna A2	
		

L	<input type="checkbox"/>	Kod artykułu
49MM*	5	54520.049.001

54521	Zawias	MH11
Materiał	Stal nierdzewna A2	
		

L	<input type="checkbox"/>	Kod artykułu
50MM*	5	54521.050.001

54524	Zawias	MH11
Materiał	Stal nierdzewna A4	
		

L	<input type="checkbox"/>	Kod artykułu
75MM*	2	54524.075.001



54525	Zawias	MH11
Materiał	Stal nierdzewna A4	
		 

L		Kod artykułu
152MM*	2	54525.100.001

54529	Zawias	MH11
Materiał	Stal nierdzewna A2	
		 

L x B		Kod artykułu
75X38*	5	54529.075.038

54534	Zawias	MH11
Materiał	Stal nierdzewna A2	
		 

L x B		Kod artykułu	L x B		Kod artykułu	L x B		Kod artykułu
50X35	5	54534.050.035	75X48*	5	54534.075.048	100X54*	5	54534.100.054
62X40*	5	54534.062.040						



Zawias specjalny

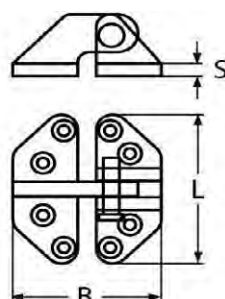

Informacje techniczne			
Nr	B	L	S
54507.074.065	65	74	6



54507

54507	Zawias specjalny	MH11
Materiał	Stal nierdzewna A4	
		

L x B	<input type="checkbox"/>	Kod artykułu
74X65*	2	54507.074.065

Zawias dwuczęściowy



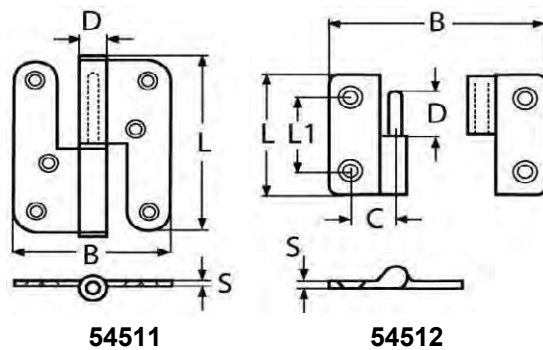

Informacje techniczne

Nr	B	C	D	L	L ₁	S	Typ
54511.100.080	80	-	14	100	-	3	L
54511.100.081	80	-	14	100	-	3	R
54512.037.037	37	12.5	13.5	37	23	2.6	R
54512.137.137	37	12.5	13.5	37	23	2.6	L



Grupy katalogowe

Materiał	Kod	Strona
St.St. A2	54511	13-92
St.St. A4	54512	13-93

54511	Dwuczesciowy zawias drzwiowy, lewy	MH11
Materiał	Stal nierdzewna A2	
		

L x B	<input type="checkbox"/>	Kod artykułu	L x B	<input type="checkbox"/>	Kod artykułu
100X80 Left*	2	54511.100.080	100X80 Right*	1	54511.100.081

54512	Zawias dwustronny, lewy	MH11
Material	Stal nierdzewna A4	
		

L x B	✉	Kod artykułu	L x B	✉	Kod artykułu
37X37 Left*	5	54512.037.037	37X37 Right*	5	54512.137.137

Zawias



Informacje techniczne

Nr	B	D	L	L ₁	S	S ₁
54519.071.001	40	-	71	35.5	2	-
54522.050.001	50	-	50	25	2	-
54538.066.030	30	-	66	33	2	-
54573.070.042	42	6	70	35	2.2	7.5
54574.052.042	42	6	52	26	2.2	7.5

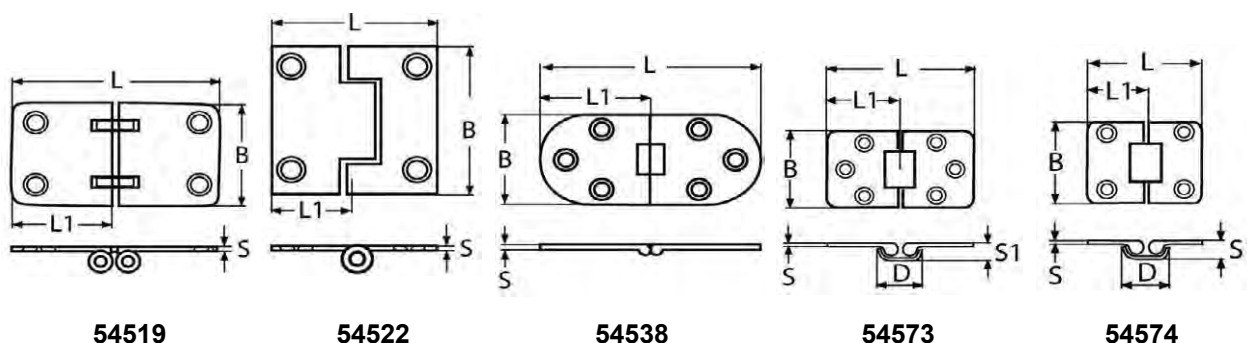

Grupy katalogowe



Material	Kod	Strona
St.St. A2	54519	13-93
St.St. A2	54522	13-94
St.St. A4	54538	13-94
St.St. A4	54573	13-94
St.St. A4	54574	13-94

54519	Zawias	MH11
Material	Stal nierdzewna A2	
		

L	✉	Kod artykułu
71MM*	5	54519.071.001

54522	Zawias	MH11
Materiał	Stal nierdzewna A2	
		

L  **Kod artykułu**
 50MM* 5 [54522.050.001](#)

54538	Zawias	MH11
Materiał	Stal nierdzewna A4	
		

L x B  **Kod artykułu**
 66X30* 5 [54538.066.030](#)

54573	Zawias	MH11
Materiał	Stal nierdzewna A4	
		

L x B  **Kod artykułu**
 70x42* 5 [54573.070.042](#)

54574	Zawias	MH11
Materiał	Stal nierdzewna A4	
		

L x B  **Kod artykułu**
 52X42* 5 [54574.052.042](#)

Zawias



Informacje techniczne

Nr	B	L	S
54535.098.037	37	98	1.5
54536.085.001	30	85	1.5

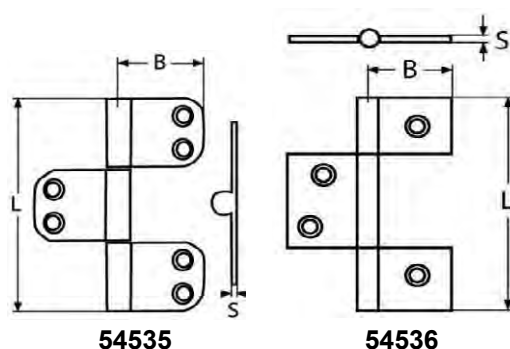

Grupy katalogowe

Material	Kod	Strona
St.St. A4	54535	13-95
St.St. A2	54536	13-95

54535	Zawias	MH11
Material	Stal nierdzewna A4	

L x B	Kod artykułu
98X37*	1 54535.098.037

54536	Zawias do przyspawania	MH11
Material	Stal nierdzewna A2	

L	Kod artykułu
85MM*	5 54536.085.001

Zawias



Informacje techniczne

Nr	B	L	L ₁	S
54541.075.056	78	56	28	2
54542.067.048	48	67	36.5	2
54543.051.035	35	51	25.5	2

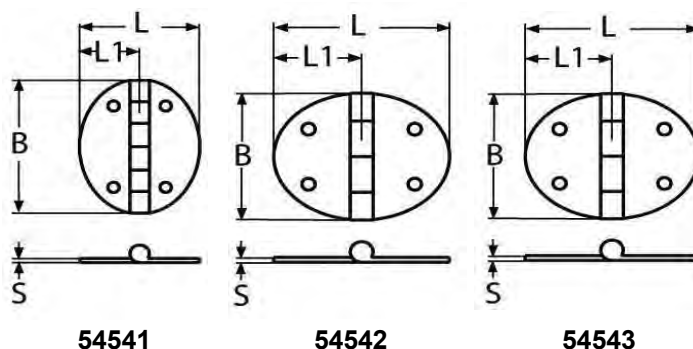

Grupy katalogowe

Material	Kod	Strona
St.St. A2	54541	13-96
St.St. A2	54542	13-96
St.St. A2	54543	13-96

54541 Zawias MH11

Material Stal nierdzewna A2



B x L **Kod artykułu**
78X56* 5 [54541.075.056](#)

54542 Zawias MH11

Material Stal nierdzewna A2



L x B **Kod artykułu**
67X48* 5 [54542.067.048](#)

54543 Zawias MH11

Material Stal nierdzewna A2



L x B		Kod artykułu
51X35*	5	54543.051.035

Zawias



Informacje techniczne					
Nr	B	H	L	L ₁	S
54546.127.047	47	41	127	98	2.5

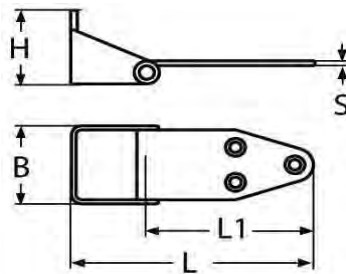

54546

54546	Zawias	MH11
Materiał	Stal nierdzewna A2	 

L x B		Kod artykułu
127X47*	2	54546.127.047

Zawias odlewany



Informacje techniczne

Nr	B	L	L ₁	S
54549.076.040	40	76	30	4
54551.134.065	65	134	21	4
54553.146.065	65	146	51	4
54555.190.065	65	190	95	4
54557.086.065	65	83	32	4
54559.072.065	65	72	21	4
54561.103.065	65	103	21	4
54563.052.061	61	52	19	4
54565.080.065	65	80	33	4
54567.070.040	40	70	30	3.5
54569.126.040	40	126	40	3.5
54571.127.065	65	127	32	4

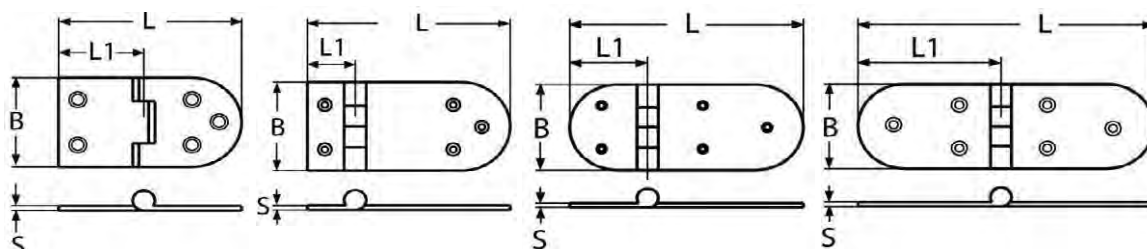

54549

54551

54553-69

54555

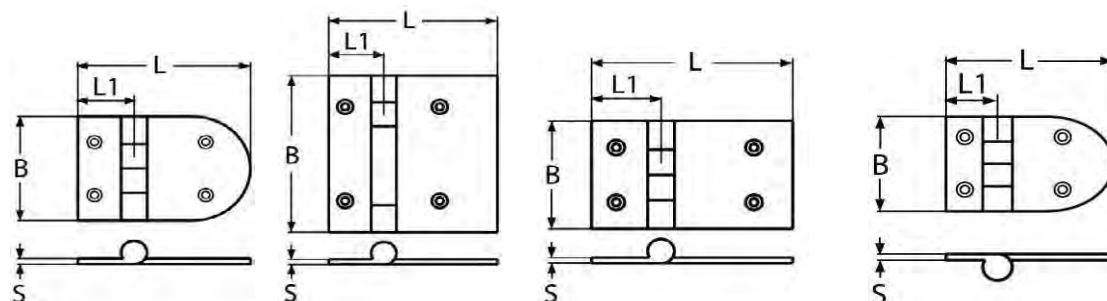

54557-59-61-71

54563

54565

54567

Grupy katalogowe

Material	Kod	Strona
St.St. A4	54549	13-99
St.St. A4	54551	13-99
St.St. A4	54553	13-99
St.St. A4	54555	13-99
St.St. A4	54557	13-99
St.St. A4	54559	13-99
St.St. A4	54561	13-100
St.St. A4	54563	13-100
St.St. A4	54565	13-100
St.St. A4	54567	13-100
St.St. A4	54569	13-100
St.St. A4	54571	13-100

54549	Zawias odlewany	MH11
Materiał	Stal nierdzewna A4	
		 

L x B  **Kod artykułu**
 76X40* 2 [54549.076.040](#)

54551	Zawias odlewany	MH11
Materiał	Stal nierdzewna A4	
		 

L x B  **Kod artykułu**
 134X65* 2 [54551.134.065](#)

54553	Zawias odlewany	MH11
Materiał	Stal nierdzewna A4	
		 

L x B  **Kod artykułu**
 146X65* 2 [54553.146.065](#)

54555	Zawias odlewany	MH11
Materiał	Stal nierdzewna A4	
		 

L x B  **Kod artykułu**
 190X65* 2 [54555.190.065](#)

54557	Zawias odlewany	MH11
Materiał	Stal nierdzewna A4	
		 

L x B  **Kod artykułu**
 83X65* 2 [54557.086.065](#)

54559	Zawias odlewany	MH11
Materiał	Stal nierdzewna A4	
		 

L x B  **Kod artykułu**
 72X65* 2 [54559.072.065](#)

54561	Zawias odlewany	MH11
Materiał	Stal nierdzewna A4	
		 

L x B **Kod artykułu**
 103X65* 2 [54561.103.065](#)

54563	Zawias odlewany	MH11
Materiał	Stal nierdzewna A4	
		 

L x B **Kod artykułu**
 52X61* 2 [54563.052.061](#)

54565	Zawias odlewany	MH11
Materiał	Stal nierdzewna A4	
		 

L x B **Kod artykułu**
 80X65* 2 [54565.080.065](#)

54567	Zawias odlewany	MH11
Materiał	Stal nierdzewna A4	
		 

L x B **Kod artykułu**
 70X40* 2 [54567.070.040](#)

54569	Zawias odlewany	MH11
Materiał	Stal nierdzewna A4	
		 

L x B **Kod artykułu**
 126X40* 2 [54569.126.040](#)

54571	Zawias odlewany	MH11
Materiał	Stal nierdzewna A4	
		 

L x B **Kod artykułu**
 127X65* 2 [54571.127.065](#)

Zawias odlewany, z gwintem



Informacje techniczne

Nr	B	L	L ₁	S
54550.076.040	40	76	30	4
54552.134.065	65	134	21	4
54554.146.065	65	146	51	4
54556.190.065	65	190	95	4
54558.083.065	65	83	32	4
54560.072.065	72	65	21	4
54562.103.065	65	103	21	4
54564.052.061	61	52	19	4
54566.070.040	65	80	33	4
54568.070.040	40	70	30	3.5
54570.126.040	40	126	40	3.5
54572.127.065	65	127	32	4

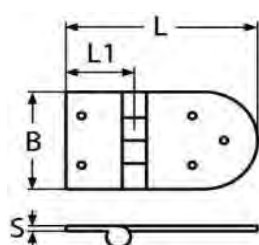

54550-72

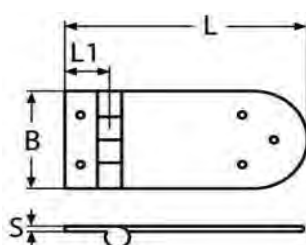

54552

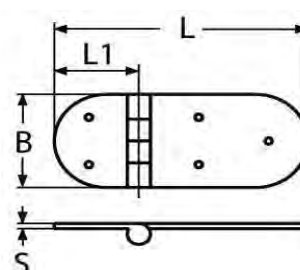

54554-70

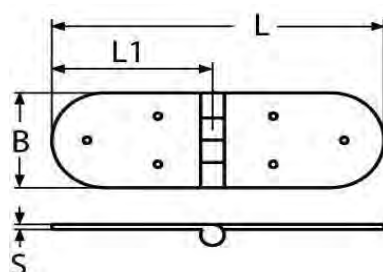

54556

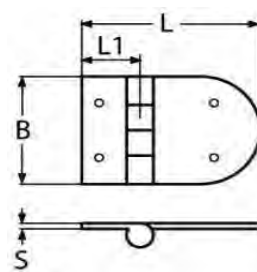

54558-60-62-68

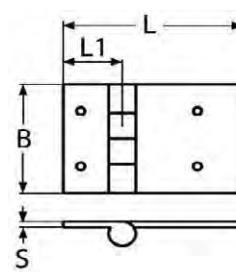



54564-66

Grupy katalogowe



Material	Kod	Strona
St.St. A4	54550	13-102
St.St. A4	54552	13-102
St.St. A4	54554	13-102
St.St. A4	54556	13-102
St.St. A4	54558	13-102
St.St. A4	54560	13-102
St.St. A4	54562	13-103
St.St. A4	54564	13-103
St.St. A4	54566	13-103
St.St. A4	54568	13-103
St.St. A4	54570	13-103
St.St. A4	54572	13-103

54550	Zawias odlewany, z gwintem	MH11
Materiał	Stal nierdzewna A4	
		 



L x B  **Kod artykułu**
 76X40* 2 [54550.076.040](#)

54552	Zawias odlewany, z gwintem	MH11
Materiał	Stal nierdzewna A4	
		 



L x B  **Kod artykułu**
 134X65* 2 [54552.134.065](#)

54554	Zawias odlewany, z gwintem	MH11
Materiał	Stal nierdzewna A4	
		 

L x B  **Kod artykułu**
 146X65* 2 [54554.146.065](#)

54556	Zawias odlewany, z gwintem	MH11
Materiał	Stal nierdzewna A4	
		 

L x B  **Kod artykułu**
 190X65* 2 [54556.190.065](#)

54558	Zawias odlewany, z gwintem	MH11
Materiał	Stal nierdzewna A4	
		 

L x B  **Kod artykułu**
 83X65* 2 [54558.083.065](#)

54560	Zawias odlewany, z gwintem	MH11
Materiał	Stal nierdzewna A4	
		 

L x B  **Kod artykułu**
 72X65* 2 [54560.072.065](#)

54562	Zawias odlewany, z gwintem	MH11
Materiał	Stal nierdzewna A4	
		

L x B  **Kod artykułu**
 103X65* 2 [54562.103.065](#)

54564	Zawias odlewany, z gwintem	MH11
Materiał	Stal nierdzewna A4	
		

L x B  **Kod artykułu**
 52X61* 2 [54564.052.061](#)

54566	Zawias odlewany, z gwintem	MH11
Materiał	Stal nierdzewna A4	
		



L x B  **Kod artykułu**
 80X65* 2 [54566.070.040](#)

54568	Zawias odlewany, z gwintem	MH11
Materiał	Stal nierdzewna A4	
		

L x B  **Kod artykułu**
 70X40* 2 [54568.070.040](#)

54570	Zawias odlewany, z gwintem	MH11
Materiał	Stal nierdzewna A4	
		

L x B  **Kod artykułu**
 126X40* 2 [54570.126.040](#)

54572	Zawias odlewany, z gwintem	MH11
Materiał	Stal nierdzewna A4	
		

L x B  **Kod artykułu**
 127X65* 2 [54572.127.065](#)

Zawias kryty

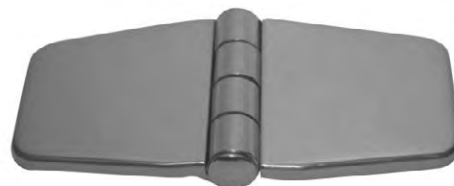

Informacje techniczne

Nr	B	D	L	L ₁	S	S ₁
54576.074.040	40	5.5	74	37	2	9
54577.075.074	75	7.5	74	37	2	9
54578.057.037	37	6	57	18	2	9
54579.036.036	36	6	36	18	2	9

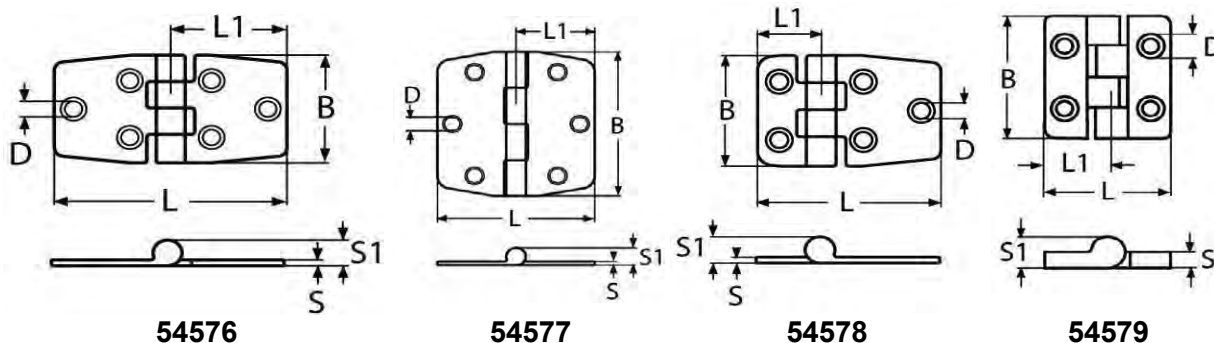

Grupy katalogowe

Material	Kod	Strona
St.St. A4	54576	13-104
St.St. A4	54577	13-104
St.St. A4	54578	13-105
St.St. A4	54579	13-105

54576 Zawias kryty MH11

Material: Stal nierdzewna A4

L x B [Kod artykułu](#)
 74X40* 5 [54576.074.040](#)

54577 Zawias kryty MH11

Material: Stal nierdzewna A4

B x L [Kod artykułu](#)
 75X74* 5 [54577.075.074](#)

54578 **Zawias kryty** **MH11**

Materiał Stal nierdzewna A4





L x B  **Kod artykułu**

57X37* 5 [54578.057.037](#)

54579 **Zawias kryty** **MH11**

Materiał Stal nierdzewna A4

L x B  **Kod artykułu**

36X36* 5 [54579.036.036](#)

Zawias ciągły



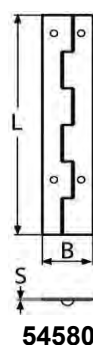

Informacje techniczne			
Nr	B	L	S
54580.007.016	16	3500	0.7
54580.007.018	18	3500	0.7
54580.007.020	20	3500	0.7
54580.007.025	25	3500	0.7
54580.007.032	32	3500	0.7
54580.007.040	40	3500	0.7
54580.015.032	32	2000	1.5
54580.015.040	40	2000	1.5



54580 **Zawias ciągły** **MH11**

Materiał Stal nierdzewna A2





S x B		Kod artykułu	S x B		Kod artykułu	S x B		Kod artykułu
0,7X16MM*	1	54580.007.016	0,7X25MM*	1	54580.007.025	1,5X32MM*	1	54580.015.032
0,7X18MM*	1	54580.007.018	0,7X32MM*	1	54580.007.032	1,5X40MM	1	54580.015.040
0,7X20MM*	1	54580.007.020	0,7X40MM*	1	54580.007.040			

Zamknięcie ryglowe

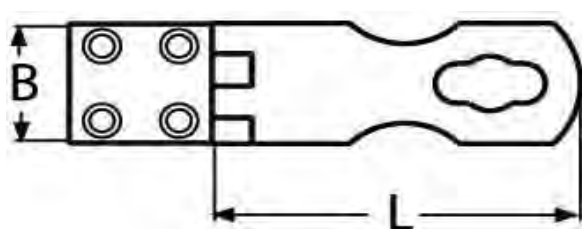

Informacje techniczne

Nr	A	B	C	L	L ₁
54581.071.024	-	24	-	67	-
54582.030.001	30	42	30	98	78



54581

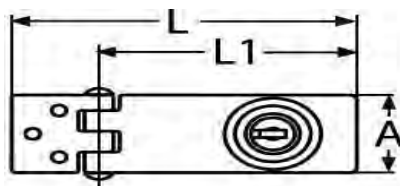

54582

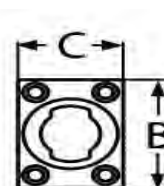

Grupy katalogowe

Material	Kod	Strona
St.St. A2	54581	13-106
St.St. A2	54582	13-106

54581	Zamknięcie ryglowe	MH11
Material	Stal nierdzewna A2	

L x B	<input type="checkbox"/>	Kod artykułu
67X24	5	54581.071.024

54582	Zamknięcie ryglowe z zamkiem	MH11
Material	Stal nierdzewna A2	

A	<input type="checkbox"/>	Kod artykułu
30MM*	1	54582.030.001

Zatrząsk ryglowy



Informacje techniczne

Nr	A	B	C	d	D	H	L	L ₁	L ₂	S
54583.080.028	-	28	-	-	-	-	80	-	-	-
54584.037.037	37	37	-	-	-	20	-	-	-	4
54585.037.037	37	37	-	-	-	20	-	-	-	4
54586.080.028	-	28	-	-	-	-	75	25	50	-
54597.070.001	72	35	24	-	-	-	-	-	-	-
54598.065.075	20	18	26	M4	41	-	65-75	-	-	-
54598.085.095	20	18	26	M5	15	-	85-95	-	-	-
54598.115.125	29	25	30	M6	18	-	115-125	-	-	-
54598.165.185	30	35	30	M8	18	-	165-185	-	-	-

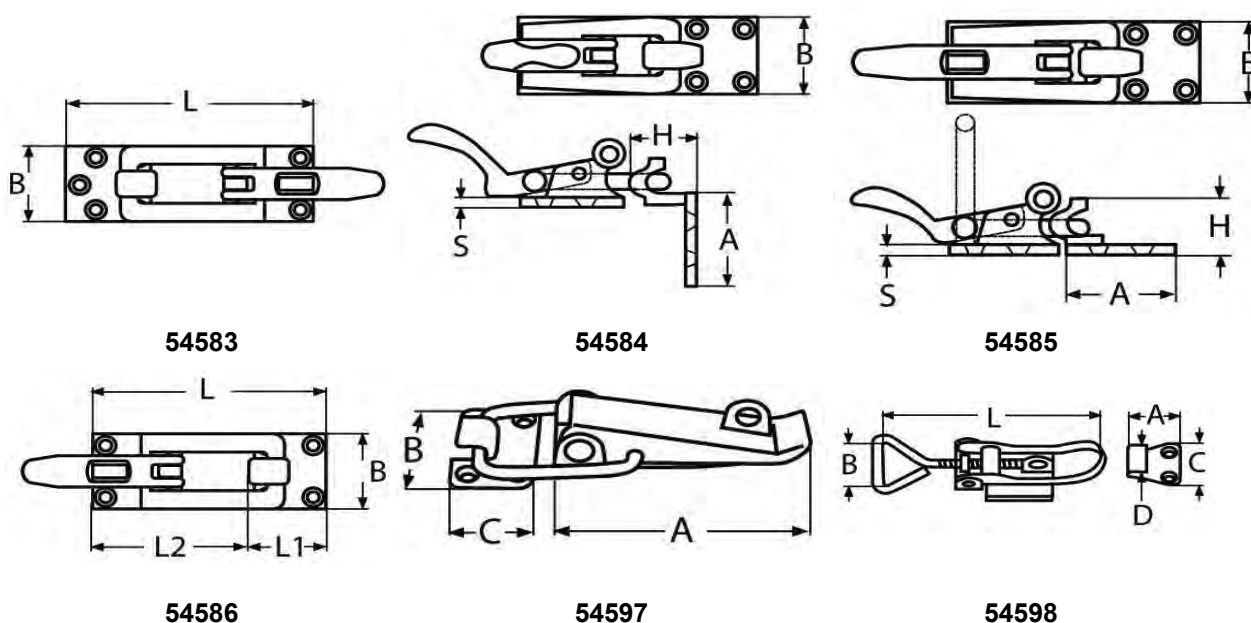

Grupy katalogowe

Material	Kod	Strona
St.St. A4	54583	13-107
St.St. A4	54584	13-108
St.St. A4	54585	13-108
St.St. A4	54586	13-108
St.St. A2	54597	13-108
St.St. A2	54598	13-108

54583 Zatrząsk ryglowy z zamkiem

MH11

Material Stal nierdzewna A4



L x B Kod artykułu
80X28* 1 [54583.080.028](#)

54584	Zatrask ryglowy	MH11
Materiał	Stal nierdzewna A4	
		



A x B **Kod artykułu**
 37X37MM* 1 [54584.037.037](#)

54585	Zatrask ryglowy	MH11
Materiał	Stal nierdzewna A4	
		

A x B **Kod artykułu**
 37X37MM* 1 [54585.037.037](#)

54586	Zatrask ryglowy	MH11
Materiał	Stal nierdzewna A4	
		

L x B **Kod artykułu**
 75X28* 1 [54586.080.028](#)

54597	Zasuwa napinająca z możliwością zakluczenia	MH11
Materiał	Stal nierdzewna A2	
		

A **Kod artykułu**
 72MM* 1 [54597.070.001](#)

54598	Snag	MH11
Materiał	Stal nierdzewna A2	
		

L	<input type="checkbox"/>	Kod artykułu	L	<input type="checkbox"/>	Kod artykułu	L	<input type="checkbox"/>	Kod artykułu
65-75MM*	1	54598.065.075	115-125MM	1	54598.115.125	165-185MM*	1	54598.165.185
85-95MM*	1	54598.085.095						

Zasuwa



Informacje techniczne

Nr	A	B	C	D	E	Grubość
54594.072.001	72	27	-	30	-	-
54595.091.001	91	56	9	16	54	-
54596.015.045	45	30	15	9.5	-	2.3
54596.036.076	76	38	36	9.5	-	4

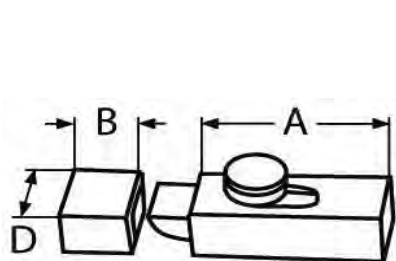

54594

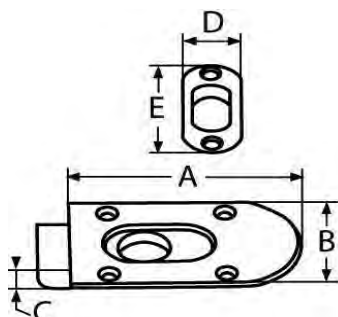

54595

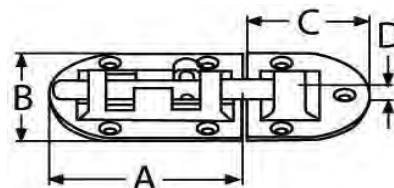

54596

Grupy katalogowe

Material	Kod	Strona
St.St. A4	54594	13-109
St.St. A4	54595	13-109
St.St. A4	54596	13-110

54594 Zasuwa do drzwi, sprężynowa

MH11

Material Stal nierdzewna A4



A **Kod artykułu**
72MM* 1 [54594.072.001](#)

54595 Zasuwa

MH11

Material Stal nierdzewna A4



A **Kod artykułu**
91MM* 1 [54595.091.001](#)

54596	Zasuwa zawiasowa	MH11
Materiał	Stal nierdzewna A4	
		 

C x A	<input type="checkbox"/>	Kod artykułu	C x A	<input type="checkbox"/>	Kod artykułu
15X45*	1	54596.015.045	36X76*	1	54596.036.076

Podnośnik denny



Informacje techniczne

Nr	A	B	C	D	Grubość	H	L	L ₁	L ₂	Typ
54587.063.063	73	-	-	63	-	-	63	-	-	Square
54587.063.163	73	-	-	63	-	-	60	-	-	Round
54588.060.001	60	41	50	33	-	-	-	-	-	-
54589.050.001	-	-	-	50	6	19	-	-	-	-
54590.050.050	-	50	-	-	6	-	50	-	-	-
54591.061.001	61	50	33	-	-	-	-	-	-	-
54603.050.001	50	55	-	-	-	-	32	30	65	-

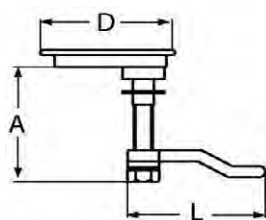

54587

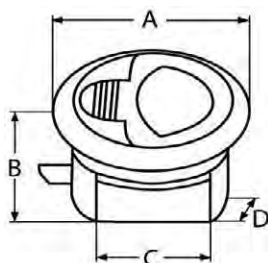

54588

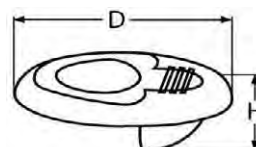

54589

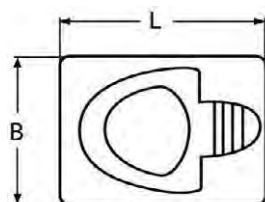

54590

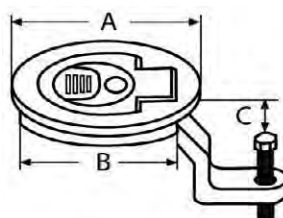

54591

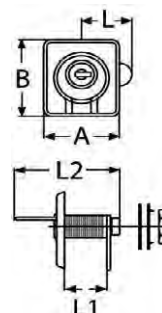

54603

Grupy katalogowe

Materiał	Kod	Strona
St.St. A4	54587	13-111
St.St. A4	54588	13-111
St.St. A4	54589	13-111
St.St. A4	54590	13-111
St.St. A4	54591	13-111
St.St. A4	54603	13-111

54587	Podnośnik denny, kwadratowy	MH11
Materiał	Stal nierdzewna A4	
		

D x A	✉	Kod artykułu	D x A	✉	Kod artykułu
63X63 Square*	1	54587.063.063	63 Round*	1	54587.063.163

54588	Podnośnik denny, z osłoną	MH11
Materiał	Stal nierdzewna A4	
		

A	✉	Kod artykułu
60MM*	1	54588.060.001

54589	Podnośnik denny, okrągły	MH11
Materiał	Stal nierdzewna A4	
		

D	✉	Kod artykułu
50MM*	1	54589.050.001

54590	Podnośnik denny, kwadratowy	MH11
Materiał	Stal nierdzewna A4	
		

L x B	✉	Kod artykułu
50X50*	1	54590.050.050

54591	Podnośnik denny, z zamknięciem, okrągły	MH11
Materiał	Stal nierdzewna A4	

A	✉	Kod artykułu	A	✉	Kod artykułu
Spare key*	1	54591.001.770	61MM*	1	54591.061.001

54603	Podnośnik denny, z zamknięciem	MH11
Materiał	Stal nierdzewna A4	
		

A	✉	Kod artykułu
50MM*	1	54603.050.001

Podnośnik denny



Informacje techniczne

Nr	B	L	S	S ₁
54600.047.038	38	47	-	-
54601.063.044	44	63	-	-
54602.075.056	56	75	-	-
54604.090.001	25	90	3	33

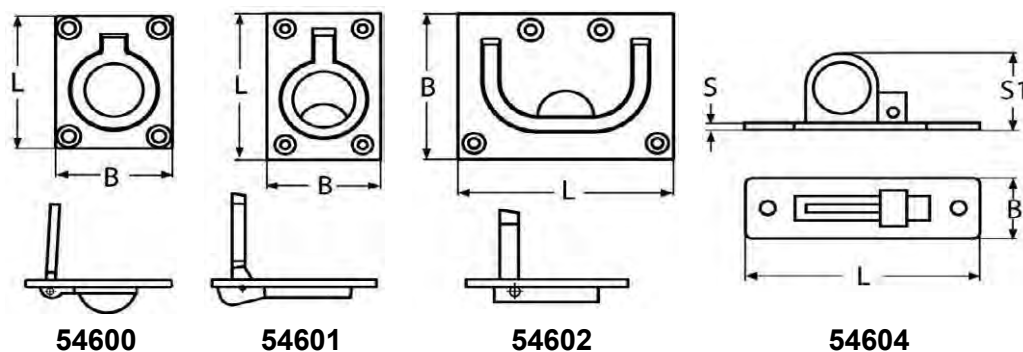

Grupy katalogowe

Material	Kod	Strona
St.St. A4	54600	13-112
St.St. A4	54601	13-112
St.St. A4	54602	13-113
St.St. A2	54604	13-113

54600	Podnośnik denny	MH11
Material	Stal nierdzewna A4	

L x B	<input type="checkbox"/>	Kod artykułu
47X38*	1	54600.047.038

54601	Podnośnik denny	MH11
Material	Stal nierdzewna A4	

L x B	<input type="checkbox"/>	Kod artykułu
63X44*	1	54601.063.044

54602	Podnośnik denny	MH11
Materiał	Stal nierdzewna A4	
		

L x B		Kod artykułu
75X56*	1	54602.075.056

54604	Podnośnik denny	MH11
Materiał	Stal nierdzewna A2	
		

L		Kod artykułu
90MM*	1	54604.090.001

Hak bramkowy



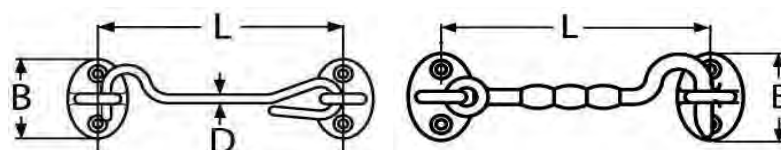

Informacje techniczne					
Nr	B	D	Długość (mm)	Grubość	L
54592.050.001	33	4.4	-	-	50
54592.070.001	33	4.4	-	-	70
54592.090.001	33	4.4	-	-	90
54593.100.001	37.5	-	-	-	100
54599.080.001	-	-	80	3.9	-
54599.120.001	-	-	120	4.4	-







54592

54593

Grupy katalogowe		
Materiał	Kod	Strona
St.St. A4	54592	13-114
St.St. A4	54593	13-114
St.St. A2	54599	13-114

54592 Hak bramkowy		MH11	
Materiał	Stal nierdzewna A4		
			
			
L	☒	Kod artykułu	L
50MM*	5	54592.050.001	70MM*
			5
			54592.070.001
			90MM*
			5
			54592.090.001

54593 Hak bramkowy		MH11	
Materiał	Stal nierdzewna A4		
			
			
L	☒	Kod artykułu	
100MM*	1	54593.100.001	

54599 Zamknięcie bramkowe z haczykami		MH11	
Materiał	Stal nierdzewna A2		
			
			
Długość	☒	Kod artykułu	Długość
80MM*	5	54599.080.001	120MM*
			5
			54599.120.001

Hak na płaszcze



Informacje techniczne

Nr	A	B	C	D	H	H ₁	L	L ₁	S
54605.032.500	-	17	-	-	32.5	14	32.5	20	-
54605.043.001	-	22	-	-	47.5	21	43	30	-
54606.035.001	-	23	16	-	44	-	35	21.5	-
54606.043.001	-	25	18	-	56	-	43	30	-
54607.047.001	-	-	18.5	28	37	-	47	-	3
54607.065.001	-	-	22.5	35	44	-	65	-	4
54608.040.030	-	30	-	-	-	-	40	-	-
54609.030.025	-	30	-	-	-	-	40	-	-
54610.035.033	-	33	-	-	-	-	35	-	-
54611.100.001	10	60	-	-	-	-	35	-	-
54612.120.001	12	36	-	-	-	-	48	-	-
54613.060.001	6	30	-	-	-	-	-	-	-
54614.055.038	-	43	20	-	-	-	55	-	-
54615.050.001	50	50	28	10	-	-	-	-	-

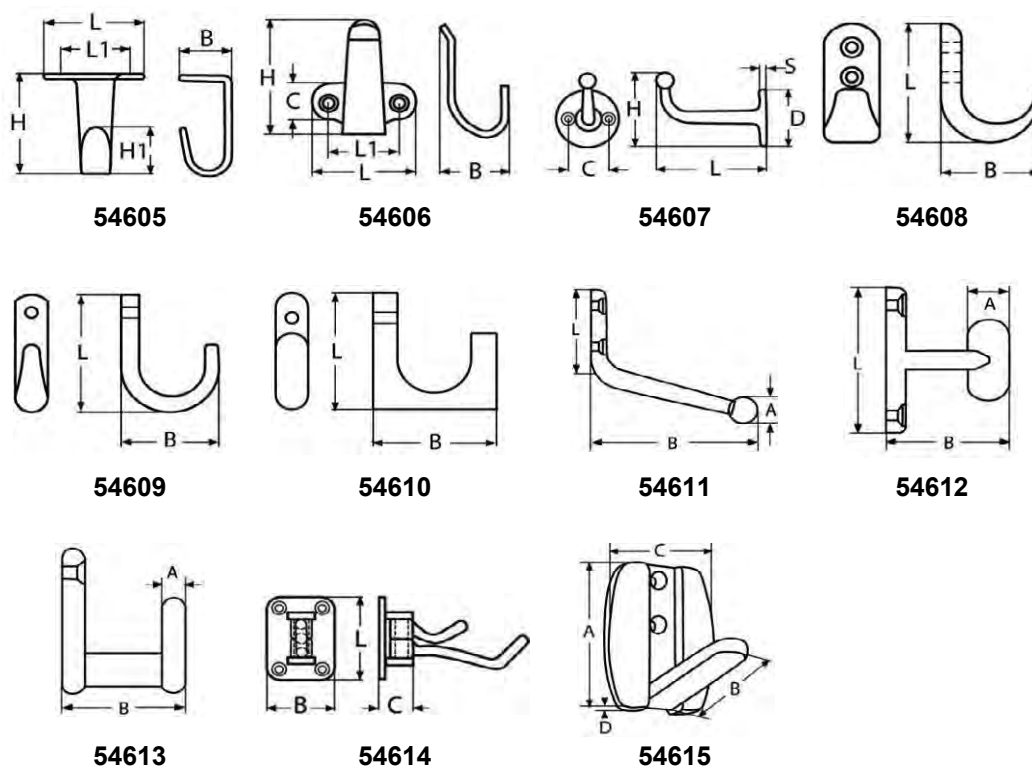

Grupy katalogowe

Material	Kod	Strona
St.St. A2	54605	13-115
St.St. A2	54606	13-115
St.St. A2	54607	13-116
St.St. A2	54608	13-116
St.St. A2	54609	13-116
St.St. A2	54610	13-116
St.St. A2	54611	13-116
St.St. A2	54612	13-116
St.St. A2	54613	13-117
St.St. A2	54614	13-117
St.St. A4	54615	13-117

54605 Hak, polerowany MH11

Material Stal nierdzewna A2

L	☒	Kod artykułu	L	☒	Kod artykułu
32,5MM*	10	54605.032.500	43MM*	10	54605.043.001

54606 Hak, polerowany MH11

Material Stal nierdzewna A2





L	☒	Kod artykułu	L	☒	Kod artykułu
35MM*	10	54606.035.001	43MM*	10	54606.043.001

54607	Hak, polerowany	MH11
Materiał	Stal nierdzewna A2	
		

L	<input type="checkbox"/>	Kod artykułu	L	<input type="checkbox"/>	Kod artykułu
47MM*	10	54607.047.001	65MM*	10	54607.065.001

54608	Hak, polerowany	MH11
Materiał	Stal nierdzewna A2	
		

L x B	<input type="checkbox"/>	Kod artykułu
40X30*	10	54608.040.030

54609	Hak, polerowany	MH11
Materiał	Stal nierdzewna A2	
		



L x B	<input type="checkbox"/>	Kod artykułu
30X25*	10	54609.030.025

54610	Hak, polerowany	MH11
Materiał	Stal nierdzewna A2	
		

L x B	<input type="checkbox"/>	Kod artykułu
35X33*	10	54610.035.033

54611	Haczyk z kulką	MH11
Materiał	Stal nierdzewna A2	
		

A	<input type="checkbox"/>	Kod artykułu
10MM*	10	54611.100.001

54612	Hak z czopem	MH11
Materiał	Stal nierdzewna A2	
		

A	<input type="checkbox"/>	Kod artykułu
12MM*	10	54612.120.001

54613	Hak kabinowy	MH11
Materiał	Stal nierdzewna A2	
		

A  **Kod artykułu**
 6MM* 10 [54613.060.001](#)

54614	Hak ruchomy	MH11
Materiał	Stal nierdzewna A2	
		

L x B  **Kod artykułu**
 55X38* 5 [54614.055.038](#)

54615	Hak (wieszak) składany	MH11
Materiał	Stal nierdzewna A4	
		

A  **Kod artykułu**
 50MM* 5 [54615.050.001](#)

Hak wkręcany



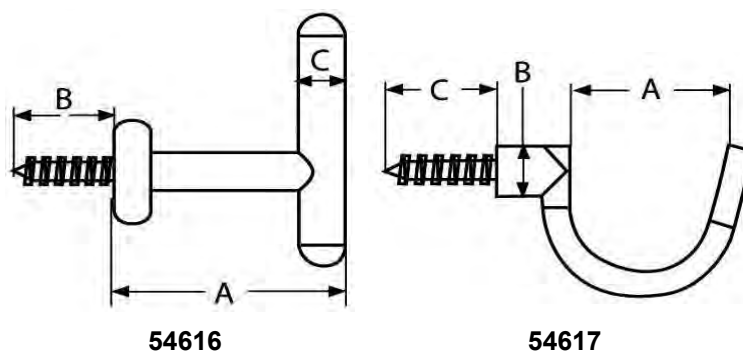

Informacje techniczne			
Nr	A	B	C
54616.040.001	40	17	8
54617.026.001	26	9	18



Grupy katalogowe		
Materiał	Kod	Strona
St.St. A2	54616	13-118
St.St. A2	54617	13-118

54616	Hak wkręcany	MH11
Materiał	Stal nierdzewna A2	
		

A **Kod artykułu**
 40MM* 10 [54616.040.001](#)

54617	Hak wkręcany	MH11
Materiał	Stal nierdzewna A2	
		

A **Kod artykułu**
 26MM* 10 [54617.026.001](#)

Hak S-kształtny



Informacje techniczne

Nr	B	C	D	L	S	S ₁	S ₂	W	W ₁	W ₂	Ø
54618.030.001	-	-	-	30	-	5	10	-	9	16	3
54618.040.001	-	-	-	36	-	6	12	-	12	19	4
54618.050.001	-	-	-	43	-	6	12	-	14	21	5
54618.060.001	-	-	-	50	-	7	15	-	15	25	6
54618.080.001	-	-	-	67	-	9	20	-	20	33	8
54619.030.001	-	-	-	24	4	-	-	9	-	-	3
54619.040.001	-	-	-	32	6	-	-	12	-	-	4
54619.050.001	-	-	-	40	8	-	-	15	-	-	5
54619.060.001	-	-	-	48	9	-	-	17	-	-	6
54619.080.001	-	-	-	64	12	-	-	24	-	-	8
54619.100.001	-	-	-	80	13	-	-	30	-	-	10
54620.095.001	17	19.5	6.9	90	-	-	-	-	-	-	9.5
54620.110.001	17	22	7	100	-	-	-	-	-	-	11
54620.130.001	17	22	8	112	-	-	-	-	-	-	13
54621.050.001	9	9	2	52	-	-	-	-	-	-	5
54621.060.001	10	10	5	64	-	-	-	-	-	-	6
54621.080.001	16	17	5	75	-	-	-	-	-	-	8
54621.100.001	20	20	8	95	-	-	-	-	-	-	10

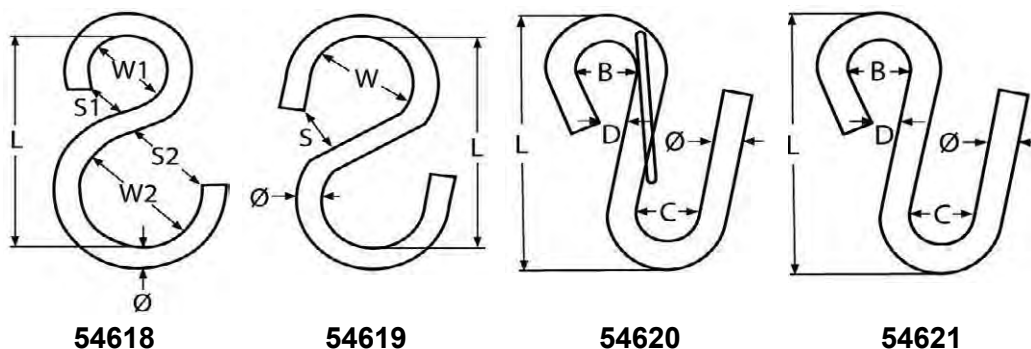

Grupy katalogowe

Material	Kod	Strona
St.St. A2	54618	13-119
St.St. A2	54619	13-119
St.St. A4	54620	13-119
St.St. A4	54621	13-119

54618 Hak S-kształtny, asymetryczny MH11

Material	Stal nierdzewna A2		
			

∅	☒	Kod artykułu	∅	☒	Kod artykułu	∅	☒	Kod artykułu
3MM*	20	54618.030.001	5MM	20	54618.050.001	8MM*	10	54618.080.001
4MM*	20	54618.040.001	6MM*	10	54618.060.001			

54619 Hak S-kształtny, symetryczny MH11

Material	Stal nierdzewna A2		
			

∅	☒	Kod artykułu	∅	☒	Kod artykułu	∅	☒	Kod artykułu
3MM*	20	54619.030.001	5MM*	20	54619.050.001	8MM*	10	54619.080.001
4MM	20	54619.040.001	6MM*	10	54619.060.001	10MM*	5	54619.100.001

54620 Hak S-kształtny z zabezpieczeniem MH11

Material	Stal nierdzewna A4		
			

∅	☒	Kod artykułu	∅	☒	Kod artykułu	∅	☒	Kod artykułu
9,5MM*	5	54620.095.001	11,0MM*	5	54620.110.001	13,0MM*	5	54620.130.001

54621 Hak S-kształtny, specjalny MH11

Material	Stal nierdzewna A4		
			

∅	☒	Kod artykułu	∅	☒	Kod artykułu	∅	☒	Kod artykułu
5MM*	10	54621.050.001	8MM*	10	54621.080.001	10MM*	5	54621.100.001
6MM*	10	54621.060.001						

Hak prosty otwarty



Informacje techniczne

Nr	L	W	ø
54622.029.040	40	12	2.9
54622.033.050	50	16	3.3
54622.033.060	60	16	3.3
54622.044.050	50	16	4.4
54622.048.065	65	22	4.8
54622.052.080	80	26	5.2
54622.058.100	100	26	5.8

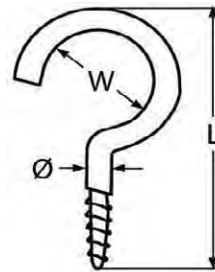

54622

54622	Hak prosty otwarty	MH11
Materiał	Stal nierdzewna A4	

ø x L	☒	Kod artykułu	ø x L	☒	Kod artykułu	ø x L	☒	Kod artykułu
2,9X40*	100	54622.029.040	4,4X50*	50	54622.044.050	5,2X80*	20	54622.052.080
3,3X50*	100	54622.033.050	4,8X65*	50	54622.048.065	5,8X100*	20	54622.058.100
3,3X60*	100	54622.033.060						



Hak do zasłon, zamknięte oko



Informacje techniczne

Nr	A	B	D	D ₁	H	L	L ₁
54623.100.001	30	35	10	4.5	-	20	22
54624.080.001	8	34	-	-	24	36	-
54624.110.001	11	34	-	-	34	42	-

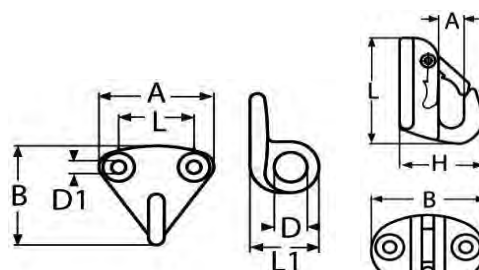

54623

54624

Grupy katalogowe

Material	Kod	Strona
St.St. A4	54623	13-121
St.St. A4	54624	13-121

54623	Hak do zasłon, zamknięte oko	MH11
Material	Stal nierdzewna A4	
		

D	 Kod artykułu
10MM*	10 54623.100.001

54624	Hak odbojnicy	MH11
Material	Stal nierdzewna A4	
		

A	 Kod artykułu	A	 Kod artykułu
8MM*	5 54624.080.001	11MM*	5 54624.110.001

Wspornik



Informacje techniczne

Nr	B	C	E	L	L ₁	L ₂	S
54625.031.012	12	-	-	31	25	12	3
54625.046.013	13	-	-	46	38	18	3
54625.061.015	15	-	-	61	51	21	3
54626.041.025	25	-	-	41	35	18	3
54626.056.035	35	-	-	56	47.5	18.5	3
54626.080.050	50	-	-	80	71	24	4
54627.150.001	30	5	5	150	-	-	-
54627.200.001	30	5	5	200	-	-	-
54627.250.001	30	5	5	250	-	-	-
54627.300.001	30	5	5	300	-	-	-

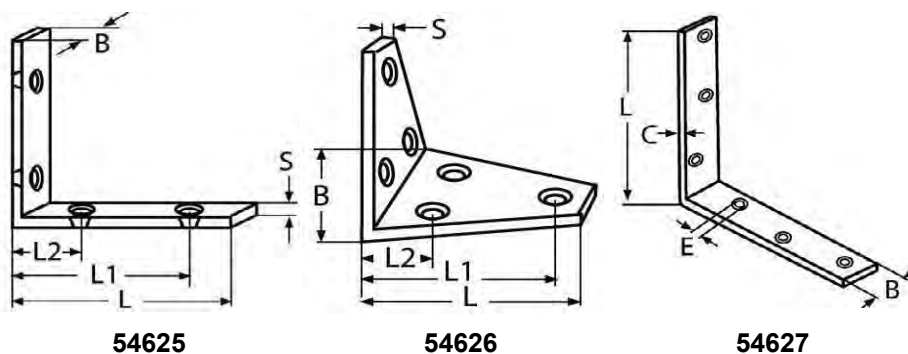

Grupy katalogowe

Material	Kod	Strona
St.St. A2	54625	13-122
St.St. A2	54626	13-122
St.St. A2	54627	13-123

54625 Wspornik 90 st., polerowany MH11

Material: Stal nierdzewna A2

L x B	☒	Kod artykułu	L x B	☒	Kod artykułu	L x B	☒	Kod artykułu
31X12*	10	54625.031.012	46X13*	10	54625.046.013	61X15*	10	54625.061.015

54626 Wspornik 90 st., trójkątny, polerowany MH11

Material: Stal nierdzewna A2

L x B	☒	Kod artykułu	L x B	☒	Kod artykułu	L x B	☒	Kod artykułu
41X25*	10	54626.041.025	56X35*	10	54626.056.035	80X50*	10	54626.080.050

54627	Wspornik 90 st.	MH11
Material	Stal nierdzewna A2	
		



L	☒	Kod artykułu	L	☒	Kod artykułu	L	☒	Kod artykułu
150MM*	2	54627.150.001	250MM*	2	54627.250.001	300MM*	2	54627.300.001
200MM*	2	54627.200.001						

Hak elastyczny wielozwojowy



Informacje techniczne

Nr	∅
54628.060.001	6
54628.080.001	8
54628.100.001	10

54628	Hak elastyczny wielozwojowy	MH11
Material	Stal nierdzewna A2	
		

∅	☒	Kod artykułu	∅	☒	Kod artykułu	∅	☒	Kod artykułu
6MM*	20	54628.060.001	8MM*	20	54628.080.001	10MM*	20	54628.100.001

Hak otwarty z gwintem



Informacje techniczne

Nr	A	B	d	D	L
54629.079.001	36	16	5/16	41	89

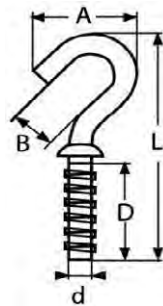

54629

54629	Hak otwarty z gwintem	MH11
Materiał	Stal nierdzewna A4	
		

GW		Kod artykułu
5/16**	10	54629.079.001

Przeplot do lin



Informacje techniczne

Nr	B	C	d	D	L	L ₁	ø
54630.100.060	-	-	M10	60	100	50	9
54630.125.090	-	-	M12	90	125	65	12
54631.092.062	62	50	M8	-	92	-	-

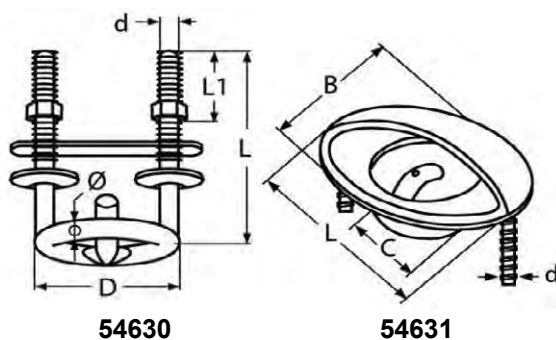

Grupy katalogowe

Material	Kod	Strona
St.St. A4	54630	13-125
St.St. A4	54631	13-125

54630 Przeplot do lin

MH11

Material Stal nierdzewna A4



L x D	☒	Kod artykułu	L x D	☒	Kod artykułu
100X60*	1	54630.100.060	125X90*	1	54630.125.090

54631 Przeplot do lin

MH11

Material Stal nierdzewna A4



L x B	☒	Kod artykułu
92X62*	1	54631.092.062

Blokada (zatrząsk) do drzwi



Informacje techniczne

Nr	A	B	B ₁	C	H	L	L ₁	S
54632.029.001	-	22	25	-	-	29	34	-
54632.041.001	-	70	31	-	-	41	40.5	-
54632.042.001	-	40	31	-	-	42	41	-
54633.090.050	9	29	50	-	12	-	-	2
54634.034.034	34	34	-	-	-	-	-	-
54635.034.034	34	34	-	-	-	-	-	-
54636.051.115	-	51	-	25	-	90-115	-	-
54637.051.025	-	51	-	25	-	90-115	-	-
54638.080.001	-	-	-	-	-	40	60	-

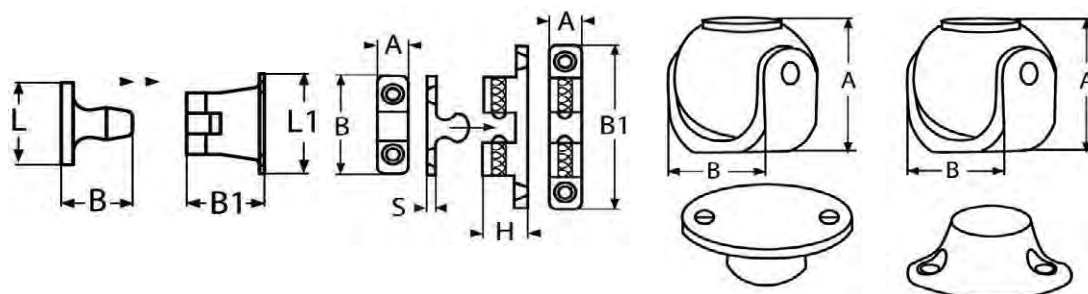

54632

54633

54634

54635

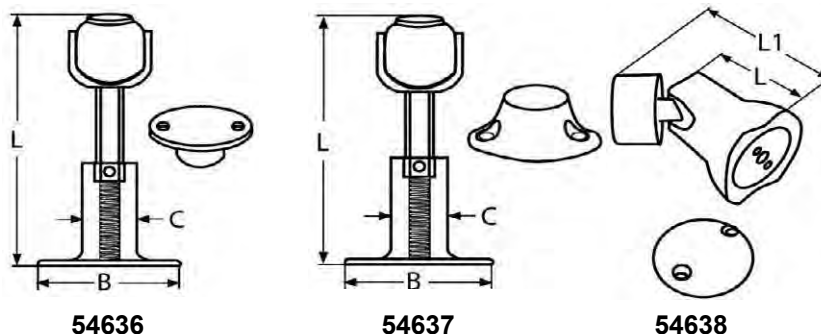

54636

54637

54638

Grupy katalogowe

Material	Kod	Strona
St.St. A2	54632	13-127
St.St. A4	54633	13-127
St.St. A4	54634	13-127
St.St. A4	54635	13-127
St.St. A4	54636	13-127
St.St. A4	54637	13-127
St.St. A4	54638	13-128

54632	Blokada (zatrask) do drzwi	MH11
Materiał	Stal nierdzewna A2	
		 

L	☒	Kod artykułu	L	☒	Kod artykułu	L	☒	Kod artykułu
29MM*	5	54632.029.001	41MM*	5	54632.041.001	42MM*	5	54632.042.001

54633	Zatrask kulkowy	MH11
Materiał	Stal nierdzewna A4	
		 

A x B ₁	☒	Kod artykułu
9X50	5	54633.090.050

54634	Magnetyczny stoper do drzwi	MH11
Materiał	Stal nierdzewna A4	
		 

A x B	☒	Kod artykułu
34X34*	5	54634.034.034

54635	Magnetyczny stoper do drzwi, nastawny z płytką	MH11
Materiał	Stal nierdzewna A4	
		 

A x B	☒	Kod artykułu
34X34*	1	54635.034.034

54636	Magnetyczny stoper do drzwi, regulowany	MH11
Materiał	Stal nierdzewna A4	
		 

B x A	☒	Kod artykułu
51X115*	2	54636.051.115

54637	Magnetyczny stoper do drzwi, nastawny z płytką	MH11
Materiał	Stal nierdzewna A4	
		 

B x A	☒	Kod artykułu
51X25*	1	54637.051.025

54638	Uchwyt magnetyczny, uchylny	MH11
Materiał	Stal nierdzewna A4	

Wymiary	<input type="checkbox"/>	Kod artykułu
80MM*	1	54638.080.001

Uchwyt do haka



Informacje techniczne

Nr	B	D	H	L	S
54639.100.001	25	32	-	100	1
54640.036.001	19	20	38	35	1.3
54640.050.001	19	28	54	50	1.3

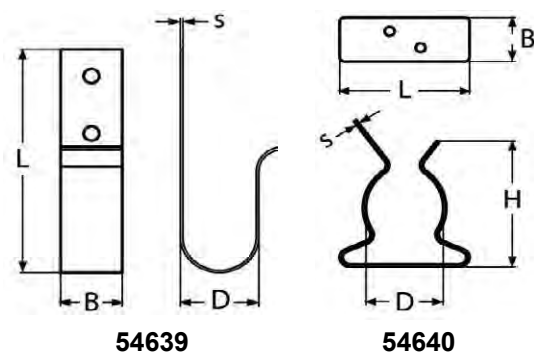

Grupy katalogowe

Materiał	Kod	Strona
St.St. A2	54639	13-128
St.St. A2	54640	13-128

54639	Uchwyt do haka	MH11
Materiał	Stal nierdzewna A2	

L	<input type="checkbox"/>	Kod artykułu
100MM*	10	54639.100.001

54640	Uchwyt do haka	MH11
Materiał	Stal nierdzewna A2	

L	<input type="checkbox"/>	Kod artykułu	L	<input type="checkbox"/>	Kod artykułu
35MM*	10	54640.036.001	50MM*	10	54640.050.001

Oczko ruchome do przykręcania



Informacje techniczne

Nr	A	B	D	H	L	S	Ø
54641.060.001	55	50	7	-	58	-	6
54641.080.001	55	50	7	-	58	-	8
54642.100.080	-	-	-	80	100	1.5	-

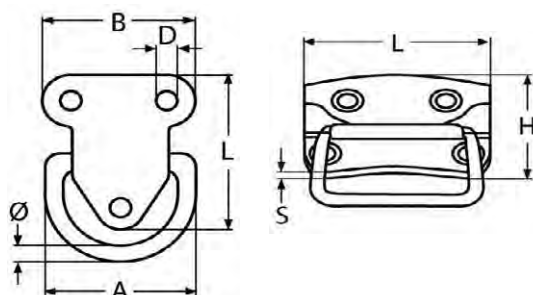

54641

54642

Grupy katalogowe

Material	Kod	Strona
St.St. A2	54641	13-129
St.St. A2	54642	13-129

54641 Oczko ruchome do przykręcania

MH11

Material Stal nierdzewna A2



Ø	✉ Kod artykułu	Ø	✉ Kod artykułu
6MM*	5 54641.060.001	8MM*	5 54641.080.001

54642 Uchwyt do skrzyni

MH11

Material Stal nierdzewna A2



L x H	✉ Kod artykułu
100X80*	1 54642.100.080

Informacje techniczne

Nr	A	B	C	D	H	Kątownik	L	ø
54643.060.040	-	-	-	-	-	60	40	6
54643.060.045	-	-	-	-	-	60	45	6
54643.060.050	-	-	-	-	-	60	50	6
54643.080.045	-	-	-	-	-	60	45	8
54643.080.050	-	-	-	-	-	60	50	8
54644.030.015	-	-	-	-	15	-	-	3
54644.030.020	-	-	-	-	20	-	-	3
54644.030.030	-	-	-	-	30	-	-	3
54644.040.025	-	-	-	-	25	-	-	4
54644.040.030	-	-	-	-	30	-	-	4
54644.040.035	-	-	-	-	35	-	-	4
54644.050.030	-	-	-	-	30	-	-	5
54644.050.040	-	-	-	-	40	-	-	5
54644.060.035	-	-	-	-	35	-	-	6
54644.060.040	-	-	-	-	40	-	-	6
54644.060.045	-	-	-	-	45	-	-	6
54644.080.040	-	-	-	-	40	-	-	8
54644.080.050	-	-	-	-	50	-	-	8
54644.100.050	-	-	-	-	50	-	-	10
54644.100.080	-	-	-	-	60	-	-	10
54644.120.070	-	-	-	-	70	-	-	12
54645.030.015	-	-	-	-	15	-	15	3
54645.030.020	-	-	-	-	18	-	20	3
54645.040.020	-	-	-	-	18	-	20	4
54645.040.025	-	-	-	-	23	-	25	4
54645.050.025	-	-	-	-	23	-	25	5
54645.050.030	-	-	-	-	26	-	30	5
54645.060.030	-	-	-	-	27	-	30	6
54645.060.040	-	-	-	-	36	-	40	6
54645.060.050	-	-	-	-	47	-	50	6
54645.080.050	-	-	-	-	47	-	50	8
54646.060.040	-	-	-	-	40	-	-	6
54646.080.050	-	-	-	-	50	-	-	8
54646.100.060	-	-	-	-	60	-	-	10
54646.120.080	-	-	-	-	80	-	-	12
54647.060.050	28	50	10	-	-	-	-	6
54647.080.050	28	50	10	-	-	-	-	8
54648.050.001	5	53	-	-	52	-	-	5
54648.060.001	5	54	-	-	53	-	-	6
54648.080.001	5	56	-	-	62	-	-	8
54649.060.001	43	30	-	-	-	-	-	6
54649.080.001	51	35	-	-	-	-	-	8
54650.060.001	42	30	-	-	-	-	-	6
54650.080.001	51	35	-	-	-	-	-	8
54651.200.001	-	-	-	20	-	-	-	1.4
54651.300.001	-	-	-	30	-	-	-	2.0
54652.130.001	-	63	-	-	-	-	120	13
54652.160.001	-	76	-	-	-	-	146	16
54652.190.001	-	89	-	-	-	-	165	19
54652.250.001	-	89	-	-	-	-	178	25

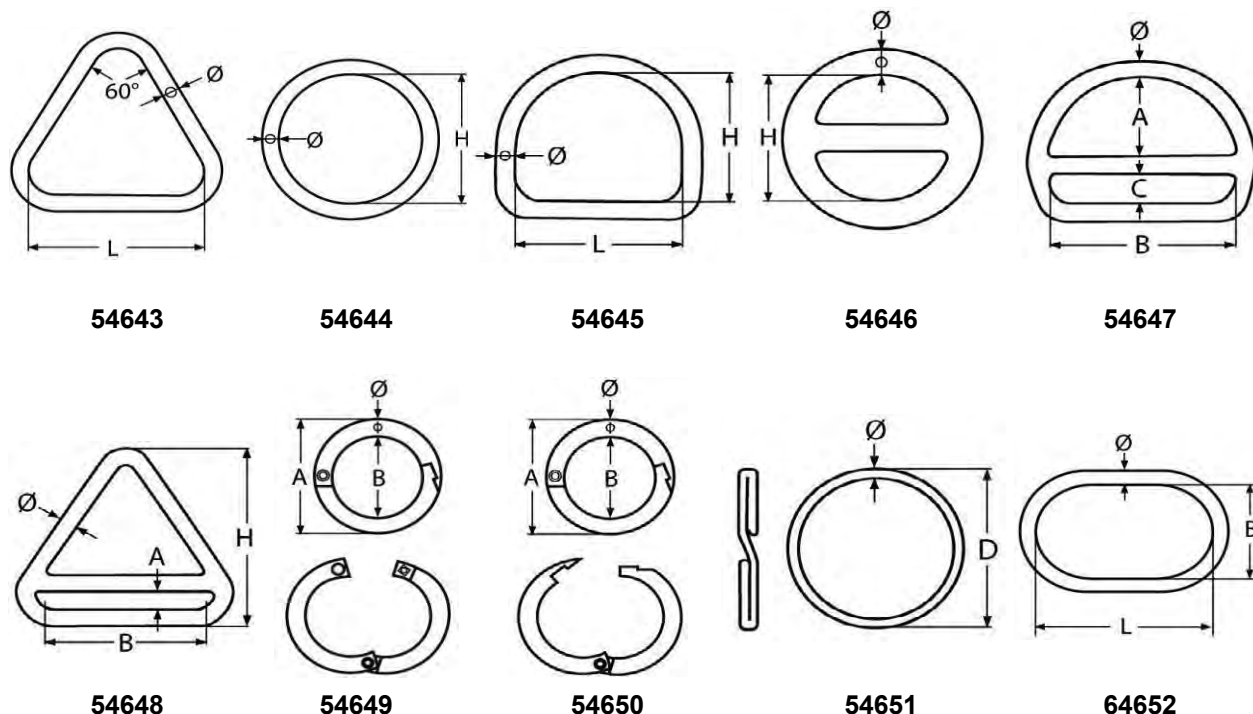

Grupy katalogowe

Material	Kod	Strona
St.St. A2	54643	13-131
St.St. A4	54644	13-131
St.St. A2	54645	13-132
St.St. A4	54646	13-132
St.St. A4	54647	13-132
St.St. A4	54648	13-132
St.St. A4	54649	13-132
St.St. A2	54650	13-132
St.St. A2	54651	13-133
St.St. A4	54652	13-133

54643 Trójkąt, spawany i polerowany MH11

Material Stal nierdzewna A2



ø x L	⊠	Kod artykułu	ø x L	⊠	Kod artykułu	ø x L	⊠	Kod artykułu
6X40*	10	54643.060.040	6X50*	5	54643.060.050	8X45*	5	54643.080.045
6X45*	10	54643.060.045				8X50*	5	54643.080.050

54644 Pierścień okrągły, spawany i polerowany MH11

Material Stal nierdzewna A4



ø x H	⊠	Kod artykułu	ø x H	⊠	Kod artykułu	ø x H	⊠	Kod artykułu
3-15*	50	54644.030.015	5-30*	20	54644.050.030	8-50*	10	54644.080.050
3-20*	50	54644.030.020	5-40*	20	54644.050.040	10-50*	10	54644.100.050
3-30*	50	54644.030.030	6-35*	20	54644.060.035	10-60*	10	54644.100.080
4-25*	50	54644.040.025	6-40*	20	54644.060.040	12-70*	5	54644.120.070
4-30*	50	54644.040.030	6-45*	20	54644.060.045			
4-35*	50	54644.040.035	8-40*	10	54644.080.040			

54645 Ucho typu D, spawane i polerowane							MH11	
Materiał		Stal nierdzewna A2						
ø x H	⊠	Kod artykułu	ø x H	⊠	Kod artykułu	ø x H	⊠	Kod artykułu
3-15*	1	54645.030.015	5-25*	1	54645.050.025	6-40*	1	54645.060.040
3-20*	1	54645.030.020	5-30*	1	54645.050.030	6-50*	1	54645.060.050
4-20*	1	54645.040.020	6-30*	1	54645.060.030	8-50*	1	54645.080.050
4-25*	1	54645.040.025						

54646 Pierścień z mostkiem							MH11	
Materiał		Stal nierdzewna A4						
ø x H	⊠	Kod artykułu	ø x H	⊠	Kod artykułu	ø x H	⊠	Kod artykułu
6-40*	10	54646.060.040	10-60*	5	54646.100.060	12-80*	5	54646.120.080
8-50*	10	54646.080.050						

54647 Pierścień z podwójnym mostkiem							MH11	
Materiał		Stal nierdzewna A4						
ø x B	⊠	Kod artykułu	ø x B	⊠	Kod artykułu			
6-50*	10	54647.060.050	8-50*	10	54647.080.050			

54648 Trójkąt z mostkiem							MH11	
Materiał		Stal nierdzewna A4						
ø	⊠	Kod artykułu	ø	⊠	Kod artykułu	ø	⊠	Kod artykułu
5MM*	10	54648.050.001	6MM*	10	54648.060.001	8MM*	10	54648.080.001

54649 Pierścień dwuczęściowy ze śrubą							MH11	
Materiał		Stal nierdzewna A4						
ø	⊠	Kod artykułu	ø	⊠	Kod artykułu			
6MM*	10	54649.060.001	8MM*	10	54649.080.001			

54650 Kółko dwuczęściowe z zamknięciem							MH11	
Materiał		Stal nierdzewna A2						
ø	⊠	Kod artykułu	ø	⊠	Kod artykułu			
6MM*	10	54650.060.001	8MM*	10	54650.080.001			

54651	Kółko do kluczy	MH11
Materiał	Stal nierdzewna A1/A2	
		 

D	✉	Kod artykułu	D	✉	Kod artykułu
20MM	100	54651.200.001	30MM	100	54651.300.001

54652	Pierścień owalny, ciężkie	MH11
Materiał	Stal nierdzewna A4	
		 

ø	✉	Kod artykułu	ø	✉	Kod artykułu	ø	✉	Kod artykułu
13MM*	5	54652.130.001	19MM*	5	54652.190.001	25MM*	1	54652.250.001
16MM*	5	54652.160.001						

Pierścień z gwoździem



Informacje techniczne

Nr	B	L	ø
54653.030.001	35	25	3
54653.040.001	35	30	4
54653.050.001	38	35	5
54653.060.001	40	40	6
54653.080.001	40	45	8

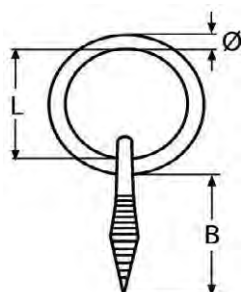

54653

54653	Pierścień z gwoździem	MH11
Materiał	Stal nierdzewna A4	
		 

ø	✉	Kod artykułu	ø	✉	Kod artykułu	ø	✉	Kod artykułu
3MM*	10	54653.030.001	5MM*	10	54653.050.001	8MM*	5	54653.080.001
4MM*	10	54653.040.001	6MM*	10	54653.060.001			

Uchwyt



Informacje techniczne

Nr	B	D	H	L	L ₁	L ₂	S	W	W ₁
54654.065.001	13	7	16	65	48	57	-	-	-
54654.080.001	14	8	20	80	64	72	-	-	-
54654.100.001	18	10	25	100	75	88	-	-	-
54655.118.001	12	-	27	118	100	105	-	36	26
54655.152.001	18	-	32	152	130	135	-	43	35
54656.106.001	17	6.5	27.5	150	-	-	3.6	-	-

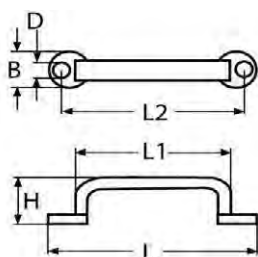

54654

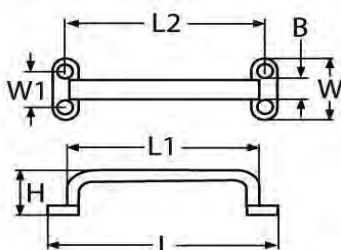

54655

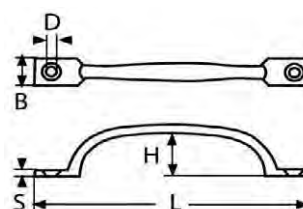

54656

Grupy katalogowe

Material	Kod	Strona
St.St. A2	54654	13-134
St.St. A2	54655	13-134
St.St. A4	54656	13-135

54654 Uchwyt płaski, polerowany

MH11

Material Stal nierdzewna A2



L	☒	Kod artykułu	L	☒	Kod artykułu	L	☒	Kod artykułu
65MM*	5	54654.065.001	80MM*	5	54654.080.001	100MM*	5	54654.100.001

54655 Uchwyt płaski, polerowany

MH11

Material Stal nierdzewna A2



L	☒	Kod artykułu	L	☒	Kod artykułu
118MM*	1	54655.118.001	152MM*	1	54655.152.001

54656	Uchwyt	MH11
Materiał	Stal nierdzewna A4	
		

L		Kod artykułu
106MM*	5	54656.106.001

Łańcuchy



Informacje techniczne

Nr	B ₂	Długość (mtr)	P	ø	≈ Obciążenie niszczące w N
54701.020.001	8	100 m	12	2	1 250
54701.030.001	11	100 m	16	3	2 800
54701.040.001	14	50 m	16	4	8 000
54701.050.001	17	50 m	18.5	5	12 500
54701.060.001	20	50 m	18.5	6	16 000
54701.080.001	26	50 m	24	8	32 000
54701.100.001	34	50 m	28	10	50 000
54702.015.001	6.3	100 m	12	1.5	900
54702.020.001	8.4	100 m	22	2	1 250
54702.030.001	12	100 m	26	3	2 800
54702.040.001	16	50 m	32	4	6 300
54702.050.001	20	50 m	35	5	10 000
54702.060.001	24	50 m	42	6	12 500
54702.080.001	32	50 m	52	8	25 000
54702.100.001	40	50 m	65	10	40 000

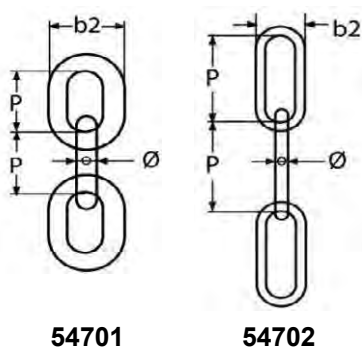

Grupy katalogowe

Materiał	Kod	Strona
St.St. A4	54701	13-136
St.St. A4	54702	13-136

54701	Łańcuchy z prętów okrągłych, krótkie ogniwo	MH11
Materiał	Stal nierdzewna A4	
		

Ø	☒	Kod artykułu	Ø	☒	Kod artykułu	Ø	☒	Kod artykułu
2MM-100MTR	1	54701.020.001	5MM-50MTR*	1	54701.050.001	8MM-50MTR*	1	54701.080.001
3MM-100MTR*	1	54701.030.001	6MM-50MTR*	1	54701.060.001	10MM-50MTR*	1	54701.100.001
4MM-50MTR	1	54701.040.001						

54702	Łańcuchy z prętów okrągłych, długie ogniwo	MH11
Materiał	Stal nierdzewna A4	
		

Ø	☒	Kod artykułu	Ø	☒	Kod artykułu	Ø	☒	Kod artykułu
1,5MM-100MTR*	1	54702.015.001	4MM-50MTR*	1	54702.040.001	8MM-50MTR*	1	54702.080.001
2MM-100MTR*	1	54702.020.001	5MM-50MTR*	1	54702.050.001	10MM-50MTR*	1	54702.100.001
3MM-100MTR	1	54702.030.001	6MM-50MTR	1	54702.060.001			

Karabińczyk zakręcany





Informacje techniczne

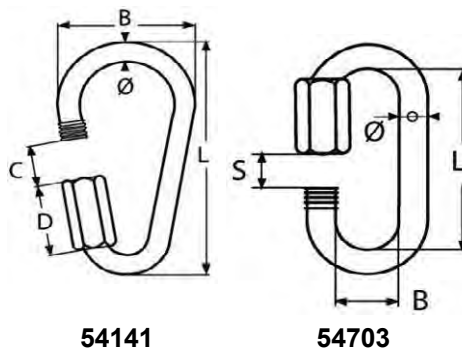

Nr	B	C	D	L	S	Ø
54141.040.061	32	11	19	61	-	4
54141.050.070	37	13	22	70	-	5
54141.060.082	42	14	25	82	-	6
54141.080.100	53	17	31	100	-	8
54141.100.118	63	20	36	118	-	10
54141.120.144	76	23	43	144	-	12
54703.040.001	12	-	-	32	5.5	4
54703.050.001	13	-	-	39	6.5	5
54703.060.001	14	-	-	45	7.5	6
54703.080.001	18	-	-	58	9.5	8
54703.100.001	22	-	-	69	12	10



Grupy katalogowe

Materiał	Kod	Strona
St.St. A4	54141	13-137
St.St. A4	54703	13-137

54141		Karabińczyk zakręcany		MH11							
Material		Stal nierdzewna A4									
											
ø x L	✉	Kod artykułu	ø x L	✉	Kod artykułu						
4X61*	10	54141.040.061	6X82*	10	54141.060.082						
5X70*	10	54141.050.070	8X100*	10	54141.080.100						
					<table border="0"> <tr> <td>10X118*</td> <td>5</td> <td>54141.100.118</td> </tr> <tr> <td>12X144*</td> <td>5</td> <td>54141.120.144</td> </tr> </table>	10X118*	5	54141.100.118	12X144*	5	54141.120.144
10X118*	5	54141.100.118									
12X144*	5	54141.120.144									

54703		Karabińczyk zakręcany		MH11				
Material		Stal nierdzewna A4						
								
ø	✉	Kod artykułu	ø	✉	Kod artykułu			
4MM*	20	54703.040.001	6MM*	20	54703.060.001			
5MM*	20	54703.050.001	8MM*	10	54703.080.001			
					<table border="0"> <tr> <td>10MM</td> <td>10</td> <td>54703.100.001</td> </tr> </table>	10MM	10	54703.100.001
10MM	10	54703.100.001						

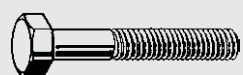

1 Śruby

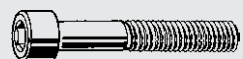

2 Produkty z gniazdem sześciokątnym



3 Nakrętki, nitonakrętki & wkładki



4 Pręty gwintowane & śruby dwustronne



5 Haki & śruby oczkowe



6 Wkręty

I Index



7 Podkładki & pierścienie uszczelniające typu “O-ring”



8 Kotwy, kołki, dyble

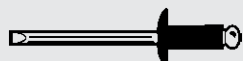

9 Nity, kołki & wpusty



10 Elementy łączące systemowe, meblowe & zabezpieczające



11 Zestawy

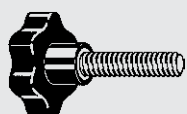

12 Części konstrukcyjne & części maszynowe

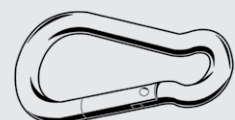

13 Przemysł morski

T Technologia łączenia

Technologia Mocowań

Spis treści

1	Wprowadzenie	3
2	Właściwości mechaniczne elementów złącznych	3
2.1	Właściwości mechaniczne śrub, wkrętów i śrub dwustronnych ze stali węglowej i stali stopowej	3
2.1.1	Zakres zastosowań	3
2.1.2	System oznaczania klas właściwości mechanicznych	4
2.1.3	Oznakowanie śrub, śrub z łbem walcowym z gniazdem oraz śrub dwustronnych	4
2.1.4	Właściwości mechaniczne śrub, wkrętów i śrub dwustronnych	5
2.1.5	Odwęglanie	6
2.1.6	Minimalne momenty zrywające	7
2.1.7	Wpływ podwyższonych temperatur na właściwości mechaniczne	7
2.1.8	Właściwości mechaniczne elementów złącznych zewnętrznie gwintowanych ze stali o niskiej i średniej zawartości węgla (w tym stopowych)	8
2.1.9	Właściwości mechaniczne elementów złącznych zewnętrznie gwintowanych ze stali nierdzewnej w zgodności z ASTM F593	8
2.2	Właściwości mechaniczne nakrętek ze stali węglowej i stali niskostopowej	9
2.2.1	Zakres zastosowań	9
2.2.2	System oznaczenia klas właściwości mechanicznych	9
2.2.3	Oznakowanie nakrętek stalowych	10
2.2.4	Właściwości mechaniczne nakrętek stalowych	10
2.2.5	Właściwości mechaniczne elementów złącznych wewnętrznie gwintowanych wg SAE J995	12
2.2.6	Właściwości mechaniczne elementów złącznych wewnętrznie gwintowanych ze stali nierdzewnej wg ASTM F594	12
2.3	Stalowe elementy złączne odporne na korozję	12
2.3.1	Zakres zastosowań	12
2.3.2	System oznaczania klas właściwości mechanicznych	13
2.3.3	Oznaczanie elementów złącznych ze stali nierdzewnej austenitycznej	14
2.3.4	Właściwości mechaniczne i inne właściwości fizyczne elementów złącznych z austenitycznej stali nierdzewnej	14
3	Gwint	16
3.1	Gwint metryczny (ISO), szereg grubozwojny – M	16
3.1.1	Wymiary graniczne dla gwintów metrycznych, szereg grubozwojny, pasowanie 6H/6g	16
3.2	Gwint metryczny (ISO), szereg drobnozwojny – MF	17
3.2.1	Wymiary graniczne dla gwintów metrycznych, szereg drobnozwojny, pasowanie 6H/6g	17
3.3	Zunifikowany gwint (ISO) – UNC	18
3.3.1	Wymiary graniczne dla gwintów zunifikowanych: grubozwojny UNC, klasy tolerancji 2A i 2B	18
3.4	Zunifikowany gwint (ISO) – UNF	19
3.4.1	Wymiary graniczne dla gwintów zunifikowanych: drobnozwojny UNF, klasy tolerancji 2A i 2B	19
3.5	Zunifikowany gwint o skoku uprzywilejowanym (ISO) - 8UN	20
3.5.1	Wymiary graniczne dla gwintów zunifikowanych - 8UN, klasy tolerancji 2A i 2B	20
3.6	Zunifikowane gwinty (ISO) - UNC i UNF	21
3.6.1	Wymiary graniczne dla gwintów zunifikowanych – UNC i UNF, klasy tolerancji 2A i 2B	21
3.7	Gwinty – drobnozwojne a grubozwojne	22
3.7.1	Wyjaśnienie	22
3.8	Gwinty metryczne o klasie tolerancji Sk6 dla śrub dwustronnych DIN 939	23
3.8.1	Wymiary graniczne dla gwintów metrycznych o klasie tolerancji Sk6	23
3.9	Gwint wkrętów samogwintujących – ST	24
3.9.1	Wymiary graniczne gwintów wkrętów samogwintujących	24
3.9.2	Końcówki gwintu wkrętów samogwintujących	24
3.10	Gwint metryczny stożkowy zewnętrzny – DIN 158-1	25
3.10.1	Wymiary graniczne dla metrycznego gwintu stożkowego zewnętrznego, typ krótki	25
3.11	Gwint zewnętrzny stożkowy rurowy Whitwortha R – DIN 3858	26
3.11.1	Wymiary znamionowe gwintów stożkowych zewnętrznych o tolerancji 2, typ krótki a	26
3.12	Gwint rurowy równoległy thread G – ISO 228-1	27
3.12.1	Wymiary graniczne dla gwintów rurowych równoległych - G	27
4	Normy podstawowe	28
4.1	Wymiary otworów rdzeniowych dla wkrętów i śrub samogwintujących	28
4.1.1	Wskazówki zastosowania	28
4.1.2	Możliwości zastosowania	28
4.1.3	Wskazówki dla średnic otworów rdzeniowych d_0^1	29

4.2	Otwory rdzeniowe dla wkrętów samogwintujących w metalu (Taptite 2000®)	31
4.2.1	Zalecenia dla otworów wierconych i wycinanych w materiałach o zakresie twardości do 150 HB, 500 N/mm ²	31
4.3	Otwory rdzeniowe dla wkrętów samogwintujących do tworzyw sztucznych (Remform®)	32
4.3.1	Zalecenia dla geometrii otworów i nadlewów wkrętów Remform	32
4.4	Długość części wystającej śruby (lp)	33
4.5	Rozmiary wiertel dla wkrętów samogwintujących	33
4.5.1	Uwagi ogólne	33
4.5.2	Rozmiary wiertel – metryczny (ISO) gwint grubozwojny - M	33
4.5.3	Rozmiary wiertel – metryczny (ISO) gwint drobnozwojny - MF	34
4.5.4	Rozmiary wiertel do gwintów rurowych równoległych Whitwortha – G	34
4.6	Wymiary pod klucz zgodnie z ISO	34
5	Powłoki powierzchniowe dla elementów złącznych	35
5.1	Wprowadzenie	35
5.1.1	Przegląd systemów powlekania	35
5.1.2	Grubości graniczne powłok	36
5.1.3	Kruchość wodorowa	36
5.1.4	Dyrektywy unijne RoHS i ELV	37
5.2	Powlekanie galwaniczne	37
5.3	Galwanizacja na gorąco	39
5.4	Powłoki płatkowe	40
6	Dokumentacja kontrolna dla elementów złącznych	41
6.1	Raporty testowe i certyfikaty EN 10204	41
6.2	Dokumenty PPAP	42
6.3	Certyfikacja CE	43
7	Wskazówki projektowe i montażowe dla elementów złącznych	44
7.1	Tabele momentów dokręcania dla stalowych połączeń śrubowych	44
7.1.1	Obciążenie montażowe wstępne/momenty dokręcania – gwint grubozwojny	44
7.1.2	Obciążenie montażowe wstępne/momenty dokręcania – gwint drobnozwojny	46
7.2	Tabele momentów dokręcania dla połączeń śrubowych ze stali nierdzewnej	47
7.2.1	Obciążenie montażowe wstępne / momenty dokręcania	47
7.3	Współczynniki tarcia μG oraz μK	48
7.4	Tabele momentów dokręcania dla stalowych calowych połączeń śrubowych	49
7.4.1	Obciążenie montażowe wstępne / momenty dokręcania – UNC (gwint grubozwojny)	50
7.4.2	Obciążenie montażowe wstępne / momenty dokręcania – UNF (gwint drobnozwojny)	51
7.5	Zacieranie się (zakleszczanie) stali nierdzewnej	52
7.6	Głębokość wkręcania dla otworów nieprzelotowych	52
7.7	Stosunek wytrzymałości na ścinanie do wytrzymałości na rozciąganie	52
7.8	Tabela długości mocowania dla śrub sprężanych HV według EN 14399-4	53
7.9	Blokowanie	54
7.9.1	Utrata siły sprężania	54
7.9.2	Klasyfikacja systemów blokowania	54
7.9.3	Praktyczne sugestie dla optymalnego połączenia skręcane	55
8	Tabele	56
8.1	Jednostki SI	56
8.2	Konwersja wytrzymałości na rozciąganie, twardości Vickersa, Brinella i Rockwella	57
8.3	Tabele korozji stykowej i chemicznej	58
8.3.1	Tabela korozji kontaktowej	58
8.3.2	Tabela korozji chemicznej	59

1 Wprowadzenie

Projektowanie i produkcja bezpiecznych elementów złącznych wymaga profesjonalnej wiedzy, doświadczenia i informacji. Należy rozważyć wszelkie istotne aspekty takie jak tolerancje wymiarowe czy właściwości mechaniczne i chemiczne. Wskazówki dla obliczeń, montażu i zabezpieczenia łączy mają równie wielkie znaczenie. Całość tej informacji jest rozrzucona po wielkiej liczbie norm, wskazówek technicznych oraz publikacji w różnych językach.

Firma Fabory zebrała najważniejsze informacje techniczne, do których często zaglądamy inżynierowie produktu, projektanci, zaopatrzeniowcy i podwykonawcy. Znaczna część tych materiałów opiera się na międzynarodowych normach (ISO) i normach europejskich (EN). Należy przy tym zauważyć, że chociaż większość norm krajowych takich jak DIN stała się przestarzała i zostały one zastąpione przez odpowiednie normy ISO lub EN, sytuacja rynkowa nadal często domaga się elementów złącznych według DIN. Tam gdzie to było stosowne załączyliśmy też informacje o tych normach DIN.

Informacje podane w oparciu o normy są aktualizowane na wrzesień 2015. Istotna będzie świadomość, że producenci elementów złącznych mogą stosować okres przejściowy między wcześniejszą a najnowszą wersją danej normy.

Oczywiście, więcej informacji technicznych jest dostępnych w Fabory. Jeżeli danych informacji nie znajdujecie w tym dziale technicznym lub jeśli potrzebne są dalsze szczegóły, prosimy o kontakt z naszymi specjalistami technicznymi. Prosimy też pamiętać, że Fabory dysponuje wiedzą techniczną, aby udzielić profesjonalnych rad i pomocy w wielu aspektach i zastosowaniach elementów złącznych. U nas, w Fabory zespół ekspertów od materiałów złącznych jest dedykowany by nieść pomoc klientom w zakresie bezpiecznych i innowacyjnych rozwiązań w zakresie techniki mocowań.

Chociaż wszelkie specyfikacje i dane techniczne zostały zebrane z największą starannością, firmy należące lub afiliowane w Grupie Fabory nie ponoszą żadnej odpowiedzialności w związku z tymi informacjami oraz sposobem ich wykorzystania.

2 Właściwości mechaniczne elementów złącznych

2.1 Właściwości mechaniczne śrub, wkrętów i śrub dwustronnych ze stali węglowej i stali stopowej

2.1.1 Zakres zastosowań

Klasy właściwości oraz związane z nimi właściwości mechaniczne wg ISO 898-1:2013 stosuje się do śrub, wkrętów i śrub dwustronnych z gwintem metrycznym (ISO), o nominalnej średnicy do i włącznie z 39 mm, wykonanych ze stali węglowej lub stali nierdzewnej, badanych w temperaturze otoczenia w zakresie 10°C do 35°C. W wyższych lub niższych temperaturach elementy złączne mogą nie zachowywać podanych właściwości mechanicznych i fizycznych.

Normy nie odnosi się do wkrętów dociskowych i podobnych połączeń gwintowanych nie podlegających sile rozciągającej (patrz ISO 898-5) lub zastosowań specjalnych jak na przykład spawanie, odporność korozyjna (do stali nierdzewnej odnosi się norma ISO 3506-1), wytrzymałość temperaturowa powyżej 150°C lub poniżej -50°C (patrz DIN 267-13). System określania klas wg 898-1 może być używany do innych rozmiarów (np. powyżej średnicy M39) z zastrzeżeniem spełnienia wszystkich własności mechanicznych z normy. Niektóre elementy złączne mogą nie spełnić wymogów sił rozciągających lub skręcających wg ISO 898-1 wskutek niepreferowanej geometrii lub np. śruby z łbem obniżonym, stożkowym lub ze zredukowanym trzpieniem.

2.1.2 System oznaczania klas właściwości mechanicznych

Symbole klas właściwości, określające najważniejsze właściwości mechaniczne, składają się z dwóch liczb oddzielonych kropką, na przykład 10.9.

Pierwsza liczba oznacza 1/100 nominalnej wytrzymałości na rozciąganie w N/mm² (patrz R_m w tabeli).

A zatem klasa właściwości 10.9 odpowiada odporności na rozciąganie 10x100 = 1000 N/mm².

Druga liczba oznacza 10-krotny stosunek między dolną granicą plastyczności R_{el} (albo naprężeniem granicznym R_{p0.2} lub rozciąganiem nieproporcjonalnym R_{pf}) a nominalną wytrzymałością na rozciąganie R_m (stosunek granicy plastyczności do wytrzymałości na rozciąganie).

A zatem dla klasy właściwości 10.9 druga cyfra 9 wywodzi się ze wzoru: $10 \times \frac{900}{1000}$

Nominalna granica plastyczności z tego przykładu (10.9) może być łatwo obliczona przez pomnożenie przez 10 iloczynu obu liczb klas właściwości: 10 x 10 x 9 = 900 N/mm².

2.1.3 Oznakowanie śrub, śrub z łbem walcowym z gniazdem oraz śrub dwustronnych

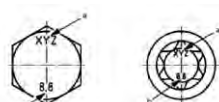

a : znak identyfikacyjny producenta
b : symbol klasy właściwości

Rys. 1

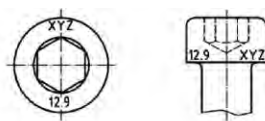

Rys. 2

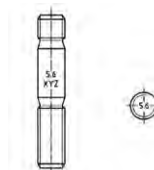

Rys. 3

- Oznaczenie klasy właściwości mechanicznych jest obowiązkowe dla śrub i wkrętów z łbem sześciokątnym dla średnicy znamionowej $d \geq M5$, dla wszystkich klas właściwości, najlepiej na szczycie łba (rys.1).
- Oznaczenie klasy właściwości mechanicznych jest obowiązkowe dla śrub z łbem walcowym i gniazdem sześciokątnym o średnicy znamionowej $d \geq M5$, dla wszystkich klas właściwości, najlepiej na szczycie łba (rys.2).
- W przypadku zastosowania stali węglowych wzbogaconych (np. B, Mn, Cr lub Mo) w klasie 12.9, symbol 12.9 należy podkreślić: 12.9.
- Śruby dwustronne o średnicy znamionowej $d \geq M5$ w klasach właściwości mechanicznych ≥ 5.6 , winny być znakowane na trzpieniu lub na końcu nakrętki (wymagane dla gwintów pasowanych) (rys.3). Dopuszczalne jest również oznakowanie symbolami (rys.4).
- Gwint lewoskrętny winien być oznakowany dla średnic znamionowych $d \geq M5$ symbolem pokazanym na rys. 5, na szczycie łba lub na końcówce śruby. Dla śrub i wkrętów z łbem sześciokątnym można zastosować oznakowanie alternatywne jak na rysunku 6.
- Oznaczenie producenta jest obowiązkowe na wszystkich produktach oznakowanych klasami właściwości mechanicznych.
- Jeśli potrzebne jest oznakowanie innych typów śrub i wkrętów, należy wykorzystać ten sam system oznaczania.
- Oznakowania zazwyczaj nie stosuje się dla wkrętów z łbem stożkowym płaskim, łbem stożkowym owalnym, łbem stożkowym ściętym lub innych podobnych o wewnętrznym mechanizmie wkręcania.
- Oznakowanie klasy właściwości mechanicznych dla elementów złącznych o obniżonym obciążeniu poprzedza się cyfrą "0". Na przykład: śruby z łbem stożkowym z gniazdem sześciokątnym o klasie właściwości "10.9" winny być oznaczane jako "010.9".

Klasa właściwości mechanicznych	5.6	8.8	9.8	10.9	12.9
Oznakowanie alternatywne	-	O	+	□	Δ

Rys. 4

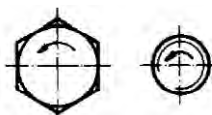

Rys. 5

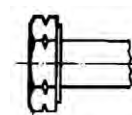

Rys. 6

2.1.4 Właściwości mechaniczne śrub, wkrętów i śrub dwustronnych

Właściwości mechaniczne i fizyczne w poniższej tabeli podano w oparciu o ISO 898-1:2013.

Właściwość mechaniczna lub fizyczna		4.6	4.8	5.6	5.8	6.8	8.8		9.8	10.9	12.9
							d ≤ 16mm ^a	d > 16mm ^b	d ≤ 16mm		12.9
Wytrzymałość na rozciąganie, R _m , MPa	Nom. ^c	400		500		600	800		900	1000	1200
	Min.	400	420	500	520	600	800	830	900	1040	1220
Dolna granica plastyczności, R _{el} ^d , MPa	Nom. ^c	240	-	300	-						
	Min.	240	-	300	-						
Umowna granica plastyczności 0,2%, R _{p0,2} , MPa	Nom. ^c	-				640		720	900	1080	
	Min.	-				640	660	720	940	1100	
Umowna granica plastyczności 0,0048d, dla elementów złącznych pełnowymiarowych, R _{pf} , MPa	Nom. ^c	-	320	-	400	480	-				
	Min.	-	340 ^e	-	420 ^e	480 ^e	-				
Wytrzymałość przy obciążeniu próbnym, S _p , Mpa	Nom.	225	310	280	380	440	580	600	650	830	970
Wydłużenie procentowe po pęknięciu dla obrabianych elementów testowych, A, %	Min.	22	-	20	-	-	12	12	10	9	8
Procentowe zmniejszenie pola po pęknięciu dla obrabianych elementów testowych, Z, %	Min.	-					52		48	48	44
Wydłużenie po pęknięciu dla elementów złącznych pełnowymiarowych, A _t , %	Min.	-	0,24	-	0,22	0,20	-				
Stabilność Iba		No fracture									
Twardość Vickersa, HV (F ≥ 98N)	Min.	120	130	155	160	190	250	255	290	320	385
	Max.	220 ^g				250	320	335	360	380	435
Twardość powierzchniowa, HV _{0,3}	Max.	-				h			h _i	h _j	
Wysokość nieodwęgłonej strefy gwintu, E, mm	Min.	-				½ H ₁			2/3 H ₁	¾ H ₁	
Głębokość całkowitego odwęglenia gwintu G, mm	Max.	-				0,015					
Obniżenie twardości po ponownym odpuszczaniu, HV	Max.	-				20					
Moment zrywający, M _B , Nm	Min.	-				According to ISO 898-7					
Udarność, K _V ^k , J	Min.				27	27			27	27	^m
Integralność powierzchni jest zgodna z:		ISO 6157-1 ^l									ISO 6157-3

Uwagi:

- a Podane wartości nie dotyczą konstrukcyjnych zestawów śrubowych
- b Dla konstrukcyjnych zestawów śrubowych d ≥ M12
- c Wartości znamionowe podane są tylko dla celów systemu oznaczania klas właściwości
- d Jeśli nie można ustalić dolnej granicy plastyczności, dopuszcza się pomiar wytrzymałości dla umownej granicy plastyczności 0,2%
- e Wartości w trakcie badań
- g Twardość maksymalna na końcówce elementu złącznego wynosi maks. 250 HV
- h Twardość powierzchniowa nie przekracza 30HV_{0,3} powyżej mierzonej twardości rdzenia HV_{0,3}
- i Maks. 390 HV
- j Maks. 435 HV
- k Temperatura testowa -20°C
- l Dotyczy d ≥ 16mm
- m Wartość w trakcie badań

2.1.5 Odwęglanie

Właściwości mechaniczne stali obrabianej cieplnie w znacznym stopniu są określone jej zawartością węgla. Nie dopuszcza się dostępu powietrza do wnętrza pieca w trakcie hartowania śrub stalowych w klasach 8.8, 10.9 i 12.9, w przeciwnym razie węgiel obecny w lub na powierzchni stali ulegnie utlenieniu przez gorące powietrze.

Dlatego też piece przelotowe do hartowania wyposażone są w kurtyny płomieniowe, a do pieca dostarczana jest atmosfera ochronna celem kontrolowania poziomu tlenu.

Utrata zawartości węgla (odwęglanie) spowodowana procesami obróbki cieplnej poniżej granic określonych w tabeli paragrafu 2.1.4 może obniżać wytrzymałość gwintu i spowodować defekt.

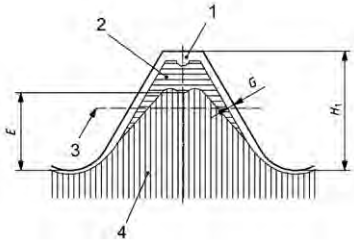

Strefy odwęglania gwintu:

- 1 Odwęglanie całkowite
- 2 Odwęglanie częściowe
- 3 Linia podziałowa gwintu
- 4 Metal nieszlachetny
- E Wysokość nieodwęglonej strefy gwintu
- G Głębokość odwęglania całkowitego w gwincie
- H₁ Wysokość gwintu zewnętrznego w maksymalnym stanie materiału

2.1.6 Minimalne momenty zrywające

Często śrub o mniejszej średnicy nie można testować na rozciąganie. Norma ISO 898-7:1995 określa minimalne momenty zrywające, poniżej których śruba bądź wkręt nie może ulec zerwaniu, jeżeli jest dokręcona zgodnie z procedurą testową. Wartości tych nie stosuje się dla wkrętów dociskowych z gniazdem sześciokątnym.

Poniższe szczegóły opierają się na ISO 898-7 (1992) i DIN 267-25 (wycofana w 1984).

Średnica	Skok P	Klasa właściwości						
		4.6	4.8	5.6	5.8	8.8	10.9	12.9
		Minimalny moment zrywający, Nm według:						
		DIN 267-25				ISO 898-7*		
M1	0,25	0,020	0,020	0,024	0,024	0,033	0,040	0,045
M1.2	0,25	0,045	0,046	0,054	0,055	0,075	0,092	0,10
M1.4	0,3	0,070	0,073	0,084	0,087	0,12	0,14	0,16
M1.6	0,35	0,098	0,10	0,12	0,12	0,16	0,20	0,22
M2	0,4	0,22	0,23	0,26	0,27	0,37	0,45	0,50
M2.5	0,45	0,49	0,51	0,59	0,60	0,82	1,0	1,1
M3	0,5	0,92	0,96	1,1	1,1	1,5	1,9	2,1
M3.5	0,6	1,4	1,5	1,7	1,8	2,4	3,0	3,3
M4	0,7	2,1	2,2	2,5	2,6	3,6	4,4	4,9
M5	0,8	4,5	4,7	5,5	5,6	7,6	9,3	10
M6	1	7,6	7,9	9,1	9,4	13	16	17
M7	1	14	14	16	17	23	28	31
M8	1,25	19	20	23	24	33	40	44
M8 x 1	1	23	23	27	28	38	46	52
M10	1,5	39	41	47	49	66	81	90
M10 x 1	1	50	52	60	62	84	103	114
M10 x 1,25	1,25	44	46	53	54	74	90	100

*Wartości mają zastosowanie wyłącznie dla klas 8.8 – 10.9 i 12.9. Ze względu na rozbieżności w wynikach testów dla klas <8.8 nie są one zawarte w ISO 898-7.

Minimalne wartości momentu zrywającego podane w tabeli stosuje się do śrub i wkrętów przypisanych do klas tolerancji 6g, 6f oraz 6e.

2.1.7 Wpływ podwyższonych temperatur na właściwości mechaniczne



Do temperatury roboczej 150°C, nie są znane żadne szkodliwe zjawiska wywołane zmianą właściwości mechanicznych dla elementów złącznych w klasach właściwości zgodnych z ISO 898-1. Jednakże dla temperatur powyżej 150°C do temperatury maksymalnej of 300°C, należy starannie zapewnić właściwe funkcjonowanie.

Wraz ze wzrostem temperatury może nastąpić postępujące obniżenie dolnej lub umownej granicy plastyczności oraz obniżenie wytrzymałości na rozciąganie.





Ciągła praca elementów złącznych w podwyższonych temperaturach może prowadzić do obluźnienia naprężenia, czemu towarzyszy utrata siły docisku.

DIN 267-13 określa materiały na elementy złączne o szczególnych właściwościach mechanicznych do stosowania w zakresie temperatur od -200°C do +700°C.

2.1.8 Właściwości mechaniczne elementów złącznych zewnętrznie gwintowanych ze stali o niskiej i średniej zawartości węgla (w tym stopowych)

Specyfikacja	Materiał	Zakres rozmiarowy (cal)	Min. obciążenie próbne (psi)	Min. wytrż. na rozciąganie (psi)	Twardość rdzeniowa Rockwell		Min. granica plastyczności (psi)	Oznaczenie klasy	Kompatybilne nakrętki
					Min.	Max.			
SAE J429-Grade 2	Stal nisko- i średniowęglowa	¼ - ¾	55 000	74 000	B80	B100	57 000		ASTM A563 Grade A Hex
		7/8 - 1½	33 000	60 000	B70	B100	36 000		
SAE J429-Grade 5	Stal średniowęglowa: hartowana i odpuszczana	¼ - 1	85 000	120 000	C25	C34	92 000		SAE J995 Grade 5 Hex
		1/8 - 1½	74 000	105 000	C19	C30	81 000		
SAE J429-Grade 8	Stal średniowęglowa stopowa: hartowana i odpuszczana	¼ - 1½	120 000	150 000	C33	C39	130 000		SAE J995 Grade 8 Hex
ASTM A574 socket head cap screw	Stal średniowęglowa stopowa: hartowana i odpuszczana	#0 - ½	140 000	180 000	C39	C45	153 000		
		Powyżej ½ - 2	135 000	170 000	C37	C45			
ASTM A574 socket button & flat countersunk head cap screw	Stal średniowęglowa stopowa: hartowana i odpuszczana	#0 - ½		145 000	C39	C44			
		Powyżej ½		135 000	C37	C44			

2.1.9 Właściwości mechaniczne elementów złącznych zewnętrznie gwintowanych ze stali nierdzewnej w zgodności z ASTM F593

Grupa de aliaj de oțel inoxidabil	Condiții	Diametru nominal (in.)	Rezistență minimă de rupere (psi)	Duritate miez Rockwell		Rezistența elastică minimă (psi)	Marcaj de identificare al Gradului	Piulițe compatibile ASTM F594
				Min.	Max.			
1 (304, 304L)	CW	¼ - 5/8	100 000 - 150 000	B95	C32	65 000		F594C
		¾ - 1½	85 000 - 140 000	B80	C32	45 000		F594D
2 (316, 316L)	CW	¼ - 5/8	100 000 - 150 000	B95	C32	65 000		F594G
		¾ - 1½	85 000 - 140 000	B80	C32	45 000		F594H

CW = Wyżarzanie i kucie na zimno
(duże rozmiary mogą być kute na gorąco i wyżarzane)

2.2 Właściwości mechaniczne nakrętek ze stali węglowej i stali niskostopowej

2.2.1 Zakres zastosowań

Klasy właściwości i związane z nimi właściwości mechaniczne są określone w ISO 898-2:2012 i stosuje się je do nakrętek z gwintem metrycznym (ISO), o średnicach znamionowych do i włącznie z 39 mm, wykonane ze stali węglowej lub stali niskostopowej oraz testowane w temperaturze otoczenia w zakresie 10 °C do 35 °C. ISO 898-2 nie stosuje się do nakrętek o specjalnych wymaganiach takich jak spawalność, odporność na korozję (stal nierdzewna patrz ISO 3506-2), zdolność do wytrzymania temperatur powyżej 300°C lub poniżej -50°C. (patrz DIN 267–13). System oznaczania klas może być stosowany dla innych rozmiarów (np. $d > 39$ mm), pod warunkiem, że wszystkie właściwości mechaniczne podane w tabeli są spełnione.

ISO 898-2 stosuje się do 3 typów nakrętek:

- Typ 2: nakrętka wysoka o wysokości minimalnej $m_{\min} \approx 0,9D$ or $m_{\min} > 0,9D$
- Typ 1: nakrętka normalna o wysokości minimalnej $m_{\min} \geq 0,8D$
- Typ 0: nakrętka niska o wysokości minimalnej $0,45D \leq m_{\min} < 0,8D$

Ważne uwagi odnośnie nakrętek w klasach właściwości wg DIN:

Nakrętek zgodnych z przestarzałymi normami DIN takimi jak DIN 934 (o wysokości znamionowej ok. 0,8d), nie można obciążać niezawodnie do granicy plastyczności odpowiadającej im śruby. Właściwości mechaniczne tych nakrętek opisane są w wycofanej normie DIN 267-4. Aby rozróżnić nakrętki o właściwościach mechanicznych według przestarzałej normy DIN 267-4 od ISO 898-2, oznaczenie ich klasy właściwości winno być między dwoma pionowymi liniami, np. |8|. (patrz Par. 2.2.3)

Dla nowych projektów zdecydowanie zaleca się stosowanie nakrętek o klasach właściwości mechanicznych według norm ISO zamiast przestarzałych norm DIN! Większość oprogramowania służącego wyborowi rozmiarów i klas właściwości elementów złącznych, także dla warunków montażowych (moment/rozciąganie), bazuje na właściwościach wg ISO a nie właściwościach według DIN (w wielu przypadkach niższych).

2.2.2 System oznaczenia klas właściwości mechanicznych

Nakrętki normalne (typ 1) oraz nakrętki wysokie (typ 2) oznaczone są symbolem klasy właściwości, którym jest liczba podana na lewo od stosownej maksymalnej klasy własności śrub, wkrętów lub śrub dwustronnych do których pasują. Symbol klasy właściwości nakrętek niskich (typ 0) składa się z dwóch liczb. Pierwszą z nich jest "0", oznaczające obniżoną obciążalność nakrętki w porównaniu z nakrętką normalną bądź wysoką. Druga liczba odpowiada 1/100 normalnego naprężenia przy obciążeniu próbnym na hartowanym trzpieniu testowym (wyrażonego w N/mm²).

Klasa właściwości mechanicznych nakrętki	Maksymalna klasa właściwości korespondującej śruby, wkrętu lub śruby dwustronnej	Nakrętka normalna (Typ 1)	Nakrętka wysoka (Typ 2)	Nakrętka niska (Typ 0)
		Zakres gwintu		
04	(*)	-	-	M5 - M39 M8x1 – M39x3
05	(*)	-	-	M5 - M39 M8x1 – M39x3
5	5.8	M5 - M39 M8x1 – M39x3	-	
6	6.8	M5 - M39 M8x1 – M39x3	-	
8	8.8	M5 - M39 M8x1 – M39x3	M5 - M39 M8x1 – M39x3	
9	9.8	-	M5 - M39	
10	10.9	M5 - M39 M8x1 – M16x1,5	M5 - M39 M8x1 – M39x3	
12	12.9/12.9	M5 - M16	M5 - M39 M8x1 – M16x1,5	
Przykład nakrętki typu 1: ISO 4032 Przykład nakrętki typu 2: ISO 4033				

(*) Nakrętki niskie stosowane jako przeciwnakrętki winny być montowane razem z nakrętką normalną lub wysoką. W takich połączeniach nakrętka niska jest najpierw dociągana względem elementów mocowanych a następnie dokręca się nakrętkę normalną lub wysoką względem nakrętki niskiej.

2.2.3 Oznakowanie nakrętek stalowych

Nakrętki sześciokątne $\geq M5$ we wszystkich klasach właściwości winny być znakowane z boku lub na powierzchni nośnej oznaczeniem klasy właściwości oraz, tam, gdzie jest to technicznie możliwe – znakiem producenta (patrz rys. 1). Gwinty lewoskrętne dla nakrętek $\geq M5$ muszą być oznaczane na powierzchni nośnej strzałką skierowaną przeciwnie do ruchu wskazówek zegara lub rowkiem w połowie nakrętki (patrz rys. 2).

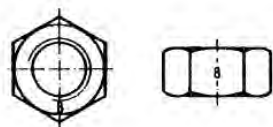

Rys.1

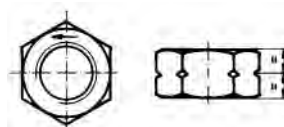

Rys.2

Ważne uwagi dla nakrętek w klasach właściwości według DIN:

Nakrętki sześciokątne $\geq M5$, o właściwościach mechanicznych według przestarzałej normy DIN 267-4, winny być znakowane symbolem klasy właściwości, pionową kreską po dowolnej stronie symbolu oraz znakiem producenta na powierzchni nośnej lub płaskiej (patrz rys. 3).

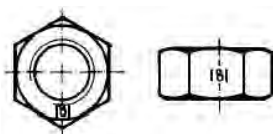

Rys.3

2.2.4 Właściwości mechaniczne nakrętek stalowych

Poniższe dane bazują na normie ISO 898-2:2012 i stosuje się je do nakrętek z gwintem według standardowej klasy tolerancji 6H. Spadek wytrzymałości na zerwanie gwintu zdarza się dla nakrętek o odchyleniu podstawowym większym niż zero.

Zależnie od typu nakrętki, zdolność do wytrzymania obciążenia testowego przeważa nad wymogami twardości, a zatem w niniejszej informacji technicznej podano jedynie obciążenia próbne.

Wartości obciążenia próbnego dla nakrętek z gwintem grubozwojnym:

Gwint D	Skok P	Obciążenia próbne, N Klasa właściwości							
		04	05	5	6	8	9	10	12
M5	0,8	5 400	7 100	8 250	9 500	12 140	13 000	14 800	16 300
M6	1	7 640	10 000	11 700	13 500	17 200	18 400	20 900	23 100
M7	1	11 000	14 500	16 800	19 400	24 700	26 400	30 100	33 200
M8	1,25	13 900	18 300	21 600	24 900	31 800	34 400	38 100	42 500
M10	1,5	22 000	29 000	34 200	39 400	50 500	54 500	60 300	67 300
M12	1,75	32 000	42 200	51 400	59 000	74 200	80 100	88 500	100 300
M14	2	43 700	57 500	70 200	80 500	101 200	109 300	120 800	136 900
M16	2	59 700	78 500	95 800	109 900	138 200	149 200	164 900	186 800
M18	2,5	73 000	96 000	121 000	138 200	176 600	176 600	203 500	230 400
M20	2,5	93 100	122 500	154 400	176 400	225 400	225 400	259 700	294 000
M22	2,5	115 100	151 500	190 900	218 200	278 800	278 800	321 200	363 600
M24	3	134 100	176 500	222 400	254 200	324 800	324 800	374 200	423 600
M27	3	174 400	229 500	289 200	330 500	422 300	422 300	486 500	550 800
M30	3,5	213 200	280 500	353 400	403 900	516 100	516 100	594 700	673 200
M33	3,5	263 700	347 000	437 200	499 700	638 500	638 500	735 600	832 800
M36	4	310 500	408 500	514 700	588 200	751 600	751 600	866 000	980 400
M39	4	370 900	488 000	614 900	702 700	897 900	897 900	1 035 000	1 171 000

Wartości obciążenia próbnego dla nakrętek z gwintem drobnozwojnym:

Gwint D x P	Obciążenie próbne, N Klasa właściwości						
	04	05	5	6	8	10	12
M8 x 1	14 900	19 600	27 000	30 200	37 400	43 100	47 000
M10 x 1,25	23 300	30 600	44 200	47 100	58 400	67 300	73 400
M10 x 1	24 500	32 200	44 500	49 700	61 600	71 000	77 400
M12 x 1,5	33 500	44 000	60 800	68 700	84 100	97 800	105 700
M12 x 1,25	35 000	46 000	63 500	71 800	88 000	102 200	110 500
M14 x 1,5	47 500	62 500	86 300	97 500	119 400	138 800	150 000
M16 x 1,5	63 500	83 500	115 200	130 300	159 500	185 400	200 400
M18 x 2	77 500	102 000	146 900	177 500	210 100	220 300	-
M18 x 1,5	81 700	107 500	154 800	187 000	221 500	232 200	-
M20 x 2	98 000	129 000	185 800	224 500	265 700	278 600	-
M20 x 1,5	103 400	136 000	195 800	236 600	280 200	293 800	-
M22 x 2	120 800	159 000	229 000	276 700	327 500	343 400	-
M22 x 1,5	126 500	166 500	239 800	289 700	343 000	359 600	-
M24 x 2	145 900	192 000	276 500	334 100	395 500	414 700	-
M27x 2	188 500	248 000	351 100	431 500	510 900	535 700	-
M30 x 2	236 000	310 500	447 100	540 300	639 600	670 700	-
M33 x 2	289 200	380 500	547 900	662 100	783 800	821 900	-
M36 x 3	328 700	432 500	622 800	804 400	942 800	934 200	-
M39 x 3	391 400	515 000	741 600	957 900	1 123 000	1 112 000	-



Ważne uwagi dotyczące nakrętek w klasach właściwości według DIN:

Naprężenia graniczne dla nakrętek sześciokątnych o właściwościach mechanicznych zgodnych z wycofaną normą DIN 267-4 są znacząco różne (najczęściej niższe), niż te zgodne z ISO 898-2:

Gwint D	Skok P	Nakrętki z właściwościami mechanicznymi według wycofanej normy DIN 267-4 Obciążenie próbne, N Klasa właściwości				
		[5]	[6]	[8]	[10]	[12]
M5	0,8	7100	8500	11 400	14 200	17 000
M6	1	10 000	12 000	16 000	20 000	24 000
M7	1	14 500	17 300	23 000	29 000	34 700
M8	1,25	18 300	22 000	29 000	36 500	43 000
M10	1,5	29 000	35 000	46 000	58 000	69 500
M12	1,75	42 100	50 500	67 000	84 000	100 000
M14	2	57 500	69 000	92 000	115 000	138 000
M16	2	78 500	94 000	136 000	157 000	188 000
M18	2,5	96 000	115 000	154 000	192 000	230 000
M20	2,5	122 000	147 000	196 000	245 000	294 000
M22	2,5	151 000	182 000	242 000	303 000	364 000
M24	3	176 000	212 000	282 000	353 000	423 000
M27	3	230 000	276 000	367 000	459 000	550 000
M30	3,5	280 000	336 000	448 000	561 000	673 000
M33	3,5	347 000	416 000	555 000	694 000	833 000
M36	4	408 000	490 000	653 000	817 000	980 000
M39	4	488 000	585 000	780 000	976 000	1 170 000

Dla nowych projektów zdecydowanie zaleca się stosowanie nakrętek o klasach właściwości zgodnych z normami ISO zamiast z przestarzałymi normami DIN!

2.2.5 Właściwości mechaniczne elementów złącznych wewnętrznie gwintowanych wg SAE J995

Grade	Materiał	Rozmiar nom. (cale)	Obciążenie próbne (psi)	Twardość Rockwella		Oznaczenie klasy
				Min.	Max.	
2	Stal węglowa	¼ - 1½	90 000*		C32	
			80 000**			
5	Stal węglowa	¼ - 4	120 000*		C32	
			109 000**			
		Over 1 - 1½	105 000*		C32	
			940 00**			
8	Stal średniowęglowa stopowa: hartowana i odpuszczana	¼ - ½	150 000	C24	C32	
		Over ½ - 1		C26	C34	
		Over 1 - 1½		C26	C36	

*UNC oraz 8UN
**UNF, 12UN i drobniejsze

2.2.6 Właściwości mechaniczne elementów złącznych wewnętrznie gwintowanych ze stali nierdzewnej wg ASTM F594

Stop nierdzewny - grupa	Wykonanie	Średnica nominalna (cale)	Obciążenie próbne (psi)	Twardość Rockwella	
				Min.	Max.
1 (304, 304L)	CW	¼ - ½	100 000	B95	C35
		¾ - 1½	85 000	B80	C35
2 (316, 316L)	CW	¼ - ½	100 000	B95	C35
		¾ - 1½	85 000	B80	C35

CW = Wyżarzanie i kucie na zimno
(duże rozmiary mogą być kute na gorąco i wyżarzane)

2.3 Stalowe elementy złączne odporne na korozję

2.3.1 Zakres zastosowań

Właściwości mechaniczne elementów złącznych ze stali nierdzewnej określa norma ISO 3506:2009 część 1 do 4:

Część 1: Śruby, wkręty i śruby dwustronne

Część 2: Nakrętki

Część 3: Śruby ustalające i inne podobne elementy złączne nie poddane naprężeniu rozciągającemu

Część 4: Wkręty samogwintujące

Termin "NIERDZEWNY" używany jest w odniesieniu do licznych materiałów, z których wszystkie zawierają co najmniej 12% chromu (Cr) oraz zazwyczaj także inne dodatki stopowe, przy czym nikiel (Ni) oraz molibden (Mo) są najważniejsze. W tych gatunkach stali na powierzchni tworzy się warstwa tlenku chromu, która chroni stal przed korozją. W warunkach podwyższonej temperatury chrom ma tendencję do tworzenia węglików zamiast tlenku.

Dla elementów złącznych ta szeroka grupa stali nierdzewnych została podzielona zgodnie z ISO 3506 na 3 grupy materiałowe w oparciu o ich strukturę metalurgiczną:

Austenityczne (A)

Martenzytyczne (C)

Ferrytyczne (F)

Dla przemysłowych elementów złącznych grupa martenzytyczna i ferrytyczna są prawie bez znaczenia. Grupa austenityczna – często zwana stalą chromoniklową – jest najczęściej stosowana do wytwarzania elementów złącznych i jest dalej podzielona na 5 gatunków stali, z których każdy ma inną odporność na korozję i specyficzny zakres zastosowań.

A1:

Stal automatowa o doskonałej skrawalności dzięki wysokiej zawartości procentowej fosforu i siarki. Jednakże, wskutek tego obniżona jest ogólna odporność na korozję. Ten rodzaj stali automatowej jest rzadko wykorzystywany w masowej produkcji elementów złącznych.

A2:

Najczęściej używany gatunek stali nierdzewnej (do masowej produkcji elementów złącznych) – zwany też 18/8 (18% Cr, 8% Ni) – o wybitnej odporności na korozję w normalnych warunkach atmosferycznych, w środowiskach wilgotnych i przy narażeniu na utleniające i liczne roztwory alkaliczne. Jednakże A2 nie jest odpowiednia do zastosowania z kwasami nieutleniającymi i środkami zawierającymi chlorki, tj. w basenach i wodzie morskiej.

A3:

Jest to stabilizowana stal nierdzewna o właściwościach stali A2. Dzięki zawartości takich pierwiastków, jak Ti, Nb lub Ta, które zmniejszają wiązanie węgla z chromem, ten gatunek stali jest szczególnie przydatny do zastosowania w wyższych temperaturach. Jest stosunkowo rzadko używany do masowej produkcji elementów złącznych.

A4:

Stale z gatunku A4 są stalami „kwasoodpornymi” z dodatkiem stopowym Mo i zapewniają znacznie lepszą odporność na korozję w warunkach agresywnych takich, jak warunki klimatu morskiego (chlorki), atmosfer przemysłowych (dwutlenek siarki), gdzie występują kwasy utleniające oraz gdzie może wystąpić korozja wżerowa. Tym niemniej, w warunkach agresywnych jak morskie, o wysokiej obecności chlorków lub innych podobnych zastosowaniach, wymagane są stale o wyższej zawartości Cr, Ni a szczególnie Mo.

A5:

Jest to stal stabilizowana o właściwościach A4. Dzięki zawartości takich pierwiastków jak Ti, Nb lub Ta, które zmniejszają wiązanie węgla z chromem, ten gatunek stali jest szczególnie przydatny do zastosowania w wyższych temperaturach. Jest stosunkowo rzadko używany do masowej produkcji elementów złącznych.

2.3.2 System oznaczania klas właściwości mechanicznych

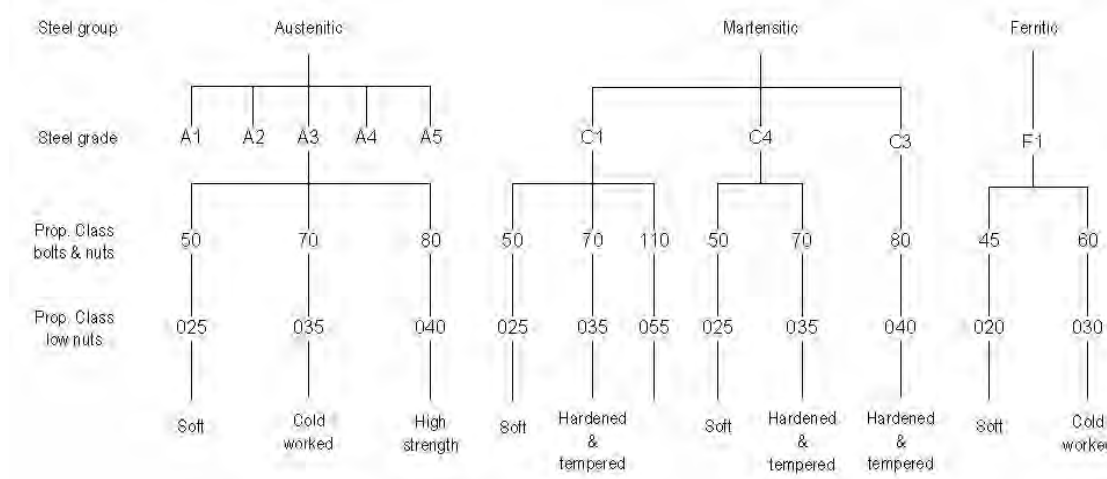

Oznaczenie klasy właściwości mechanicznych reprezentuje 1/10 wytrzymałości na rozciąganie (śruba lub wkręt) lub 1/10 naprężenia przy obciążeniu próbnym dla nakrętek. Jeśli pierwszą cyfrą jest „0” oznacza to, że nakrętka ma obniżoną wytrzymałość w porównaniu do nakrętki standardowej.

2.3.3 Oznaczenie elementów złącznych ze stali nierdzewnej austenitycznej

Wykonane ze stali nierdzewnej śruby i nakrętki z łbem sześciokątnym oraz wkręty z łbem gniazdowym o rozmiarze M5 i powyżej oraz wszelkie opakowania powinny być oznaczone znakiem identyfikacyjnym producenta i gatunkiem stali, po których następują dwie (lub trzy) cyfry określające klasę właściwości mechanicznych. Dla nakrętek możliwe jest znakowanie alternatywne poprzez karbowanie, patrz przykłady poniżej. Jeśli klasa właściwości mechanicznych nie jest wskazana, przyjmuje się klasę 50 lub 025. Niskowęglowa austenityczna stal nierdzewna o zawartości węgla nie przekraczającej 0,03%, może być oznakowana dodatkowo symbolem „L”.

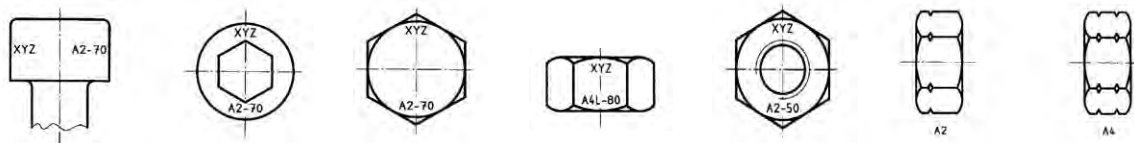

Znakowanie śrub dwustronnych i innych elementów złącznych winno być uzgodnione przez użytkownika i producenta.

2.3.4 Właściwości mechaniczne i inne właściwości fizyczne elementów złącznych z austenitycznej stali nierdzewnej

Właściwości mechaniczne śrub, wkrętów, śrub dwustronnych oraz nakrętek z austenitycznej stali nierdzewnej:

Stal nierdzewna		Klasa właściwości	Śruby i wkręty			Nakrętki typu 1
Grupa stali	Gatunek stali		Wytrzymałość na rozciąganie R_m ¹⁾ min. N/mm ²	0.2% umowna granica plastyczności $R_{p0.2}$ ¹⁾ min. N/mm ²	Wydłużenie przy pęknięciu A ²⁾ min. mm	Wytrzymałość od obciążeniem próbnym S_p min. N/mm ²
Austenityczna	A1, A2, A3, A4, A5	50	500	210	0,6d	500
		70	700	450	0,4d	700
		80	800	600	0,3d	800

¹⁾ Wartości obliczone dla znamionowego pola naprężeń (patrz: Tabela gwintów)
²⁾ Ustalono zgodnie z ISO 3506-1 dla rzeczywistej długości wkrętu a nie dla przygotowanego elementu testowego.

Minimalny moment zrywania w Nm dla śrub z austenitycznej stali nierdzewnej oraz wkrętów M1,6 do M16 (gwint grubozwojny):

Znamionowy rozmiar gwintu	Klasa właściwości mech. 50	Klasa właściwości mech. 70	Klasa właściwości mech. 80
M1.6	0.15	0.2	0.24
M2	0.3	0.4	0.48
M2.5	0.6	0.9	0.96
M3	1.1	1.6	1.76
M4	2.7	3.8	4.32
M5	5.5	7.8	8.8
M6	9.3	13	15
M8	23	32	37
M10	46	65	74
M12	80	110	130
M16	210	290	330

0.2% umowna granica plastyczności ($R_{p_{0,2}}$) austenitycznej stali nierdzewnej w podwyższonych temperaturach:

Gatunek stali	+100°C	+200°C	+300°C	+400°C
A2, A3, A4, A5	85 ¹⁾	80 ¹⁾	75 ¹⁾	70 ¹⁾
¹⁾ Wartości te podane są jako % wartości dla temperatury pokojowej. Wartości te stosuje się jedynie dla elementów złącznych w klasach właściwości 70 i 80.				

Zastosowania w niskich temperaturach:

Gatunek stali	Dolne granice temperatury roboczej dla pracy ciągłej	
A2, A3	-200°C	
A4, A5	Śruby i wkręty ¹⁾	-60°C
	Śruby dwustronne	-200°C
¹⁾ W związku z elementem stopowym Mo, stabilność austenytu ulega zmniejszeniu a temperatura przejściowa ulega podniesieniu do wyższych wartości, jeżeli następuje wysoki stopień odkształcenia w trakcie produkcji elementu złącznego.		

Właściwości magnetyczne:

Elementy złączne z austenitycznej stali nierdzewnej są niemagnetyczne. Tym niemniej po obróbce na zimno mogą pojawić się pewne właściwości magnetyczne. Pod tym względem A4 jest lepsza od A2, a A1 jest najbardziej niekorzystna. Niektóre zastosowania, jak te dla sprzętu elektrotechnicznego a także w przemyśle morskim i jądrowym, wymagają przenikalności magnetycznej możliwie zbliżonej do 1.0. Elementy złączne dostępne z magazynu nie są odpowiednie dla tych celów, a zatem należy uzgodnić specjalne rodzaje stali niemagnetyzującej.

3 Gwint

3.1 Gwint metryczny (ISO), szereg grubozwojny – M

Profil nominalny i profile graniczne

Linie pogrubione oznaczają maksymalne profile materiału. Maksymalny profil materiału gwintu wewnętrznego stanowi profil nominalny.

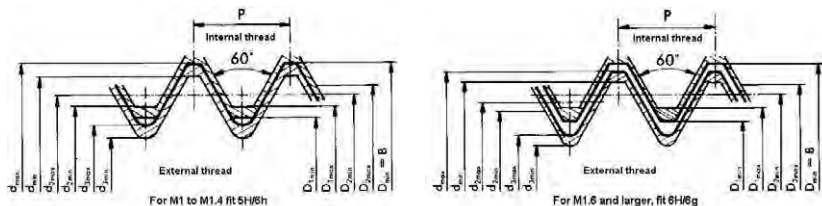

Gwint zewnętrzny

Gwint wewnętrzny

B = podstawowa średnica nominalna
P = skok gwintu

d = średnica nominalna
d₃ = średnica rdzenia
d₂ = średnica podziałowa

D = średnica nominalna
D₁ = średnica rdzenia
D₂ = średnica podziałowa

3.1.1 Wymiary graniczne dla gwintów metrycznych, szereg grubozwojny, pasowanie 6H/6g

Poniższa tabela bazuje na normie ISO 965-1 (2013). Wymiary w mm.

Średn. ²⁾ nominalna	Skok	Gwint zewnętrzny, tolerancja 6g ¹⁾ (śruby i wkręty)						Gwint wewnętrzny, tolerancja 6H ¹⁾ (nakrętki)				Przekrój dla średnicy rdzenia $\frac{\pi}{4} d_s^2$	Powierz- chnia czynna gwintu $\frac{\pi}{4} \left(\frac{d_2 + d_3}{2} \right)^2$
		Średnica nominalna		Średnica podziałowa		Średnica rdzenia		Średnica podziałowa		Średnica rdzenia			
B = D min.	P	d max.	d min.	d _{2max}	d _{2min}	d _{3max}	d _{3min}	D _{2min}	D _{2max}	D _{1min}	D _{1max}	A _{d3} mm ²	A _s mm ²
1 ¹⁾	0,25	1,000	0,933	0,838	0,785	0,693	0,630	0,838	0,894	0,729	0,785	0,337	0,460
1,1 ¹⁾	0,25	1,100	1,033	0,938	0,885	0,793	0,730	0,938	0,994	0,829	0,885	0,494	0,588
1,2 ¹⁾	0,25	1,200	1,133	1,038	0,985	0,893	0,830	1,038	1,094	0,929	0,985	0,626	0,732
1,4 ¹⁾	0,3	1,400	1,325	1,205	1,149	1,032	0,964	1,205	1,265	1,075	1,142	0,837	0,983
1,6	0,35	1,581	1,496	1,354	1,291	1,152	1,075	1,373	1,458	1,221	1,321	1,075	1,27
1,8	0,35	1,781	1,696	1,554	1,491	1,352	1,275	1,573	1,658	1,421	1,521	1,474	1,70
2	0,4	1,981	1,886	1,721	1,654	1,490	1,407	1,740	1,830	1,567	1,679	1,788	2,07
2,2	0,45	2,180	2,080	1,888	1,817	1,628	1,540	1,908	2,003	1,713	1,838	2,133	2,48
2,5	0,45	2,480	2,380	2,188	2,117	1,928	1,840	2,208	2,303	2,013	2,138	2,980	3,39
3	0,5	2,980	2,874	2,655	2,580	2,367	2,273	2,675	2,775	2,459	2,599	4,475	5,03
3,5	0,6	3,479	3,354	3,089	3,004	2,743	2,635	3,110	3,222	2,850	3,010	6,000	6,78
4	0,7	3,978	3,838	3,523	3,433	3,119	3,002	3,545	3,663	3,242	3,422	7,749	8,78
4,5	0,75	4,478	4,338	3,991	3,901	3,558	3,439	4,013	4,131	3,688	3,878	10,07	11,3
5	0,8	4,976	4,826	4,456	4,361	3,995	3,869	4,480	4,605	4,134	4,334	12,69	14,2
6	1	5,974	5,794	5,324	5,212	4,747	4,596	5,350	5,500	4,917	5,153	17,89	20,1
7	1	6,974	6,794	6,324	6,212	5,747	5,596	6,350	6,500	5,917	6,153	26,18	28,9
8	1,25	7,972	7,760	7,160	7,042	6,438	6,272	7,188	7,348	6,647	6,912	32,84	36,6
9	1,25	8,972	8,760	8,042	7,924	7,438	7,272	8,188	8,348	7,647	7,912	43,78	48,1
10	1,5	9,968	9,732	8,994	8,862	8,128	7,938	9,026	9,206	8,376	8,676	52,3	58,0
11	1,5	10,968	10,732	9,994	9,862	9,128	8,938	10,026	10,206	9,376	9,676	65,9	72,3
12	1,75	11,966	11,701	10,829	10,679	9,819	9,602	10,863	11,063	10,106	10,441	76,2	84,3
14	2	13,962	13,682	12,663	12,503	11,508	11,271	12,701	12,913	11,835	12,210	104,7	115
16	2	15,962	15,682	14,663	14,503	13,508	13,271	14,701	14,913	13,835	14,210	144,1	157
18	2,5	17,958	17,623	16,334	16,164	14,891	14,625	16,376	16,600	15,294	15,744	175,1	193
20	2,5	19,958	19,623	18,334	18,164	16,891	16,625	18,376	18,600	17,294	17,744	225,2	245
22	2,5	21,958	21,623	20,334	20,164	18,891	18,625	20,376	20,600	19,294	19,744	281,5	303
24	3	23,952	23,577	22,003	21,803	20,271	19,955	22,051	22,316	20,752	21,252	324,3	353
27	3	26,952	26,577	25,003	24,803	23,271	22,955	25,051	25,316	23,752	24,252	427,1	459
30	3,5	29,947	29,522	27,674	27,462	25,653	25,306	27,727	28,007	26,211	26,711	519,0	561
33	3,5	32,947	32,522	30,674	30,462	28,653	28,306	30,727	31,007	29,211	29,711	647,2	694
36	4	35,940	35,465	33,342	33,118	31,033	30,655	33,402	33,702	31,670	32,270	759,3	817
39	4	38,940	38,465	36,342	36,118	34,033	33,655	36,402	36,702	34,670	35,270	913	976
42	4,5	41,937	41,437	39,014	38,778	36,416	36,007	39,077	39,392	37,129	37,799	1045	1121
45	4,5	44,937	44,437	42,014	41,778	39,416	39,007	42,077	42,392	40,129	40,799	1224	1306
48	5	47,929	47,399	44,681	44,431	41,795	41,352	44,752	45,087	42,587	43,297	1377	1473
52	5	51,929	51,399	48,681	48,431	45,795	45,352	48,752	49,087	46,587	47,297	1652	1758
56	5,5	55,925	55,365	52,353	52,088	49,177	48,700	52,428	52,783	50,046	50,796	1905	2030
60	5,5	59,925	59,365	56,353	56,088	53,177	52,700	56,428	56,783	54,046	54,796	2227	2362
64	6	63,920	63,320	60,023	59,743	56,559	56,048	60,103	60,478	57,505	58,305	2520	2676
68	6	67,920	67,320	64,023	63,743	60,559	60,048	64,103	64,478	61,505	62,305	2888	3055

¹⁾ Wartości średnic nominalnych 1 do 1,4 mm odpowiadają pasowaniu 5H/6h.

²⁾ Gwint metryczny oznacza się średnicą nominalną, poprzedzoną literą M określającą profil, po których następuje klasa tolerancji, np. 6, oraz pozycja tolerancji, np.: M10-6g. Jeśli nie podano klasy tolerancji, obowiązują wyżej wymienione wartości pasowania. Dla średnic znamionowych powyżej 68 mm patrz: gwint metryczny, szereg drobnozwojny.

3.2 Gwint metryczny (ISO), szereg drobnozwojny – MF

Profil nominalny i profile graniczne

Linie pogrubione oznaczają maksymalne profile materiału. Maksymalny profil materiału gwintu wewnętrznego stanowi profil nominalny.

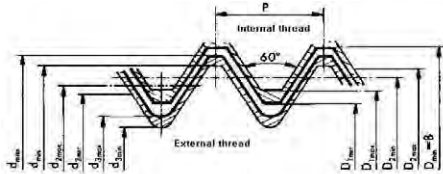

B = podstawowa średnica nominalna
P = skok gwintu

Gwint zewnętrzny

d = średnica nominalna
d₂ = średnica rdzenia
d₁ = średnica podziałowa

Gwint wewnętrzny

D = średnica nominalna
D₁ = średnica rdzenia
D₂ = średnica podziałowa

3.2.1 Wymiary graniczne dla gwintów metrycznych, szereg drobnozwojny, pasowanie 6H/6g

Poniższa tabela bazuje na normie ISO 965-1 (2013). Wymiary w mm.

Średn. ²⁾ nominalna	Skok	Gwint zewnętrzny, tolerancja 6g ¹⁾ (śruby i wkręty)						Gwint wewnętrzny, tolerancja 6H ¹⁾ (nakrętki)				Przekrój dla średnicy rdzenia	Powierz- chnia czynna gwintu
		Średnica nominalna		Średnica podziałowa		Średnica rdzenia		Średnica podziałowa		Średnica rdzenia			
B = D min.	P	d max.	d min.	d ₂ max.	d ₂ min.	d ₁ max.	d ₁ min.	D ₂ min.	D ₂ max.	D ₁ min.	D ₁ max.	A _{d3} mm ²	A _s mm ²
6	0,75	5,978	5,838	5,491	5,391	5,058	4,929	5,513	5,645	5,188	5,378	20,27	22,0
8	1	7,974	7,794	7,324	7,212	6,747	6,596	7,350	7,500	6,917	7,153	36,03	39,2
10	1	9,974	9,794	9,324	9,212	8,747	8,596	9,350	9,500	8,917	9,153	60,45	64,5
10	1,25	9,972	9,760	9,160	9,042	8,438	8,272	9,188	9,348	8,647	8,912	56,29	61,2
12	1	11,974	11,794	11,324	11,206	10,747	10,590	11,350	11,510	10,917	11,153	91,15	96,1
12	1,25	11,972	11,760	11,160	11,028	10,438	10,258	11,188	11,368	10,647	10,912	86,03	92,1
12	1,5	11,968	11,732	10,994	10,854	10,128	9,930	11,026	11,216	10,376	10,676	81,07	88,1
14	1,5	13,968	13,732	12,994	12,854	12,128	11,930	13,026	13,216	12,376	12,676	116,1	125
16	1,5	15,968	15,732	14,994	14,854	14,128	13,930	15,026	15,216	14,376	14,676	157,5	167
18	1,5	17,968	17,732	16,994	16,854	16,128	15,930	17,026	17,216	16,376	16,676	205,1	216
18	2	17,962	17,682	16,663	16,503	15,508	15,271	16,701	16,913	15,835	16,210	189,8	204
20	1,5	19,968	19,732	18,994	18,854	18,128	17,930	19,026	19,216	18,376	18,676	259,0	272
20	2	19,962	19,682	18,663	18,503	17,508	17,271	18,701	18,913	17,835	18,210	241,8	258
22	1,5	21,968	21,732	20,994	20,854	20,128	19,930	21,026	21,216	20,376	20,676	319,2	333
22	2	21,962	21,682	20,663	20,503	19,508	19,271	20,701	20,913	19,835	20,210	300,1	318
24	1,5	23,968	23,732	22,994	22,844	22,128	21,920	23,026	23,226	22,376	22,676	385,7	401
24	2	23,962	23,682	22,663	22,493	21,508	21,261	22,701	22,925	21,835	22,210	364,6	384
27	1,5	26,968	26,732	25,994	25,844	25,128	24,920	26,026	26,226	25,376	25,676	497,2	514
27	2	26,962	26,682	25,663	25,493	24,508	24,261	25,701	25,925	24,835	25,210	473,2	496
30	1,5	29,968	29,732	28,994	28,844	28,128	27,920	29,026	29,226	28,376	28,676	622,8	642
30	2	29,962	29,682	28,663	28,493	27,508	27,261	28,701	28,925	27,835	28,210	596,0	621
33	1,5	32,968	32,732	31,994	31,844	31,128	30,920	32,026	32,226	31,376	31,676	762,6	784
33	2	32,962	32,682	31,663	31,493	30,508	30,261	31,701	31,925	30,835	31,210	732,8	761
36	1,5	35,968	35,732	34,994	34,844	34,128	33,920	35,026	35,226	34,376	34,676	916,5	940
36	3	35,952	35,682	34,003	33,803	32,271	31,955	34,051	34,316	32,752	33,252	820,4	865
39	1,5	38,968	38,732	37,994	37,844	37,128	36,920	38,026	38,226	37,376	37,676	1085	1110
39	3	38,952	38,577	37,003	36,803	35,271	34,955	37,051	37,316	35,752	36,252	979,7	1028
42	1,5	41,968	41,732	40,994	40,844	40,128	39,920	41,026	41,226	40,376	40,676	1267	1294
42	3	41,952	41,577	40,003	39,803	38,271	37,955	40,051	40,316	38,752	39,252	1153	1206
45	1,5	44,968	44,732	43,994	43,844	43,128	42,920	44,026	44,226	43,376	43,676	1463	1492
45	3	44,952	44,577	43,003	42,803	41,276	40,955	43,051	43,316	41,752	42,252	1341	1398
48	1,5	47,968	47,732	46,994	46,834	46,128	45,910	47,026	47,238	46,376	46,676	1674	1705
48	3	47,952	47,577	46,003	45,791	44,271	43,943	46,051	46,331	44,752	45,252	1543	1604
52	1,5	51,968	51,732	50,994	50,834	50,128	49,910	51,026	51,238	50,376	50,676	1976	2010
52	3	51,952	51,577	50,003	49,791	48,271	47,943	50,051	50,331	48,752	49,252	1834	1900
56	2	55,962	55,682	54,663	54,483	53,508	53,251	54,701	54,937	53,835	54,210	2252	2301
56	4	55,940	55,465	53,342	53,106	51,033	50,643	53,402	53,717	51,670	52,270	2050	2144
60	4	59,940	59,465	57,342	57,106	55,033	54,643	57,402	57,717	55,670	56,270	2384	2485
64	4	63,940	63,465	61,342	61,106	59,033	58,643	61,402	61,717	59,670	60,270	2743	2851
68	4	67,940	67,465	65,342	65,106	63,033	62,643	65,402	65,717	63,670	64,270	3127	3242
72	6	71,920	71,320	68,023	67,743	64,559	64,048	68,103	68,478	65,505	66,305	3287	3463
76	6	75,920	75,320	72,023	71,743	68,559	68,048	72,103	72,478	69,505	70,305	3700	3889
80	6	79,920	79,320	76,023	75,743	72,559	72,048	76,103	76,478	73,505	74,305	4144	4344
90	6	89,920	89,320	86,023	85,743	82,559	82,048	86,103	86,478	83,505	84,305	5364	5590
100	6	99,920	99,320	96,023	95,723	92,559	92,028	96,103	96,503	93,505	94,305	6740	7000
110	6	109,920	109,320	106,023	105,723	102,559	102,028	106,103	106,503	103,505	104,305	8273	8560

¹⁾ Dla gwintów powlekanych maksymalne wartości dla d, d₂ i d₃ są równe wartościom profilu nominalnego. (d_{2max} = D_{2min} oraz d_{3max} = D_{1min})

²⁾ Gwint metryczny szereg drobnozwojny oznacza się średnicą nominalną, poprzedzoną literą M określającą profil, po których następuje skok gwintu oddzielony x, a następnie klasa tolerancji, np. 6, oraz pozycja tolerancji, np.: M10x1,25-6H. Jeśli nie podano klasy tolerancji, obowiązuje pasowanie 6H/6g.

3.3 Zunifikowany gwint (ISO) – UNC

Profil nominalny i profile graniczne

Linie pogrubione oznaczają maksymalne profile materiału. Maksymalny profil materiału gwintu wewnętrznego stanowi profil nominalny.

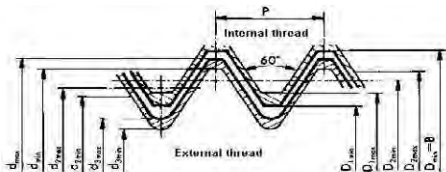

B = podstawowa średnica nominalna
 P = skok gwintu
 N = liczba zwojów na skok

Gwint zewnętrzny
 d = średnica nominalna
 d₂ = średnica rdzenia
 d₃ = średnica podziałowa

Gwint wewnętrzny
 D = średnica nominalna
 D₁ = średnica rdzenia
 D₂ = średnica podziałowa

3.3.1 Wymiary graniczne dla gwintów zunifikowanych: grubozwojny UNC, klasy tolerancji 2A i 2B

Poniższa tabela bazuje na normie ISO 5864. (1993) Wymiary w mm.

Śred. nominalna	Liczba zwojów	Gwint zewnętrzny, tolerancja 2A (śruby i wkręty)						Gwint wewnętrzny, tolerancja 2B (nakrętki)					Przekrój dla średnicy rdzenia $\frac{\pi}{4} d_3^2$	Powierzchnia czynna gwintu $\frac{\pi}{4} \left(\frac{d_2 + d_3}{2} \right)^2$
		Średnica nominalna		Średnica podziałowa		Średnica rdzenia		Średnica nominalna	Średnica podziałowa		Średnica rdzenia			
B cal	N	d _{max.}	d _{min.}	d _{2max.}	d _{2min.}	d _{3max.}	d _{3min.}	D _{min.}	D _{2min.}	D _{2max.}	D _{1min.}	D _{1max.}	A _{d3} mm ²	A _s mm ²
1/4	20	6,322	6,117	5,496	5,403	4,765	4,580	6,350	5,525	5,646	4,979	5,257	17,4	20,5
5/16	18	7,907	7,687	6,990	6,889	6,174	5,972	7,938	7,021	7,155	6,401	6,731	29,3	33,8
3/8	16	9,491	9,254	8,460	8,349	7,543	7,318	9,525	8,494	8,638	7,798	8,153	43,7	50
7/16	14	11,076	10,816	9,898	9,779	8,851	8,603	11,113	9,934	10,088	9,144	9,550	60,2	68,6
1/2	13	12,661	12,386	11,391	11,265	10,264	9,998	12,700	11,430	11,595	10,592	11,023	81,1	91,5
9/16	12	14,246	13,958	12,872	12,741	11,650	11,367	14,288	12,914	13,086	11,989	12,446	105	117,4
5/8	11	15,834	15,528	14,335	14,197	13,002	12,698	15,875	14,377	14,559	13,386	13,868	130	146
3/4	10	19,004	18,677	17,353	17,204	15,887	15,555	19,050	17,399	17,594	16,307	16,840	195	215
7/8	9	22,176	21,824	20,342	20,183	18,714	18,352	22,225	20,392	20,599	19,177	19,761	270	298
1IN,	8	25,349	24,969	23,286	23,114	21,452	21,052	25,400	23,338	23,561	21,971	22,606	355	391
1 1/8	7	28,519	28,103	26,162	25,980	24,066	23,623	28,575	26,218	26,456	24,638	25,349	447	492
1 1/4	7	31,694	31,278	29,337	29,150	27,241	26,792	31,750	29,393	29,636	27,813	28,524	574	625
1 3/8	6	34,864	34,402	32,113	31,911	29,669	29,162	34,925	32,175	32,438	30,353	31,115	680	745
1 1/2	6	38,039	37,577	35,288	35,083	32,844	32,335	38,100	35,350	35,615	33,528	34,290	835	906
1 3/4	5	44,381	43,861	41,081	40,856	38,148	37,557	44,450	41,151	41,445	38,964	39,827	1123	1226
2IN,	4 1/2	50,726	50,168	47,061	46,820	43,802	43,155	50,800	47,135	47,449	44,679	45,593	1484	1613
2 1/4	4 1/2	57,076	56,518	53,411	53,165	50,152	49,500	57,150	53,485	53,804	51,029	51,943	1948	2097
2 1/2	4	63,421	62,817	59,296	59,033	55,631	54,910	63,500	59,376	59,717	56,617	57,581	2400	2581
2 3/4	4	69,768	69,165	65,643	65,378	61,978	61,255	69,850	65,726	66,073	62,967	63,931	2981	3181
3IN,	4	76,118	75,515	71,993	71,722	68,328	67,600	76,200	72,076	72,428	69,317	70,281	3626	3852

Zunifikowany gwint niemetryczny oznacza się średnicą nominalną, po której następuje liczba zwojów na cal (n), seria gwintu UNC oraz klasa tolerancji, np. 3/8 – 16 UNC – 2A. Jeśli nie podano klasy tolerancji, obowiązuje pasowanie 2A/2B

Dla gwintów zewnętrznych powlekanych maksymalne wartości dla d, d₂ i d₃ są równe wartościom profilu nominalnego. (d_{2max.} = D_{2min.} oraz d_{3max.} = D_{1min.}).

3.4 Zunifikowany gwint (ISO) – UNF

Profil nominalny i profile graniczne

Linie pogrubione oznaczają maksymalne profile materiału. Maksymalny profil materiału gwintu wewnętrznego stanowi profil nominalny.

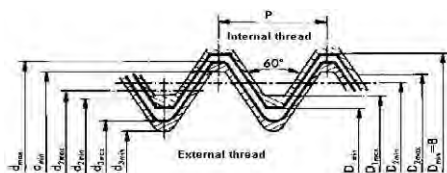

B = podstawowa średnica nominalna
P = skok gwintu
N = liczba zwojów na skok

Gwint zewnętrzny
d = średnica nominalna
d₃ = średnica rdzenia
d₂ = średnica podziałowa

Gwint wewnętrzny
D = średnica nominalna
D₁ = średnica rdzenia
D₂ = średnica podziałowa

3.4.1 Wymiary graniczne dla gwintów zunifikowanych: drobnozwojny UNF, klasy tolerancji 2A i 2B

Poniższa tabela bazuje na normie ISO 5864. (1993) Wymiary w mm.

Śred. nominalna	Liczba zwojów	Gwint zewnętrzny, tolerancja 2A (śruby i wkręty)						Gwint wewnętrzny, tolerancja 2B (nakrętki)					Przekrój dla średnicy rdzenia $\frac{\pi}{4} d_1^2$ A _{d3} mm ²	Powierzchnia czynna gwintu $\frac{\pi}{4} \left(\frac{d_2 + d_3}{2} \right)^2$ A _s mm ²
		Średnica nominalna		Średnica podziałowa		Średnica rdzenia		Średnica nominalna	Średnica podziałowa	Średnica rdzenia				
B cal	N	d _{max.}	d _{min.}	d _{2max.}	d _{2min.}	d _{3max.}	d _{3min.}	D _{min.}	D _{2min.}	D _{2max.}	D _{1min.}	D _{1max.}		
1/4	28	6,324	6,160	5,735	5,652	5,212	5,063	6,350	5,761	5,869	5,360	5,588	21,0	23,5
5/16	24	7,909	7,727	7,221	7,128	6,611	6,442	7,938	7,250	7,371	6,782	7,035	33,8	37,4
3/8	24	9,497	9,315	8,808	8,713	8,199	8,027	9,525	8,837	8,961	8,382	8,636	52,2	56,6
7/16	20	11,079	10,874	10,253	10,148	9,522	9,325	11,113	10,287	10,424	9,729	10,033	70,3	76,6
1/2	20	12,666	12,462	11,841	11,733	11,109	10,910	12,700	11,875	12,016	11,329	11,607	95,9	103
9/16	18	14,251	14,031	13,335	13,221	12,519	12,304	14,288	13,371	13,520	12,751	13,081	122	131
5/8	18	15,839	15,619	14,922	14,804	14,107	13,887	15,875	14,959	15,110	14,351	14,681	155	165
3/4	16	19,011	18,774	17,980	17,854	17,063	16,823	19,050	18,019	18,183	17,323	17,678	226	241
7/8	14	22,184	21,923	21,005	20,869	19,959	19,693	22,225	21,047	21,224	20,270	20,675	310	328
1IN.	12	25,354	25,065	23,980	23,831	22,758	22,457	25,400	24,026	24,218	23,114	23,571	403	428
1IN.	14	25,357	25,095	24,178	24,036	23,123	25,400	24,220	24,407	23,444	23,825	–	420	439
1 1/8	12	28,529	28,240	27,155	27,003	25,933	25,629	28,575	27,201	27,398	26,289	26,746	524	552
1 1/4	12	31,704	31,415	30,330	30,173	29,108	28,799	31,750	30,376	30,579	29,464	29,921	661	692
1 3/8	12	34,879	34,588	33,502	33,343	32,280	31,969	34,925	33,551	33,759	32,639	33,096	813	848
1 1/2	12	38,051	37,763	36,677	36,516	35,455	35,141	38,100	36,726	36,936	35,814	36,271	981	1020

Zunifikowany gwint niemetryczny oznacza się średnicą nominalną, po której następuje liczba zwojów na cal (n), szereg gwintu UNF oraz klasa tolerancji, np. 3/8 – 24 UNF – 2A. Jeśli nie podano klasy tolerancji, obowiązuje pasowanie 2A/2B

Dla gwintów zewnętrznych powlekanych maksymalne wartości dla d, d₂ i d₃ są równe wartościom profilu nominalnego. (d_{2max.} = D_{2min.} oraz d_{3max.} = D_{1min.}.)

3.5 Zunifikowany gwint o skoku uprzywilejowanym (ISO) - 8UN

Profil nominalny i profile graniczne

Linie pogrubione oznaczają maksymalne profile materiału. Maksymalny profil materiału gwintu wewnętrznego stanowi profil nominalny.

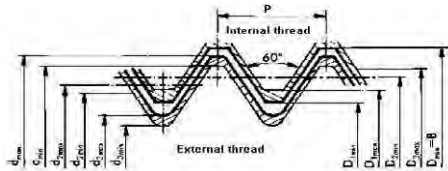

B = podstawowa średnica nominalna
 P = skok gwintu
 N = liczba zwojów na skok

Gwint zewnętrzny
 d = średnica nominalna
 d₃ = średnica rdzenia
 d₂ = średnica podziałowa

Gwint wewnętrzny
 D = średnica nominalna
 D₁ = średnica rdzenia
 D₂ = średnica podziałowa

3.5.1 Wymiary graniczne dla gwintów zunifikowanych - 8UN, klasy tolerancji 2A i 2B

Poniższa tabela bazuje na normie ISO 5864. (1993) Wymiary w mm.

Śred. nominalna	Liczba zwojów	Gwint zewnętrzny, tolerancja 2A (śruby i wkręty)					Gwint wewnętrzny, tolerancja 2B (nakrętki)					Przekrój dla średnicy rdzenia $\frac{\pi}{4} d_3^2$	Powierzchnia czynna gwintu $\frac{\pi}{4} \left(\frac{d_2 + d_3}{2} \right)^2$
		Średnica nominalna	Średnica podziałowa	Średnica rdzenia	Średnica nominalna	Średnica podziałowa	Średnica rdzenia						
B inch	N	d _{max}	d _{min}	d _{2max}	d _{2min}	nominal	D _{min}	D _{2min}	D _{2max}	D _{1min}	D _{1max}	A _{q3} mm ²	A _s mm ²
1/8	8	28,521	28,141	26,459	26,284	24,653	28,575	26,513	26,741	25,146	25,781	470	510
1/4	8	31,697	31,316	29,634	29,456	27,800	31,750	29,688	29,921	28,321	28,956	599	645
3/8	8	34,869	34,488	32,807	32,624	30,973	34,925	32,863	33,099	31,496	32,131	745	795
1/2	8	38,044	37,663	35,982	35,796	34,148	38,100	36,038	36,279	34,671	35,306	906	963
5/8	8	41,219	40,838	39,157	38,969	37,323	41,275	39,213	39,459	37,846	38,481	1084	1148
3/4	8	44,392	44,011	43,329	42,139	40,495	44,450	42,388	42,636	41,021	41,656	1277	1342
1 1/8	8	47,567	47,186	45,564	45,309	43,670	47,625	45,563	45,817	44,196	44,831	1484	1555
2IN.	8	50,742	50,361	48,679	48,481	46,845	50,800	48,738	48,994	47,371	47,371	1710	1787

Zunifikowany gwint o uprzywilejowanym skoku oznacza się średnicą nominalną, po której następuje liczba zwojów na cal (n), szereg gwintu UN oraz klasa tolerancji, np. 1.3/8 – 8UN – 2A. Jeśli nie podano klasy tolerancji, obowiązuje pasowanie 2A/2B.

Dla gwintów zewnętrznych powlekanych maksymalne wartości dla d, d₂ i d₃ są równe wartościom profilu nominalnego. (d_{2max} = D_{2min} oraz d_{3max} = D_{1min}).

3.6 Zunifikowane gwinty (ISO) - UNC i UNF

Profil nominalny i profile graniczne

Linie pogrubione oznaczają maksymalne profile materiału. Maksymalny profil materiału gwintu wewnętrznego stanowi profil nominalny.

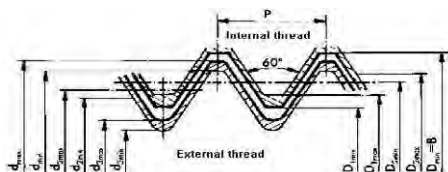

B = podstawowa średnica nominalna
P = skok gwintu
N = liczba zwojów na skok

Gwint zewnętrzny
d = średnica nominalna
d₂ = średnica rdzenia
d₃ = średnica podziałowa

Gwint wewnętrzny
D = średnica nominalna
D₁ = średnica rdzenia
D₂ = średnica podziałowa

3.6.1 Wymiary graniczne dla gwintów zunifikowanych – UNC i UNF, klasy tolerancji 2A i 2B

Poniższa tabela bazuje na normie ISO 5864. (1993) Wymiary w mm.

Oznaczenie	Średnica nominalna	Liczba zwojów	Gwint zewnętrzny, tolerancja 2A (śruby i wkręty)					Gwint wewnętrzny, tolerancja 2B (nakrętki)			
			Średnica nominalna		Średnica podziałowa		Średnica rdzenia	Średnica podziałowa		Średnica rdzenia	
			d _{max.}	d _{min.}	d _{2max.}	d _{2min.}	d _{3max.}	D _{2min.}	D _{2max.}	D _{1min.}	D _{1max.}
B	N										
2-56 UNC	2,184	56	2,169	2,066	1,874	1,822	1,612	1,890	1,960	1,695	1,871
3-48 UNC	2,514	48	2,496	2,383	2,153	2,096	1,846	2,172	2,247	1,941	2,146
4-40 UNC	2,844	40	2,824	2,695	2,413	2,350	2,044	2,434	2,517	2,157	2,385
5-40 UNC	3,175	40	3,154	3,026	2,743	2,678	2,374	2,764	2,847	2,487	2,697
6-32 UNC	3,505	32	3,484	3,333	2,969	2,899	2,512	2,990	3,083	2,642	2,895
8-32 UNC	4,165	32	4,142	3,991	3,627	3,554	3,169	3,650	3,746	3,302	3,530
10-24 UNC	4,826	24	4,800	4,618	4,112	4,029	3,502	4,138	4,246	3,683	3,962
12-24 UNC	5,486	24	5,461	5,279	4,772	4,687	4,163	4,799	4,909	4,344	4,597
4-48 UNF	2,844	48	2,827	2,713	2,484	2,424	2,176	2,502	2,580	2,271	2,458
5-44 UNF	3,175	44	3,157	3,036	2,781	2,718	2,448	2,800	2,880	2,551	2,740
6-40 UNF	3,505	40	3,484	3,356	3,073	3,008	2,705	3,094	3,180	2,820	3,022
8-36 UNF	4,165	36	4,145	4,006	3,688	3,617	3,279	3,709	3,799	3,404	3,606
10-32 UNF	4,826	32	4,803	4,651	4,287	4,212	3,830	4,311	4,409	3,963	4,165
12-28 UNF	5,486	28	5,461	5,296	4,871	4,791	4,348	4,898	5,003	4,496	4,724

3.7 Gwinty – drobnozwojne a grubozwojne

3.7.1 Wyjaśnienie

Ogólna tendencja dla przemysłowych elementów złącznych wykazuje stopniowe, ale zauważalne przeniesienie popularności w kierunku gwintów grubozwojnych. Słusznie, gdyż jest coraz mniej powodów uzasadniających stosowanie gwintów drobnozwojnych. Chociaż gwinty drobnozwojne znajdują zastosowanie w przypadkach szczególnych, przypadki te występują tak rzadko, że elementy złączne z gwintem drobnozwojnym stają się coraz częściej produktem specjalnym z całą gamą towarzyszących wad ekonomicznych (wyższa cena, słaba dostępność, podwojone zapasy). Gwint drobnozwojny został stworzony głównie dla przemysłu samochodowego (gdzie nadal jest popularny) oraz branż pokrewnych.

Najważniejsze argumenty zwolenników gwintu drobnozwojowego to:

- wysoka wytrzymałość na rozciąganie statyczne ze względu na większą powierzchnię czynną gwintu
- ze względu na mniejszy kąt pochylenia linii śrubowej gwint ten zapewnia większą odporność na luzowanie w chwili, gdy jest poddany wibracjom
- lepsza dokładność regulacji.

W praktyce jednak większość konstrukcji nie jest obciążana statycznie lecz dynamicznie, więc właściwym kryterium jest wytrzymałość na zmęczenie. Gwint grubozwojny wykazuje lepszą wytrzymałość na zmęczenie, ponieważ koncentracja naprężenia u nasady zmniejsza się wraz ze wzrostem skoku gwintu. Argument o lepszej odporności na luzowanie stał się przestarzały dzięki rozwojowi mechanicznych i chemicznych systemów blokowania, które zapewniają bardziej skuteczne rozwiązanie dla utraty wstępnego naprężenia szczególnie wtedy, gdy złącze poddane jest dynamicznym siłom ścinającym.

Dalsze zalety gwintu grubozwojnego obejmują:

- mniejszą podatność na uszkodzenie i na ogół łatwiejszy, i szybszy montaż
- możliwość stosowania grubszych powłok w wyniku większych naddatków gwintu
- mniejsze ryzyko zerwania gwintu.

Najważniejsze zalety i wady zostały posumowane w poniższej tabeli:

Właściwości funkcjonalne	Gwint grubozwojny ¹⁾	Gwint drobnozwojny
Wytrzymałość statyczna	+	++
Wytrzymałość dynamiczna	+	-
Odporność na luzowanie	-	+
Niewrażliwość na uszkodzenie	+	-
Grubość powłoki	+	-
Niewrażliwość na zerwanie	+	-
Łatwość montażu	+	-
Niski koszt/dostępność	+	-

¹⁾ Gwint grubozwojny jest zalecany dla znormalizowanych elementów złącznych w konstrukcjach typu ogólnego.

3.8 Gwinty metryczne o klasie tolerancji Sk6 dla śrub dwustronnych DIN 939

Profil nominalny i profile graniczne

Linia pogrubiona oznacza maksymalny profil materiału.

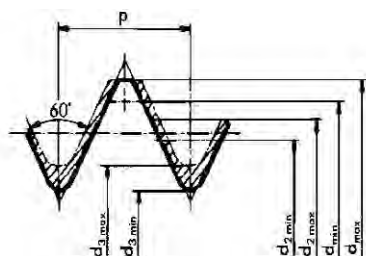

P = Skok gwintu
d = średnica znamionowa = wielkość normalna
 d_2 = średnica podziałowa
 d_3 = średnica rdzenia

Klasa tolerancji Sk6 jest używana dla zastosowań ogólnych, np. wstawiany koniec śruby dwustronnej wg DIN 939 (połączenia z funkcją uszczelnienia) oraz w kombinacji z gwintem wewnętrznym, o klasie tolerancji drobnej (4H odpowiednio, 4H5H) wg DIN 13 część 14. W rzeczywistości te klasy tolerancji dla średnicy podziałowej dotyczą pasowania przejściowego, gdyż w wielu przypadkach nie dochodzi do faktycznego pasowania z wciskiem.

Uwaga:

Opracowano prawdziwe dopasowanie z wciskiem dla gwintów metrycznych (MFS), które realizuje się poprzez zawarcie nadmiaru w średnicy znamionowej. Patrz: DIN 8141 Część 1 szukając tolerancji oraz DIN 8141 Część 2 szukając skojarzonych wielkości gwintów. Jednakże normy te stosuje się jedynie do zastosowań dla odlewów aluminiowych dla wielkości od M5 do M16. Dalszy rozwój zależy od zdobytego doświadczenia.

3.8.1 Wymiary graniczne dla gwintów metrycznych o klasie tolerancji Sk6

Poniższa tabela bazuje na normie DIN 13-51 (2013). Wymiary w mm.

Średnica znamionowa	Skok	Gwint zewnętrzny (śruby dwustronne)					
		średnica znamionowa		średnica podziałowa		średnica rdzenia	
d	P	d_{max}	d_{min}	d_{2max}	d_{2min}	d_{3max}	d_{3min}
6	1	6	5,776	5,406	5,335	4,773	4,663
(7) ¹⁾	1	7	6,776	6,406	6,335	5,773	5,633
8	1,25	8	7,750	7,244	7,173	6,466	6,343
(9) ¹⁾	1,25	9	8,750	8,244	8,173	7,466	7,343
10	1,5	10	9,720	9,082	9,011	8,160	8,017
(11) ¹⁾	1,5	11	10,720	10,082	10,011	9,160	9,017
12	1,75	12	11,600	10,943	10,843	9,853	9,691
14	2	14	13,525	12,781	12,681	11,546	11,369
16	2	16	15,525	14,781	14,681	13,546	13,369
18	2,5	18	17,470	16,456	16,356	14,933	14,731
20	2,5	20	19,470	18,456	18,356	16,933	16,731
22	2,5	22	21,470	20,456	20,356	18,933	18,731
24	3	24	23,400	22,131	22,031	20,319	20,078

¹⁾ raczej nie stosować

Oznaczenie takiego gwintu np. M12 Sk6

3.9 Gwint wkrętów samogwintujących – ST

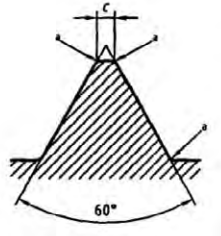
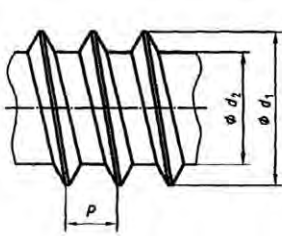

Krawędzie lekko sfazowane w punkcie (a)

3.9.1 Wymiary graniczne gwintów wkrętów samogwintujących

Poniższa tabela bazuje na normie ISO 1478 (1999). Wymiary w mm.

Średnica znamionowa	Nr	Skok P	Średnica znamionowa		Średnica rdzenia		Średnica końcówki płaskiej		Spłaszczenie grzbietu gwintu c _{max.}	Długość grzbietu stożkowego y _{max}		
			d _{1max.}	d _{1min.}	d _{2max.}	d _{2min.}	d _{3max.}	d _{3min.}		Typ C	Typ F	Typ R
ST 2,2	2	0,8	2,24	2,1	1,63	1,52	1,47	1,37	0,1	2	1,6	--
ST 2,6	3	0,9	2,57	2,43	1,9	1,8	1,73	1,6	0,1	2,3	1,8	--
ST 2,9	4	1,1	2,9	2,76	2,18	2,08	2,01	1,88	0,1	2,6	2,1	--
ST 3,3	5	1,3	3,3	3,12	2,39	2,29	2,21	2,08	0,1	3	2,5	--
ST 3,5	6	1,3	3,53	3,35	2,64	2,51	2,41	2,26	0,1	3,2	2,5	2,7
ST 3,9	7	1,4	3,91	3,73	2,92	2,77	2,67	2,51	0,1	3,5	2,7	3
ST 4,2	8	1,4	4,22	4,04	3,10	2,95	2,84	2,69	0,1	3,7	2,8	3,2
ST 4,8	10	1,6	4,8	4,62	3,58	3,43	3,3	3,12	0,15	4,3	3,2	3,6
ST 5,5	12	1,8	5,46	5,28	4,17	3,99	3,86	3,68	0,15	5	3,6	4,3
ST 6,3	14	1,8	6,25	6,03	4,88	4,7	4,55	4,34	0,15	6	3,6	5
ST 8	16	2,1	8	7,78	6,2	5,99	5,84	5,64	0,15	7,5	4,2	6,3

3.9.2 Końcówki gwintu wkrętów samogwintujących

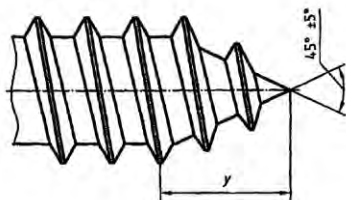

Typ C (stożkowy)

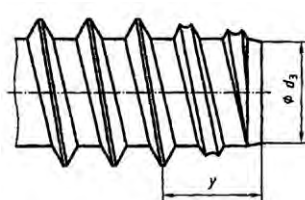

Typ F (płaski)

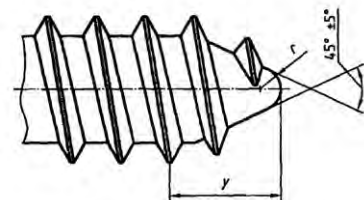

Type R (zaokrąglony)

3.10 Gwint metryczny stożkowy zewnętrzny – DIN 158-1



Metryczny gwint stożkowy zewnętrzny jest przeznaczony do zastosowania w połączeniach płyno-/gazoszczelnych takich jak korki do rur wg DIN 906, smarowniczkę itp. Do rozmiaru M26 nie wymagany jest żaden środek uszczelniający dla olejów, innych płynów i gazów; dla rozmiarów powyżej M26 zalecany środek uszczelniający. Metryczny gwint stożkowy zewnętrzny jest zazwyczaj łączony z gwintem walcowym wg DIN 158. Metryczny gwint stożkowy zewnętrzny drobnozwojowy jest oznaczany wartością średnicy znamionowej poprzedzoną literą profilu M, po której następuje skok, oddzielonymi „x”, np. M 20x1.5 .

3.10.1 Wymiary graniczne dla metrycznego gwintu stożkowego zewnętrznego, typ krótki

Poniższa tabela bazuje na normie DIN 158-1 (1997). Wymiary w mm.

Średnica znamionowa x P	Średnica znamionowa		Średnica podziałowa		Średnica rdzenia		Długość pomiarowa b	Długość użyteczna gwintu l ₁
	d _{max.}	d _{min.}	d _{2max.}	d _{2min.}	d _{1max.}	d _{1min.}		
M 8x1	8,093	8,033	7,443	7,383	6,866	6,806	3	4
M 10x1	10,093	10,033	9,443	9,383	8,866	8,806	3	4
M 12x1,5	12,235	12,141	11,261	11,167	10,395	10,301	5,5	7,5
M 14x1,5	14,235	14,141	13,261	13,167	12,395	12,301	5,5	7,5
M 16x1,5	16,235	16,141	15,261	15,167	14,395	14,301	5,5	7,5
M 18x1,5	18,235	18,141	17,261	17,167	16,395	16,301	5,5	7,5
M 20x1,5	20,235	20,141	19,261	19,167	18,395	18,301	5,5	7,5
M 22x1,5	22,235	22,141	21,261	21,167	20,395	20,301	5,5	7,5
M 24x1,5	24,235	24,141	23,261	23,167	22,395	22,301	5,5	7,5
M 30x1,5	30,235	30,141	29,261	29,167	28,395	28,301	5,5	7,5
M 36x1,5	36,282	36,141	35,308	35,182	34,442	34,316	6,9	9
M 42x1,5	42,282	42,156	41,308	41,182	40,442	40,316	6,9	9

3.11 Gwint zewnętrzny stożkowy rurowy Whitwortha R – DIN 3858

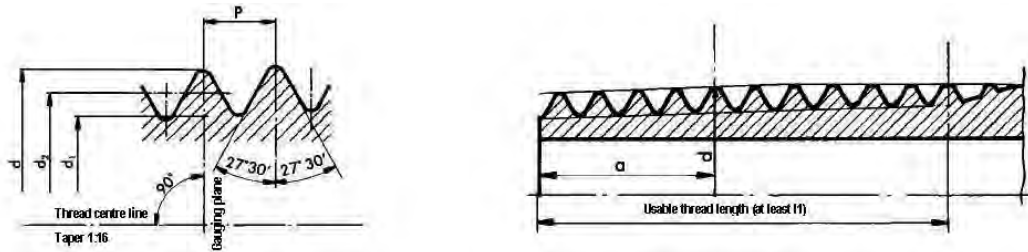

3.11.1 Wymiary znamionowe gwintów stożkowych zewnętrznych o tolerancji 2, typ krótki (a)

Poniższa tabela bazuje na normie DIN 3858 (2005). Wymiary w mm.

Oznaczenie	Liczba zwojów N	Skok P	Gwint zewnętrzny				
			Średnica znamionowa d	Średnica podziałowa d ₂	Średnica rdzenia d ₁	Długość pomiarowa a	Długość użyteczna gwintu l ₁
R $\frac{1}{8}$	28	0,907	9,728	9,147	8,566	3	5,5
R $\frac{1}{4}$	19	1,337	13,157	12,301	11,445	4,5	8,2
R $\frac{3}{8}$	19	1,337	16,662	15,806	14,950	4,5	8,2
R $\frac{1}{2}$	14	1,814	20,955	19,793	18,631	5	10,0
R $\frac{3}{4}$	14	1,814	26,441	25,279	24,117	6	11,0
R1	11	2,309	33,249	31,770	30,291	7	13,4
R1 $\frac{1}{4}$	11	2,309	41,910	40,431	38,952	7,5	13,9
R1 $\frac{1}{2}$	11	2,309	47,803	46,324	44,845	7,5	13,9

Gwint zewnętrzny stożkowy do rur Whitwortha jest oznaczany literą profilu R, po której następuje średnica znamionowa w calach, np.: R1/8.

3.12 Gwint rurowy równoległy thread G – ISO 228-1

Linia pogrubiona oznacza maksymalny profil materiału

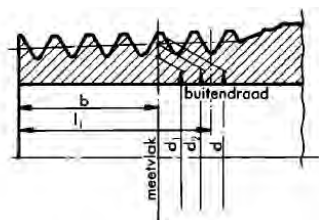

P = skok gwintu
N = liczba zwojów na skok

Gwint zewnętrzny
d = średnica nominalna
d₃ = średnica rdzenia
d₂ = średnica podziałowa

Gwint wewnętrzny
D = średnica nominalna
D₁ = średnica rdzenia
D₂ = średnica podziałowa

Gwint rurowy równoległy Whitwortha - G przeznaczony jest do mechanicznych mocnoszczelnych złączy dla armatury, zaworów, kurków itd., gdzie nie wykonano uszczelnienia na gwincie. Gwint ten jest oznaczany literą profilu G, po której następuje duża litera A lub B oznaczająca klasę tolerancji, np. dla gwintu zewnętrznego G $\frac{1}{2}$ A i gwintu wewnętrznego G $\frac{1}{2}$.

3.12.1 Wymiary graniczne dla gwintów rurowych równoległych - G

Poniższa tabela bazuje na normie ISO 228-1 (2000). Wymiary w mm.

Gwint zewnętrzny, klasa tolerancji A							Gwint wewnętrzny						
Oznaczenie	Liczba zwojów	Średnica znamionowa		Średnica podziałowa		Średnica rdzenia	Oznaczenie	Liczba zwojów	Średnica znamionowa	Średnica podziałowa		Średnica rdzenia	
	N	d _{max.}	d _{min.}	d _{2max.}	d _{2min.}	d _{1nom.}		N	D _{Basic}	D _{2max.}	D _{2min.}	D _{1max.}	D _{1min.}
G $\frac{1}{8}$ A	28	9,728	9,514	9,147	9,040	8,566	G $\frac{1}{8}$	28	9,728	9,254	9,147	8,848	8,566
G $\frac{1}{4}$ A	19	13,157	12,907	12,301	12,176	11,445	G $\frac{1}{4}$	19	13,157	12,426	12,301	11,890	11,445
G $\frac{3}{8}$ A	19	16,662	16,412	15,806	15,681	14,950	G $\frac{3}{8}$	19	16,662	15,931	15,806	15,395	14,950
G $\frac{1}{2}$ A	14	20,955	20,671	19,793	19,651	18,631	G $\frac{1}{2}$	14	20,995	19,935	19,793	19,172	18,631
G $\frac{5}{8}$ A	14	22,911	22,627	21,749	21,607	20,587	G $\frac{5}{8}$	14	22,911	21,891	21,749	21,128	20,587
G $\frac{3}{4}$ A	14	26,441	26,157	25,279	25,137	24,117	G $\frac{3}{4}$	14	26,441	25,421	25,279	24,658	24,117
G $\frac{7}{8}$ A	14	30,201	29,917	29,039	28,897	27,877	G $\frac{7}{8}$	14	30,201	29,181	29,039	29,418	27,877
G1A	11	33,249	32,889	31,770	31,590	30,291	G1	11	33,249	31,950	31,770	30,931	30,291
G1 $\frac{1}{8}$ A	11	37,897	37,537	36,418	36,238	34,939	G1 $\frac{1}{8}$	11	37,897	36,598	36,418	35,579	34,939
G1 $\frac{1}{4}$ A	11	41,910	41,550	40,431	40,251	38,952	G1 $\frac{1}{4}$	11	41,910	40,611	40,431	39,592	38,952
G1 $\frac{1}{2}$ A	11	47,803	47,443	46,324	46,144	44,845	G1 $\frac{1}{2}$	11	47,803	46,504	46,324	45,485	44,845

4 Normy podstawowe

4.1 Wymiary otworów rdzeniowych dla wkrętów i śrub samogwintujących

4.1.1 Wskazówki zastosowania

Istotną cechą gwintu wkrętów samogwintujących jest jego zdolność do bezwiónowego nacinania gwintu wewnętrznego w otworze rdzeniowym materiałów przeznaczonych do złączenia. Zamieszczone tu dane dotyczące otworów rdzeniowych, obliczone teoretycznie w oparciu o rzeczywiste testy, obowiązują dla elementów złącznych z gwintem samogwintującym zgodnym z normą ISO 1478 i dotyczą jedynie zastosowania w metalach o podanych w tabeli wartościach wytrzymałości na rozciąganie. Nie dotyczą zastosowania w tworzywach sztucznych, dla których opracowano kilka modyfikacji gwintów do wkrętów samogwintujących. Ponadto, gwintów tych nie stosuje się w stali nierdzewnej. Nie ma możliwości określenia ogólnych zaleceń i należy dokonać ustaleń na bazie indywidualnych przypadków dla warunków, w których takie złącza są możliwe. Dotyczy to również wkrętów samogwintujących do stali nierdzewnej. Podczas wkręcania wkrętów powłoki zewnętrzne mogą mieć taki wpływ na współczynniki tarcia, że wymiary otworów rdzeniowych będą wymagały dostosowania.

Dla blach o grubości do 2 mm otwory są zazwyczaj wybijane, a nie nawiercane. Z powodu utwardzania na zimno ściany otworu, otwór musi być od 0,1 do 0,3 mm większy, w zależności od materiału i grubości blachy. Należy się upewnić, że kierunek wkręcania wkrętu jest zgodny z kierunkiem wybicia otworu a nie odwrotny.

- Najczęściej stosuje się wkręty samogwintujące z końcówką typu C i typu R (patrz poprzedni rozdział), szczególnie w przypadku łączenia wielu arkuszy blachy, kiedy końcówka prowadząca umożliwia właściwe osiowanie otworów.
- Gwint wkrętów samogwintujących z końcówką płaską typu F (patrz poprzedni rozdział) preferowany jest w przypadkach, gdy ostre, przechodzące na wskroś wierzchołki mogłyby spowodować problemy, np. skałeczenia.

4.1.2 Możliwości zastosowania

Grubość blachy jest nie mniejsza niż skok gwintu.

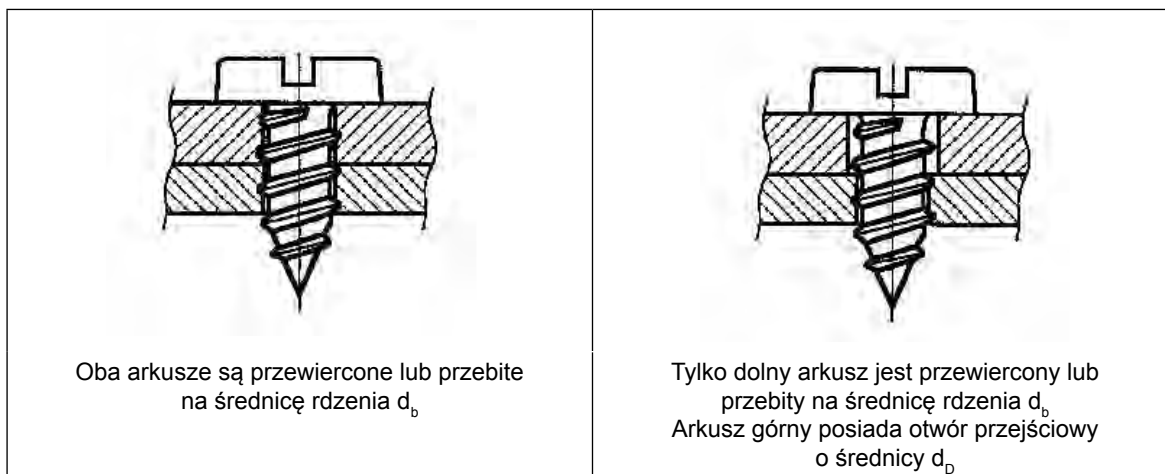

Grubości blach cieńszych

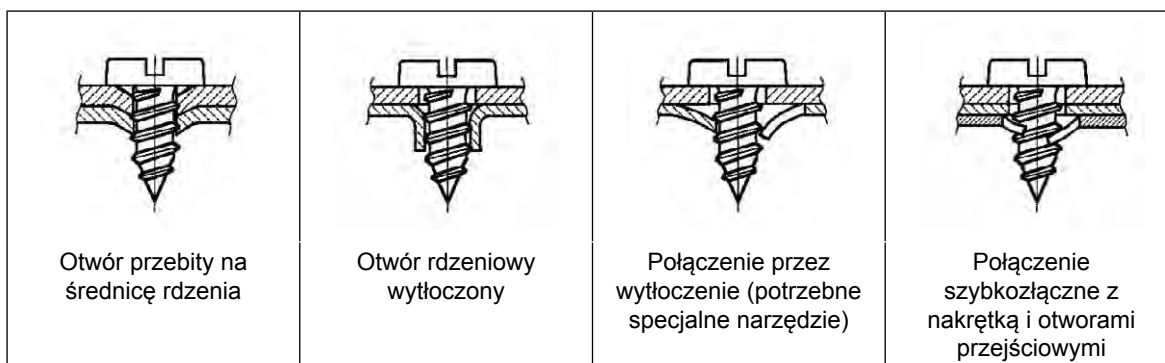

4.1.3 Wskazówki dla średnic otworów rdzeniowych d_b^1

Poniższa tabele bazują na normie DIN 7975 (1989). Wymiary w mm.

Średnice otworu rdzeniowego dla gwintów wkrętów samogwintujących ST2,2										Średnice otworu rdzeniowego dla gwintów wkrętów samogwintujących ST2,9									
Grubość blachy ²	Wytrzymałość materiału na rozciąganie R_m wyrażona w N/mm ²									Grubość blachy ²	Wytrzymałość materiału na rozciąganie R_m wyrażona w N/mm ²								
	100	150	200	250	300	350	400	450	500		100	150	200	250	300	350	400	450	500
0,8	1,7	1,7	1,7	1,7	1,7	1,7	1,7	1,7	1,7	1,1	2,2	2,2	2,2	2,2	2,2	2,2	2,2	2,2	2,3
0,9	1,7	1,7	1,7	1,7	1,7	1,7	1,7	1,7	1,7	1,2	2,2	2,2	2,2	2,2	2,2	2,2	2,2	2,2	2,3
1,0	1,7	1,7	1,7	1,7	1,7	1,7	1,7	1,7	1,8	1,3	2,2	2,2	2,2	2,2	2,2	2,2	2,3	2,3	2,3
1,1	1,7	1,7	1,7	1,7	1,7	1,7	1,7	1,8	1,8	1,4	2,2	2,2	2,2	2,2	2,2	2,3	2,3	2,4	2,4
1,2	1,7	1,7	1,7	1,7	1,7	1,7	1,8	1,8	1,8	1,5	2,2	2,2	2,2	2,2	2,3	2,3	2,4	2,4	2,4
1,3	1,7	1,7	1,7	1,7	1,7	1,8	1,8	1,8	1,8	1,6	2,2	2,2	2,2	2,2	2,3	2,3	2,4	2,4	2,4
1,4	1,7	1,7	1,7	1,7	1,7	1,8	1,8	1,8	1,9	1,7	2,2	2,2	2,2	2,2	2,3	2,4	2,4	2,4	2,4
1,5	1,7	1,7	1,7	1,7	1,8	1,8	1,8	1,9	1,9	1,8	2,2	2,2	2,2	2,3	2,3	2,4	2,4	2,4	2,5
1,6	1,7	1,7	1,7	1,8	1,8	1,8	1,9	1,9	1,9	1,9	2,2	2,2	2,2	2,3	2,4	2,4	2,4	2,5	2,5
1,7	1,7	1,7	1,7	1,8	1,8	1,9	1,9	1,9	1,9	2,0	2,2	2,2	2,3	2,3	2,4	2,4	2,5	2,5	2,5
1,8	1,7	1,7	1,8	1,8	1,8	1,9	1,9	1,9	1,9	2,2	2,2	2,2	2,3	2,4	2,4	2,5	2,5	2,5	2,5

Średnice otworu rdzeniowego dla gwintów wkrętów samogwintujących ST3,5										Średnice otworu rdzeniowego dla gwintów wkrętów samogwintujących ST3,9									
Grubość blachy ²	Wytrzymałość materiału na rozciąganie R_m wyrażona w N/mm ²									Grubość blachy ²	Wytrzymałość materiału na rozciąganie R_m wyrażona w N/mm ²								
	100	150	200	250	300	350	400	450	500		100	150	200	250	300	350	400	450	500
1,3	2,6	2,6	2,6	2,6	2,6	2,6	2,7	2,7	2,8	1,3	2,9	2,9	2,9	2,9	2,9	2,9	3,0	3,0	3,1
1,4	2,7	2,7	2,7	2,7	2,7	2,7	2,7	2,8	2,8	1,4	2,9	2,9	2,9	2,9	2,9	3,0	3,1	3,1	3,1
1,5	2,7	2,7	2,7	2,7	2,7	2,7	2,8	2,8	2,9	1,5	3,0	3,0	3,0	3,0	3,0	3,1	3,1	3,1	3,2
1,6	2,7	2,7	2,7	2,7	2,7	2,7	2,8	2,9	2,9	1,6	3,0	3,0	3,0	3,0	3,1	3,1	3,2	3,2	3,2
1,7	2,7	2,7	2,7	2,7	2,7	2,8	2,8	2,9	2,9	1,7	3,0	3,0	3,0	3,0	3,1	3,1	3,2	3,2	3,3
1,8	2,7	2,7	2,7	2,7	2,8	2,8	2,9	2,9	2,9	1,8	3,0	3,0	3,0	3,0	3,1	3,2	3,2	3,3	3,3
1,9	2,7	2,7	2,7	2,7	2,8	2,9	2,9	2,9	3,0	1,9	3,0	3,0	3,0	3,1	3,2	3,2	3,3	3,3	3,3
2,0	2,7	2,7	2,7	2,8	2,9	2,9	2,9	3,0	3,0	2,0	3,0	3,0	3,0	3,1	3,2	3,2	3,3	3,3	3,3
2,2	2,7	2,7	2,8	2,8	2,9	3,0	3,0	3,0	3,0	2,2	3,0	3,0	3,1	3,2	3,2	3,3	3,3	3,3	3,4
2,5	2,7	2,7	2,9	2,9	3,0	3,0	3,1	3,1	3,1	2,5	3,0	3,0	3,2	3,3	3,3	3,4	3,4	3,4	3,4
2,8	2,7	2,8	2,9	3,0	3,0	3,0	3,1	3,1	3,1	2,8	3,0	3,2	3,3	3,3	3,4	3,4	3,4	3,4	3,4
										3,0	3,0	3,2	3,3	3,3	3,4	3,4	3,4	3,4	3,5

Średnice otworu rdzeniowego dla gwintów wkrętów samogwintujących ST4,2										Średnice otworu rdzeniowego dla gwintów wkrętów samogwintujących ST4,8									
Grubość blachy ²	Wytrzymałość materiału na rozciąganie R_m wyrażona w N/mm ²									Grubość blachy ²	Wytrzymałość materiału na rozciąganie R_m wyrażona w N/mm ²								
	100	150	200	250	300	350	400	450	500		100	150	200	250	300	350	400	450	500
1,4	3,1	3,1	3,1	3,1	3,1	3,1	3,2	3,3	3,4	1,6	3,6	3,6	3,6	3,6	3,6	3,7	3,8	3,9	3,9
1,5	3,2	3,2	3,2	3,2	3,2	3,2	3,2	3,3	3,4	1,7	3,6	3,6	3,6	3,6	3,7	3,8	3,9	3,9	4,0
1,6	3,2	3,2	3,2	3,2	3,2	3,2	3,3	3,4	3,4	1,8	3,6	3,6	3,6	3,6	3,8	3,8	3,9	4,0	4,0
1,7	3,2	3,2	3,2	3,2	3,2	3,3	3,3	3,4	3,4	1,9	3,6	3,6	3,6	3,7	3,8	3,9	3,9	4,0	4,0
1,8	3,2	3,2	3,2	3,2	3,3	3,3	3,4	3,4	3,5	2,0	3,6	3,6	3,6	3,8	3,9	3,9	4,0	4,0	4,1
1,9	3,2	3,2	3,2	3,2	3,3	3,4	3,4	3,4	3,5	2,2	3,6	3,6	3,7	3,9	3,9	4,0	4,0	4,1	4,1
2,0	3,2	3,2	3,2	3,3	3,4	3,4	3,5	3,5	3,5	2,5	3,6	3,7	3,9	4,0	4,0	4,1	4,1	4,1	4,2
2,2	3,2	3,2	3,2	3,3	3,4	3,5	3,5	3,5	3,6	2,8	3,6	3,8	4,0	4,0	4,1	4,1	4,2	4,2	4,2
2,5	3,2	3,2	3,4	3,4	3,5	3,5	3,6	3,6	3,6	3,0	3,7	3,9	4,0	4,1	4,1	4,2	4,2	4,2	4,2
2,8	3,2	3,3	3,4	3,5	3,6	3,6	3,6	3,6	3,6	3,5	3,8	4,0	4,1	4,2	4,2	4,2	4,2	4,2	4,3
3,0	3,2	3,4	3,5	3,5	3,6	3,6	3,6	3,6	3,7	4,0	4,0	4,1	4,2	4,2	4,2	4,2	4,3	4,3	4,3
3,5	3,3	3,5	3,6	3,6	3,6	3,7	3,7	3,7	3,7										

Średnice otworu rdzeniowego dla gwintów wkrętów samogwintujących ST5,5										Średnice otworu rdzeniowego dla gwintów wkrętów samogwintujących ST6,3									
Grubość blachy ²	Wytrzymałość materiału na rozciąganie R _m wyrażona w N/mm ²									Grubość blachy ²	Wytrzymałość materiału na rozciąganie R _m wyrażona w N/mm ²								
	100	150	200	250	300	350	400	450	500		100	150	200	250	300	350	400	450	500
1,8	4,2	4,2	4,2	4,2	4,3	4,4	4,5	4,6	4,6	1,8	4,9	4,9	4,9	4,9	5,0	5,2	5,3	5,3	5,4
1,9	4,2	4,2	4,2	4,2	4,4	4,5	4,6	4,6	4,7	1,9	4,9	4,9	4,9	5,0	5,1	5,2	5,3	5,4	5,4
2,0	4,2	4,2	4,2	4,3	4,4	4,5	4,6	4,6	4,7	2,0	4,9	4,9	4,9	5,1	5,2	5,3	5,4	5,4	5,5
2,2	4,2	4,2	4,3	4,4	4,5	4,6	4,7	4,7	4,8	2,2	4,9	4,9	5,0	5,2	5,3	5,4	5,5	5,5	5,6
2,5	4,2	4,2	4,4	4,6	4,7	4,7	4,8	4,8	4,8	2,5	4,9	5,0	5,2	5,4	5,4	5,5	5,6	5,6	5,6
2,8	4,2	4,4	4,6	4,7	4,7	4,8	4,8	4,8	4,9	2,8	4,9	5,2	5,3	5,5	5,5	5,6	5,6	5,7	5,7
3,0	4,2	4,5	4,6	4,7	4,8	4,8	4,8	4,9	4,9	3,0	4,9	5,3	5,4	5,5	5,6	5,6	5,7	5,7	5,7
3,5	4,4	4,6	4,7	4,8	4,8	4,9	4,9	4,9	4,9	3,5	5,2	5,4	5,5	5,6	5,7	5,7	5,7	5,7	5,8
4,0	4,6	4,7	4,8	4,9	4,9	4,9	4,9	4,9	5,0	4,0	5,3	5,5	5,6	5,7	5,7	5,7	5,8	5,8	5,8
4,5	4,7	4,8	4,9	4,9	4,9	4,9	5,0	5,0	5,0	4,5	5,5	5,6	5,7	5,7	5,8	5,8	5,8	5,8	5,8
										5,0	5,5	5,7	5,7	5,8	5,8	5,8	5,8	5,8	5,8

Średnice otworu rdzeniowego dla gwintów wkrętów samogwintujących ST8									
Grubość blachy ²	Wytrzymałość materiału na rozciąganie R _m wyrażona w N/mm ²								
	100	150	200	250	300	350	400	450	500
2,1	6,3	6,3	6,3	6,3	6,5	6,6	6,7	6,8	6,9
2,2	6,3	6,3	6,3	6,5	6,6	6,8	6,8	6,9	7,0
2,5	6,3	6,3	6,5	6,7	6,8	6,9	7,0	7,0	7,1
2,8	6,3	6,4	6,7	6,8	6,9	7,0	7,1	7,1	7,2
3,0	6,3	6,5	6,8	6,9	7,0	7,1	7,1	7,2	7,2
3,5	6,4	6,8	7,0	7,1	7,1	7,2	7,2	7,3	7,3
4,0	6,7	6,9	7,1	7,2	7,2	7,3	7,3	7,3	7,3
4,5	6,8	7,1	7,2	7,2	7,3	7,3	7,3	7,3	7,4
5,0	7,0	7,1	7,2	7,3	7,3	7,3	7,4	7,4	7,4
5,5	7,1	7,2	7,3	7,3	7,3	7,4	7,4	7,4	7,4
6,0	7,1	7,2	7,3	7,3	7,4	7,4	7,4	7,4	7,4
6,5	7,2	7,3	7,3	7,4	7,4	7,4	7,4	7,4	7,4

¹ Podane wartości średnic otworu rdzeniowego obowiązują dla zwykłych połączeń na wkręt samogwintujący z otworem przejściowym w górnym arkuszu i otworem wierconym w arkuszu dolnym oraz dla wkrętów samogwintujących bez warstwy powlekającej.

² Minimalna grubość blachy została dobrana tak, aby moment dokręcania nie przekraczał 50 % minimalnego momentu zrywającego zgodnie z ISO 2702. Ta górna granica to około 0,8 średnicy znamionowej wkrętu, np. wkręt ST4,2 może być stosowany do blachy nie grubszej niż 0,8 x 4,2 = 3,5 mm.

Wskazówki dotyczące średnic otworów przejściowych:

Minimalną średnicę otworu przejściowego można obliczyć stosując wzór:

$$d_D = d_1 + 1/3(d_1 - d_b) \text{ mm}$$

gdzie: d_D = średnica otworu przejściowego
 d_1 = średnica nominalna gwintu wkrętu samogwintującego
 d_b = średnica otworu rdzeniowego

Przykład:

Minimalna średnica otworu przejściowego dla wkrętu samogwintującego z gwintem ST6,3, grubości materiału 4mm i wytrzymałości na rozciąganie 350 N/mm², wynosi $d_D = 6,3 + 1/3(6,3 - 5,7) = 6,5$ mm

4.2 Otwory rdzeniowe dla wkrętów samogwintujących w metalu (Taptite 2000®)

4.2.1 Zalecenia dla otworów wierconych i wycinanych w materiałach o zakresie twardości do 150 HB, 500 N/mm²

Średnice otworów rdzeniowych (strefa preferowana zaznaczona kolorem) w poniższej tabeli zostały określone w drodze eksperymentu przez producentów i użytkowników, zależnie od rodzaju materiału, jego grubości oraz głębokości wkręcania. Podane wartości służą jedynie konsultacji.

Procesy wytwórcze (np. wybijanie), które powodują utwardzanie zgniotowe ściany otworu rdzeniowego, wymagają zastosowania nieco większej średnicy. To samo może dotyczyć otworów odlewanych (twardsze nadlewy).

Zalecana klasa tolerancji dla otworów rdzeniowych: H11.

Szczególnie dla potrzeb produkcji masowej zaleca się wykonanie testów celem uzyskania optymalnego wyniku w odniesieniu do kombinacji właściwości mechanicznych wkrętu, głębokości wkręcania oraz właściwości mechanicznych materiału, w którym wkręty mają być mocowane. Zaleca się rozpoczęcie testowania od najmniejszej proponowanej średnicy.

d	M2.5	M3	M3.5	M4	M5	M6	M8	d
Grubość materiału lub głębokość wkręcania	Średnica otworu D _h [mm]							Grubość materiału lub głębokość wkręcania
0,8								0,8
0,9								0,9
1	2,20							1
1,2		2,65	3,15	3,60				1,2
1,5	2,20							1,5
1,6								1,6
1,7	to							1,7
1,8	2,25							1,8
2					4,45 to 4,50			2
2,2		2,65 to 2,70	3,15 to 3,20			5,25 to 5,30		2,2
2,5	2,25 to 2,30			3,60 to 3,70				2,5
3						5,30 to 5,40	7,10 to 7,20	3
3,2								3,2
3,5								3,5
4	2,25 to 2,30				4,50 to 4,55			4
5		2,70 to 2,75	3,20 to 3,25			5,40 to 5,45	7,20 to 7,30	5
5,5								5,5
6								6
6,5				3,65 to 3,70				6,5
7					4,55 to 4,65		7,30 to 7,35	7
7,5						5,45 to 5,65		7,5
8								8
10								10
12								12
>12-16							7,35 to 7,45	>12-16
>16-20								>16-20

Wskazówki wymiarowania głębokości wkręcania.

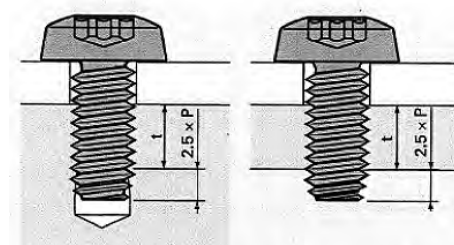

Wartości zalecane dla głębokości wkręcania

- Stal = 1,5 x d
- Aluminium = 2 x d
- Cynk = 2 x d
- Magnez = 2,5 x d

Ważna uwaga:

Długość gwintu nośnego jest skrócona o długość końcówki wkrętu.

Dla odlewów, np. stożkowych, informacje dotyczące otworów nieprzelotowych i przelotowych dostępne są na życzenie.

4.3 Otwory rdzeniowe dla wkrętów samogwintujących do tworzyw sztucznych (Remform®)

4.3.1 Zalecenia dla geometrii otworów i nadlewów wkrętów Remform

Geometria nadlewu powinna zasadniczo zgadzać się z poniższym rysunkiem.

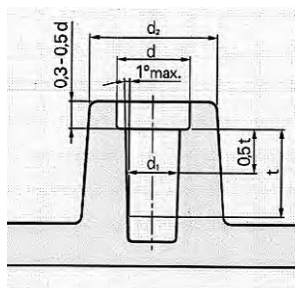

- d średnica znamionowa wkrętu
- d_1 średnica otworu
- d_2 średnica zewnętrzna tulei
- t głębokość wkręcania

Poniższe wielkości średnic otworów rdzeniowych opierają się na rzeczywistych testach, przeprowadzonych z użyciem różnych typów tworzywa. Wartości te podawane są głównie w celach informacyjnych. W produkcji masowej, jednakże, zaleca się przeprowadzanie własnych testów w celu uzyskania optymalnego efektu w odniesieniu do właściwości mechanicznych (np. temperatura, obciążenie, czas, prędkość). Głębokość wkręcenia utrzymywana jest na poziomie minimalnym i w miarę możliwości nie jest niższa od poniższych wartości.

Wielkość wkrętu $\varnothing d$	miękki															twardy		
	Geometria tulei	PP	PE-LD/HD	PS	PA6/PA6.6	PBT	PET	ASA/SAN	ABS	POM	ABS/PC	PA6-GF3-	PMMA	PC*	PPE*	PC-GF30*	PBT-GF30*	PET-GF30*
$\varnothing 2,0$	d_1	1,45	1,45	1,45	1,45	1,5	1,5	1,5	1,5	1,5	1,6	1,6	1,6	1,6	1,7	1,7	1,7	1,7
	d_2	4,4	4,4	4,4	4,4	4,2	4,2	4,2	4,2	4,2	4,0	4,0	4,0	4,4	4,4	4,4	3,8	3,8
	t	5,0	5,0	5,0	5,0	5,0	5,0	4,5	4,5	4,5	4,5	4,5	4,5	4,0	4,0	4,0	4,0	4,0
$\varnothing 2,2$	d_1	1,6	1,6	1,6	1,6	1,7	1,7	1,7	1,7	1,7	1,8	1,8	1,8	1,8	1,9	1,9	1,9	1,9
	d_2	4,9	4,9	4,9	4,9	4,7	4,7	4,7	4,7	4,7	4,4	4,4	4,4	4,9	4,9	4,9	4,2	4,2
	t	5,5	5,5	5,5	5,5	5,5	5,5	5,0	5,0	5,0	5,0	5,0	5,0	4,5	4,5	4,5	4,5	4,5
$\varnothing 2,5$	d_1	1,8	1,8	1,8	1,8	1,9	1,9	1,9	1,9	1,9	2,0	2,0	2,0	2,0	2,1	2,1	2,1	2,1
	d_2	5,5	5,5	5,5	5,5	5,3	5,3	5,3	5,3	5,3	5,0	5,0	5,5	5,5	5,5	5,8	4,8	4,8
	t	6,0	6,0	6,0	6,0	6,0	6,0	5,5	5,5	5,5	5,5	5,5	5,5	5,0	5,0	5,0	5,0	5,0
$\varnothing 3,0$	d_1	2,25	2,25	2,25	2,25	2,3	2,3	2,3	2,3	2,3	2,4	2,4	2,4	2,4	2,6	2,6	2,6	2,6
	d_2	6,6	6,6	6,6	6,6	6,3	6,3	6,3	6,3	6,3	6,0	6,0	6,0	6,6	6,6	6,6	5,7	5,7
	t	7,0	7,0	7,0	7,0	7,0	7,0	6,5	6,5	6,5	6,5	6,5	6,5	6,0	6,0	6,0	6,0	6,0
$\varnothing 3,5$	d_1	2,6	2,6	2,6	2,6	2,7	2,7	2,7	2,7	2,7	2,8	2,8	2,8	2,8	3,0	3,0	3,0	3,0
	d_2	7,8	7,8	7,8	7,8	7,4	7,4	7,4	7,4	7,4	7,0	7,0	7,0	7,8	7,8	7,8	6,7	6,7
	t	8,0	8,0	8,0	8,0	8,0	8,0	7,5	7,5	7,5	7,5	7,5	7,5	7,0	7,0	7,0	7,0	7,0
$\varnothing 4,0$	d_1	2,9	2,9	2,9	2,9	3,0	3,0	3,0	3,0	3,0	3,2	3,2	3,2	3,2	3,4	3,4	3,4	3,4
	d_2	9,0	9,0	9,0	9,0	8,5	8,5	8,5	8,5	8,5	8,0	8,0	8,0	9,0	9,0	9,0	7,5	7,5
	t	9,0	9,0	9,0	9,0	9,0	9,0	8,5	8,5	8,5	8,5	8,5	8,5	8,0	8,0	8,0	8,0	8,0
$\varnothing 5,0$	d_1	3,7	3,7	3,7	3,7	3,8	3,8	3,8	3,8	3,8	4,0	4,0	4,0	4,0	4,2	4,2	4,2	4,2
	d_2	11,0	11,0	11,0	11,0	10,5	10,5	10,5	10,5	10,5	10,0	10,0	10,0	11,0	11,0	11,0	9,5	9,5
	t	11,0	11,0	11,0	11,0	11,0	11,0	10,5	10,5	10,5	10,5	10,5	10,5	10,0	10,0	10,0	10,0	10,0
$\varnothing 6,0$	d_1	4,3	4,3	4,3	4,3	4,5	4,5	4,5	4,5	4,5	4,8	4,8	4,8	4,8	5,1	5,1	5,1	5,1
	d_2	13,5	13,5	13,5	13,5	12,5	12,5	12,5	12,5	12,5	12,0	12,0	12,0	13,5	13,5	13,5	11,5	11,5
	t	13,5	13,5	13,5	13,5	13,5	13,5	13,0	13,0	13,0	13,0	13,0	13,0	12,0	12,0	12,0	12,0	12,0
$\varnothing 8,0$	d_1	5,7	5,7	5,7	5,7	6,0	6,0	6,0	6,0	6,0	6,4	6,4	6,4	6,4	6,8	6,8	6,8	6,8
	d_2	17,5	17,5	17,5	17,5	16,5	16,5	16,5	16,5	16,5	16,0	16,0	16,0	17,5	17,5	17,5	15,5	15,5
	t	18,0	18,0	18,0	18,0	18,0	18,0	17,0	17,0	17,0	17,0	17,0	17,0	16,0	16,0	16,0	16,0	16,0

Wymiary w mm, tolerancja wg DIN 16901

*Tworzywa podatne na pękanie naprężeniowe

4.4 Długość części wystającej śruby (l_p)

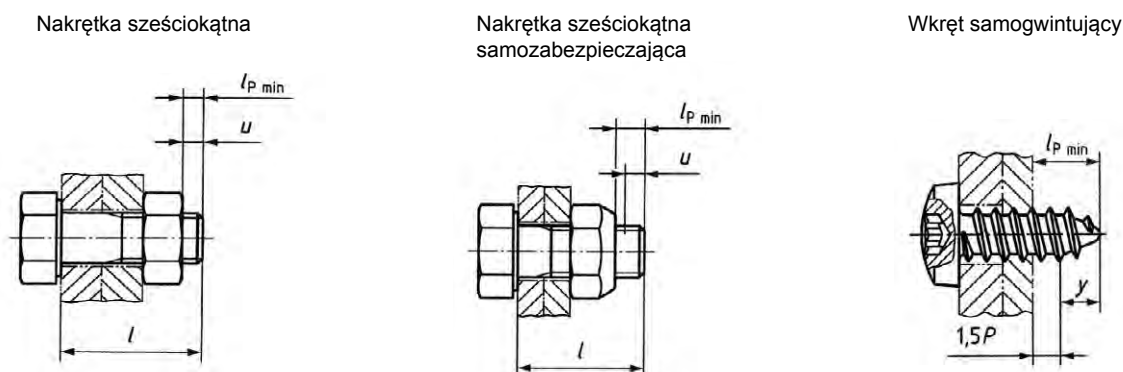

Długość wystającej części śruby (l_p) bazuje na DIN 78 (2013).

Dla nakrętek sześciokątnych: $l_{p \min} = 2P + (ISO 4753(2011): u \geq 2P)$.

Dla nakrętek sześciokątnych samozabezpieczających: $l_{p \min} = 3P + (ISO 4753(2011): u \geq 2P)$.

Znamionowa długość śrub L jest obliczana jako długość mocowania plus całkowita wysokość nakrętki oraz minimalna końcówka śruby $l_{p \min}$. Tak obliczone wartości muszą być zaokrąglone do najbliższej (dłuższej) długości znamionowej. Długość części wystającej dla nakrętek sześciokątnych rowkowych – patrz DIN 34803.

y według DIN-EN-ISO 1478 (1999)

y	Typ	ST2,2	ST2,9	ST3,5	ST3,9	ST4,2	ST4,8	ST5,5	ST6,3
	C	2,0	2,3	3,2	3,5	3,7	4,3	5,0	6,0
	F	1,6	1,8	2,5	2,7	2,8	3,2	3,6	3,6
R	--	--	2,7	3,0	3,2	3,6	4,3	5,0	

4.5 Rozmiary wiertel dla wkrętów samogwintujących

4.5.1 Uwagi ogólne

Podane rozmiary wiertel są wartościami zalecanymi dla średnic otworów nawierczanych pod wkręty samogwintujące. Nie wolno przekraczać granic tolerancji dla gwintu. Zależnie od materiału, narzędzi i technologii produkcji, niezbędne może być odstępianie od tych wartości zalecanych i ustalenie faktycznego rozmiaru wiertła eksperymentalnie.

Dla gwintów metrycznych i zunifikowanych (profil ISO) zasadniczo stosuje się następujący wzór: rozmiar wiertła = znamionowy rozmiar gwintu – skok, w razie potrzeby zaokrąglony.

4.5.2 Rozmiary wiertel – metryczny (ISO) gwint grubzwojny – M

W oparciu o ISO 2306 (1972). Wymiary w mm.

Rozmiar gwintu	Rozmiar wiertła
M1	0,75
M1,1	0,85
M1,2	0,95
M1,4	1,1
M1,6	1,25
M1,8	1,45
M2	1,6

Rozmiar gwintu	Rozmiar wiertła
M2,2	1,75
M2,5	2,05
M3	2,5
M3,5	2,9
M4	3,3
M4,5	3,7
M5	4,2

Rozmiar gwintu	Rozmiar wiertła
M6	5
M7	6
M8	6,8
M9	7,8
M10	8,5
M11	9,5
M12	10,2

Rozmiar gwintu	Rozmiar wiertła
M14	12
M16	14
M18	15,5
M20	17,5
M22	19,5
M24	21
M27	24

Rozmiar gwintu	Rozmiar wiertła
M30	26,5
M33	29,5
M36	32
M39	35
M42	37,5
M45	40,5
M48	43

Rozmiar gwintu	Rozmiar wiertła
M52	47
M56	50,5
M60	54,5
M64	58
M68	62

4.5.3 Rozmiary wiertel – metryczny (ISO) gwint drobnozwojny – MF

W oparciu o ISO 2306 (1972). Wymiary w mm.

Rozmiar gwintu	Rozmiar wiertła
M3 x 0,35	2,65
M3,5 x 0,35	3,15
M4 x 0,5	3,5
M4,5 x 0,5	4

Rozmiar gwintu	Rozmiar wiertła
M5 x 0,5	4,5
M6 x 0,75	5,2
M8 x 1	7
M10 x 1	9

Rozmiar gwintu	Rozmiar wiertła
M10 x 1,25	8,8
M12 x 1	11
M12 x 1,25	10,8
M12 x 1,5	10,5

Rozmiar gwintu	Rozmiar wiertła
M14 x 1,5	12,5
M16 x 1,5	14,5
M18 x 1,5	16,5
M18 x 2	16

Rozmiar gwintu	Rozmiar wiertła
M20 x 1,5	18,5
M20 x 2	18
M22 x 1,5	20,5
M22 x 2	20

Rozmiar gwintu	Rozmiar wiertła
M24 x 1,5	22,5
M24 x 2	22
M27 x 1,5	25,5
M27 x 2	25

4.5.4 Rozmiary wiertel do gwintów rurowych równoległych Whitwortha – G

W oparciu o ISO 2306 (1972). Wymiary w mm.

Rozmiar gwintu x ilość zwojów/cal	Rozmiar wiertła
G $\frac{1}{8}$ x 28	8,8
G $\frac{1}{4}$ x 19	11,8
G $\frac{3}{8}$ x 19	15,25
G $\frac{1}{2}$ x 14	19

Rozmiar gwintu x ilość zwojów/cal	Rozmiar wiertła
G $\frac{5}{8}$ x 14	21
G $\frac{3}{4}$ x 14	24,5
G $\frac{7}{8}$ x 14	28,25
G1 x 11	30,75

Rozmiar gwintu x ilość zwojów/cal	Rozmiar wiertła
G 1 $\frac{1}{8}$ x 11	35,3
G 1 $\frac{1}{4}$ x 11	39,5
G 1 $\frac{1}{2}$ x 11	45
G 1 $\frac{3}{4}$ x 11	51

4.6 Wymiary pod klucz zgodnie z ISO

Wymiary pod klucz niektórych nakrętek i śrub sześciokątnych wg ISO uległy zmianie w porównaniu ze starymi normami DIN. Dotyczy to jedynie elementów złącznych o średnicy gwintu M10, M12, M14 oraz M22.

Zestawienie wymiarów pod klucz wg DIN oraz ISO podaje poniższa tabela bazująca na ISO 272 (1982).

Wymiary w mm.

Średnica znamionowa	M10	M12	M14	M22
Wymiar pod klucz wg DIN	17	19	22	32
Wymiar pod klucz wg ISO 272	16	18	21	34

5 Powłoki powierzchniowe dla elementów złącznych

5.1 Wprowadzenie

Według normy DIN 50900-1, korozja metalu to reakcja tego materiału z jego środowiskiem prowadząca do wymiernej zmiany metalu i mogąca doprowadzić do obniżonej sprawności komponentu metalowego lub całego systemu.

Istnieje kilka rodzajów korozji. Niektóre rodzaje korozji występują bez mechanicznego obciążenia produktu: korozja powierzchniowa, korozja wżerowa, korozja szczelinowa, korozja elektrochemiczna, korozja chemiczna. Inne rodzaje korozji inicjowane są w połączeniu z obciążeniem mechanicznym: pęknięcie korozyjne naprężeniowe, nadżerki korozyjne.

Odporność powłoki na korozję często bywa wyrażana liczbą godzin do wystąpienia rdzy białej (korozja cynkowa) lub rdzy czerwonej (korozja metalem pospolitym) w próbie mgłą solną zgodnie z ISO 9227. Próba mgłą solną jest metodą sprawdzania czy zachowana jest porównywalna jakość ochrony antykorozyjnej. Tym niemniej rzadko występuje bezpośredni związek między odpornością na działanie mgły solnej a odpornością na inne środki, ponieważ kilka czynników wpływających na rozwój korozji różni się znacznie zależnie od danych warunków. Zatem działanie różnych powłok podczas takiej próby korozyjnej nie powinno być przyjmowane jako bezpośredni wskaźnik odporności na korozję w warunkach użytkowania. Można podjąć kilka środków celem zapobiegania lub opóźnienia korozji elementów złącznych. Należą do nich: właściwa konstrukcja elementu złącznego, właściwy dobór materiałów, zastosowanie odpowiedniej powłoki ochronnej.

W sekcji tabelarycznej niniejszej instrukcji można znaleźć tabelę Korozji Stykowej oraz tabelę Korozji Chemicznej, które mogą być źródłem pierwszej pomocy w ustaleniu materiału dopuszczalnego dla danego rodzaju środowiska korozyjnego.

Niniejszy rozdział obejmuje jedynie powłoki powierzchniowe odpowiednie dla elementów złącznych.

5.1.1 Przegląd systemów powlekania

Powłoki dzielą się na metaliczne i niemetaliczne.

Powłoki metaliczne (nieorganiczne):

- Powlekanie elektrolityczne (wg ISO 4042) takie jak cynk, cynk-żelazo, nikiel, ...
- Chemiczne powlekanie metali (bezprądowe): niklowanie chemiczne
- Cynkowanie na gorąco (ISO 10684): grube powlekanie cynkiem poprzez zanurzenie w roztopionym cynku
- Powlekanie dyfuzyjne: proszek metaliczny nakładany w wysokiej temperaturze (szerardyzacja, chromianowanie)
- Powlekanie mechaniczne (ISO 12683): mechaniczne nakładanie sproszkowanego cynku
- Powlekanie dyspersyjne (ISO 10683): nakładanie płatków cynku w roztworze dyspersyjnym

Powłoki niemetaliczne:

- Olej: zazwyczaj stosowany na zwykłych elementach złącznych dla zmniejszenia ryzyka korozji podczas składowania
- Oksydowanie: to nie jest prawdziwa powłoka a raczej zamiana powierzchni stalowej na tlenek żelaza poprzez zanurzenie w gorącym roztworze alkalicznym
- Fosfatacja (ISO 3892): nakładana chemicznie powłoka cynku z fosoranu manganu, zazwyczaj łączona z olejem dla uzyskania pewnej ochrony antykorozyjnej
- Pasywacja chromianowa (EN12329): dodatkowe powlekanie np. na cynku celem dalszego ulepszenia jego odporności na korozję
- Cienkie powłoki lakierowe: kilka powłok takich jak PTFE, Teflon, KTL

Na elementach złącznych najczęściej stosuje się powłoki „aktywne”. Powłoki takie (np. cynk) zapewniają ochronę „katodową”, co znaczy że powłokę poświęca się w zamian za ochronę metalu. Zaletą powłok aktywnych jest to, że nawet przy niewielkich uszkodzeniach, opóźnią one poważną korozję metalu pospolitego. Powłoki „pasywne” to te, które odizolowują materiał od środowiska, np. Teflon. Powłoki takiego rodzaju mają tę wadę, że w przypadku ich naruszenia korozja rozwinię się gwałtownie. Czasami stosuje się kombinację powłok, zwaną często „powlekaniami dupleksowymi”.

5.1.2 Grubości graniczne powłok

Poziom ochrony antykorozyjnej jest na ogół proporcjonalny do grubości zastosowanej powłoki. Dla elementów złącznych gwintowanych maksymalna grubość powłoki, jaka może być zastosowana zależy od tolerancji między maksymalnym rozmiarem gwintu zewnętrznego, a minimalnym rozmiarem gwintu wewnętrznego. Aby zapobiec zakleszczaniu się nakrętki/śruby podczas montażu, maksymalna znamionowa grubość powłoki nie powinna przekraczać ¼ tej tolerancji.

Poniższa tabela (według ISO 4042) określa tolerancję i maksymalną grubość warstwy dla każdego skoku. Większość powłok ma grubość, która może się różnić zależnie od położenia elementu złącznego. Dla powłok nakładanych elektrolizacyjnie norma ISO 4042 określa związek między stosunkiem długości/średnicy a maksymalną grubością powłoki.

Gwint zewnętrzny						
Skok P	Znamionowa średnica gwintu d ¹	Tolerancja podstawowa	Pozycja tolerancji g			
			Maksymalna nominalna grubość warstwy			
			2 Wszystkie długości znamionowe	3 Długość znamionowa L		
				L≤5d	5d<L≤10d	10d<L≤15d
mm	µm	µm	µm	µm	µm	
0,2		-17	3	3	3	3
0,25	1; 1,2	-18	3	3	3	3
0,3	1,4	-18	3	3	3	3
0,35	1,6 (1,8)	-19	3	3	3	3
0,4	2	-19	3	3	3	3
0,45	2,5 (2,2)	-20	5	5	3	3
0,5	3	-20	5	5	3	3
0,6	3,5	-21	5	5	3	3
0,7	4	-22	5	5	3	3
0,75	4,5	-22	5	5	3	3
0,8	5	-24	5	5	3	3
1	6 (7)	-26	5	5	3	3
1,25	8	-28	5	5	5	3
1,5	10	-32	8	8	5	5
1,75	12	-34	8	8	5	5
2	16 (14)	-38	8	8	5	5
2,5	20 (18; 22)	-42	10	10	8	8
3	24 (27)	-48	12	12	8	8
3,5	30 (33)	-53	12	12	10	8
4	36 (30)	-60	15	15	12	10
4,5	42 (45)	-63	15	15	12	10
5	48 (52)	-71	15	15	12	10
5,5	56 (60)	-75	15	15	15	12
6	64	-80	20	20	15	12

¹ Informacja dotycząca gwintów gruboziarnych podana jest tylko dla wygody. Skok jest normatywny.
² Maksymalne znamionowe grubości warstwy dla pomiaru miejscowego.
³ Maksymalne znamionowe grubości warstwy w przypadku gdy uzgodniono pomiar w oparciu o średnią grubość warstwy danej partii zgodnie z metodą opisaną w ISO 4042, załącznik B.

5.1.3 Kruchość wodorowa

Gdy wodór atomowy łączy się ze stalą, może dojść do katastrofalnego pęknięcia kruchego przy naprężeniach wyraźnie poniżej poziomu granicy plastyczności. Zjawisko to często jest nazywane opóźnionym pękaniem kruchym wywołanym wodorem lub kruchością wodorową. Charakterystyczną rzeczą jest to, że defekt spowodowany kruchością wodorową pojawia się po kilku godzinach lub dniach od montażu. Wodór można wprowadzić podczas kilku procedur takich jak czyszczenie, trawienie, elektrolizacja, ale także w środowisku użytkowym w wyniku reakcji ochrony katodowej lub reakcji korozyjnych.

Występowanie kruchości wodorowej jest najbardziej prawdopodobne w poniższych produktach:

- O wytrzymałości na rozciąganie ≥ 1000 N/mm²
- O twardości ≥ 320 HV
- Utwardzanych powierzchniowo.

Celem obniżenia ryzyka defektu spowodowanego kruchością wodorową, elementy podatne winny być wygrzewane w ciągu 4 godzin od elektrolizacji oraz przed pasywacją do zakresu temperatury 200°C do 230°C. Tym niemniej nie można zagwarantować, że po takim wygrzewaniu elementy będą wolne od kruchości. Szczególnie w przypadku śrub o wysokiej wytrzymałości na rozciąganie, takich jak klasa 12.9, zdecydowanie zaleca się, by nie stosować powłok niosących ryzyko kruchości wodorowej (np. galwanizacja). Powłoki standardowe o na ogół niskim zagrożeniu kruchością wodorową: lamelowanie (płatki) cynkowe, galwanizacja na gorąco.

5.1.4 Dyrektywy unijne RoHS i ELV

RoHS lub RoHS II: Ograniczenia Użycia Substancji Niebezpiecznych (Dyrektywa Europejska 2011/65/EU).
 ELV: Pojazdy Wycofane z Eksploatacji (Dyrektywa Europejska 2000/53/EC).
 Obie dyrektywy ograniczają użycie ołowiu (Pb), rtęci (Hg), kadmu (Cd) i chromu sześciowartościowego (Cr⁶⁺).
 RoHS II ogranicza też stosowanie bifenyli polibromowanych (PBB), polibromowanych eterów difenylowych (PBDF). RoHS stosuje się do sprzętu elektrycznego i elektronicznego, natomiast ELV dotyczy samochodów osobowych.

Dla powłok elementów złącznych szczególnie ważne jest ograniczenie dotyczące Cr⁶⁺ ponieważ popularne warstwy pasywacyjne takie jak pasywacja żółta i czarna, ale także powłoka Dacromet zawierają niedopuszczalny poziom tej substancji. Oczekuje się, że w najbliższej przyszłości powłoki Cr⁶⁺ zostaną w Europie zakazane.

Jeśli chodzi o elementy standardowe, Fabory dysponuje szerokim asortymentem elementów złącznych powlekanych, wolnych od Cr⁶⁺, głównie:

- Cynkowane elektrogalwanicznie, z pasywacją białą (Cr³⁺)
- Powłoki płatkowe fZn/nc/L/600h

Na życzenie wiele innych powłok wolnych od Cr⁶⁺.



Należy ostrożnie podchodzić do stosowania ołowiu (Pb) w niektórych rodzajach stali i mosiądzu, w zależności od tego, czy zwolnienia udzielone w legislacji RoHS będą kontynuowane po ich wygaśnięciu w połowie 2016.

5.2 Powlekanie galwaniczne

Powłoka galwaniczna stanowi warstwę metaliczną, która tworzy się na powierzchni elementów metalowych poprzez zanurzenie ich w roztworze zawierającym elektrolit, poprzez który przepływa prąd elektryczny. Wymagania dla powłok galwanicznych na elementach złącznych określa ISO 4042:1999. Ta edycja normy ISO nie bierze pod uwagę ograniczeń stosowanych przez różne ustawy unijne. Przygotowywana jest nowa edycja ISO 4042, która określi też powłoki galwaniczne wolne od substancji niebezpiecznych, jak zdefiniowano np. w RoHS.

Można stosować system kodowy celem określenia metalu powlekającego, jego grubości i warstwy pasywacyjnej.

Kod składa się z dwóch dużych liter z liczbą pomiędzy nimi.

- Litera kodowa dla metalu powlekającego
- Liczba kodowa dla minimalnej grubości warstwy
- Litera kodowa dla rodzaju pasywacji na powierzchni metalu powlekającego.

Litera kodowa dla metalu powlekającego:

Litera kodu	Metal powlekający	Symbol chemiczny
A	Cynk	Zn
B	Kadm	Cd
C	Miedź	Cu
D	Mosiądz	CuZn
E	Nikiel	Ni
F	Chromonikiel ¹	NiCr
G	Miedź – Nikiel	CuNi
H	Miedź – Nikiel – Chrom ¹	CuNiCr
J	Cyna	Sn
K	Miedź – Cyna	CuSn
L	Srebro	Ag
N	Miedź - Srebro	CuAg
P	Cynk - nikiel	ZnNi
Q	Cynk - kobalt	ZnCo
R	Cynk - żelazo	ZnFe

¹ Grubość warstwy chromu ≈ 0.3µm.

Liczba kodowa dla grubości powłoki:

Liczba kodowa	Minimalna grubość warstwy (struktura powłoki) w μm	
	1 metal powlekający	2 metale powlekające
0 ²	-	-
1	3	-
2	5	2+3
3	8	3+5
4	12	4+8
5	15	5+10
6	20	8+12
7 ³	25	10+15
8 ³	30	12+18

² Liczba kodowa 0 stosuje się do gwintów poniżej M1.6 gdzie nie można określić specyficznej grubości warstwy..

³ Nie dotyczy elementów gwintowanych.

Litera kodowa dla warstwy pasywacji chromianowej:

Litera kodowa	Stopień połysku	Barwa pasywacji chromianowej
A	Matowy	Żadna
B		Niebieskawa do niebieskawej opalizującej ¹
C		Żółtawa do żółtawo-brązowej, opalizująca
D		Oliwkowozielona do oliwkowobrązowej
E	Półpołysk	Żadna
F		Niebieskawa do niebieskawej opalizującej ¹
G		Żółtawa do żółtawo-brązowej, opalizująca
H		Oliwkowozielona do oliwkowobrązowej
J	Połysk	Żadna
K		Niebieskawa do niebieskawej opalizującej ¹
L		Żółtawa do żółtawo-brązowej, opalizująca
M		Oliwkowozielona do oliwkowobrązowej
N	Wysoki połysk	Żadna
P	Opcjonalny	Jak metody B, C lub D
R	Matowy	Brązowawo-czarna do czarnej
S	Półpołysk	
T	Połysk	

¹ dotyczy tylko do powłok cynkowych Zn

Przykład kodowania: A3L

“A” oznacza cynkowany

“3” oznacza grubość warstwy co najmniej 8 μm

“L” oznacza chromowanie z wykończeniem na “połysk”

Przykład oznaczenia: śruba z łbem sześciokątnym ISO 4014 – M16 x 60 – 8.8 – A3L.

W wyniku legislacji RoHS/ELV oraz wysokich wymagań stawianych przez przemysł samochodowy dla odporności na korozję powłok wolnych od Cr^{6+} , opracowano inne powłoki pasywacyjne oraz uszczelnienia, których jeszcze nie unormowano. Więcej informacji uzyskasz w Fabory.

5.3 Galwanizacja na gorąco

Galwanizacja na gorąco jest definiowana jako ochronna warstwa cynku położona na powierzchnię elementów stalowych poprzez ich zanurzenie w płynnym cynku. Elementy gwintowane na ogół wymagają odwirowania bezpośrednio po zanurzeniu. ISO 10684 (dawniej DIN 267-10) określa materiał, proces, wymagania wymiarowe i osiągi dla powłok galwanizowanych na gorąco zastosowanych dla elementów złącznych z gwintem grubozwojnym od M8 do M64. Ze względu na wysoką odporność na korozję w warunkach zewnętrznych, galwanizacja na gorąco jest najczęściej stosowanym systemem powlekania dla elementów złącznych w konstrukcjach stalowych i budownictwie.

Gwint wewnętrzny jest zazwyczaj nacinany po procesie galwanizacji na gorąco, a zatem normalnie nie jest powlekany. Po zamontowaniu gwint wewnętrzny jest chroniony przed korozją przez galwanizowany zanurzeniowo na gorąco gwint wewnętrzny odpowiadającej śruby.

Galwanizacja na gorąco elementów złącznych w klasie właściwości 10.9 wymaga zastosowania specjalnych procedur celem zapobiegania kruchości wodorowej i mikropęknięciom w śrubach \geq M27.

Grubość powłoki: minimum 40 μm .

Ze względu na grubość powłoki, która przewyższa normalną tolerancję między klasami tolerancji gwintu 6g i 6H, należy podjąć specjalne kroki:

1. System „gwintu nadwymiarowego”:
Gwint śrub standardowych o klasie tolerancji gwintu 6g poddanych galwanizacji na gorąco staje się gwintem „nadwymiarowym”. Śruby te muszą być stosowane łącznie z nakrętkami nagwintowanymi „nadwymiarowo” (około 0.3 mm większe) po galwanizacji. Zatem nie dają one zwyczajnego dopasowania gwintu. Takich śrub i nakrętek należy używać w zestawach. Takie połączenie jest zazwyczaj stosowane i jest zalecane.
2. System gwintu ISO:
W drugiej metodzie, zgodnej z ISO 10684, rozmiar gwintu po galwanizacji zanurzeniowej na gorąco odpowiada normie ISO 965-1 klasy 6h/6H. A zatem przed galwanizacją na gorąco gwint zewnętrzny musi być cieńszy niż normalna klasa tolerancji 6g (gwint niewymiarowy). Oznacza to, że po galwanizacji na gorąco śruby muszą spełniać wymogi pozycji tolerancji 6h. Takie galwanizowane na gorąco śruby metryczne ISO muszą być dopasowane z nakrętkami normalnie gwintowanymi po galwanizacji, a zatem muszą spełniać warunki tolerancji 6H. Metoda ta sprawdza się w zwykłym pasowaniu gwintów i może być zastosowana w stosunku do nakrętek lub w nagwintowanych otworach z gwintem metrycznym zgodnym z normą ISO.

Ważne uwagi:

- **Należy uważać, aby nie mieszać śrub i nakrętek w systemie „gwintu nadwymiarowego” z tymi w systemie „gwintu ISO”, gdyż w takim przypadku awaria złącza jest nieunikniona!**
- **Należy zwrócić uwagę na fakt, że obciążenia próbne nakrętek z gwintem nadwymiarowym oraz obciążenia próbne śrub i wkrętów z gwintem niewymiarowym mogą być obniżone w stosunku do wartości podanych odpowiednio w ISO 898-2 i ISO 898-1.**

5.4 Powłoki płatkowe

Powłoka płatkowa (według ISO 10683) jest nie-elektrolitycznie nakładaną powłoką wytwarzaną poprzez dyspersję płatków cynku na powierzchni elementu łącznego, z możliwym dodatkiem płatków aluminium. Odpowiedni środek tworzy wiązanie między płatkami a także między płatkami a stalą poprzez utwardzanie termiczne. Utworzona w ten sposób powłoka nieorganiczna przewodzi elektryczność i zapewnia ochronę katodową.

W porównaniu z większością powłok elektrocynkowych, cynkowanie płatkowe daje znacznie wyższą odporność antykorozyjną bez ryzyka wystąpienia kruchości wodorowej.

ISO 10683 definiuje powłoki płatkowe zarówno z jak i bez Cr^{6+} . Standardowy asortyment Fabory obejmuje lamelowanie cynkowe wolne od chromu. Jest to określone w normie ISO jako flZn/nc (fl = płatek, Zn = cynk, nc = bez chromu).

Odporność korozyjna powłok płatkowych (lamelarnych) przewyższa konwencjonalą elektrolizację cynkową przy porównywalnej grubości powłoki. Dla swego standardowego asortymentu Fabory wybrało odporność korozyjną 480 godzin dla mniejszych średnic gwintu oraz 600 godzin dla rozmiarów większych (>M8). Ta ostatnia jest określona w normie ISO jako flZn/nc/600h.

Często zaniebdywany przy określaniu powłoki jest współczynnik tarcia. W większości zastosowań gwintowane elementy łączne muszą być dokręcane do uzyskania minimalnej siły docisku, bez przeciążenia elementów łączonych ani samych elementów łącznych. Proces dokręcania jest często kontrolowany podanym momentem. Fabory zdecydowało się wybrać smarowane powłoki lamelowane cynkowo o współczynniku tarcia zbliżonym do zwykłych i standardowo cynkowanych elementów łącznych: $\mu_{tot} = 0,12 - 0,18$. Zastosowanie smarowania jest określone literą "L".

Powłoki płatkowe wybrane dla standardowego asortymentu Fabory mają specyfikację zgodną z ISO 10683 jako "flZn/nc/L/480h" dla elementów łącznych do M8 oraz jako "flZn/nc/L/600h" dla większych rozmiarów.

6 Dokumentacja kontrolna dla elementów złącznych

6.1 Raporty testowe i certyfikaty EN 10204

Pierwotnie dokumentacja kontrolna (rodzaje certyfikatów) była określona w normie DIN 50049. Definicje badania materiałów i rodzaje certyfikatów wg DIN 50049 stały się podstawą dla normy europejskiej EN 10204, która była opublikowana po raz pierwszy w roku 1991.

Zarówno DIN 50049 jak i EN 10204 określają rodzaje certyfikatów 2.1, 2.2, 2.3, 3.1A, 3.1B, 3.1C oraz 3.2.

EN 10204 miała ostatnią rewizję w roku 2004 w zakresie uproszczenia dokumentacji kontrolnej (rodzajów certyfikatów). Obecnie certyfikaty obejmują jedynie typy 2.1, 2.2, 3.1 oraz 3.2.

Typ 2.3 został skreślony.

Typ 3.1 zastępuje 3.1B

Typ 3.2 zastępuje 3.1A, 3.1C i 3.2 z poprzedniej edycji.

Poniższa tabela podaje pełen zakres aktualnych (C= edycja 2004) oraz wycofanych (W= edycja 1995) rodzajów certyfikatów EN 10204 wraz z krótką interpretacją ich zakresu.

Typ certyfikatu	Tytuł	Status	Streszczenie wymagań EN10204	Uwagi
2.1	Deklaracja zgodności z zamówieniem	C	Deklaracja producenta o zgodności z zamówieniem.	Nie podaje wyników badań.
2.2	Raport testowy	C	Deklaracja producenta o zgodności z zamówieniem w oparciu o nieszczegółową kontrolę (testy) producenta.	Można podać przykładowe wyniki badań z innej partii wytworzonej wg tej samej procedury.
2.3	Szczegółowy raport testowy	W	Z podaniem wyników badań ze szczegółowej kontroli i testowania	Niezbędne są wyniki badań dostarczanej partii. Certyfikat wystawiony i podpisany przez przedstawiciela producenta, który nie musi być niezależny od działu produkcji.
3.1	Certyfikat kontroli	C	Deklaracja producenta o zgodności z zamówieniem z wynikami szczegółowej kontroli	Zastępuje 3.1B. Zwykły typ certyfikatu wystawianego dla dostarczanej partii wyrobów. Certyfikat wystawiony i podpisany przez przedstawiciela producenta, który musi być niezależny od działu produkcji, np. kierownika działu kontroli/inspektora nadzoru.
3.1A	Certyfikat kontroli 3.1A	W	Z podaniem wyników badań ze szczegółowej kontroli i testowania	Wyniki badań dostarczanej partii. Certyfikat wystawiany przez niezależnego inspektora wymagany przez organ wydający (np TUV dla niemieckich zbiorników ciśnieniowych). Zastąpiony przez 3.2 w roku 2004.
3.1B	Certyfikat kontroli 3.1B	W	Z podaniem wyników badań ze szczegółowej kontroli i testowania	Wyniki badań dostarczanej partii. Certyfikat wystawiony i podpisany przez przedstawiciela producenta. Zastąpiony przez 3.1 w roku 2004
3.1C	Certyfikat kontroli 3.1C	W	Z podaniem wyników badań ze szczegółowej kontroli i testowania	Wyniki badań dostarczanej partii. Certyfikat wystawiony przez niezależnego inspektora mianowanego przez klienta (np. akredytowane laboratorium Lloyds). Zastąpiony przez 3.2 w roku 2004
3.2	Raport kontrolny	C	Deklaracja zgodności z zamówieniem ze wskazaniem wyników kontroli szczegółowej	Wyniki badań dostarczanej partii. Raport wystawiony zarówno przez przedstawiciela producenta oraz niezależnego inspektora mianowanego przez klienta (por. wycofany 3.1C) lub inspektora wyznaczonego przez oficjalne przepisy (por. wycofane 3.1A), tj. 3.2 obecnie obejmuje zakres 3.1A oraz 3.1C z wcześniejszej edycji.

Laboratorium Fabory jest akredytowane wg ISO/IEC 17025 jako niezależny ośrodek testowy w zakresie badań własności mechanicznych oraz analizy składu chemicznego elementów złącznych. Laboratorium ma możliwość wystawiania atestów wg EN 10204 typ 3.1 C (edycja 1995).



6.2 Dokumenty PPAP

PPAP jest akronimem dla "Production Part Approval Process" (Procedura Zatwierdzania Części do Produkcji) zazwyczaj wymawiany jako "pi-pap". Głównym celem dokumentacji jakościowej PPAP jest weryfikacja zdolności producenta do wytwarzania i konsekwentnego dostarczania części samochodowej w pełni spełniającej wymagania określone w zamówieniu.

System PPAP jest unikatowy dla przemysłu motoryzacyjnego, chociaż niektóre inne branże też z niego korzystają. Niezbędna jest wielka ilość dokumentacji dla zminimalizowania prawdopodobieństwa defektu części samochodowej, która może obniżyć bezpieczeństwo pojazdu, jego niezawodność i poziom satysfakcji klienta, a także doprowadzić do przerw w produkcji pojazdu.

W instrukcji PPAP opublikowanej przez AIAG określono kilka Poziomów Zgodności PPAP.

Istnieje pięć Poziomów Zgodności PPAP:

Poziom 1: wyłącznie dokument przekazania części PSW.

Poziom 2: dokument PSW z próbkami produktu i ograniczonymi danymi.

Poziom 3: dokument PSW z próbkami produktu i pełnymi danymi.

Poziom 4: dokument PSW oraz inne wymagania określone przez klienta.

Poziom 5: dokument PSW z próbkami produktu i pełnymi danymi dostępnymi w celach inspekcyjnych w miejscu produkcji.

Na ogół wymagany jest "Poziom 3", dla którego producent musi odnieść się do szeregu zagadnień:

- Dane projektowe
- Zmiany konstrukcyjne
- Zatwierdzenia konstrukcyjne
- Analiza projektu (DFMEA)
- Schematy przebiegu procesu
- Analiza procesu (PFMEA)
- Plan kontroli
- Studium analizy systemu pomiarowego
- Wyniki wymiarowe
- Wyniki badań materiałowych
- Wstępne studium procesu
- Dokumentacja z kwalifikowanego laboratorium
- Raport Zatwierdzenia Wyglądu (jeśli dotyczy)
- Próbką produktu
- Dokumentacja zgodności ze szczegółowymi wymaganiami klienta
- Dokument przekazania części (PSW)

Dla części standardowych (ISO, DIN, ...) i w uzgodnieniu z klientem, często można znacznie ograniczyć liczbę zagadnień. Choć na ogół dokumentacja PPAP musi być wystawiona przez producenta, na specjalne życzenie klient może uzgodnić z Fabory wykonanie uproszczonej dokumentacji PPAP w swoim akredytowanym laboratorium.

Dokumenty przekazania PPAP są ważne zazwyczaj do chwili wprowadzenia zmiany projektu lub procesu wytwarzania danej części przez producenta.

6.3 Certyfikacja CE

Wiele wyrobów przemysłowych musi być wytwarzanych przez producenta z certyfikatem CE lub ze znakiem CE. Z biegiem czasu liczba produktów wymagających oznakowania CE będzie dalej zwiększana. Znak CE oznacza, że produkt spełnia podstawowe europejskie wymagania w zakresie BHP, niezbędne by wprowadzić produkt na rynek. Takie minimalne wymagania są opisane w Przewodniku Europejskim. Przewodnik ten nie zawiera szczegółowych danych technicznych produktu. Tego rodzaju specyfikacje techniczne zamieszczone są w normach dla wielu produktów, głównie europejskich.

Elementy złączne, dla których wymagane jest oznakowanie CE:



W związku z dyrektywą maszynową (2006/42/EC):

DIN 580 resp. DIN 582: Śruby i nakrętki z uchem jeśli stosowane jako sprzęt do podnoszenia.

W związku z dyrektywą o produktach budowlanych (89/106/EEC):

EN 14399: Wysokowytrzymałościowe zestawy skręcane sprężane.

EN 15048: Niesprężane zestawy skręcane.

Dla elementów złącznych według tej Dyrektywy dostępne są Deklaracja Właściwości Użytkowych (DoP) oraz certyfikat wg EN 10204 typ 3.1.

7 Wskazówki projektowe i montażowe dla elementów złącznych

Celem zapewnienia by gwintowane elementy złączne spełniały swe zadanie i nie luzowały się ani zawodziły w działaniu, należy dokonać starannej selekcji elementów i metod montażowych dla każdego zastosowania. Poniższe informacje bazują na wskazówkach VDI 2230:2003 "Systematyczne obliczenia dla połączeń śrubowych wysokiej wytrzymałości". Zależnie od rzeczywistej sytuacji montażowej koniecznym może być dalsze zbadanie konstrukcji i wskazówek montażowych.

Uwaga: dla konstrukcji objętych normą EN 1090, złącze skręcane (sprężane lub niesprężane) ma być montowane zgodnie z metodami opisanymi w krajowych wydaniach norm europejskich EN 1090 lub EN 1993. Zależnie od kraju, mogą być stosowane dodatkowe wymagania.

7.1 Tabele momentów dokręcania dla stalowych połączeń śrubowych

7.1.1 Obciążenie montażowe wstępne/momenty dokręcania – gwint grubozwojny

Poniższa tabela ma zastosowanie do śrub z trzpieniem, z gwintem metrycznym zgodnym z ISO 262, rozmiarem łba śrub sześciokątnych według ISO 4014 – 4018 i odpowiednio wkrętów z gniazdem sześciokątnym (sześciokarbowym) według ISO 4762, i nawierceniach "średnich" wg EN 20273. Zalecenia dla momentów dokręcania dla produktów innych niż wyżej wymienione normy i warunki (np. podobnie wyglądających produktów wg DIN), **NIE MOGA** być pobierane z tej tabeli i są dostępne na życzenie.

Średnica znamionowa	Klasa właściwości	Obciążenie montażowe wyrażone w N dla $\mu_e =$							Momenty dokręcania M_k wyrażone w Nm dla $\mu_k = \mu_e =$						
		0,08	0,10	0,12	0,14	0,16	0,20	0,24	0,08	0,10	0,12	0,14	0,16	0,20	0,24
M4	8.8	4 600	4 500	4 400	4 300	4 200	3 900	3 700	2,3	2,6	3,0	3,3	3,6	4,1	4,5
	10.9	6 800	6 700	6 500	6 300	6 100	5 700	5 400	3,3	3,9	4,6	4,8	5,3	6,0	6,6
	12.9	8 000	7 800	7 600	7 400	7 100	6 700	6 300	3,9	4,5	5,1	5,6	6,2	7,0	7,8
M5	8.8	7 600	7 400	7 200	7 000	6 800	6 400	6 000	4,4	5,2	5,9	6,5	7,1	8,1	9,0
	10.9	11 100	10 800	10 600	10 300	10 000	9 400	8 800	6,5	7,6	8,6	9,5	10,4	11,9	13,2
	12.9	13 000	12 700	12 400	12 000	11 700	11 000	10 300	7,6	8,9	10,0	11,2	12,2	14,0	15,5
M6	8.8	10 700	10 400	10 200	9 900	9 600	9 000	8 400	7,7	9,0	10,1	11,3	12,3	14,1	15,6
	10.9	15 700	15 300	14 900	14 500	14 100	13 200	12 400	11,3	13,2	14,9	16,5	18,0	20,7	22,9
	12.9	18 400	17 900	17 500	17 000	16 500	15 500	14 500	13,2	15,4	17,4	19,3	21,3	24,2	26,8
M7	8.8	15 500	15 100	14 800	14 400	14 000	13 100	12 300	12,6	14,8	16,8	18,7	20,5	23,6	26,2
	10.9	22 700	22 500	21 700	21 100	20 500	19 300	18 100	18,5	21,7	24,7	27,5	30,1	34,7	38,5
	12.9	26 600	26 000	25 400	24 700	24 000	22 600	21 200	21,6	25,4	28,9	32,2	35,2	40,6	45,1
M8	8.8	19 500	19 100	18 600	18 100	17 600	16 500	15 500	18,5	21,6	24,6	27,3	29,8	34,3	38,0
	10.9	28 700	28 000	27 300	26 600	25 800	24 300	22 700	27,2	31,8	36,1	40,1	43,8	50,3	55,8
	12.9	33 600	32 800	32 000	31 100	30 200	28 400	26 600	31,8	37,2	42,2	46,9	51,2	58,9	65,3
M10	8.8	31 000	30 300	29 600	28 800	27 900	26 300	24 700	36	43	48	54	59	68	75
	10.9	45 600	44 500	43 400	42 200	41 000	38 600	36 200	53	63	71	79	87	100	110
	12.9	53 300	52 100	50 800	49 400	48 000	45 200	42 400	62	73	83	93	101	116	129
M12	8.8	45 200	44 100	43 000	41 900	40 700	38 300	35 900	63	73	84	93	102	117	130
	10.9	66 300	64 800	63 200	61 500	59 800	56 300	52 800	92	108	123	137	149	172	191
	12.9	77 600	75 900	74 000	72 000	70 000	65 800	61 800	108	126	144	160	175	201	223
M14	8.8	62 000	60 600	59 100	57 500	55 900	52 600	49 300	100	117	133	148	162	187	207
	10.9	91 000	88 900	86 700	84 400	82 100	77 200	72 500	146	172	195	218	238	274	304
	12.9	106 500	104 100	101 500	98 800	96 000	90 400	84 800	171	201	229	255	279	321	356
M16	8.8	84 700	82 900	80 900	78 800	76 600	72 200	67 800	153	180	206	230	252	291	325
	10.9	124 400	121 700	118 800	115 700	112 600	106 100	99 600	224	264	302	338	370	428	477
	12.9	145 500	142 400	139 000	135 400	131 700	124 100	116 600	262	309	354	395	433	501	558
M18	8.8	107 000	104 000	102 000	99 000	96 000	91 000	85 000	220	259	295	329	360	415	462
	10.9	152 000	149 000	145 000	141 000	137 000	129 000	121 000	314	369	421	469	513	592	657
	12.9	178 000	174 000	170 000	165 000	160 000	151 000	142 000	367	432	492	549	601	692	769
M20	8.8	136 000	134 000	130 000	127 000	123 000	116 000	109 000	308	363	415	464	509	588	655
	10.9	194 000	190 000	186 000	181 000	176 000	166 000	156 000	438	517	592	661	725	838	933
	12.9	227 000	223 000	217 000	212 000	206 000	194 000	182 000	513	605	692	773	848	980	1092
M22	8.8	170 000	166 000	162 000	158 000	154 000	145 000	137 000	417	495	567	634	697	808	901
	10.9	242 000	237 000	231 000	225 000	219 000	207 000	194 000	595	704	807	904	993	1 151	1 284
	12.9	283 000	277 000	271 000	264 000	257 000	242 000	228 000	696	824	945	1057	1 162	1 347	1 502
M24	8.8	196 000	192 000	188 000	183 000	178 000	168 000	157 000	529	625	714	798	875	1 011	1 126
	10.9	280 000	274 000	267 000	260 000	253 000	239 000	224 000	754	890	1 017	1 136	1 246	1 440	1 604
	12.9	327 000	320 000	313 000	305 000	296 000	279 000	262 000	882	1 041	1 190	1 329	1 458	1 685	1 877
M27	8.8	257 000	252 000	246 000	240 000	234 000	220 000	207 000	772	915	1 050	1 176	1 292	1 498	1 672
	10.9	367 000	359 000	351 000	342 000	333 000	314 000	295 000	1 100	1 304	1 496	1 674	1 840	2 134	2 381
	12.9	429 000	420 000	410 000	400 000	389 000	367 000	345 000	1 287	1 526	1 750	1 959	2 153	2 497	2 787
M30	8.8	313 000	307 000	300 000	292 000	284 000	268 000	252 000	1 053	1 246	1 428	1 597	1 754	2 931	2 265
	10.9	446 000	437 000	427 000	416 000	405 000	382 000	359 000	1 500	1 775	2 033	2 274	2 498	2 893	3 226
	12.9	522 000	511 000	499 000	487 000	474 000	447 000	420 000	1 755	2 077	2 380	2 662	2 923	3 386	3 775
M33	8.8	389 000	381 000	373 000	363 000	354 000	334 000	314 000	1 415	1 679	1 928	2 161	2 377	2 759	3 081
	10.9	554 000	543 000	531 000	517 000	504 000	475 000	447 000	2 015	2 392	2 747	3 078	3 385	3 930	4 388
	12.9	649 000	635 000	621 000	605 000	589 000	556 000	523 000	2 358	2 799	3 214	3 601	3 961	4 598	5 135
M36	8.8	458 000	448 000	438 000	427 000	415 000	392 000	368 000	1 825	2 164	2 482	2 778	3 054	3 541	3 951
	10.9	652 000	638 000	623 000	608 000	591 000	558 000	524 000	2 600	3 082	3 535	3 957	4 349	5 043	5 627
	12.9	763 000	747 000	729 000	711 000	692 000	653 000	614 000	3 042	3 607	4 136	4 631	5 089	5 902	6 585
M39	8.8	548 000	537 000	525 000	512 000	498 000	470 000	443 000	2 348	2 791	3 208	3 597	3 958	4 598	5 137
	10.9	781 000	765 000	748 000	729 000	710 000	670 000	630 000	3 345	3 975	4 569	5 123	5 637	6 549	7 317
	12.9	914 000	895 000	875 000	853 000	831 000	784 000	738 000	3 914	4 652	5 346	5 994	6 596	7 664	8 562

7.1.2 Obciążenie montażowe wstępne/momenty dokręcania – gwint drobnozwojny

Poniższa tabela ma zastosowanie do śrub z trzpieniem, z gwintem metrycznym zgodnym z ISO 262, rozmiarem lba śrub sześciokątnych według ISO 4014 – 4018 i odpowiednio wkrętów z gniazdem sześciokątnym (sześciokarbowym) według ISO 4762 i nawierceniach “średnich” wg EN 20273. Zalecenia dla momentów dokręcania dla produktów innych niż wyżej wymienione normy i warunki (np. podobnie wyglądających produktów wg DIN) **NIE MOGĄ** być pobierane z tej tabeli i są dostępne na życzenie.

Średnica znamionowa	Klasa właściwości	Obciążenie montażowe wyrażone w N dla $\mu_s =$							Momenty dokręcania M_A wyrażone w Nm dla $\mu_k = \mu_s =$						
		0,08	0,10	0,12	0,14	0,16	0,20	0,24	0,08	0,10	0,12	0,14	0,16	0,20	0,24
M8x1	8.8	21 200	20 700	20 200	19 700	19 200	18 100	17 000	19,3	22,8	26,1	29,2	32,0	37,0	41,2
	10.9	31 100	30 400	29 700	28 900	28 100	26 500	24 900	28,4	33,5	38,3	42,8	47,0	54,3	60,5
	12.9	36 400	35 600	34 700	33 900	32 900	31 000	29 100	33,2	39,2	44,9	50,1	55,0	63,6	70,8
M9x1	8.8	27 700	27 200	26 500	25 900	25 200	23 700	22 300	28,0	33,2	38,1	42,6	46,9	54,4	60,7
	10.9	40 700	39 900	39 000	38 000	37 000	34 900	32 800	41,1	48,8	55,9	62,6	68,8	79,8	89,1
	12.9	47 700	46 700	45 600	44 400	43 300	40 800	38 400	48,1	57,0	65,4	73,3	80,6	93,4	104,3
M10x1	8.8	35 200	34 500	33 700	32 900	32 000	30 200	28 400	39	46	53	60	66	76	85
	10.9	51 700	50 600	49 500	48 300	47 000	44 400	41 700	57	68	78	88	97	112	125
	12.9	60 400	59 200	57 900	56 500	55 000	51 900	48 800	67	80	91	103	113	131	147
M10x1,25	8.8	33 100	32 400	31 600	30 800	29 900	28 200	26 500	38	44	51	57	62	72	80
	10.9	48 600	47 500	46 400	45 200	44 000	41 400	38 900	55	65	75	83	92	106	118
	12.9	56 800	55 600	54 300	52 900	51 400	48 500	45 500	65	76	87	98	107	124	138
M12x1,25	8.8	50 100	49 100	48 000	46 800	45 600	43 000	40 400	66	79	90	101	111	129	145
	10.9	73 600	72 100	70 500	68 700	66 900	63 200	59 400	97	116	133	149	164	190	212
	12.9	86 200	84 400	82 500	80 400	78 300	73 900	69 500	114	135	155	174	192	222	249
M12x1,5	8.8	47 600	46 600	45 500	44 300	43 100	40 600	38 200	64	76	87	97	107	123	137
	10.9	70 000	68 500	66 800	65 100	63 300	59 700	56 000	95	112	128	143	157	181	202
	12.9	81 900	80 100	78 200	76 200	74 100	69 800	65 600	111	131	150	167	183	212	236
M14x1,5	8.8	67 800	66 400	64 800	63 200	61 500	58 100	54 600	104	124	142	159	175	203	227
	10.9	99 500	97 500	95 200	92 900	90 400	85 300	80 200	153	182	209	234	257	299	333
	12.9	116 500	114 100	111 400	108 700	105 800	99 800	93 900	179	213	244	274	301	349	390
M16x1,5	8.8	91 400	89 600	87 600	85 500	83 200	78 600	74 000	159	189	218	244	269	314	351
	10.9	134 200	131 600	128 700	125 500	122 300	115 500	108 700	233	278	320	359	396	461	515
	12.9	157 100	154 000	150 600	146 900	143 100	135 100	127 200	273	325	374	420	463	539	603
M18x1,5	8.8	122 000	120 000	117 000	115 000	112 000	105 000	99 000	237	283	327	368	406	473	530
	10.9	174 000	171 000	167 000	163 000	159 000	150 000	141 000	337	403	465	523	578	674	755
	12.9	204 000	200 000	196 000	191 000	186 000	176 000	166 000	394	472	544	613	676	789	884
M18x2	8.8	114 000	112 000	109 000	107 000	104 000	98 000	92 000	229	271	311	348	383	444	495
	10.9	163 000	160 000	156 000	152 000	148 000	139 000	131 000	326	386	443	496	545	632	706
	12.9	191 000	187 000	182 000	178 000	173 000	163 000	153 000	381	452	519	581	638	740	826
M20x1,5	8.8	154 000	151 000	148 000	144 000	141 000	133 000	125 000	327	392	454	511	565	660	741
	10.9	219 000	215 000	211 000	206 000	200 000	190 000	179 000	466	558	646	728	804	940	1055
	12.9	257 000	252 000	246 000	241 000	234 000	222 000	209 000	545	653	756	852	941	1100	1234
M22x1,5	8.8	189 000	186 000	182 000	178 000	173 000	164 000	154 000	440	529	613	692	765	896	1006
	10.9	269 000	264 000	259 000	253 000	247 000	233 000	220 000	627	754	873	985	1090	1276	1433
	12.9	315 000	309 000	303 000	296 000	289 000	273 000	257 000	734	882	1022	1153	1275	1493	1677
M24x1,5	8.8	228 000	224 000	219 000	214 000	209 000	198 000	187 000	570	686	796	899	995	1166	1311
	10.9	325 000	319 000	312 000	305 000	298 000	282 000	266 000	811	977	1133	1280	1417	1661	1867
	12.9	380 000	373 000	366 000	357 000	347 000	330 000	311 000	949	1143	1326	1498	1658	1943	2185
M24x2	8.8	217 000	213 000	209 000	204 000	198 000	187 000	177 000	557	666	769	865	955	1114	1248
	10.9	310 000	304 000	297 000	290 000	282 000	267 000	251 000	793	949	1095	1232	1360	1586	1777
	12.9	362 000	355 000	348 000	339 000	331 000	312 000	294 000	928	1110	1282	1442	1591	1856	2080
M27x1,5	8.8	293 000	288 000	282 000	276 000	269 000	255 000	240 000	822	992	1153	1304	1445	1697	1910
	10.9	418 000	410 000	402 000	393 000	383 000	363 000	342 000	1171	1413	1643	1858	2059	2417	2720
	12.9	489 000	480 000	470 000	460 000	448 000	425 000	401 000	1370	1654	1922	2174	2409	2828	3183
M27x2	8.8	281 000	276 000	270 000	264 000	257 000	243 000	229 000	806	967	1119	1262	1394	1630	1829
	10.9	400 000	393 000	384 000	375 000	366 000	346 000	326 000	1149	1378	1594	1797	1986	2322	2605
	12.9	468 000	460 000	450 000	439 000	428 000	405 000	382 000	1344	1612	1866	2103	2324	2717	3049
M30x2	8.8	353 000	347 000	339 000	331 000	323 000	306 000	288 000	1116	1343	1556	1756	1943	2276	2557
	10.9	503 000	494 000	483 000	472 000	460 000	436 000	411 000	1590	1912	2216	2502	2767	3241	3641
	12.9	588 000	578 000	565 000	552 000	539 000	510 000	481 000	1861	2238	2594	2927	3238	3793	4261
M33x2	8.8	433 000	425 000	416 000	407 000	397 000	376 000	354 000	1489	1794	2082	2352	2605	3054	3435
	10.9	617 000	606 000	593 000	580 000	565 000	535 000	505 000	2120	2555	2965	3350	3710	4350	4892
	12.9	722 000	709 000	694 000	678 000	662 000	626 000	591 000	2481	2989	3470	3921	4341	5090	5725
M36x2	8.8	521 000	512 000	502 000	490 000	478 000	453 000	427 000	1943	2345	2725	3082	3415	4010	4513
	10.9	742 000	729 000	714 000	698 000	681 000	645 000	609 000	2767	3340	3882	4390	4864	5711	6428
	12.9	869 000	853 000	836 000	817 000	797 000	755 000	712 000	3238	3908	4542	5137	5692	6683	7522
M39x2	8.8	618 000	607 000	595 000	581 000	567 000	537 000	507 000	2483	3002	3493	3953	4383	5151	5801
	10.9	880 000	864 000	847 000	828 000	808 000	765 000	722 000	3537	4267	4974	5631	6243	7336	8263
	12.9	1030 000	1011 000	991 000	969 000	945 000	896 000	845 000	4139	5003	5821	6589	7306	8585	9669

7.2 Tabele momentów dokręcania dla połączeń śrubowych ze stali nierdzewnej

7.2.1 Obciążenie montażowe wstępne / momenty dokręcania

Poniższe wartości stosuje się dla wykonanych z austenicznej stali nierdzewnej śrub z łbem sześciokątnym zgodnych z ISO 4014 – 4018 i odpowiednio wkrętów z gniazdem sześciokątnym (sześciokarbowym) według ISO 4762. Momenty są wartościami obliczonymi teoretycznie w zależności od wybranego współczynnika tarcia i w oparciu o obciążenie wstępne, z wykorzystaniem 90% minimalnej granicy plastyczności podczas montażu.

Zalecenia dla momentów dokręcania dla produktów innych niż wyżej wymienione normy i warunki (np. podobnie wyglądających produktów wg DIN) **NIE MOGĄ** być pobierane z tej tabeli i są dostępne na życzenie.

Współczynnik tarcia		Obciążenie montażowe F_m wyrażone w kN dla $\mu_g =$								Moment dokręcania M_A wyrażony w Nm dla $\mu_k = \mu_g =$							
Średnica podstawowa	Klasa	0,10	0,12	0,14	0,16	0,18	0,20	0,30	0,40	0,10	0,12	0,14	0,16	0,18	0,20	0,30	0,40
M4	50	1,46	1,41	1,37	1,32	1,28	1,24	1,04	0,88	0,83	0,94	1,04	1,12	1,20	1,28	1,55	1,72
	70	3,12	3,03	2,93	2,84	2,74	2,65	2,22	1,88	1,79	2,01	2,22	2,41	2,58	2,73	3,32	3,68
	80	4,16	4,04	3,91	3,78	3,65	3,53	2,96	2,51	2,38	2,68	2,96	3,21	3,44	3,64	4,42	4,91
M5	50	2,38	2,32	2,25	2,17	2,10	2,03	1,71	1,45	1,65	1,86	2,06	2,24	2,41	2,55	3,12	3,47
	70	5,11	4,96	4,81	4,66	4,51	4,36	3,67	3,11	3,54	4,00	4,42	4,80	5,15	5,47	6,68	7,43
	80	6,81	6,62	6,41	6,21	6,01	5,81	4,89	4,15	4,72	5,33	5,89	6,40	6,87	7,30	8,91	9,90
M6	50	3,36	3,26	3,16	3,06	2,96	2,86	2,40	2,04	2,86	3,23	3,57	3,88	4,16	4,42	5,38	5,98
	70	7,20	6,99	6,77	6,56	6,34	6,13	5,15	4,37	6,14	6,92	7,65	8,31	8,91	9,46	11,53	12,81
	80	9,60	9,32	9,03	8,74	8,45	8,17	6,87	5,83	8,18	9,23	10,20	11,08	11,88	12,62	15,37	17,08
M8	50	6,2	6,0	5,8	5,6	5,5	5,3	4,4	3,8	7,0	7,9	8,7	9,5	10,2	10,8	13,3	14,8
	70	13,2	12,8	12,5	12,1	11,7	11,3	9,5	8,1	14,9	16,9	18,7	20,3	21,8	23,2	28,4	31,6
	80	17,6	17,1	16,6	16,1	15,6	15,1	12,7	10,8	19,9	22,5	24,9	27,1	29,1	30,9	37,9	42,2
M10	50	9,8	9,5	9,3	9,0	8,7	8,4	7,1	6,0	13,7	15,6	17,2	18,8	20,2	21,5	26,4	29,4
	70	21,0	20,5	19,9	19,2	18,6	18,0	15,2	12,9	29,4	33,3	37,0	40,3	43,3	46,1	56,5	63,0
	80	28,1	27,3	26,5	25,7	24,8	24,0	20,3	17,2	39,2	44,5	49,3	53,7	57,7	61,4	75,4	84,0
M12	50	14,3	13,9	13,5	13,1	12,7	12,3	10,4	8,8	23,7	26,9	29,8	32,5	35,0	37,2	45,8	51,1
	70	30,7	29,8	29,0	28,1	27,2	26,3	22,2	18,9	50,8	57,7	63,9	69,7	75,0	79,8	98,1	109,4
	80	40,9	39,8	38,6	37,4	36,2	35,1	29,6	25,2	67,8	76,9	85,3	93,0	100,0	106,4	130,8	145,9
M14	50	19,6	19,0	18,5	17,9	17,4	16,8	14,2	12,1	38,2	43,4	48,2	52,6	56,6	60,3	74,2	82,9
	70	41,9	40,8	39,6	38,4	37,2	36,0	30,4	25,9	81,9	93,0	103,3	112,7	121,3	129,2	159,0	177,6
	80	55,9	54,4	52,8	51,2	49,6	48,0	40,6	34,5	109,3	124,1	137,7	150,3	161,8	172,3	212,0	236,7
M16	50	27,0	26,3	25,6	24,8	24,1	23,3	19,8	16,8	58,3	66,4	74,0	80,9	87,3	93,1	115,3	129,2
	70	57,8	56,4	54,8	53,2	51,6	49,9	42,4	36,1	124,8	142,3	158,5	173,4	187,1	199,6	247,1	276,8
	80	77,1	75,1	73,1	70,9	68,8	66,6	56,5	48,1	166,4	189,8	211,4	231,2	249,5	266,1	329,5	369,1
M18	50	32,9	32,0	31,1	30,2	29,3	28,3	24,0	20,4	81,7	92,8	103,1	112,6	121,2	129,1	159,2	177,9
	70	70,6	68,7	66,7	64,7	62,7	60,7	51,4	43,7	175,0	198,9	220,9	241,2	259,8	276,7	341,1	381,2
	80	94,1	91,6	89,0	86,3	83,6	80,9	68,5	58,3	233,3	265,2	294,6	321,6	346,4	369,0	454,8	508,3
M20	50	42,1	41,1	39,9	38,8	37,6	36,4	30,9	26,3	114,0	130,0	144,8	158,5	171,0	182,4	226,0	253,2
	70	90,3	88,0	85,5	83,0	80,5	78,0	66,2	56,4	244,4	278,6	310,4	339,6	366,4	390,9	484,3	542,6
	80	120,4	117,3	114,1	110,7	107,4	104,0	88,2	75,2	325,8	371,5	413,8	452,8	488,6	521,2	645,7	723,5
M22	50	52,4	51,1	49,8	48,3	46,9	45,5	38,6	33,0	153,0	174,9	195,2	214,0	231,2	247,0	307,2	344,9
	70	112,4	109,6	106,6	103,6	100,5	97,4	82,8	70,6	327,8	374,8	418,4	458,6	495,5	529,3	658,3	739,1
	80	149,8	146,1	142,2	138,1	134,0	129,9	110,4	94,1	437,1	499,7	557,8	611,4	660,7	705,7	877,8	985,5
M24	50	61	59	58	56	54	52	45	38	197	224	250	273	295	314	389	436
	70	130	127	123	120	116	112	95	81	421	480	535	585	632	674	835	935
	80	173	169	164	160	155	150	127	108	562	640	713	781	842	898	1113	1247
M27	50	80	78	76	73	71	69	59	50	289	331	369	405	438	468	583	655
	70	170	166	162	157	153	148	126	107	619	708	791	868	938	1003	1249	1403
M30	50	97	95	92	89	87	84	71	61	394	450	502	550	594	635	789	886
	70	208	203	197	191	186	180	153	130	843	964	1076	1179	1273	1360	1691	1898
M33	50	121	118	115	111	108	105	89	76	531	609	681	747	808	864	1079	1213
M36	50	142	138	134	131	127	123	105	89	684	782	874	959	1036	1108	1380	1551
M39	50	170	166	161	157	152	148	126	108	883	1013	1133	1245	1347	1441	1802	2028

7.3 Współczynniki tarcia μ_G oraz μ_K

Poniższa tabela zawiera wskazówki dla wyboru współczynników tarcia μ_G oraz μ_K (μ_G = współczynnik tarcia gwintu / μ_K = współczynnik tarcia łba śruby lub powierzchni nośnej nakrętki). Współczynnik tarcia może się różnić znacznie w zależności od szczegółowej specyfikacji zastosowanych materiałów i smarów.

Typowe przykłady		Współczynnik tarcia μ_G oraz μ_K
Materiał / powierzchnia	Smar	
Metaliczny jasny Czarny oksydowany Fosforyzowany Powłoki galwaniczne takie jak: Zn, Zn/Fe, Zn/Ni Powłoki lamelowane cynkowo	Smary stałe takie jak: MoS ₂ , grafitowy, PTFE, PA, PE, PI w lakierach smarowniczych nawierzchniowych lub w pastach; Wosk płynny Emulsja woskowa	0,04 do 0,10
Jasny metaliczny Czarny oksydowany Fosforyzowany Powłoki galwaniczne takie jak: Zn, Zn/Fe, Zn/Ni Powłoki lamelowane cynkowo Stopy Al oraz Mg	Smary stałe takie jak: MoS ₂ , grafitowy, PTFE, PA, PE, PI w lakierach smarowniczych nawierzchniowych lub w pastach; Wosk płynny Emulsja woskowa, smary; Oleje; stan dostawy	0,08 do 0,16
Galwanizowany na gorąco	MoS ₂ , grafit; Emulsja woskowa	
Powłoki organiczne	Ze zintegrowanym smarem stałym lub emulsją woskową	
Stal austenityczna	Smary stałe lub woski; pasty	0,14 do 0,24
Stal austenityczna	Emulsja woskowa, pasty	
Jasny metaliczny Fosforyzowany	Stan dostawy (lekko naoliwiony)	
Powłoki galwaniczne takie jak: Zn, Zn/Fe, Zn/Ni Powłoki lamelowane cynkowo klej	brak	
Stal austenityczna	olej	
Powłoki galwaniczne takie jak: Zn, Zn/Fe; Galwanizowany na gorąco	brak	0,20 do 0,35
Powłoki galwaniczne takie jak: Zn/Fe, Zn/Ni; Stal austenityczna Stopy Al oraz Mg	brak	≥ 0,30

Uwaga: jeśli współczynniki tarcia nie zostały ustalone doświadczalnie, zastosowanie najmniejszej wartości tarcia z niniejszej tabeli zmniejszy ryzyko przekręcenia śruby. **(Dział Techniczny Fabory może wykonać test tarcia na specjalne życzenie oraz dla krytycznych zastosowań).**

7.4 Tabele momentów dokręcania dla stalowych calowych połączeń śrubowych

Tak samo jak dla metrycznych gwintowanych elementów złącznych, również ustalenie momentu dokręcania dla calowych śrub wykonuje się w oparciu o szereg czynników, z których bardzo ważny jest współczynnik tarcia. Podejście amerykańskie zgodnie z SAE J1701, jest istotnie różne od europejskiego.

Poniższe tabele bazują na empirycznym wzorze tarcie/rozciąganie $T = K \times d \times W$

Gdzie T = moment
 K = współczynnik tarcia
 d = znamionowa średnica gwintu (cale)
 W = rozciąganie (siła docisku lub sprężanie wstępne) powstałe w elemencie złącznym (lbs)

Wartość "K" może mieścić się w zakresie od powyżej 0,30 dla połączenia zardzewiałego do 0,10 lub mniej dla połączenia czystego, dobrze nasmarowanego teflonem lub smarem na bazie MoS₂. Powyższy wzór dowodzi istoty wartości współczynnika K gdyż zakres 0,10 do 0,30 powoduje ekstremalnie zmienne wartości momentu.

Dla połączeń o średnim poziomie krytycznym często stosuje się następujące wartości K:

Elementy współpracujące	współczynnik K
Suche, czyste z cienką warstwą oleju	0.15 – 0.20
Dodatkowe powłoki smarujące z oleju, wosku, lub galwanizowane różnymi metalami lub podkładka twarda	0.10 – 0.15
Powierzchnie nośne gwintu i tła pokryte wysokowydajnymi smarami lub czynnikami przeciwzatarciowymi	może być tak niski jak 0.05
Kombinacja pewnych materiałów takich jak śruby/wkręty z austenitycznej stali nierdzewnej oraz elementy nie smarowane ani powlekane	może być tak wysoki jak 0.35

Szczególnie w przypadku połączeń krytycznych, jedynym sposobem określenia prawidłowego momentu jest badanie dla rzeczywistego połączenia i w rzeczywistych warunkach montażowych z wykorzystaniem kalibrowanego klucza dynamometrycznego oraz wskaźnika obciążenia takiego jak przyrząd Skidmore-Wilhelma lub bardziej zaawansowany przetwornik z czujnikiem tensometrycznym.

7.4.1 Obciążenie montażowe wstępne / momenty dokręcania – UNC (gwint grubozwojny)

Poniższa tabela prezentuje momenty dokręcania dla śrub z łbem sześciokątnym (UNC Hex Bolts) zgodnie z ASME B18.2.1., ogólnego zastosowania. Te momenty montażowe podane są jako ogólny przewodnik, gdyż moment jest bardzo pośrednim wskaźnikiem naprężenia i na wynik wpływ ma wiele różnych czynników takich jak tarcie, smarowanie, struktura powierzchni, korozja itd.

Średnica znamionowa		Gwint/cal lbs	Gatunek N	Siła zacisku W (*)		Moment dokręcania dla K =					
Ułamki	Dziesiętne			lbs	N	0.10		0.15		0.20	
						lbs.ft	Nm	lbs.ft	Nm	lbs.ft	Nm
¼	0,250	20	Grade 2	1 313	5 839	3	4	4	6	5	7
			Grade 5	2 029	9 023	4	6	6	9	8	11
			Grade 8	2 864	12 739	6	8	9	12	12	16
⅕	0,3125	18	Grade 2	2 163	9 620	6	8	8	11	11	15
			Grade 5	3 342	14 868	9	12	13	18	17	24
			Grade 8	4 719	20 990	12	17	18	25	25	33
⅙	0,375	16	Grade 2	3 196	14 219	10	14	15	20	20	27
			Grade 5	4 940	21 974	15	21	23	31	31	42
			Grade 8	6 974	31 022	22	30	33	44	44	59
⅚	0,4375	14	Grade 2	4 385	19 505	16	22	24	33	32	43
			Grade 5	6 777	30 144	25	33	37	50	49	67
			Grade 8	9 567	42 556	35	47	52	71	70	95
½	0,500	13	Grade 2	5 853	26 037	24	33	37	50	49	66
			Grade 5	9 046	40 239	38	51	57	77	75	102
			Grade 8	12 771	56 808	53	72	80	108	106	144
⅗	0,5625	12	Grade 2	7 503	33 377	35	48	53	72	70	95
			Grade 5	11 596	51 582	54	74	82	111	109	147
			Grade 8	16 371	72 821	77	104	115	156	153	208
⅘	0,625	11	Grade 2	9 323	41 468	49	66	73	99	97	132
			Grade 5	14 408	64 087	75	102	113	153	150	203
			Grade 8	20 340	90 476	106	144	159	215	212	287
¾	0,750	10	Grade 2	13 796	61 369	86	117	129	175	172	234
			Grade 5	21 322	94 844	133	181	200	271	267	361
			Grade 8	30 101	133 897	188	255	282	383	376	510
⅞	0,875	9	Grade 2	11 427	50 830	83	113	125	169	167	226
			Grade 5	19 045	84 717	139	188	208	282	278	377
			Grade 8	41 553	184 836	303	411	454	616	606	822
1	1,000	8	Grade 2	14 992	66 688	125	169	187	254	250	339
			Grade 5	38 616	171 771	322	436	483	654	644	873
			Grade 8	54 517	242 501	454	616	681	924	909	1 232
1⅕	1,125	7	Grade 2	18 892	84 034	177	240	266	360	354	480
			Grade 5	42 363	188 440	397	538	596	808	794	1 077
			Grade 8	68 697	305 578	644	873	966	1 310	1 288	1 746
1¼	1,250	7	Grade 2	23 985	106 691	250	339	375	508	500	677
			Grade 5	53 785	239 247	560	760	840	1 139	1 120	1 519
			Grade 8	87 219	387 968	909	1 232	1 363	1 848	1 817	2 464
1⅓	1,375	6	Grade 2	28 584	127 146	328	444	491	666	655	888
			Grade 5	64 097	285 116	734	996	1 102	1 494	1 469	1 991
			Grade 8	103 941	462 350	1 191	1 615	1 786	2 422	2 382	3 229
1½	1,500	6	Grade 2	34 781	154 714	435	589	652	884	870	1 179
			Grade 5	77 994	346 934	975	1 322	1 462	1 983	1 950	2 644
			Grade 8	126 477	562 595	1 581	2 143	2 371	3 215	3 162	4 287

Konwersja wartości momentu: 1 lbs in = 0,11298 Nm 1 lbs ft = 1,35581 Nm ;
 1 Nm = 8.85074 lbs in 1 Nm = 0.73756 lbs ft

(*) W tej tabeli siła zacisku (obciążenie wstępne) W została obliczona zakładając użyteczną wytrzymałość śruby jako 75 % obciążenia próbnego pomnożone przez obszar naprężenia gwintu. Zależnie od zastosowania siła zacisku może być wybrana jako niższa (np. ponieważ łączone materiały są miękkie), lub jako wyższa (np. gdy warunki montażu są bardzo precyzyjne, współczynnik K był testowany dla takiego zastosowania oraz jeśli siła zacisku ma być możliwie najwyższa by obniżyć ryzyko awarii z powodu zmęczenia).

7.4.2 Obciążenie montażowe wstępne / momenty dokręcania – UNF (gwint drobnozwojny)

Poniższa tabela prezentuje momenty dokręcania dla śrub z łbem sześciokątnym (UNF Hex Bolts) zgodnie z ASME B18.2.1., ogólnego zastosowania. Te momenty montażowe podane są jako ogólne wskazówki, gdyż moment jest bardzo pośrednim wskaźnikiem naprężenia i na wynik wpływ ma wiele różnych czynników takich jak tarcie, smarowanie, struktura powierzchni, korozja itd.

Średnica znamionowa		Gwint/cal lbs	Gatunek N	Siła zacisku W (*)		Moment dokręcania dla K =					
Ułamki	Dziesiętne			lbs	N	0.10		0.15		0.20	
						lbs.ft	Nm	lbs.ft	Nm	lbs.ft	Nm
¼	0,250	28	Grade 2	1 502	6 679	3	4	5	6	6	8
			Grade 5	2 321	10 322	5	7	7	10	10	13
			Grade 8	3 276	14 572	7	9	10	14	14	19
⅝	0,3125	24	Grade 2	2 397	10 661	6	8	9	13	12	17
			Grade 5	3 704	16 476	10	13	14	20	19	26
			Grade 8	5 229	23 260	14	18	20	28	27	37
¾	0,375	24	Grade 2	3 622	16 110	11	15	17	23	23	31
			Grade 5	5 597	24 898	17	24	26	36	35	47
			Grade 8	7 902	35 150	25	33	37	50	49	67
⅞	0,4375	20	Grade 2	4 896	21 780	18	24	27	36	36	48
			Grade 5	7 567	33 660	28	37	41	56	55	75
			Grade 8	10 683	47 520	39	53	58	79	78	106
1	0,500	20	Grade 2	6 600	29 358	27	37	41	56	55	75
			Grade 5	10 200	45 372	42	58	64	86	85	115
			Grade 8	14 400	64 054	60	81	90	122	120	163
1 ⅙	0,5625	18	Grade 2	8 374	37 248	39	53	59	80	79	106
			Grade 5	12 941	57 565	61	82	91	123	121	164
			Grade 8	18 270	81 269	86	116	128	174	171	232
1 ⅓	0,625	18	Grade 2	10 560	46 973	55	75	82	112	110	149
			Grade 5	16 320	72 595	85	115	127	173	170	230
			Grade 8	23 040	102 487	120	163	180	244	240	325
1 ½	0,750	16	Grade 2	15 386	68 441	96	130	144	196	192	261
			Grade 5	23 779	105 773	149	201	223	302	297	403
			Grade 8	33 570	149 326	210	284	315	427	420	569
1 ⅔	0,875	14	Grade 2	12 610	56 092	92	125	138	187	184	249
			Grade 5	21 017	93 487	153	208	230	312	306	416
			Grade 8	45 855	203 972	334	453	502	680	669	907
2	1,000	12	Grade 2	16 409	72 992	137	185	205	278	273	371
			Grade 5	42 266	188 009	352	478	528	716	704	955
			Grade 8	59 670	265 424	497	674	746	1 011	994	1 348
2 ⅙	1,125	12	Grade 2	21 179	94 207	199	269	298	404	397	538
			Grade 5	47 491	211 251	445	604	668	905	890	1 207
			Grade 8	77 013	342 569	722	979	1 083	1 468	1 444	1 958
2 ⅓	1,250	12	Grade 2	26 554	118 119	277	375	415	563	553	750
			Grade 5	59 546	264 872	620	841	930	1 261	1 240	1 682
			Grade 8	96 561	429 523	1 006	1 364	1 509	2 046	2 012	2 727
2 ½	1,375	12	Grade 2	32 539	144 739	373	505	559	758	746	1 011
			Grade 5	72 966	324 567	836	1 134	1 254	1 700	1 672	2 267
			Grade 8	118 323	526 324	1 356	1 838	2 034	2 757	2 711	3 676
3	1,500	12	Grade 2	39 130	174 057	489	663	734	995	978	1 326
			Grade 5	87 746	390 310	1 097	1 487	1 645	2 231	2 194	2 974
			Grade 8	142 290	632 934	1 779	2 411	2 668	3 617	3 557	4 823

Konwersja wartości momentu: 1 lbs in = 0,11298 Nm 1 lbs ft = 1,35581 Nm ;
 1 Nm = 8.85074 lbs in 1 Nm = 0.73756 lbs ft

(*) W tej tabeli siła zacisku (obciążenie wstępne) W została obliczona zakładając użyteczną wytrzymałość śruby jako 75 % obciążenia próbnego pomnożone przez obszar naprężenia gwintu. Zależnie od zastosowania siła zacisku może być wybrana jako niższa (np. ponieważ łączone materiały są miękkie), lub jako wyższa (np. gdy warunki montażu są bardzo precyzyjne, współczynnik K był testowany dla takiego zastosowania oraz jeśli siła zacisku ma być możliwie najwyższa by obniżyć ryzyko awarii z powodu zmęczenia).

7.5 Zacieranie się (zakleszczanie) stali nierdzewnej

Wysoka ciągliwość austenitycznej stali nierdzewnej oznacza, że w ogólnym użyciu jest ona bardziej podatna na zacieranie się niż stale zwykłe. Aby uniknąć zacierania, produkt musi być czysty, wolny od zadziorów, ciał obcych, wiórów, piasku itp. oraz należy unikać łączenia jednostronnego z powodu ryzyka uszkodzenia gwintu śruby bądź krzywego jej zamontowania. Złącza sztywne sprawują się lepiej niż złącza elastyczne.

Zaleca się dokręcanie maksymalnie jednostajne i wolne oraz niestosowanie kluczy udarowych. Wiadomo, że aby doprowadzić do danego obciążenia wstępnego ważne są nie tylko współczynniki tarcia, ale też dokładność metody zastosowanej do zakręcania śrub. Kombinacja dwóch różnych gatunków stali nierdzewnej (np. A2 i A4) nie jest korzystna jeżeli chodzi o zacieranie się. W warunkach szczególnych oraz dla spełnienia specjalnych wymagań należy użyć odpowiedniego (przeciw-zatarciowego) smaru /pasty, bądź wcześniej nałożonej powłoki suchej, np. smar/pasta; chlorek-parafina, lakier Molykote, olej wysokociśnieniowy, smar odporny na korozję lub powłoka sucha: Metalform lub Combiflon, itd.

7.6 Głębokość wkręcania dla otworów nieprzelotowych

Poniższy wykres ilustruje zalecane minimalne głębokości wkręcania dla otworów nieprzelotowych w zestawieniu z różnymi klasami właściwości, związane z wytrzymałością na ścinanie materiału, w którym śruba jest mocowana.

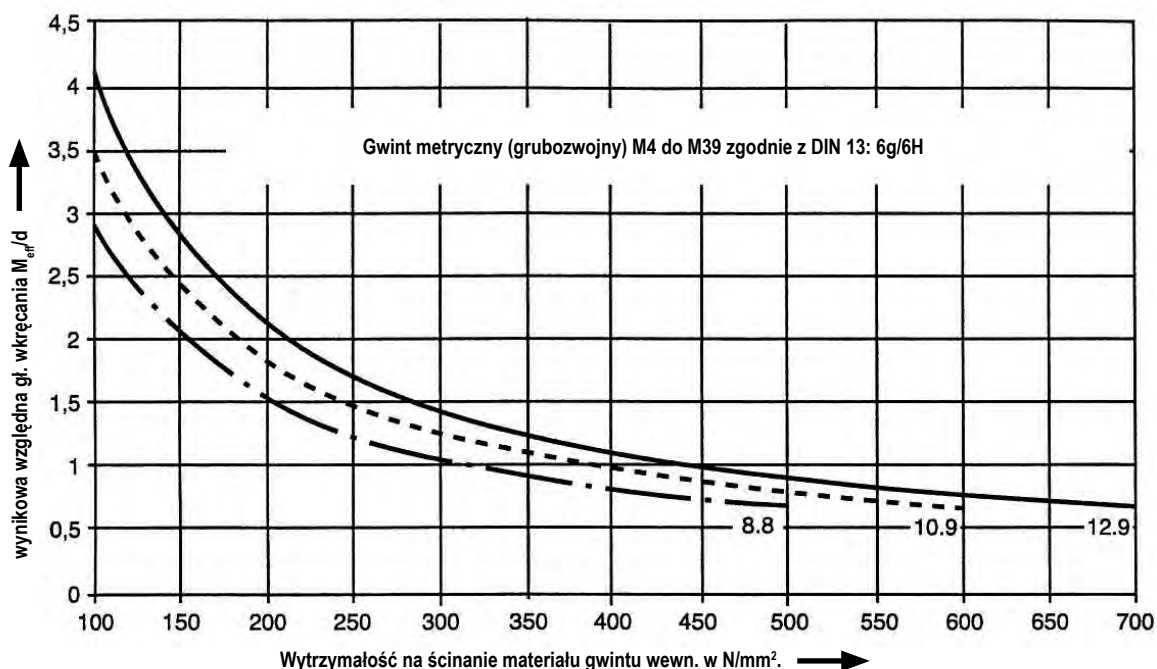

M_{eff} = skuteczna głębokość wkręcania
 d = średnica znamionowa

7.7 Stosunek wytrzymałości na ścinanie do wytrzymałości na rozciąganie

Poniższa tabela bazuje na VDI 2230 (2003)

Klasa właściwości	4.6	5.6	8.8	10.9	12.9
t_b / R_m	0,70	0,70	0,65	0,62	0,60

7.8 Tabela długości mocowania dla śrub sprężanych HV według EN 14399-4

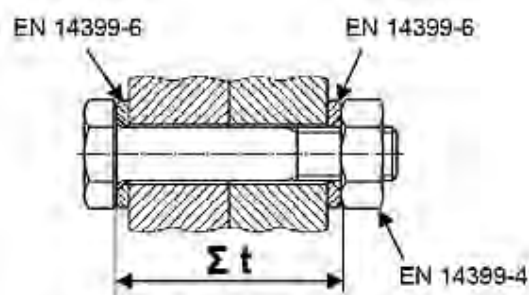

Poniższa tabela bazuje na EN14399-4:2015.

(Seria EN 14399 zastępuje przestarzałą normę dla elementów złącznych HV DIN 6914, 6915, 6916.)

d	M12		M16		M20		M22		M24		M27		M30		M36	
L	Σ t _{min.} and Σ t _{max.}															
nom.	min.	max.	min.	max.	min.	max.	min.	max.	min.	max.	min.	max.	min.	max.	min.	max.
35	16	21														
40	21	26	17	22												
45	26	31	22	27	18	23										
50	31	36	27	32	23	28	22	27								
55	36	41	32	37	28	33	27	32								
60	41	46	37	42	33	38	32	37	29	34						
65	46	51	42	47	38	43	37	42	34	39						
70	51	56	47	52	43	48	42	47	39	44	36	41				
75	56	61	52	57	48	53	47	52	44	49	41	46	39	44		
80	61	66	57	62	53	58	52	57	49	54	46	51	44	49		
85	66	71	62	67	58	63	57	62	54	59	51	56	49	54	43	48
90	71	76	67	72	63	68	62	67	59	64	56	61	54	59	48	53
95	76	81	72	77	68	73	67	72	64	69	61	66	59	64	53	58
100			77	82	73	78	72	77	69	74	66	71	64	69	58	63
105			82	87	78	83	77	82	74	79	71	76	69	74	63	68
110			87	92	83	88	82	87	79	84	76	81	74	79	68	73
115			92	97	88	93	87	92	84	89	81	86	79	84	73	78
120			97	102	93	98	92	97	89	94	86	91	84	89	78	83
125			102	107	98	103	97	102	94	99	91	96	89	94	83	88
130			107	112	103	108	102	107	99	104	96	101	94	99	88	93
135					108	113	107	112	104	109	101	106	99	104	93	98
140					113	118	112	117	109	114	106	111	104	109	98	103
145					118	123	117	122	114	119	111	116	109	114	103	108
150					123	128	122	127	119	124	116	121	114	119	108	113
155					128	133	127	132	124	129	121	126	119	124	113	118
160							132	137	129	134	126	131	124	129	118	123
165							137	142	134	139	131	136	129	134	123	128
170									139	144	136	141	134	139	128	133
175									144	149	141	146	139	144	133	138
180									149	154	146	151	144	149	138	143
185									154	159	151	156	149	154	143	148
190									159	164	156	161	154	159	148	153
195									164	169	161	166	159	164	153	158
200											166	171	164	169	158	163

7.9 Blokowanie

Prawidłowo zaprojektowane połączenia skręcane nie ulegają poluzowaniu pod warunkiem właściwego montażu. Jednakże nie zawsze jest możliwe zaprojektowanie złącza, które jest w stanie być optymalnie odpornym na wszelkie przyczyny luzowania. Dodatkowe produkty takie jak podkładki sprężyste lub ząbkowane są w stanie skompensować utratę siły sprężenia wstępnego lub zapobiec poluzowaniu.

7.9.1 Utrata siły sprężania

Utrata siły sprężania wstępnego powstaje wskutek:

- Poluzowania spowodowanego zmianą długości wynikającą z relaksacji (osadzenia) oraz pełzania materiału.
- Spontanicznego poluzowania w wyniku względnego ruchu między powierzchniami stykowymi złącza z tytułu obciążenia dynamicznego lub z tytułu składowych obciążenia działających poprzecznie do osi śruby. Śruba wówczas wydaje się nie posiadać tarcia z powodu wyeliminowania efektu samozabezpieczenia.

7.9.2 Klasyfikacja systemów blokowania

Ze względu na różne przyczyny utraty siły sprężania wstępnego rozróżnia się:

Zabezpieczenie przeciw osadzaniu i pełzaniu: dodać elementy kompensujące osadzanie i pełzanie.

Zabezpieczenie przeciw utracie siły sprężania: dodać elementy zapewniające, że złącze się nie rozpadnie po utracie siły sprężania.

Zabezpieczenie przeciw luzowaniu rotacyjnemu: dodać elementy zapobiegające spontanicznemu luzowaniu poprzez zablokowanie wewnętrznego momentu luzującego.

Poza klasyfikacją wyżej wspomnianych grup, poniższy przegląd podaje subklasyfikację zależnie od funkcji danego systemu blokującego.

Podane przykłady nie stanowią gwarancji optymalnego efektu, ponieważ na zachowanie złącza wpływ ma szereg innych parametrów.

Przyczyna utraty siły sprężania	Klasyfikacja systemów blokujących zależnie od:		Przykłady	Odniesienie ²⁾
	Celu	Funkcji		
Luzowanie wskutek osadzania / pełzania	Zabezpieczenie przeciw osadzaniu	Elementy elastyczne zaciśnięte w złączu	Podkładki sprężyste zabezpieczające Sprężyny talerzowe Podkładki sprężyste stożkowe	DIN 127/128/137 DIN 2093 DIN 6796 / 6908
Luzowanie wskutek wewnętrznego momentu luzującego i przemieszczenia poprzecznego	Zabezpieczenie przeciw utracie siły sprężania	Elementy blokujące	Nakrętki koronkowe Płytki ustalające Drut blokujący Produkty z otworem na zawleczkę	DIN 935 DIN 93/432/463 ---- DIN 962
		Elementy dociskające	Nakrętki blokujące z plastikową podkładką ¹⁾ Nakrętki metalowe o przeważających wartościach momentu Śruby z wkładką plastikową ¹⁾ Wkręty samogwintujące	DIN 982/985/6926 DIN 980 Drilloc Plastic DIN 7500
	Zabezpieczenie przeciw luzowaniu rotacyjnemu	Elementy blokujące	Śruby z kołnierzem zębatym Nakrętki z kołnierzem zębatym Podkładki zabezpieczające Pierścienie zabezpieczające	E.g. Ripp. E.g. Ripp. ---- E.g. Nord-Lock.
		Czynnik blokujący	Śruby z mikrokapsułkami ¹⁾ Anaerobowy środek blokujący ¹⁾	E.g. Dri-loc 2015. E.g. Loctite.

¹⁾ zależny od temperatury

²⁾ zawiera przestarzałe normy

Na życzenie dostępna jest broszura zawierająca bardziej szczegółowe informacje na ten temat.

Celem ustalenia skuteczności danego systemu blokowania często stosuje się powszechnie przyjęty test wykorzystujący „Junker machine”. Urządzenie to poddaje produkty siłom ścinającym i graficznie rejestruje utratę siły sprężania zależnie od szeregu obciążeń alternatywnych. Fabory ma możliwość wykonania takiego testu.

7.9.3 Praktyczne sugestie dla optymalnego połączenia skręcane

- Zastosowanie dużej siły sprężania wstępnego znacznie ogranicza krytyczne przemieszczenia powierzchni styecznych. (Należy wziąć pod uwagę docisk powierzchniowy skręcane materiału.)
- Kontrolowane dokręcanie.
- Najwyższy możliwy stosunek długości mocowania/ średnicy, najlepiej $L_k / d > 5$.
- Zapobieganie przemieszczaniu się elementów konstrukcyjnych poprzez zastosowanie np. kołków ustalających i tulei dociskających, itp.
- Zwiększenie tarcia między powierzchniami styecznymi poprzez zastosowanie powłok ciernych lub szorstkowanie powierzchni przez piaskowanie.
- Zapewnienie gładkich i równoległych powierzchni styecznych.
- Gdy występuje tylko statyczne naprężenie osiowe i zastosowano prawidłowy montaż, nie ma potrzeby stosowania mechanizmów blokujących.
- Nieprawidłowe użycie osadzenia oraz systemów retencji może częściej pogorszyć niż polepszyć niezawodność złącza. Nie stosować dynamicznych obciążeń ścinających.

Uwaga:

Systemy blokujące muszą być zastosowane pod łbem śruby oraz nakrętki. Podkładka zabezpieczająca założona na podkładkę płaską jest bezużyteczna.

8 Tabele

8.1 Jednostki SI

W poniższej tabeli podany jest wybór jednostek miar powszechnie stosowanych w technologii elementów złącznych.

Nazwa	Symbol	Jednostka dotyczy	Zastępuje	Konwersja (w zaokrągleniu)	
Niuton	N	siła	kgf, kp	1N ≈ 0,1 kgf ≈ kp	1 kgf ≈ 1 kp ≈ 10N
joule	J	Energia, praca ciepło	kcal, cal, kgf.m lub kgm Btu (British thermal unit)	1J ≈ 1Nm ≈ 0,1 kgf.m 1J = 0,739 cal	1 kgf.m ≈ 10J ≈ 10Nm 1 cal = 4,187J
bar	bar	Ciśnienie płynów i gazów	at, kgf/cm ² of kg/cm ²	1 bar ≈ 1 at ≈ 1kgf/cm ² ≈ kg/cm ²	1 at = 1 bar
kelvin	K	Temperatura	częściowo °C	Tk-273,15+T °C	T °C=Tk-273,15
metr	m	Długość	-		
sekunda	s	czas	-		
kilogram	kg	masa (ilość)	Jednostka wagi	1 kg (masa) = 10 N (waga) na Ziemi	
volt	V	Napięcie elektryczne	-		
amper	A	Prąd elektryczny	-		
watt	W	moc (nie tylko elektryczna)	pk, hp oraz kcal/h	1 kW = 1.359 pk 1 kW = 1.341 hp 1 kW = 959.845 kcal/h	1 pk = 0.7355 kW 1 hp = 0.7457 kW 1 kcal/h=0.001163 kW
Pascal	N/m ²	Ciśnienie, naprężenie	m ⁻¹ ·kg·s ⁻²	1 Pa 1MPa	1 N/m ² 1 N/mm ²
Niutonometr	Nm	Moment	Kgf.m	1 Nm = 0.1 kgf.m	1kgf.m = 10 Nm

8.2 Konwersja wytrzymałości na rozciąganie, twardości Vickersa, Brinella i Rockwella

Poniższa tabela stanowi jedynie referencję w oparciu o normę ISO 18265:2013 dla której należy rozważyć następujące okoliczności:

- Wytrzymałość na rozciąganie zgodnie z ISO 6892-1, twardość Vickersa zgodnie z ISO 6507-1, twardość Brinella zgodnie z ISO 6506-1, twardość Rockwella zgodnie z ISO 6508-1 z zastosowaniem dla stali niestopowych i niskostopowych. Dla stali wysokostopowych i/lub obrabianych na zimno należy spodziewać się znacznych odchyłeń.
- ISO 18265 podaje kilka tabel konwersyjnych mających zastosowanie do większości rodzajów stali i warunków ich obróbki cieplnej (np. ulepszana cieplnie) oraz do innych metali. Z tabel tych należy korzystać gdy potrzebna jest dokładniejsza konwersja.
- Zasadniczo każda konwersja twardości skutkuje pewnym stopniem niedokładności i może być stosowana jedynie wówczas gdy nie można skorzystać z metody pomiarowej. Konwersja nie może prowadzić do odrzucenia, chyba że w chwili zamówienia uzgodniono daną metodę pomiarową.
- Konwersja wytrzymałości na rozciąganie i twardości skutkuje jeszcze większym odchyleniem, a zatem może być powoływana tylko jako wartość referencyjna, która nigdy nie może zastępować wytrzymałości na rozciąganie ustalonej w drodze próby rozciągania.

Wytrzymałość na rozciąganie	Twardość Vickersa	Twardość Brinella	Twardość Rockwella							
			HRB	HRF	HRC	HRA	HRD	HR15N	HR30N	HR45N
255	80	76,0								
285	90	85,5	48,0	82,6						
320	100	95,0	56,2	87,0						
350	110	105	62,3	90,5						
385	120	114	66,7	93,6						
415	130	124	71,2	96,4						
450	140	133	75,0	99,0						
480	150	143	78,7	101,4						
510	160	152	81,7	103,6						
545	170	162	85,0	105,5						
575	180	171	87,1	107,2						
610	190	181	89,5	108,7						
640	200	190	91,5	110,1						
675	210	199	93,5	111,3						
705	220	209	95,0	112,4						
740	230	219	96,7	113,4						
770	240	228	98,1	114,3	20,3	60,7	40,3	69,6	41,7	19,9
800	250	238	99,5	115,1	22,2	61,6	41,7	70,6	43,4	22,2
835	260	247	(101)		24,0	62,4	43,1	71,6	45,0	24,3
865	270	257	(102)		25,6	63,1	44,3	72,6	46,4	26,2
900	280	266	(104)		27,1	63,8	45,3	73,4	47,8	27,9
930	290	276	(105)		28,5	64,5	46,5	74,2	49,0	29,5
965	300	285			29,8	65,2	47,5	74,9	50,2	31,1
995	310	295			31,0	65,8	48,4	75,6	51,3	32,5
1030	320	304			32,2	66,4	49,4	76,2	52,3	33,9
1060	330	314			33,3	67,0	50,2	76,8	53,6	35,2
1095	340	323			34,4	67,6	51,1	77,4	54,4	36,5
1125	350	333			35,5	68,1	51,9	78,0	55,4	37,8
1155	360	342			36,6	68,7	52,8	78,6	56,4	39,1
1190	370	352			37,7	69,2	53,6	79,2	57,4	40,4
1220	380	361			38,8	69,8	54,4	79,8	58,4	41,7
1255	390	371			39,8	70,3	55,3	80,3	59,3	42,9
1290	400	380			40,8	70,8	56,0	80,8	60,2	44,1
1320	410	390			41,8	71,4	56,8	81,4	61,1	45,3
1350	420	399			42,7	71,8	57,5	81,8	61,9	46,4
1385	430	409			43,6	72,3	58,2	82,3	62,7	47,4
1420	440	418			44,5	72,8	58,8	82,8	63,5	48,4
1455	450	428			45,3	73,3	59,4	83,2	64,3	49,4
1485	460	437			46,1	73,6	60,1	83,6	64,9	50,4
1520	470	447			46,9	74,1	60,7	83,9	65,7	51,3
1555	480	(456)			47,7	74,5	61,3	84,3	66,4	52,2

8.3 Tabele korozji stykowej i chemicznej

8.3.1 Tabela korozji kontaktowej

S = silna korozja metalu, pokazana w kolumnie poziomej														
G = brak korozji lub ograniczona korozja metalu, pokazana w kolumnie poziomej														
M = umiarkowana korozja metalu (w ekstremalnie wilgotnej atmosferze), pokazana w kolumnie poziomej														
Metal	Powierzchnia*	Stopy magnezu	Cynk	Stal galwaniz. na gorąco	Stopy aluminium	Powłoki kadmu	Stal miękka	Stal niskostopowa	Stal lana	Stal chromowa	Ołów	Cyna	Miedź	Stal nierdzewna
Stopy magnezu	mała		S	S	S	S	S	S	S	S	S	S	S	S
	duża		M	M	M	M	S	S	S	S	S	S	S	S
Cynk	mała	M		G	S	S	S	S	S	S	S	S	S	S
	duża	G		G	G	G	G	G	G	G	G	G	G	G
Stal galwanizowana na gorąco	mała	M	G		M	M	S	S	S	S	S	S	S	S
	duża	G	G		G	G	G	G	G	G	G	G	G	G
Stopy aluminium	mała	M	G	G		G	S		S		S		S	S
	duża	G	G	M		G	G	G	M	M	S	S	S	S
Powłoki kadmu	mała	G	G	G	G		S	S	S	S	S	S	S	S
	duża	M	G	M	G		G	G	G	G	G	G	G	G
Stal miękka	mała	G	G	G	G	G		M	S	S	S	S	S	S
	duża	G	G	G	G	G		G	G	G	G	G	G	G
Stal niskostopowa	mała	G	G	G	G	G	G		G	S	S	S	S	S
	duża	G	G	G	G	G	G		G	G	G	G	G	G
Stal lana	mała	G	G	G	G	G	G	M		S	S	S	S	S
	duża	G	G	G	G	G	G	G		G	G	G		
Stal chromowa	mała	G	G	G	G	G	G	G			M	M	S	S
	duża	G	G	G	G	G	G	G			G	G		G
Ołów	mała	G	G	G	G	G	G	G	G	G		G	G	
	duża	G	G	G	G	G	G	G	M	G		G		G
Cyna	mała	G	G	G	G	G	G	G		G		G		
	duża	G	G	G	G	G	G	G	G	M		G		
Miedź	mała	G	G	G	G	G	G	G		M	M	S		
	duża	G	G	G	G	G	G	G	G		G	M		G
Stal nierdzewna	mała	G	G	G	G	G		G	G		G	G		
	duża	G	G	M	G	G	G	G	G	M	M	M	G	

* Względny stosunek pola powierzchni danego metalu w odniesieniu do metali podanych w sąsiednich kolumnach.

8.3.2 Tabela korozji chemicznej

ŚRODEK CHEMICZNY	Stal galwanizowana na gorąco	Stal nierdzewna		Mosiądz	Aluminium Sopral	Tworzywa sztuczne PA 6.6
		A2	A4			
Octany		0-1	0	1-2	0	2-3
Aceton		0	0	0	0	0
Acetylen		0	0	3	0	
Alkohole	3	0	0	0	0-1	0
Atun		2	1	2	0	2
Amoniak gazowy		0	0	3	0	1
Amoniak	3	0	0	3	1	1
Benzen/Toluen/Ksylene	0	0	0	0	0	0
Chlor gazowy		1	1	1	3	3
Woda chlorowa		1	1			
Kwas solny		2-3	2-3	3	3	3
Chlorki						
– chlorek sodu/ potasu	0	1	1	2	2-3	0
– chlorek amoniaku- / cynku		2	1	2	3	2
– chlorek żelaza		3	3	3	3	3
Kwas cytrynowy		1	0	2	1	1
Kwas fosforowy		2-3	0-1	3	2-3	2-3
Fosforany	0	1	0	2	2-3	1-2
Glikol		0	0	1	1	1
Gliceryna	0	0	0	0-1	0	1
Żywiec	2-3	1	1	2-3	0-1	0
Węglowodory						
– Butan, benzyna, smoła	0	0	0	0-1	0	0
Węglowodory chloru						
– Trójchloroetylen	0	0	0	0-1	0	0-1
– Czterochlorek	0	0	0	0-1	0	0-1
Kwas węglowy		0	0	2	0	0
Węgiel sodowy (soda)		0	0	1-2	0	0
Lakiery	0	0	0	1	0	1
Kwas mrówkowy		1	0	2	3	3
Olej napędowy / olej roślinny	1	0	0	0	0	0
Kwas palmitynowy / stearolowy		1	0	2	0	0
Kwas azotowy		1	0-1	3	2	3
– siarczan sodu/amoniaku		0	0	2-3	0	2
Woda						
– woda pitna		0	0	2	0	0
– woda kwaśna	1-2			3	2	1
– woda słona	0	1	1	2	1	0
Dwutlenek siarki suchy		0	0	0-1	1	1
Dwutlenek siarki mokry		1	0	3	2	2
Kwas siarkowy	3	3	2-3	3	3	3
– siarczan sodu/amoniaku	1	0	0	1	0-1	0
– siarczan niklu/miedzi		0-1	0	2-3	2-3	2-3
Siarkowodor		0-1	0	2	0	1

0 = odporność dobra

1 = odporność umiarkowana

2 = odporność słaba

3 = brak odporności

The satisfaction of successfully completing your projects, that's what it's all about! Delivering flawless work requires know-how and the right, top quality materials. Because only the very best is good enough for experienced professionals. You expect quality because you deliver quality!

MaxxFast is a high quality no-nonsense brand in the hardware market. MaxxFast offers a wide range of fasteners, tools and industrial supplies. No matter what product you choose, quality is guaranteed. And it comes at a competitive price! MaxxFast gives you everything you need for the trouble-free completion of your project, so you can start with confidence on your next challenge.

Even though quality always comes first, a good price is just as important to achieve success. MaxxFast works closely with solid partners and aims for a streamlined production process with large-scale production to keep costs down. The bottom line is that this means a competitive retail price. That's good business for you and for your customers. Success guaranteed!

- Top quality
- A wide range of products
- Quality at a competitive price

**JOB DONE,
ON TO THE
NEXT**



Revolutionary woodscrews



High performance self drilling screws



A great range of quality anchors



Proven quality chemical anchors



Leading hose clamps



New cable ties



Screw bits the right fit



Holesaws the sharp edge



Quality assortments

www.maxxfast.com

MAXXFAST
PROFESSIONAL HARDWARE